

## A LOCAL LAW

To amend the New York city charter and the administrative code of the city of New York, in relation to enacting the New York city construction codes and repealing chapter 1 of title 26 of the administrative code, sections 27-106, 27-124, 27-125, 27-126, 27-127, 27-128, 27-129, 27-130, 27-131, 27-132, 27-133, 27-134, 27-135, 27-136 and 27-137 of the administrative code, articles 9, 10, 11, 12, 13, 14, 15, 16, 17, 18, 19, 20, 21, 22, 23, 24, 25 and 27 of subchapter 1 of chapter 1 of title 27 of the administrative code, subchapter 19 of chapter 1 of title 27 of the administrative code and chapters 1, 2, 3, 5, 6, 7 and 8 of title 28 of the administrative code.

### Be it enacted by the Council as follows:

Section 1. Items (v) (vi) and (vii) of paragraph b of subdivision 5 of section 1041 of the New York city charter are amended to read as follows:

(v) statement or communication effecting a non-continuous closing of a street; or (vi) statement or communication adopted pursuant to sections fifty-one, one hundred ninety-seven-a except pursuant to the first sentence of subdivision b or the third sentence of subdivision c of section one hundred ninety-seven-a, one hundred ninety-seven-c except pursuant to subdivisions i and l of section one hundred ninety-seven-c, one hundred ninety-nine, two hundred, two hundred one, two hundred two and seven hundred five of this charter [; or (vii) building code reference standards amended, revised or added by the commissioner of the department of buildings in consultation with the fire commissioner on all issues relating to fire safety after notice and a public hearing and published as part of the administrative code].

§2. Chapter 1 of title 26 of the administrative code of the city of New York is REPEALED.

§3. Section 27-101 of the administrative code of the city of New York is amended to read as follows:

§27-101 Title. This code shall be known and may be cited as the “1968 building code of the city of New York” or the “1968 building code”, and is hereinafter referred to as “this code” or “the code”.

§4. Section 27-103 of the administrative code of the city of New York is amended to read as follows:

§ 27-103 Scope. [This] On and after July 1, 2008 this code shall apply to the minimum requirements and standards for the construction, alteration, repair, [demolition, removal, maintenance,] occupancy and use of new and existing buildings in the city of New York [including the installation, alteration, repair, maintenance and use of service equipment therein , except as provided in section six hundred forty-three of the charter] in accordance with and to the extent provided for by chapter 1 of title 28 of the administrative code and the New York city construction codes. On and after July 1, 2008, administration and enforcement of this code shall be in accordance with title 28 of the administrative code.

§5. Section 27-106 of the administrative code of the city of New York is REPEALED.

§6. Article 4 of subchapter 1 of chapter 1 of title 27 of the administrative code of the city of New York is amended by adding a new section 27-123.3.

§27-123.3 Definition. For the purposes of this article, the term “existing building” means a building in existence prior to December 6<sup>th</sup>, 1968 or a building constructed in accordance with the building laws and regulations in force prior to such date in accordance with section 27-105 of this code.

§7. Sections 27-124, 27-125, 27-126, 27-127, 27-128, 27-129, 27-130, 27-131, 27-132, 27-133, 27-134, 27-135, 27-136 and 27-137 of the administrative code of the city of New York are REPEALED.

§8. Articles 9, 10, 11, 12, 13, 14,15, 16, 17, 18, 19, 20, 21, 22, 23, 24, 25 and 27 of subchapter 1 of chapter 1 of title 27 of the administrative code of the city of New York are REPEALED.

§9. Subchapter 19 of chapter 1 of title 27 of the administrative code of the city of New York is REPEALED.

§10. Section 2 of local law number 99 for the year 2005 is amended to read as follows:

§ 2. This local law shall take effect on July 1, [2007] 2008 [provided, however that prior to such date a New York city building code based on the 2003 edition of the International Building Code, a New York city mechanical code based on the 2003 edition of the International Mechanical Code, a New York city residential code based on the 2003 edition of the International Residential Code, a New York city fuel gas code based on the 2003 edition of the International Fuel Gas Code, all such international codes published by the International Code Council, with recommended changes that reflect the unique character of the city, shall be enacted and that if a local law or laws enacting such New York city codes are not enacted prior to July 1, 2007, this local law shall not take effect, and provided, further,] except that prior to the effective date of this local law, the commissioner shall take administrative actions necessary for the timely implementation of this local law including but not limited to the promulgation of rules.

§11. Chapters 1, 2 and 3 of title 28 of the administrative code of the city of New York, as added by local law number 99 for the year 2005, are REPEALED and new chapters 1, 2, 3, 4 and 5 are added to read as follows:

CHAPTER 1  
ADMINISTRATION

ARTICLE 101  
GENERAL

§28-101.1 Title. The provisions of this chapter shall apply to the administration of the codes set forth in this title and the 1968 building code. The codes set forth in this title shall be known and may be cited as the “New York city construction codes” and shall consist of:

The New York city plumbing code.

The New York city building code.

The New York city mechanical code.

The New York city fuel gas code.

§28-101.2 Intent. The purpose of this code is to provide reasonable minimum requirements and standards, based upon current scientific and engineering knowledge, experience and techniques, and the utilization of modern machinery, equipment, materials, and forms and methods of construction, for the regulation of building construction in the city of New York in the interest of public safety, health and welfare, and with due regard for building construction and maintenance costs.

§28-101.3 Codes. Any reference in this title to “this code” or “the code” shall be deemed to be a reference to this title and all of the codes comprising the New York city construction codes unless the context or subject matter requires otherwise.

§28-101.4 Effective date. Except as otherwise provided in sections 28-101.4.1, 28-101.4.2, 28-101.4.3 and 28-101.4.4 on and after the effective date of this code, all work shall be performed in accordance with the provisions of this code.

§28-101.4.1 Permit issued or work commenced prior to effective date. If a permit for work was issued prior to the effective date of this code or, if no permit was necessary, work was commenced prior to such effective date, all of the provisions of chapter 1 of title 27 of the administrative code as heretofore in effect shall apply to such work.

§28-101.4.2 Applications for construction document approval submitted prior to and within twelve months after the effective date of this code. Any work for which an application for construction document approval was submitted to the department prior to the effective date of this code and not thereafter abandoned, or for which an application for construction document approval is submitted to the department within a period of twelve months after such date may, at the option of the owner, be performed in its entirety in accordance with the provisions of this code, or in accordance with the 1968 building code, provided that such work is commenced within twelve months after the date of issuance of a permit therefore and is diligently carried on to completion. The commissioner may, for

good cause, extend the time period for commencement of the work beyond 12 months. Where the owner elects to perform the work in compliance with the 1968 building code, the following conditions shall apply:

1. Except as otherwise limited by the commissioner, administration and enforcement of the 1968 building code shall be in accordance with this code, including but not limited to approval of construction documents, issuance of permits and certificates of occupancy, tests and inspections, penalties and enforcement. Controlled inspections and semi-controlled inspections as referenced in the 1968 building code shall be deemed to be special inspections and shall comply with the provisions of this code relating to special inspections. Materials regulated in their use by the 1968 building code shall be subject to applicable provisions of this code.
2. Safety of public and property during construction operations including demolition shall be governed by chapter 33 of the New York city building code.

§28-101.4.3 Optional use of the 1968 building code for alteration of existing buildings. At the option of the owner, and subject to appropriate approval, a permit may be issued after the effective date of this code authorizing work on existing buildings constructed in accordance with the 1968 building code or with the building laws in effect prior to the effective date of the 1968 building code, to be performed in accordance with the requirements and standards set forth in the 1968 building code, subject to the following conditions:

1. The installation and alteration of all appliances, equipment and systems regulated by the New York city fuel gas code, the New York city plumbing code and the New York city mechanical code shall be governed by applicable provisions of those codes relating to new and existing installations.
2. The installation, alteration and additions to fire protection systems regulated by Chapter 9 of

the New York city building code, including a change of occupancy group that would require such systems, shall be governed by applicable provisions of such chapter and related referenced standards.

3. The installation and alteration of elevators, conveyors, and amusement rides shall be governed by chapter 30, appendix K of the New York city building code and the rules of the department.
4. Safety of public and property during construction operations including demolition shall be governed by chapter 33 of the New York city building code.
5. Where the estimated cost of such alteration in any twelve-month period exceeds fifty percent of the cost of replacement of the building or where there is a change in the main use or dominant occupancy of the building, facilities for people with physical disabilities shall be provided in accordance with chapter 11 of the New York city building code as if the building were hereafter erected.
6. Encroachments onto the public right of way shall be governed by chapter 32 of the New York city building code.
7. Except as otherwise limited by the commissioner, administration and enforcement of the 1968 building code shall be in accordance with this code, including but not limited to approval of construction documents, issuance of permits and certificates of occupancy, tests and inspections, penalties and enforcement. Controlled inspections and semi-controlled inspections as referenced in the 1968 building code shall be deemed to be special inspections and shall comply with the provisions of this code relating to special inspections. Materials regulated in their use by the 1968 building code shall be subject to applicable provisions of this code.

§28-101.4.4 Alterations that reduce the fire protection or structural safety of existing buildings.

Notwithstanding any other provision of this code, where the alteration of any existing building

in accordance with a provision of this code would result in a reduction of the fire protection or structural safety of such building, relevant provisions of the 1968 building code shall apply to such alteration unless there is full compliance with those provisions of this code that would mitigate or offset such reduction of fire protection or structural safety.

§28-101.5 Definitions. As used in this chapter and elsewhere in this title, the following terms shall have the following meanings unless the context or subject matter requires otherwise:

1968 BUILDING CODE. Chapter 1 of title 27 of the administrative code as hereafter in effect.

ACCEPTANCE OR ACCEPTED. In reference to construction documents, the endorsement by the department of construction documents with less than full examination by the department based on the professional certification of a registered design professional in accordance with a program established by the commissioner.

ADDITION. An alteration of a building in existence that increases its exterior dimensions including but not limited to an extension or increase in floor area or height (including an increase in height or area resulting from the construction of a rooftop structure for mechanical equipment) of the building.

ADMINISTRATIVE CODE. The administrative code of the city of New York.

ALTERATION. Any construction, addition, change of use or occupancy, or renovation to a building or structure in existence.

APPROVAL OR APPROVED. In reference to construction documents, the determination by the department after full examination that submitted construction documents comply with this code and other applicable laws and rules. In reference to materials, the determination by the commissioner that material is acceptable for its intended use.

APPROVED AGENCY. An established and recognized agency, or other qualified person, regularly engaged in conducting tests or furnishing inspection services, when approved pursuant to department

rules as qualified to perform or witness identified testing or inspection services.

APPROVED FABRICATOR. An established and qualified person, firm or corporation approved by the commissioner to custom manufacture or build products or assemblies regulated by this code.

APPROVED INSPECTION AGENCY. An approved agency that is approved by the department as qualified to perform one or more of the inspections required by this code.

APPROVED TESTING AGENCY. An approved agency that is approved by the department as qualified to test and evaluate the performance of one or more of the materials regulated in their use by this code. Such term shall include, when approved pursuant to department rules, a third party testing or certification agency, evaluation agency, testing laboratory, testing service or other entity concerned with product evaluation.

ARCHITECT. A person licensed and registered to practice the profession of architecture under the education law of the state of New York.

BUILDING. Any structure used or intended for supporting or sheltering any use or occupancy. The term shall be construed as if followed by the phrase “structure, premises, lot or part thereof” unless otherwise indicated by the text.

CHARTER. The New York city charter.

CERTIFICATE OF COMPLIANCE. A certificate stating that materials meet specified standards or that work was done in compliance with approved construction documents and other applicable provisions of law and with respect to specified service equipment, a certificate issued by the department authorizing the operation of such equipment.

CITY. The city of New York.

COMMISSIONER. The commissioner of buildings of the city of New York, or his or her duly authorized representative.



CONSTRUCTION DOCUMENTS. Plans and specifications and other written, graphic and pictorial documents, prepared or assembled for describing the design, location and physical characteristics of the elements of the project necessary for obtaining a building permit.

DEFERRED SUBMITTAL. Those portions of the design that are not submitted at the time of the application for construction document approval and that are to be submitted to the department within a specified period of time after the issuance of a permit.

DEMOLITION. Full or partial demolition.

DEMOLITION, FULL: The dismantling, razing, or removal of all of a building or structure, including all operations incidental thereto.

DEMOLITION, PARTIAL: The dismantling, razing, or removal of structural members, floors, interior bearing walls, and/or exterior walls or portions thereof, including all operations incidental thereto.

DEPARTMENT. The department of buildings of the city of New York.

ENGINEER. A person licensed and registered to practice the profession of engineering under the education law of the state of New York.

ENLARGEMENT. An addition.

EXISTING BUILDING OR STRUCTURE. (i) A building or structure in existence prior to the effective date of this code or one for which a lawful building permit was issued for the erection of such building or structure prior to the effective date of this code. (ii) A building or structure erected in accordance with the 1968 building code under a lawful building permit issued for the erection of such building or structure after the effective date of this code in accordance with section 28-101.4.2 of this code.

FABRICATED ITEM. Products and assemblies regulated by this code, that are custom manufactured, or built prior to their incorporation into the work at the job site. Fabricated items shall not include listed, labeled or approved products or assemblies.

FIRE PROTECTION PLAN. A report containing a narrative description of the life and fire safety systems and evacuation system for a structure.

HEREAFTER. On or after the effective date of this code.

HERETOFORE. Before the effective date of this code.

INSPECTION CERTIFICATE. Identification applied to a product by an approved agency containing the name of the manufacturer, the function and performance characteristics, and the name and identification of the approved agency that indicates that the product or material has been inspected and evaluated by such approved agency. An inspection certificate shall also mean a certificate issued by the department upon satisfactory completion of an inspection or test.

LABEL. Identification applied to material by the manufacturer or an approved agency that contains the name of the manufacturer, the function and performance characteristics of the material, and the name and identification of the approved agency that conducted the evaluation of a representative sample of such material.

LABELED. Material to which has been attached a label, symbol or other identifying mark of the manufacturer that contains the name of the manufacturer, the function and performance characteristics of the product or material, and the name and identification of an approved agency and that indicates that a representative sample of the material has been tested and evaluated by an approved agency for compliance with nationally recognized standards or tests to determine suitable usage in a specified manner.

LAND SURVEYOR. A person licensed and registered to practice the profession of land surveying under the education law of the state of New York.

LISTED. Material identified in a list published by an approved agency that maintains periodic inspection of production of listed material or periodic evaluation services and whose listing states either that the

material meets identified nationally recognized standards or has been tested and found suitable for a specified purpose when installed in accordance with the manufacturer's installation instructions.

LETTER OF COMPLETION. A document issued by the department indicating that permitted work has been completed, including satisfactory final inspection in accordance with this code. A letter of completion is issued only in circumstances where a certificate of occupancy is not required upon completion of the permitted work.

LIMITED PLUMBING ALTERATIONS. An alteration to a plumbing system where the total cost of the proposed work in the building does not exceed twenty five thousand dollars in any 12 month period and the proposed work is limited to the following:

1. The installation of new plumbing or gas piping, or the rerouting of existing plumbing or gas piping;
2. The addition of not more than two plumbing fixtures or fixture connections;
3. The mounting of new plumbing fixtures on existing roughings, other than the mere replacement of existing fixtures constituting a minor alteration or ordinary repair under this code; and
4. The installation or replacement of backflow preventers.

LIMITED SPRINKLER ALTERATIONS. An alteration to an existing sprinkler system where the total cost of the proposed work in the building does not exceed twenty five thousand dollars in any 12-month period and the proposed work is limited to the following:

1. Replacement of parts required for the operation of a sprinkler system;
2. Replacement of sprinkler heads, provided that orifice sizes, type and deflector positions remain the same;
3. Changes that do not alter the type of sprinkler system;
4. Relocation of piping that does not affect the operation of the sprinkler system; and

5. Rearrangement of not more than 20 sprinkler heads in areas presently sprinklered in light hazard occupancy, as such term is defined in reference standards, which will remain in such occupancy, provided that the addition of sprinkler heads in existing systems shall be limited to light hazard occupancies in rooms or spaces not exceeding 800 square feet (74.3 m<sup>2</sup>) requiring only one head with the maximum spacing allowed by the code, and provided that the number of new heads does not exceed a total of five.

LIMITED STANDPIPE ALTERATIONS. An alteration to an existing standpipe system where the total cost of the proposed work in the building does not exceed twenty five thousand dollars in any 12-month period and the proposed work is limited to the following:

1. Replacement of parts required for the operation of a combined standpipe system; and
2. Relocation of combined standpipe auxiliary hose sources and cabinets within 10 feet (3048 mm) of their original location, provided that the existing covered area is not affected and provided that such relocation complies with this code for a new installation.

MANUFACTURER'S DESIGNATION. Identification applied to material by the manufacturer indicating that the material complies with a specified standard or set of rules.

MARK. Identification applied to a product by the manufacturer indicating the name of the manufacturer and the function of a product or material.

MATERIALS. Materials, assemblies, appliances, equipment, devices, systems, products and methods of construction regulated in their use by this code or regulated in their use by the 1968 building code.

OCCUPANCY. The purpose or activity for which a building or space is used or is designed, arranged or intended to be used.

OWNER. Any person, agent, firm, partnership, corporation or other legal entity having a legal or equitable interest in, or control of the premises.

PARTY WALL. A fire division on an interior lot line common to two adjoining buildings.

PERMIT. An official document or certificate issued by the commissioner that authorizes performance of specified work or activity.

PERSON. An individual, partnership, corporation, or other legal entity.

PREMISES. Land, improvements thereon, or any part thereof.

PROFESSIONAL CERTIFICATION. A personal verification of a registered design professional made under such professional's signature and seal that accompanies construction documents and other submittal documents filed with the department and that attests that such documents do not contain false information and are in compliance with all applicable provisions of law.

REGISTERED DESIGN PROFESSIONAL. An architect or engineer.

REGISTERED DESIGN PROFESSIONAL OF RECORD. The registered design professional who prepared or supervised the preparation of applicable construction documents filed with the department.

REQUIRED. Shall mean required by the provisions of this code.

RETAINING WALL. A wall designed to prevent the lateral displacement of soil or other materials.

SIGN-OFF. The issuance by the department of a letter of completion or certificate of occupancy for permitted work indicating the satisfactory completion of all required inspections and receipt by the department of all required submittal documents.

SERVICE EQUIPMENT. Equipment or systems, and all components thereof, that provide sanitation, power, light, heat, ventilation, air conditioning, refuse disposal, fire-fighting, transportation or other facilities for buildings.

SINGLE ROOM OCCUPANCY MULTIPLE DWELLING. See section 28-107.2.

SPECIAL INSPECTION. Inspection of selected materials, equipment, installation, fabrication, erection or placement of components and connections, to ensure compliance with approved construction

documents and referenced standards as required by chapter 17 of the New York city building code or elsewhere in this code or its referenced standards.

SPECIAL INSPECTOR. An individual having required qualifications and authorized by the department to perform or witness particular special inspections required by this code or by the rules of the department, including but not limited to a qualified registered design professional so authorized.

SUPERINTENDENT OF CONSTRUCTION (CONSTRUCTION SUPERINTENDENT). An individual, when authorized pursuant to department rules as qualified to superintend permitted construction work on behalf of the owner.

STRUCTURE. That which is built or constructed, including among others: buildings, stadia, tents, reviewing stands, platforms, stagings, observation towers, radio towers, tanks, trestles, open sheds, shelters, fences, and display signs.

SUBMITTAL DOCUMENTS. Completed application forms, construction documents, reports and any other required documents submitted in compliance with this code or other applicable laws and rules including but not limited to special inspection reports, certifications or approvals from other governmental agencies and other data required by this code or by the department.

USE (USED). The purpose for which a building, structure, or space is occupied or utilized, unless otherwise indicated by the text. Use (used) shall be construed as if followed by the words “or is intended, arranged, or designed to be used.”

UTILITY COMPANY OR PUBLIC UTILITY COMPANY. The term shall be construed to have the same meaning as that contained in section two of the New York state public service law.

UTILITY CORPORATION OR PUBLIC UTILITY CORPORATION. The term shall be construed to have the same meaning as that contained in section two of the New York state public service law.

WORK NOT CONSTITUTING MINOR ALTERATIONS OR ORDINARY REPAIRS. See section 28-

105.4.2.1.

WRITING (WRITTEN). The term shall be construed to include handwriting, typewriting, printing, photo-offset, or any other form of reproduction in legible symbols or characters, including, in the discretion of the commissioner, electronic media.

WRITTEN NOTICE. A notification in writing delivered by hand to the person or parties intended, or delivered at or sent by mail or in the discretion of the commissioner by electronic media to the last address known to the party giving such notice.

ZONING RESOLUTION. The zoning resolution of the city of New York, adopted December fifteenth, nineteen hundred sixty-one, including all amendments thereto.

ARTICLE 102  
APPLICABILITY

§28-102.1 General. Where, in any specific case, different sections of this code specify different materials, methods of construction or other requirements, the most restrictive shall govern. Where a general requirement conflicts with a specific requirement, the specific requirement shall govern. Where British and metric units of measurement conflict, the British units shall govern.

§28-102.2 Other laws. The provisions of this code do not presumptively provide for matters that are contained in the charter, the labor law, the multiple dwelling law, the zoning resolution, or the general city law. Where there is conflict or inconsistency between the requirements of this code and other applicable laws and rules, unless otherwise required, such conflict shall be resolved in favor of the more restrictive requirement.

§28-102.3 Separability. If any clause, sentence, paragraph, section or part of this code shall be adjudged to be invalid, such judgment shall not affect, impair or invalidate the remainder thereof, but shall be confined in its operation to the clause, sentence, paragraph, or part thereof directly involved in the controversy in which such judgment shall have been rendered.

§28-102.4 Existing buildings. The lawful use or occupancy of any existing building or structure, including the use of any service equipment therein, may be continued unless a retroactive change is specifically required by the provisions of this code or other applicable laws or rules. The continuation of the unlawful use or occupancy of a building or structure after the effective date of this code contrary to the provisions of this code or other applicable law or rule shall be a violation of this code.

§28-102.4.1 Existing buildings must comply with the applicable retroactive requirements of the 1968 building code. Existing buildings must comply with the applicable retroactive requirements of the 1968 building code including those requiring the installation of fire safety and building safety systems and the filing of verifying reports with the department of such installations by the dates specified in section 27-228.5 of the administrative code or in other applicable provisions of such 1968 building code. A violation of such provisions shall be a violation of this code.

§28-102.4.2 Change in use or occupancy. Except as otherwise provided in sections 28-101.4.1, 28-101.4.2 28-101.4.3 or 28-101.4.4 changes in the use or occupancy of any building or structure made after the effective date of this code shall comply with the provisions of this code. Any changes made in the use or occupancy of a building or structure not in compliance with this code shall be prohibited and shall be a violation of this code. After a change in use or occupancy has been made in a building, the re-establishment of a prior use or occupancy that would not be lawful in a new building of the same construction class shall be prohibited unless and until all the applicable provisions of this code and other applicable laws and rules for such reestablished use or occupancy shall have been complied with. A change from a use prohibited by the provisions of this code, but which was permitted prior to the effective date of this code, to another use prohibited by the provisions of this code shall be deemed a violation of this code.



§28-102.4.3 Alteration of existing structures. Except as otherwise provided in sections 28-101.4.1, 28-101.4.2, 28-101.4.3 and 28-101.4.4, existing structures altered after the effective date of this code shall comply with the provisions of this code. In accordance with subdivision eleven of section three of the multiple dwelling law and article 4 of subchapter 1 of the 1968 building code, at the option of the owner, multiple dwellings erected prior to December 6, 1969 may be altered and buildings erected prior to December 6, 1969 may be converted to multiple dwellings in accordance with applicable provisions of the multiple dwelling law and the building laws and regulations in effect prior to December 6, 1968, provided the general safety and public welfare are not thereby endangered.

§28-102.5 Grading of lots. The regulation of lots, in conformity with the street on which they are situated, shall be calculated at curb level. Where a lot has more than one street frontage, and is so situated that the street frontages intersect, the curb of the longest street frontage shall be used. When the street frontages do not intersect, the curb along each frontage shall be used to one-half the depth of the lot between street frontages. A lot as referred to in this section 28-102.5 shall mean a parcel of land twenty-five feet by one hundred feet, or less, in one ownership whether adjacent land be in the same or other ownership; but, for this purpose, no land in the same ownership may be divided into lots smaller than twenty-five feet by one hundred feet.

§28-102.6 Appendices. All enacted appendices are a part of the provisions of this code.

ARTICLE 103  
DUTIES AND POWERS OF COMMISSIONER OF BUILDINGS

§28-103.1 Jurisdiction. This code shall be enforced by the commissioner of buildings, pursuant to the provisions of section six hundred forty-three of the New York city charter. However, the commissioner of small business services may also enforce all of the provisions of this code with respect to buildings under the jurisdiction of the department of small business services and the fire commissioner may also enforce all the provisions of this code relating to:

1. The approved number of persons in places of assembly (overcrowding);
2. Obstruction of aisles, corridors, and exits;
3. The posting and availability for inspection of certificates of occupancy or other authorization of lawful occupancy, certificates of compliance and place of assembly certificates of operation;
4. The maintenance of fire, smoke and carbon monoxide detection and alarm systems, fire extinguishing systems, refrigerating systems, storage tanks and auxiliary storage tanks for oil burning equipment, exit signs and path markings, and any fire or life safety system, equipment or device intended for use by fire fighting personnel or whose use or operation is subject to the New York city fire code or other law or rule enforced by the New York city fire department, and any related installation and signage;  
and
5. The installation and testing of fire alarm systems, smoke-detecting and carbon monoxide detecting devices that are interconnected with a fire alarm system or monitored by a central station, and fire extinguishing systems for commercial cooking appliances.

§28-103.1.1 Installation of equipment required by the New York city fire code. Where the installation of exit signs, emergency means of egress illumination, special mechanical ventilation and sprinkler and fire alarm systems is required by the New York city fire code, the fire commissioner shall require such installations to be in accordance with this code.

§28-103.1.2 Enforcement of New York city construction codes on property within the jurisdiction of the department of small business services. This code and the 1968 building code shall apply to property within the jurisdiction of the department of small business services pursuant to the New York city charter including, but not limited to, structures on waterfront property used in conjunction with and in furtherance of waterfront commerce and/or navigation. It shall be administered and enforced by the department of small business services in the same manner as property within the jurisdiction of the

department. The commissioner of small business services may delegate one or more administrative or enforcement functions to the department of buildings.

§28-103.2 Interpretation. This code shall be liberally interpreted to secure the beneficial purposes thereof.

§28-103.3 Variations. The requirements and standards prescribed in this code shall be subject to variation in specific cases by the commissioner, or by the board of standards and appeals, under and pursuant to the provisions of paragraph two of subdivision (b) of section six hundred forty-five and section six hundred sixty-six of the New York city charter, as amended.

§28-103.4 Appeals. An appeal from any decision or interpretation of the commissioner may be taken to the board of standards and appeals pursuant to the procedures of the board, except as provided in section 25-205 of the administrative code or as otherwise provided in this code.

§28-103.5 Seal; judicial notice. The commissioner may design and adopt a seal for the department for use in the authentication of the orders and proceedings of the department, and for such other purposes as the commissioner may prescribe. The courts shall take judicial notice of such seal, and of the signature of the commissioner, the deputy commissioners, and the borough superintendents of the department.

§28-103.6 Proofs, affidavits and oaths. Proofs, affidavits and examinations as to any matter arising in connection with the performance of any of the duties of the department may be taken by or before the commissioner, or a deputy commissioner, or such other person as the commissioner may designate; and such commissioner, deputy or other person may administer oaths in connection therewith.

§28-103.7 Cooperation of other departments. Upon request of the commissioner, it shall be the duty of all departments to cooperate with the department of buildings at all times, and to furnish to such department such information, reports and assistance as the commissioner may require.

§28-103.8 Matters not provided for. Any matter or requirement essential for fire or structural safety or essential for the safety or health of the occupants or users of a structure or the public, and which is not

covered by the provisions of this code or other applicable laws and rules, shall be subject to determination and requirements by the commissioner in specific cases.

§28-103.9 Additional tests. Whenever there is insufficient evidence of compliance with the provisions of this code, or evidence that a material or method of construction does not conform to the requirements of this code, or in order to substantiate claims for alternative materials or methods, the commissioner shall have the authority to require tests as evidence of compliance to be made at no expense to the city. Test methods shall be as specified in this code, or by other recognized test standards approved by the commissioner. In the absence of recognized and accepted test methods, the commissioner shall approve the testing procedures. Tests shall be performed as directed by the commissioner. Reports of such tests shall be retained by the department for the period required for retention of public records.

§28-103.10 Supporting documentation for materials. Whenever this code or the rules of the department permits the use of material regulated in its use by this code or the 1968 building code without the prior approval of the commissioner, the commissioner may, in the interest of public safety, require the submittal of supporting documentation that any material used or proposed to be used complies with the applicable code standard for such use. Such supporting documentation may consist of but shall not be limited to certification documents of an approved agency, test reports, analysis, computations or other evidence of such compliance.

§28-103.11 Applications and permits. The department shall receive and review applications, construction documents, and other submittal documents and shall issue permits, in accordance with the provisions of this code.

§28-103.12 Identification. Department personnel shall carry metal badges with suitable inscriptions thereon or other prescribed identification when inspecting structures or premises or otherwise in the performance of their duties under this code.

§28-103.13 Right of entry. The commissioner or his or her authorized representatives, in the discharge of their duties, shall have the right to enter upon and inspect, at all reasonable times, any buildings, enclosure, premises, or any part thereof, or any signs or service equipment contained therein or attached thereto for the purpose of determining compliance with the provisions of this code and other applicable building laws and rules. Officers and employees of the department shall identify themselves by exhibiting the official badge or other identification prescribed by the department; and other authorized representatives of the commissioner shall identify themselves by producing and exhibiting their authority in writing signed by the commissioner. If access is not obtained, the commissioner shall have recourse to remedies provided by law to secure entry.

§28-103.14 Department records. The department shall keep official records of applications received, permits and certificates issued, fees collected, reports of inspections, and notices and orders issued. Such records shall be retained in the official records for the period required for retention of public records.

§28-103.14.1 List of permits for cellular antenna. The commissioner shall maintain a separate list of alteration permits issued for the erection or placement of antennae used to provide cellular telephone or similar service or any structure related to such service which shall, at a minimum, set forth the name, business address and business telephone number of the applicant, the date of the application, the date the permit was issued, the location for which the permit was issued, including the premises address and the zoning district, whether residential, commercial, or manufacturing, and the number of permits issued for such purpose at the same location. Such list shall be made available to the public upon request between regular business hours and shall be available to the public in electronic format on a 24-hour basis on the department's website.

§28-103.15 Insurance. The commissioner may require applicants for permits to obtain and furnish proof of workers' compensation, disability and general liability insurance in such amounts and in accordance

with such specifications as shall be set forth in the rules of the department or as otherwise required by law.

§28-103.16 Inspections of completed buildings, structures, signs, service equipment and construction machinery and equipment. In addition to other required inspections, the commissioner may make or require inspections of completed buildings, structures, signs, service equipment installations and construction machinery and equipment to ascertain compliance with the provisions of this code and other laws that are enforced by the department. Such inspections may be made on behalf of the department by officers and employees of the department and other city departments and governmental agencies; and by approved agencies, special inspectors or other persons when the commissioner is satisfied as to their qualifications and reliability. The commissioner may accept inspection and test reports from persons authorized by this code or by the commissioner to perform such inspections. Such reports shall be filed with the department.

§28-103.17 Certain outside work, employment and financial interests of department employees prohibited. It shall be unlawful for any officer or employee of the department to be engaged in conducting or carrying on business as an architect, engineer, carpenter, plumber, iron worker, mason or builder, or any other profession or business concerned with the construction, alteration, sale, rental, development, or equipment of buildings. It shall also be unlawful for such employees to be engaged in the manufacture or sale of automatic sprinklers, fire extinguishing apparatus, fire protection devices, fire prevention devices, devices relating to the means or adequacy of exit from buildings, or articles entering into the construction or alteration of buildings, or to act as agent for any person engaged in the manufacture or sale of such articles, or own stock in any corporation engaged in the manufacture or sale of such articles.

§28-103.18 Investigation of complaints. The commissioner shall cause all complaints to be investigated. For purposes of investigating complaints of violations of law enforced by the department, the

commissioner may by rule establish a program to classify structures based on their enforcement history and may create criteria for such classification and assign enforcement resources accordingly.

§28-103.18.1 Complaint records. The department shall keep records of complaints made by any person in reference to any building or other matter under the jurisdiction of the department. Recorded complaints shall include the name and residence of the complainant, the name of the person complained of, the date of the entry of the complaint and any suggested remedies. Except for entries of names and residences of the complainants, such records shall be made available for public examination.

§28-103.19 Addition, modification, and deletion of referenced standards. The standards referenced in this code may be added to, deleted or modified pursuant to local law or by rule of the department. Every such rule adding, deleting or modifying a referenced standard shall indicate the promulgating agency of the standard, the standard identification, the effective date and title and the section or sections of this code to which such standard applies. The commissioner shall act in consultation with the fire commissioner on matters relating to fire safety.

Exception: Referenced standards in the New York city plumbing code, other than referenced national standards contained in chapter 13 of such code, shall not be added to, deleted, or modified by rule.

#### ARTICLE 104 CONSTRUCTION DOCUMENTS

§28-104.1 General. The department shall not issue a permit pursuant to this code, or a place of assembly operation certificate pursuant to this code unless and until it approves all required construction documents for such work. The department shall not issue an electrical work permit pursuant to the New York city electrical code for fire and emergency alarm systems, solar panels and wind turbines unless and until it approves all required construction documents for such work. Such construction documents shall be prepared by or under the supervision of a registered design professional as required by this code. An

application for an associated work permit shall not be submitted to the department until all required construction documents have been approved.

§28-104.1.1 Construction documents subject to the New York city fire code. Except as the New York city fire code may otherwise provide, the construction documents for facilities and systems for which the fire code provides design and installation requirements, including but not limited to fire alarm systems, flammable and combustible liquids, compressed gases, explosives and other hazardous materials; flammable spraying systems and facilities; automatic water sprinkler systems for hazardous material and combustible material storage, and non-water fire extinguishing systems, shall be subject to the review and approval of the fire commissioner in accordance with the New York city fire code. Approval by the department of construction documents for new or existing buildings containing such facilities and systems shall not be construed as approval of such systems and facilities.

§28-104.2 Application for approval of construction documents. The department shall assign a job number to and docket all applications for approval of construction documents and any amendments thereto filed with it. The department shall examine the construction documents promptly after their submission. The examination shall be made under the direction of the commissioner for compliance with the provisions of this code and other applicable laws and rules. The personnel employed for the examination of construction documents shall be qualified registered design professionals, experienced in building construction and design.

§28-104.2.1 Less than full examination of construction documents. The commissioner may, in the commissioner's discretion, establish a program whereby construction documents may be accepted with less than full examination by the department based on the professional certification of an applicant who is a registered design professional.

§28-104.2.1.1 Effect of acceptance. Except as otherwise specified in this code or in the rules of



the department, for the purposes of this code, the acceptance of construction documents in accordance with such program shall have the same force and effect as the approval of construction documents after full examination by the department. Except as otherwise specified in this code or in the rules of the department, references in this code to approved construction documents or to the approval of construction documents shall also be deemed to refer to accepted construction documents or to the acceptance of construction documents, as applicable.

§28-104.2.1.2 Program requirements. The commissioner may establish qualifications and requirements for registered design professionals to participate in such program and may exclude, suspend or otherwise sanction participants for cause.

§28-104.2.1.3 Mandatory program requirements. Registered design professionals participating in such program shall be subject to sections 28-104.2.1.3 .1 through 28-104.2.1.3 .2

§28-104.2.1.3.1 Probation. A registered design professional shall not be eligible to participate in the program during any period of probation imposed as a sanction by the board of regents pursuant to section 6511 of the education law.

§28-104.2.1.3.2 Mandatory sanctions. The commissioner shall, after the opportunity for a hearing before the office of administrative trials and hearings in accordance with department rules, exclude, suspend or otherwise condition the participation of a registered design professional who (i) knowingly or negligently submits a professional certification of an application and/or construction documents that contains false information or is not in compliance with all applicable provisions of law, or (ii) submits two professionally certified applications for construction document approval within any 12-month period containing errors that result in revocation of an associated permit or that otherwise demonstrate incompetence or a lack of knowledge of applicable laws. The term “otherwise condition” shall

mean limitations on such professional's participation in the program, such as, but not limited to, audits and monitoring of the registered design professional's applications and other submissions.

§28-104.2.1.3.2.1 Reinstatement. A registered design professional who is excluded from the program in accordance with section 28-104.2.1.3 may apply for reinstatement one year or more after such exclusion. An applicant who the commissioner finds is qualified to resume participation in the program shall be on probation for a period of not less than 6 months after reinstatement and during that time shall as a condition of such reinstatement attend one or more training or continuing education courses, approved by the department, related to compliance with the building code and related laws and rules and the zoning resolution. The professional shall submit satisfactory proof of the successful completion of such training or continuing education courses to the department.

§28-104.2.1.3.2.2 Construction. Nothing herein shall be construed to limit the commissioner's power, consistent with state and local law, to adopt rules that include additional grounds to limit the filing privileges of or otherwise sanction registered design professionals, after the opportunity for a hearing, who it determines, knowingly or negligently submit applications or other documents to the department that contain false information or are not in compliance with all applicable provisions of law or that otherwise demonstrate incompetence or a lack of knowledge of applicable law or standards.

§28-104.2.1.4 Database. The department shall create and maintain a database of all registered design professionals who have been excluded, suspended or otherwise sanctioned by the department. Within 7 business days of the date a sanction is imposed, the department shall post on its website and shall make available upon request, the name of the registered design professional, a

description of the sanction, the initial date of the sanction, the reinstatement date, if applicable, the address of the premises for which the application associated with the sanction was submitted, and whether the sanction was imposed after a hearing or a settlement.

§28-104.2.1.5 Applicant requirement. The program shall include a condition that the applicant remain with the job until it is signed-off by the department and that if the applicant withdraws from the job before the issuance of a letter of completion or certificate of occupancy, as applicable, all work shall stop and no permit, letter of completion or certificate of occupancy shall be issued until a successor registered design professional is designated as applicant and such person submits (i) a professional certification indicating his or her concurrence with the construction documents as accepted by the department or (ii) new construction documents are approved or accepted by the department.

§28-104.2.2 Approval or acceptance to be indicated on construction documents. All construction documents, when approved, shall be stamped or endorsed “approved” under the official method of the department, followed by a notation of the date except that construction documents accepted with less than full examination by the department shall be stamped or endorsed “accepted” instead of “approved”. One set of “approved” or “accepted” construction documents shall be retained by the department and another set shall be maintained at the job site until the work authorized by the permit is completed and signed-off by the department.

§28-104.2.3 Time limitation of application. An application for approval of construction documents shall be deemed to have been abandoned 12 months after the date of its submission, unless such application has been diligently prosecuted after rejection in whole or in part, or unless a permit shall have been issued pursuant to this code, except that the commissioner may upon application, for reasonable cause, grant extensions of time for additional 12-month periods.

§28-104.2.4 Conditions of approval. All construction documents approved by the commissioner shall be conditioned upon and subject to compliance with the requirements of this code and other applicable laws and rules in effect at the time of issuance of the associated work permit or place of assembly certificate of operation.

§28-104.2.5 Phased or partial approval. In the case of construction documents for the construction of new buildings or the alteration of buildings, the commissioner may grant partial approval of construction documents for the issuance of foundation and earthwork permits before the construction documents for the entire building or structure have been submitted. The approval of such partial applications will be subject to the submittal and approval of construction documents, filed together or separately, comprising:

1. The lot diagram showing the exact location of the lot and dimensions to the nearest corner;
2. A complete zoning analysis showing compliance of the proposed work with the zoning resolution;
3. The foundation plans, as provided for in this code; and
4. The floor and roof plans showing compliance with exit requirements, as provided for in this code.

The issuance of such foundation and earthwork permit is subject to submission of required submittal documents. The owner and the holder of such foundation and earthwork permit shall proceed at their own risk with the construction operation and without assurance that a permit for the entire structure will be granted.

§28-104.2.6 Deferred submittal. With the prior approval of the department, the applicant may defer submittal of portions of the design until a specified period of time after the issuance of a permit. The applicant shall list the deferred submittal items on the initial application for construction

document approval. The deferred submittal items shall not be constructed or installed until the design and submittal documents for the item have been approved by the department.

§28-104.2.7 Time period for review. Completed construction documents complying with the provisions of this code and other applicable laws and rules shall be approved by the commissioner and written notice of approval shall be given the applicant promptly and no later than 40 calendar days after the submission of a complete application.

Exceptions:

1. On or before the fortieth day, the commissioner may, for good cause shown and upon notification to the applicant, extend such time for an additional 20 calendar days.
2. Such time period for review shall commence in accordance with article 107 for single room occupancy multiple dwellings.

§28-104.2.8 Notification of rejection. Applications failing to comply with the provisions of this code and other applicable laws and rules shall be rejected and written notice of rejection, stating the grounds of rejection, shall be given the applicant promptly and not later than the date required in section 28-104.2.7.

§28-104.2.9 Resubmission. Whenever an application has been rejected and is thereafter revised and resubmitted to meet the stated grounds of rejection, the revised application and construction documents shall be approved if they meet the stated grounds of rejection and otherwise comply with the provisions of this code and other applicable laws and rules or shall be rejected if they fail to meet the stated grounds of rejection or otherwise fail to so comply. Written notice of approval or written notice of rejection, stating the grounds of rejection, shall be given the applicant promptly and not later than 20 calendar days after the resubmission of such documents.

§28-104.2.10 Revocation of approval. The commissioner may, on notice to the applicant, revoke the

approval of construction documents for failure to comply with the provisions of this code or other applicable laws or rules; or whenever there has been any false statement or any misrepresentation as to a material fact in the submittal documents upon the basis of which such approval was issued; or whenever an approval has been issued in error and conditions are such that approval should not have been issued. Such notice shall inform the applicant of the reasons for the proposed revocation and that the applicant has the right to present to the commissioner or his or her representative within 10 business days of personal service or 15 calendar days of the posting of service by mail, information as to why the approval should not be revoked.

§28-104.2.10.1 Effect on work permit. The effect of revocation of approval of construction documents is the automatic revocation of all associated work permits that may have been issued.

§28-104.3 Amended construction documents. Subject to the time limitations set forth in this code, amendments to approved construction documents shall be submitted, reviewed and approved before the final inspection of the work or equipment is completed; and such amendments when approved shall be deemed part of the original construction documents. The department may allow minor revisions of construction documents to be made and submitted to the department after the completion of work but prior to sign-off of the work in accordance with department rules.

§28-104.4 Place of filing. Except as otherwise provided by rule, applications for construction document approval shall be filed in the department office in the borough in which the work or equipment is located or at the discretion of the commissioner shall be submitted electronically.

§28-104.5 Fees. Filing fees shall be paid as required by article 112.

§28-104.6 Applicant. The applicant for approval of construction documents shall be the registered design professional who prepared or supervised the preparation of the construction documents on behalf of the owner.

Exception: The applicant may be other than a registered design professional for:

1. Limited plumbing alterations, limited sprinkler alterations, and limited standpipe alterations, where the applicant is licensed to perform such work pursuant to this code;
2. Demolition applications other than those specified in section 3306.5 of the New York city building code, where the applicant is the demolition contractor performing such demolition. In such cases, the commissioner may require structural plans designed by a registered design professional to address any critical structural, sequencing or site safety items;
3. Elevator applications;
4. Other categories of work consistent with rules promulgated by the commissioner.

§28-104.7 Submittal of construction documents. All construction documents submitted to the department shall contain such information and shall be in such form as shall be set forth in this section 28-104.7 and the rules of the department. Construction documents shall also conform to standards as may be prescribed in the applicable sections of the construction codes.

§28-104.7.1 Scope. Construction documents shall be complete and of sufficient clarity to indicate the location and entire nature and extent of the work proposed, and shall show in detail that they conform to the provisions of this code and other applicable laws and rules; if there exist practical difficulties in the way of carrying out the strict letter of the code, laws or rules, the applicant shall set forth the nature of such difficulties.

§28-104.7.2 Forms. The applicant shall submit construction documents on or accompanied by forms provided by the department.

§28-104.7.3 Media. Construction documents shall be printed upon suitable material, or presented as electronic media documents as determined by the commissioner. Plans shall be drawn to suitable scale.

§28-104.7.4 Quantities. The applicant shall submit the number of copies of construction documents as the commissioner shall require.

§28-104.7.5 Citations to code sections required. In no case shall terms such as “code compliant”, “approved”, “legal” or similar terms be used in the construction documents as a substitute for specific reference to a particular code section, approval or standard in order to show compliance with code requirements or other applicable laws and rules.

§28-104.7.6 City Datum. All elevations noted in the construction documents shall be referred to and clearly identified as the United States coast and geodetic survey mean sea level datum of 1929 (national geodetic vertical datum, “NGVD”), which is hereby established as the city datum. By way of examples, tables 104.7.6.1 through 104.7.6.5 shall be used to convert borough elevations to their corresponding equivalent NGVD elevations.

**TABLE 104.7.6.1**

<b><u>BRONX</u></b> <b><u>Elevations</u></b>	<b><u>To obtain</u></b> <b><u>equivalency:</u></b>	<b><u>NGVD</u></b> <b><u>Elevations</u></b>
10.000	→ add 2.608 →	12.608
7.392	→ add 2.608 →	10.000

**TABLE 104.7.6.2**

<b><u>BROOKLYN</u></b> <b><u>Elevations</u></b>	<b><u>To obtain</u></b> <b><u>equivalency:</u></b>	<b><u>NGVD</u></b> <b><u>Elevations</u></b>
10.000	→ add 2.547 →	12.547
7.453	→ add 2.547 →	10.000

**TABLE 104.7.6.3**

<b><u>MANHATTAN</u></b> <b><u>Elevations</u></b>	<b><u>To obtain</u></b> <b><u>equivalency:</u></b>	<b><u>NGVD</u></b> <b><u>Elevations</u></b>
10.000	→ add 2.752 →	12.752
7.248	→ add 2.752 →	10.000



**TABLE 104.7.6.4**

<b><u>QUEENS</u></b> <b><u>Elevations</u></b>	<b><u>To obtain</u></b> <b><u>equivalency:</u></b>	<b><u>NGVD</u></b> <b><u>Elevations</u></b>
10.000	→ add 2.725 →	12.725
7.275	→ add 2.725 →	10.000

**TABLE 104.7.6.5**

<b><u>+STATEN</u></b> <b><u>ISLAND Elevations</u></b>	<b><u>To obtain</u></b> <b><u>equivalency:</u></b>	<b><u>NGVD</u></b> <b><u>Elevations</u></b>
10.000	→ add 3.192 →	13.192
6.808	→ add 3.192 →	10.000

§28-104.7.7 Identification of special inspections. Whenever materials are subject to special inspection, as provided in this code, such materials shall be listed on the title sheet of the construction documents, or the sheet immediately following, as subject to special inspection.

§28-104.7.8 Identification of materials. Construction documents shall identify all materials proposed to be used, including identification of the test standard to which they conform, and where applicable, supporting information or test data from the manufacturer attesting to such conformance.

§28-104.7.9 Energy conservation construction code. The application shall contain all information required to demonstrate compliance with the energy conservation construction code of New York state.

§28-104.7.10 Preparer. Each plan or drawing shall contain the registration number, seal, signature (or equivalent as approved by the commissioner) and address of the registered design professional who prepared or supervised the preparation of the plans.

§28-104.7.11 Additional information. In addition to the data and information specified in this code and the rules of the department, the commissioner is authorized to require the submission of additional plans, surveys, computations, analyses, test reports, photographs, special inspection and such other

data and information as may be necessary to determine compliance with this code and other applicable laws and rules.

§28-104.7.12 Waiver of certain documents. The commissioner is authorized to waive the submission of any of the required construction documents and other data if review of such documents is not necessary to ascertain compliance with this code or not required for the phase of work for which a permit is sought.

§28-104.8 Applications. All applications shall comply with sections 28-104.8.1 through 28-104.8.4.

§28-104.8.1 Applicant statements. The application shall contain the following signed and sealed statements by the applicant:

1. A statement certifying that the applicant is authorized by the owner to make the application and certifying that, to the best of the applicant's knowledge and belief, the construction documents comply with the provisions of this code or the 1968 building code, if applicable, and other applicable laws and rules; if there exist practical difficulties in the way of carrying out the strict letter of the code, laws or rules, the applicant shall set forth the nature of such difficulties in such signed statement; and
2. A statement certifying (i) that the site of the building to be altered or demolished, or the site of the new building to be constructed, contains no occupied housing accommodations subject to rent control or rent stabilization under chapters 3 and 4 of title 26 of the administrative code, or (ii) that the owner has notified the New York state division of housing and community renewal of the owner's intention to file such plans and has complied with all requirements imposed by the regulations of such agency as preconditions for such filing; or (iii) that the owner has not notified such agency of the owner's intention to file because the nature and scope of the work proposed, pursuant to such regulations, does not require notification.

3. A professional certification.

4. A statement certifying compliance with the energy conservation construction code of New York state.

§28-104.8.2 Owner statement. The application shall contain a signed statement by the owner, cooperative owners' corporation, or condominium owners' association stating that the applicant is authorized to make the application and, if applicable, acknowledging that construction documents will be accepted with less than full examination by the department based on the professional certification of the applicant. Such statement shall list the owner's full name and address, as well as the names of the principal officers, partners or other principals if a corporation, partnership or other entity. Principal officers of a corporation shall be deemed to include the president, vice presidents, secretary and treasurer.

§28-104.8.3 Information of applicant, filing representative, and owner. The application shall set forth the full names, addresses, telephone numbers, and where available, e-mail addresses of the following persons and where any of such persons are corporations, partnerships or other business entities, the names and addresses of the principal officers, partners or other principals of such entity:

1. The applicant;
2. The filing representative;
3. The owner, cooperative owners' corporation, or condominium owners' association; and
4. Where a person other than the owner has engaged the applicant, such cooperative unit shareholder, condominium unit owner, lessee, or mortgagee.

§28-104.8.4 Tenant protection plan. Construction documents for alterations of buildings in which any dwelling unit will be occupied during construction shall include a tenant protection plan. Such plan shall contain a statement that the building contains dwelling units that will be occupied during

construction and shall indicate in sufficient detail the specific units that are or may be occupied during construction, the means and methods to be employed to safeguard the safety and health of the occupants, including, where applicable, details such as temporary fire-rated assemblies, opening protectives, or dust containment procedures. The elements of the tenant protection plan may vary depending on the nature and scope of the work but at a minimum shall make detailed and specific provisions for:

1. Egress. At all times in the course of construction provision shall be made for adequate egress as required by this code and the tenant protection plan shall identify the egress that will be provided. Required egress shall not be obstructed at any time except where approved by the commissioner.
2. Fire safety. All necessary laws and controls, including those with respect to occupied dwellings, as well as additional safety measures necessitated by the construction shall be strictly observed.
3. Health requirements. Specification of methods to be used for control of dust, disposal of construction debris, pest control and maintenance of sanitary facilities, and limitation of noise to acceptable levels shall be included.
  - 3.1. There shall be included a statement of compliance with applicable provisions of law relating to lead and asbestos.
4. Compliance with housing standards. The requirements of the New York city housing maintenance code, and, where applicable, the New York state multiple dwelling law shall be strictly observed.
5. Structural safety. No structural work shall be done that may endanger the occupants.

6. Noise restrictions. Where hours of the day or the days of the week in which construction work may be undertaken are limited pursuant to the New York city noise control code, such limitations shall be stated.

ARTICLE 105  
PERMITS

§28-105.1 General. It shall be unlawful to construct, enlarge, alter, repair, move, demolish, remove or change the use or occupancy of any building or structure in the city, or to erect, install, alter, repair, or use or operate any sign or service equipment in or in connection therewith, or to erect, install, alter, repair, remove, convert or replace any gas, mechanical, plumbing or fire suppression system in or in connection therewith or to cause any such work to be done unless and until a written permit therefore shall have been issued by the commissioner in accordance with the requirements of this code, subject to such exceptions and exemptions as may be provided in section 28-105.4.

§28-105.2 Classification of work permits. For the purposes of this code, work permits shall be classified as follows:

1. New building permits: for the construction of new buildings.
2. Alteration permits: for the alteration of buildings or structures, including partial demolition in conjunction therewith.
3. Foundation and earthwork permits: for the construction or alteration of foundations, including earthwork, excavation, and fill.
4. Full demolition permits: for the full demolition of buildings or structures.
5. Plumbing permits: for the installation or alteration of plumbing and plumbing systems, including gas piping. Such permits shall include permits for limited plumbing alterations.
6. Sign permits: for the erection or alteration of signs and sign structures.
7. Service equipment permits: for the installation or alteration of service equipment, including but

not limited to air conditioning and ventilating systems, boilers, elevators, escalators, moving walkways and dumbwaiters.

8. Temporary construction equipment permits: for the erection, installation and use of temporary structures to facilitate construction and/or for public or worker safety during construction, including but not limited to temporary fences, railings, catch platforms, over-the-sidewalk chutes, footbridges, sidewalk sheds, and scaffolds.

9. Fire suppression system permits: for the installation and alteration of fire suppression systems, including but not limited to sprinkler systems, standpipe systems, and non-water systems. Such permits shall include permits for limited sprinkler alterations and limited standpipe alterations.

10. Crane and derrick permits: for the use of power operated cranes and derricks during construction.

§28-105.3 Separate permits required. Separate work permits shall be required, as provided above, except that separate permits for foundations and earthwork, or for the installation or alteration of air conditioning systems, ventilation systems, and heating systems shall not be required whenever such work is included in and forms a part of the construction documents filed for the construction of a new building or the alteration of a building or structure.

§28-105.4 Work exempt from permit. Exemptions from permit requirements of this code shall not be deemed to grant authorization for any work to be done in any manner in violation of the provisions of this code, the zoning resolution or any other law or rules enforced by the department. Such exemptions shall not relieve any owner of the obligation to comply with the requirements of or file with other city agencies.

Unless otherwise indicated, permits shall not be required for the following:

1. Emergency work, as set forth in section 28-105.4.1.
2. Minor alterations and ordinary repairs, as described in section 28-105.4.2.
3. Certain work performed by a public utility company or public utility corporation, as set forth in

section 28-105.4.3.

4. Ordinary plumbing work, as set forth in section 28-105.4.4.

5. Permits for the installation of certain signs, as set forth in section 28-105.4.5.

6. Other categories of work as described in department rules, consistent with public safety.

§28-105.4.1 Emergency work. Work that would otherwise require a permit may be performed without a permit to the extent necessary to relieve an emergency condition. An application for a permit shall be submitted within 2 business days after the commencement of the emergency work and shall include written description of the emergency condition and the measures undertaken to mitigate the hazard.

Emergency work may include but shall not be limited to:

1. Erection of sidewalk sheds, fences, or other similar structures to protect the public from an unsafe condition.
2. Stabilization of unsafe structural conditions.
3. Repair of gas leaks.
4. Repair or replacement of heating or hot water equipment servicing residential occupancies during the heating season as established by the New York city housing maintenance code.
5. Replacement of parts required for the operation of a combined standpipe or sprinkler system.

§28-105.4.2 Minor alterations and ordinary repairs. A permit shall not be required for minor alterations and ordinary repairs.

§28-105.4.2.1 Definitions. The following words and terms shall, for the purposes of this section 28-105.4.2 and as used elsewhere in this code, have the meanings shown herein.

MINOR ALTERATIONS. Minor changes or modifications in a building or any part thereof, excluding additions thereto, that do not in any way affect health or the fire or structural safety of the building or the safe use and operation of the service equipment therein. Minor alterations shall

not include any of the work described as “work not constituting minor alterations or ordinary repairs.”

ORDINARY REPAIRS. Replacements or renewals of existing work in a building, or of parts of the service equipment therein, with the same or equivalent materials or equipment parts, that are made in the ordinary course of maintenance and that do not in any way affect health or the fire or structural safety of the building or the safe use and operation of the service equipment therein. Ordinary repairs shall include the repair or replacement of any plumbing fixture, piping or faucets from any exposed stop valve to the inlet side of a trap. Ordinary repairs shall not include any of the work described as “work not constituting minor alterations or ordinary repairs.”

WORK NOT CONSTITUTING MINOR ALTERATIONS OR ORDINARY REPAIRS. Minor alterations or ordinary repairs shall not include:

1. The cutting away of any load bearing or required fire rated wall, floor, or roof construction, or any portion thereof.
2. The removal, cutting, or modification of any beams or structural supports;
3. The removal, change, or closing of any required exit;
4. The addition, rearrangement, relocation, removal or replacement of any parts of the building affecting loading or exit requirements, or light, heat, ventilation, or elevator requirements or accessibility requirements or any fire suppression system;
5. Additions to, alterations of, or rearrangement, relocation, replacement, repair or removal of any portion of a standpipe or sprinkler system, water distribution system, house sewer, private sewer, or drainage system, including leaders, or any soil, waste or vent pipe, or any gas distribution system;
6. Any plumbing work other than the repair or replacement of plumbing fixtures, piping or



faucets from the exposed stop valve to the inlet side of a trap;

7. The alteration or repair of a sign for which a permit is required; or

8. Any other work affecting health or the fire or structural safety of the building or the safe use and operation of the service equipment therein.

§28-105.4.3 Public utility company or public utility corporation. A permit shall not be required for:

1. The installation or alteration of gas service piping or gas meter piping including meters, valves, regulators, and related equipment, when such work is to be performed and serviced and maintained by utility corporations subject to the jurisdiction of the New York state public service commission;

2. The emergency repair of gas distribution piping when such work is performed by licensed master plumbers or by utility corporations subject to the jurisdiction of the New York state public service commission, in order to alleviate hazardous conditions, provided that a written report describing the details of such repairs shall be filed with the commissioner upon completion of the work.

§28-105.4.4 Ordinary plumbing work. The following ordinary plumbing work may be performed without a permit, provided that the licensed plumber performing such work: (i) provides a monthly report listing completed work and work in progress during the preceding month, including the block, lot and address of each job, a description of the work performed or in progress at each address, and the location in each building where the work was performed or is in progress; (ii) pays the fees for such work in accordance with this code; and (iii) submits to the department a certification that the work was performed in accordance with this code and all applicable laws and rules. Ordinary plumbing work shall include:

1. The removal of a domestic plumbing system not connected to a fire suppression system, or the

removal of a portion of such system.

2. The relocation of up to two plumbing fixtures within the same room to a maximum of 10 feet (3048 mm) distant from the original location, except in health care facilities.
3. The installation, replacement or repair of a food waste grinder (food waste disposal) or back flow preventer and the replacement or repair of a sump pump.
4. The replacement of closet bends.
5. In buildings in occupancy group R2 occupied by fewer than six families or in buildings in occupancy group R3, the replacement of a gas water heater or a gas fired boiler with a capacity of 350,000 BTU or less where the existing appliance gas cock is not moved, provided that the plumber has inspected the chimney and found it to be in good operational condition.
6. The repair or replacement of any non-gas, non-fire suppression piping not longer than 10 feet (3048 mm) inside a building, or connected piping previously repaired or replaced under this provision.
7. The repair or replacement of non-fire suppression branch piping after the riser shutoff valve, including the replacement of fixtures, limited to two bathrooms and one kitchen per building per monthly reporting period.

§28-105.4.5 Sign permits. A sign permit shall not be required where the sign is:

1. Painted directly on the exterior wall surface of a building or on the surface of a fence;
2. A wall sign of not more than six square feet (0.56 m<sup>2</sup>) in area;
3. Erected by employees of a city agency, including traffic and other similar signs;
4. A ground sign advertising the sale or rental of the premises on which it is erected, provided the sign does not exceed 12 square feet (1.1 m<sup>2</sup>) in area;

5. Temporary and erected during construction work and related thereto; or
6. Temporary for special decorative display use for holidays, public demonstrations, or the promotion of civic, welfare or charitable purposes, except that signs that utilize streets or cross streets shall be subject to the requirements of the department of transportation.
7. Temporary signs announcing the sale or rental of real property.

§28-105.5 Application for permit. All applications for permits shall be submitted on forms furnished by the department. Applications shall include all information required by this code, other applicable law or the rules of the department. The applicant shall list any portions of the design that have been approved for deferred submittal in accordance with section 28-104.2.6. The application shall set forth an inspection program for the job. An application for a permit shall be submitted no later than 12 months after the approval of all required construction documents (other than those documents approved for deferred submittal).

§28-105.6 Fees. Applications for permits shall be accompanied by the payment of appropriate fees as provided for in article 112.

§28-105.7 Time limitation of applications. An application for a permit shall be deemed to have been abandoned 12 months after the date of its submission, unless such application has been diligently prosecuted after rejection in whole or in part, or a permit shall have been issued except that the commissioner may, for reasonable cause, and upon payment of all reinstatement fees as provided for in this code, grant extensions of time for additional 12-month periods.

§28-105.8 Validity of permit. The issuance or granting of a permit shall not be construed to be a permit for, or an approval of, any violation of any of the provisions of this code or of any other law or rule. Permits presuming to give authority to violate or cancel the provisions of this code or other law or rule shall not be valid. The issuance of a permit based on construction documents and other data shall not prevent the

commissioner from requiring the correction of errors in the construction documents and other data. The commissioner is authorized to prevent any occupancy, use or work in violation of this code, the zoning resolution or other law or rule enforced by the department.

§28-105.8.1 Duration of permit. Permits may be issued for a period of up to two years unless otherwise limited by law.

§28-105.8.2 Signature of commissioner on permit. Every permit issued by the commissioner shall have his or her signature affixed thereto; but the commissioner may authorize any subordinate to affix such signature, including by the use of electronic means.

§28-105.9 Expiration. All permits issued by the commissioner shall expire by limitation and become invalid if the permitted work or use is not commenced within 12 months from the date of issuance of the permit or, if commenced, is suspended or abandoned for a period of 12 months thereafter. All permits for work in an area of special flood hazard pursuant to Appendix G of the New York city building code shall expire if the actual start of permanent construction has not occurred within 180 days from the date on which such permit is issued. The commissioner may, however, upon good cause shown, reinstate a work permit at any time within a period of two years from the date of issuance of the original permit, provided that the work shall comply with all the requirements of this code and other applicable laws and rules in effect at the time application for reinstatement is made, and provided further that the applicant shall pay all reinstatement fees as required by article 112. The permit shall automatically expire upon the expiration of required insurance or if the applicant holds a license issued by the department upon the expiration or revocation of such license during the term of the permit.

§28-105.10 Suspension or revocation of permit. The commissioner is authorized to suspend or revoke a permit issued under the provisions of this code.

§28-105.10.1 Notice of proposed revocation. The commissioner may, on written notice to the permit

holder, revoke any permit for failure to comply with the provisions of this code or other applicable laws or rules; or whenever there has been any false statement or any misrepresentation as to a material fact in the application or submittal documents upon the basis of which such approval was issued; or whenever a permit has been issued in error and conditions are such that the permit should not have been issued. Such notice shall inform the permit holder of the reasons for the proposed revocation and that the applicant has the right to present to the commissioner or his or her representative within 10 business days of delivery of the notice by hand or 15 calendar days of the posting of notice by mail, information as to why the permit should not be revoked.

§28-105.10.2 Immediate suspension in cases of imminent peril. The commissioner may immediately suspend any permit without prior notice to the permit holder when the commissioner has determined that an imminent peril to life or property exists. The commissioner shall forthwith notify the permit holder that the permit has been suspended and the reasons therefore, that it is proposed to be revoked, and that the permit holder has the right to present to the commissioner or his or her representative within 10 business days of delivery of the notice by hand or 15 calendar days of the posting of notice by mail information as to why the permit should not be revoked.

§28-105.11 Posting of permit. The building permit or copy shall be posted in a conspicuous place at the work site, visible to the public for the duration of the work or the use and operation of the equipment, or until the expiration of the permit. No such permit shall be posted or displayed at any location other than the location of the premises or equipment for which the permit was issued.

§28-105.12 Conditions of permit. Permits shall be subject to the following conditions:

§28-105.12.1 Compliance with code. Permits shall be deemed to incorporate the provisions that the applicant, the owner, their agents, employees, and contractors shall carry out the permitted work in accordance with the provisions of this code and other applicable laws or rules, whether specified or

not, except as variations have been legally permitted or authorized.

§28-105.12.2 Compliance with construction documents. All work shall conform to the approved construction documents, and any approved amendments thereto. Changes and revisions during the course of construction shall conform to the amendment requirements of this code.

§28-105.12.3 Adherence to lot diagram. All work shall be strictly located in accordance with the lot diagram approved in accordance with this code and no lot or plot shall be changed, increased or diminished in area from that shown on the approved lot diagram, unless and until a revised diagram showing such changes, accompanied by the necessary statement of the owner or applicant, shall have been submitted to and approved by the commissioner.

§28-105.12.4 Compliance with safety requirements. All work shall be conducted in accordance with and subject to the safety requirements of this code and other applicable laws or rules, including any order or requirement of the commissioner that the building or structure under construction or alteration be vacated, in whole or in part, during the progress of the work and until the issuance of a certificate of occupancy. Adjoining lots and properties shall be protected in accordance with this code.

§28-105.12.5 Compliance with noise control code required. All work shall be performed in compliance with the provisions of the New York city noise control code as set forth in chapter 2 of title 24 of the administrative code. Failure to comply with sections 24-222 and 24-223 of the administrative code shall be a violation of this code.

§28-105.12.6 Deferred submittals. Where permits are issued subject to deferred submittal of portions of the design as provided for in section 28-104.2.6, the deferred submittal items shall not be installed until the construction and submittal documents for such portions have been approved by the department and, where applicable, new or amended permits have been issued.

§28-105.12.7 Insurance. Where workers compensation, employee disability or liability insurance is required by law or department rule, the applicant for the work permit shall obtain and include proof of such insurance with the work permit application. The permit shall expire by operation of law if the insurance upon which the permit was conditioned lapses, expires or is cancelled, unless the permit holder files proof of alternate insurance before such event.

§28-105.12.8 Site safety plan. Where required by this code or by the department, applications shall include a site safety plan approved in accordance with the New York city building code. All work shall adhere to the site safety plan.

#### ARTICLE 106 ASBESTOS INVESTIGATION

§28-106.1 Asbestos investigation. In addition to the requirements otherwise prescribed, all applications for construction document approval for work on buildings constructed on or before April 1, 1987 shall include asbestos certifications, reports or removal plans as may be required by this article.

Exception: Types of activities exempted pursuant to rules of the commissioner of environmental protection.

§28-106.2 Demolition and alteration of buildings constructed on or before April 1, 1987. The commissioner shall not approve or accept an application for construction document approval for the demolition or alteration of a building constructed on or before April 1, 1987, unless the applicant submits (i) a certification from an asbestos investigator that the work to be performed will not constitute an asbestos project, (ii) an asbestos inspection report completed in accordance with the provisions of section 24-146.1 of the administrative code, or (iii) proof that an asbestos removal plan has been approved by the commissioner of the New York city department of environmental protection in accordance with section 24-146.1 of the administrative code.

§28-106.3 Asbestos project. The commissioner shall not approve construction documents for work that

constitutes an asbestos project and for which an asbestos inspection report is required unless the applicant at the time of application and prior to approval of the construction documents certifies on forms prescribed by the commissioner of environmental protection that the applicant is familiar with federal, state and local laws and regulations applicable to asbestos related work.

§28-106.4 Definitions. For the purposes of this article, the terms “asbestos,” “asbestos inspection report,” “asbestos investigator,” “asbestos project” and “asbestos removal plan” shall have the meanings as are ascribed in section 24-146.1 of the administrative code.

ARTICLE 107  
ALTERATION OR DEMOLITION OF SINGLE ROOM OCCUPANCY  
MULTIPLE DWELLINGS

§28-107.1 General. The commissioner shall not approve construction documents for the alteration or demolition of a single room occupancy multiple dwelling except as set forth in this article.

§28-107.2 Definitions. The following words and terms shall, for the purposes of this article and elsewhere in the code, have the meanings shown herein.

CLASS A MULTIPLE DWELLING, CLASS B MULTIPLE DWELLING, FURNISHED ROOM HOUSE, ROOMING UNIT AND SINGLE ROOM OCCUPANCY. Shall have the meanings set forth in section 27-2004 of the New York city housing maintenance code.

SINGLE ROOM OCCUPANCY MULTIPLE DWELLING. A single room occupancy multiple dwelling means:

1. A “class A multiple dwelling” used in whole or part as a “rooming house” or “furnished room house,” or for “single room occupancy” pursuant to section 248 of the New York state multiple dwelling law;
2. A “class A multiple dwelling” containing “rooming units”; or
3. A “class B multiple dwelling.”



Exception: The term single room occupancy multiple dwelling shall not include:

1. College or school dormitories;
2. Clubhouses;
3. Luxury hotels, as such term is defined by the commissioner of housing preservation and development; or
4. Residences whose occupancy is restricted to an institutional use such as housing intended for use by the employees of a single company or institution;
5. City-owned multiple dwellings; or
6. Any multiple dwelling containing fewer than nine “class B” dwelling units; used for single room occupancy unless the total number of such units is more than fifty percent of the total number of dwelling units in such multiple dwelling; or
7. Any multiple dwelling that:
  - 7.1. Is the subject of a program approved by the commissioner of housing preservation and development and related to the rehabilitation of a single room occupancy multiple dwelling or the provision of housing for persons of low or moderate income, other than a program consisting solely of real property tax abatement or tax exemption; and
  - 7.2. Has been exempted from the provisions of this article by the commissioner of housing preservation and development.

§28-107.3 Covered categories of work. Applications for the approval of construction documents for the following categories of work are covered by this article:

1. Demolition of a single room occupancy multiple dwelling;
2. Alteration of a single room occupancy multiple dwelling to a class A multiple dwelling to be used in whole or in part for other than single room occupancy purposes;

3. Alteration of a single room occupancy multiple dwelling resulting in the removal or addition of kitchen or bathroom facilities; and
4. Such other types of alteration work to a single room occupancy multiple dwelling as shall be prescribed by rule of the commissioner of housing preservation and development, in consultation with the commissioner.

Exceptions:

1. Work solely for the purpose of either (i) making the public areas of a multiple dwelling accessible to persons with disabilities without altering the configuration of any dwelling unit or rooming unit or (ii) making a dwelling unit or a rooming unit accessible to persons with disabilities shall not be covered by this article.
2. Repairs, demolition or any other work performed by a city agency or by a contractor pursuant to a contract with a city agency shall not be covered by this article.

§28-107.4 Required submittal documents. The commissioner shall not approve any construction documents for a single room occupancy multiple dwelling for the covered categories of work unless the applicant provides:

1. A sworn affidavit by or on behalf of all the owners, as such term is defined in section 27-2004 of the New York city housing maintenance code, of such multiple dwelling that there will be no harassment of the lawful occupants of such multiple dwelling by or on behalf of such owners during the construction period;
2. A tenant protection plan as provided for in this code; and
3. One of the following documents from the commissioner of housing preservation and development:
  - 3.1. A certification that there has been no harassment of the lawful occupants of such multiple dwelling within the 36 month period prior to submission of an application for such

certification to the department of housing preservation and development, provided, however, that such certification shall except any portion of such 36 month period during which title was vested in the city; or

3.2. A waiver of such certification.

§28-107.5 Filing process. After submitting an application for construction document approval to the commissioner and obtaining the identifying job number for the same, the applicant shall forward a copy of such application to the commissioner of housing preservation and development, together with an application for a certification of no harassment pursuant to section 27-2093 of the housing maintenance code.

§28-107.6 Time period for acceptance or rejection. The time period in which the commissioner is required to approve or reject an application for construction document approval or resubmission thereof pursuant to this code shall commence from the date that the commissioner receives either the certification or waiver pursuant to this article.

§28-107.7 Denial of certification. Where the commissioner of housing preservation and development denies the certification required by this article, the commissioner shall reject the application for construction document approval.

§28-107.8 Request for stop-work or rescission. The commissioner shall be empowered to issue a stop-work notice or order with respect to an alteration or demolition permit and/or to rescind approval of construction documents at the request of the commissioner of housing preservation and development pursuant to section 27-2093 of the New York city housing maintenance code.

§28-107.9 Effect of denial or rescission. Where the commissioner rejects or rescinds the approval of construction documents pursuant to this article, no further application for the covered categories of work shall be considered by the commissioner for a period of 36 months following the date of the denial of the

certification of no harassment by the commissioner of housing preservation and development or the date of the rescission of such certification of no harassment by such commissioner.

ARTICLE 108  
PAVEMENT PLAN

§28-108.1 General. The commissioner shall not issue a permit for the erection of a new building or for alterations that will require the issuance of a new or amended certificate of occupancy without a statement that no certificate of occupancy shall be issued unless the sidewalk in front of or abutting such building, including but not limited to the intersection quadrants for corner properties, shall have been paved or repaired by the owner, at his or her own cost, in the manner, of the materials, and in accordance with the standard specifications prescribed by the New York city department of transportation pursuant to sections 19-113 and 19-115 of the administrative code.

Exceptions:

1. Application for the erection of an accessory building appurtenant to an existing one- or two-family dwelling.
2. Where the commissioner determines that a sidewalk is not required, provided that such determination shall not affect the obligations of the owner under subdivision a of section 19-152 of the administrative code, nor relieve the owner of any such obligations, nor impair or diminish the rights of the city or its agencies to enforce such obligations.
3. Where the extent of the change in use or occupancy or the cost of the alteration does not exceed a threshold established pursuant to rule of the commissioner.

§28-108.2 Pavement plan required. Construction documents shall include a pavement plan processed and approved under guidelines established by the department. The pavement plan shall include documentation sufficient to show compliance with the standards and specifications of the New York city department of transportation pursuant to sections 19-113 and 19-115 of the administrative code.

Exception: No pavement plan shall be required with respect to an alteration application for a building where the applicant certifies that there is a sidewalk in existence in front of or abutting such building, including but not limited to the intersection quadrants for corner properties, complying with the specifications of the New York city department of transportation, and that the nature of such alteration work will neither remove such existing sidewalk nor cause damage to such existing sidewalk such that the damage could not be corrected as minor repairs prior to issuance of the certificate of occupancy.

§28-108.3 Improvement of streets. The commissioner shall insure that streets are suitably improved in accordance with the standards and specifications of the department of transportation as required by subdivision two of section thirty-six of the general city law and shall otherwise carry out the provisions of such subdivision.

#### ARTICLE 109 FIRE PROTECTION PLAN

§28-109.1 Fire protection plan required for covered buildings. New building and alteration applications for covered buildings as set forth in section 28-109.2 shall include a fire protection plan prepared by or under the supervision of a registered design professional who shall professionally certify such plan. Such plan shall be approved by the department and the fire department prior to issuance of a certificate of occupancy, a temporary certificate of occupancy or a letter of completion, as applicable.

Exception: No fire protection plan shall be required for an alteration that meets all three of the following requirements:

1. The alteration does not involve a change of use or occupancy;
2. The alteration does not exceed one million dollars; and
3. The alteration does not create an inconsistency with a previously approved fire protection plan.

§28-109.2 Covered buildings. Covered buildings include:

1. High-rise buildings subject to section 403 of the New York city building code.

2. Buildings where the main use or dominant occupancy is B, E, F, H, M, or S that are two or more stories in height with over 20,000 gross square feet (1858 m<sup>2</sup>) per floor or are two or more stories in height with a total building floor area exceeding 50,000 gross square feet (4645 m<sup>2</sup>).
3. Any building containing an assembly occupancy having an occupant load of 300 or more persons;  
and
4. Buildings where the main use or dominant occupancy is I or R-1 that are two or more stories in height and contain sleeping accommodations for 30 or more persons; and
5. Buildings where the main use or dominant occupancy is R-2 that contain 30 or more dwelling units and where over 10,000 gross square feet (929 m<sup>2</sup>) of floor area is used for mercantile, assembly, educational or institutional purposes.

§28-109.3 Scope. The plan shall include the following information, where applicable:

1. A description of the building including: address; block and lot numbers; number of stories; height in feet; occupancy group; construction classification; occupancy load and department of buildings job number;
2. All floors, exits, doors, corridors, and partitions serving as fire barriers, fire partitions, fire walls; locations and ratings of required enclosures and fire areas; stairs with pressurization; roof access; exit discharges; and locations of any required frontage space; and
3. In narrative form, a description of safety systems and features, including:
  - 3.1. Communications systems.
  - 3.2. Alarm systems.
  - 3.3. Smoke and carbon monoxide detection equipment.
  - 3.4. Location of fire command station.
  - 3.5. Elevator recall.

3.6. Emergency lighting and power.

3.7. Standpipes.

3.8. Sprinklers.

3.9. Emergency power systems.

3.10. Mechanical ventilation and air conditioning.

3.11. Smoke control systems and equipment.

3.12. Furnishings types and materials.

3.13. Places of assembly.

3.14. Fire department access.

3.15. Photoluminescent pathway markings.

3.16. Other safety related systems, required and voluntary, to be installed.

ARTICLE 110  
SITE SAFETY PLAN

§28-110.1 Site safety plan. Where a site safety plan is required by chapter 33 of the New York city building code, such plan shall include the following:

1. Location of all construction fences around work site;
2. Location of all gates in construction fences;
3. Location of standard guardrails around excavations, when required;
4. Horizontal and vertical netting program, including details of the initial installation, schedule of horizontal jumps and vertical installations, and designated crane and derrick lifting areas where horizontal netting is omitted. The program shall include as an attachment any department approval obtained regarding required safety netting during construction or demolition operations; the revised site safety plan shall be approved;

5. Location of all sidewalk sheds, including appropriate department application numbers and department of transportation permit numbers and expiration dates;
6. Location of all temporary walkways, including appropriate department application numbers and department of transportation permit numbers and expiration dates;
7. Location of foot bridges and motor vehicle ramps, including appropriate department application numbers and department of transportation permit numbers and expiration dates;
8. Protection of side of excavation, when required, including appropriate department application numbers and department of transportation permit numbers and expiration dates;
9. Location of all street and sidewalk closing(s), including appropriate department application numbers and department of transportation permit numbers and expiration dates;
10. Approximate location of material and personnel hoist(s) and loading areas, including appropriate department application numbers and department of transportation permit numbers and expiration dates;
11. Approximate location of all crane and derrick loading areas;
12. Location of all surrounding buildings, indicating occupancy, height and type of any required roof protection;
13. Location of all standpipe system and siamese hose connections;
14. Location of all temporary elevators for fire department use when building is above 75 feet (22 860 mm) in height;
15. Location of all exterior contractors' sheds;
16. All required safety netting and scaffolding;
17. Widths of all sidewalks and roadways; all traffic information; all exits from job site;
18. A copy of the proposed site safety manager or site safety coordinator's certificate, as applicable,



including the certificate for any alternate site safety manager or site safety coordinator; and

19. Such features requiring special sequencing in order to maintain safe conditions with a written description of those sequences.

§28-110.2 Phased site safety plans. Multiple layouts of the site safety features enumerated in section 28-110.1 may be submitted at any time during construction operations to show phased site safety designs consistent with the phase of anticipated work.

### ARTICLE 111 TEMPORARY STRUCTURES AND USES

§28-111.1 General. The commissioner is authorized to issue a permit for temporary structures and temporary uses. Such permits shall be limited as to time of service or use, but shall not be permitted for more than 30 days. The commissioner may grant extensions for demonstrated cause.

Exception: No permit shall be required for:

1. The erection and use of temporary tents of less than 400 gross square feet (37 m<sup>2</sup>) for not more than 30 days.
2. The erection and use of temporary platforms, reviewing stands, outdoor bandstands and similar miscellaneous structures that cover an area less than 120 square feet (11.16 m<sup>2</sup>), including connecting areas or spaces with a common means of egress or entrance, for not more than 30 days.

§28-111.2 Conformance. Temporary structures and uses shall conform to the structural strength, fire safety, means of egress, accessibility, light, ventilation and sanitary requirements of this code as necessary to ensure the public health, safety and general welfare.

§28-111.3 Termination of approval. The commissioner is authorized to terminate such permit for a temporary structure or use and to order the temporary structure or use to be discontinued.

§28-111.4 Application processing. Application for such structures and uses shall be submitted to the

department no later than 15 business days prior to the construction of the temporary structure or the commencement of the temporary use.

§28-111.5 Fees. Applications for such permits shall be accompanied by the applicable fees in accordance with article 112. Fees for subsequent requests for renewals shall be paid upon approval of such requests.

## ARTICLE 112 FEES

§28-112.1 Payment of fees. A permit, inspection, or other service or privilege as regulated in this code shall not be valid until the fees prescribed herein or in rules have been paid, nor shall a renewal of a permit or other service or privilege or an amendment to a permit be released until the fee has been paid. In addition, an approval required to be reissued due to a change in product name, company name and/or address, contact information or principals, shall not be reissued until a reissuance fee, if any, has been paid. The department shall adopt such rules and shall prescribe such forms as may be necessary to carry out the provisions of this article.

### Exceptions:

1. A permit, inspection or other service or privilege as regulated in this code shall not be subject to this provision if the owner of the building or property affected is a corporation or association organized and operated exclusively for religious, charitable or educational purposes, or for one or more such purposes, no part of the earnings of which inures to the benefit of any private shareholder or individual, and provided that the property affected is to be used exclusively by such corporation or association for one or more of such purposes.
2. A permit, inspection or other service or privilege as regulated in this code shall not be subject to this provision if the work proposed is emergency work performed by a city agency or by a contractor pursuant to a contract with a city agency.

§28-112.2 Schedule of permit fees. Permits for new buildings, structures, mechanical, and plumbing

systems or alterations requiring a permit shall be accompanied by a fee for each permit in accordance with the fee schedule of Table 28-112.2. Fifty percent of the total fee for the work permit, but not less than one hundred dollars, or the total fee for the work permit where such fee is less than one hundred dollars, shall be paid and shall accompany the first application for the approval of construction documents; and the whole or remainder of the total fee shall be paid before the work permit may be issued. The commissioner may require reasonable substantiation of any statement or other form that may be required by the department.

**Table 28-112.2**

<b><u>Permit Type</u></b>	<b><u>Initial Fee</u></b>	<b><u>Renewal Fee</u></b>	<b><u>Comments</u></b>
<b><u>New Buildings</u></b>			
<u>New building work permit: One-, two- or three-family dwelling</u>	<u>\$0.12 for each square foot, or fraction thereof, of the total floor area of the new building, but not less than \$100 for each structure</u>	<u>\$100.</u>	
<ul style="list-style-type: none"> <li>□ <u>Subsequent applications related to initial new building work permit application, including but not limited to elevators, filed prior to the first temporary certificate of occupancy (TCO), or the final certificate of occupancy if no TCO is issued</u></li> </ul>	<u>\$100. Each</u>	<u>\$100. Each</u>	
<ul style="list-style-type: none"> <li>□ <u>New building work permit: Garage for not more than three cars when accessory to and filed with plans for one-, two- or three-family dwelling to which it is accessory on the same lot</u></li> </ul>	<u>\$100.</u>	<u>\$100.</u>	

<p><u>New building work permit:</u> <u>All other new buildings</u></p> <p>□ <u>Subsequent applications related to initial new building work permit application, including but not limited to elevators, filed prior to the first temporary certificate of occupancy (TCO), or the final certificate of occupancy if no TCO is issued</u></p>	<p><u>\$0.26 for each square foot, or fraction thereof, of the total floor area of the new building, but not less than \$100 for each structure annually.</u></p> <p><u>\$100 each annually.</u></p>	<p><u>\$100 annually.</u></p> <p><u>\$100 annually.</u></p>	
<b><u>Alterations</u></b>			
<p><u>Alteration work permit:</u></p> <p>□ <u>One-, two- or three-family dwelling.</u></p> <p>□ <u>Permit to install and/or alter plumbing, plumbing system and/or fire suppression piping system in existing building: One-, two- or three-family dwelling.</u></p>	<p><u>\$100 for the first five thousand dollars, or fraction thereof, of the cost of alteration, excluding the cost for the installation or alteration of any plumbing or plumbing system or fire suppression piping system; not less than \$100 annually for subsequent years; plus \$5.15 for each one thousand dollars, or fraction thereof, of cost of alterations in excess of five thousand dollars.</u></p>	<p><u>\$100 annually.</u></p>	
<p><u>Alteration work permit:</u></p> <p>□ <u>Alterations in all other buildings and structures, including but not limited to aerial towers and masts, tank structures, fire escapes, etc., which are unoccupied and not easily valued by area;</u></p> <p>□ <u>Applications related to new building work permit application, filed after the</u></p>	<p><u>\$100 for the first three thousand dollars, or fraction thereof, of the cost of alteration not including the cost of the installation or alteration of any plumbing or plumbing system or fire suppression piping system; not less than \$100 annually for subsequent years; plus \$20 for each one thousand dollars, or fraction thereof, of the next two thousand dollars of such cost; plus</u></p>	<p><u>\$100 annually.</u></p>	

<p><u>first temporary certificate of occupancy (TCO), or the final certificate of occupancy if no TCO is issued.</u></p> <ul style="list-style-type: none"> <li>□ <u>Installation or alteration of elevators, escalators, amusement devices and other devices regulated under this code, except those filed under a new building application.</u></li> <li>□ <u>Permit to install and/or alter plumbing, plumbing system and/or fire suppression piping system in existing building: All buildings other than one-, two- or three-family dwelling.</u></li> </ul>	<p><u>\$10.30 for each one thousand dollars, or fraction thereof, of the alteration cost in excess of five thousand dollars.</u></p>		
<p><u>Permit to install or alter service equipment except plumbing and fire suppression piping service equipment.</u></p>	<p><u>Fee calculated as for respective building alteration.</u></p>	<p><u>\$100.</u></p>	
<p><u>Permit to install, alter or replace oil-burning equipment:</u></p> <ul style="list-style-type: none"> <li>□ <u>Where the storage tank exceeds two hundred seventy-five gallon capacity; or where the storage tank is less than two hundred seventy-five gallons and is to be buried, or is to be installed in a multiple dwelling or a place of assembly or in a building along the line of a subway, or is to deliver fuel oil to a burner installed above the lowest floor of a building with a primary Business Group B. occupancy.</u></li> </ul>	<p><u>\$100.</u></p>	<p><u>\$100.</u></p>	

<input type="checkbox"/> <u>In all other conditions.</u>	<u>\$50.</u>	<u>\$100.</u>	
<b><u>Other</u></b>			
<u>Permit for foundation, earthwork or open space without roof, whether enclosed or unenclosed, on sites such as parking lots, gasoline or oil-selling stations, storage yards, sales or exhibition or show spaces used for generally similar purposes.</u>	<u>\$10 for each two thousand square feet of area or fraction thereof, but not less than \$100.</u>	<u>\$100.</u>	
<u>Permit for golf driving range.</u>	<u>\$7.50 for each twenty thousand square feet of area or fraction thereof, but not less than \$100.</u>	<u>\$100.</u>	
<u>Accessory building to golf driving range, not to exceed one hundred forty-four square feet.</u>	<u>\$100.</u>	<u>\$100</u>	
<u>Permit for demolition and removal.</u>	<u>Multiply street frontage in feet or fraction thereof x number of stories of the building x \$2.60, but not less than \$260. For corner lot, use the longer street frontage.</u>	<u>\$100.</u>	
<u>Asbestos permits:</u>  <input type="checkbox"/> <u>Permit for the performance of an asbestos project for which the filing with the department of an asbestos inspection report, or proof of approval by the commissioner of environmental protection of an asbestos removal plan is required.</u>  <input type="checkbox"/> <u>Application for plan approval or permit for work for which an asbestos investigator is required to submit an asbestos</u>			<u>Specific fee to be established by the commissioner of environmental protection.</u>  <u>Terms “asbestos project,” “asbestos inspection report” and “asbestos removal plan” shall have the meanings ascribed in Section 24-146.1 of the administrative code.</u>

<u>inspection report certifying that the work to be performed will not constitute an asbestos project.</u>			
<b><u>Signs</u></b>			
<u>Permit to erect, install or alter sign: Ground sign.</u>	<u>Basic fee calculated as for building alteration; plus \$5 for each one hundred square feet of surface area, or fraction thereof; but not less than \$35.</u>	<u>\$100.</u>	<u>Each face of any sign, when fronting on different streets, shall be treated as a separate sign.</u>
<u>Permit to erect, install or alter sign: Roof sign having a tight, closed or solid surface.</u>	<u>Basic fee calculated as for building alteration; plus \$15 for each one hundred square feet of surface area, or fraction thereof; but not less than \$70.</u>	<u>\$100.</u>	<u>Each face of any sign, when fronting on different streets, shall be treated as a separate sign.</u>
<u>Permit to erect, install or alter sign: Roof sign without a tight, closed or solid surface, extending to a height of not more than thirty-one feet above roof level.</u>	<u>Basic fee calculated as for building alteration; plus \$15 for each one hundred square feet of surface area, or fraction thereof, but not less than \$100.</u>	<u>\$100.</u>	<u>Each face of any sign, when fronting on different streets, shall be treated as a separate sign.</u>
<u>Permit to erect, install or alter sign: Roof sign without a tight, closed or solid surface, extending to a height over thirty-one feet above roof level.</u>	<u>Basic fee calculated as for building alteration; plus \$25 for each one hundred square feet of area, or fraction thereof, but not less than \$135.</u>	<u>\$100.</u>	<u>Each face of any sign, when fronting on different streets, shall be treated as a separate sign.</u>
<u>Permit to erect, install or alter sign: Illuminated sign projecting beyond street line having thirty square feet or less on one side.</u>	<u>Basic fee calculated as for building alteration.</u>	<u>\$100.</u>	<u>Illuminated sign is subject to annual use fee: \$45.</u>
<u>Permit to erect, install or alter sign: Illuminated sign projecting beyond street line having more than thirty square feet but no more than fifty square feet on one side.</u>	<u>Basic fee calculated as for building alteration.</u>	<u>\$100.</u>	<u>Illuminated sign is subject to annual use fee: \$70.</u>
<u>Permit to erect, install or alter sign: Illuminated sign projecting beyond street line and having more than fifty</u>	<u>Basic fee calculated as for building alteration.</u>	<u>\$100.</u>	<u>Illuminated sign is subject to annual use fee: \$0.75 for each square foot or part thereof annually, but not less than \$100.</u>

<u>square feet on one side</u>			
<u>Maintenance permit for outdoor signs.</u>	<u>As provided by rule.</u>		
<b><u>Temporary Structures</u></b>			
<u>Permit for temporary shed, fence, railing, footbridge, catch platform, building sidewalk shanty, over-the-sidewalk chute.</u>	<u>\$130 for each permit.</u>	<u>\$100.</u>	
<u>Sidewalk shed.</u>	<u>\$130 for the first twenty-five feet or fraction thereof in the length of the shed; plus \$10 for each additional twenty-five feet or fraction thereof.</u>	<u>\$100.</u>	
<u>Permit for temporary structure other than those listed above, including but not limited to tents, grandstands, stages.</u>	<u>\$100 for the first one thousand square feet or fraction thereof; plus \$0.10 for each square foot or fraction thereof in excess of one thousand square feet.</u>	<u>\$100.</u>	
<b><u>Reinstatement of Applications/Permits</u></b>			
<u>Application/permit reinstatement fees:</u>			
<input type="checkbox"/> <u>Prior to first permit.</u>	<u>Full fee at the rate in effect on the date of reinstatement.</u>		
<input type="checkbox"/> <u>Following first permit issuance but prior to commencing work.</u>	<u>Full fee at the rate in effect on the date of reinstatement.</u>		
<input type="checkbox"/> <u>Following first permit, with work partially complete.</u>	<u>Based upon the full fee at the rate in effect on the date of reinstatement, the percentage of the fee equal to the percentage of work remaining as determined by the department inspector, plus the renewal fee.</u>		

§28-112.3 Building permit valuations. Where applicable, the applicant for a permit shall provide an



estimated job construction cost at time of application. Cost estimates shall include total value of work, including materials and labor, for which the permit is being issued, such as installation or alteration of building, gas, mechanical, plumbing equipment and permanent systems. If, in the opinion of the department, the valuation is underestimated on the application, the permit shall be denied, unless the applicant can show detailed estimates to meet the approval of the department. Final building permit valuation shall be set by the department.

§28-112.4 Work commencing before permit issuance. Any person who commences any work before obtaining the necessary permits shall be subject to a penalty as specified in this code that shall be in addition to the required permit fees.

§28-112.5 Related fees. The payment of the fee for the construction, alteration, removal or demolition for work done in connection or concurrently with the work authorized by a building permit shall not relieve the applicant or holder of the permit from the payment of other fees that are prescribed by law.

§28-112.6 Refunds and rebates. Upon application to the comptroller of the city of New York, and upon verification of claim by the commissioner, refunds or rebates of partial or full fees shall be provided as set forth in sections 28-112.6.1 through 28-112.6.3.

§28-112.6.1 Withdrawal of work permit applications. In the event that an owner withdraws an application, the owner may obtain a refund of all or a portion of the fee paid as follows:

1. If an application for construction document approval is withdrawn prior to the commencement of examination of the application all but forty dollars of the deposit fee paid shall be refunded.
2. If an application for construction document approval is withdrawn during the progress of examination of the application, the comptroller shall retain a percentage of the deposit fee paid, which the department shall certify is the equivalent percentage of the examination

completed, but not less than one hundred dollars. The remainder of the deposit fee shall be refunded to the owner.

3. If an application for construction document approval is withdrawn after examination of construction documents and/or construction document approval and before issuance of permit, there shall be refunded by the comptroller 50 percent of the total computed fee for the permit, except that not less than one hundred dollars shall be retained by the comptroller.

§28-112.6.2 Withdrawal of cranes and derricks applications. If the applicant withdraws his or her application for a certificate of approval for a power-operated crane, derrick or cableway, such applicant may obtain a refund of a portion of the fees as follows:

1. If the application is withdrawn prior to the commencement of examination by the department, the entire fee shall be refunded except one hundred dollars.
2. If the application is withdrawn after the examination has commenced, the comptroller shall retain a percentage of the fee paid, which the department shall certify is the equivalent percentage of the examination performed, but not less than one hundred dollars. The remainder of the fee shall be refunded to the applicant.
3. If the application is withdrawn after the department has performed its examination, whether or not the application has been approved no part of the fee shall be returned to the applicant.

§28-112.6.3 Incentive rebates. With respect to the rebates under this section 28-112.6, the commissioner may, at his or her discretion, issue a rebate of application fees as follows and as established by rule.

§28-112.6.3.1 Renewable energy rebates. Owners who demonstrate the production on a zoning lot of five percent or more of the annual energy consumption on the zoning lot through renewable energy sources may receive a fee rebate as established by rule.

§28-112.6.3.2 Rebate for energy use reduction. Owners who demonstrate a reduction in energy use from that allowed at the time of permit by the New York state energy conservation construction code as a result of the permitted work may receive a fee rebate as established by rule.

§28-112.6.3.3 Rebate for water conservation systems. Owners who demonstrate conservation of water taken from the city supply by providing evidence of achieving the water-recycling discount authorized by the New York city water board may receive a fee rebate as established by rule.

§28-112.6.3.4 Rebate for redevelopment, remediation and reuse of contaminated properties known as brownfields. Owners who demonstrate that their site was contaminated and has been certified as remediated by the United States environmental protection agency or the New York state department of environmental conservation, or has received a notice of satisfaction from the New York city department of environmental protection, may receive a fee rebate as established by rule.

§28-112.6.3.5 Rebate for recycling construction and demolition waste. Owners who demonstrate the recycling of construction and demolition waste may receive a fee rebate as established by rule.

§28-112.6.3.6 Rebate for bicycle storage facilities. Except for R-3 occupancy, owners who demonstrate that they have provided secured indoor bicycling facilities accessible to all building occupants may be rebated their fees as set out in rule. Such facilities shall be identified on approved plans and shall be noted on the certificate of occupancy with a statement that the bicycling accommodations dedicated to such facilities were provided in accordance with this section.

§28-112.6.3.7 Rebate for LEED or other environmental design certification. Owners who demonstrate certification of their project, which was signed off following the effective date of this code, by the United States Green Building Council based upon the Council's Leadership in Energy and Environmental Design (LEED) rating system or as otherwise provided by rule, may be rebated

their fees as set out in rule.

§28-112.6.3.8 Other rebates. The commissioner is authorized to promulgate rules to rebate fees following sign-off based upon the installation of energy-conserving systems.

§28-112.7 Inspection fees. Aside from the inspection fees covered under permit fees above, the following inspection fees shall be paid according to requirements of this code and as promulgated in rules.

§28-112.7.1 Fees for the testing, approval, inspection and use of power-operated cranes, derricks and cableways. The owner of any crane or derrick shall renew the certificate of operation each year.

**Table 28-112.7.1**

<b><u>Equipment Type</u></b>	<b><u>Initial Fee</u></b>	<b><u>Renewal Fee for Certificate of Operation</u></b>	<b><u>Comments</u></b>
<u>Prototype approval of one configuration of a mobile crane. One configuration shall be comprised of the crane with a main boom, one fixed jib and one set of counterweights.</u>	<u>\$2500 when testing has been monitored and certified by a competent individual or group, other than the manufacturer, acceptable to the commissioner;</u> <u>\$4000 when, in lieu of monitoring and certification of tests, the commissioner shall require design calculations for such items as the commissioner deems necessary to supplement the tests.</u>		<u>Additional configurations shall be subject to the same fees as the original configuration.</u>
<u>Amendment to a configuration.</u>	<u>One-half the original configuration fee.</u>		

<u>Prototype approval of a mobile crane with a hydraulic boom.</u>	<u>\$4000.</u>		
<u>Certificate of approval for mobile crane with a boom less than two hundred feet in length; fee also includes initial certificate of operation.</u>	<u>\$500.</u>	<u>\$250 annually</u> :	<u>The boom length as herein specified shall include the jibs and any other extensions to the boom.</u>
<u>Certificate of approval for mobile crane with a boom two hundred feet or more in length, but less than three hundred feet in length; fee also includes initial certificate of operation.</u>	<u>\$1000.</u>	<u>\$250 annually</u> :	<u>The boom length as herein specified shall include the jibs and any other extensions to the boom.</u>
<u>Certificate of approval for mobile crane with a boom three hundred feet or more in length but less than four hundred feet in length; fee also includes initial certificate of operation.</u>	<u>\$2000.</u>	<u>\$400 annually</u> :	<u>The boom length as herein specified shall include the jibs and any other extensions to the boom.</u>
<u>Certificate of approval for mobile crane with a boom four hundred feet or more in length; fee also includes initial certificate of operation.</u>	<u>\$3000.</u>	<u>\$400 annually</u> :	<u>The boom length as herein specified shall include the jibs and any other extensions to the boom.</u>
<u>Certificate of approval for climber and tower cranes and derricks, regardless of length; fee also includes initial certificate of operation.</u>	<u>\$3000.</u>	<u>\$400 annually</u> :	
<u>Certificate of approval for all other cranes; fee also includes initial certificate of operation.</u>	<u>\$1000.</u>	<u>\$250 annually</u> :	
<u>Certificate of approval required for a mobile crane with a boom not exceeding fifty feet in length with a maximum rated capacity not exceeding three tons; fee also includes initial certificate of operation.</u>	<u>\$300.</u>	<u>\$200 annually</u> :	<u>The boom length as herein specified shall include the jibs and any other extensions to the boom.</u>
<u>New certificate of approval, when the boom or extension thereof is replaced or altered.</u>	<u>The fee shall be the full fee required for testing a new crane or derrick with a boom or extension of the same</u>		

	<u>size and design as the replacement boom or extension thereof.</u>		
<u>Review only of engineering calculations for mobile crane with a boom exceeding 250 feet to be erected by a licensed master or special rigger, for which a certificate of on-site inspection is not required under this code or rules of the department.</u>	<u>\$100.</u>		
<u>On-site inspection of up to three models of mobile cranes with boom, including jibs and other extensions to the boom two hundred fifty feet or more in length, or derrick.</u>	<u>\$250 on normal working days; \$750 on other than normal working days, upon written request of the applicant.</u>		
<u>All other on-site inspections of cranes.</u>	<u>\$150.</u>		
<u>Amendment to an application for certificate of on-site inspection.</u>	<u>\$100.</u>		
<u>Application for waiver of on-site inspection of mobile crane or derrick.</u>	<u>\$100.</u>		

§28-112.7.2 Periodic inspection fees.

**Table 28-112.7.2**

<b><u>Inspection Type</u></b>	<b><u>Initial Fee</u></b>	<b><u>Renewal Fee</u></b>	<b><u>Comments</u></b>
<u>Filing fee for report of critical examination of exterior walls and appurtenances thereof.</u>	<u>As provided by rule.</u>		
<input type="checkbox"/> <u>Filing fee for periodic boiler inspection report.</u>	<u>\$30 for each boiler.</u>		
<u>Equipment inspection fee:</u>	<u>\$65 for each inspection, for each boiler.</u>		
<input type="checkbox"/> <u>High-pressure boiler periodically inspected as provided by section 28-116.4.</u>	<u>As provided by rule.</u>		
<input type="checkbox"/> <u>Reinspection fee following</u>			

a violation.			
□ <u>Filing fee for report of periodic inspection of elevator and other devices.</u>	<u>\$30 for each device.</u>		
□ <u>Equipment inspection fee: Each elevator or other device regulated by this code.</u>	<u>\$65 for each inspection, for each device.</u>		

§28-112.7.3 Other inspection fees.

**Table 28-112.7.3**

<u>Inspection Type</u>	<u>Initial Fee</u>	<u>Renewal Fee</u>	<u>Comments</u>
<u>Curb cut, private dwelling.</u>	<u>\$3 for each linear foot including splay.</u>		
<u>Curb cut, other.</u>	<u>\$6 for each linear foot including splay.</u>		
<u>Marquee inspection.</u>	<u>\$15 annually for each one hundred square feet or fraction thereof.</u>		
<u>Place of assembly inspection, including following a violation.</u>	<u>\$100 each inspection, each place of assembly.</u>		
<u>Search inspection of a building with a frontage of twenty-five feet or less and a depth of one hundred feet or less.</u>	<u>\$20 for each floor for the first three floors;</u> <u>\$10 for each additional floor;</u> <u>\$100 minimum total.</u>		<u>A basement or a cellar shall count as a floor.</u>
□ <u>Additional fee for building with frontage exceeding twenty-five feet.</u>	<u>Increase above fee by 40% for each floor for each additional twenty-five feet or fraction thereof.</u>		<u>Where both a basement and a cellar exist, the cellar shall not count as a floor in computing fee.</u>
□ <u>Additional fee for building with depth exceeding one hundred feet.</u>	<u>Increase above fee by 25% for each floor for each additional twenty-five feet or fraction thereof.</u>		

§28-112.8 Special fees. The department shall be entitled to charge the following special fees:

**Table 28-112.8**

<b><u>Item Description</u></b>	<b><u>Fee</u></b>	<b><u>Comments</u></b>
<u>Acknowledgement.</u>	<u>As provided by rule.</u>	
<u>Accelerated plan review.</u>	<u>In accordance with rules promulgated by the commissioner.</u>	
<u>Accelerated inspection.</u>	<u>As provided by rule.</u>	
<u>Certificate of occupancy.</u>	<u>As provided by rule.</u>	
<u>Accelerated certificate of occupancy request.</u>	<u>As provided by rule.</u>	
<u>Application for temporary certificate of occupancy.</u>	<u>\$100.</u>	<u>\$100 renewal.</u>
<u>Place of assembly certificate of operation.</u>	<u>\$100.</u>	<u>\$100 renewal.</u>
<u>Reinspection made necessary by a failure to correct a condition or respond to a request to correct that results in issuance of a violation or other order</u>	<u>As provided by rule</u>	
<u>Temporary place of assembly certificate of operation.</u>	<u>\$100.</u>	<u>\$100 renewal.</u>
<u>Temporary use letter for temporary structure.</u>	<u>\$100.</u>	
<u>Temporary use letter for place of assembly.</u>	<u>\$250.</u>	<u>Application shall be submitted at least ten work days prior to the event; late fees shall be imposed at \$100 for each day following required submission date that the application is received by the department.</u>
<u>Ordinary plumbing work.</u>	<u>\$100 for each report.</u>	
<u>Limited plumbing alteration.</u>	<u>Same as for alteration.</u>	
<u>Limited sprinkler and/or standpipe alteration.</u>	<u>Same as for alteration.</u>	
<b><u>Approval or acceptance of materials, assemblies and equipment</u></b>		
<u>Application for approval of materials</u>	<u>\$600.</u>	



<u>Application for amendment of prior approval of materials</u>	<u>\$500.</u>	
<u>Application for change of identification (change of ownership, corporate name or name of product) of prior approval.</u>	<u>\$350.</u>	
<u>Application for approval of materials Evaluated by an approved testing agency.</u>	<u>\$200.</u>	
<b><u>Other fees</u></b>		
<u>Certificate of pending violation: Multiple and private dwellings.</u>	<u>As provided by rule.</u>	
<u>Certificate of pending violation: All other buildings.</u>	<u>As provided by rule.</u>	
<u>Certified copy of license.</u>	<u>As provided by rule.</u>	
<u>Microfilming of applications for new buildings and alterations and associated documentation for certificates of occupancy, temporary certificates of occupancy and/or letters of completion, as required by rule of the commissioner.</u>	<u>As provided by rule.</u>	
<u>Preparing only or preparing and certifying a copy of a record or document filed in the department, other than a plan, certificate of occupancy or certificate of pending violation.</u>	<u>As provided by rule.</u>	
<u>Half-size print from microfilm of a plan thirty-six by forty-eight inches or less.</u>	<u>As provided by rule.</u>	
<u>Additional copies.</u>		
<u>Half-size print from microfilm of a plan exceeding thirty-six by forty-eight inches.</u>	<u>As provided by rule.</u>	
<u>Additional copies.</u>		

§28-112.9 Lien on premises for unpaid fee or other charge. Any unpaid fee or charge for an inspection, reinspection, examination or service performed by the department or other unpaid amount owed to the department, and all permits issued by the department, pursuant to law shall constitute a lien upon the land and buildings upon or in respect to which such inspection, reinspection, examination or service was performed or permit issued, as hereinafter provided.

§28-112.9.1 Filing of fees. The department shall maintain a record of all unpaid fees and other

charges. Such records shall be kept on a building by building basis and shall be accessible to the public during business hours. An entry of an unpaid amount on the records of the department shall constitute notice to all parties.

§28-112.9.2 Lien. All such unpaid amounts shall constitute a lien upon the land and building upon, or in respect to which, such inspection, reinspection, examination or service was performed or permit issued when the amount thereof shall have been definitely computed as a statement of account by the department and the department shall file such statement with the department of finance for entry in the records of such department against the premises. Such lien shall have a priority over all other liens and encumbrances except for the lien of taxes and assessments. However, no lien created pursuant to this section 28-112.9 shall be enforced against a subsequent purchaser in good faith or mortgagee in good faith unless the requirements of section 28-112.9.1 are satisfied.

§28-112.9.3 Notice. A notice, stating the amount due and the nature of the charge, shall be mailed by the department of finance, to the last known address of the person whose name appears on the records in the office of the department of finance as being the owner or agent or as the person designated by the owner to receive tax bills or, where no name appears, to the premises, addressed to either the owner or the agent.

§28-112.9.4 Interest. If such charge is not paid within 30 days from the date of entry, it shall be the duty of the department of finance to receive interest thereon at the rate of 15 percent per annum, to be calculated to the date of payment from the date of entry.

§28-112.9.5 Tax lien. Such charge and the interest thereon shall continue to be, until paid, a lien on the premises. Such lien shall be deemed a tax lien within the meaning of sections 11-319 and 11-401 of the administrative code and may be sold, enforced or foreclosed in the manner provided in chapter three or four of title eleven of such code or may be satisfied in accordance with the provisions of

section thirteen hundred fifty-four of the real property actions and proceedings law.

§28-112.9.6 Reference. The notice mailed by the department of finance pursuant to this section 28-112.9 shall have stamped or printed thereon a reference to this section 28-112.9.

§28-112.9.7 Validity not subject to challenge in enforcement proceeding. In any proceedings to enforce or discharge a lien created pursuant to this section 28-112.9 the validity of the lien shall not be subject to challenge based on:

1. The lawfulness of the inspection, reinspection, examination, service or permit; or
2. The propriety and accuracy of the fee for which a lien is claimed, except as provided in this section 28-112.9.

§28-112.9.8 Standing to challenge. No such challenge may be made except by (i) the owner of the property, or (ii) a mortgagee or lienor whose mortgage or lien would, but for the provisions of this section 28-112.9, have priority over the department's lien.

### ARTICLE 113 MATERIALS

§28-113.1 General. Materials shall be used, tested and approved for use in accordance with the specific provisions of this code and department rules, except that the commissioner shall have the power to limit or prohibit the use of any material to protect public safety. Materials shall be identified or described on construction documents and other submittal documents.

§28-113.2 Use of materials. Except as set forth in sections 28-113.2.1 through 113.2.6 materials specifically prescribed by this code or department rules may be used as prescribed without the prior approval of the commissioner.

§28-113.2.1 Approved material. Whenever this code or the rules of the department requires the use of an approved material, such material shall not be used without the prior approval of the commissioner for such use and may be used only to the extent set forth in such approval.

§28-113.2.2 Alternative materials. Except as otherwise specifically limited by this code, the provisions of this code are not intended to prevent the installation of any material or to prohibit any alternative engineered design or method of construction not specifically prescribed by this code, provided that the use of such alternative material has been previously approved by the commissioner and may be used only to the extent set forth in such approval. The use of an alternative material, design, method of construction or equipment shall be approved where the commissioner finds that the proposed design is satisfactory and complies with the intent of the provisions of this code, and that the material, method or work offered is, for the purpose intended, at least the equivalent of that prescribed in this code in quality, strength, effectiveness, fire resistance, durability and safety.

§28-113.2.3 Listed or labeled. Whenever this code or the rules of the department requires that material used be listed or labeled to a standard, material that is so listed or labeled may be used in accordance with such list or label without the prior approval of the commissioner. However, the commissioner reserves the right to require that information be submitted with regard to the testing and evaluation of any material so listed or labeled including but not limited to inspection certificates, test or evaluation reports, analysis, computations or other information used to determine that the material so listed or labeled complies with the applicable standard.

§28-113.2.4 Material not listed or labeled. Whenever this code or the rules of the department requires that material be listed or labeled to a standard and material proposed to be used is not so listed or labeled, the use of such material shall be subject to prior approval by the commissioner and such material shall be used only to the extent set forth in such approval.

§28-113.2.5 Reuse. The use of used material that meets the requirements of this code for new material is permitted unless otherwise provided in this code. Used equipment and devices shall not be reused without the prior approval of the commissioner and may be used only to the extent set forth in such

approval.

§28-113.2.6 Previously issued approvals. Materials that were previously approved by the board of standards and appeals or by the department before the effective date of this code may continue to be used, but only to the extent set forth in such approval, and only if such approval is not specifically amended or repealed by the commissioner.

§28-113.3 Approval procedure. Approval of materials shall be in accordance with the rules of the department. The cost offsets, reports and investigations required under these provisions shall be paid by the applicant.

§28-113.3.1 Performance. Specific information consisting of test reports conducted by an approved testing agency in accordance with standards referenced in the construction codes or other such information as necessary, shall be provided for the commissioner to determine whether the material will perform for the use intended.

§28-113.3.2 Research and investigation. Sufficient technical data shall be submitted to the commissioner to substantiate the proposed use of any material. If it is determined that the evidence submitted is satisfactory proof of performance for the use intended, the commissioner shall approve the use of the material subject to the requirements of this code.

§28-113.3.3 Retesting of materials. All materials tested and accepted for use shall be subject to periodic retesting as determined by the commissioner; and any material that upon retesting is found not to comply with the code requirements or the requirements set forth in the approval of such material shall cease to be acceptable for the use intended. During the period for such retesting, the commissioner may require the use of such material to be restricted or discontinued if necessary to secure safety.

§28-113.3.4 New materials. New materials not provided for in this code, and any material of

questioned suitability proposed for use in the construction of a building or structure, shall be subjected to the tests prescribed in this code or in the rules of the department to determine character, quality and limitations of use.

§28-113.3.5 Research reports. Supporting data, where necessary to assist in the approval of materials not specifically provided for in this code, shall consist of valid research reports from approved sources.

§28-113.3.6 Conflicting test results. Whenever there is evidence of conflicting results in the test of any material, the commissioner shall determine the acceptability of the material and/or the acceptable rating for such material.

§28-113.3.7 Amendment and repeal. The commissioner shall have the power to amend or repeal the approval of any material, including materials previously approved by the board of standards and appeals.

§28-113.3.8 Maintenance of records of approved material. For any material that has been approved, a record of such approval, including the conditions and limitations of the approval, shall be kept on file in the department and shall be open to public inspection at appropriate times.

§28-113.3.9 List of approved testing agencies and approved materials. A current list of all approved testing agencies and a current list of all materials specifically approved by the commissioner or previously approved by the board of standards and appeals shall be maintained by the department and published in written form.

§28-113.4 Labeling. Materials required to be labeled shall be labeled in accordance with the procedures set forth in this code or the recognized referenced standards.

§28-113.4.1 Testing. An approved agency shall test a representative sample of the material being labeled to the relevant standard or standards. The approved agency shall maintain a record of the tests

performed. The record shall provide sufficient detail to verify compliance with the test standard.

§28-113.4.2 Inspection and identification. The approved agency shall at regular intervals perform an inspection, which shall be in-plant if necessary, of the material that is to be labeled. The inspection shall verify that the labeled material is representative of the material tested.

§28-113.4.3 Label information. The label shall contain the manufacturer's or distributor's identification, model number, serial number or definitive information describing the material's performance characteristics and the approved agency's identification.

§28-113.4.4 Shipment and delivery certification of materials listed, labeled or approved. In the case of the shipment or delivery of material listed or labeled to a standard, such material shall be appropriately labeled or accompanied by the inspection certificate of an approved agency that the material is the same as that which was tested and evaluated by such agency. In the case of the shipment or delivery of material previously approved by the commissioner, the material shall be identified by a tag or certificate indicating that the material is the same that was approved for its intended use by the commissioner or, if applicable, previously approved by the board of standards and appeals, and containing the applicable approval number or calendar number under which the material received such approval.

#### ARTICLE 114 APPROVED AGENCIES

§28-114.1 General. Approved agencies shall satisfy the provisions of this article and the rules of the department as to qualifications and operations. The commissioner may revoke or suspend the commissioner's approval of or otherwise sanction an approved agency for cause.

§28-114.1.1 Independent. An approved agency shall perform its authorized duties objectively and competently. The agency shall disclose possible conflicts of interest so that objectivity can be confirmed.

§28-114.1.2 Testing equipment. An approved agency shall have adequate testing equipment to perform required tests. The equipment shall be periodically calibrated.

§28-114.1.3 Personnel. An approved agency shall employ experienced personnel qualified to conduct, supervise and evaluate the tests or inspections that it undertakes. Special inspections may be performed only by employees of such agency who are special inspectors qualified pursuant to department rules to perform or witness the particular test or inspection. The commissioner may require proof of the qualifications of employees.

§28-114.1.4 Background. The commissioner may require an approved agency to submit to an investigation of its background and of the background of its principals as a condition of approval.

§28-114.1.5 Insurance. An approved agency shall maintain liability insurance as required by department rules.

§28-114.2 Written evaluation by approved agency. An agency's evaluation of material or report of an inspection shall be in writing after satisfactory completion of the required inspection or test.

§28-114.3 Records. The approved agency shall maintain records of inspection and test reports for at least six years or for such period as the commissioner shall determine and shall make such records available to the department upon request.

§28-114.4 Re-authorization of approved agencies. An approved agency shall have its approval re-authorized in accordance with rules of the department.

#### ARTICLE 115 SPECIAL INSPECTORS

§28-115.1 General. Special inspectors shall satisfy the provisions of this article and the rules of the department as to qualifications in order to perform special inspections required by chapter 17 of the New York city building code or elsewhere in this code.

§28-115.2 Disqualification. The commissioner may disqualify a special inspector from performing



special inspections pursuant to this code for cause. The special inspector shall be given prior notice of the proposed disqualification and the opportunity to contest such action. A list of special inspectors who have been disqualified from performing special inspection shall be maintained and made available to the public upon request.

§28-115.3 Records. A special inspector shall maintain records of special inspections on a building by building basis for at least 6 years or for such period as the commissioner shall determine and shall make such records available to the department upon request.

#### ARTICLE 116 INSPECTIONS AND SIGN-OFF OF COMPLETED WORK

§28-116.1 General. Construction or work for which a permit is required shall be subject to inspection in accordance with this code and such construction or work shall remain accessible and exposed for inspection purposes until the required inspection is completed. A satisfactory inspection by the department or the acceptance by the department of a satisfactory report of an inspection by an approved agency or special inspector shall not be construed to be an approval by the department of a violation of the provisions of this code or of any other provision of law. It shall be the duty of the permit holder to cause the work to remain accessible and exposed for inspection purposes. The permit holder shall be liable for any expense entailed in the removal or replacement of any material required to allow inspection. The inspector shall supply a report of the results of each inspection.

§28-116.2 Types of inspections. The inspections set forth in sections 28-116.2.1 through 28-116.2.4 are required or authorized by this code.

§28-116.2.1 Preliminary inspection. Before approving construction documents, the commissioner is authorized to examine or cause to be examined structures or premises for which an application has been filed.

§28-116.2.2 Compliance inspections. In addition to the inspections specified in this code, the

commissioner is authorized to make or require other inspections of any construction work to ascertain compliance with the provisions of this code and other laws that are enforced by the department.

§28-116.2.3 Special inspections and other inspections required during the progress of work. After the issuance of a work permit, special inspections and other inspections required by this code to be made during the progress of the work shall be made at such times or at such stages of the work and in such manner as shall be provided by this code or as otherwise required by the commissioner. The permit application shall set forth an inspection program for the job. Such inspections may be made by approved agencies or by the department as provided in this code or in the rules of the department. Special inspections shall be performed only by individuals who are special inspectors. The commissioner may accept inspection and test reports from approved agencies and special inspectors and the work may, unless otherwise specifically provided by code provisions or directed by the commissioner, proceed without any verifying inspection or test by the department. The names and business addresses of special inspectors and approved agencies shall be set forth in the work permit application. All inspection reports shall be in writing and signed by the person or entity performing the inspection. A record of all inspections shall be kept by the person performing the inspection. The commissioner may require inspection reports to be filed with the department. Records of inspections made by approved agencies and special inspectors shall be maintained by such persons for a period of six years after sign-off of the job or for such other period of time as the commissioner may require and shall be made available to the department upon request.

§28-116.2.3.1 Special inspection of fabricated items. Where fabrication of regulated products is performed on the premises of a fabricator's shop, special inspection of the fabricated items is required. The special inspector shall verify that the fabricator maintains detailed fabrication and quality control procedures that provide a basis for inspection control of the workmanship and the

fabricator's ability to conform to approved construction documents and referenced standards. The special inspector shall review the procedures for completeness and adequacy relative to the code requirements for the fabricator's scope of work.

Exception: Special inspections shall not be required where the fabricator is approved by the commissioner in accordance with section 28-116.7.

§28-116.2.4 Final inspection. There shall be a final inspection of all permitted work. Final inspections shall comply with sections 28-116.2.4.1 through 28-116.2.4.2.

§28-116.2.4.1 Final inspection prior to certificate of occupancy. In all cases where the permitted work requires the issuance of a new or amended certificate of occupancy, the final inspection shall be performed by the department in the presence of the, permit holder, the registered design professional of record or the superintendent of construction. Such inspection shall be performed after all work authorized by the building permit is completed and before the issuance of the certificate of occupancy. All failures to comply with the provisions of this code or approved construction documents shall be noted and the owner promptly notified thereof in writing. All defects noted in such inspection shall be corrected. Reports of such final inspections shall be maintained by the department. The final inspection report shall confirm that defects noted have been corrected, that the work is in substantial compliance with the approved construction documents and with this code and with other applicable laws and rules and that all required inspections were performed.

§28-116.2.4.2 Final inspection prior to letter of completion. In all cases where the permitted work does not require the issuance of a certificate of occupancy, the final inspection shall be performed by the department or at the option of the owner by an approved agency. Whenever the department performs a final inspection, the department shall charge a fee for such inspection. The applicant

shall take all reasonable and necessary steps to insure that the final inspection is performed within one year after the expiration of the last permit. The inspection shall be performed after all work authorized by the building permit is completed. The person performing the inspection shall note all failures to comply with the provisions of this code or approved construction documents and shall promptly notify the owner in writing. All defects noted in such inspection shall be corrected. The final inspection report shall confirm that defects noted have been corrected, that the work is in substantial compliance with the approved construction documents and with this code and other applicable laws and rules and that all required inspections were performed. Final inspection reports shall be filed with and maintained by the department. Records of final inspections made by approved agencies shall be maintained by such persons for a period of six years after sign-off or for such other period as the commissioner shall require and shall be made available to the department upon request.

§28-116.3 Inspection requests. It shall be the duty of the permit holder to notify the department or the person designated to perform the inspection when work requiring inspection is ready to be inspected. It shall be the duty of the permit holder to provide access to and means for inspection of such work for any inspections that are required by this code.

§28-116.4 Sign-off of completed work. Upon submission of a satisfactory report of final inspection and all required submittal documents, the department shall document the sign-off of the project and issue a letter of completion, or, if applicable, a certificate of occupancy for the work. The owner shall take all reasonable and necessary steps for the issuance by the department of a letter of completion or certificate of occupancy within 1 year following the expiration of the last permit.

§28-116.4.1 Issuance of certificate of compliance. The following types of service equipment shall not be operated until the department issues a certificate of compliance after submission of a satisfactory

report of inspection and testing of such equipment in accordance with this code and all required submittal documents:

1. Air-conditioning and ventilation systems
2. Elevators, escalators, moving walkways and dumbwaiters
3. Fuel burning and fuel-oil storage equipment
4. Refrigeration systems
5. Heating systems
6. Boilers.

Exception: A certificate of compliance shall not be required in connection with work specifically exempted from permit requirements in accordance with this code or department rules.

§28-116.5 Payment of outstanding penalties. The department may refuse to issue a letter of completion or certificate of occupancy pending payment of all outstanding fines or civil penalties imposed for violations of this code, the 1968 building code or other laws enforced by the department at the same building.

§28-116.6 List of approved inspection agencies. A current list of all approved inspection agencies shall be maintained by the department and published in written form.

§28-116.7 Fabricator approval. Approval of fabricators by the department shall be based upon review of the fabricator's written procedural and quality control manuals and periodic auditing of fabrication practices by an approved agency.

§28-116.7.1 Fabricator's certificate of compliance. For all fabricated items, the approved fabricator shall submit a certificate of compliance to the department stating that the work was performed in accordance with the approved construction documents, referenced standards and applicable provisions of law.

ARTICLE 117  
PLACES OF ASSEMBLY

§28-117.1 Place of assembly certificate of operation. It shall be unlawful to use or occupy any building or space as a place of assembly without a certificate of operation issued by the commissioner. An application for a certificate of operation shall be made to the department in such form and containing such information as the commissioner shall provide. The department shall inspect every place of assembly space prior to the issuance of a certificate of operation. The commissioner shall not issue a certificate of operation unless the department determines that the space conforms substantially to the approved construction documents and to the provisions of this code and that the certificate of occupancy authorizes such use. A certificate of operation shall not be issued to a place of assembly providing seating or other moveable furnishings unless the commissioner approves a plan conforming to this code and the rules of the department. Seating and other moveable furnishings shall be maintained at all times during occupancy in accordance with the approved plan. Any amendment of such plan shall be subject to the prior approval of the commissioner.

§28-117.1.1 Contents of certificate of operation. The certificate of operation shall contain the place of assembly certificate number, the number of persons who may legally occupy the space and any other information that the commissioner may determine. Such certificate of operation shall be framed and mounted in a location that is conspicuously visible to a person entering the space. For the purposes of this article a place of assembly permit issued prior to the effective date of this code shall be valid until its expiration. Prior to the expiration of the term of such place of assembly permit, the party responsible for renewal shall apply to the department for a certificate of operation in accordance with this article, except that the issuance of such certificate shall be subject to the same inspection requirement as a renewal of a certificate of operation pursuant to this code.

§28-117.2 Temporary place of assembly certificate of operation. At the commissioner's discretion, a temporary certificate of operation may be issued for a place of assembly space upon request by the

applicant in accordance with this code provided that public safety is not jeopardized thereby. The applicant shall notify the fire department when a temporary place of assembly certificate of operation is issued.

§28-117.3 Duration and renewal of certificate. A place of assembly certificate of operation shall be issued for a term of 1 year and may be renewed annually upon payment of proper fees and proof of satisfactory inspection by the fire department.

#### ARTICLE 118 CERTIFICATES OF OCCUPANCY

§28-118.1 General provisions. No building or open lot shall be used or occupied without a certificate of occupancy issued by the commissioner. Issuance of a certificate of occupancy shall not be construed as an approval of a violation of the provisions of this code or of other applicable laws and rules.

§28-118.2 New buildings or open lots. No building hereafter constructed or open lot shall be occupied or used, in whole or in part, unless and until a certificate of occupancy shall have been issued certifying that such building or open lot conforms substantially to the approved construction documents and the provisions of this code and other applicable laws and rules.

§28-118.3 Completed buildings or open lots. The provisions of sections 28-118.3.1 through 28-118.3.4 shall apply to completed buildings or open lots.

§28-118.3.1 Change of occupancy or use. No building, open lot or portion thereof hereafter altered so as to change from one occupancy group to another, or from one zoning use group to another, either in whole or in part, shall be occupied or used unless and until the commissioner has issued a certificate of occupancy certifying that the alteration work for which the permit was issued has been completed substantially in accordance with the approved construction documents and the provisions of this code and other applicable laws and rules for the new occupancy or use.

§28-118.3.2 Changes inconsistent with existing certificate of occupancy. No change shall be made to

a building or open lot or portion thereof inconsistent with the last issued certificate of occupancy or, where applicable, inconsistent with the last issued certificate of completion for such building or open lot or which would bring it under some special provision of this code or other applicable laws or rules, unless and until the commissioner has issued a new certificate of occupancy.

§28-118.3.3 Changes to exits. No building hereafter altered so as to cause a major alteration to existing exits shall be occupied or used unless and until the commissioner has issued a certificate of occupancy certifying that the alteration work for which the permit was issued has been completed substantially in accordance with the approved construction documents and the provisions of this code and other applicable laws and rules.

§28-118.3.4 Existing buildings or open lots without certificates of occupancy. A building or open lot in existence prior to January 1, 1938 and heretofore legally used or occupied without a certificate of occupancy or, if applicable, a certificate of completion, and subject to the provisions of section 28-102.4 (continuation of lawful existing use), may continue to be used or occupied without a certificate of occupancy or, if applicable, a certificate of completion, pursuant to the requirements of section six hundred forty five of the New York city charter, this code and other applicable laws and rules provided there is no change in the existing use or occupancy classification of the building, open lot or portion thereof.

§28-118.3.4.1 Application for certificate of occupancy. Upon application by the owner of such a building or open lot in existence prior to January 1, 1938, the commissioner shall issue a certificate of occupancy for such building, provided that at the time of issuing such certificate, such existing building is in compliance with all retroactive requirements of the 1968 building code applicable to such building and no notices of violation or other notices or orders affecting the building as they relate to the provisions of this code or the 1968 building code are pending before



the department, and provided further that it is established to the satisfaction of the commissioner, after inspection and investigation, that the alleged use of the building has heretofore legally existed.

§28-118.3.4.2 Partial certificates of occupancy. Partial certificates of occupancy may be issued pursuant to section 28-118.16 .

§28-118.4 Applications for certificates of occupancy. All applications for certificates of occupancy shall be submitted on forms furnished by the department. Applications for new buildings or additions to buildings shall be accompanied by an accurate and complete final lot survey made by a land surveyor showing such information as prescribed by the commissioner. The commissioner may waive the requirement of such survey in the case of small sheds, stands, temporary structures, signs, and similar small structures.

§28-118.4.1 Applicant. The application for a certificate of occupancy shall be made by or on behalf of the owner of the building or open lot; and if made by a person other than the owner, the application shall be accompanied by a signed statement of the applicant stating that the applicant is authorized by the owner to make the application. The full names and addresses of the owner, and applicant, and of the principal officers thereof, if a corporation, shall be stated in the application.

§28-118.4.2 Statement of compliance. When a certificate of occupancy for a new or altered building is applied for, the application shall be accompanied by a signed statement of the registered design professional of record or the superintendent of construction, as applicable, stating that such person has examined the approved construction documents and specifications of the building for which the certificate of occupancy is sought, and that, to the best of his or her knowledge and belief, the building has been erected or altered in accordance with the approved construction documents and specifications and, as erected or altered, complies with the provisions of this code and all other

applicable laws and rules, except insofar as variations or variances therefrom have been legally permitted or authorized, specifying such variations or variances in such required statement.

§28-118.5 Review of applications for certificates of occupancy. All applications for certificates of occupancy and accompanying submittal documents shall be examined promptly after their submission. If the building is entitled to the certificate of occupancy applied for, the application shall be approved and the certificate of occupancy issued by the commissioner within 10 calendar days after submission of a complete application. Otherwise, the application shall be rejected and written notice of rejection, stating the grounds of rejection, shall be given to the applicant within 10 calendar days of the submission of the application. Wherever an application has been rejected and proof is thereafter submitted establishing that the grounds of rejection have been met and that the building is entitled to the certificate of occupancy applied for, the application shall be approved and the certificate of occupancy issued within 10 calendar days after submission of such proof.

§28-118.6 Issuance of certificate of occupancy. After the commissioner inspects the building or open lot and determines that the building or open lot conforms substantially to the approved construction documents and to the provisions of this code and other applicable laws and rules, the commissioner shall issue a certificate of occupancy that shall contain information including, but not limited to:

1. The building permit number.
2. The address of the structure.
3. Block and lot numbers pertaining to the zoning lot as of the date of issuance, as defined in section 12-10 of the New York city zoning resolution.
4. The description of the structure for which the certificate is issued.
5. A statement that the described portion of the structure has been inspected for compliance with the requirements of this code.

6. The name and signature of the commissioner.
7. The code under which the permit was issued.
8. The use and occupancy, in accordance with this code and the zoning resolution.
9. The type of construction as defined in this code.
10. The design occupant load of floors and spaces.
11. Types of major fire suppression or alarm systems.
12. Any special stipulations and conditions of the building permit.
13. The maximum permissible live loads on the several floors of the building.
14. The number of parking spaces.

§28-118.7 Pavement plan. No certificate of occupancy shall be issued for any building or open lot requiring a pavement plan pursuant to article 108 unless and until an inspection has been made to show that all work necessary for compliance with the pavement plan has been completed.

§28-118.7.1 Certification. No certificate of occupancy shall be issued for any building or open lot requiring a certification pursuant to article 108 unless and until the applicant, after completion of construction work, inspects the sidewalk and certifies that the sidewalk is free from defects.

Exception: The commissioner may issue a certificate of occupancy if in lieu of such certification the owner furnishes to the department prior to the issuance of the certificate of occupancy security satisfactory to the department that the sidewalk will be installed and paved or repaired within the time specified by the department.

§28-118.8 Sanitary/storm water drainage. No certificate of occupancy shall be issued until the department confirms by inspection that all work relating to the installation of the part of the sanitary/storm water drainage system which lies outside of such property, if and as required by section 24-526 of the administrative code, has been satisfactorily completed.

§28-118.9 Fire protection plan. No certificate of occupancy shall be issued until a fire protection plan, if required pursuant to article 109, has been filed and accepted.

§28-118.10 Electrical work. No certificate of occupancy shall be issued unless compliance with the New York city electrical code is certified by the commissioner.

§28-118.11 Certificates of compliance. No certificate of occupancy shall be issued until certificates of compliance are issued for the following types of service equipment:

1. Air conditioning and ventilation systems.
2. Elevators, escalators, moving walkways and dumbwaiters.
3. Fuel burning and fuel oil storage equipment.
4. Refrigeration systems.
5. Heating systems.
6. Boilers.

§28-118.12 Place of assembly certificate of operation. The issuance of a certificate of occupancy shall not authorize the use of any space as a place of assembly unless and until the commissioner thereafter issues a place of assembly certificate of operation.

§28-118.13 Certificates of occupancy for air-inflated structures, air-supported structures, and tents. Certificates of occupancy for air-inflated structures, air-supported structures, and tents shall be issued for a period not exceeding one year. Such certificates may be renewed for one-year periods upon demonstration that the structure complies with all laws and rules in effect at the time of the request for renewal.

§28-118.14 Payment of outstanding penalties. The department may refuse to issue a certificate of occupancy for a building pending payment of all outstanding fines or civil penalties imposed for violations of this code, the 1968 building code or other laws enforced by the department at the same

building.

§28-118.15 Temporary certificates of occupancy. Upon application, the commissioner is authorized to issue a temporary certificate of occupancy before the completion of the entire work covered by the permit, provided that the subject portion or portions of the building may be occupied and maintained in a manner that will not endanger public safety, health, or welfare. The commissioner shall set a time period during which the temporary certificate of occupancy is valid.

§28-118.16 Amended certificate of occupancy. Where a building exceeds three stories in height and the change does not exceed 20 percent of the total floor area, an amendment to the existing certificate of occupancy for such new use shall be issued by the commissioner certifying that the proposed new occupancy and use conforms to the provisions of the laws governing building construction and that the proposed use will not be in conflict with any provisions of the labor law, multiple dwelling law or the zoning resolution.

§28-118.16.1 Partial certificate of occupancy. A partial certificate of occupancy may be issued to a specific floor or floors of an existing building erected prior to January 1, 1938 subject to the following conditions:

1. The building does not have and is not otherwise required to have a certificate of occupancy or certificate of completion, if applicable.
2. The floor or floors for which a certificate of occupancy is issued shall not constitute more than 50 percent of the gross floor area of the building.
3. The building is of noncombustible construction and protected with an automatic sprinkler system.
4. Adequate means of egress are provided from all floors.
5. Upon inspection, the building is deemed safe for occupancy.

§28-118.17 Revocation of certificates of occupancy. The commissioner is authorized to request, in writing, pursuant to section six hundred forty five of the New York city charter that the board of standards and appeals or a court of competent jurisdiction revoke, vacate, or modify a certificate of occupancy issued under the provisions of this code whenever the certificate is issued in error, or on the basis of incorrect information provided to the department.

§28-118.18 Record of certificates. A record of all certificates of occupancy shall be kept by the department; and copies thereof shall be furnished by the department upon request, and on the payment of the fee prescribed in article 112 of this chapter. The certificate of occupancy or a copy thereof shall be available for inspection at the building at all reasonable times.

§28-118.19 Posting of certificates of occupancy. The owner shall post a copy of the building's certificate of occupancy in accordance with this section 28-118.19, except buildings classified in occupancy group R3. Buildings that are not required to have a certificate of occupancy shall be posted by the owner with a sign or placard in a form prescribed by the commissioner. The certificate of occupancy or sign, as applicable, shall be permanently affixed to the structure in a conspicuous location in a public hall, corridor, management office of the building or as otherwise prescribed by the commissioner.

§28-118.19.1 Replacement of posted certificates of occupancy and signs. All posted certificates of occupancy or signs, as applicable, shall not be removed or defaced and, if lost, removed or defaced, shall be immediately replaced. The commissioner may inspect or cause to be inspected periodically all buildings for compliance with the provisions of this code in regard to posting; and the inspection reports shall specify any violation thereof.

## ARTICLE 119 SERVICE UTILITIES

§28-119.1 Connection of service utilities. It shall be unlawful for any utility company or utility

corporation to supply gas to a building, place or premises in which new meters other than replacement are required until a certificate of approval of gas installation from the department is filed with such utility company or utility corporation. When new gas service piping has been installed it shall be locked-off by the utility company or utility corporation either by locking the gas service line valve or by installing a locking device on the outside gas service line valve. The lock shall not be removed until the gas meter piping (other than utility owned) and gas distribution piping have been inspected and certified as required by the department of buildings as being ready for service.

§28-119.1.1 Gas shut-off for alterations to gas piping systems. When alterations, extensions or repairs to existing gas meter piping or gas distribution piping require the shut-off of gas flow to a building, the utility company shall be notified by the owner or his or her authorized representative.

§28-119.2 Temporary connection. The commissioner shall have the authority to authorize the temporary connection of the building or system to the gas service utility.

§28-119.3 Authority to disconnect utility service. The commissioner may authorize disconnection of gas service to the building, structure or system regulated by this code and the codes referenced in case of emergency where necessary to eliminate an immediate hazard to life or property. The department shall notify the local gas utility company, and wherever possible the owner and occupant of the building, structure or service system of the decision to disconnect prior to taking such action.

## CHAPTER 2 ENFORCEMENT

### ARTICLE 201 GENERAL

§28-201.1 Unlawful acts. It shall be unlawful to erect, construct, alter, extend, repair, fail to maintain, move, remove, demolish, occupy, use or operate any building, structure, premises, or equipment, or to conduct any subject matter regulated by this code or by the zoning resolution, or to cause same to be

done, in conflict with or in violation of any of the provisions of this code, the zoning resolution, or the rules of the department or, with regard to existing buildings, any applicable provision of the 1968 building code or any other law or rule enforced by the department. It shall be unlawful to fail to comply with an order of the commissioner or to violate any order of the commissioner issued pursuant to this code, the 1968 building code, the zoning resolution or any law or rule enforced by the department.

§28-201.2 Classification of violations. The commissioner shall promulgate rules classifying all violations of this code, the zoning resolution or, with regard to existing buildings, the 1968 building code or other laws or rules enforced by the department as immediately hazardous violations, major violations or lesser violations unless the classification of such violations is specifically directed by this code. Such classification shall be based on the effect of the violation on life, health, safety or the public interest or the necessity for economic disincentive.

§28-201.2.1 Specified immediately hazardous violations. The commissioner shall classify the following violations as immediately hazardous:

1. A violation of section 28-210.1 in which a building legally approved for occupancy as a one-family or two-family dwelling (as set forth in the certificate of occupancy or if no certificate of occupancy is required, as evidenced by official records) is illegally converted to or maintained as a dwelling for occupancy by four or more families;
2. Any violation of section 28-211.1 false statement;
3. Any violation of a stop work order or of a cease use order;
4. Any violation of a vacate order or order to seal, secure and close, or closure order;
5. Unlawful demolition;
6. Falsely impersonating an employee or authorized representative of the department;
7. Occupancy without a required certificate of occupancy;



8. Intentional disobedience or violation of any provision of a closure order;

9. Submittal of a materially false or misleading professional certification.

10. A violation of section 28-212.11.

§28-201.2.2 Specified major violations. The commissioner shall classify the following violations as major violations:

1. A violation of section 28-210.1 or 28-210.2 other than a violation that is directed to be classified as immediately hazardous.

2. Failure to perform required façade, elevator and boiler inspections and to file required reports within the applicable time period.

§28-201.3 Methods of enforcement. The commissioner may use any of the methods set forth in this code to enforce compliance with this code, the 1968 building code, the zoning resolution, other laws or rules enforced by the department and orders of the commissioner issued pursuant thereto including but not limited to:

1. Proceedings for the recovery of civil penalties for immediately hazardous, major and lesser violations before the environmental control board or other administrative tribunal.

2. Civil judicial proceedings for the recovery of civil penalties or injunctive relief or both for immediately hazardous, major and lesser violations.

3. Criminal judicial proceedings for the imposition of criminal fines or imprisonment or both for immediately hazardous, major and lesser violations.

4. The issuance and enforcement of preemptory orders for immediately hazardous, major and lesser violations.

5. The issuance of a commissioner's request for correction of an unlawful use or condition or order to correct an unlawful use or condition.

6. Other special remedies as set forth in this code, the zoning resolution or other law or rule.

§28-201.3.1 Issuance. Officers and employees of the department and of other city agencies designated by the commissioner shall have the power to issue summonses, appearance tickets and notices of violation for violations of this code, the 1968 building code, the zoning resolution or other laws or rules enforced by the department, orders, and requests for corrective action.

§28-201.4 Aggravating and mitigating factors. Civil penalties and criminal fines and imprisonment shall be imposed within the ranges set forth in this code or as otherwise specified in this code or other law, with due regard for mitigating and aggravating factors.

## ARTICLE 202 CIVIL PENALTIES

§28-202.1 Civil penalties. Except as otherwise specified in this code or other law, violations of this code, the 1968 building code, the zoning resolution or other laws or rules enforced by the department shall be punishable by civil penalties within the ranges set forth below:

1. For immediately hazardous violations, a civil penalty of not less than one thousand dollars nor more than twenty-five thousand dollars may be imposed for each violation. In addition to such civil penalty, a separate additional penalty may be imposed of not more than one thousand dollars for each day that the violation is not corrected. The commissioner may by rule establish specified daily penalties within the limit set forth above for particular immediately hazardous violations.
2. For major violations, a civil penalty of not more than ten thousand dollars may be imposed for each violation. In addition to such civil penalty, a separate additional penalty may be imposed of not more than two hundred fifty dollars for each month that the violation is not corrected. The commissioner may by rule establish specified monthly penalties within the limit set forth above for particular major violations.
3. For lesser violations, a civil penalty of not more than five hundred dollars may be imposed for each

violation.

§28-202.2 Continuing violations. Notwithstanding the assessment of daily penalties, each day that a violation continues shall be a separate and distinct offense.

ARTICLE 203  
CRIMINAL PENALTIES

§28-203.1 Criminal fines and imprisonment. Except as otherwise specified in this code or other law, violations of this code, the 1968 building code, the zoning resolution or other laws or rules enforced by the department shall be punishable by criminal fines and imprisonment within the ranges set forth below:

1. Every person convicted of violating a provision of this code, the 1968 building code, the zoning resolution or other law or rule enforced by the department or an order of the commissioner issued pursuant thereto that is classified by the commissioner or the code as an immediately hazardous violation shall be guilty of a misdemeanor punishable by a fine of not more than twenty-five thousand dollars or by imprisonment of not more than one year or by both such fine and imprisonment.
2. Every person convicted of violating a provision of this code, the 1968 building code, the zoning resolution or other law or rule enforced by the department or an order of the commissioner issued pursuant thereto that is classified by the commissioner or the code as a major violation shall be guilty of a violation punishable by a fine of not more than ten thousand dollars or imprisonment for not more than 15 days or both such fine and imprisonment.
3. Every person convicted of violating a provision of this code, the zoning resolution or other law or rule enforced by the department or an order of the commissioner issued pursuant thereto that is classified by the commissioner or the code as a lesser violation shall be guilty of a violation punishable by a fine of not more than five hundred dollars.

§28-203.2 Continuing violations. In the case of continuing violations each day's continuance shall be a

separate and distinct offense.

ARTICLE 204  
ENVIRONMENTAL CONTROL BOARD

§28-204.1 General. Any person who shall violate or fail to comply with any of the provisions of this code, the 1968 building code, the zoning resolution or other laws or rules enforced by the department or with any order issued pursuant thereto shall be liable for a civil penalty that may be recovered in a proceeding before the environmental control board. Such proceeding shall be commenced by the service of a notice of violation returnable before the board. Such notice of violation may be issued by employees of the department or of other city agencies designated by the commissioner and may be served by such employees or by a licensed process server.

§28-204.2 Order to certify correction. Each such notice of violation shall contain an order of the commissioner directing the respondent to correct the condition constituting the violation and to file a certification with the department that the condition has been corrected. Unless otherwise provided by rule, such order shall require that violations classified as major or lesser be corrected within 30 days from the date of the order and that violations classified as immediately hazardous be corrected forthwith. Such order shall also require that certification of the correction of the violation shall be filed with the department in a manner and form and within such additional period of time as shall be established by rule of the department. In any proceeding before the environmental control board, no civil penalty shall be imposed for a lesser violation if the respondent complies with the commissioner's order to correct and to certify correction of the violation within the applicable time period. However, such violation may serve as a predicate for purposes of assessing aggravating factors attributable to multiple offenses.

§28-204.3 Failure of proof. In any proceeding before the environmental control board, if the board finds that the commissioner has failed to prove the violation charged, the order requiring the respondent to correct the condition constituting the violation shall be deemed dismissed.

§28-204.4 Failure to certify the correction of a violation. Failure to comply with an order of the commissioner issued pursuant to section 28-204.2 to correct and to certify correction of a violation within the applicable time period shall be a violation of this code for which penalties may be imposed in addition to the penalties that may be or have been imposed for the violation referred to in such order. Upon application, for good cause, the commissioner may extend the time for filing the certification of correction of a violation, but not for more than 30 days for each extension.

§28-204.5 False statements in certification of correction. For the purposes of this section 28-204.5, if the environmental control board finds that a certification of correction filed pursuant to section 28-204.2 contained material false statements relating to the correction of a violation, such certification of correction shall be null and void and the penalties set forth in this code for the violation may be imposed as if such false certification had not been filed with and accepted by the department. It shall be an affirmative defense that the respondent neither knew nor should have known that such statements were false,

§28-204.6 Tax lien. Enforcement of environmental control board judgments against owners for certain building code violations. Notwithstanding any provision of law to the contrary, an environmental control board judgment against an owner for a building code violation with respect to a private dwelling, a wooden-framed single room occupancy multiple dwelling, or a dwelling with a legal occupancy of three or fewer dwelling units shall constitute a tax lien on the property named in the violation with respect to which such judgment was rendered, as hereinafter provided. Such liens shall be entered and enforced as provided in this section 28-204.6.

§28-204.6.1 Record of unpaid judgments. There shall be filed in the office of the department a record of all such unpaid judgments. Such records shall be kept by tax lot and block number and shall be accessible to the public during business hours. An entry of a judgment on the records of the department shall constitute notice to all parties.

§28-204.6.2 Lien. All such unpaid judgments shall constitute a lien upon the property named in the violation with respect to which such judgment was rendered when the amount shall have been definitely computed as a statement of account by the department, and the department shall file such statement with the department of finance for entry against the property. Such lien shall have a priority over all other liens and encumbrances except for the lien of taxes and assessments. However, no lien created pursuant to this section 28-204.6 shall be enforced against a subsequent purchaser in good faith or mortgagee in good faith unless the requirements of section 28-204.6.1 are satisfied.

§28-204.6.3 Notice. A notice, stating the amount due and the nature of the charge, shall be mailed by the department of finance to the last known address of the person whose name appears on the records of the department as being the owner or agent of the property or as the person designated by the owner to receive tax bills or, where no name appears, to the property, addressed to either the “owner” or the “agent.”

§28-204.6.4 Mailing. Such notice mailed by the department of finance pursuant to this section 28-204.6.4 shall have stamped or printed thereon a reference to section 204.6.

§28-204.6.5 Failure to pay charge. If such charge is not paid within 30 days from the date of entry, it shall be the duty of the department of finance to receive interest thereon at the same rate as unpaid real property taxes, to be calculated to the date of payment from the date of entry.

§28-204.6.6 Enforcement of lien. Such charge and the interest thereon shall continue to be, until paid, a lien on the property. Any remedy or procedure available for the enforcement of tax liens against such property, including, but not limited to, any sale of a tax lien or any foreclosure of a tax lien, shall be available with respect to such tax lien. In addition, such tax lien may be satisfied in accordance with the provisions of section 1354 of the real property actions and proceedings law.

§28-204.6.7 Validity of lien. In any proceeding to enforce or discharge a lien created pursuant to this

section 28-204.6, the validity of the lien shall not be subject to challenge based on the lawfulness of the judgment, except as provided in this section 28-204.6.

§28-204.6.8 Challenge. No such challenge may be made except by the owner of the property or a mortgagee or lienor whose mortgage or lien would, but for the provisions of this section 28-204.6, have priority over the department's lien.

§28-204.6.9 Notice to mortgagees and lienors. Notwithstanding the foregoing provisions, no such judgment shall be entered and enforced as a tax lien against any property unless at the time of the issuance of the notice of violation a copy of such notice was also served on all mortgagees and lienors of record of such property by mail addressed to the recorded addresses of such mortgagees and lienors.

§28-204.6.10 Non-exclusive remedy. The procedures provided in this section 28-204.6 for the enforcement of environmental control board judgments against owners shall be in addition to any other methods provided under any other provision of law for the enforcement of such judgments.

## ARTICLE 205 CIVIL JUDICIAL PROCEEDINGS

§28-205.1 Civil judicial enforcement. The owner, lessee, person in charge, or occupant of any building, structure, premises, equipment or part thereof, where a violation of this code, the 1968 building code, the zoning resolution or of other laws or rules enforced by the department or any order issued by the commissioner shall exist or the agent, architect, builder, contractor, engineer, or any other person who commits or assists in any such violation or who maintains any building, structure, premises, equipment or part thereof where any such violation shall exist shall be subject to an action or proceeding to restrain, correct or abate such violation, or to compel compliance with such order. Upon request of the commissioner, the corporation counsel may institute judicial actions or proceedings seeking such relief. In addition to any other remedies, in any such action or proceeding the defendant or respondent shall be

subject to the payment of civil penalties as provided in this code.

§28-205.1.1 Corporation counsel. Such actions and proceedings may be instituted by the corporation counsel in the name of the city in any court of competent jurisdiction in the city and shall be given preference over pending causes therein. In such actions or proceedings, the city may apply for restraining orders, preliminary injunctions or other provisional remedies, with or without notice; and no undertakings shall be required as a condition to the granting or issuing of any such order, injunction or remedy, or by reason thereof. No court shall lose jurisdiction of any action or proceeding hereunder by reason of a plea that the title to real estate is involved if the object of the action is to recover a penalty for the violation of any of the provisions of this code.

§28-205.1.1.1 Naming the building as a defendant. The corporation counsel shall name as defendants the building, structure, or premises where the violation shall exist by describing it by block, lot number, and street address and at least one of the owners of some part of or interest in the building, structure, or premises.

§28-205.1.1.2 In rem jurisdiction over the building. In rem jurisdiction over the building, structure, or premises where the violation shall exist shall be complete by affixing the summons to the door of the building, structure, or premises and by mailing the summons by certified or registered mail, return receipt requested, to one of the owners of some part of or interest in the building, structure, or premises. Proof of service shall be filed within two days thereafter with the clerk of the court designated in the summons. Service shall be complete upon such filing.

§28-205.1.1.3 Service on other defendants. Defendants, other than the building, structure, or premises where the violation shall exist, shall be served with the summons as provided in the civil practice law and rules.

§28-205.1.2 Presumptive evidence. In any action or proceeding founded upon a claim by the



commissioner that any law or rule enforceable by the department has been violated, or that a lawful order issued by such commissioner has not been complied with, the following presumptions shall apply:

§28-205.1.2.1 Presumption of commissioner certificate. A certificate in writing by the commissioner, or his or her authorized representative, shall be presumptive evidence of any matter stated therein.

§28-205.1.2.2 Presumption of ownership. The person in whose name the real estate affected by the action is recorded in the office of the city register or the county clerk, as applicable, shall be presumed to be the owner thereof.

§28-205.1.2.3 Presumption of employment or agency. Whenever there is evidence that a person was the manager, operator, or supervisor or, in any other way, in charge of the premises, at the time the violation occurred, such evidence shall be presumptive that he or she was an agent or employee of the owner or lessee of the building, structure, or premises.

§28-205.1.3 Costs. In no case shall the department, or any officer or employee thereof, be liable for costs in any such action or proceeding; and officers and employees of the department, acting in good faith and without malice, shall be free from liability for acts done in any such action or proceeding.

§28-205.1.4 Lien. Any judgment rendered in any such action or proceeding shall be and become a lien upon the premises named in the complaint in such action or proceeding, if any, the lien to date from the time of filing a notice of pendency in the office of the clerk of the county in which the premises is located, and to have priority before any mortgage or other lien existing prior to such filing, except tax and assessment liens.

§28-205.1.5 Notice of pendency. The notice of pendency referred to in this section 28-205.1.5 may be filed at the commencement of judicial proceedings; provided the commissioner may deem such action

to be necessary. Any notice of pendency filed pursuant to the provisions of this code may be vacated and cancelled of record upon an order of a justice of the court in which such action or proceeding was instituted or is pending, or upon the consent in writing of the corporation counsel. The clerk of the county where the notice is filed is hereby directed and required to mark any such notice of pendency, and any record or docket thereof, as vacated and cancelled of record upon the presentation and filing of a certified copy of such order or consent.

ARTICLE 206  
CRIMINAL JUDICIAL PROCEEDINGS

§28-206.1 Criminal judicial enforcement. The owner, lessee, person in charge, or occupant of any building, structure, premises, equipment or part thereof, where a violation of this code, the 1968 building code, the zoning resolution or of other laws or rules enforced by the department or any order issued by the commissioner shall exist or the agent, architect, builder, contractor, engineer, or any other person who commits or knowingly assists in any such violation or who maintains any building, structure, premises, equipment or part thereof where any such violation shall exist shall be guilty of a criminal offense punishable by a fine or imprisonment or both a fine and imprisonment in accordance with this code.

§28-206.1.1 Other penalties. The criminal penalties provided by this code shall be in addition to or alternative to any civil sanctions authorized to be imposed for an unlawful use or condition cited in this code.

ARTICLE 207  
PEREMPTORY ORDERS

§28-207.1 Contents and service. Peremptory orders issued by the commissioner shall contain a description of the building, structure, premises, equipment or subject matter affected, and shall be designated by address where applicable. Such orders may be served personally or by posting at the

premises followed by regular mail, by any officer or employee of the department, or by any person authorized by the commissioner.

§28-207.2 Stop work orders. Whenever the commissioner finds that any building work is being executed in violation of the provisions of this code, the 1968 building code, the zoning resolution or of any laws or rules enforced by the department, or in a dangerous or unsafe manner, the commissioner or his or her authorized representative may issue a stop work order.

§28-207.2.1 Issuance. Upon issuance of a stop work order by the commissioner, all work shall immediately stop unless otherwise specified. Such order may require all persons to forthwith vacate the premises pursuant to the provisions of section 28-207.4 and may also require such work to be done as, in the opinion of the commissioner, may be necessary to remove any danger therefrom. The police department or other law enforcement agency or officer shall, upon the request of the commissioner, assist the department in the enforcement of this section 28-207.2. The stop work order may be given verbally or in writing to the owner, lessee or occupant of the property involved, or to the agent of any of them, or to the person or persons executing the work. A verbal order shall be followed promptly by a written order and shall include the reason for the issuance of the stop work order.

§28-207.2.2 Unlawful continuance. No person shall with knowledge or notice of a stop work order allow, authorize, promote, continue or cause to be continued any work covered by the stop work order, except such work that may be required by order of the commissioner.

§28-207.2.3 Rescission. Upon application, the commissioner shall rescind the stop work order when the condition that gave rise to its issuance has been corrected and either all civil penalties or criminal fines assessed for any violation of such order have been paid or, where a violation is pending, security for the payment of such penalties or fines has been posted in accordance with department rules, or where the stop work order was issued in error or conditions are such that it should not have been

issued. The commissioner may by rule require the payment of a fee in the amount of the expense of additional inspection and administrative expense related to such stop work order.

§28-207.3 Public nuisance. Whenever any building, structure, place or premises is or may be perilous to life or property by reason of the nature or condition of its contents, its use, the overcrowding of persons therein, defects in its construction, or deficiencies in fire alarm, fire extinguishing equipment or fire escape equipment, or by reason of any condition in violation of law or order of the commissioner, the commissioner may declare that the same, to the extent that the commissioner may specify, is a public nuisance and may order the same to be removed, sealed, abated, repaired, altered or otherwise improved.

§28-207.3.1 Rescission. Upon application, the commissioner shall rescind such order when the condition that gave rise to its issuance has been corrected or where the declaration was issued in error or conditions are such that it should not have been issued. The commissioner may by rule require the payment of a fee in the amount of the expense of additional inspection and administrative expense related to such order.

§28-207.4 Vacate order. In case any order to remedy a condition that is or may be imminently perilous, dangerous or detrimental to life, public safety or property, issued by the commissioner is not complied with, or the commissioner determines that an emergency exists requiring such action, the commissioner may order and immediately cause any building, structure, place or premises to be vacated. The vacate order may be given verbally or in writing to the owner, lessee or occupant of the property involved, or to the agent of any of them, or to the person or persons executing the work. A verbal order shall be followed promptly by a written order and shall include the reason for the issuance of the vacate order.

§28-207.4.1 Basis for vacate. Conditions for which the commissioner may issue a vacate order shall include but shall not be limited to the following conditions that create a hazard to life, public safety, or property:

1. Danger of structural failure;
2. Danger of façade failure;
3. Inadequate fire protection, detection, or suppression;
4. Inadequate egress; or
5. Improper storage of hazardous materials, combustible or toxic.

§28-207.4.2 Enforcement of vacate order. All orders issued pursuant to this section 28-207.4 shall be posted upon the premises and made available to the public. Immediately upon the posting of an order upon the premises, officers and employees of the police department, the department, and other authorized officers and employees of the city shall immediately act upon and enforce such order. The police department shall provide all reasonable assistance to the department and other authorized officers and employees necessary to carry out the provisions of this section 28-207.4. A copy of the vacate order shall be filed with the county clerk of the county in which the premises is located. Such filing shall be notice of the vacate order to any subsequent owner and such owner shall be subject to such order.

§28-207.4.3 Rescission. Upon application, the commissioner shall rescind the vacate order when the condition that gave rise to its issuance has been corrected and either all civil penalties or criminal fines assessed for any violation of such order have been paid or, where a violation is pending, security for the payment of such penalties or fines has been posted in accordance with department rules, or where the vacate order was issued in error or conditions are such that it should not have been issued. The commissioner may by rule require the payment of a fee in the amount of the expense of additional inspection and administrative expense related to such vacate order.

§28-207.5 Cease use orders for service equipment. Whenever the commissioner determines that the operation of any service equipment is or may be dangerous to life, health or safety, the commissioner may

issue a cease use order requiring such equipment to be shut down or sealed or otherwise made inoperable. Upon the issuance of such order a tag or notice shall be affixed to the device warning that the equipment is unsafe for operation. It shall be unlawful to operate such equipment or to remove or deface such tag unless and until the cease use order is rescinded by the commissioner.

§28-207.5.1 Rescission of cease use order. Upon application, the commissioner shall rescind the cease use order when the condition that gave rise to its issuance has been corrected and either all civil penalties or criminal fines assessed for any violation of such order have been paid or, where a violation is pending, security for the payment of such penalties or fines has been posted in accordance with department rules or where the cease use order was issued in error or conditions are such that it should not have been issued.. The commissioner may by rule require the payment of a fee in the amount of the expense of additional inspection and administrative expense related to such cease use order.

#### ARTICLE 208 COMMISSIONER'S REQUEST FOR CORRECTIVE ACTION

§28-208.1 Commissioner's request for corrective action. As an alternative to the issuance of an order or notice of violation, the commissioner may issue a request for corrective action to any person responsible for any claimed unlawful use or condition in any premises. Each request for corrective action shall have the commissioner's signature affixed thereto; but the commissioner may authorize any subordinate to affix such signature, including an electronic signature.

§28-208.1.1 Contents and delivery. The request for corrective action shall contain a description of the building, structure, premises, equipment or subject matter affected, shall be designated by address, where applicable, shall be sent by regular mail or upon consent by electronic means to the owner, lessee, person in charge, or occupant of the building, structure, premises, equipment or to any person responsible for the unlawful use or condition at the last known address for such person. Requests for

corrective action may be sent to a managing agent or other person specifically designated by the owner to attend to such requests on behalf of the owner. Each such request shall describe the unlawful use or condition, call upon the person addressed to correct it and to inform the department of the action taken. A time for correction or response shall be specified. A request for corrective action may be given orally, followed within a reasonable time by a writing as described in this section 28-208.1.1. A request for corrective action shall provide notice that failure to respond to such a request may result in the imposition of a fee for any subsequent inspection that results in the issuance of a notice of violation for the condition.

§28-208.1.2 Public record. The department shall keep a record, available to the public, of requests for corrective action issued pursuant to this article. The record of a request for corrective action shall be reflected as withdrawn upon submission to the department of a statement in a form prescribed by rule indicating that the use or condition has been corrected or did not exist or following an inspection by the department that confirms correction. A request for corrective action may be issued in response to a complaint or inspection.

§28-208.1.3 Other remedies not precluded. Nothing in this article shall be construed to limit the power of the commissioner to take any other action authorized by this code with respect to any unlawful use or condition including, but not limited to, the commencement of an action or proceeding in a court or before the environmental control board or other administrative tribunal or the issuance of a peremptory order or to require that the commissioner issue a request for corrective action as a prerequisite to any other enforcement action.

ARTICLE 209  
COMMISSIONER'S ORDER TO CORRECT UNLAWFUL USE OR CONDITION

§28-209.1 General. The commissioner may issue an order to the persons responsible for any unlawful use or condition in any premises directing such person to correct the unlawful use or condition. Each such

order shall have the commissioner's signature affixed thereto; but the commissioner may authorize any subordinate to affix such signature, including an electronic signature.

§28-209.2 Contents and service of order. All orders issued by the commissioner shall contain a description of the building, structure, premises, equipment or subject matter affected, and shall be designated by address where applicable. All such orders shall be served by regular mail or, upon consent, electronically. Such orders may be served by any officer or employee of the department, or by any person authorized by the commissioner. An order may be given orally, followed within a reasonable time by a written order as described in this section 28-209.2. Failure to comply with a commissioner's order within the stated time period shall be a violation of this code punishable by civil penalties or criminal fines and imprisonment as set forth in this code. Proof of compliance with a commissioner's order shall consist of certification as prescribed by the rules of the department.

#### ARTICLE 210 ILLEGAL CONVERSIONS

§28-210.1 Illegal residential conversions. It shall be unlawful, except in accordance with all requirements of this code, to convert any dwelling for occupancy by more than the legally authorized number of families or to assist, take part in, maintain or permit the maintenance of such conversion. Upon the finding of such violation and the imposition of punishment for such violation as set forth in this code the department or if applicable the environmental control board shall forward to the internal revenue service, the New York state department of taxation and finance and the New York city department of finance the name and address of the respondent or defendant, the address of the building or structure with respect to which the violation occurred and the time period during which the violation was found to have existed.

28-210.2 Illegal manufacturing conversions. Except as otherwise provided pursuant to the multiple dwelling law, it shall be unlawful, except in accordance with all requirements of this code, to convert to residential use any space legally authorized for occupancy for industrial or manufacturing use or to assist,



take part in, maintain or permit the maintenance of such conversion. Upon the finding of such violation and the imposition of punishment for such violation as set forth in this code the department, or, if applicable, the environmental control board shall forward to the internal revenue service, the New York state department of taxation and finance and the New York city department of finance the name and address of the respondent or defendant, the address of the building or structure with respect to which the violation occurred and the time period during which the violation was found to have existed.

ARTICLE 211  
FALSE STATEMENTS

§28-211.1 False statements in certificates, forms, written statements, applications, reports or certificates of correction. It shall be unlawful for any person to make a material false statement in any certificate, professional certification, form, signed statement, application, report or certification of the correction of a violation required under the provisions of this code or any rule of any agency promulgated thereunder that such person knew or should have known to be false.

§28-211.1.1 Rebuttable presumption. In any proceeding that relates to a false statement in a certification of correction of a violation filed in compliance with section 28-204.2 if an inspection made within six months after the filing of the certification finds a condition constituting a violation that is the same as the condition described in the notice of violation with respect to which such certification was filed, there shall be a rebuttable presumption that the condition described in such notice of violation continued and is the same condition found in the inspection.

§28-211.2 Falsely impersonating an officer. It shall be unlawful for any person to falsely represent himself or herself as an officer, inspector or employee of the department, or as acting under the authority of the department, or without authority to use, wear or display a shield or other insignia or emblem such as is worn by such officer, inspector or employee.

ARTICLE 212

ABATEMENT OF PUBLIC NUISANCE CAUSED BY CERTAIN ILLEGAL OCCUPANCIES

§28-212.1 Abatement of public nuisances caused by illegal commercial or manufacturing occupancy in residence districts and certain other zoning districts. Any building or part thereof or vacant land that is located in a residence zoning district and that is occupied for a use not permitted in such district in violation of the zoning resolution, without a certificate of occupancy authorizing such use, is hereby declared to be a public nuisance. Any building or part thereof or vacant land that is located in a C-1 or C-2 commercial zoning district and that is occupied for a commercial or manufacturing use indicated under use group 16, 17, or 18 as described in sections 32-25, 42-14, and 42-15 of the zoning resolution, in violation of the zoning resolution, without a certificate of occupancy authorizing such use is hereby declared to be a public nuisance.

§28-212.2 Order of closure. If a building or part thereof or vacant land in which such a nuisance occurs is not occupied primarily as a residence, the commissioner may, in addition to or as an alternative to any other remedy under any other provision of law, after notice and the opportunity for a hearing in accordance with this article, order the closing of such building or part thereof or such vacant land to the extent necessary to abate the nuisance.

§28-212.3 Notice of hearing. A notice of hearing with respect to an order of closure shall be served on the owner and mortgagee of record of such building or part thereof or such vacant land and on any person alleged to be occupying such building or part thereof or such vacant land at which the nuisance is located.

§28-212.4 Service of notice of hearing. Service may be made on the owner by delivering such notice to the owner or to an agent of the owner or to a person of suitable age and discretion at the residence or place of business of the owner or, if upon reasonable application such delivery cannot be completed, by affixing such notice in a conspicuous place at the owner's place of business or residence or by placing it under the entrance door at either of such locations or by delivering such notice to a person employed by the owner

to work at or to manage or maintain the premises at which the nuisance is located and, in all instances except personal delivery upon such owner by mailing the notice of hearing as follows:

§28-212.4.1 Mailing to owner's registered address. To the person registered with the department of housing preservation and development as the owner or agent of the premises, at the address filed with such department in compliance with article two of subchapter four of chapter two of title twenty-seven of the administrative code;

§28-212.4.2 Mailing to billing address. To the person designated as owner of the building or designated to receive real property tax or water bills for the building at the address for such person contained in one of the files compiled by the department of finance for the purpose of the assessment or collection of real property taxes and water charges or in the file compiled by the department of finance from real property transfer forms filed with the city register upon the sale or transfer of real property; or

§28-212.4.3 Mailing to recorded address. To the person in whose name the real estate affected by the order of the commissioner is recorded in the office of the city register or the county clerk as the case may be at the address set forth on the recorded instrument.

§28-212.4.4 Service on corporate owner. Service may be made on an owner that is a corporation pursuant to section 306 of the business corporation law; however, service upon a corporation shall be deemed to have been completed 45 days following service upon the secretary of state.

§28-212.4.5 Service on mortgagees. Service may be made upon mortgagees of record by mailing such notice to the mortgagees at the address set forth on the recorded instrument.

§28-212.4.6 Service on occupants. Service may be made upon an occupant by delivering such notice to the occupant or to a person employed by the occupant to work at or to manage or maintain the premises at which the nuisance is located; or by affixing such notice to the premises at which the

nuisance is located in a conspicuous place or by placing a copy under the entrance door of such premises and mailing a copy of such notice to the occupant at such premises; and in all instances except personal delivery upon such occupant, by mailing the notice of hearing to the occupant at the premises at which the nuisance is located.

§28-212.4.7 Proof of service. Proof of service pursuant to section 28-212.4.1 through 28-212.4.6 shall be filed with the commissioner.

§28-212.5 Conduct of hearing by office of administrative trials and hearings. The hearing shall be conducted by the office of administrative trials and hearings. The administrative law judge assigned to hear the matter shall submit his or her proposed findings of fact and recommended decision to the commissioner. If based on such recommended decision, proposed findings of fact, and the record of the hearing the commissioner determines that the building or part thereof or vacant land is a public nuisance, pursuant to this article, the commissioner may issue an order of closure. Such order shall not bar legally required ingress or egress for residential occupancy of parts of the building that are not subject to the order of closure.

§28-212.6 Lack of knowledge not a defense. At such hearing it shall not be a defense that the owner, occupant, lessor, lessee, mortgagee, or other person having an interest in the property lacked knowledge of or did not acquiesce or participate in the creation or continuation of the public nuisance.

§28-212.7 Closure not an act of possession. A closure ordered by the commissioner pursuant to this article shall not constitute an act of possession, ownership, or control by the city over the closed premises.

§28-212.8 Posting of order of closure. An order of closure shall be posted at the building or part thereof or vacant land that is the subject of such order, and shall be mailed to the record owner of such premises, and any record mortgagee at the address for such person set forth in the recorded instrument, and to the person designated as owner or agent of the building or designated to receive real property tax or water bills for

the building at the address for such person contained in one of the files compiled by the department of finance for the purpose of the assessment or collection of real property taxes and water charges or in the file compiled by the department of finance from real property transfer forms filed with the city register upon the sale or transfer of real property. A copy shall also be filed with county clerk or register of the county in which such premises are located. Such filing shall be notice of the order to any subsequent owner and such owner shall be subject to such order.

§28-212.9 Enforcement of order of closure. On the tenth business day after the posting of such order and upon the written directive of the commissioner, police officers and authorized employees of the department shall act upon and enforce such order by sealing, padlocking, or otherwise preventing access to the premises in a manner that will not bar legally required ingress or egress for residential occupancy of parts of the building that are not subject to the closure order.

§28-212.10 Rescission of order of closure. If at any time after the issuance of such order, the owner, mortgagee, or other person having an interest in the property provides assurance, in a form satisfactory to the commissioner, that the illegal commercial or manufacturing use of the premises has been discontinued and will not reoccur, or such owner, mortgagee, or other person establishes that the premises may be lawfully occupied for such use, the commissioner shall rescind the closure order. If such order is rescinded, the commissioner shall, upon request of such owner, mortgagee, or other person, provide a copy of such rescission, which may be filed with the county clerk or register of the county in which such premises are located. No such re-occupancy shall be permitted without a certificate of occupancy authorizing such use.

§28-212.11 Violation of closure order. It shall be unlawful for any person to use or occupy or to permit any other person to use or occupy any building or part thereof or vacant land that has been sealed, padlocked, or otherwise closed pursuant to an order of the commissioner. It shall be unlawful to mutilate

or remove a posted order of the commissioner. Intentional disobedience or violation of any provision of a closure order shall be punishable as an immediately hazardous violation.

ARTICLE 213  
PENALTY FOR WORK WITHOUT A PERMIT

§28-213.1 Department penalty for work without a permit. In addition to any penalties otherwise authorized by law pursuant to article 202 and the rules of the department, whenever any work for which a permit is required pursuant to this code has been performed without a permit, a penalty shall be imposed by the department as provided in this article.

§28-213.1.1 Penalty for work without permit on one or two-family dwelling. Where work has been performed without a permit on a one-family or two-family dwelling the penalty shall equal four times the amount of the fee payable for the permit. Where only part of the work has been performed without a permit, the penalty shall be reduced proportionately according to the amount of work still to be performed at the time a permit is issued. Notwithstanding the foregoing, no such penalty shall be less than five hundred dollars.

§28-213.1.2 Penalty for work without permit on other than one or two-family dwelling. The penalty for work without a permit on buildings other than one or two-family dwellings shall be fourteen times the amount of the fee payable for such permit. Where only part of the work has been performed without a permit, the penalty shall be reduced proportionately according to the amount of work still to be performed at the time a permit is issued. Notwithstanding the foregoing, no such penalty shall be less than five thousand dollars.

§28-213.2 Waiver. Such penalty and the permit fee shall be payable by the owner of the building on which the unpermitted work was performed. A waiver or reduction of such penalty shall be available to a subsequent *bona fide* purchaser of the premises pursuant to department rules.

§28-213.3 Payment of penalty required before issuance of permit. No permit shall be issued for work

described in this article until the penalty assessed by the department pursuant to this article has been paid.

§28-213.4 Procedure. The department shall adopt a rule setting forth a procedure for assessment of penalties pursuant to this article.

#### ARTICLE 214 ORDER TO SEAL, SECURE AND CLOSE

§28-214.1 Order to seal, secure and close. If the commissioner determines such action is necessary to the preservation of life and safety the commissioner may order a building subject to a vacate order to be sealed, secured and closed, except that the commissioner shall not order sealed, secured and closed any dwelling unit or other space lawfully used for residential purposes unless such dwelling unit or other space is sealed pursuant to the provisions of article 216.

§28-214.1.1 Definition. For the purpose of this article, “sealed” and “sealed, secured and closed” shall mean the use of any means available to render the building, structure or part thereof inaccessible, including but not limited to the use of a padlock or cinder blocks.

§28-214.1.2 Hearing. Such order to seal, secure and close shall contain notice of the opportunity for a hearing with respect to such order to determine if the order was properly issued in accordance with the provisions of this article. Such hearing shall be conducted by the commissioner, or in the commissioner’s discretion, by the office of administrative trials and hearings or the environmental control board. If the matter is referred to such office or board, the hearing officer shall submit his or her findings of fact and a recommended decision to the commissioner. The hearing shall be held within three business days after the receipt of the written request of an owner, lessor, lessee, or mortgagee for such hearing. The commissioner shall render a decision within three business days after such hearing is concluded or findings of fact and a recommendation are submitted.

§28-214.1.3 Service of seal, secure and close order. Such order issued pursuant to this article shall be

served as follows: It shall be mailed to the record owner of such premises; any record mortgagee of such premises at the address for such person as set forth in the recorded instrument; and if reasonably ascertainable, the person designated as owner's agent of the building or designated to receive real property tax or water bills for the building at the address for such person contained in one of the files compiled by the department of finance for the purpose of the assessment or collection of real property taxes and water charges or in the file compiled by the department of finance from real property transfer forms filed with the city register upon the sale or transfer of real property. A copy shall also be filed with the county clerk of the county in which such premises is located. Such filing shall be notice of the order to any subsequent owner and such owner shall be subject to such order.

§28-214.1.4 Rescission of seal, secure and close order. An order issued pursuant to this article shall not be rescinded unless the owner, lessor, lessee or mortgagee seeking such rescission provides assurance, in a form satisfactory to the commissioner, that the conditions that caused the issuance of such order have been corrected and will not reoccur. If such order is rescinded, upon the request of the owner, lessor, lessee or mortgagee, the commissioner shall provide a certified copy of such rescission, which may be filed with the county clerk of the county in which such premises is located.

§28-214.1.5 Expenses of enforcing seal, secure and close orders. The expenses attending the execution of any and all orders duly made by the department shall respectively be a several and joint personal charge against each of the owners or part owners, and each of the lessees and occupants of the building, structure, enclosure, place or premises to which such order relates, and in respect to which such expenses were incurred; and also against every person or body who was by law or contract bound to do that in regard to such building, structure, enclosure, place or premises which such order requires. Such expenses shall also be a lien on all rent and compensation due, or to become due, for the use of any building, structure, place or premises, or any part thereof, to which such order relates,



and in respect to which such expenses were incurred.

§28-214.1.6 Notice of seal, secure and close order to community. The commissioner shall give written notice of the closing of any building, structure, enclosure, place or premises pursuant to this article, and any subsequent actions taken with respect thereto, as soon as practicable, to the borough president of the borough within which the closing has occurred; the council member representing the district within which the closing has occurred; and the local community board. On January first of each year, the commissioner shall submit a report to the council, setting forth the number of closings made in the previous year, the locations of such closings, and the nature and use of the premises closed. The commissioner shall, in addition, as soon as practicable after a building, structure, enclosure, place or premises has been closed, make and publish a report of said closing in a manner calculated to quickly notify the local community in which such closing occurred. The commissioner shall also make and publish a report of any premises reopened pursuant to his or her permission under this article. Failure to comply with this section 28-214.1.6 shall not invalidate any action taken by the commissioner pursuant to this article.

§28-214.2 Access to sealed premises. The commissioner shall allow access to the premises sealed, secured and closed pursuant to this article to an owner, or a lessor, lessee or mortgagee upon the following conditions:

1. The submission of a written affirmation, satisfactory to the commissioner, that such person or persons will commence or cause to be commenced without delay all work necessary to correct the conditions stated in the vacate order or otherwise to make the premises meet all applicable laws and rules and will complete such work within a period of time and in a manner to be approved by the commissioner;
2. The submission of a written affirmation or other proof satisfactory to the commissioner describing

the steps that have been taken and will be taken in the future to ensure that the premises will be used or operated in a lawful manner and specifying such lawful use;

3. If a license, permit, certificate of operation or certificate of occupancy is necessary for such lawful use, the submission of a written affirmation or other proof, satisfactory to the commissioner, describing the steps that have been taken and will be taken in the future to ensure that such premises will be used or operated in compliance with any law requiring such license, permit, certificate of operation or certificate of occupancy; and
4. If the premises are leased and the person making the affirmations described above in items 1, 2 and 3 is not such lessee, the commissioner may also require any authorized person seeking access to submit a written affirmation or other proof that proceedings to enable such person to take actions necessary to ensure compliance with the affirmations submitted by such authorized person pursuant to items 1, 2 and 3 have been commenced.

§28-214.3 Additional penalties for harm or injury from violation of order to seal, secure and close. Notwithstanding any other law, rule, or regulation, any person, corporation, partnership, association or any other legal entity who permits a building, structure, enclosure, place or premises, or any part thereof, to be unlawfully occupied or used in contravention of an order of the commissioner pursuant to this article, or who negligently fails to prevent or prohibit such unlawful occupancy or use, shall be liable for a civil penalty of not more than one million dollars, if any other person suffers serious physical injury, as defined in section ten of the penal law, or death in the building, structure, place or premises or any part thereof subject to such order as a result of such unlawful occupancy or use. If more than one person suffers serious physical injury or death, such penalty shall be recoverable for each person suffering serious physical injury or death. Such penalty shall be recovered in a civil action brought by the corporation counsel in the name of the city in any court of competent jurisdiction. In determining the

amount of the civil penalty to be imposed the court shall consider:

1. The extent and severity of injury to persons and property caused by the violation;
2. The history of violations by the defendant at such premises, or any other premises, of laws or rules enforced by the department;
3. The degree of willfulness, recklessness, or negligence displayed by the defendant in committing the subject violation;
4. The defendant's financial resources; and
5. The defendant's good faith efforts to cure the subject violation, including efforts to obtain entry to or possession of the premises in order to do so.

§28-214.3.1 Payment by city. In the event that the family of any person seriously injured or who has died as the result of any unlawful occupancy or use described in this section 28-214.3 is unable to collect a judgment recovered in a civil action for personal injury or wrongful death against a defendant who has violated this section 28-214.3 because of the insolvency of such defendant, the city may, in its discretion, pay to such injured person or the family of such deceased person an amount, as hereinafter provided, collected from such defendant in an action relating to the same injury or death commenced by the corporation counsel against such defendant pursuant to this section 28-214.3.1.

§28-214.3.2 Limitations. Payments pursuant to section 28-214.3.1 shall be made as a matter of grace and shall be in such amounts and in accordance with such standards and procedures as shall be established by the mayor, provided, however, that any payment made pursuant to section 28-214.3.1 shall be in an amount not exceeding out-of-pocket expenses, including indebtedness reasonably incurred for medical or other services necessary as a result of the injury upon which such action is based; loss of earnings or support resulting from such injury; burial expenses not exceeding two thousand five hundred dollars of a person who died as a result of such unlawful occupancy or use

described in this section 28-214.3; and the unreimbursed cost of repair or replacement of articles of essential personal property lost, damaged or destroyed as a direct result of such unlawful occupancy or use. In no event shall the payment made to any person exceed the amount of such person's uncollected judgment for personal injury or wrongful death and in no event shall the total amount paid to any number of persons with such uncollected judgments against a single defendant exceed the actual amount collected by the city from such defendant in an action under this subdivision.

ARTICLE 215  
EMERGENCY POWERS OF THE COMMISSIONER

§28-215.1 Emergency work. Notwithstanding any other provisions of law, if the commissioner determines that a structure or any part thereof is in imminent danger of collapse and the exigency of the situation is such that any delay may cause further danger to the public safety, then the commissioner may direct the commissioner of housing preservation and development or the department of citywide administrative services, or other city agency to perform or arrange the performance of the emergency demolition of such structure or part thereof or such other work as deemed by the commissioner to make it safe.

§28-215.1.1 Lien for emergency work. The expenses of the city in performing emergency work on any structure or part of such structure pursuant to this article shall constitute a debt recoverable from the owner and a lien upon the land and any part of such structure that was not demolished. Every such lien shall have priority over all other liens and encumbrances on the premises except for the lien of taxes and assessments. Except as otherwise provided by rule of the affected agency, the agency incurring such expense shall be governed by the procedures set forth in article eight of subchapter five of the housing maintenance code with respect to the enforcement of such debt and lien against all types of structures, including those authorized to be occupied or otherwise occupied for residential, commercial, and manufacturing purposes.

§28-215.2 Stopping work and securing structures. See section 28-207.2.

§28-215.3 Vacating structures. See section 28-207.4.

§28-215.4 Violations of protective measures during construction or demolition. During the construction or demolition of a structure, the commissioner shall notify the owner of the structure affected of any failure to comply with any of the provisions of this code that concern the protection of the public and workers during construction or demolition. Unless the owner so notified proceeds immediately to comply with the orders of the commissioner, the commissioner shall have full power to correct the violation. All expenses incurred therefore shall become a lien on the property pursuant to section 28-112.9.

§28-215.5 Investigation of accidents or other emergency conditions. When necessary to conduct an investigation of any occurrence affecting building or construction safety, the commissioner may seize or impound equipment, building material, and portions of the affected building or premises for examination and testing. The police department or other authorized law enforcement agency shall cooperate with the commissioner upon request and shall provide a suitable place for the deposit of such items.

§28-215.6 Closing streets temporarily. The commissioner may, when necessary for the public safety, temporarily close the sidewalks, streets, structures or places adjacent to a structure or part thereof, and the police commissioner, or any of his or her subordinates shall enforce all orders or requirements made by the commissioner, when so requested by the commissioner.

§28-215.7 Recovery of bodies from wrecked structures. Where any persons are known or believed to be buried under the ruins of any fallen structure or part thereof in the city, the commissioner shall cause an examination of the premises to be made for the recovery of the injured and bodies of the dead. Whenever, in making such examination, it shall be necessary to remove any debris from the premises, other city agencies shall cooperate with the commissioner in carrying out the purposes of this section 28-215.7, and shall provide suitable and convenient places for the deposit of such debris.

§28-215.8 Non-compliance with orders; execution of work by department. Upon the failure to comply with any order of the commissioner within the time limited thereby, and subject to the provisions of article 216, any work required to be executed by such order may be executed by the commissioner through the officers, agents or contractors of the department; and the city shall be reimbursed promptly for all costs and expenses of such work. Such costs and expenses shall become a lien upon the premises involved and named in the commissioner's order, which may be enforced in accordance with the provisions of section 28-112.9 of this code.

ARTICLE 216  
UNSAFE BUILDINGS

§28-216.1 Conditions constituting an unsafe building or structure. Any building, structure or part thereof described in this article shall be deemed an unsafe building and shall be demolished or removed or made safe and secure as provided herein.

§28-216.1.1 Compromised structures. Any structure or premises or part of a structure or premises that from any cause may at any time become dangerous or unsafe, structurally or as a fire hazard, or dangerous or detrimental to human life, health or safety, shall be demolished and removed or made safe and secure.

§28-216.1.2 Vacant buildings. Any vacant building not continuously guarded or not sealed and kept secure against unauthorized entry shall have all openings sealed in a manner approved by the commissioner, and it shall be the duty of the owner thereof promptly to make any repairs that may be necessary for the purpose of keeping such building sealed and secure.

§28-216.2 Record and notice of unsafe building, structure or premises. The department shall cause a report to be filed on an unsafe building, structure or premises. The report shall describe the nature of the occupancy of the structure and the nature of the unsafe condition and be made a record of the department.

§28-216.3 Notice and order. The owner, executor, administrator, mortgagee, lessee or any other person

who may have a recorded vested or recorded contingent interest in the unsafe building, structure or premises, shall be served with a notice containing a description of the unsafe building, structure or premises and an order requiring such building be vacated pursuant to 28-207.4, if necessary, and sealed, secured, repaired, shored, or demolished and removed as may be deemed necessary by the department.

§28-216.3.1 Content. Such notice shall require the person thus served immediately to certify to the department his or her acceptance or rejection of the order. The notice shall further notify said person(s) that upon his or her refusal or neglect to comply with any of the requirements of this provision, a survey of the building or premises named in such notice will be made at a time and place therein named. The notice shall also state that if, pursuant to the survey, it is found that the building, structure, or premises referred to therein is unsafe or dangerous by the surveyors, their report of survey will be placed before the supreme court for trial at a time and place named in such notice.

§28-216.4 Method of service. The notice and order shall be served in accordance with the civil practice law and rules of the state of New York.

§28-216.5 Owner abatement of unsafe or dangerous conditions. If the person served with a notice and order pursuant to section 28-216.4 shall immediately certify his or her assent to the securing or removal of such unsafe building, structure or premises condition, such person shall be allowed a period of time as determined by the commissioner, or his or her designee, within which to commence and complete the abatement of the unsafe or dangerous condition. Such person shall employ sufficient labor and assistance to secure or remove such conditions as expeditiously as possible.

§28-216.6 Survey. A survey of the building or premises shall be conducted as follows:

§28-216.6.1 Identity of surveyors. The survey shall be made by three competent persons, of whom one shall be the commissioner or his or her designee; another shall be a registered design professional appointed by a recognized professional organization; and the third shall be a registered design

professional appointed by the person served with a notice pursuant to section 28-216.4. If the person served with such notice shall neglect or refuse to appoint such surveyor, the other two surveyors shall make the survey. In case they disagree, they shall appoint a third person to take part in such survey, who shall be a registered design professional of at least 10 years' practice, whose decision shall be final.

§28-216.6.2 Posting report of survey. A copy of the report of the survey shall be posted on the structure that is the subject thereof by the persons holding the survey, immediately on their issuing such report.

§28-216.6.3 Compensation of surveyors. The registered design professional appointed by the respective professional organization, as hereinbefore provided, who may act on any survey called in accordance with the provisions of this section 28-216.6, and the third surveyor who may have been called in the case of disagreement provided for in this section 28-216.6, shall each be paid a sum to be determined by rule to be promulgated by the department.

§28-216.6.4 Cost of survey. Any costs incurred by the city in connection with the survey shall become money due and owing to the city as part of the return of precept and judgment provided for in section 28-216.9 and 28-216.10 of this code or pursuant to lien provided for in section 28-112.9 of this code.

§28-216.7 Court proceeding. Whenever the report of survey shall recite that the building, structure or premises surveyed is unsafe or dangerous, the corporation counsel or his or her designee shall, at the time specified in the notice, place such notice and report before a justice of the court named in the notice. The report of survey shall be in writing and constitute the issues to be placed before the court for trial. The purpose of the trial shall be to determine whether the unsafe building, structure, or premises shall be vacated and sealed, secured, shored, or demolished and removed.



§28-216.7.1 Precedence of proceeding. The unsafe building proceeding shall have precedence over every other business of such supreme court. The trial on the issues in the unsafe building proceeding shall be held without delay, at the time specified in the notice, and shall be held by a justice of the court or by a referee, whose decision or report in the matter shall be final.

§28-216.7.2 Precept to abate. If the justice or referee determines the building, structure or premises that is the subject of the report of survey is unsafe or dangerous, such justice or referee trying the case shall immediately issue a precept directed to the commissioner authorizing the commissioner forthwith to vacate pursuant to section 28-207.4, if necessary, and to seal, secure, shore, or demolish and remove the unsafe building, structure or premises named in such report. The precept shall be effective for a period of three years from the date of issuance.

§28-216.7.3 Notice of pendency. A notice of pendency shall be filed in accordance with the following procedure:

1. The notice of pendency shall consist of a copy of the notice described in section 28-216.3 and shall be filed in the office of the clerk of the county where the property affected by such action, suit or proceeding is located. Such notice of pendency may be filed at any time after the service of the notice described in section 28-216.3.
2. Any notice of pendency filed pursuant to the provisions of this section 28-216.7.3 that has not expired may be vacated and cancelled of record upon an order of a justice of the court in which such suit or proceeding was instituted or is pending, or upon the consent in writing of the corporation counsel. The clerk of the county where the notice is filed is hereby directed and required to mark any such notice of pendency, and any record or docket thereof, as vacated and cancelled of record upon the presentation and filing of a certified copy of such order or consent.

§28-216.8 Execution of precept. A precept issued pursuant to section 28-216.7.2 shall be executed in accordance with the procedure set forth in sections 28-216.8.1 through 28-216.8.3.

§28-216.8.1 Work by the department. Upon receiving a precept under the provisions of section 28-216.7.2, the commissioner shall execute such precept, as therein directed, and may employ such labor and assistance and furnish such materials as may be necessary for that purpose. The commissioner or his or her designee shall direct the commissioner of citywide administrative services or the department of housing preservation and development or other authorized agency to perform work in accordance with the precept. Such work shall be performed by or under the direction of citywide administrative services in accordance with the provisions of section 4-204 of the administrative code, or the department of housing preservation and development, or such other authorized agency.

§28-216.8.2 Owner application to perform work. The owner of such unsafe building, structure, or premises, or any party interested therein, if such person applies to the commissioner immediately upon the issuing of such precept, shall be allowed to perform the requirements of such precept at his or her own cost and expense, if the performance shall be done immediately and in accordance with the requirements of such precept and other applicable laws and rules and such other requirements as the commissioner shall impose.

§28-216.8.3 Modification of precept. The commissioner or his or her designee shall have authority to modify the requirements of any precept when such commissioner or designee shall be satisfied that such change will secure the safety of such structure or premises equally well.

§28-216.8.3.1 Upon application. The commissioner shall also have authority to modify the requirements of any precept upon application to such commissioner in writing by the owner of the unsafe building, structure, or premises, or such owner's authorized representative. In addition, upon application to modify the requirements of any precept to seal or shore the structure by the

commissioner of housing preservation and development, citywide administrative services or such other authorized agency, the commissioner or designee shall have authority to modify such precept accordingly when the commissioner shall be satisfied that such change will secure the safety of such structure or premises equally well.

§28-216.8.3.2 Notice. After a determination to modify the precept is made by the commissioner, written notice of such determination shall be sent by regular mail to the owner and applicant for the modification if other than the owner, at his or her last known address.

§28-216.8.3.3 Failure of owner to perform work. If no action in accordance with the modified precept is undertaken by the owner or applicant for modification within the time period provided in the modification following the granting of such application, the commissioner may direct the department of housing preservation and development or the department of citywide administrative services or such other authorized agency to execute the original precept, provided however that prior to such execution, notice shall be provided by regular mail to the owner of the unsafe building, structure or premises and applicant for the modification if other than the owner, at his or her last known address. The owner shall continue to have the right to request the commissioner to modify the requirements of the precept prior to the execution thereof.

§28-216.8.4 Interference prohibited. It shall be unlawful for any person to interfere, obstruct or hinder the commissioner or the commissioner of citywide administrative services, housing preservation and development, or other authorized agency, or any person who, acting under the authority conferred on such person by such commissioner, in performing the work authorized by a precept issued out of any court or modified in accordance with §28-216.8.3, or the work ordered by the commissioner in accordance with such precept under the provisions of section 28-216.8.3.3.

§28-216.8.5 Enforcement. The police commissioner shall enforce such orders or requirements when

requested by the commissioner and shall likewise enforce same at the request of the commissioner of citywide administrative services, housing preservation and development, or other authorized agency, with respect to work performed by or under the direction of such commissioner pursuant to the provisions of section 28-216.8.3.3.

§28-216.9 Return of precept and reimbursement of city. Upon compliance with any precept issued to the commissioner in a proceeding under this article, the commissioner may make return thereof, with an endorsement of the action thereunder and the costs and expenses thereby incurred, to the justice of the court from which such precept issued. Such justice shall then tax and adjust the amount endorsed upon such precept, and shall adjust and allow the disbursements of the proceeding, including but not limited to the preliminary expenses of searches, service of the notice of survey and summons on interested parties, surveys thereof, and costs of executing the precept, which shall be inserted in the judgment in such proceeding. Such justice shall then render judgment for such amount and for the sale of the premises named in such notice, together with all the right, title and interest that the person named in such notice had in the lot, ground or land upon which such structure was placed, at the time of the filing of a notice of pendency in such proceedings, or at the time of the entry of judgment therein, to satisfy such judgment in foreclosure of mortgages. Nothing in this article shall preclude the city from recovering such costs and expenses in any other lawful manner, including pursuant to section 28-112.9 of this code.

§28-216.10 Judgment lien. Any judgment rendered in an action or proceeding instituted under this article shall be and become a lien upon the premises named in such action or proceeding, such lien to date from the time of filing a notice of pendency in the office of the clerk of the county wherein the property affected by such action or proceeding, is located. Every such lien shall have priority before any mortgage or other lien as may exist prior to such filing except tax and assessment liens.

§28-216.11 Tax lien. Any costs and expenses incurred by any agency of the city pursuant to this article,

including but not limited to the preliminary expenses of searches, service of the notice of survey and summons on interested parties, surveys thereof, and costs of executing the precept, shall be a debt recoverable from the owner of the premises and a lien upon the land and buildings upon or in respect to which such costs and expenses were incurred. Every such lien shall have priority over all other liens and encumbrances on the premises except for the lien of taxes and assessments. Except as otherwise provided by rule of the affected agency, the agency incurring such expense shall be governed by the procedures set forth in article eight of subchapter five of the housing maintenance code with respect to the enforcement of such debt and lien.

CHAPTER 3  
MAINTENANCE OF BUILDINGS

ARTICLE 301  
GENERAL

§28-301.1 Owner's responsibilities. All buildings and all parts thereof and all other structures shall be maintained in a safe condition. All service equipment, means of egress, materials, devices, and safeguards that are required in a building by the provisions of this code, the 1968 building code or other applicable laws or rules, or that were required by law when the building was erected, altered, or repaired, shall be maintained in good working condition. Whenever persons engaged in building operations have reason to believe in the course of such operations that any building or other structure is dangerous or unsafe, such person shall forthwith report such belief in writing to the department. The owner shall be responsible at all times to maintain the building and its facilities and all other structures regulated by this code in a safe and code-compliant manner and shall comply with the inspection and maintenance requirements of this chapter.

ARTICLE 302  
MAINTENANCE OF EXTERIOR WALLS

§28-302.1 General. A building's exterior walls and appurtenances thereof shall be maintained in a safe

condition. All buildings greater than six stories shall comply with the maintenance requirement of this article.

Exception: The requirements imposed by this article shall not apply to any part of an exterior wall that is less than 12 inches (305 mm) from the exterior wall of an adjacent building.

§28-302.2 Inspection requirements. A critical examination of a building's exterior walls and appurtenances thereof shall be conducted at periodic intervals as set forth by rule of the commissioner, but such examination shall be conducted at least once every five years. The commissioner may establish staggered inspection cycles for buildings required to comply with this article. The initial examination for a new building shall be conducted in the fifth year following the erection or installation of any exterior wall and/or appurtenances as evidenced by the issuance date of a temporary or final certificate of occupancy or as otherwise prescribed by rule.

1. Such examination shall be conducted on behalf of the building owner by or under the direct supervision of a registered design professional with appropriate qualifications as prescribed by the department.
2. Such examination shall include a complete review of the most recently prepared report and an inspection.
3. Such examination shall be conducted in accordance with rules promulgated by the commissioner.

§28-302.3 Immediate notice of unsafe condition. Whenever a registered design professional learns of an unsafe condition through a critical examination of a building's exterior walls and appurtenances thereof, such person shall notify the owner and the department immediately in writing of such condition.

§28-302.4 Report of critical examination. The registered design professional shall submit a written report to the commissioner within 60 days of completing the critical examination, but not more than five years following submission of the preceding report of critical examination, certifying the results of such critical examination as either safe, unsafe or safe with a repair and maintenance program. The report shall clearly

document the condition of the exterior walls and appurtenances thereof and shall include a record of all significant deterioration, unsafe conditions and movement observed as well as a statement concerning the watertightness of the exterior surfaces. Such report must be professionally certified by such registered design professional.

§28-302.5 Repair of exterior walls, unsafe condition. Upon the notification to the department of an unsafe condition, the owner, the owner's agent or the person in charge shall immediately commence such repairs, reinforcements or other measures as may be required to secure public safety and to make the building's exterior walls or appurtenances thereof conform to the provisions of this code.

1. All unsafe conditions shall be corrected within 30 days of filing the critical examination report.
2. The registered design professional shall reinspect the premises and file an amended report within two weeks after the repairs have been completed certifying that the unsafe conditions of the building have been corrected.
3. The commissioner may grant an extension of time of up to 90 days to complete the repairs required to correct an unsafe condition upon receipt and review of an initial extension application submitted by the registered design professional together with such additional documentation as may be prescribed by rule.
4. The commissioner may grant further extensions of time to complete the repairs required to remove an unsafe condition upon receipt and review of an application for a further extension submitted by the registered design professional together with such further documentation as may be prescribed by rule.

§28-302.6 Safe condition with a repair and maintenance program. The registered design professional shall not file a report of a safe condition with a repair and maintenance program for the same building for two consecutive filing periods unless the second such report is accompanied by his or her professional

certification attesting to the correction of all conditions identified in the prior report as requiring repair.

ARTICLE 303  
PERIODIC BOILER INSPECTIONS

§28-303.1 General. Periodic boiler inspections shall be performed in accordance with this article.

§28-303.2 Annual inspection. Except as otherwise provided in this article, all boilers as defined in section 204 of the New York state labor law, excepting those boilers listed in subdivision five of such section of such labor law, shall be inspected at least once a year by a qualified department boiler inspector or an approved agency. Such inspections shall also include the chimney connectors. All individuals who perform periodic inspections pursuant to this article shall be qualified under section 204 of the New York state labor law and the rules promulgated by the commissioner of labor or the commissioner of buildings.

§28-303.2.1 Internal inspection required. When the construction of the boiler allows, an internal inspection shall also be performed.

§28-303.3 Inspection of high-pressure boilers. Each owner of a high-pressure boiler, as defined in this code, may choose to have the annual boiler inspection conducted by the department or by a qualified boiler inspector in the employ of a duly authorized insurance company.

§28-303.4 Staggered inspection cycles. The commissioner may by rule establish staggered inspection cycles for buildings required to comply with this article.

§28-303.5 Repair of defects. The owner of each boiler that is subject to periodic inspection shall correct any defects identified in the annual boiler inspection.

§28-303.6 Owner's annual statement. The owner of each boiler that is subject to periodic inspection shall file an annual written statement with the commissioner including:

1. The location of each boiler.
2. Whether the owner, agent, or lessee has had the boiler inspected by a qualified boiler inspector in the employ of a duly authorized insurance company or other qualified inspector in accordance



with the requirements of this article, setting forth the name and address of the insurance company or other qualified inspector, the date of inspection, and the policy number covering the boiler.

§28-303.7 Report of inspection. A signed copy of the report of each boiler inspection shall be filed with the owner's annual statement, on such forms and in such manner as required by the commissioner. The report shall include a certification that identified defects have been corrected. The statement shall be filed within 30 days after installation of a boiler. Thereafter, it shall be filed as set forth in this article and in rules.

§28-303.8 Removal or discontinuance notice. The owner of a boiler that is removed or discontinued from use shall file a written notice of such removal or discontinuance with the commissioner within 30 days of the date of removal or discontinuance.

§28-303.9 Additional inspections. In addition to the inspections required by this article, the commissioner may make such additional inspections as required to enforce the provisions of this code.

§28-303.10 Fees. Every owner of a boiler in use and inspected by a qualified boiler inspector in the employ of a duly authorized insurance company shall pay to the department an annual fee for each boiler in the amount prescribed by this code to cover the city's administrative and supervisory costs. The fee shall be payable at the time of the filing of the owner's annual statement. No fee shall be charged for additional inspections made by the department pursuant to section 28-303.9.

#### ARTICLE 304 PERIODIC INSPECTION OF ELEVATORS

§28-304.1 General. Every new and existing elevator or conveying system shall be inspected and tested in accordance with the schedule set forth in this article.

§28-304.2 Elevators, escalators, moving walkways and dumbwaiters. Elevators, escalators, moving walkways and dumbwaiters shall be inspected and tested in accordance with the schedule set forth in Table N1 of ASME 17.1 as referenced in chapter 35 and as may be modified in chapter 30 and appendix

K of the New York city building code.

Exception: Elevators located in owner-occupied one-family, two-family or multiple-family dwellings that service only the owner-occupied dwelling unit and that are not occupied by boarders, roomers or lodgers, and elevators located within convents and rectories that are not open to non-occupants on a regular basis are not subject to periodic test requirement of such reference standard.

§28-304.3 Chair lifts and stairway chair lifts. Chair lifts and stairway chair lifts shall be inspected and tested at intervals not exceeding one year.

§28-304.4 Amusement devices. Amusement devices shall be inspected and tested at intervals not exceeding six months except that for seasonally operated amusement devices, the commissioner may extend the periodic inspection and test for an additional two months.

§28-304.5 Frequency of inspection and testing. Elevators and other conveying systems may be subject to more frequent inspection and testing as the commissioner finds necessary to protect public safety.

§28-304.6 Inspection and testing process. All devices shall be inspected and tested in accordance with sections 28-304.6.1 through 28-304.6.6

§28-304.6.1 Inspection and testing entities. The required periodic inspections shall be made by the department, except that one inspection and test for elevators and escalators shall be made between January first and December thirty-first of each year on behalf of the owner by an approved agency in accordance with this code and with rules promulgated by the commissioner. Required inspections and tests performed on behalf of the owner shall be performed by an approved agency in accordance with rules of the department and witnessed by an approved agency not affiliated with the one performing the test. The department shall be notified at least 10 days prior to the owner's periodic inspection and testing pursuant to rule of the department.

§28-304.6.2 Scope. During periodic inspection and testing, in addition to any other requirements prescribed by this code, all parts of the equipment shall be inspected to determine that they are in safe operating condition and that parts subject to wear have not worn to such an extent as to affect the safe and reliable operation of the installation.

§28-304.6.3 Reporting an unsafe or hazardous condition. If an inspection reveals that any elevator or other conveying system is unsafe or hazardous to life and safety, the device is to be taken out of service immediately by the agency performing the inspection and the building owner notified immediately. The department shall be notified by telephone or fax within 24 hours.

§28-304.6.4 Notation of inspection or test. After each inspection or test, the inspector shall affix the inspection date and his or her signature over a stamp identifying his or her approved agency and his or her approval number on the inspection certificate issued by the department.

§28-304.6.5 Inspection and test reports submission. Inspection and test reports shall be submitted on such forms and in such manner as required by the commissioner. Copies of each report (each copy originally signed by the inspector performing the inspection and test and by the inspector witnessing the inspection and test, the agency director, and the building owner) listing all violations of any of the provisions of this code for each device inspected and/or tested, shall be delivered to the owner within 30 calendar days of the inspection or test and filed with the department within 45 calendar days of the inspection or test.

§28-304.6.6 Repair. All defects as found and reported in such inspection and test reports shall be corrected within 45 days of the filing of the report, except all hazardous conditions shall be corrected immediately.

§28-304.7 Required contract. The owner of all new and existing passenger elevators shall have a contract with an approved agency to perform elevator repair work and maintenance as defined by ASME 17.1. The

name, address and telephone number of such agency shall be maintained at each premises, on the mainline disconnect switch and in a location readily accessible to employees of the department and to maintenance and custodial staff at the premises.

§28-304.8 Fees. Every owner of elevators and other devices shall pay to the department an inspection fee and a report filing fee for each elevator or device in the amount prescribed by this code.

§28-304.9 Additional inspections. The commissioner may make such additional inspections as required to enforce the provisions of this code. No fee shall be charged for such additional inspections.

### ARTICLE 305 RETAINING WALLS

§28-305.1 Retaining walls, partition fences and other site structures. In addition to the requirements set forth in chapter 33 of the New York city building code, the responsibility for maintaining and repairing retaining walls, partition fences and other site structures shall be in accordance with sections 28-305.1.1 and 305.1.2.

§28-305.1.1 Structures located on the lot line of adjacent properties and partially on both properties. The owners of adjacent properties shall be responsible jointly for the proper maintenance and repair of retaining walls, partition fences and other site structures, or portions thereof, that are located along the common lot line and on both their properties; and each such owner shall be responsible for one-half of the costs of maintaining and repairing such fences, retaining walls and other site structures, or such portions thereof. Where an owner elects to remove temporarily a retaining wall or partition fence that is required to support a grade differential between the two properties, or for any other reason is required by this code, such owner shall protect the adjacent property, shall not impair its safe use, and shall replace the retaining wall or partition fence at his or her own cost.

§28-305.1.2 Structures located entirely on one property. Where such retaining walls, partition fences or other site structures, or portions thereof, are located entirely on one property, the owner of such property

shall be wholly responsible for the proper maintenance and repair of the retaining wall, partition fence or other site structure. If, however, the proper maintenance and/or repair of such retaining wall, partition fence or other site structures requires access to the adjoining property, the owner of such adjoining property shall allow such access.

§28-305.2 Retaining walls required. Hereafter, when an owner elects to set his or her grade either higher or lower than the grade of an adjoining property at the property line, such owner shall erect, maintain and repair a retaining wall of sufficient height, structure and foundation to support such grade differential, and with proper drainage, in accordance with this code, such that the adjacent property is not impacted, and shall do so at the sole expense of such owner and entirely on the property of such owner without access to the adjoining property.

§28-305.3 Special agreement. Nothing in this article shall be construed to prevent the owners of adjacent properties from making or enforcing by private action special agreements with respect to maintenance or repair of retaining walls, partition fences and other site structures or access to adjoining property for such purpose.

ARTICLE 306  
PARTY WALLS

§28-306.1 Responsibility for party walls. Repair and maintenance of the construction, design and fire-resistance rating of party walls shall be the joint responsibility of the owners of the adjoining properties, and any change by either owner must maintain the weather protection, structural, vertical fire division and other requirements of this code for party walls.

CHAPTER 4  
LICENSING AND REGISTRATION OF BUSINESSES, TRADES AND OCCUPATIONS  
ENGAGED IN BUILDING WORK

ARTICLE 401  
GENERAL

§28-401.1 Application. This chapter shall apply to the licensing and registration of businesses, trades and occupations engaged in building work regulated by this code.

§28-401.2 General requirements for all licenses. The provisions of this article shall apply to all licenses issued by the department pursuant to this chapter. All applicants and licensees shall comply with the provisions of this article as well as the specific requirements applicable to the particular license as set forth in other articles of this chapter.

§28-401.3 Definitions. As used in this chapter the following terms shall have the following meanings unless the context or subject matter requires otherwise.

CERTIFICATE OF COMPETENCE. A certificate issued by the department to an individual representing that such individual has completed all requirements for the master plumber or master fire suppression piping contractor license but has not obtained a seal or plate; and that such certificate of competence has been renewed as required and is currently in effect. The certificate of competence shall bear the name of the holder and the certificate number. The holder of a certificate of competence is not a licensed master plumber or licensed master fire suppression piping contractor and may practice the trade for which the certificate is issued only under the direct and continuing supervision of a licensed master plumber or licensed master fire suppression piping contractor or, with respect to a city employee under the direct and continuing supervision of a supervising licensed master plumber or licensed master fire suppression piping contractor.

CITY AGENCY. A city, county, borough, or other office, position, administration, department, division, bureau, board or commission, or a corporation, institution or agency of government, the expenses of which are paid, in whole or in part, from the city treasury.

COMBINED STANDPIPE SYSTEM. A standpipe to which a sprinkler system is connected or is being connected.

DIRECT AND CONTINUING SUPERVISION. Responsible control exercised by a licensed individual, either personally or through one or more, but no more than three, levels of competent supervision over individuals (i) in the direct employ of the licensee, or (ii) in the direct employ of the city agency employing the licensee or (iii) in the direct employ of the business performing the actual work of the licensee's trade or the actual work permitted by the class of license held by the licensee, for which work such licensee assumes full responsibility. Such control shall be evidenced by such licensee's signature, and seal where applicable, upon any required statements, applications and/or permits and by demonstrating involvement of the licensee in the operations of the business, including hiring of employees, responsibility for financial matters, and oversight of work performance. Direct and continuing supervision includes field inspection, supervision of job sites, and the maintenance of records of such supervision and such other requirements as the commissioner may prescribe by rule for a particular license type.

DIRECT EMPLOY. An individual is in the direct employ of a licensee or business or a city agency when such individual is on the payroll of such licensee or business or city agency and under the usual common law rules applicable in determining the employer-employee relationship has the status of an employee. The work performed by such employee shall not exceed the class of license held by the licensee. Direct employment shall be evidenced by payroll records, such as social security payments, income tax withholding or the disbursement of other funds as required by law for the benefit of such employee, timekeeping records, such as time cards and sign-in sheets, work orders, and assignment or route logs.

FIRE SUPPRESSION PIPING WORK. The installation, maintenance, repair, modification, extension, or alteration or testing of a fire suppression piping system in any building in the city of New York.

FIRE SUPPRESSION PIPING SYSTEM. Any system including any and all equipment and materials in connection therewith, with the exception of any electrical components that must be installed by a licensed

electrician pursuant to the New York city electrical code, the purpose of which is to control, contain, suppress or extinguish fire and shall include:

1. The systems, materials and equipment described or referred to in this code (with the exception of any electrical components that must be installed by a licensed electrician pursuant to the New York city electrical code) which systems, materials or equipment shall include any standpipe system to which a sprinkler system is or is now being connected; provided, however, that such systems, materials or equipment shall not include any systems, materials or equipment constituting plumbing work, with the exception of up to thirty sprinkler heads off the domestic water in any one building; or
2. Any dry, liquid or gaseous chemical fire containment, suppression, control or extinguishing system or any other device or means of control, suppression, containment or extinguishing of fire (with the exception of any electrical components that must be installed by a licensed electrician pursuant to the New York city electrical code) but not including portable fire extinguishers.

HIGH-PRESSURE BOILER. A boiler that carries a pressure of more than fifteen pounds of steam per square inch and is rated in excess of ten horsepower, or that produces hot water over a pressure of one hundred sixty pounds per square inch or at a temperature over 250°F (121°C).

LICENSE. A license, registration, certification or other evidence, issued by the department pursuant to this chapter, representing that an individual, a sole proprietorship, partnership, corporation, business association or other person meets the qualifications and requirements as set out in this chapter and in the rules of the department and is authorized to engage in the particular trade, occupation or business as indicated on the license and representing that such license, with associated plate and/or seal, where applicable, has been renewed as required and is currently in effect. The license shall bear the holder's full name, the type of license, the license class, where applicable, the license number and any restrictions



relating to the use of such license. Such term shall not include a certificate of competence.

LICENSE BOARD OR BOARD. A panel of trade practitioners and others appointed by the commissioner as provided herein and in rules promulgated by the commissioner with the purpose of advising the commissioner regarding the character and fitness of applicants for a license or certificate of competence, allegations of illegal practices by persons licensed, or other matters as the commissioner may see fit.

LICENSED MASTER FIRE SUPPRESSION PIPING CONTRACTOR, MASTER FIRE SUPPRESSION PIPING CONTRACTOR. An individual who has satisfied the requirements of this chapter for the master fire suppression piping contractor license, who has been issued a license, plate and/or seal, and who is authorized under the provisions of this chapter to perform fire suppression piping work in the city of New York, according to the classification of license held. A master fire suppression piping contractor licensee shall practice his or her trade in association with a master fire suppression piping contractor business or as an employee of a city agency.

LICENSED MASTER PLUMBER, MASTER PLUMBER. An individual who has satisfied the requirements of this chapter for the master plumber license, who has been issued a license, plate and/or seal, and who is authorized under the provisions of this chapter to perform plumbing work in the city of New York. A master plumber licensee shall practice his or her trade in association with a master plumber business or as an employee of a city agency.

PLATE. A plaque issued by the department to a master plumber or a master fire suppression piping contractor setting forth the licensee's name and number, the class of license and the master plumber business or master fire suppression piping contractor business operating pursuant to the plate, and displayed prominently and conspicuously on view to the public at the place of business registered with the department. The plate is the property of the department and is not transferable by the licensee.

PLUMBING WORK. The installation, maintenance, repair, modification, extension or alteration of plumbing, standpipe where a sprinkler is not connected or is not now being connected, domestic water, connections to the domestic water, combination domestic water and reserve standpipe supply tank up to and including the roof tank check valve, gas piping or any piping system referred to in the New York city plumbing code, and/or up to thirty sprinkler heads off the domestic water in any building in the city of New York.

PRIVATE ELEVATOR INSPECTION AGENCY. An approved agency authorized by the commissioner to operate as an independent contractor for the purpose of inspecting and testing elevators, escalators and other conveying equipment regulated by this code and shall include but shall not be limited to an insurance company, elevator maintenance company, elevator manufacturer or elevator inspection company.

SEAL. Emblem issued by the department to an applicant for some license types, that allows the licensee to stamp documents required by this code to be signed and sealed. The seal shall bear the full name of the licensee, the license type, the license class, where applicable, and the license number. The seal is the property of the department and is not transferable by the licensee. For applications and other documents submitted electronically, the digital signature and imprint of the seal may be submitted in a manner authorized by the commissioner.

SIGN. A sign as defined in section 12-10 of the zoning resolution.

TOTAL BOOM. A boom including jibs and other extensions.

§28-401.4 Requirement of license. It shall be unlawful for any person to engage in or carry on in the city any business, trade or occupation regulated by this chapter, without having first obtained a license from the commissioner in accordance with and subject to the provisions of this chapter and the rules of the department. A license issued by the department for any such business, trade or occupation prior to the effective date of this code, shall remain in full force and effect until the expiration or termination thereof

in accordance with the terms thereof, unless sooner revoked or suspended for cause as hereinafter provided.

Any renewal of such license shall be in accordance with the provisions of this code.

§28-401.5 Application and conditions. Every application for a license or certificate of competence shall be made in such form and shall be accompanied by such information as the commissioner may prescribe, and by the required fee. It is a condition of the license or certificate of competence that information in the application be kept correct and current. Any change in required information shall be reported to the department within fourteen days after any change prior to issuance of the license or certificate of competence or within thirty days after any change following issuance.

§28-401.6 Qualifications of applicant. All applicants for a license or certificate of competence shall be at least 18 years of age, shall be able to read and write the English language, shall be of good moral character, and shall meet additional qualifications that may be prescribed for the particular license or certificate of competence.

§28-401.7 Examination of applicant. Except as otherwise specified for the particular license type, applicants for a license shall be required to take an examination in accordance with the rules of the department. Every applicant shall commence the license application process with the department within one year of passing the examination for licensure and shall furnish to the department a completed license application within one year of submission of the first filing. Failure to provide all requested documents in a timely manner will constitute an incomplete application and may result in denial of the license

§28-401.8 Investigation of applicant. Every applicant for a license or certificate of competence shall submit to investigation as directed by a governmental entity in order to determine the applicant's character and fitness. The applicant shall furnish the department with payment for the actual cost of conducting a background investigation. Failure to provide all requested and completed documents in a timely fashion will constitute an incomplete application and will result in a denial of the license or

certificate of competence.

§28-401.9 Insurance. Except as noted otherwise for a particular license, or exempted by the commissioner pursuant to rule, prior to the issuance of a license, or during the renewal thereof, the applicant shall file with the department (i) satisfactory evidence of a general liability insurance policy in the amount of one million dollars or such other amount as the commissioner may require, listing the New York city department of buildings as the certificate holder; and (ii) satisfactory evidence of an insurance policy for property damage in an amount set forth in rules and conditioned upon the observance of all applicable laws and rules governing the licensed activities and upon the payment of any applicable judgment awarded for damage to or destruction of property occurring in the performance of any regulated work by or under the supervision of the license holder. Each policy of insurance shall contain a provision for continuing liability notwithstanding any recovery under such policy. In addition, prior to the issuance of any license or seal and plate, if applicable, or during any renewal thereof, the applicant shall file with the department satisfactory evidence of compliance with the workers' compensation law and the disability benefits law.

§28-401.10 Issuance of license, plate and/or seal, where applicable, or certificate of competence. The commissioner shall issue a license or certificate of competence to each applicant who shall have submitted satisfactory evidence of his or her qualifications, and shall have satisfactorily passed all required examinations and investigations, provided that no license or certificate of competence shall be issued unless and until the applicant shall have paid the required fee and complied with such other and further requirements for the particular license or certificate of competence as may be set forth in this chapter and in rules promulgated by the department. All licenses or certificates of competence issued by the commissioner shall have his or her signature affixed thereto; but the commissioner may authorize any subordinate to affix such signature. For licenses that require a plate and/or the application of a seal, the plate

and/or seal shall be issued with the license except as provided otherwise in this chapter. The license, plate and seal are the property of the department and are not transferable by the licensee. No licensee shall make or cause to be made duplicates of a department-issued license, plate or seal. The loss or theft of a license, plate or seal must be reported to the department within five calendar days.

§28-401.11 Term of license. All licenses issued by the commissioner for which an examination is required shall expire three years from the date of issuance thereof, and may be renewed every three years thereafter without examination. The commissioner shall have authority to stagger the issuance of licenses for three-year terms. All licenses not requiring examination shall expire one year from the date of issuance thereof, and may be renewed each year thereafter except as otherwise noted for a specific license.

§28-401.12 Renewal of license or certificate of competence. Applications for renewal of a license or certificate of competence shall be accompanied by the renewal fee and such additional information as the commissioner may require, and shall be made at least 30 calendar days but not more than 60 calendar days prior to the expiration date of same. The failure of an individual to renew his or her license or certificate of competence shall have the effect of cancellation of the license or certificate of competence upon expiration, and the holder of a plate and/or seal issued by the department shall immediately surrender such plate and/or seal to the department. A person who fails to renew a license or certificate of competence within the time period set forth in this section 28-401.12 may apply for reinstatement of such license pursuant to section 28-401.13. The department may, following notice and an opportunity to be heard, refuse to renew a license or certificate of competence on any grounds on the basis of which it could deny, suspend or revoke such license.

§28-401.13 Reinstatement. If a license or certificate of competence expires, the individual may apply for reinstatement of the license or certificate of competence, within one year of the date of its expiration

without examination but subject to applicable late and reinstatement fees. Thereafter, and up to five years after the date of expiration, the commissioner may reinstate the license or certificate of competence without examination upon the applicant's demonstration to the commissioner's satisfaction of continued competence in the respective trade and satisfaction of any applicable continuing education requirements. A license or certificate of competence shall not be reinstated after five years from date of expiration.

§28-401.14 Continuing education. The commissioner may promulgate rules to require applicants for the renewal of licenses or certificate of competence to complete a prescribed number of hours of continuing education courses approved by the department within the term preceding the application for renewal and to provide proof of same in a form acceptable to the department. Such proof, when required, shall be submitted with the application for renewal.

§28-401.15 Schedule of fees.

<u>License Type</u>	<u>Initial Fee</u>	<u>Renewal Fee</u>	<u>Additional Fees</u>
<u>Master rigger license.</u>	<u>\$200.</u>	<u>\$150 triennially.</u>	<u>Late-renewal fee. \$50. Reissuance fee: \$50.</u>
<u>Special rigger license.</u>	<u>\$100.</u>	<u>\$75 triennially.</u>	<u>Late-renewal fee \$50. Reissuance fee: \$50.</u>
<u>Basic hoisting machine operator license (Class A).</u>	<u>\$150.</u>	<u>\$150 triennially.</u>	<u>Late-renewal fee \$50. Reissuance fee: \$50.</u>
<u>Basic hoisting machine operator license with endorsement to operate hoisting machinery without limitation or restriction (Class B).</u>	<u>\$200.</u>	<u>\$150 triennially.</u>	<u>Late-renewal fee \$50. Reissuance fee: \$50.</u>
<u>Special hoisting machine operator license (Class C).</u>	<u>\$100.</u>	<u>\$75 triennially.</u>	<u>Late-renewal fee \$50. Reissuance fee: \$50.</u>
<u>Concrete testing laboratory license.</u>	<u>\$100.</u>	<u>\$75 annually.</u>	<u>Late-renewal fee. \$50. Reissuance fee: \$50.</u>
<u>Welder license.</u>	<u>\$50.</u>	<u>\$45 triennially.</u>	<u>Late-renewal fee. \$50. Reissuance fee: \$50.</u>
<u>Master plumber license (certificate of competence).</u>	<u>\$200.</u>	<u>\$150 triennially.</u>	<u>Late-renewal fees: Up to 30 days late. \$50; From 31 days to five years late, \$100 for each year or part thereof. Reissuance fee: \$50.</u>

<u>Master plumber license plate.</u>	<u>\$75.</u>	<u>\$100 triennially.</u>	<u>Replacement fee upon loss of plate, w/affidavit: \$100.</u>
<u>Master plumber license seal.</u>	<u>\$50.</u>	<u>\$75 triennially.</u>	<u>Replacement fee upon loss of seal, w/affidavit: \$75.</u>
<u>Journeyman plumber registration.</u>	<u>\$50</u>		<u>No renewal, no reissuance.</u>
<u>Master fire suppression piping contractor (class A, B or C) license (certificate of competence).</u>	<u>\$200.</u>	<u>\$150 triennially.</u>	<u>Late-renewal fees: Up to 30 days late, \$50; From 31 days to five years late, \$100 for each year or part thereof. Reissuance fee: \$50.</u>
<u>Master fire suppression piping contractor (class A, B or C) license plate.</u>	<u>\$75.</u>	<u>\$100 triennially.</u>	<u>Replacement fee upon loss of plate, w/affidavit: \$100.</u>
<u>Master fire suppression piping contractor (class A, B or C) license seal.</u>	<u>\$50.</u>	<u>\$75 triennially.</u>	<u>Replacement fee upon loss of seal, w/affidavit: \$75.</u>
<u>Journeyman fire suppression piping contractor registration.</u>	<u>\$50</u>		<u>No renewal, no reissuance.</u>
<u>Oil-burning equipment installer. License (class A or B).</u>	<u>\$100.</u>	<u>\$75 triennially.</u>	<u>Late-renewal fee \$50. Reissuance fee: \$50.</u>
<u>High-pressure boiler operating engineer license.</u>	<u>\$50.</u>	<u>\$45 triennially.</u>	<u>Late-renewal fee \$50. Reissuance fee: \$50.</u>
<u>Portable high-pressure boiler operating engineer license.</u>	<u>\$50.</u>	<u>\$45 triennially.</u>	<u>Renewal fee includes renewal fee for a hoisting machine operator license. Late-renewal fee \$50. Reissuance fee: \$50.</u>
<u>Master sign hanger license.</u>	<u>\$100</u>	<u>\$75 triennially.</u>	<u>Late-renewal fee \$50. Reissuance fee: \$50.</u>
<u>Special sign hanger license.</u>	<u>\$100</u>	<u>\$75 triennially.</u>	<u>Late-renewal fee \$50. Reissuance fee: \$50.</u>
<u>Outdoor advertising company registration.</u>	<u>As provided by dept rules</u>	<u>As provided by dept rules.</u>	<u>As provided by dept rules.</u>
<u>Filing representative registration.</u>	<u>\$50</u>	<u>\$25 annually.</u>	<u>Late-renewal fee \$50. Reissuance fee: \$50.</u>
<u>Reinstatement of expired license, certificate of competence or certification without examination, if approved by commissioner, in addition to applicable renewal fees.</u>	<u>Same as initial license</u>		<u>\$100 for each year or part thereof from date of expiration.</u>

§28-401.16 Restrictions on use of license. No holder of a license issued under this chapter shall authorize, consent to or permit the use of his or her license by or on behalf of any other person, and no

person who has not qualified and obtained or renewed a license under this chapter shall hold himself or herself out to the public as licensed, certified, registered or as the holder of a license issued under this chapter, either directly or indirectly, by means of signs, sign cards, plates, stationery, or in any other manner whatsoever.

§28-401.17 Use on behalf of a business. Except for such additional requirements as may be set forth for a particular license, nothing in this chapter shall be construed to prohibit the use of a license by the holder thereof for or on behalf of a partnership, corporation or other business association, provided that:

1. At least one member of the partnership or at least one officer of the corporation is licensed for the same business, trade or occupation, and that all work performed by such partnership or corporation is performed by or under the direct and continuing supervision of such license holder or holders;  
or
2. Such partnership, corporation or other business association is itself authorized to engage in such business as prescribed herein.

§28-401.17.1 Use on behalf of a city agency. Nothing in this chapter shall be construed to prohibit the holder of a license who is an employee of a city agency from using such license to practice the trade for which such license is issued for or on behalf of such city agency in the course of such employment except as otherwise limited pursuant to articles 408 and 410 of this chapter for licensed master plumber and licensed master fire suppression piping contractor licensees.

§28-401.18 New York city location required. Except as otherwise noted for a particular license, the holder of a license, other than an employee of a city agency, shall have or be employed by a business entity that has an established place of business with an address within the city of New York at which such person can be contacted by the public and the department by mail, telephone or other modes of communication. A post office box is not an acceptable address.



§28-401.19 Suspension or revocation of license or certificate of competence. The commissioner shall have the power to suspend or revoke a license or certificate of competence and/or to impose a fine not to exceed twenty-five thousand dollars for each finding of violation, and/or to order any holder thereof to repair damage resulting from any act or omission as set forth in this chapter or in rules, for any of the following:

1. Fraud or deceit in obtaining or renewing a license, plate or seal, certificate of competence, certification, registration , or permit;
2. The making of a material false or misleading statement on any form or report filed with the department or other governmental entity;
3. The failure to file a statement, report or form required by law to be filed;
4. Willfully impeding or obstructing the filing of a statement, report or form of another required by law to be filed;
5. Fraudulent dealings;
6. Negligence, incompetence, lack of knowledge, or disregard of this code and related laws and rules;
7. Failure to comply with this code or any order, rule, or requirement lawfully made by the commissioner including failure to cooperate with investigations related to the trade for which the individual is licensed conducted by the commissioner or other government entity;
8. Failure to comply with any order, rule, regulation or requirement lawfully made by the commissioner of environmental protection or commissioner of transportation pertaining to water services, house connections street openings, street/lane closures or sidewalk closures that relate to requirements of this code;
9. A practice or pattern of failing timely to perform or complete contracts relating to home

improvements as defined by section 20-386 of the administrative code or a practice of abandoning contracts on residential buildings containing four dwelling units or less;

10. Failure to provide documents, including payroll records, workers compensation or other insurance documents, employee timekeeping records and corporate tax returns, required by the commissioner;

11. Engaging or assisting in any act that endangers the public safety and welfare;

12. Conviction of a criminal offense where the underlying act arises out of the individual's professional dealings with the city or any other governmental entity;

13. Poor moral character that adversely reflects on his or her fitness to conduct work regulated by this code; or

14. Failure to pay outstanding fines, penalties, or fees related to the individual's professional dealings with the city or any other governmental entity.

28-401.19.1 Notice and hearing. The commissioner shall not revoke or suspend a license or certificate of competence for any cause or impose any other sanction on a licensee unless and until the holder has been given at least five calendar days prior written notice and an opportunity to be heard. However, when the public safety may be imminently jeopardized the commissioner shall have the power, pending a hearing and determination of charges, to forthwith suspend any license for a period not exceeding five working days.

§28-401.19.2 Surrender of plate or seal. Upon surrender, suspension or revocation of a license for which the department has also issued a plate or seal, the license and such plate and/or seal shall be immediately surrendered to the department.

§28-401.19.3 Reinstatement fees. The fees required for the reinstatement of a certificate of competence or license, plate or seal after suspension shall be the same as those required to obtain an

original document. If reinstatement of the certificate of competence, license, plate or seal is not requested within 30 days of the lifting of the suspension, then late fees shall be imposed in accordance with article 119 of chapter 1 of this title.

§28-401.20 Cooperation required. Any person, including any corporation, partnership, business or other entity, issued a license or certificate of competence by the department shall, pursuant to a request or order of the commissioner or any other city agency or office, cooperate fully and completely with respect to any department or city agency or office investigation. Evidence of cooperation shall include, but is not limited to, appearing before the department or other city agency or office, answering questions completely and accurately, and providing any and all requested documents. Failure to comply with such request or order may subject such person to disciplinary measures authorized by law, including but not limited to suspension or revocation of the license or certificate of competence.

§28-401.20.1 Service of request or order. Such request or order by the commissioner or other city agency or office shall be mailed by regular mail to the person named therein to his or her last known business or home address at least ten days before such appearance and shall contain the name of the person, date, time and place of such appearance and, if known or applicable, a description of any requested documents. If the appearance or information is required immediately, the request or order may be transmitted via facsimile or delivered to the person's last known business or home address prior to the date and time specified therein.

§28-401.21 Judicial review of determinations. Notwithstanding any other provision of law to the contrary, decisions, orders and interpretations of the commissioner made pursuant to this chapter shall not be subject to review by the board of standards and appeals. Final decisions and orders of the commissioner made pursuant to this chapter shall be subject to review pursuant to article 78 of the civil practice law and rules.

ARTICLE 402  
SITE SAFETY MANAGER CERTIFICATE

§28-402.1 Certificate required. It shall be unlawful to perform the duties and responsibilities of a site safety manager as specified in chapter 33 of the New York city building code unless such work is performed by a person certified as a site safety manager under the provisions of this article.

§28-402.2 Qualifications. All applicants for a site safety manager certificate shall submit satisfactory proof establishing that the applicant:

1. Is a registered design professional and has had three years of experience supervising major buildings as that term is defined in chapter 33, and within one year prior to application has satisfactorily completed a 8-hour course approved by the department;
2. Has eight years of construction supervision experience within the 10 years prior to application, including five years supervising major buildings as that term is defined in chapter 33, and within one year prior to application has satisfactorily completed a 40-hour course approved by the department;
3. Has completed an 18 month on-the-job training program working on major buildings as that term is defined in chapter 33 under the direct and continuing supervision of a certified site safety manager. Such on-the-job training program shall conform to rules promulgated by the department. The supervising site safety manager shall certify the trainee's satisfactory completion of the training program. In addition, the applicant shall provide proof that, within one year prior to the date of application, he or she has satisfactorily completed a 40-hour course approved by the department;
4. Has equivalent education and construction experience as determined by the department and within one year prior to application has satisfactorily completed a 40-hour course approved by the department; or

5. Has three years of experience as a certified site safety coordinator and within one year prior to application has satisfactorily completed a 40-hour course approved by the department.

ARTICLE 403  
SITE SAFETY COORDINATOR CERTIFICATE

§28-403.1 Certificate required. It shall be unlawful to perform the duties and responsibilities of a site safety coordinator as specified in chapter 33 of the New York city building code unless such work is performed by a person certified as a site safety coordinator under the provisions of this article.

§28-403.2 Qualifications. All applicants for a site safety coordinator certificate shall submit satisfactory proof establishing that the applicant:

1. Is a registered design professional and has had two years of experience supervising major buildings as that term is defined in chapter 33, and within one year prior to application has satisfactorily completed an 8-hour course approved by the department;
2. Has five years of construction supervision or construction safety experience within the 10 years prior to application, including three years supervising major buildings as that term is defined in chapter 33, and within one year prior to application has satisfactorily completed an 8-hour course approved by the department; or
3. Has equivalent education and construction experience as determined by the department and within one year prior to application has satisfactorily completed a 40-hour course approved by the department.

ARTICLE 404  
RIGGER LICENSE

§28-404.1 Rigger license required. It shall be unlawful to hoist or lower any article on the outside of any building in the city unless such work is performed by or under the direct and continuing supervision of a person licensed as a rigger under the provisions of this article. The provisions of this article shall apply to

the erection or dismantling of a tower crane or a climber crane on a building and to the use of a derrick in their removal, except that such erection or dismantling may be performed by or under the direct and continuing supervision of a licensed climber or tower crane rigger in accordance with rules promulgated by the department.

Exception: The provisions of this article shall not apply to the hoisting or lowering of signs if the person so doing possesses a license as a sign hanger, as provided in this chapter, or to the loading or unloading of any building materials or equipment, other than boilers and tanks, from a delivery truck.

§28-404.2 Classification. Such licenses shall be classified as follows:

1. Master rigger license. Authorizes the holder thereof to hoist or lower any article, irrespective of weight, on the outside of any building.
2. Special rigger license. Authorizes the holder thereof to hoist or lower any article not exceeding 2,000 pounds (907 kg) in weight on the outside of any building.
3. Climber or tower crane rigger license. Authorizes the holder thereof to erect or dismantle a tower crane or a climber crane on a building and to use a derrick in their removal.

§28-404.3 Additional qualifications. Applicants for a rigger license shall have the additional qualifications as set forth in sections 28-404.3.1 through 28-404.3.3.

§28-404.3.1 Master rigger qualifications. All applicants for a master rigger license shall submit satisfactory proof establishing that the applicant:

1. Has had at least five years of practical experience in the hoisting and rigging business within the seven years prior to application; and
2. Has knowledge of and is able to explain the risks incident to such business and precautions to be taken in connection therewith, safe loads and computation thereof, types of rigging, size and strength of ropes, cables, blocks, poles, derricks, sheerlegs and other tools used in connection with such

business.

§28-404.3.2 Special rigger qualifications. All applicants for a special rigger license shall submit satisfactory proof establishing that the applicant:

1. Has had at least one year of practical experience in the hoisting and rigging business within the three years prior to application; and
2. Has knowledge of and is able to explain the risks incident to such business and precautions to be taken in connection therewith.

§28-404.3.3 Climber or tower crane rigger qualifications. All applicants for a climber or tower crane rigger license shall submit satisfactory proof establishing that the applicant:

1. Has had at least five years of practical experience in the climber or tower crane rigging business within the seven years prior to application; and
2. Has knowledge of and is able to explain the risks incident to such business and precautions to be taken in connection therewith, including connecting pins, cables, anchorage, platform or pad, plumb of mast, torque of bolts, supervision of rigging and hoisting of loads, placement of components, and coordination of sequencing.

§28-404.4 Additional requirements. The additional requirements set forth in sections 28-404.4.1 through 28-404.4.3 shall apply to riggers:

§28-404.4.1 Danger warning. Every licensed master or special rigger shall, while rigging operations are in progress at a job site, place, conspicuously, at such job site two plates or signs not less than 18 inches (457 mm) by 24 inches (610 mm) in size (i) displaying the word “danger” in letters not less than 6 inches (152 mm) high, and (ii) disclosing the rigger’s name, business address, type of rigger license and license number.

§28-404.4.2 Master rigger place of business. Every licensed master rigger shall have a place of

business within the city and shall display prominently at such place of business a plate or sign marked with the words “master rigger” and his or her license number immediately thereunder.

§28-404.4.3. Fitness to perform work. As a condition of license renewal, a licensed master or special rigger shall provide evidence satisfactory to the department that such licensee is fit to perform the work.

ARTICLE 405  
HOISTING MACHINE OPERATOR LICENSE

§28-405.1 Hoisting machine operator license required. It shall be unlawful for any persons to take charge of or operate any power-operated hoisting machine used for hoisting purposes or cableways under the jurisdiction of the department, except power-operated scaffolds and window-washing machines, unless such person is licensed under the provisions of this article or is a holder of a certificate of qualification as a hoisting machine operator issued prior to December 6, 1968 and not allowed to lapse.

Exceptions:

1. The commissioner may, by rule, exempt operators of mobile cranes of limited size and capacity from the requirements of this article.
2. The provisions of this article shall not apply to machines under one ton capacity.

§28-405.2 Classification. Hoisting machine operator licenses shall be classified as follows:

1. Class A license: Basic license to operate cranes with total boom less than 200 feet (60 960 mm) in length, derricks and cableways, excluding truck-mounted tower cranes that exceed 200 feet (60 960 mm) in height.
2. Class B license: Endorsement on basic license to include the operation of hoisting machinery without limitation or restriction.
3. Class C license: Special hoisting machine operator license to operate a specified class of hoisting machine of limited size and capacity as follows:



Class C1: License to operate wheel mounted cranes (single control station) with telescoping, hydraulic or folding booms, including jibs and any other extensions to the boom, not exceeding 200 feet in length (60 960 mm) with a manufacturer's rated capacity of 50 tons (51 t) or less;

Class C2: License to operate boom trucks with telescoping, hydraulic or folding booms, including jibs and any other extensions to the boom, not exceeding 200 feet (60 960 mm) in length with a manufacturer's rated capacity of 50 tons (51 t) or less;

Class C3: License to operate boom trucks with telescoping, hydraulic or folding booms, including jibs and any other extensions to the boom, not exceeding 135 feet (41 148 mm) in length with a manufacturer's rated capacity of three tons or less, used exclusively for the erection, maintenance or removal of signs.

§28-405.3 Additional qualifications. Applicants for a hoisting machine operator license shall have the following additional qualifications.

§28-405.3.1 Class A license. All applicants for a class A basic hoisting machine operator license shall have had at least three years experience within the five years prior to application under the direct and continuing supervision of a licensed hoisting machine operator.

§28-405.3.2 Class B license. All applicants for a class B hoisting machine operator license shall hold a class A basic hoisting machine operator license, and shall have had at least two years experience prior to application under the direct and continuing supervision of a Class B licensed hoisting machine operator operating the equipment for which they are applying for endorsement and shall satisfactorily demonstrate by operation that they are competent to operate a crane with a boom, including jibs and other extensions, exceeding 200 feet (60 960 mm) in length or truck-mounted tower crane exceeding 200 feet (60 960 mm) in height, or as otherwise provided in rules of the department.

§28-405.3.3 Class C license. All applicants for a class C special hoisting machine operator license shall have had at least two years experience within the three years prior to application under the direct and continuing supervision of a licensed hoisting machine operator and have satisfactorily passed a practical examination in the operation of equipment for which such license is to be issued.

§28-405.4 Fitness to perform work. As a condition of license renewal, a licensed hoisting machine operator shall provide evidence satisfactory to the department that he or she is fit to perform the work.

§28-405.5 Insurance exemption: Unless otherwise required by rule, licensed hoisting machine operators are exempt from the insurance requirements of section 28-401.9.

#### ARTICLE 406 CONCRETE TESTING LABORATORY LICENSE

§28-406.1 Concrete testing laboratory license required. Testing of concrete required by this code or other applicable laws or rules shall be conducted by a concrete testing laboratory licensed in accordance with this article.

§28-406.2 Qualifications. All applicants for a concrete testing laboratory license shall maintain a laboratory within 50 miles (80 467 m) of the city and shall submit satisfactory proof establishing that the business is conducted by qualified personnel in accordance with procedures, safety requirements and professional standards as set forth in rules of the department. The department shall inspect an applicant's place of business and equipment and conduct an investigation of applicant's personnel in a manner to be set forth in department rules prior to the issuance or renewal of a license.

§28-406.3 Additional requirements. The following additional requirements shall apply to concrete testing laboratories:

§28-406.3.1 Director. Each laboratory shall have in responsible charge a director who shall be a registered design professional and who shall personally supervise all technical functions of the laboratory relating to testing of concrete and concrete materials as required in this code and in rules of

the department.

§28-406.3.2 Certification of reports by director. The director shall certify the truth and accuracy of all reports filed by the laboratory under the provisions of this code or other applicable laws and rules.

§28-406.4 No examination required. An examination shall not be required for a concrete testing laboratory license.

ARTICLE 407  
WELDER LICENSE

§28-407.1 Welder license required. It shall be unlawful to perform manual welding work on any structural member of any building in the city unless such work is performed by a person licensed as a welder under the provisions of this article.

§28-407.2 Qualifications. All applicants for a welder license shall submit satisfactory proof of the applicant's fitness to make structural welds, including his or her ability to pass operator qualification tests as determined by the commissioner.

§28-407.3 Fitness to perform work. As a condition of license renewal, a licensed welder shall provide evidence satisfactory to the department that such licensee is fit to perform the work.

§28-407.4 Insurance exemption. Unless otherwise required by rule, licensed welders are exempt from the insurance requirements of section 28-401.9.

ARTICLE 408  
MASTER PLUMBER LICENSE

§28-408.1 Master plumber license required. It shall be unlawful for any person:

1. To perform plumbing work unless such person is a licensed master plumber or working under the direct and continuing supervision of a licensed master plumber except that a city employee who holds a master plumber license may only perform replacement, maintenance and repair plumbing work on existing buildings in the course of his or her employment.

2. To use the title licensed master plumber, master plumber or any other title in such manner as to convey the impression that such person is a licensed master plumber unless such person is licensed as such in accordance with the provisions of this article.

§28-408.2 Seal. All documents that are required to be filed with any department or agency of the city of New York shall bear the stamp of the seal as well as the signature of the licensee. The licensed master plumber performing the work and services shall personally sign and seal all applications and other documents required to be filed pursuant to this code.

§28-408.3 Additional qualifications. Applicants for a master plumber license shall have the following additional qualifications:

§28-408.3.1 Experience. All applicants for a master plumber license shall submit satisfactory proof establishing that the applicant:

1. Has had at least seven years total experience within the 10 years prior to application in the design and installation of plumbing systems under the direct and continuing supervision of a licensed master plumber in the United States, with at least two years of such experience as a registered journeyman plumber in accordance with the provisions of article 409, except that during the three years immediately following the effective date of this code there shall be no requirement for such registered journeyman plumber experience;
2. Has received a bachelor's degree in engineering or appropriate engineering technology from an accredited college or university and has had at least five years total experience within the seven years prior to application in the design and installation of plumbing systems under the direct and continuing supervision of a licensed master plumber in the United States, where at least two years of such experience were in New York city;

3. Is an architect or engineer with at least three years of experience within the five years prior to application in the design and installation of plumbing systems under the direct and continuing supervision of a licensed master plumber in the United States, where at least one year of such experience was in New York city; or
4. Has had at least seven years total experience within the 10 years prior to application, with at least two years of such experience working in the design and installation of plumbing systems under the direct and continuing supervision of a licensed master plumber in the United States. The balance of such required experience may be obtained by performing maintenance, replacement and repair plumbing work on existing buildings while in the employ of a city agency under the direct and continuing supervision of a licensed master plumber supervisor employed by the city agency. Three years after the effective date of this code the two years experience in the design and installation of plumbing systems set forth above may only be satisfied by working as a registered journeyman plumber.
5. An employee of a government agency, private inspection agency or other entity, acceptable to the commissioner, whose duties primarily involve the inspection of plumbing work for compliance with the New York city plumbing code and/or other laws relating to the installation, alteration or repair of plumbing systems shall be credited with fifty percent (50%) of the number of years that he or she has been satisfactorily employed in such duties within the ten (10) year period prior to application, which, however, in no event, shall exceed two and one-half (2 1/2) years credit of satisfactory experience. The balance of the required seven years must have been obtained by working in the design and installation of plumbing systems under the direct and continuing supervision of a licensed master plumber in the United States except that the requirement of paragraph 1 of this section 28-408.3.1 that an applicant's working

experience must have been within the ten (10) year period prior to application shall not apply to such balance of the work experience required pursuant to this paragraph.

§28-408.3.2 Armed services. Applicants who were engaged in plumbing work as above provided prior to entering the armed services of the United States shall be permitted to credit their time in the service as experience in the plumbing business, as above provided; but such service credit shall not exceed one-third of the time required for experience.

§28-408.4 Certificate of competence and license, plate and/or seal. The commissioner shall issue a certificate of competence, license, plate, and/or seal, in accordance with the following:

§28-408.4.1 Certificate of competence. A certificate of competence shall be issued by the commissioner to an applicant who satisfactorily complies with the experience and examination requirements of this chapter for a license, upon payment of the fee. Such certificate shall contain the full name of the individual and a certificate number, the date of issuance, and shall be signed by the commissioner.

§28-408.4.2 Effect of issuance. The issuance of a certificate of competence shall constitute evidence that the person named therein is qualified upon payment of applicable fees to obtain a plate and seal while the certificate is valid except that a city employee while in the employ of the city shall only be entitled to obtain a seal.

§28-408.4.3 Plate and/or seal required. The holder of a certificate shall not be entitled to perform work or hold himself or herself out to perform work as a licensed master plumber until such plate and/or seal have been obtained. Further, no holder of a certificate of competence shall enter into any contractual agreement to install or alter any plumbing, gas piping, or any piping system, other than an employment agreement with a master plumber business or a city agency.

§28-408.4.4 Effect of failure to obtain plate and/or seal. If a holder of a certificate of competence has

held the certificate for five years without a plate and/or seal, then the commissioner may require said person to submit an affidavit and supporting documentation satisfactory to the department stating that over the five-year period the individual has been engaged in the design and installation of plumbing systems in the United States under the direct and continuing supervision of a licensed master plumber. If the holder's qualifications are not satisfactory to the commissioner, the commissioner may require such person to submit to reexamination or to provide evidence of retained proficiency. In addition, additional fees will be due as set forth in this chapter.

§28-408.4.5 Requirement for obtaining plate and /or seal. A holder of a certificate of competence shall obtain:

1. A license, plate and seal upon establishing a master plumbing business conforming to the requirements of this article and rules promulgated by the department; or
2. A license and seal upon demonstrating employment with a city agency. The license shall clearly state: "The bearer of this master plumber license is a government employee and as such is not authorized to engage in plumbing contract work outside of his/her government employment and within such government employment shall only engage in maintenance, replacement and repair plumbing work on existing buildings." No plate shall be issued to a licensed master plumber employed by a city agency.

§28-408.4.6 Issuance. A certificate of competence or a license, plate, and/or seal as a master plumber shall be issued only to an individual.

§28-408.4.7 Duplication prohibited. Not more than one license, plate and/or seal shall be issued to an individual and no individual shall make or cause to be made a duplicate of such license, plate or seal.

§28-408.5 Surrender of license, plate or seal. Upon the death or the retirement of a licensed master plumber, or upon the surrender, revocation or suspension of his or her license, his or her license, plate and/or

seal shall immediately be surrendered to the commissioner. Nothing contained herein shall be construed to prevent the legal representative of a deceased licensee, with the consent of the commissioner, from retaining such plate and seal for the purpose of completing all unfinished work of the deceased licensee for which plans have been approved and a permit issued, provided such work is performed by or under the direct and continuing supervision of a licensed master plumber and is completed within one year from the date of the death of the original licensee.

§28-408.6 Master plumber business. No individual, corporation, partnership or other business association shall conduct a plumbing contracting business in the city of New York, or employ the name “plumber” or “plumbing” in its business name unless such business is a master plumber business as follows:

1. No less than 51 percent of the control and voting capital stock of such entity is owned by one or more individuals who are licensed master plumbers, except as otherwise provided;
2. All plumbing or gas piping work performed by such entity is performed by or under the direct and continuing supervision of such licensed master plumber;
3. The person in charge of such work is such licensed master plumber; and
4. The persons actually performing such work are in the direct employ of such master plumber business as authorized by the code.

Exception: A company, corporation, partnership or other business association or its predecessor that was engaged in plumbing work prior to January 25, 1990 may continue to do so in any one or more of such business forms without complying with the foregoing, if (i) application was made to the department prior to July 25, 1990, and (ii) necessary evidence was furnished on or prior to January 25, 1991, that such company, corporation, partnership or other business association or its predecessor had employed an average of ten or more journeymen plumbers doing plumbing work for at least five days a week for a period of 10 years or more out of the twenty years preceding July 25, 1990, provided, that such



plumbing business continues to have all plumbing work conducted under the management and direct and continuing supervision of a licensed master plumber in the direct employ of such plumbing business and that such licensed master plumber is not otherwise interested in, associated with or employed by any other plumbing business operating in this city except as a joint venture in which such master plumber's employer is one of the joint venturers.

§28-408.6.1 Use. Nothing herein contained shall be construed to prohibit the use of a master plumber license by the holder thereof for or on behalf of a partnership, corporation or other business association provided that such partnership, corporation or other business is a master plumber business.

§28-408.6.2 Identification. All business vehicles, advertising, websites and stationery used in connection with a master plumber business shall display prominently the full name of the licensee, the words "N.Y.C. licensed plumber," the licensee's number and the licensee's business address. If the business is conducted under a trade name, or by a partnership or corporation, the trade name, partnership or corporate name shall be placed immediately above the full name or names of the licensed master plumber or licensed master plumbers to whom the plates were issued.

§28-408.6.3 Withdrawal of license. If a licensed master plumber withdraws from a master plumbing business operating pursuant to such individual's license, the right of the business to perform plumbing work shall lapse if the provisions of this section 28-408.6 are no longer satisfied. If a licensed master plumber's license is revoked or suspended, such licensee will be deemed withdrawn from such business.

§28-408.6.4 Ownership limitations. An individual who is a licensed master plumber whose interest or ownership in a master plumber business constitutes any portion of the 51 percent interest or control required by this section 28-408.6 shall be prohibited from possessing an interest or ownership in more than one other master plumber business at his or her established place of business, where such interest

or ownership would constitute any portion of the 51 percent interest or control required by this section 28-408.6. Both master plumber businesses in which the individual who is a licensed master plumber has an interest shall be located at the same place of business. For the purposes of this section 28-408.6, where two or more individuals who are licensed master plumbers possess an interest or ownership in any master plumber business which together represents more than 51 percent of the interest or control of such entity, all of such licensees shall be deemed to possess a portion of the 51 percent interest or control required by this section 28-408.6.

§28-408.6.5 Joint ventures. Nothing contained in this section 28-408.6 shall be construed to prevent a master plumber business from entering into a joint venture of limited duration for a particular project with another master plumber business. The terms of a joint venture must be in writing, and documentation of the joint venture must be submitted to the department for approval prior to the initiation of work under such venture.

§28-408.6.6 Supervision. The master plumber shall conduct his or her business to provide direct and continuing supervision in accordance with the provisions of this code.

Exception: The provisions of this section 28-408.6.6 shall not apply to minor alterations or ordinary repairs, as defined in this code, or to the installation or alteration of gas service piping and gas meter piping, including meters, valves, regulators or related equipment, when such work is to be performed, serviced and maintained by utility corporations subject to the jurisdiction of the New York state public service commission.

## ARTICLE 409 JOURNEYMAN PLUMBER REGISTRATION

§28-409.1 Journeyman plumber registration; additional qualifications. Upon satisfactory completion of a New York State-recognized training program or affirmation of an applicant's qualifications by an employer licensed master plumber or, in the case of a city agency, a supervising licensed master plumber

and upon written stipulation of same by the applicant, the commissioner shall register an applicant as journeyman plumber. Such qualifications shall reflect a progressive understanding, proficiency and competence in the plumbing trade, including:

1. A working familiarity with the plumbing code and technical standards and the ability to apply the code requirements correctly;
2. The application of basic plumbing theory and the utilization of trade skills on the job site;
3. A working knowledge of the tools of the trade and the ability to utilize them properly; and
4. An ability to draft simple diagrams and interpret from drawings for the purpose of the plumbing work in which the applicant is engaged.

§28-409.2 Experience. The applicant for journeyman plumber registration shall have a minimum of five years of full-time experience in the performance of plumbing work under the direct and continuing supervision of a licensed master plumber or equivalent, where at least one year of such experience shall have been in New York city.

§28-409.3 Registration need not be renewed. The registration for journeyman plumber shall have no expiration and shall not require renewal or re-issuance.

§28-409.4 Registration card. The registration card shall clearly state: “This registration is NOT A LICENSE, and the holder is NOT AUTHORIZED TO PERFORM PLUMBING WORK in New York city except under the direct and continuing supervision of a licensed master plumber.”

ARTICLE 410  
MASTER FIRE SUPPRESSION PIPING CONTRACTOR LICENSE

§28-410.1 Master fire suppression piping contractor license required. It shall be unlawful for any person:

1. To perform fire suppression piping work unless such person is a licensed master fire suppression piping contractor or working under the direct and continuing supervision of a licensed master fire suppression piping contractor except that a city employee who holds a license may only perform

replacement, maintenance and repair fire suppression piping work on existing buildings in the course of his or her employment.

2. To use the title licensed master fire suppression piping contractor, master fire suppression piping contractor or any other title in such manner as to convey the impression that such person is a licensed master fire suppression piping contractor unless such person is licensed as such in accordance with the provisions of this article.

§28-410.2 Seal. All documents that are required to be filed with any department or agency of the city of New York shall bear the stamp of the seal as well as the signature of the licensee. The licensed master fire suppression piping contractor performing the work and services shall personally sign and seal all applications and other documents required to be filed pursuant to the code.

§28-410.3 Classification. There shall be three classes of licenses for master fire suppression piping contractor:

1. Class A. The holder of a class A master fire suppression piping contractor license is authorized to perform any work in connection with any and all fire suppression piping systems as set forth in paragraphs 1 and 2 of the definition of fire suppression piping system in section 28-401.3.
2. Class B. The holder of a class B master fire suppression piping contractor license is authorized to perform any work in connection with any and all fire suppression piping systems as set forth in paragraph 1 of the definition of fire suppression piping system in section 28-401.3.
3. Class C. The holder of a class C master fire suppression piping contractor license is authorized to perform any work in connection with any and all fire suppression piping systems as set forth in paragraph 2 of the definition of fire suppression piping system in section 28-401.3.

§28-410.4 Additional qualifications. Applicants for a master fire suppression piping contractor license shall have the following additional qualifications:

§28-410.4.1 Experience. All applicants for a master fire suppression piping contractor license shall submit satisfactory proof establishing that the applicant:

1. Has had at least seven years total experience within the 10 years prior to application in the design and installation of fire suppression piping systems under the direct and continuing supervision of a licensed master fire suppression piping contractor in the United States with the class of license for which application is made, with at least two years of such experience as a registered journeyman fire suppression piping installer in accordance with the provisions of article 411, except that during the three years immediately following the effective date of this code there shall be no requirement for such registered journeyman fire suppression piping installer experience;
2. Has received a bachelor's degree in engineering or appropriate engineering technology from an accredited college or university and has had at least five years total experience within the seven years prior to application in the design and installation of fire suppression piping systems under the direct and continuing supervision of a licensed master fire suppression piping contractor in the United States for the class of license for which application is made, at least two of which were in New York city;
3. Is an architect or engineer with at least three years of experience within the five years prior to application in the design and installation of fire suppression piping systems in the United States for the class of license for which application is made, where at least one year of such experience was in New York city; or
4. Has had at least seven years total experience within the 10 years prior to application, with at least two years of such experience working in the design and installation of fire suppression piping systems under the direct and continuing supervision of a licensed master fire

suppression piping contractor in the United States with the class of license for which application is made. The balance of such required experience may be obtained by performing maintenance, replacement and repair of fire suppression piping work on existing buildings while in the employ of a city agency under the direct and continuing supervision of a licensed master fire suppression piping contractor supervisor employed by the city agency with the class of license for which application is made. Three years after the effective date of this article the two years of experience in the design and installation of fire suppression piping systems set forth above may only be satisfied by working as a registered journeyman fire suppression piping installer.

5. An employee of a government agency, private inspection agency or other entity, acceptable to the commissioner, whose duties primarily involve the inspection of plumbing work for compliance with this the New York city plumbing code and/or other laws relating to the installation, alteration or repair of fire suppression piping systems shall be credited with fifty percent (50%) of the number of years that he or she has been satisfactorily employed in such duties within the ten (10) year period prior to application, which, however, in no event, shall exceed two and one-half (2½) years credit of satisfactory experience. The balance of the required seven years must have been obtained by working in the design and installation of fire suppression piping systems under the direct and continuing supervision of a licensed fire suppression piping contractor in the United States except that the requirement of paragraph 1 of this section 28-410.4.1 that an applicant's working experience must have been within the ten (10) year period prior to application shall not apply to such balance of the work experience required pursuant to this paragraph.

§28-410.4.2 Armed services. Applicants who were engaged in fire suppression piping work prior to entering the armed services of the United States shall be permitted to credit their time in the service as experience in the fire suppression piping business, as above provided; but such service credit shall not exceed one-third of the time required for experience.

§28-410.5 Certificate of competence and license, plate and/or seal. The commissioner shall issue a certificate of competence, license, plate and/or seal in accordance with the following:

§28-410.5.1 Certificate of competence. A certificate of competence shall be issued by the commissioner to an applicant who satisfactorily complies with the experience and examination requirements of this article for a license, upon payment of the fee. Such certificate shall contain the full name of the individual and a certificate number, and shall be signed by the commissioner.

§28-410.5.2 Effect of issuance. The issuance of a certificate of competence shall constitute evidence that the person named therein is qualified upon payment of applicable fees to obtain a plate and seal while the certificate is valid except that a city employee while in the employ of the city shall only be entitled to obtain a seal.

§28-410.5.3 Plate and /or seal required. The holder of a certificate of competence shall not be entitled to perform work or hold himself or herself out to perform work as a licensed master fire suppression piping contractor until such plate and/or seal have been obtained. Further, no holder of a certificate of competence shall enter into any contractual agreement to install or alter any fire suppression piping system other than an employment agreement with a master fire suppression piping business or a city agency.

§28-410.5.4 Failure to obtain plate and/or seal. If a holder of a certificate of competence has held the certificate for five years without a plate and/or seal, then the commissioner may require said person to submit an affidavit and supporting documentation satisfactory to the department stating that over the

five-year period the individual has been engaged in the design and installation of fire suppression piping systems in the United States under the direct and continuing supervision of a licensed master fire suppression piping contractor. If the holder's qualifications are not satisfactory to the commissioner, the commissioner may require such person to submit to reexamination or to provide evidence of retained proficiency. In addition, additional fees will be due as set forth in this chapter.

§28-410.5.5 License plate and/or seal. A holder of a certificate of competence or an applicant who has satisfied all requirements for a master fire suppression piping contractor license shall obtain:

1. A license, plate and seal upon establishing a fire suppression piping contracting business conforming to the requirements of this article and any rules promulgated by the department; or
2. A license and seal upon demonstrating employment with a city agency. The license shall clearly state: "The bearer of this master fire suppression piping contractor license is a government employee and as such is not authorized to engage in fire suppression piping contract work outside of his/her government employment and within such government employment shall only engage in maintenance, replacement and repair fire suppression piping work on existing buildings." No plate shall be issued to a licensed master fire suppression piping contractor employed by a city agency.

§28-410.5.6 Issuance. A certificate of competence or a license, plate and/or seal as a master fire suppression piping contractor shall be issued only to an individual.

§28-410.5.7 Duplication prohibited. Not more than one license, plate and/or seal shall be issued to an individual, and no individual shall make or cause to be made a duplicate of such license, plate or seal.

§28-410.6 Waiver of examinations. Any license issued without examination pursuant to an application filed prior to July 25, 1990 pursuant to the provisions of law in effect prior to the effective date of this code that has not lapsed as of the effective date of this code, shall be renewable pursuant to the provisions



of this code.

§28-410.7 Surrender of license, plate and/or seal. Upon the death or the retirement of a licensed master fire suppression piping contractor, or upon the surrender, revocation or suspension of his or her license, his or her license, plate and seal shall immediately be surrendered to the commissioner. Nothing contained herein shall be construed to prevent the legal representative of a deceased licensee, with the consent of the commissioner, from retaining such plate and seal for the purpose of completing all unfinished work of such deceased licensee for which plans have been approved and a permit issued, provided such work is performed by or under the direct and continuing supervision of a licensed master fire suppression piping contractor and is completed within one year from the date of the death of the original licensee.

§28-410.8 Master fire suppression piping contractor business required. No individual, corporation, partnership or other business association shall conduct a fire suppression piping contracting business in the city of New York, or employ the name “fire suppression piping” in its business name, unless the business is a master fire suppression business as follows:

1. No less than 51 percent of the control and voting capital stock of such entity is owned by one or more individuals who are licensed master fire suppression piping contractors, except as otherwise provided; and
2. All fire suppression piping work performed by such entity is performed by or under the direct and continuing supervision of such licensed master fire suppression piping contractor;
3. The person in charge of such work is such licensed master fire suppression piping contractor; and
4. The persons actually performing such work are in the direct employ of such master fire suppression piping contractor business as authorized by the code.

Exception: A company, corporation, partnership or other business association or its predecessor that was engaged in fire suppression piping contractor work prior to January 25, 1990 may continue to do so in

any one or more of such business forms without complying with the foregoing, if (i) application was made to the department prior to July 25, 1990, and (ii) necessary evidence was furnished on or prior to January 25, 1991, that such company, corporation, partnership or other business association or its predecessor had employed an average of 10 or more journeymen doing fire suppression piping contractor work for at least five days a week for a period of ten years or more out of the 20 years preceding July 25, 1990, provided, that such business continues to have all fire suppression piping contractor work conducted under the management and direct and continuing supervision of a licensed master fire suppression contractor in the direct employ of such business and that such licensed master fire suppression contractor is not otherwise interested in, associated with or employed by any other licensed master fire suppression contracting business operating in this city except as a joint venture in which such licensed master fire suppression contractor's employer is one of the joint venturers.

§28-410.8.1 Use. Nothing herein contained shall be construed to prohibit the use of a master fire suppression piping contractor license by the holder thereof for or on behalf of a partnership, corporation or other business association provided that such partnership, corporation or other business is a master fire suppression piping contractor business.

§28-410.8.2 Identification. All business vehicles, advertising, websites and stationery used in connection with a master fire suppression piping contractor business shall display prominently the full name of the licensee, the words "N.Y.C. licensed fire suppression piping contractor – class A, B or C," the licensee's number and the licensee's business address. If the business is conducted under a trade name, or by a partnership or corporation, the trade name, partnership or corporate name shall be placed immediately above the full name or names of the licensed master fire suppression piping contractor or licensed master fire suppression piping contractors to whom the plates were issued.

§28-410.8.3 Withdrawal of licensee. If a licensed master fire suppression piping contractor withdraws

from a master fire suppression piping contractor business operating pursuant to such individual's license, the right of the business to perform fire suppression piping work shall lapse if the provisions of this article are no longer satisfied. If a licensed master fire suppression piping contractor's license is revoked or suspended, such licensee will be deemed withdrawn from such business.

§28-410.8.4 Ownership limitations. An individual who is a licensed master fire suppression piping contractor whose interest or ownership in a master fire suppression piping contractor business constitutes any portion of the 51 percent interest or control required by this section 28-410.8 shall be prohibited from possessing an interest or ownership in more than one other fire suppression piping contractor business at his or her established place of business where such interest or ownership would constitute any portion of the 51 percent interest or control required by this section 28-410.8. Both fire suppression piping contractor businesses in which the individual who is a licensed master fire suppression piping contractor has an interest shall be located at the same place of business. For the purposes of this section 28-410.8, where two or more individuals who are licensed master fire suppression piping contractors possess an interest or ownership in any master fire suppression piping contractor business which together represents more than fifty-one percent of the interest or control of such entity, all of such licensees shall be deemed to possess a portion of the 51 percent interest or control required by this section 28-410.8.

§28-410.8.5 Joint ventures. Nothing contained in this section 28-410.8 shall be construed to prevent a master fire suppression piping contractor business from entering into a joint venture of limited duration for a particular project with another master fire suppression piping contractor business. The terms of a joint venture must be in writing, and documentation of the joint venture must be submitted to the department for approval prior to the initiation of work under such venture.

§28-410.8.6 Supervision. The master fire suppression piping contractor shall conduct his or her

business to provide direct and continuing supervision in accordance with the provisions of this article.

Exception: The provisions of this section 28-410.8.6 shall not apply to minor alterations or ordinary repairs, as defined in this code, and/or to maintenance of a fire suppression piping system.

#### ARTICLE 411 JOURNEYMAN FIRE SUPPRESSION PIPING INSTALLER REGISTRATION

§28-411.1 Journeyman fire suppression piping installer registration; additional qualifications. Upon satisfactory completion of a New York state-recognized training program or affirmation of an applicant's qualifications by an employer licensed master fire suppression piping contractor or, in the case of a city agency, a supervising licensed master fire suppression piping contractor and upon written stipulation of same by the applicant, the commissioner shall register an applicant as journeyman fire suppression piping installer. Such qualifications shall reflect a progressive understanding, proficiency and competence in the fire suppression piping trade, including:

1. A working familiarity with the code and technical standards with regard to fire suppression piping, and the ability to apply the code requirements correctly;
2. The application of basic fire suppression theory and the utilization of trade skills on the job site;
3. A working knowledge of the tools of the trade and the ability to utilize them properly; and
4. An ability to draft simple diagrams and interpret from drawings for the purpose of the fire suppression piping work in which the applicant is engaged.

§28-411.2 Experience. The applicant for journeyman fire suppression piping installer registration shall have a minimum of five years of full-time experience in the performance of fire suppression piping work under the direct and continuing supervision of a licensed master fire suppression piping contractor or equivalent, where at least one year of such experience shall have been in New York city.

§28-411.3 The registration for journeyman fire suppression piping installer shall have no expiration and

shall not require renewal or reissuance.

§28-411.4 The registration shall clearly state: “This registration is NOT A LICENSE, and the holder is NOT AUTHORIZED TO PERFORM FIRE SUPPRESSION PIPING WORK in New York city except under the direct and continuing supervision of a Licensed Master Fire Suppression Piping Contractor.”

## ARTICLE 412 OIL-BURING EQUIPMENT INSTALLER LICENSE

§28-412.1 Oil-burning equipment installer license required. It shall be unlawful to install oil-burning equipment in the city unless such work is performed by or under the direct and continuing supervision of a person licensed as an oil-burning equipment installer under the provisions of this article.

§28-412.2 Classifications. Oil-burning equipment installer licenses shall be classified as follows:

1. Class A oil-burning equipment installer license. Licenses the holder thereof to install any type of oil-burning equipment, as an independent contractor with full responsibility for the manner in which the work is done, and for the material and equipment used, and for the control and direct and continuing supervision of the persons employed on the work. Such equipment shall include but not be limited to burners, boilers and generators.
2. Class B oil-burning equipment installer license. Licenses the holder thereof to install oil-burning equipment for the use of domestic fuel oils from number one fuel oil to and including number four fuel oil, as an independent contractor with full responsibility for the manner in which the work is done, for the materials and equipment used, and for the control and direct and continuing supervision of the persons employed on the work.

§28-412.3 Qualifications. Applicants for an oil-burning equipment installer license shall have the qualifications set forth in sections 28-412.3.1 through 28-412.3.2.

§28-412.3.1 Experience for Class A license. All applicants for a class A oil-burning equipment installer license shall submit satisfactory proof establishing that the applicant has had at least four

years practical experience within the seven years prior to application in the installation of oil-burning equipment under the direct and continuing supervision of a Class A-licensed oil-burning equipment installer in the city, including at least one year experience in the installation of oil-burning equipment for the use of number five and number six fuel oils.

§28-412.3.2 Experience for class B license. All applicants for a class B oil-burning equipment installer license shall submit satisfactory proof establishing that the applicant has had at least three years practical experience within the five years prior to application in the installation of oil-burning equipment under the direct and continuing supervision of a licensed oil-burning equipment installer in the city.

§28-412.4 Fitness to perform work. As a condition of license renewal, a licensed oil burning equipment installer shall provide evidence satisfactory to the department that such licensee is fit to perform the work.

#### ARTICLE 413 HIGH-PRESSURE BOILER OPERATING ENGINEER LICENSE

§28-413.1 High-pressure boiler operating engineer license required. It shall be unlawful to operate any high-pressure steam boiler for any purpose whatsoever, in the city of New York or in connection with any vessel on the waters in and around the city not subject to the jurisdiction of the United States, unless such boiler is operated by or under the direct and continuing supervision and in the presence of a person having a high-pressure boiler operating engineer license under the provisions of this article.

§28-413.2 Qualifications. Applicants for a high-pressure boiler operating engineer license shall present satisfactory proof that:

1. Applicant was employed as a fireman, oiler, general assistant, journeyman, boiler-maker or machinist under the direct and continuing supervision of a licensed high-pressure boiler operating engineer in the city for a period of not less than five years within the seven year period preceding the date of the application; however, in lieu of the experience requirement contained in this paragraph, an

applicant for a high-pressure boiler operating engineer license who is employed in a fossil fuel production plant located in the Rockaway Peninsula area of Queens county may submit satisfactory proof establishing that the applicant has obtained at least five years experience within the seven years preceding the date of the application which shall include at least two years of experience obtained during employment under the direct and continuing supervision of a licensed high-pressure boiler operating engineer in a steam generating plant located outside of the city of New York but within the state of New York that is owned and operated by a licensed public utility company, and shall also include a separate period of at least three years of experience obtained during employment as a fireman, oiler, general assistant, journeyman, boiler-maker or any comparable position as approved by the commissioner, in such steam generating plant;

2. Applicant received a degree in mechanical engineering from an accredited school or college and had one year experience in the operation and maintenance of high-pressure boilers under the direct and continuing supervision of a licensed high-pressure boiler operating engineer in the city within the two year period preceding the date of the application;

3. Applicant has held, for a minimum of four years, a certificate as an engineer issued by a board of examining engineers duly established and qualified pursuant to the laws of the United States or any state or territory thereof, or a certificate as a marine engineer issued by the United States Coast Guard, and a minimum of one year experience in the city in the operation and maintenance of stationary high-pressure boiler plants under the direct and continuing supervision of a licensed high-pressure boiler operating engineer within the seven years preceding the date of the application, provided that the applicant shall have filed with such application a signed statement that the applicant is the person named in said certificate together with the supporting signed statements by three licensed high-pressure boiler operating engineers employed in the city of

New York at the time of making of such signed statements;

4. Applicant exercised direct and continuing supervision, care, operation and maintenance over a steam generating plant of a governmental building, having boilers of 150 or more horsepower, for a minimum of five years and had a minimum of one year of experience on high-pressure boilers under the direct and continuing supervision of a licensed high-pressure boiler operating engineer in the city within the seven year period preceding the date of the application; or
5. Applicant successfully completed a New York state approved apprenticeship training program of at least two years and had at least three years experience within the seven years preceding the date of the application in the operation and maintenance of high-pressure boilers in the city under the direct and continuing supervision of a licensed high-pressure boiler operating engineer.

§28-413.3 Fitness to perform work. As a condition of license renewal, a licensed high-pressure boiler operating engineer shall provide evidence satisfactory to the department that such licensee is fit to perform the work.

ARTICLE 414  
PORTABLE HIGH-PRESSURE BOILER OPERATING ENGINEER LICENSE

§28-414.1 Portable high-pressure boiler operating engineer license required. It shall be unlawful to operate a portable high-pressure steam boiler for any purpose whatsoever in the city of New York unless such boiler is operated by or under the direct and continuing supervision and in the presence of a person licensed as a portable high-pressure boiler operating engineer.

§28-414.2 Qualifications. Applicants for a portable high-pressure boiler operating engineer license shall present satisfactory proof that applicant held a basic license as a hoisting machine operator as provided in this chapter for a minimum of three years within the five year period preceding the date of the application; and served as a fireman, oiler, assistant engineer or engineer on portable high-pressure boilers for a minimum of three years within the seven year period preceding the date of the application at least one year on



portable high pressure boilers within the city under the direct and continuing supervision of a licensed portable high-pressure boiler operating engineer.

§28-414.3 Fitness to perform work. As a condition of license renewal, a licensed portable high-pressure boiler operating engineer shall provide evidence satisfactory to the department that such licensee is fit to perform the work.

ARTICLE 415  
SIGN HANGER LICENSE

§28-415.1 Sign hanger license required. It shall be unlawful to hoist or lower or to hang or attach any sign upon or on the outside of any building in the city unless such work is performed by or under the direct and continuing supervision of a person licensed as a sign hanger under the provisions of this article.

§28-415.2 Exemptions. The provisions of this article shall not apply to the following:

1. Signs not exceeding 75 square feet (7 m<sup>2</sup>) in area, measured on one face only, nor exceeding 25 pounds (11 kg) in weight;
2. Signs supported directly on the ground; or
3. Directional signs; or
4. Temporary signs erected during the construction or alteration of a building and related to such work; or
5. The erection or placing of any signs by employees of the city, any city department or other city agency.

§28-415.3 Classification. Such licenses shall be classified as follows:

1. Master sign hanger license. Authorizes the holder thereof to hoist or lower or to hang or attach any sign, irrespective of weight, upon or on the outside of any building.
2. Special sign hanger license. Authorizes the holder thereof to hoist or lower or to hang or attach any sign not exceeding one hundred fifty square feet in area, measured on one face only, nor

exceeding one thousand two hundred pounds in weight, upon or on the outside of any building.

§28-415.4 Additional qualifications. Applicants for a sign hanger license shall have the additional qualifications set forth in sections 28-415.4.1 through 28-415.4.2.

§28-415.4.1 Master sign hanger qualifications. All applicants for a master sign hanger license shall submit satisfactory proof establishing that the applicant has had at least five years practical experience in sign hanging within the seven years preceding the date of the license application under the direct and continuing supervision of a licensed master sign hanger; and the applicant shall also have a knowledge of and ability to read plans and specifications relating to sign construction and erection, including supporting framework and other supports, and a knowledge of the problems and practices of sign construction and hanging and be familiar with the equipment and tools used in sign hanging.

§28-415.4.2 Special sign hanger qualifications. All applicants for a special sign hanger license shall submit satisfactory proof establishing that the applicant has had at least three years practical experience in sign hanging within the five years preceding the date of the license application under the direct and continuing supervision of a licensed sign hanger; and the applicant shall also have a knowledge and ability to read plans and specifications relating to sign construction and erection, including supporting framework and other supports, and a knowledge of the problems and practices of sign construction and hanging and be familiar with the equipment and tools used in sign hanging.

§28-415.5 Additional requirements. The additional requirements set forth in sections 28-415.5.1 through 28-415.5.2 shall apply to sign hangers:

§28-415.5.1 Danger warning. Every licensed sign hanger shall, while sign hanging operations are in progress at a job site, place conspicuously at such job site two plates or signs not less than 18 inches (457 mm) by 24 inches (610 mm) in size (i) displaying the word “danger” in letters not less than 6 inches (152 mm) high, and (ii) disclosing the sign hanger’s name, business address, type of license

and license number.

§28-415.5.2 Sign hanger place of business. Every licensed sign hanger shall have a place of business within the city and shall display prominently at such place of business a plate or sign marked with the words “sign hanger” and the license number immediately thereunder.

§28-415.6 Fitness to perform work. As a condition of license renewal, a licensed sign hanger shall provide evidence satisfactory to the department that such licensee is fit to perform the work.

ARTICLE 416  
FILING REPRESENTATIVE REGISTRATION

§28-416.1 Filing representative registration required. No person shall use the term “registered filing representative” or “filing representative” or any similar representation in such manner as to convey the impression that such person is a registered filing representative in accordance with the provisions of this article; nor shall any person present, submit, furnish or seek approval of applications or construction documents, or remove any documents from the possession of the department, without first having registered with the department such person’s name, address and company affiliation on a form to be furnished by the department.

§28-416.2 Exemptions. The following persons are exempt from the provisions of this article:

1. The owners of the premises for which the building applications are filed including, in the case of partnerships or corporations, the general partners or the principal officers of the corporation, where the principal officers of a corporation shall include the president, vice presidents, secretary and treasurer;
2. The lessees of such premises authorized by the owner to file building applications;
3. Condominium unit owners authorized by the condominium board of managers to file building applications;
4. Cooperative shareholders authorized by the cooperative board of directors to file building

applications;

5. Architects;

6. Engineers;

7. Attorneys admitted to practice in New York state;

8. Master plumbers licensed pursuant to this chapter;

9. Master fire suppression piping contractors licensed pursuant to this chapter; and

10. Master electricians licensed pursuant to subchapter one of chapter 3 of title 27 of the administrative code.

§28-416.3 Rules. The commissioner shall promulgate rules for the proper and efficient administration and enforcement of this article. Unless required by rule, a registered filing representative shall not be required to take an examination or to complete continuing education courses as a condition for renewal of the registration.

#### ARTICLE 417 BOARDS

§28-417.1 Plumbing and fire suppression piping contractor license board. The commissioner shall appoint annually and may remove in his or her discretion each member of a plumbing and fire suppression piping contractor license board that shall have as its purpose the following:

1. To advise the commissioner regarding the character and fitness of applicants for certificates of competence and licenses who have passed the required examination.
2. To advise the commissioner regarding allegations of illegal practices on the part of licensed master plumbers, licensed master fire suppression piping contractors, master plumber businesses or master fire suppression piping businesses.
3. To advise the commissioner regarding plumbing and fire suppression piping practices, code applications, regulations and legislation.

4. To perform such other responsibilities as may be requested by the commissioner and as set forth in rules promulgated by the department.

§28-417.1.1 Removal. The commissioner may remove any member of the license board and shall fill any vacancy therein.

§28-417.1.2 Membership. Membership of the board shall consist of:

1. Two officers or employees of the department;
2. Five licensed master plumbers, three of whom shall be selected from nominees of the New York city contracting plumbing association whose members perform the largest dollar value of work within the city and one of whom shall be the holder of a class A or class B master fire suppression piping contractor license. The two remaining licensed master plumber board member positions shall be from the next largest plumbing association in the city of New York.
3. Two licensed master fire suppression piping contractors, both of whom shall hold a class A license and shall be selected from nominees of the New York city sprinkler/fire suppression piping contractors association whose members perform the largest dollar value of work within the city;
4. A registered journeyman plumber from the organization representing the largest number of registered journeyman plumbers;
5. A registered journeyman fire suppression piping installer from the organization representing the largest number of registered journeyman fire suppression piping installers;
6. An engineer having at least five years experience in the design of plumbing systems;
7. An architect;
8. An engineer who is a full member of the society of fire protection engineers;

9. Two officers or employees of the fire department representing the fire commissioner; and

10. A real estate owner or manager or representative thereof.

§28-417.1.3 Organization of the board. A member of the board who is an officer or employee of the department representing the commissioner shall serve as chairperson and all members shall serve without compensation. Nine members including the chairperson, who shall be entitled to vote, shall constitute a quorum of the board for the transaction of business. All actions shall be conducted by majority vote except as otherwise provided, and the board shall keep minutes of its proceedings and records of its investigations. The board shall meet at least once a month except during the months of July and August, and at such other times upon call of the chairperson.

§28-417.1.4 Advisory and support personnel. The board may request the commissioner to appoint duly authorized representatives to conduct investigations and other activities incidental to the functions of the license board. Such appointees shall be non-voting members of the committee to which they are appointed, and may include personnel who are not department employees who shall serve without compensation. In addition the commissioner may designate such employees of the department as the commissioner deems necessary to the service and support of the license board.

CHAPTER 5  
SPECIAL PROVISIONS RELATING TO REGULATION OF OUTDOOR SIGNS

ARTICLE 501  
MAINTENANCE PERMIT FOR OUTDOOR SIGNS

§28-501.1 Permit required. The commissioner may, in his or her discretion, when necessary in the public interest, establish a permit requirement for signs maintained in the areas described in this article in accordance with the provisions of this article and the rules of the department. On and after a date to be provided by the rules establishing such a permit requirement, and subject to the provisions of section 28-501.6 of this code, it shall be unlawful to place or maintain a sign, as defined in section 12-10 of the

zoning resolution, on any building or premises unless a permit for the maintenance of such sign has been issued by the department pursuant to this article if such sign is within a distance of nine hundred linear feet from and within view of an arterial highway or within a distance of 200 linear feet (60 960 mm) from and within view of a public park with an area of one half acre or more.

§28-501.1.1 Other permits notwithstanding. Where a sign maintenance permit has been established by the commissioner pursuant to section 28-501.1 such permit shall be required for all signs maintained in the areas described in such section 28-501.1 and not otherwise excluded under section 28-501.6, whether or not a work permit is required and/or has been issued for the installation, alteration or erection of such sign pursuant to chapter 1 of this title.

§28-501.1.2 Arterial highway. For the purposes of this article, the term arterial highway shall include all highways that are shown on the master plan of arterial highways and major streets as principal routes parkways or toll crossings and that have been designated by the city planning commission as arterial highways to which the provisions of sections 42-55 and 32-66 of the zoning resolution shall apply as shown in appendix C of the zoning resolution.

§28-501.2 Application. Application for a permit or for the renewal of a permit shall be made on forms to be furnished by the department and shall contain such information as the department shall prescribe. Except as otherwise provided in section 28-501.3, a permit shall remain in effect for a period to be determined by rule and may be renewed. The fee for a permit or for its renewal shall be established by rule. The identification number of the permit shall be displayed on the sign or on the building or premises on which the sign is located or both, in a manner to be provided by rule.

§28-501.3 Permit expiration. A permit issued pursuant to this article shall expire and be of no further force or effect where:

1. In the case of a sign which is accessory to a principal use within the meaning of section 12-10 of

the zoning resolution, there has been a discontinuance of the operation of the principal use to which such sign is accessory, or in the event the sign is no longer in the same ownership as such principal use or is no longer operated and maintained substantially for the benefit or convenience of the owners, occupants, employees, customers or visitors of the principal use;

2. In the case of any sign for which a permit has been issued pursuant to this article, whether or not accessory to a principal use within the meaning of section 12-10 of the zoning resolution, there has been a change in copy which the commissioner has determined renders such sign no longer in compliance with the zoning resolution. The commissioner shall prescribe by rule procedures for the notification to the department concerning changes in copy which have been made on signs for which permits have been issued under this article. Nothing herein shall be construed as limiting the ability of any person to apply for a new permit pursuant to this article.

§28-501.4 Civil penalties. Any person who places or maintains a sign on a building or premises without an appropriate permit in violation of this article shall be liable for a civil penalty of, for a first violation, not more than fifteen thousand dollars and, for a second or subsequent violation, not more than twenty-five thousand dollars. Each day's continuance shall be a separate and distinct violation. Such civil penalties may be recovered in an action in any court of appropriate jurisdiction or in a proceeding before the environmental control board. Such board shall have the power to impose the civil penalties provided for in this article. Notwithstanding the provisions of section six hundred sixty-six of the charter, a notice of violation issued by the department pursuant to this section 28-501.4 shall not be subject to review by the board of standards and appeals.

§28-501.5 Construction. This chapter shall not be construed to grant the right to place or maintain a sign on any building or premises where the placement or maintenance of such sign would otherwise be prohibited pursuant to the zoning resolution, the administrative code or any other provision of law. No



permit for a sign issued hereunder shall be deemed to constitute permission or authorization to maintain a sign which is unlawful pursuant to any other provisions of law nor shall any permit issued hereunder constitute a defense in an action or proceeding with respect to such an unlawful sign.

§28-501.6 Exemption. The provisions of this article shall not apply to:

1. Signs with a surface area of 200 square feet (19 m<sup>2</sup>) or less that are located no higher than 3 feet (914 mm) above the floor of the second story of the building on which the sign is located; and
2. Signs under the control of an outdoor advertising company and included on a certified list of signs, sign structures, and sign locations under the control of such company required to be filed with the department pursuant to this chapter.

## ARTICLE 502 OUTDOOR ADVERTISING COMPANIES

§28-502.1 Definitions. As used in this chapter, the following terms shall have the following meanings:

AFFILIATE. An outdoor advertising company having a controlling interest in another outdoor advertising company or in which such other outdoor advertising company has a controlling interest. In addition, where a person or entity has controlling interests in two or more outdoor advertising companies, such outdoor advertising companies shall be considered affiliates of each other. A “controlling interest” means actual working control, in whatever manner exercised, including without limitation, control through ownership, management, debt instruments or negative control, as the case may be, as defined in rules of the department.

OUTDOOR ADVERTISING COMPANY. A person, corporation, partnership or other business entity that as a part of the regular conduct of its business engages in or, by way of advertising, promotions or other methods, holds itself out as engaging in the outdoor advertising business.

OUTDOOR ADVERTISING BUSINESS. The business of selling, leasing, marketing, managing, or otherwise either directly or indirectly making space on signs situated on buildings and premises within the

city of New York available to others for advertising purposes, whether such advertising directs attention to a business, profession, commodity, service or entertainment conducted, sold, or offered on the same or a different zoning lot and whether such sign is classified as an advertising sign pursuant to section 12-10 of the zoning resolution.

SIGN. A sign as defined in section 12-10 of the zoning resolution except that such term shall not include any sign subject to regulation by the department of transportation.

SIGN LOCATION. A building or premises on which an outdoor advertising company is entitled to sell, lease, market, manage or otherwise either directly or indirectly make space on signs available to customers, irrespective of whether a sign exists on such building or premises.

UNDER THE CONTROL OF AN OUTDOOR ADVERTISING COMPANY in reference to a sign, sign structure, or sign location. That space on such sign, sign structure, or at such sign location that is sold, leased, marketed, managed or otherwise either directly or indirectly made available to others for any purposes by such outdoor advertising company.

§28-502.2 Registration of outdoor advertising companies. On and after a date to be provided by rule, it shall be unlawful for an outdoor advertising company to engage in the outdoor advertising business or, by way of advertising, promotions or other methods, hold itself out as engaging in the outdoor advertising business unless such company is registered in accordance with this code and the rules of the department. Such rules shall establish a procedure pursuant to which the department may require the single registration of an outdoor advertising company and its affiliates. An outdoor advertising company and its affiliates made subject to single registration shall be considered a single outdoor advertising company for purposes of this code.

§28-502.2.1 Application. Application for registration or the renewal of registration shall be made on forms to be furnished by the department, may be made through electronic means, and shall contain

such information as the department shall prescribe. Registration shall remain in force for two years and may be renewed. The fee for such registration and for the renewal of such registration shall be established by rule and may be based on the number of signs in the registered inventory.

§28-502.2.2 Security. Each outdoor advertising company shall post a bond or provide another form of security to the city in an amount to be determined by the department by rule to cover:

1. All costs incurred by the city pursuant to this code for painting over, covering, rendering ineffective or for the removal and storage of an illegal sign or sign structure under the control of such outdoor advertising company; and
2. All fines or civil penalties imposed against such company pursuant to this chapter.

§28-502.3 Revocation or suspension or registration. The department may revoke, suspend or refuse to renew the registration of an outdoor advertising company or impose fines or other penalties where it is determined by the commissioner, after notice and the opportunity to be heard, that (i) such company has made statements that it knew or should have known are false in any application or certification filed with the department, (ii) such company has failed to comply with section 28-502.3 of this code or the rules adopted pursuant to its provisions by failing to file a listing of signs, sign structures and sign locations under its control as specified in such section within the time and in the manner required by department rules or by filing an incomplete listing of signs, sign structures and sign locations under its control as specified in such section, (iii) such company has been found liable for or has admitted to violations of the zoning resolution under section 28-502.5 of this code committed on three or more occasions within a 36 month period, where such violations relate to the erection, maintenance, attachment, affixing, painting or representation in any other manner on a building or premises of advertising signs, as defined in section 12-10 of the zoning resolution, at locations where the display of such advertising signs is not permitted under the zoning resolution or at locations where the display of such advertising signs violates the size,

height, or illumination provisions of the zoning resolution, and such signs are located within a distance of nine hundred linear feet from and within view of an arterial highway or within 200 linear feet (60 960 mm) from and within view of a public park with an area of one half acre or more, (iv) such company has failed to pay any civil penalties imposed or amounts owed to the city pursuant to section 28-502.5 of this code or, (v) such company has violated the department's rules pertaining to outdoor advertising companies. No application for registration by an outdoor advertising company or any affiliate thereof shall be accepted for filing by the department for a period of five years after revocation of or the refusal to renew the registration of such outdoor advertising company pursuant to this code. The department shall not accept or process any applications for permits to install, erect or alter signs pursuant to this code or for the maintenance of signs pursuant to section 28-501.1 of this code where such applications are filed by or where such signs are under the control of an outdoor advertising company or any affiliate thereof after the registration of such outdoor advertising company has been revoked or not renewed or during the term of any period of suspension of such registration. The commissioner may settle any proceeding in which the revocation, suspension or renewal of an outdoor advertising company's registration is at issue upon such terms and conditions as he or she may deem appropriate including but not limited to the agreement of an outdoor advertising company to remove signs along with supporting sign structures as a condition for the dismissal of such proceeding.

§28-502.4 Reporting requirement. An outdoor advertising company shall provide the department with a list with the location of signs, sign structures and sign locations under the control of such outdoor advertising company in accordance with the following provisions:

1. The list shall include all signs, sign structures and sign locations located (i) within a distance of 900 linear feet (274 m) from and within view of an arterial highway; or (ii) within a distance of 200 linear feet (60 960 mm) from and within view of a public park with an area of ½ acre (5000

m) or more.

2. The commissioner may, by rule, expand the scope of such list to include the reporting of other signs, sign structures and sign locations, as specified in such rule.

§28-502.4.1 Form of list. The list shall be in such form, containing such information and filed at such periodic intervals or upon such other conditions, as the department shall prescribe by rule.

§28-502.4.2 Other required information. Such list shall also indicate the work permit identification numbers for the erection, alteration or installation of such signs pursuant to chapter 1 of this title and for the maintenance of such signs pursuant to article 501, unless a permit is not required pursuant to such provisions, as well as the name and license number of the master or special sign hanger who hung or erected each such sign.

§28-502.4.3 Certification of list. Such list shall be accompanied by (i) a certification by an architect or engineer, co-signed by a responsible officer of the outdoor advertising company, that all signs reported on such list are in compliance with the zoning resolution; (ii) copies of proof that the sign complies with the zoning resolution and a certification by the sign's owner that to the best of the certifier's knowledge and belief the information provided is accurate, or (iii) a written opinion by the department, stating that the sign to which the opinion refers complies with the zoning resolution.

Notwithstanding any inconsistent provision of this code, where, in accordance with the department's rules, the department renders an opinion, determination or decision relating to whether a sign is non-conforming or whether it is located in proximity to an arterial highway as defined by the zoning resolution, such decision, determination or opinion will be appealable to the board of standards and appeals in accordance with applicable law. If a timely appeal to such board is taken, the department shall not issue a notice of violation with respect to such sign pending a determination of such appeal by such board.

§28-502.4.4 Public access to list. The commissioner shall make all listings filed pursuant to this article accessible to the public.

§28-502.5 Display of name and registration number of outdoor advertising company. On and after a date to be prescribed by rule, the commissioner shall require that each outdoor advertising company display, in a manner to be provided by rule, on each sign under its control or on the building or premises where each sign under its control is located or both, (i) the name and registration number of such company and, (ii) unless a permit is not required, the work permit identification number for the installation, alteration or erection of the sign pursuant to chapter 1 of this code and, if applicable, for the maintenance of the sign pursuant to article 501.

§28-502.6 Criminal and civil penalties. Outdoor advertising companies that violate the zoning resolution, this code, the 1968 building code or rules of the department shall be subject to criminal and civil penalties in accordance with this article.

§28-502.6.1 General. Notwithstanding any other provision of law, an outdoor advertising company shall be liable for a civil penalty in accordance with this article if a sign under its control has been erected, maintained, attached, affixed, painted on, or in any other manner represented on a building or premises in violation of any provision of the zoning resolution, this code, the 1968 building code or rules adopted pursuant thereto relating to signs.

§28-502.6.2 Unlawful for outdoor advertising company to sell space on illegal sign. It shall be unlawful for an outdoor advertising company to sell, lease, market, manage or otherwise make available to others for advertising purposes space on a sign that has been erected, maintained, attached, affixed, painted on or in any other manner represented on a building or premises in violation of any provision of the zoning resolution, this code, the 1968 building code or rules adopted pursuant thereto or to enter into any agreement for such purpose.

§28-502.6.3 Unlawful to transfer sign to unregistered outdoor advertising company. On and after a date to be provided by rule, it shall be unlawful for an outdoor advertising company to sell or otherwise transfer control of a sign or sign location or of any right of such company to sell, lease, market, manage or otherwise make space on a sign or at a sign location available to others for advertising purposes to an outdoor advertising company that is not registered in accordance with this article and the rules of the department.

§28-502.6.4 Civil penalty. An outdoor advertising company that violates any of the provisions of this article shall be subject to a civil penalty of, for a first violation, not more than fifteen thousand dollars and, for a second or subsequent violation, not more than twenty-five thousand dollars. Each day's continuance shall be a separate and distinct violation.

§28-502.6.5 Criminal penalty. Notwithstanding any inconsistent provision of law, an outdoor advertising company shall, upon being found guilty, be subject to fines or imprisonment or both pursuant to this code if a sign under its control has been erected, maintained, attached, affixed, painted on, or in any other manner represented on a building or premises in violation of any provision of the zoning resolution, this code, the 1968 building code or rules adopted pursuant thereto relating to signs.

§28-502.6.6 Activity by unregistered company. On and after a date to be provided by rule, an outdoor advertising company that engages in the outdoor advertising business or, by way of advertisement, promotion or other methods holds itself out as engaging in the outdoor advertising business without registering with the department pursuant to this chapter, or, after such registration has been revoked or not renewed pursuant to this code continues to engage in such business beyond a date specified by the commissioner in his or her determination to revoke or not renew, shall be guilty of a misdemeanor subject to a fine not to exceed five thousand dollars or a sentence of imprisonment of not more than one year or both such fine and imprisonment for each offense. In the case of a continuing violation

each day's continuance shall be a separate and distinct violation. Such company shall also be liable for a civil penalty of, for a first violation, not more than fifteen thousand dollars and, for a second or subsequent violation, not more than twenty-five thousand dollars. Each day's continuance shall be a separate and distinct violation.

§28-502.6.7 Venue. Civil penalties may be recovered in an action in any court of appropriate jurisdiction or in a proceeding before the environmental control board. Such board shall have the power to impose the civil penalties provided for in this article. Notwithstanding the provisions of section six hundred sixty-six of the charter, a notice of violation issued by the department pursuant to this article shall not be subject to review by the board of standards and appeals.

§28-502.7 Signs under control of unregistered outdoor advertising company are public nuisance. On and after a date to be provided by rule, it shall be unlawful to erect, maintain, attach, affix, paint on, or in any other manner represent on a building or premises any sign that is under the control of an unregistered outdoor advertising company. In addition to or as an alternative to any other remedies or penalties provided under any other provision of law, the commissioner may commence a proceeding for the removal of such sign or its sign structure or both in accordance with the procedures set forth in this code for the abatement of a nuisance and any such sign and its sign structure is hereby declared to be a public nuisance pursuant thereto. All of the provisions of article 503 of this chapter shall apply to the removal of a sign pursuant to this article except that a sign under the control of an unregistered outdoor advertising company may be removed whether or not it is in compliance with the zoning resolution, this code, the 1968 building code or rules adopted pursuant thereto, and irrespective of whether it has a surface area greater than 200 square feet (19 m<sup>2</sup>).

§28-502.8 Franchise or concession disqualification. Notwithstanding any other provision of law to the contrary, an outdoor advertising company, or any affiliate thereof, that has been found guilty of a



misdemeanor or liable for a civil penalty pursuant to this article or whose registration has been revoked shall be considered ineligible for the award of any city franchise or concession, and shall be prohibited from administering any advertising program on behalf of a city franchisee or concessionaire, for a period of five years following judgment or decision.

§28-502.9 Investigations. The department may investigate any matter within the jurisdiction conferred by this chapter and shall have full power to compel the attendance, examine and take testimony under oath of such persons as it may deem necessary in relation to such investigation, and to require the production of books, accounts, papers and other evidence relevant to such investigation. The department of investigation may, at the request of the commissioner, assist the department in any investigation conducted pursuant to this article.

#### ARTICLE 503 NUISANCE ABATEMENT FOR ILLEGAL SIGNS

§28-503.1 General. A sign with a surface area greater than 200 square feet (19 m<sup>2</sup>) that is erected, maintained, attached, affixed, painted on, or in any other manner represented on a building or premises in violation of the zoning resolution, this code, the 1968 building code or rules adopted pursuant thereto is hereby declared to be a public nuisance. The commissioner may, after notice and hearing, order the removal of such illegal sign or its sign structure or both, as hereinafter provided.

§28-503.2 Notice. The commissioner shall serve a notice of hearing with regard to the proposed nuisance abatement on the owner and mortgagee of record of the building or premises and other persons having a recorded interest in the property in the manner provided in article 212 of chapter 2 of this title for the service of an order of closure. If the sign is under the control of an outdoor advertising company and an address for such company is reasonably ascertainable, the notice shall also be served on such outdoor advertising company by mail to the last known address for such company or, if such company is

registered in accordance with section 28-502.2, at the address provided to the department by the registrant.

§28-503.3 Hearing. The office of administrative trials and hearings shall conduct the hearing. The administrative law judge assigned to hear the matter shall submit his or her proposed findings of fact and recommended disposition to the commissioner. If based on such recommended disposition, proposed findings of fact and the record of the hearing the commissioner determines (i) that the sign has a surface area greater than 200 square feet (19 m<sup>2</sup>) and, (ii) that the sign has been erected, maintained, attached, affixed, painted on, or in any other manner represented on the building or premises in violation of the zoning resolution, this code, the 1968 building code or rules adopted pursuant thereto, he or she may order the removal of the illegal sign or its sign structure or both.

§28-503.3.1 Lack of knowledge no defense. At such hearing it shall not be a defense that an owner or other person having an interest in the property lacked knowledge of or did not participate in the erection or maintenance of the illegal sign.

§28-503.4 Posting of order. The commissioner's order of removal shall be posted, mailed and filed in the manner provided in this code for an order of closure.

§28-503.5 Enforcement of order. On or after the tenth business day after the posting of such order and upon the written directive of the commissioner, police officers and authorized representatives of the department shall act upon and enforce such order by removing, covering, painting over or otherwise rendering ineffective the illegal sign or its sign structure or both. Such work shall at all times be performed by a licensed sign hanger where required by law. Nothing in this article shall be construed to prohibit an owner or other person having an interest in the property from removing or causing the removal of an illegal sign or its sign structure prior to the arrival of such enforcement officers. On and after the posting of such removal order, no further permits for signs shall be issued for such building or premises

pursuant to this code and, if the sign structure is not removed, no further display shall be exhibited on such sign structure unless and until the commissioner rescinds such order.

§28-503.6 Rescission of order. The commissioner may rescind the order if the owner or other person having an interest in the building or premises provides assurance in a form satisfactory to the commissioner that all signs erected or maintained at such building or premises will be in compliance with the zoning resolution, this code, the 1968 building code or rules adopted pursuant to such provisions. If such order is rescinded, the commissioner shall, upon request of such owner, mortgagee or other person, provide a certified copy of such rescission which may be filed with the county clerk or register of the county in which such building or premises is located.

§28-503.7 Costs. The costs and expenses for painting over, covering, rendering ineffective or for the removal and storage of such sign and its sign structure may be recovered from the owner of the premises or, if the illegal sign is under the control of an outdoor advertising company and notice was served on such company in accordance with this article, from such outdoor advertising company. Such amounts may be recovered by the city in an action or proceeding in any court of appropriate jurisdiction and, with respect to amounts owed by an outdoor advertising company, by drawing upon any bond posted or other security provided by such company pursuant to section 28-502.2. Nothing in this article shall be construed to limit the ability of an owner to seek recovery of such costs and expenses from any other party.

§28-503.8 Lien. In addition, such costs and expenses shall constitute a lien on the land and building on which the sign was located which may be entered and enforced pursuant to the provisions of this code in the same manner as an unpaid fee.

§28-503.9 Storage and disposal. The commissioner shall adopt rules to provide for the storage and disposal of any sign or sign structure removed pursuant to this article. If the identity and address of the

owner of such property is reasonably ascertainable, notice of the removal shall be sent to the owner within a reasonable period of time after the removal. If such property is not claimed within thirty days after its removal, it shall be deemed to be abandoned and may be sold at a public auction after having been advertised in the City Record and the proceeds paid into the general fund or if the commissioner determines that the property is not saleable, he or she may turn over such property to the department of sanitation for disposal. Property removed pursuant to this article shall be released to the owner or other person lawfully entitled to possession upon payment of the costs of removal and storage as set forth in the rules of the department and any fines or civil penalties imposed for the violation or, if an action or proceeding for the violation is pending in court or before the environmental control board, upon the posting of a bond or other form of security acceptable to the department in an amount which will secure the payment of such costs and any fines or civil penalties which may be imposed for the violation.

§28-503.10 Definitions. For the purposes of this article the terms “sign” and “surface area,” in reference to a sign, shall be as defined under section 12-10 of the zoning resolution.

§28-503.11 Review of order. An order of the commissioner issued pursuant to this article shall be a final determination of the commissioner for purposes of review pursuant to article seventy-eight of the civil practice law and rules. Notwithstanding any inconsistent provision of paragraph (a) of subdivision six of section six hundred sixty-six of the New York city charter, such order shall not be subject to review by the board of standards and appeals.

§12. The title of chapter 4 of title 28 of the administrative code of the city of New York, as added by local law number 99 for the year 2005, is amended to read as follows:

CHAPTER [4] 6

THE NEW YORK CITY PLUMBING CODE

§13. The title to section 401 of the administrative code of the city of New York, as added by local law number 99 for the year 2005, is amended to read as follows:

[SECTION 401] ARTICLE 601

ENACTMENT AND UPDATE OF THE NEW YORK CITY PLUMBING CODE

§14. Sections 28-401.1 and 28-401.2 of the administrative code of the city of New York, as added by local law number 99 for the year 2005, are renumbered to be sections 28-601.1 and 28-601.2.

§15. Chapters 5, 6, 7 and 8 of title 28 of the administrative code of the city of New York, as added by local law number 99 for the year 2005, are REPEALED.

§16. Title 28 of the administrative code of the city of New York is amended by adding a new chapter 7 to read as follows:

CHAPTER 7

THE NEW YORK CITY BUILDING CODE

ARTICLE 701

ENACTMENT AND UPDATE OF THE NEW YORK CITY BUILDING CODE

§28-701.1 Update. No later than the third year after the effective date of this section 701.1 and every third year thereafter, the commissioner shall submit to the city council proposed amendments that he or she determines should be made to this code to bring it up to date with the latest edition of the International Building Code or otherwise modify the provisions thereof. In addition, prior to the submission of such proposal to the city council, such proposal shall be submitted to an advisory committee established by the commissioner pursuant to this title for review and comment.

§28-701.2 Enactment of the New York city building code. The New York city building code based on the 2003 edition of the International Building Code published by the International Code Council, with changes that reflect the unique character of the city, is hereby adopted to read as follows:

**THE NEW YORK CITY BUILDING CODE**

**CHAPTER 1**  
**ADMINISTRATION**

**CHAPTER 2**  
**DEFINITIONS**

**CHAPTER 3**  
**USE AND OCCUPANCY CLASSIFICATION**

**CHAPTER 4**  
**SPECIAL DETAILED REQUIREMENTS BASED ON USE AND OCCUPANCY**

**CHAPTER 5**  
**GENERAL BUILDING HEIGHTS AND AREAS**

**CHAPTER 6**  
**TYPES OF CONSTRUCTION**

**CHAPTER 7**  
**FIRE-RESISTANCE-RATED CONSTRUCTION**

**CHAPTER 8**  
**INTERIOR FINISHES**

**CHAPTER 9**  
**FIRE PROTECTION SYSTEMS**

**CHAPTER 10**  
**MEANS OF EGRESS**

**CHAPTER 11**  
**ACCESSIBILITY**

**CHAPTER 12**  
**INTERIOR ENVIRONMENT**

**CHAPTER 13**  
**ENERGY EFFICIENCY**

**CHAPTER 14**  
**EXTERIOR WALLS**

**CHAPTER 15**  
**ROOF ASSEMBLIES AND ROOFTOP STRUCTURES**

**CHAPTER 16**  
**STRUCTURAL DESIGN**

**CHAPTER 17**  
**STRUCTURAL TESTS AND SPECIAL INSPECTIONS**

**CHAPTER 18**  
**SOILS AND FOUNDATIONS**

**CHAPTER 19**  
**CONCRETE**

**CHAPTER 20**  
**ALUMINUM**

**CHAPTER 21**  
**MASONRY**

**CHAPTER 22**  
**STEEL**

**CHAPTER 23**  
**WOOD**

**CHAPTER 24**  
**GLASS AND GLAZING**

**CHAPTER 25**  
**GYPSUM BOARD AND PLASTER**

**CHAPTER 26**  
**PLASTIC**

**CHAPTER 27**  
**ELECTRICAL**

**CHAPTER 28**  
**MECHANICAL SYSTEMS**

**CHAPTER 29**  
**PLUMBING SYSTEMS**

**CHAPTER 30**  
**ELEVATORS AND CONVEYING SYSTEMS**

**CHAPTER 31**  
**SPECIAL CONSTRUCTION**

**CHAPTER 32**  
**ENCROACHMENTS INTO THE PUBLIC RIGHT-OF-WAY**

**CHAPTER 33**  
**SAFEGUARDS DURING CONSTRUCTION AND DEMOLITION**

**CHAPTER 34**  
**RESERVED**



**CHAPTER 35**  
**REFERENCED STANDARDS**

**APPENDIX A**  
**RESERVED**

**APPENDIX B**  
**RESERVED**

**APPENDIX C**  
**RESERVED**

**APPENDIX D**  
**FIRE DISTRICTS**

**APPENDIX E**  
**SUPPLEMENTARY ACCESSIBILITY REQUIREMENTS**

**APPENDIX F**  
**RODENT PROOFING**

**APPENDIX G**  
**FLOOD-RESISTANT CONSTRUCTION**

**APPENDIX H**  
**OUTDOOR SIGNS**

**APPENDIX I**  
**RESERVED**

**APPENDIX J**  
**RESERVED**

**APPENDIX K**  
**MODIFIED INDUSTRY STANDARDS FOR**  
**ELEVATORS AND CONVEYING SYSTEMS**

**APPENDIX L**  
**RESERVED**

**APPENDIX M**  
**SUPPLEMENTARY REQUIREMENTS FOR ONE- AND TWO-FAMILY DWELLINGS**

**APPENDIX N**  
**ASSISTIVE LISTENING SYSTEMS PERFORMANCE STANDARDS**

**APPENDIX O**  
**RESERVED**

**APPENDIX P**  
**R-2 OCCUPANCY TOILET AND BATHING FACILITIES REQUIREMENTS**

**APPENDIX Q**  
**MODIFIED NATIONAL STANDARDS FOR AUTOMATIC SPRINKLER, STANDPIPE, AND**  
**FIRE ALARM SYSTEMS**

**APPENDIX R**  
**ACOUSTICAL TILE AND LAY-IN PANEL CEILING SUSPENSION SYSTEMS**

§17. Title 28 of the administrative code of the city of New York is amended by adding a new chapter 8 to read as follows:

**CHAPTER 8**

**THE NEW YORK CITY MECHANICAL CODE**

**ARTICLE 801**

**ENACTMENT AND UPDATE OF THE NEW YORK CITY MECHANICAL CODE**

§28-801.1 Update. No later than the third year after the effective date of this section 28-801.1 and every third year thereafter, the commissioner shall submit to the city council proposed amendments that he or she determines should be made to this code to bring it up to date with the latest edition of the International Mechanical Code or otherwise modify the provisions thereof. In addition, prior to the submission of such proposal to the city council, such proposal shall be submitted to an advisory committee established by the commissioner pursuant to this title for review and comment.

§28-801.2 Enactment of the New York city mechanical code. The New York city mechanical code based on the 2003 edition of the International Mechanical Code published by the International Code Council, with changes that reflect the unique character of the city, is hereby adopted to read as follows:

### **THE NEW YORK CITY MECHANICAL CODE**

§18. Title 28 of the administrative code of the city of New York is amended by adding a new chapter 9 to read as follows:

#### **CHAPTER 9**

#### **THE NEW YORK CITY FUEL GAS CODE**

#### **ARTICLE 901**

#### **ENACTMENT AND UPDATE OF THE NEW YORK CITY FUEL GAS CODE**

§28-901.1 Update. No later than the third year after the effective date of this section 28-901.1 and every third year thereafter, the commissioner shall submit to the city council proposed amendments that he or she determines should be made to this code to bring it up to date with the latest edition of the International Fuel Gas Code or otherwise modify the provisions thereof. In addition, prior to the submission of such proposal to the city council, such proposal shall be submitted to an advisory committee established by the commissioner pursuant to this title for review and comment.

§28-901.2 Enactment of the New York city fuel gas code. The New York city fuel gas code based on the 2003 edition of the International Fuel Gas Code published by the International Code Council, with changes that reflect the unique character of the city, is hereby adopted to read as follows:

**THE NEW YORK CITY FUEL GAS CODE**

§19. All actions and proceedings, civil or criminal, commenced prior to the effective date of this local law in accordance with any provision repealed by this local law and pending immediately prior to the taking effect of such repeal may be prosecuted and defended to final effect in the same manner as they might if those provisions had not been repealed.

§20. All licenses, permits and certificates of occupancy issued prior to the effective date of this local law pursuant to any provision repealed by this local law and in force immediately prior to the taking effect of such repeal shall continue in force until they expire or are revoked as if the provisions under which they were issued had not been repealed. All renewals of such licenses and permits shall be in accordance with the provisions of title 28 of the administrative code of the city of New York as enacted by this local law.

§21. The repeal of item (vii) of paragraph b of subdivision 5 of section 1041 of the New York city charter as set forth in section one of this local law shall not affect the validity of reference standards amended, revised or added by the commissioner of buildings prior to the effective date of this local law and in force on the effective date of this local law.

§22. This local law shall take effect on July 1, 2008 except that section 10 of this local law shall take effect immediately and such section 10 shall be retroactive to and shall be deemed to be in full force and effect on and after July 1 2007. Prior to July 1, 2008 the commissioner of buildings shall take administrative actions necessary for the timely implementation of this local law, including but not limited to the promulgation of rules.



**CHAPTER 1**  
**ADMINISTRATION**

**SECTION BC 101**  
**GENERAL**

**101.1 Title.** This code shall be known and may be cited as the “New York City Building Code,” “NYCBC” or “BC”. All section numbers in this code shall be deemed to be preceded by the designation “BC”.

**101.2 Scope.** The provisions of this code shall apply to the construction, alteration, movement, addition, replacement, repair, equipment, use and occupancy, location, maintenance, removal and demolition of every building or structure or any appurtenances connected or attached to such buildings or structures.

**101.3 Intent.** Refer to Chapter 1 of Title 28 of the *Administrative Code*.

**101.4 Referenced codes.** The other codes listed in Sections 101.4.1 through 101.4.7 and referenced elsewhere in this code shall be considered part of the requirements of this code to the prescribed extent of each such reference.

**101.4.1 Electrical.** The provisions of the *New York City Electrical Code* shall apply to the installation of electrical systems, including alterations, repairs, replacement, equipment, appliances, fixtures, fittings and appurtenances thereto.

**101.4.2 Gas.** The provisions of the *New York City Fuel Gas Code* shall apply to the installation of gas piping, gas appliances and related accessories as covered in this code. These requirements apply to gas piping systems extending to the inlet connections of appliances and the installation and operation of residential and commercial gas appliances and related accessories.

**101.4.3 Mechanical.** The provisions of the *New York City Mechanical Code* shall apply to the installation, alterations, repairs and replacement of mechanical systems, including equipment, appliances, fixtures, fittings and/or appurtenances, including ventilating, heating, cooling, air-conditioning and refrigeration systems, incinerators and other energy-related systems.

**101.4.4 Plumbing.** The provisions of the *New York City Plumbing Code* shall apply to the installation, alteration, repair and replacement of plumbing systems, including equipment, appliances, fixtures, fittings and appurtenances, and where connected to a water or sewage system and all aspects of a medical gas system.

**101.4.5 Fire prevention.** The provisions of the *New York City Fire Code* shall apply to:

1. The manufacturing, storage, handling, use and transportation of flammable and combustible substances and hazardous materials, except for the

installation of storage tanks and auxiliary storage tanks for oil-burning equipment;

2. The installation, testing, operation and maintenance of devices, equipment and systems designed to prevent, mitigate, control and extinguish fire, explosions or other life safety hazards;
3. The orderly evacuation or other safe conduct of occupants of a building, structure or premises in the event of fire, explosion, biological, chemical or hazardous material incident or release, natural disaster or other emergency, or the threat thereof;
4. The prevention, mitigation and control of hazards to firefighters and emergency responders during emergency operations;
5. The inspection, testing, operation and maintenance of any automatic or other fire alarm or fire extinguishing device, equipment or system.

**101.4.6 Energy.** The provisions of the *Energy Conservation Construction Code of New York State* shall apply to all matters governing the design and construction of buildings for energy efficiency.

## **SECTION BC 102** **APPLICABILITY**

**102.1 General.** Where, in any specific case, different sections of this code specify different materials, methods of construction or other requirements, the most restrictive shall govern. Where there is a conflict between a general requirement and a specific requirement, the specific requirement shall be applicable.

**102.2 Reserved.**

**102.3 Application of references.** References to chapter or section numbers, or to provisions not specifically identified by number, shall be construed to refer to such chapter, section or provision of this code.

**102.4 Referenced standards.** The standards referenced in this code and in the rules of the department shall be considered part of the requirements of this code to the prescribed extent of each such reference. Where differences occur between provisions of this code and referenced standards, the provisions of this code shall apply. Refer to Article 103 of Chapter 1 of Title 28 of the *Administrative Code* for additional provisions relating to referenced standards.

**102.5 Partial invalidity.** In the event that any part or provision of this code is held to be illegal or void, this shall not have the effect of making void or illegal any of the other parts or provisions.

**102.6 Existing structures.** The legal occupancy of any existing structure shall be permitted to continue without change, except as is otherwise specifically provided or as is deemed necessary by the commissioner for the general safety and welfare of the occupants and the public. Refer to Chapter 1 of Title 28 of the *Administrative Code* for additional provisions relating to existing structures.

**SECTION BC 103**  
**DEPARTMENT OF BUILDINGS**

**103.1 General.** Refer to the New York City Charter and Chapter 1 of Title 28 of the *Administrative Code*.

**SECTION BC 104**  
**DUTIES AND POWERS OF COMMISSIONER OF BUILDINGS**

**104.1 General.** The commissioner shall have the authority to render interpretations and to adopt rules establishing policies, and procedures to clarify and implement the provisions of this code. Such interpretations and rules shall be in compliance with the intent and purpose of this code. Refer to the New York City Charter and Chapter 1 of Title 28 of the *Administrative Code* for additional provisions relating to the authority of the Commissioner of Buildings.

**SECTION BC 105**  
**PERMITS**

**105.1 General.** Permits shall comply with this section, with Article 105 of Chapter 1 of Title 28 of the *Administrative Code*, and with requirements found elsewhere in this code.

**105.2 Required.** Any owner or authorized agent who intends to construct, add to, alter, repair, move, demolish, or change the occupancy of a building or structure, or to erect, install, add to, alter, repair, remove, convert or replace any gas, mechanical or plumbing system, the installation of which is regulated by this code, or to cause any such work to be done, shall first make application for construction document approval in accordance with Chapter 1 of Title 28 of the *Administrative Code* and this chapter and obtain the required permit.

**105.3 Work exempt from permit.** Exemptions from permit requirements of this code as authorized in Chapter 1 of Title 28 of the *Administrative Code* and the rules of the department shall not be deemed to grant authorization for any work to be done in any manner in violation of the provisions of this code or any other laws or rules.

**105.4 Validity of permit.** The issuance or granting of a permit shall not be construed to be a permit for, or an approval of, any violation of any of the provisions of this code or of any other law. Permits presuming to give authority to violate or cancel the provisions of this code or other law shall not be valid. The issuance of a permit based on construction documents and other data shall not prevent the commissioner from requiring the



correction of errors in the construction documents and other data. The commissioner is also authorized to prevent occupancy or use of a structure where in violation of this code or of any other law.

**105.5 Foundation and earthwork permits.** In addition to the requirements of Chapter 1 of Title 28 of the *Administrative Code* and Chapter 33 of this code, applications for foundation and earthwork permits shall include:

1. Notice to adjoining owners. Proof of notice to adjoining owners as required by Section 3304.3.2.
2. Liens. Satisfactory evidence that the property is free from any lien for unpaid city taxes, assessments, water rates, bail bonds, or judgments obtained by the city, together with consent in writing of the mortgagee, if there is a mortgage upon the property, and the consent in writing of the surrogate's court or supreme court, if the owner of the property is a minor or incompetent.

**105.5.1 Notice to the department of commencement of foundation and earthwork.** The foundation and earthwork permit shall be issued on the condition that the applicant will provide written notice to the department at least 24 but no more than 48 hours prior to the commencement of the foundation or earthwork as required by Section 3304.3.1.

**105.6 Full demolition permits.** In addition to the requirements of Chapter 1 of Title 28 of the *Administrative Code* and Chapter 33 of this code, applications for full demolition permits shall include:

1. Utility certifications. Certifications by the respective utility companies or governmental agencies having jurisdiction that all gas, electric, water, steam and other service lines to the building have been disconnected as required by Section 3306.9.1.
2. Notice to adjoining owners. Proof of notice to adjoining owners as required by Section 3306.3.2.
3. Certification of rodent extermination. Certification in accordance with department rules that the building has been treated effectively for rodent extermination as required by Section 3306.9.13.

**105.6.1 Notice to department of commencement of demolition work.** The full demolition permit shall be issued on the condition that the applicant will provide written notice to the department at least 48 hours prior to the commencement of demolition work.

**105.7 Sign permits.** In addition to the requirements of Chapter 1 of Title 28, permits for the erection, alteration or installation of signs shall be subject to the special provisions set

forth in Sections 105.7.1 through 105.7.5.

**105.7.1 Identification number.** Every sign permit shall have an identification number.

**105.7.2 Changing copy or structural change of sign or sign structure.** The changing of copy on a sign not permitted for changeable copy or any structural change of the sign or sign structure shall require a new permit pursuant to this code.

**105.7.3 Permit does not constitute authorization for illegal sign.** The issuance of a permit for the erection, alteration or installation of a sign or sign structure issued pursuant to this code shall not be deemed to constitute permission or authorization to maintain a sign that would otherwise be illegal without a maintenance permit for an outdoor sign if required pursuant to this code and department rule or that is otherwise illegal pursuant to any other provision of law nor shall any permit issued hereunder constitute a defense in an action or proceeding with respect to such an unlawful sign.

**105.7.4 Name and business address of licensed sign hanger.** The application shall contain the name and business address of the licensed sign hanger who is to perform or supervise the proposed work.

**105.7.5 Outdoor advertising company.** If the sign or sign location is under the control of an outdoor advertising company, as defined in Chapter 5 of Title 28 of the *Administrative Code*, the application shall be accompanied by the name and, where provided by rule, the registration number of such outdoor advertising company.

**105.8 Temporary construction equipment permits.** In addition to the requirements of Chapter 1 of Title 28, permits for the erection, installation and use of temporary construction equipment shall be subject to the special provisions set forth in Sections 105.8.1 through 105.8.3.

**105.8.1 Application.** The need for each specific item of construction equipment shall be stated on the application.

**105.8.2 Term of permit.** Notwithstanding any other provision of this code, the term of a construction equipment permit shall be one year, or the expiration of the contractor's insurance or the street obstruction bond, if such time period is less than one year and shall be renewable. The permit must be in effect at all times during which the equipment is at the work site.

**105.8.3 Special provisions for renewal of permit for a sidewalk shed.** An application for the renewal of a construction equipment permit for a sidewalk shed used in connection with the alteration of a building shall be accompanied by a report, acceptable to the department, prepared by a registered design professional who has examined that part of the premises on which the work requiring the use of a sidewalk shed is being performed. Such report shall document the condition of the applicable

part of the premises and the scope of work that has been performed thereon since the issuance of the permit and shall provide an estimate of the additional time needed to complete the work.

**105.9 Mandatory sewer and catch basin work required by Section 24-526 of the Administrative Code.** In addition to the requirements of Chapter 1 of Title 28, an applicant for a permit who is required pursuant to Section 24-526 of the *Administrative Code* to construct or repair defects in sewers or catch basins that lie outside the property shall submit certification from the Department of Environmental Protection that the applicant or owner has provided the Department of Environmental Protection with:

1. A performance bond or other security satisfactory to the Department of Environmental Protection and approved as to form by the Law Department for the full cost, as estimated by the Department of Environmental Protection, of constructing the part of the storm water drainage system for such property which shall lie outside the property line and repairing defects in such construction, if and as required by Section 24-526 of the *Administrative Code*;
2. Any license or other written instrument that the Department of Environmental Protection or the Law Department may reasonably request that gives the Department of Environmental Protection, its agents and contractors and the surety for a performance bond described in Item 1 above the legal right to enter private property to perform the work described in Item 1 above, pursuant to the terms of the performance bond or in accordance with the conditions of acceptance of other security described in Item 1 above, and the legal right to connect to, to extend or to discharge storm water into any private sewer authorized as a point of disposal pursuant to Section 24-526 of the *Administrative Code*, in the event that the owner of property fails to do so, if and as required pursuant to Section 24-526 of the *Administrative Code*;
3. Insurance of a kind and in an amount that the Department of Environmental Protection and the Law Department deem satisfactory to insure the city fully for all risks of loss, damage to property or injury to or death of persons to whomsoever occurring, arising out of or in connection with the performance of all work described in this section.

## **SECTION BC 106** **CONSTRUCTION DOCUMENTS**

**106.1 General.** Construction documents shall comply with Chapter 1 of Title 28 of the *Administrative Code*, this section and other applicable provisions of this code and its referenced standards.

**106.2 Required construction documents.** In addition to the requirements of Chapter 1 of Title 28 of the *Administrative Code*, the applicant shall submit any and all of the documents specified in Sections 106.3 through 106.15 as appropriate to the nature and

extent of the work proposed.

**106.2.1 Composite plans.** Composite plans showing architectural, structural, and mechanical parts of a building may be submitted provided that a clear understanding of each part is not impaired.

**106.2.2 Multiple building developments.** The same set of plans may be used for several buildings of the same construction, if such buildings are located on adjoining lots under the same ownership, and if applications for construction document approval for the lots are filed simultaneously.

**106.3 Lot diagram.** The lot diagram shall show compliance with the *New York City Zoning Resolution*, indicating: the size, height, and location of the proposed construction including parking and curb cuts; all existing structures on the zoning lot and their distances from lot and street lines; the established grade and existing curb elevations; and the proposed final grade elevations of the site shown by contours or spot grades at reasonable intervals. The lot diagram shall be drawn in accordance with an accurate boundary survey to the city datum, made by a land surveyor, which shall be attached to and form part of the application. A complete zoning analysis shall accompany the lot diagram with citation to the relevant sections of the *New York City Zoning Resolution*.

**106.4 Building classification statement.** The statement shall identify:

1. The occupancy group or groups that apply to parts of the building in accordance with Section 302;
2. The occupancy group of the main use or dominant occupancy of the building in accordance with Section 302.1;
3. The construction class of the building in accordance with Section 602;
4. The structure category in accordance with Table 1604.5;
5. The height of the building as defined in Section 502.1;
6. The applicable measurements to the highest and lowest level of Fire Department access;
7. Whether the building is inside or outside of the fire districts; and
8. For multiple dwellings, the multiple dwelling classification as established by the *New York State Multiple Dwelling Law*.

**106.5 Means of egress plans.** Floor and roof plans shall show compliance with the requirements of Chapter 10, with sufficient notations indicating egress features and complete egress analysis as required by this code.

**106.6 Architectural plans.** Construction documents for all buildings shall provide detailed drawings of all architectural elements of the building showing compliance with the code, including but not limited to doors, windows and interior finish schedules, and other details necessary to substantiate all required fire-protection characteristics, as well as other details demonstrating compliance with the accessibility requirements of this code. Site safety features shall be shown where applicable. Plans shall also provide details of the exterior wall envelope as required, including flashing, intersections with dissimilar materials, corners, end details, control joints, intersections at roof, eaves or parapets, means of drainage, water-resistive membrane and details around openings.

**Exception:** Where a curtain wall system is to be employed containing elements that are normally detailed on shop or working drawings, approval of construction documents shall be conditioned upon deferred submittal of such shop or working drawings showing the approval of the registered design professional who prepared the architectural construction documents, or of a signed statement by such registered design professional that such drawings were prepared to his or her satisfaction. In such cases, submittal of construction documents showing compliance with the *Energy Conservation Construction Code of New York State* related to such curtain wall may also be deferred.

**106.7 Structural plans.** Structural plans shall include the data and information described in this section and in Chapter 16.

**Exceptions:**

1. Where structural elements are normally detailed on shop or working drawings, approval of construction documents shall be conditioned upon deferred submittal of such shop or working drawings showing the approval of the registered design professional who prepared the structural construction documents, or of a signed statement by such registered design professional that such drawings were prepared to his or her satisfaction.
2. In cases where the detailing of structural elements has been made on the basis of fire-resistance ratings, load tables, or similar data as given in manufacturer's catalogues, approval of construction documents shall be conditional upon submission of a manufacturer's designation attesting to the accuracy of the data and indicating that such data were derived in conformance with the provisions of this code. Where the detailing of structural elements has been made on the basis of data published in technical documents of recognized authority issued or accredited by the agency or association promulgating the applicable referenced standard, such manufacturer's designation will not be required.

**106.7.1 Foundation plans.** Foundation plans shall show compliance with the requirements of Chapter 18 of this code regarding foundation design and shall show

the plan locations, design elevations of the bottoms, and details as to sizes, reinforcements, and construction of all footings, piers, foundation walls, pile groups, and pile caps. The levels of footings of adjacent structures shall be indicated or, if the adjacent structures are pile supported, this shall be stated. Where applicable, the plans shall include underpinning details. In addition, there shall be a statement indicating the character and minimum class of the soil strata required for the support of the foundation; the allowable soil pressure used for the design of footings; and the character, class, and presumptive bearing capacity of the bearing stratum to which piling is required to penetrate. The types and design capacities of piling and the records of required borings or test pits shall also be shown.

**106.7.2 Floor plans.** Floor plans and sections showing all structural requirements shall be provided for all levels.

**106.7.3 Detailed drawings.** Drawings shall show sizes, sections, and locations of members, and such other information as may be required to indicate clearly all structural elements and special structural engineering features.

**106.7.4 Column schedules.** Column schedules shall show the design load contributed by the framing at any level and the total accumulated design load at each level.

**106.7.5 Truss forces.** Where trusses are employed, a diagram or table shall indicate the loads or moments in the various members under the design loading conditions. The requirement for a diagram or table may be waived when the trusses consist of elements selected from load tables or similar data, subject to the requirements for verification described in this code.

**106.7.6 Prestressing forces.** Where prestressed members are employed, a schedule or table shall show the total prestressing forces and the method and sequence of application.

**106.8 Excavation and earthwork plans.** Where the application is sought solely for earthwork excavation or fill operations, the applicant shall submit 1) a lot diagram and 2) plans showing the exact location, extent, and depth or height of the proposed excavation or fill operation and any protective railings or equipment required by Chapter 33

**106.9 Fire protection system plans.** Construction documents for fire protection systems shall include a plot plan to scale indicating the location of the system in relation to the rest of the building and shall comply with Sections 106.14.1 through 106.14.4. Such plans shall not be required in connection with applications for limited standpipe alterations and limited sprinkler alterations.

**106.9.1 Sprinkler systems.** Sprinkler systems plans shall comply with Section 903.1.2.

**106.9.2 Alternative automatic fire-extinguishing systems.** Alternative automatic fire-extinguishing systems plans shall comply with Section 904.1.1.

**106.9.3 Standpipe systems.** Standpipe systems plans shall comply with Section 905.1.1.

**106.9.4 Fire alarm and detection systems.** Fire alarm and detection systems plans shall comply with Section 907.1.1.

**106.10 Sign installation plans.** Construction documents for signs applications shall comply with Section H105.2 in Appendix H.

**106.11 Sewer adequacy verification for increases in impervious surfaces.** Whenever an alteration increases impervious surfaces on the lot to greater than 20 percent of the impervious surfaces existing when the structure was constructed, the applicant shall submit information as to the availability of a public sewer system, as well as the adequacy of any existing system for the disposal of storm water by any means other than storm or combined sewers.

**Exception:** Where the total area of impervious surfaces proposed to be increased after the effective date of this code is less than or equal to 1,000 square feet (93 m<sup>2</sup>).

**106.12 Pre-demolition photographs.** In addition to the requirements of Section 3306.3, construction documents for full demolition shall comply with the following requirements for archival photographs:

1. Number required. Applications shall contain two sets of photographs of the building or buildings to be demolished or removed. Both sets shall be received by the department on behalf of the New York City Landmarks Preservation Commission and the New York City Municipal Archives Division of the Department of Records and Information Services.
2. Format. The photographs shall conform to the standards and specifications established by rules promulgated by the commissioner upon the advice of the commissioner of the Department of Records and Information Services and the chairperson of the Landmarks Preservation Commission.

**Exceptions:** Applications made on behalf of the Department of Housing Preservation and Development or made pursuant to Article 215 of chapter 2 of title 28 of the *Administrative Code* are exempt from the requirements of this section.

**106.13 Energy efficiency.** Construction documents shall include a statement by the registered design professional of record that: “To the best of my knowledge, belief and professional judgment, these plans and specifications are in compliance with the *Energy Conservation Construction Code of New York State*.” In addition, the following requirements shall apply:

1. A lead energy professional shall be identified for each project, who shall draw the relevant information regarding envelope, mechanical systems, service water heating system and lighting and power systems from construction documents into an energy analysis. The energy analysis shall balance total energy consumption of all systems in accordance with the *Energy Conservation Construction Code of New York State* and shall be signed and sealed by the lead energy professional.
2. The format for the energy analysis shall be as established in the *Energy Conservation Construction Code of New York State*, or as approved by the department, and shall comprise a sheet within the drawing set. Supporting documentation shall be available within the drawing set or upon request of the department.

**106.14 Mechanical and fuel gas plans.** Construction documents for gas piping, heating, ventilation, refrigeration and other mechanical work to be performed shall be submitted as per *New York City Mechanical and Fuel Gas Codes*.

**106.15 Plumbing plans.** Construction documents for plumbing work shall contain plans that include the following data and information. Such plans shall not be required in connection with applications for limited plumbing alterations.

1. Riser diagrams showing the story heights, all plumbing fixtures with diagrammatic arrangement of their connections to soil, waste, and vent piping, all soil, waste, and vent stacks from the point of connection with the building drain to their termination above the roof, all leader and storm water piping from the point of connection with the building drain to the roof drain, and all risers.
2. Diagrammatic floor plans showing the location, layout, and spacing of all plumbing fixtures, the summation of plumbing loads, the size, location, and material for all building sewers and drains, and the soil, waste, vent, water, and gas distribution piping.
3. Floor plans showing typical layouts; and stack details shown on one drawing, provided that such details are clearly identified as to location and stack number.
4. Plans clearly indicating all appurtenant equipment, including, but not limited to, pumps, ejectors, water tanks, and piping.
5. In the case of plans for new plumbing systems, and alterations of existing plumbing systems, plans indicating:
  - 5.1. The relative elevation of the lowest fixture referred to the city datum provided in Section 28-104.7.6 of the *Administrative Code* and the approximate inside top of the public sewers;



- 5.2. The number, size, and location of all proposed sewer connections and relative location and size of all water mains, leaders, and risers; and
- 5.3. A statement from the New York City Department of Environmental Protection, giving the minimum water pressure in the main serving the building.
6. Seismic protection and restraint details for piping and equipment as required by Chapter 16 of the *New York City Building Code*.
7. Details showing structural supports for water tanks where required.
8. In areas of special flood hazards, construction documents shall comply with Appendix G of the *New York City Building Code*.

**SECTION BC 107**  
**TEMPORARY STRUCTURES AND USES**

**107.1 General.** Refer to Chapter 1 of Title 28 of the *Administrative Code*.

**SECTION BC 108**  
**FEES**

**108.1 Payment of fees.** Refer to Chapter 1 of Title 28 of the *Administrative Code*.

**SECTION BC 109**  
**INSPECTIONS**

**109.1 General.** Except as otherwise specifically provided, inspections required by this code or by the department during the progress of work may be performed on behalf of the owner by approved inspection agencies or, if applicable, by special inspectors. However, in the interest of public safety, the commissioner may direct that any of such inspections be performed by the department. All inspections shall be performed at the sole cost and expense of the owner. Refer to Chapter 1 of Title 28 of the *Administrative Code* for additional provisions relating to inspections.

**109.2 Preliminary inspection.** Refer to Chapter 1 of Title 28 of the *Administrative Code*.

**109.3 Required progress inspections.** The inspections set forth in Sections 109.3.1 through 109.3.8 shall be made during the progress of work to verify substantial compliance with the code and with approved construction documents

**109.3.1 Footing and foundation inspection.** Footing and foundation inspections shall be made after excavations for footings are complete and any required reinforcing steel is in place. For concrete foundations, any required forms shall be in place prior to inspection. Materials for the foundation shall be on the job, except

where concrete is ready mixed in accordance with ASTM C 94, the concrete need not be on the job.

**109.3.2 Lowest floor elevation.** In areas of special flood hazard, upon placement of the lowest floor, including the basement (for flood zone purposes), and prior to further vertical construction, the elevation inspection report required in Item 1 of Section G105.3 of Appendix G shall be submitted to the department.

**109.3.3 Frame inspection.** Framing inspections shall be performed to determine compliance with the approved construction documents.

---

**Exception:** Work regulated and inspected under Chapter 17.

**109.3.4 Fire resistance rated construction inspection.** Fire resistance rated construction shall be inspected to determine compliance with the approved construction documents, including inspection of the following work:

1. Fire resistance rated partitions, floors, ceilings, shafts;
2. Fire blocking of concealed spaces;
3. Through-penetration firestopping, draftstopping and fireblocking;
4. Fire dampers;
5. Fire shutters; and
6. Protection of structural members.

**Exception:** Work regulated and inspected under Chapter 17.

**109.3.5 Energy code compliance inspections.** Inspections shall be made to determine compliance with approved construction documents.

**109.3.6 Other inspections.** In addition to the inspections specified above, the commissioner is authorized to make or require other inspections of any construction work to ascertain compliance with the provisions of this code and other laws that are enforced by the department.

**109.4 Special inspections.** Special inspections required by this code or by the commissioner shall be performed by special inspectors.

**109.5 Final inspection.** Refer to Chapter 1 of Title 28 of the *Administrative Code*.

**109.6 Issuance of Certificate of compliance.** Upon satisfactory inspection of service equipment and the project satisfied all the requirements for sign-off, the department shall

issue certificate of compliance as applicable for the following service equipment:

1. Elevators;
2. Escalators;
3. Moving walkways;
4. Heating systems; and
5. Dumbwaiters.

**109.7 Inspection agencies.** Refer to Chapter 1 of Title 28 of the *Administrative Code*.

**109.8 Inspection requests.** Refer to Chapter 1 of Title 28 of the *Administrative Code*.

**109.9 Satisfactory inspection report required.** Portions of work requiring inspection may be sequenced or phased to allow continuing progress of that work provided that work shall not be done beyond the point indicated in each successive required inspection for that phase. The inspector shall either indicate the portion of the construction that is satisfactory as completed, or notify the permit holder or the superintendent of construction wherein the same fails to comply with this code. Any portions that do not comply shall be corrected and such portion shall not be covered or concealed until corrected. The person performing the inspection shall complete a report of satisfactory inspection. Refer to Chapter 1 of Title 28 of the *Administrative Code*.

## **SECTION BC 110** **CERTIFICATE OF OCCUPANCY**

**110.1 General.** Refer to Chapter 1 of Title 28 of the *Administrative Code*.

## **SECTION BC 111** **SERVICE UTILITIES**

**111.1 General.** Refer to Chapter 1 of Title 28 of the *Administrative Code*.

## **SECTION BC 112** **RESERVED**

## **SECTION BC 113** **VIOLATIONS**

**113.1 General.** Refer to Chapter 2 of Title 28 of the *Administrative Code*.

## **SECTION BC 114** **STOP WORK ORDER**

**114.1 General.** Refer to Chapter 2 of Title 28 of the *Administrative Code*..

**SECTION BC 115**  
**UNSAFE STRUCTURES AND EQUIPMENT**

**115.1 General.** Refer to Chapter 2 and Chapter 3 of Title 28 of the *Administrative Code*.

**CHAPTER 2**  
**DEFINITIONS**

**SECTION BC 201**  
**GENERAL**

**201.1 Scope.** Unless otherwise expressly stated, the following words and terms shall, for the purposes of this code, have the meanings shown in this chapter.

**201.2 Interchangeability.** Words used in the present tense include the future; words stated in the masculine gender include the feminine and neuter; the singular number includes the plural and the plural, the singular.

**201.3 Terms defined in other codes.** Where terms are not defined in this code and are defined in the *New York City Fuel Gas Code*, *New York City Fire Code*, *New York City Mechanical Code*, *New York City Electrical Code* or *New York City Plumbing Code*, such terms shall have the meanings ascribed to them as in those codes.

**201.4 Terms not defined.** Where terms are not defined through the methods authorized by this section, such terms shall have ordinarily accepted meanings such as the context implies.

**SECTION BC 202**  
**DEFINITIONS**

**ACCESSIBLE.** See Section 1102.1.

**ACCESSIBLE MEANS OF EGRESS.** See Section 1002.1.

**ACCESSIBLE ROUTE.** See Section 1102.1.

**ACCESSIBLE UNIT.** See Section 1102.

**ACTIVE FAULT/ACTIVE FAULT TRACE.** See Section 1613.1.

**ADDITION.** An alteration of a building in existence that increases its exterior dimensions including but not limited to an extension or increase in floor area or height (including an increase in height or area resulting from the construction of a rooftop structure for mechanical equipment) of the building. See Section 28-101.5 of the *Administrative Code*.

**ADHERED MASONRY VENEER.** See Section 1402.1.

**ADJUSTED SHEAR RESISTANCE.** See Sections 2202.1 and 2302.1.

**ADMINISTRATIVE CODE.** *The Administrative Code of the City of New York.*

**ADMIXTURE.** See Section 1902.1.

**AEROSOL.** See Section 307.2.

**Level 1 aerosol products.** See Section 307.2.

**Level 2 aerosol products.** See Section 307.2.

**Level 3 aerosol products.** See Section 307.2.

**AGGREGATE.** See Section 1902.1.

**AGGREGATE, LIGHTWEIGHT.** See Section 1902.1.

**AGRICULTURAL, BUILDING.** A structure designed and constructed to house farm implements, hay, grain, poultry, livestock or other horticultural products. This structure shall not be a place of human habitation or a place of employment where agricultural products are processed, treated or packaged, nor shall it be a place used by the public.

**AIR-INFLATED STRUCTURE.** See Section 3102.2.

**AIR-SUPPORTED STRUCTURE.** See Section 3102.2.

**Double skin.** See Section 3102.2.

**Single skin.** See Section 3102.2.

**AISLE ACCESSWAY.** See Section 1002.1.

**ALARM NOTIFICATION APPLIANCE.** See Section 902.1.

**ALARM SIGNAL.** See Section 902.1.

**ALLEY.** See “Public way.”

**ALLOWABLE STRESS DESIGN.** See Section 1602.1.

**ALTERATION.** Any construction, addition, change of use or occupancy, or renovation to a building or structure in existence. See Section 28-101.5 of the *Administrative Code*.

**ALTERNATE LOAD PATH.** See Section 1624.1.

**ALTERNATE LOAD PATH METHOD.** See Section 1624.1.

**ALTERNATING TREAD DEVICE.** See Section 1002.1.

**ANCHOR.** See Section 2102.1.

**ANCHOR BUILDING.** See Section 402.2.

**ANCHORED MASONRY VENEER.** See Section 1402.1.

**ANNULAR SPACE.** See Section 702.1.

**ANNUNCIATOR.** See Section 902.1.

**APARTMENT.** See Section 310.2.

**APARTMENT, STUDENT.** See Section 310.2.

**APPROVED.** Acceptable to the commissioner. In reference to construction documents, the determination by the department after full examination that submitted construction documents comply with this code and other applicable laws and rules. In reference to materials, the determination by the commissioner that material is acceptable for its intended use. See Section 28-101.5 of the *Administrative Code*.

**APPROVED AGENCY.** An established and recognized agency, or other qualified person, regularly engaged in conducting tests or furnishing inspection services, when approved pursuant to department rules as qualified to perform or witness identified testing or inspection services. See Chapter 1 of Title 28 of the *Administrative Code*.

**APPROVED FABRICATOR.** See Section 1702.1.

**APPROVED INSPECTION AGENCY.** An approved agency that is approved by the department as qualified to perform one or more of the inspections required by this code. See Chapter 1 of Title 28 of the *Administrative Code*.

**APPROVED TESTING AGENCY.** An approved agency that is approved by the department as qualified to test and evaluate the performance of one or more of the materials regulated in their use by this code. Such term shall include, when approved pursuant to department rules, a third party testing or certification agency, evaluation agency, testing laboratory, testing service or other entity concerned with product evaluation. See Chapter 1 of Title 28 of the *Administrative Code*.

**ARCHEOLOGICAL RESOURCE.** See Section 3302.1.

**ARCHITECT.** A person licensed and registered to practice the profession of architecture under the Education Law of the state of New York.

**ARCHITECTURAL TERRA COTTA.** See Section 2102.1.

**AREA.** See Section 2102.1.

**Bedded.** See Section 2102.1.

**Gross cross-sectional.** See Section 2102.1.

**Net cross-sectional.** See Section 2102.1.

**AREA, BUILDING.** See Section 502.1.

**AREA OF REFUGE.** See Section 1002.1.

**AREA OF RESCUE ASSISTANCE.** See Section 1002.1.

**AREA OF SPECIAL FLOOD HAZARD.** See Section G201.2.

**ARTICULATING BOOM CRANE.** See Section 3302.1.

**ASPECT RATIO.** See Sections 1624.1.

**ASSISTED RESCUE PATH.** See Section 1002.1.

**ATRIUM.** See Section 404.1.1.

**ATTACHMENTS, SEISMIC.** See Section 1613.1.

**ATTIC.** The space between the ceiling beams of the top story and the roof rafters.

**AUDIBLE ALARM NOTIFICATION APPLIANCE.** See Section 902.1.

**AUTOMATIC.** See Section 902.1.

**AUTOMATIC FIRE-EXTINGUISHING SYSTEM.** See Section 902.1.

**AUTOMATIC SPRINKLER SYSTEM.** See Section 902.1.

**AVERAGE AMBIENT SOUND LEVEL.** See Section 902.1

**AWNING.** An architectural projection that provides weather protection, identity or decoration and is wholly supported by the building to which it is attached. An awning is comprised of a lightweight, rigid skeleton structure over which a covering is attached.

**AXIS OF ROTATION.** See Section 3302.1.

**AXLE.** See Section 3302.1.

**A-ZONE.** See Section G201.2.



**BACKING.** See Section 1402.1.

**BALCONY, EXTERIOR.** See Section 1602.1.

**BARRICADE.** See Section 307.2.

**Artificial barricade.** See Section 307.2.

**Natural barricade.** See Section 307.2.

**BASE.** See Section 1613.1.

**BASE (MOUNTING).** See Section 3302.1.

**BASE FLOOD.** See Section G201.2.

**BASE FLOOD ELEVATION.** See Section G201.2.

**BASE SHEAR.** See Section 1602.1.

**BASIC SEISMIC-FORCE-RESISTING SYSTEMS.** See Section 1602.1.

**Bearing wall system.** See Section 1602.1.

**Building frame system.** See Section 1602.1.

**Dual system.** See Section 1602.1.

**Inverted pendulum system.** See Section 1602.1.

**Moment-resisting frame system.** See Section 1602.1.

**Shear wall-frame interactive system.** See Section 1602.1.

**BASEMENT.** A story partly below the grade plane and having less than one-half its clear height (measured from finished floor to finished ceiling) below the grade plane (see “Story”, “Story above grade plane” in Section 502.1).

**BASEMENT (FOR FLOOD ZONE PURPOSES).** See Section G201.2.

**BEARER (PUTLOG).** See Section 3302.1.

**BED JOINT.** See Section 2102.1.

**BEDROCK.** See Section 1804.2.1.

**Hard sound rock (Class 1a).** See Section 1804.2.1.

**Medium hard rock (Class 1b).** See Section 1804.2.1.

**Intermediate rock (Class 1c).** See Section 1804.2.1.

**Soft rock (Class 1d).** See Section 1804.2.1.

**BLEACHERS.** See Section 1002.1.

**BOARDER (ROOMER, LODGER).** See Section 310.2.

**BOILING POINT.** See Section 307.2.

**BOND BEAM.** See Section 2102.1.

**BOND REINFORCING.** See Section 2102.1.

**BOOM.** See Section 3302.1.

**BOOM POINT.** See Section 3302.1.

**BOUNDARY ELEMENTS.** See Section 1613.1.

**BOUNDARY MEMBERS.** See Section 1602.1.

**BRACED WALL LINE.** See Section 2302.1.

**BRACED WALL PANEL.** See Section 2302.1.

**BRAKE.** See Section 3302.1.

**BREAKAWAY WALL.** See Section G201.2.

**BRICK.** See Section 2102.1.

**Calcium silicate (sand lime brick).** See Section 2102.1.

**Clay or shale.** See Section 2102.1.

**Concrete.** See Section 2102.1.

**BRITTLE.** See Section 1613.1.

**BUCKET HOIST.** See Section 3302.1.

**BUILDING.** Any structure used or intended for supporting or sheltering any use or occupancy. The term shall be construed as if followed by the phrase “structure, premises, lot or part thereof” unless otherwise indicated by the text. See Section 28-101.5 of the *Administrative code*.

**BUILDINGS AND OTHER STRUCTURES, FLEXIBLE.** See Section 1609.2.

**BUILDING, ENCLOSED.** See Section 1609.2.

**BUILDING LINE.** The line established by law, beyond which a building shall not extend, except as specifically provided by law.

**BUILDING, LOW-RISE.** See Section 1609.2.

**BUILDING, OPEN.** See Section 1609.2.

**BUILDING, PARTIALLY ENCLOSED.** See Section 1609.2.

**BUILDING, SIMPLE DIAPHRAGM.** See Section 1609.2.

**BUILT-UP ROOF COVERING.** See Section 1502.1.

**BULKHEAD.** See Section 1502.1.

**BUTTRESS.** See Section 2102.1.

**CABLE-RESTRAINED, AIR-SUPPORTED STRUCTURE.** See Section 3102.2.

**CABLEWAY.** See Section 3302.1.

**CANOPY.** An architectural projection that provides weather protection, identity or decoration and is supported by the building to which it is attached and at the outer end by not less than one stanchion. A canopy is comprised of a rigid structure over which a covering is attached.

**CANTILEVERED COLUMN SYSTEM.** See Section 1602.1.

**CARBON DIOXIDE EXTINGUISHING SYSTEMS.** See Section 902.1.

**CARBON MONOXIDE ALARM.** See Section 902.1.

**CARBON MONOXIDE DETECTOR.** See Section 902.1.

**CARBON MONOXIDE PRODUCING EQUIPMENT.** See Section 902.1.

**CARPORT.** See Section 406.1.2.

**CAST STONE.** See Section 2102.1.

**CEILING LIMIT.** See Section 902.1.

**CEILING RADIATION DAMPER.** See Section 702.1.

**CELL.** See Section 2102.1.

**CELLAR.** See Section 502.1.

**CEMENT PLASTER.** See Section 2502.1.

**CEMENTITIOUS MATERIALS.** See Section 1902.1.

**CENTRAL STATION.** See Section 902.1.

**CERAMIC FIBER BLANKET.** See Section 721.1.1.

**CERTIFICATE OF APPROVAL.** See Section 3302.1.

**CERTIFICATE OF COMPLIANCE.** See Section 1702.1 and Section 28-101.5 of the *Administrative Code*.

**CERTIFICATE OF OPERATION.** See Section 3302.1.

**CERTIFICATE OF ON-SITE INSPECTION.** See Section 3302.1.

**CHIMNEY.** See Section 2102.1.

**CHIMNEY TYPES.** See Section 2102.1.

**High-heat appliance type.** See Section 2102.1.

**Low-heat appliance type.** See Section 2102.1.

**Masonry type.** See Section 2102.1.

**Medium-heat appliance type.** See Section 2102.1.

**CIRCULATION PATH.** See Section 1102.1.

**CITY.** City of New York.

**CLADDING.** See “Components and cladding.”

**CLAMSHELL.** See Section 3302.1.

**CLAYS.** See Section 1804.2.1.

**Hard (Class 4a).** See Section 1804.2.1.

**Stiff (Class 4b).** See Section 1804.2.1.

**Medium (Class 4c).** See Section 1804.2.1.

**Soft (Class 4d).** See Section 1804.2.1.

**CLEAN AGENT.** See Section 902.1.

**CLEANOUT.** See Section 2102.1.

**CLOSED-CIRCUIT TELEPHONE.** See Section E102.1.

**CLOSED SYSTEM.** See Section 307.2.

**COLLAPSE.** See Section 1624.1.

**COLLAR JOINT.** See Section 2102.1.

**COLLECTING SAFE AREA.** See Section 1002.1.

**COLLECTOR.** See Sections 1613.1 and 2302.1.

**COLLECTOR ELEMENTS.** See Section 1602.1.

**COLUMN.** See Section 1902.1.

**COLUMN, MASONRY.** See Section 2102.1.

**COMBINATION FIRE/SMOKE DAMPER.** See Section 702.1.

**COMBINATION SIGN.** See Section H102.1.

**COMBUSTIBLE DUST.** See Section 307.2.

**COMBUSTIBLE FIBERS.** See Section 307.2.

**COMBUSTIBLE LIQUID.** See Section 307.2.

**Class II.** See Section 307.2.

**Class IIIA.** See Section 307.2.

**Class IIIB.** See Section 307.2.

**COMMERCIAL COOKING SYSTEM.** See Section 902.1.

**COMMERCIAL TRUCK MOUNTED CRANE (BOOM TRUCK).** See Section 3302.1.

**COMMISSIONER.** The Commissioner of Buildings of the City of New York or his or her duly authorized representative. See Section 28-101.5 of the *Administrative Code*.

**COMMON PATH OF EGRESS TRAVEL.** See Section 1002.1.

**COMMON USE.** See Section 1102.1.

**COMPETENT PERSON.** See Section 3302.1.

**COMPONENT.** See Section 1613.1.

**Component equipment.** See Section 1613.1.

**Component, flexible.** See Section 1613.1.

**Component, rigid.** See Section 1613.1.

**COMPONENTS AND CLADDING.** See Section 1609.2.

**COMPOSITE ACTION.** See Section 2102.1.

**COMPOSITE MASONRY.** See Section 2102.1.

**COMPRESSED GAS.** See Section 307.2.

**Nonliquefied compressed gases.** See Section 307.2.

**Liquefied compressed gases.** See Section 307.2.

**Compressed gases in solution.** See Section 307.2.

**Compressed gas mixtures.** See Section 307.2.

**COMPRESSIVE STRENGTH OF MASONRY.** See Section 2102.1.

**CONCEALED SPACES.** See Section 702.1.

**CONCRETE.** See Section 1902.1.

**CONCRETE CARBONATE AGGREGATE.** See Section 721.1.1.

**CONCRETE, CELLULAR.** See Section 721.1.1.

**CONCRETE, LIGHTWEIGHT AGGREGATE.** See Section 721.1.1.

**CONCRETE, PERLITE.** See Section 721.1.1.

**CONCRETE, SAND-LIGHTWEIGHT.** See Section 721.1.1.

**CONCRETE, SILICEOUS AGGREGATE.** See Section 721.1.1.

**CONCRETE, SPECIFIED COMPRESSIVE STRENGTH OF, ( $F'_c$ ).** See Section 1902.1.

**CONCRETE, VERMICULITE.** See Section 721.1.1.

**CONFINED REGION.** See Section 1602.1.

**CONGREGATE LIVING UNIT.** See Section 310.2.

**CONNECTOR.** See Section 2102.1.

**CONSTANTLY ATTENDED LOCATION.** See Section 902.1.

**CONSTRUCTION.** See Section 3302.1.

**CONSTRUCTION DOCUMENTS.** Plans and specifications and other written, graphic and pictorial documents, prepared or assembled for describing the design, location and physical characteristics of the elements of the project necessary for obtaining a building permit. See Section 28-101.5 of the *Administrative Code*.

**CONSTRUCTION TYPES.** See Section 602.

**Type I.** See Section 602.2.

**Type II.** See Section 602.2.

**Type III.** See Section 602.3.

**Type IV.** See Section 602.4.

**Type V.** See Section 602.5.

**CONTINUOUS GAS-DETECTION SYSTEM.** See Section 415.2.

**CONTRACTION JOINT.** See Section 1902.1.

**CONTROL AREA.** See Section 307.2.

**CONTROLLED LOW-STRENGTH MATERIAL.** A self-compacted, cementitious material used primarily as a backfill in place of compacted fill.

**CONVENTIONAL LIGHT-FRAME WOOD CONSTRUCTION.** See Section 2302.1.

**CORNER SCAFFOLD (ANGLE SCAFFOLD).** See Section 3302.1.

**CORRIDOR.** See Section 1002.1.

**CORRIDOR, INTERIOR.** See Section 1002.1.

**CORRIDOR, PUBLIC.** See Section 1002.1.

**CORROSION RESISTANCE.** The ability of a material to withstand deterioration of its surface or its properties when exposed to its environment.

**CORROSIVE MATERIAL.** See Section 307.2.

**COUNTERWEIGHT.** See Section 3302.1.

**COURT.** An open, uncovered space, unobstructed to the sky, bounded on three or more sides by exterior building walls or other enclosing devices.

**COVER.** See Section 2102.1.

**COVERED MALL BUILDING.** See Section 402.2.

**CRANE.** See Section 3302.1.

**CRAWLER CRANE.** See Section 3302.1.

**CRIPPLE WALL.** See Section 2302.1.

**CROSS AISLE.** See Section 1002.1.

**CRYOGENIC FLUID.** See Section 307.2.

**CURB LINE.** See Section 3201.8.

**CURTAIN WALL.** See Section 1402.1.

**CUSTODIAL CARE FACILITY.** See Section 310.2.

**DALLE GLASS.** See Section 2402.1.

**DAMPER.** See Section 702.1.

**DEAD END.** See Section 1002.1.

**DEAD LOADS.** See Section 1602.1.

**DEBRIS NET OR NETTING.** See Section 3302.1.

**DECK.** See Section 1602.1.

**DECORATIVE GLASS.** See Section 2402.1.

**DEFLAGRATION.** See Section 307.2.



**DEFORMABILITY.** See Section 1602.1.

**High deformability element.** See Section 1602.1.

**Limited deformability element.** See Section 1602.1.

**Low deformability element.** See Section 1602.1.

**DEFORMATION.** See Section 1602.1.

**Limited deformation.** See Section 1602.1.

**Ultimate deformation.** See Section 1602.1.

**DEFORMED REINFORCEMENT.** See Section 1902.1.

**DELUGE SPRINKLER SYSTEM.** See Section 902.1.

**DEMOLITION.** See Section 3302.1.

**DEMOLITION, FULL.** See Section 3302.1.

**DEMOLITION, PARTIAL.** See Section 3302.1.

**DEPARTMENT.** Department of Buildings of the City of New York.

**DERRICK.** See Section 3302.1.

**DESIGN EARTHQUAKE.** See Section 1613.1.

**DESIGN FLOOD ELEVATION.** See Section G201.2.

**DESIGN STRENGTH.** See Sections 1602.1 and 2102.1.

**DETACHED BUILDING.** See Section 307.2.

**DETECTABLE WARNING.** See Section 1102.1.

**DETECTOR, HEAT.** See Section 902.1.

**DETONATION.** See Section 307.2.

**DEVELOPMENT.** See Section G201.2.

**DIAPHRAGM.** See Sections 1602.1 and 2102.1.

**Diaphragm, blocked.** See Section 1602.1.

**Diaphragm, boundary.** See Section 1602.1.

**Diaphragm, chord.** See Section 1602.1.

**Diaphragm, flexible.** See Section 1602.1.

**Diaphragm, rigid.** See Section 1602.1.

**DIAPHRAGM, UNBLOCKED.** See Section 2302.1.

**DIMENSIONS.** See Section 2102.1.

**Actual.** See Section 2102.1.

**Nominal.** See Section 2102.1.

**Specified.** See Section 2102.1.

**DISPENSING.** See Section 307.2.

**DISPLACEMENT.** See Section 1613.1.

**Design displacement.** See Section 1613.1.

**Total design displacement.** See Section 1613.1.

**Total maximum displacement.** See Section 1613.1.

**DISPLACEMENT RESTRAINT SYSTEM.** See Section 1613.1

**DISPLAY SIGN.** See Section H102.1.

**DOOR, BALANCED.** See Section 1002.1.

**DORMITORY UNIT, STUDENT.** See Section 310.2.

**DRAFTSTOP.** See Section 702.1.

**DRAG STRUT.** See “Collector” at Section 2302.1.

**DRUM.** See Section 3302.1.

**DRY-CHEMICAL EXTINGUISHING SYSTEM.** See Section 902.1.

**DUCT.** See Section 1902.1.

**DURATION OF LOAD.** See Section 1602.1.

**DWELLING.** A building or structure which is occupied in whole or in part as the home, residence or sleeping place of one or more families.  
See Section 310.2.

**DWELLING, MULTIPLE.** A dwelling which is either rented, leased, let or hired out, to be occupied, or is occupied, as the residence or home of three or more families living independently of each other. A multiple dwelling does not include a building used for occupancies in Groups I-2, I-3 or I-4.

See Section 310.2.

**DWELLING, ONE-FAMILY.** Any building or structure designed and occupied exclusively for residence purposes on a long-term basis for more than a month at a time by not more than one family. One-family dwellings shall also be deemed to include a dwelling located in a series of one-family dwellings each of which faces or is accessible to a legal street or public thoroughfare, provided that each such dwelling unit is equipped as a separate dwelling unit with all essential services, and also provided that each such unit is arranged so that it may be approved as a legal one-family dwelling.

See Sections 310.2 and M102.1.

**DWELLING, TWO-FAMILY.** Any building or structure designed and occupied exclusively for residence purposes on a long-term basis for more than a month at a time by not more than two families. Two-family dwellings shall also be deemed to include a dwelling located in a series of two-family dwellings each of which faces or is accessible to a legal street or public thoroughfare, provided that each such dwelling is equipped as a separate dwelling with all essential services, and also provided that each such dwelling is arranged so that it may be approved as a legal two-family dwelling.

See Sections 310.2 and M102.1.

**DWELLING UNIT.** A single unit consisting of one or more habitable rooms and occupied or arranged to be occupied as a unit separate from all other units within a dwelling. See Section 310.2.

**DWELLING UNIT OR SLEEPING UNIT, MULTI-STORY.** See Section 1102.1.

**DWELLING UNIT OR SLEEPING UNIT, TYPE B.** See Section 1102.1.

**EFFECTIVE DAMPING.** See Section 1613.1.

**EFFECTIVE DEPTH OF SECTION (*d*).** See Section 1902.1.

**EFFECTIVE HEIGHT.** See Section 2102.1.

**EFFECTIVE STIFFNESS.** See Section 1613.1.

**EFFECTIVE WIND AREA.** See Section 1609.2.

**EGRESS COURT.** See Section 1002.1.

**ELEMENT.** See Sections 1602.1 and 1624.1.

**Ductile element.** See Section 1602.1.

**Limited ductile element.** See Section 1602.1.

**Nonductile element.** See Section 1602.1.

**EMERGENCY ALARM SYSTEM.** See Section 902.1.

**EMERGENCY CONTROL STATION.** See Section 415.2.

**EMERGENCY ESCAPE AND RESCUE OPENING.** See Section 1002.1.

**EMERGENCY VOICE/ALARM COMMUNICATIONS.** See Section 902.1.

**EMPLOYEE WORK AREA.** See Section 1102.1.

**ENGINEER.** A person licensed and registered to practice the profession of engineering under the Education Law of the State of New York.

**ENLARGEMENT.** An addition.

**EQUIPMENT SUPPORT.** See Section 1602.1.

**ESSENTIAL FACILITIES.** See Section 1602.1.

**EXHAUSTED ENCLOSURE.** See Section 415.2.

**EXISTING CONSTRUCTION.** See Section G201.2.

**EXISTING STRUCTURE.** (i) A building or structure in existence prior to the effective date of this code or one for which a lawful building permit was issued for the erection of such building or structure prior to the effective date of this code. (ii) A building or structure erected in accordance with the 1968 building code under a lawful building permit issued for the erection of such building or structure after the effective date of this code in accordance with section 28-101.4.2 of the *Administrative Code*. See Section 28-101.5 of the *Administrative Code*.

**EXISTING STRUCTURE (FOR FLOOD ZONE PURPOSES).** See Section G201.2.

**EXIT.** See Section 1002.1.

**EXIT ACCESS.** See Section 1002.1.

**EXIT DISCHARGE.** See Section 1002.1.

**EXIT DISCHARGE, LEVEL OF.** See Section 1002.1.

**EXIT ENCLOSURE.** See Section 1002.1.

**EXIT, HORIZONTAL.** See Section 1002.1.

**EXIT PASSAGEWAY.** See Section 1002.1.

**EXPANDED VINYL WALL COVERING.** See Section 802.1.

**EXPLOSION.** An effect produced by the sudden violent expansion of gases, that is accompanied by a shockwave or disruption of enclosing materials or structures, or both.

**EXPLOSIVE.** See Section 307.2.

**High explosive.** See Section 307.2.

**Low explosive.** See Section 307.2.

**UN/DOTh Class 1 Explosives.** See Section 307.2.

**Division 1.1.** See Section 307.2.

**Division 1.2.** See Section 307.2.

**Division 1.3.** See Section 307.2.

**Division 1.4.** See Section 307.2.

**Division 1.5.** See Section 307.2.

**Division 1.6.** See Section 307.2.

**EXTERIOR INSULATION FINISH SYSTEM (EIFS).** See Section 1402.1.

**EXTERIOR SURFACES.** See Section 2502.1.

**EXTERIOR WALL.** See Section 1402.1.

**EXTERIOR WALL COVERING.** See Section 1402.1.

**EXTERIOR WALL ENVELOPE.** See Section 1402.1.

**F RATING.** See Section 702.1.

**FABRICATED ITEM.** Products and assemblies regulated by this code, that are custom manufactured, or built prior to their incorporation into the work at the job site. Fabricated items shall not include listed, labeled or approved products or assemblies. See Section 1702.1.

**FABRICATION AREA.** See Section 415.2.

**FACILITY.** See Section 1102.1.

**FACTORED LOAD.** See Section 1602.1.

**FAMILY.** See Section 310.2.

**FIBERBOARD.** See Section 2302.1.

**FIBER CEMENT SIDING.** See Section 1402.1.

**FIRE ALARM BOX, MANUAL.** See Section 902.1.

**FIRE ALARM CONTROL PANEL.** See Section 902.1.

**FIRE ALARM SIGNAL.** See Section 902.1.

**FIRE ALARM SYSTEM.** See Section 902.1.

**FIRE AREA.** See Section 702.1.

**FIRE BARRIER.** See Section 702.1.

**FIRE COMMAND CENTER.** See Section 902.1.

**FIRE DAMPER.** See Section 702.1.

**FIRE DETECTOR, AUTOMATIC.** See Section 902.1.

**FIRE DOOR.** See Section 702.1.

**FIRE DOOR ASSEMBLY.** See Section 702.1.

**FIRE EXIT HARDWARE.** See Section 1002.1.

**FIRE PARTITION.** See Section 702.1.

**FIRE PROTECTION PLAN.** See Section 28-101.5 of the *Administrative Code*.

**FIRE PROTECTION RATING.** See Section 702.1.

**FIRE PROTECTION SYSTEM.** See Section 902.1.

**FIRE RESISTANCE.** See Section 702.1.

**FIRE-RESISTANCE RATING.** See Section 702.1.

**FIRE-RESISTANT JOINT SYSTEM.** See Section 702.1.

**FIRE SAFETY FUNCTIONS.** See Section 902.1.

**FIRE SEPARATION DISTANCE.** See Section 702.1.

**FIRE WALL.** See Section 702.1.

**FIRE WINDOW ASSEMBLY.** See Section 702.1.

**FIREBLOCKING.** See Section 702.1.

**FIRECUTTING.** See Section 2302.1.

**FIREPLACE.** See Section 2102.1.

**FIREPLACE THROAT.** See Section 2102.1.

**FIRESTOPPING.** See Section 702.1.

**FIREWORKS.** See Section 307.2.

**FIREWORKS, 1.3G.** See Section 307.2.

**FIREWORKS, 1.4G.** See Section 307.2.

**FLAME RESISTANCE.** See Section 802.1.

**FLAME SPREAD.** See Section 802.1.

**FLAME SPREAD INDEX.** See Section 802.1.

**FLAMMABLE GAS.** See Section 307.2.

**FLAMMABLE LIQUEFIED GAS.** See Section 307.2.

**FLAMMABLE LIQUID.** See Section 307.2.

**Class IA.** See Section 307.2.

**Class IB.** See Section 307.2.

**Class IC.** See Section 307.2.

**FLAMMABLE MATERIAL.** See Section 307.2.

**FLAMMABLE SOLID.** See Section 307.2.

**FLAMMABLE VAPORS OR FUMES.** See Section 415.2.

**FLASH POINT.** See Section 307.2.

**FLEXIBLE EQUIPMENT CONNECTIONS.** See Section 1602.1.

**FLEXURAL LENGTH.** See Section 1808.1.

**FLOOD OR FLOODING.** See Section G201.2.

**FLOOD DAMAGE-RESISTANT MATERIALS.** See Section G201.2.

**FLOOD INSURANCE RATE MAP (FIRM).** See Section G201.2.

**FLOOD INSURANCE STUDY.** See Section G201.2.

**FLOODPROOFING, DRY.** See Section G201.2.

**FLOODPROOFING, WET.** See Section G201.2.

**FLOODWAY.** See Section G201.2.

**FLOOR AREA, GROSS.** See Section 1002.1.

**FLOOR AREA, NET.** See Section 1002.1.

**FLOOR FIRE DOOR ASSEMBLY.** See Section 702.1.

**FLUE.** See Section 2102.1.

**FLUE, APPLIANCE.** See Section 2102.1.

**FLUE GASES.** See Section 2102.1.

**FLUE LINER (LINING).** See Section 2102.1.

**FLY GALLERY.** See Section 410.2.

**FOAM-EXTINGUISHING SYSTEM.** See Section 902.1.

**FOAM PLASTIC INSULATION.** See Section 2602.1.

**FOLDING AND TELESCOPIC SEATING.** See Section 1002.1.



**FOOD COURT.** See Section 402.2.

**FOOTING.** See Section 3201.8.

**FRAME.** See Section 1602.1.

**Braced frame.** See Section 1602.1.

**Concentrically braced frame (CBF).** See Section 1602.1.

**Eccentrically braced frame (EBF).** See Section 1602.1.

**Ordinary concentrically braced frame (OCBF).** See Section 1602.1.

**Special concentrically braced frame (SCBF).** See Section 1602.1.

**Moment frame.** See Section 1602.1.

**FRONTAGE SPACE.** See Section 502.1.

**FUNCTIONALLY DEPENDENT FACILITY.** See Section G201.2

**GAS CABINET.** See Section 415.2.

**GAS ROOM.** See Section 415.2.

**GLASS FIBERBOARD.** See Section 721.1.1.

**GLUED BUILT-UP MEMBER.** See Section 2302.1.

**GRADE (LUMBER).** See Section 2302.1.

**GRADE PLANE.** See Section 502.1.

**GRANDSTAND.** See Section 1002.1.

**GRANULAR SOILS.** See Section 1804.2.1.

**Dense (Class 3a).** See Section 1804.2.1.

**Medium (Class 3b).** See Section 1804.2.1.

**Loose (Class 6).** See Section 1804.2.1.

**GREENROOF.** See Section 1502.1.

**GRIDIRON.** See Section 410.2.

**GROSS LEASABLE AREA.** See Section 402.2.

**GROUND SIGN.** See Section H102.1.

**GROUP HOME.** See Section 310.2.

**GROUT.** See Section 2102.1.

**GROUTED MASONRY.** See Section 2102.1.

**Grouted hollow-unit masonry.** See Section 2102.1.

**Grouted multiwythe masonry.** See Section 2102.1.

**GUARD.** See Sections 1002.1 and 1602.1.

**GUARDRAIL SYSTEM (SCAFFOLD).** See Section 3302.1.

**GUY.** See Section 3302.1.

**GYPSUM BOARD.** See Section 2502.1.

**GYPSUM PLASTER.** See Section 2502.1.

**GYPSUM VENEER PLASTER.** See Section 2502.1.

**HABITABLE SPACE.** See Section 1202.1.

**HALOGENATED EXTINGUISHING SYSTEM.** See Section 902.1.

**HANDLING.** See Section 307.2.

**HANDRAIL.** See Section 1002.1.

**HARDBOARD.** See Section 2302.1.

**HAZARDOUS CONTENTS.** See Section 1613.1.

**HAZARDOUS MATERIALS.** See Section 307.2.

**HAZARDOUS PRODUCTION MATERIAL (HPM).** See Section 415.2.

**HEAD JOINT.** See Section 2102.1.

**HEADER (Bonder).** See Section 2102.1.

**HEALTH HAZARD.** See Section 307.2.

**HEAVY DUTY SIDEWALK SHED.** See Section 3302.1.

**HEIGHT, BUILDING.** See Section 502.1.

**HEIGHT, STORY.** See Section 502.1.

**HEIGHT, WALLS.** See Section 2102.1.

**HELIPORT.** See Section 412.5.2.

**HELISTOP.** See Section 412.5.2.

**HEREAFTER.** On or after the effective date of this code.

**HERETOFORE.** Before the effective date of this code.

**HIGH-PRESSURE BOILER.** See Section 28-401.3.

**HIGHLY TOXIC MATERIAL.** See Section 307.2.

**HISTORIC STRUCTURE.** See Section G201.2.

**HOISTING EQUIPMENT.** See Section 3302.1.

**HOISTING MACHINE.** See Section 3302.1.

**HOISTING MECHANISM.** See Section 3302.1.

**HPM FLAMMABLE LIQUID.** See Section 415.2.

**HPM ROOM.** See Section 415.2.

**HURRICANE-PRONE REGIONS.** See Section 1609.2.

**IMMEDIATELY DANGEROUS TO LIFE AND HEALTH (IDLH).** See Section 415.2.

**IMPACT LOAD.** See Section 1602.1.

**IMPORTANCE FACTOR, *I*.** See Section 1609.2.

**INCOMPATIBLE MATERIALS.** See Section 307.2.

**INDUSTRIAL EQUIPMENT PLATFORM.** See Section 502.1.

**INITIATING DEVICE.** See Section 902.1.

**INSPECTION CERTIFICATE.** See Section 1702.1.

**INTENDED TO BE OCCUPIED AS A RESIDENCE.** See Section 1102.1.

**INTERIOR FINISH.** See Section 802.1.

**INTERIOR FLOOR FINISH.** See Section 802.1.

**INTERIOR SURFACES.** See Section 2502.1.

**INTERIOR WALL AND CEILING FINISH.** See Section 802.1.

**INTERLAYMENT.** See Section 1502.1.

**INVERTED PENDULUM-TYPE STRUCTURES.** See Section 1613.1.

**ISOLATION INTERFACE.** See Section 1613.1.

**ISOLATION JOINT.** See Section 1902.1.

**ISOLATION SYSTEM.** See Section 1613.1.

**ISOLATOR UNIT.** See Section 1613.1.

**JIB.** See Section 3302.1.

**JOINT.** See Section 1602.1.

**JUMP (JUMPING).** See Section 3302.1.

**KEY ELEMENT.** See Section 1624.1.

**KITCHEN.** See Section 1202.1.

**KITCHENETTE.** See Section 1202.1.

**LABEL.** See Section 1702.1.

**LABORATORY BUILDING.** See Section 419.4.

**LABORATORY CHEMICAL.** See Section 419.4.

**LABORATORY, NON-PRODUCTION.** See Section 419.4.

**LABORATORY UNIT.** See Section 419.4.

**LAY.** See Section 3302.1.

**LETTER OF MAP AMENDMENT (LOMA).** See Section G201.2.

**LETTER OF MAP REVISION BASED ON FILL (LOMR-F).** See Section G201.2.

**LIGHT-DIFFUSING SYSTEM.** See Section 2602.1.

**LIGHT DUTY SIDEWALK SHED.** See Section 3302.1.

**LIGHT-FRAME CONSTRUCTION.** A type of construction whose vertical and horizontal structural elements are primarily formed by a system of repetitive wood or light gage steel framing members.

**LIGHT-TRANSMITTING PLASTIC ROOF PANELS.** See Section 2602.1.

**LIGHT-TRANSMITTING PLASTIC WALL PANELS.** See Section 2602.1.

**LIMIT STATE.** See Section 1602.1.

**LIMITED AREA SPRINKLER SYSTEM.** See Section 902.1.

**LIMITED PLUMBING ALTERATIONS.** See Section 28-101.5 of the *Administrative Code*.

**LIMITED SPRINKLER ALTERATIONS.** See Section 28-101.5 of the *Administrative Code*.

**LIMITED STANDPIPE ALTERATIONS.** See Section 28-101.5 of the *Administrative Code*.

**LIQUID.** See Section 415.2.

**LIQUID STORAGE ROOM.** See Section 415.2.

**LIQUID USE, DISPENSING AND MIXING ROOMS.** See Section 415.2.

**LISTED.** See Section 902.1 and Section 28-101.5 of the *Administrative Code*.

**LIVE LOADS.** See Section 1602.1.

**LIVE LOADS (ROOF).** See Section 1602.1.

**LOAD.** See Section 1613.1.

**Gravity load (W).** See Section 1613.1.

**LOAD (WORKING).** See Section 3302.1.

**LOAD AND RESISTANCE FACTOR DESIGN (LRFD).** See Section 1602.1.

**LOAD FACTOR.** See Section 1602.1.

**LOAD RATINGS.** See Section 3302.1.

**LOAD RATING CHART.** See Section 3302.1.

**LOADS.** See Section 1602.1.

**LOADS EFFECTS.** See Section 1602.1.

**LOCAL COLLAPSE.** See Section 1624.1.

**LOT.** A portion or parcel of land considered as a unit.

**LOT LINE.** A line dividing one lot from another, or from a street or any public place.

**LOWER FLAMMABLE LIMIT (LFL).** See Section 415.2.

**LOWER LOAD BLOCK.** See Section 3302.1.

**LOWEST FLOOR.** See Section G201.2

**MAILBOXES.** See Section E102.1

**MAIN WINDFORCE-RESISTING SYSTEM.** See Section 1609.2.

**MALL.** See Section 402.2.

**MANUAL FIRE ALARM BOX.** See Section 902.1.

**MANUFACTURED HOME.** See Section G201.2.

**MANUFACTURED HOME PARK OR SUBDIVISION.** See Section G201.2.

**MANUFACTURER'S DESIGNATION.** See Section 1702.1.

**MARK.** See Section 1702.1.

**MANUFACTURED HOME PARK OR SUBDIVISION.** See Section G201.2.

**MARKET VALUE OF STRUCTURE.** See Section G201.2.

**MARQUEE.** A permanent roofed structure attached to and supported by the building and that projects into the public right-of-way.

**MASONRY.** See Section 2102.1.

**Ashlar masonry.** See Section 2102.1.

**Coursed ashlar.** See Section 2102.1.

**Glass unit masonry.** See Section 2102.1.

**Plain masonry.** See Section 2102.1.

**Random ashlar.** See Section 2102.1.

**Reinforced masonry.** See Section 2102.1.

**Solid masonry.** See Section 2102.1.

**MASONRY UNIT.** See Section 2102.1.

**Clay.** See Section 2102.1.

**Concrete.** See Section 2102.1.

**Hollow.** See Section 2102.1.

**Solid.** See Section 2102.1.

**MAST-CLIMBING WORK PLATFORMS.** See Section 3302.1.

**MATERIAL HANDLING EQUIPMENT.** See Section 3302.1.

**MATERIAL HOIST (MATERIAL HOISTING EQUIPMENT).** See Section 3302.1.

**MAXIMUM CONSIDERED EARTHQUAKE.** See Section 1613.1.

**MEAN DAILY TEMPERATURE.** See Section 2102.1.

**MEAN ROOF HEIGHT.** See Section 1609.2.

**MEANS OF EGRESS.** See Section 1002.1.

**MECHANICAL-ACCESS OPEN PARKING GARAGES.** See Section 406.3.2.

**MECHANICAL EQUIPMENT SCREEN.** See Section 1502.1.

**MEMBRANE-COVERED CABLE STRUCTURE.** See Section 3102.2.

**MEMBRANE-COVERED FRAME STRUCTURE.** See Section 3102.2.

**MEMBRANE PENETRATION.** See Section 702.1.

**MEMBRANE-PENETRATION FIRESTOP.** See Section 702.1.

**METAL COMPOSITE MATERIAL (MCM).** See Section 1402.1.

**METAL COMPOSITE MATERIAL (MCM) SYSTEM.** See Section 1402.1.

**METAL ROOF PANEL.** See Section 1502.1.

**METAL ROOF SHINGLE.** See Section 1502.1.

**MEZZANINE.** See Section 502.1.

**MINERAL BOARD.** See Section 721.1.1.

**MOBILE CRANE.** See Section 3302.1.

**MOBILE SCAFFOLD.** See Section 3302.1.

**MODIFIED BITUMEN ROOF COVERING.** See Section 1502.1.

**MORTAR.** See Section 2102.1.

**MORTAR, SURFACE-BONDING.** See Section 2102.1.

**MULTILEVEL ASSEMBLY SEATING.** See Section 1102.1.

**MULTIPLE-STATION ALARM DEVICE.** See Section 902.1.

**MULTIPLE-STATION SMOKE ALARM.** See Section 902.1.

**MULTI-POINT ADJUSTABLE SUSPENSION SCAFFOLD.** See Section 3302.1.

**NAILING, BOUNDARY.** See Section 2302.1.

**NAILING, EDGE.** See Section 2302.1.

**NAILING, FIELD.** See Section 2302.1.

**NATIONAL GEODETIC VERTICAL DATUM (NGVD).** See Section G201.2.

**NATURALLY DURABLE WOOD.** See Section 2302.1.



Decay resistant. See Section 2302.1.  
Termite resistant. See Section 2302.1.

NEW CONSTRUCTION. See Section G201.2.

NOMINAL LOADS. See Section 1602.1.

NOMINAL SIZE (LUMBER). See Section 2302.1.

NONBUILDING STRUCTURE. See Section 1613.1.

NONCOMBUSTIBLE MEMBRANE STRUCTURE. See Section 3102.2.

NONRESIDENTIAL (FOR FLOOD ZONE PURPOSES). See Section G201.2.

NORMALTEMPERATURE AND PRESSURE (NTP). See Section 415.2.

NOSING. See Section 1002.1.

NOTATIONS. See Sections 1602.1 and 2102.1.

OCCUPANCY. The purpose or activity for which a building or space is used or is designed, arranged or intended to be used..

OCCUPANCY IMPORTANCE FACTOR. See Section 1613.1.

OCCUPANT LOAD. See Section 1002.1.

OCCUPIABLE SPACE. See Section 1202.1.

OPEN EXTERIOR SPACE. See Section 1002.1.

OPEN PARKING GARAGE. See Section 406.3.2.

OPEN PARKING LOT. See Section 406.3.2.

OPEN SYSTEM. See Section 307.2.

ORDINARY REPAIRS. See Section 28-105.4.2.1.

ORGANIC PEROXIDE. See Section 307.2.

Class I. See Section 307.2.

Class II. See Section 307.2.

Class III. See Section 307.2.

Class IV. See Section 307.2.

Class V. See Section 307.2.

Unclassified detonable. See Section 307.2.

OTHER STRUCTURES. See Section 1602.1.

OUTRIGGER (CRANE). See Section 3302.1.

OUTRIGGER (SCAFFOLD). See Section 3302.1.

OUTRIGGER BEAM (THRUSTOUT). See Section 3302.1.

OUTRIGGER SCAFFOLD. See Section 3302.1.

OWNER. Any person, agent, firm, partnership, corporation or other legal entity having a legal or equitable interest in, or control of the premises.

OXIDIZER. See Section 307.2.

Class 4. See Section 307.2.

Class 3. See Section 307.2.

Class 2. See Section 307.2.

Class 1. See Section 307.2.

OXIDIZING GAS. See Section 307.2.

P-DELTA EFFECT. See Section 1602.1.

PANEL (PART OF A STRUCTURE). See Section 1602.1.

PANIC HARDWARE. See Section 1002.1.

PARKING GARAGE. See Section 406.2.2.

PARTIAL DEMOLITION. See Section 3302.1.

PARTICLE BOARD. See Section 2302.1.

PEDESTAL. See Section 1902.1.

PENETRATION FIRESTOP. See Section 702.1.

PENTHOUSE. See Section 1502.1.

PERFORATED SHEAR WALL. See Section 2302.1.

**PERFORATED SHEAR WALL SEGMENT.** See Section 2302.1.

**PERMIT.** An official document or certificate issued by the commissioner that authorizes performance of specified work or activity.

**PERSON.** An individual, partnership, corporation, or other legal entity.

**PERSONAL CARE SERVICE.** See Section 310.2.

**PERSONNEL HOIST.** See Section 3302.1.

**PHYSICAL HAZARD.** See Section 307.2.

**PIER FOUNDATIONS.** See Section 1808.1.

**Belled piers.** See Section 1808.1.

**PILE FOUNDATIONS.** See Section 1808.1.

**Augered-cast-in-place piles.** See Section 1808.1.

**Caisson piles.** See Section 1808.1.

**Compacted Concrete Piles.** See Section 1808.1.

**Concrete-filled steel pipe and tube piles.** See Section 1808.1.

**Driven uncased piles.** See Section 1808.1.

**Enlarged base piles.** See Section 1808.1.

**H-Piles.** See Section 1808.1.

**Steel-cased piles.** See Section 1808.1.

**Jacked Piles.** See Section 1808.1.

**Micro-piles/mini-piles.** See Section 1808.1.

**Open end pipe pile.** See Section 1808.1.

**PINRAIL.** See Section 410.2.

**PLAIN CONCRETE.** See Section 1902.1.

**PLAIN REINFORCEMENT.** See Section 1902.1.

**PLASTIC, APPROVED.** See Section 2602.1.

**PLASTIC GLAZING.** See Section 2602.1.

**PLASTIC HINGE.** See Section 2102.1.

**PLATFORM.** See Sections 410.2 and 3302.1.

**POLE SIGN.** See Section H102.1.

**POSITIVE ROOF DRAINAGE.** See Section 1502.1.

**POST-FIRE SMOKE PURGE SYSTEM.** See Section 909.1.1.

**POST-FIRM DEVELOPMENT.** See Section G201.2.

**POST-FIRM STRUCTURE.** See Section G201.2.

**POST TENSIONING.** See Section 1902.1.

**POWER BUGGIES.** See Section 3302.1.

**PRECAST CONCRETE.** See Section 1902.1.

**PRE-FIRM DEVELOPMENT.** See Section G201.2.

**PRE-FIRM STRUCTURE.** See Section G201.2.

**PREMISES.** Land, improvements thereon, or any part thereof.

**PRESERVATIVE-TREATED WOOD.** See Section 2302.1.

**PRESIGNAL SYSTEM.** See Section 902.1.

**PRESSURIZATION.** See Section 909.1.1.

**PRESTRESSED CONCRETE.** See Section 1902.1.

**PRESTRESSED MASONRY.** See Section 2102.1.

**PRESTRESSING STEEL.** See Section 1902.1.

**PRETENSIONING.** See Section 1902.1.

**PRIMARY STRUCTURE.** See Sections 1627.5.

**PRISM.** See Section 2102.1.

**PRIVATE GARAGE.** See Section 406.1.2

**PROJECTING SIGN.** See Sections 3201.8 and H102.1.

**PROSCENIUM WALL.** See Section 410.2.

**PUBLIC ENTRANCE.** See Section 1102.1.

**PUBLIC-USE AREAS.** See Section 1102.1.

**PUBLIC WAY.** See Section 1002.1.

**PYROPHORIC MATERIAL.** See Section 307.2.

**PYROTECHNIC COMPOSITION.** See Section 307.2.

**QUALIFIED PERSON.** See Section 3302.1.

**RAMP.** See Section 1002.1.

**RAMP-ACCESS OPEN PARKING GARAGES.** See Section 406.3.2.

**RECORD DRAWINGS.** See Section 902.1.

**RECREATIONAL VEHICLE.** See Section G201.2.

**REFERENCE RESISTANCE (*D*).** See Section 2302.1.

**REGISTERED DESIGN PROFESSIONAL.** An architect or engineer.

**REGISTERED DESIGN PROFESSIONAL OF RECORD.** The registered design professional who prepared or supervised the preparation of applicable construction documents filed with the department.

**REINFORCED CONCRETE.** See Section 1902.1.

**REINFORCED PLASTIC, GLASS FIBER.** See Section 2602.1.

**REINFORCEMENT.** See Section 1902.1.

**REPAIR.** The reconstruction or renewal of any part of an existing building for the purpose of its maintenance.

**REQUIRED.** Required by this code.

**REQUIRED STRENGTH.** See Sections 1602.1 and 2102.1.

**REROOFING.** See Section 1502.1.

**RESHORES.** See Section 1902.1.

**RESIDENTIAL CARE/ASSISTED LIVING FACILITIES.** See Section 310.2.

**RESIDENTIAL (FOR FLOOD ZONE PURPOSES).** See Section G201.2.

**RESISTANCE FACTOR.** See Section 1602.1.

**RESPONSE RATIO.** See Section 1624.1.

**RESTRICTED ENTRANCE.** See Section 1102.1.

**RETRACTABLE AWNING.** See Section 3105.2.

**ROOF ASSEMBLY.** See Section 1502.1.

**ROOF COVERING.** See Section 1502.1.

**ROOF COVERING SYSTEM.** See Section 1502.1.

**ROOF DECK.** See Section 1502.1.

**ROOF RECOVER.** See Section 1502.1.

**ROOF REPLACEMENT.** See Section 1502.1.

**ROOF SIGN.** See Section H102.1.

**ROOF VENTILATION.** See Section 1502.1.

**ROOFTOP STRUCTURE.** See Section 1502.1.

**ROOMING HOUSE.** See Section 310.2.

**ROPE.** See Section 3302.1.

**ROTATION.** See Section 1624.1.

**RUBBLE MASONRY.** See Section 2102.1.

**Coursed rubble.** See Section 2102.1.

**Random rubble.** See Section 2102.1.

**Rough or ordinary rubble.** See Section 2102.1.

**RUNBACK STRUCTURE.** See Section 3302.1.

**RUNNING BOND.** See Section 2102.1.

**SAFE AREA.** See Section 1002.1.

**SANDY GRAVEL AND GRAVELS.** See Section 1804.2.1.

**Dense (Class 2a).** See Section 1804.2.1.

**Medium (Class 2b).** See Section 1804.2.1.

**Loose (Class 6).** See Section 1804.2.1.

**SAND DUNES.** See Section G201.2.

**SCAFFOLD.** See Section 3302.1.

**SCISSOR STAIR.** See Section 1002.1.

**SEATING SECTION.** See Section 1002.1.

**SEISMIC DESIGN CATEGORY.** See Section 1613.1.

**SEISMIC-FORCE-RESISTING SYSTEM.** See Section 1613.1.

**SEISMIC FORCES.** See Section 1613.1.

**SEISMIC USE GROUP.** See Section 1613.1.

**SELF-CLOSING.** See Section 702.1.

**SELF-SERVICE STORAGE FACILITY.** See Section 1102.1.

**SERVICES.** See Section 1102.1.

**SERVICE CORRIDOR.** See Section 415.2.

**SERVICE ENTRANCE.** See Section 1102.1.

**SHAFT.** See Section 702.1.

**SHAFT ENCLOSURE.** See Section 702.1.

**SHEAR PANEL.** See Section 1602.1.

**SHEAR WALL.** See Sections 1602.1, 1613.1 and 2102.1 and 2302.1.

**Detailed plain masonry shear wall.** See Section 2102.1.  
**Intermediate pre-stressed masonry shear wall.** See Section 2102.1.  
**Intermediate reinforced masonry shear wall.** See Section 2102.1.  
**Ordinary plain masonry shear wall.** See Section 2102.1.  
**Ordinary plain pre-stressed masonry shear wall.** See Section 2102.1.  
**Ordinary reinforced masonry shear wall.** See Section 2102.1.  
**Perforated shear wall.** See Section 2302.1.  
**Perforated shear wall segment.** See Section 2302.1.  
**Special reinforced masonry shear wall.** See Section 2102.1.  
**Type I shear wall.** See Section 2202.1.  
**Type II shear wall.** See Section 2202.1.  
**Type II shear wall segment.** See Section 2202.1.

**SHEAR WALL-FRAME INTERACTIVE SYSTEM.** See Section 1613.1.

**SHELL.** See Section 2102.1.

**SHORES.** See Section 1902.1.

**SHOTCRETE.** See Section 1914.1.

**SIGN.** See Sections 3201.8 and H102.1.

**SIGN STRUCTURE.** See Section H102.1.

**SILTS AND CLAY SLITS.** See Section 1804.2.1.

**Dense (Class 5a).** See Section 1804.2.1.

**Medium (Class 5b).** See Section 1804.2.1.

**Loose (Class 6).** See Section 1804.2.1.

**SINGLE-POINT ADJUSTABLE SUSPENSION SCAFFOLD.** See Section 3302.1.

**SINGLE-PLY MEMBRANE.** See Section 1502.1.

**SINGLE-STATION SMOKE ALARM.** See Section 902.1.

**SITE.** See Section 1102.1.

**SITE CLASS.** See Section 1613.1.

**SITE COEFFICIENTS.** See Section 1613.1.



**SKYLIGHT, UNIT.** A factory-assembled, glazed fenestration unit, containing one panel of glazing material that allows for natural lighting through an opening in the roof assembly while preserving the weather-resistant barrier of the roof.

**SKYLIGHTS AND SLOPED GLAZING.** Glass or other transparent or translucent glazing material installed at a slope of 15 degrees (0.26 rad) or more from vertical. Glazing material in skylights, including unit skylights, solariums, sunrooms, roofs and sloped walls, are included in this definition.

**SLEEPING UNIT.** See Section 310.2.

**SMOKE.** See Section 909.1.1.

**SMOKE ALARM.** See Section 902.1.

**SMOKE BARRIER.** See Section 702.1.

**SMOKE COMPARTMENT.** See Section 702.1.

**SMOKE-CONTROL MODE.** See Section 909.1.1.

**SMOKE-CONTROL SYSTEM, MECHANICAL.** See Section 909.1.1.

**SMOKE-CONTROL SYSTEM, PASSIVE.** See Section 909.1.1.

**SMOKE-CONTROL ZONE.** See Section 909.1.1.

**SMOKE DAMPER.** See Section 702.1.

**SMOKE DETECTOR.** See Section 902.1.

**SMOKE-DEVELOPED INDEX.** See Section 802.1.

**SMOKE PARTITION.** See Section 702.1.

**SMOKE-PROTECTED ASSEMBLY SEATING.** See Section 1002.1.

**SMOKEPROOF ENCLOSURE.** See Section 902.1.

**SOLID.** See Section 415.2.

**SPACE FRAME.** See Section 1602.1.

**SPECIAL AMUSEMENT BUILDING.** See Section 411.2.

**SPECIAL INSPECTION.** See Section 1702.1.

**SPECIAL INSPECTION, CONTINUOUS.** See Section 1702.1.

**SPECIAL INSPECTION, PERIODIC.** See Section 1702.1.

**SPECIAL INSPECTOR.** An individual having required qualifications and authorized by the department to perform or witness particular special inspections required by this code or by the rules of the department, including but not limited to a qualified registered design professional so authorized. See Section 1702.1 and Chapter 1 of title 28 of the *Administrative Code*.

**SPECIAL FLOOD HAZARD AREA.** See Section G201.2.

**SPECIAL TRANSVERSE REINFORCEMENT.** See Section 1602.1.

**SPECIFIC LOCAL LOAD.** See Section 1624.1.

**SPECIFIC LOCAL RESISTANCE METHOD.** See Section 1624.1.

**SPECIFIED.** See Section 2102.1.

**SPECIFIED COMPRESSIVE STRENGTH OF MASONRY ( $f'_m$ ).** See Section 2102.1.

**SPIRAL REINFORCEMENT.** See Section 1902.1.

**SPRAYED FIRE-RESISTANT MATERIALS.** See Section 1702.1.

**STACK BOND.** See Section 2102.1.

**STAGE.** See Section 410.2.

**STAIR.** See Section 1002.1.

**STAIRWAY.** See Section 1002.1.

**STAIRWAY, EXTERIOR.** See Section 1002.1.

**STAIRWAY, INTERIOR.** See Section 1002.1.

**STAIRWAY, SPIRAL.** See Section 1002.1.

**STACK EFFECT.** See Section 909.1.1.

**STANDARD CUBIC FEET (SCF).** See Section 307.2.

**STANDARD GUARDRAIL SYSTEM (SCAFFOLD).** See Section 3302.1.

**STANDPIPE SYSTEM.** See Section 902.1.

**Automatic dry.** See Section 902.1.

**Automatic wet.** See Section 902.1.

**Manual dry.** See Section 902.1.

**Manual wet.** See Section 902.1.

**Semiautomatic dry.** See Section 902.1.

**STANDPIPE SYSTEM, CLASSES OF.** See Section 902.1.

**Class I system.** See Section 902.1.

**Class II system.** See Section 902.1.

**Class III system.** See Section 902.1.

**START OF CONSTRUCTION.** See Section G201.2.

**STEEL CONSTRUCTION, COLD-FORMED.** See Section 2202.1.

**STEEL JOIST.** See Section 2202.1.

**STEEL MEMBER, STRUCTURAL.** See Section 2202.1.

**STEEP SLOPE.** A roof slope greater than two units vertical in 12 units horizontal (17-percent slope).

**STRIPPING OPERATIONS.** See Section 1902.1.

**STIRRUP.** See Section 1902.1.

**STONE MASONRY.** See Section 2102.1.

**Ashlar stone masonry.** See Section 2102.1.

**Rubble stone masonry.** See Section 2102.1.

**STORAGE CABINET.** See Section 419.4.

**STORAGE ROOM.** See Section 419.4.

**STORY.** That portion of a building included between the upper surface of a floor and the upper surface of the floor or roof next above (also see “Basement,” “Mezzanine” and Section 502.1). It is measured as the vertical distance from top to top of two successive

tiers of beams or finished floor surfaces and, for the topmost story, from the top of the floor finish to the top of the ceiling joists or, where there is not a ceiling, to the top of the roof rafters.

**STORY ABOVE GRADE PLANE.** Any story having its finished floor surface entirely above grade plane, except that a basement shall also be considered a story above grade plane (also see “Basement” and “Story”). See Section 502.1.

**STORY DRIFT RATIO.** See Section 1613.1.

**STREET.** See Section 3201.8.

**STREET FLOOR.** A floor, usually the principal entrance floor, that is not more than one-half story above or below grade at the location from which egress is provided to the street.

**STREET LINE.** See Section 3201.8.

**STRENGTH, NOMINAL.** See Sections 1602.1 and 2102.1.

**STRENGTH, REQUIRED.** See Sections 1602.1 and 2102.1.

**STRENGTH, DESIGN.** See Section 1602.1.

**STRUCTURAL CONCRETE.** See Section 1902.1.

**STRUCTURAL GLUED-LAMINATED TIMBER.** See Section 2302.1.

**STRUCTURAL NET OR NETTING.** See Section 3302.1.

**STRUCTURE.** That which is built or constructed, including among others: buildings, stadia, tents, reviewing stands, platforms, stagings, observation towers, radio towers, tanks, trestles, open sheds, shelters, fences, and display signs. See Section 28-101.5 of the *Administrative Code*.

**SUBDIAPHRAGM.** See Section 2302.1.

**SUSTAINED WIND.** See Section 3302.1.

**SUBSTANTIAL DAMAGE.** See Section G201.2.

**SUBSTANTIAL IMPROVEMENT.** See Section G201.2.

**SUPERINTENDENT OF CONSTRUCTION.** See Section 28-101.5 of the *Administrative Code*.

**SUPERSTRUCTURE.** See Section 3302.1.

**SUPERVISING STATION.** See Section 902.1.

**SUPERVISORY SERVICE.** See Section 902.1.

**SUPERVISORY SIGNAL.** See Section 902.1.

**SUPERVISORY SIGNAL-INITIATING DEVICE.** See Section 902.1.

**SUPPORTED SCAFFOLD.** See Section 3302.1.

**SUSTAINED WIND.** See Section 3302.1

**SWIMMING POOL.** See Section 3109.2.

**SWIMMING POOL, PRIVATE.** See Section 3109.2.

**SWIMMING POOL, PUBLIC.** See Section 3109.2.

**SWING.** See Section 3302.1.

**T RATING.** See Section 702.1.

**TEMPORARY SIGN.** See Section H102.1.

**TENABLE ENVIRONMENT.** See Section 909.1.1.

**TENDON.** See Section 1902.1.

**TENT.** See Section 3102.2.

**THERMALLY ISOLATED SUNROOM ADDITION.** See Section 1202.1.

**THERMOPLASTIC MATERIAL.** See Section 2602.1.

**THERMOSETTING MATERIAL.** See Section 2602.1.

**THROUGH PENETRATION.** See Section 702.1.

**THROUGH-PENETRATION FIRESTOP SYSTEM.** See Section 702.1.

**TIE-DOWN (HOLD-DOWN).** See Section 2302.1.

**TIE, LATERAL.** See Section 2102.1.

**TIE, WALL.** See Section 2102.1.

**TILE.** See Section 2102.1.

**TILE, STRUCTURAL CLAY.** See Section 2102.1.

**TIRES, BULK STORAGE OF.** See Section 902.1.

**TORSIONAL FORCE DISTRIBUTION.** See Section 1613.1.

**TOUGHNESS.** See Section 1613.1.

**TOWER.** See Section 3302.1.

**TOWER CRANE.** See Section 3302.1.

**TOXIC MATERIAL.** See Section 307.2.

**TRANSIENT LODGING.** See Section E102.1.

**TRANSIT.** See Section 3302.1.

**TRAVEL.** See Section 3302.1.

**TREATED WOOD.** See Section 2302.1.

**TRIM.** See Section 802.1.

**TROUBLE SIGNAL.** See Section 902.1.

**TWO-POINT SUSPENSION SCAFFOLD (SWING STAGE).** See Section 3302.1.

**UNADJUSTED SHEAR RESISTANCE.** See Sections 2202.1 and 2302.1.

**UNDERLAYMENT.** See Section 1502.1.

**UNSTABLE (REACTIVE) MATERIAL.** See Section 307.2.

**Class 4.** See Section 307.2.

**Class 3.** See Section 307.2.

**Class 2.** See Section 307.2.

**Class 1.** See Section 307.2.

**USE (USED).** The purpose for which a building, structure, or space is occupied or utilized, unless otherwise indicated by the text. Use (used) shall be construed as if followed by the words "or is intended, arranged, or designed to be used."

**UTILITY COMPANY OR PUBLIC UTILITY COMPANY.** See Section 28-101.5.

**UTILITY CORPORATION OR PUBLIC UTILITY CORPORATION.** See Section 28-101.5.

**VAPOR RETARDER.** A vapor-resistant material, membrane or covering such as foil, plastic sheeting or insulation facing having a permeance rating of 1 perm ( $5.7 \times 10^{-11}$  kg/Pa · s · m<sup>2</sup>) or less, when tested in accordance with the desiccant method using Procedure A of ASTM E 96. Vapor retarders limit the amount of moisture vapor that passes through a material or wall assembly.

**VAULT.** See Section 3201.8.

**VENEER.** See Section 1402.1.

**VENTILATION.** The natural or mechanical process of supplying conditioned or unconditioned air to, or removing such air from, any space.

**VISIBLE ALARM NOTIFICATION APPLIANCE.** See Section 902.1.

**V-ZONE.** See Section G201.2.

**WALKWAY, PEDESTRIAN.** A walkway used exclusively as a pedestrian trafficway.

**WALL.** See Section 2102.1.

**Cavity wall.** See Section 2102.1.

**Composite wall.** See Section 2102.1.

**Dry-stacked, surface-bonded wall.** See Section 2102.1.

**Masonry-bonded hollow wall.** See Section 2102.1.

**Parapet wall.** See Section 2102.1.

**WALL, LOAD-BEARING.** See Section 1602.1.

**WALL, NONLOAD-BEARING.** See Section 1602.1.

**WALL SIGN.** See Section H102.1.

**WATER-REACTIVE MATERIAL.** See Section 307.2.

Class 3. See Section 307.2.

Class 2. See Section 307.2.

Class 1. See Section 307.2.

WEATHER-EXPOSED SURFACES. See Section 2502.1.

WEB. See Section 2102.1.

WET-CHEMICAL EXTINGUISHING SYSTEM. See Section 902.1.

WHEELCHAIR SPACE. See Section 1102.1.

WHEEL MOUNTED CRANE (MULTIPLE CONTROL STATIONS). See Section 3302.1.

WHEEL MOUNTED CRANE (SINGLE CONTROL STATION). See Section 3302.1.

WIND-BORNE DEBRIS REGION. See Section 1609.2.

WINDER. See Section 1002.1.

WIND-RESTRAINT SEISMIC SYSTEM. See Section 1613.1.

WIRE BACKING. See Section 2502.1.

WIRELESS PROTECTION SYSTEM. See Section 902.1.

WOOD SHEAR PANEL. See Section 2302.1.

WOOD STRUCTURAL PANEL. See Section 2302.1.

Composite panels. See Section 2302.1.

Oriented strand board (OSB). See Section 2302.1.

Plywood. See Section 2302.1.

WORK NOT CONSTITUTING MINOR ALTERATIONS OR ORDINARY REPAIRS. See Section 28-105.4.2.1.

WORKSTATION. See Section 415.2.

WRITING (WRITTEN). See Section 28-101.5.

WRITTEN NOTICE. See Section 28-101.5.



**WYTHE.** See Section 2102.1.

**YARD.** An open space, other than a court, unobstructed from the ground to the sky, except where specifically provided by this code, on the lot on which a building is situated.

**ZONE.** See Section 902.1.

**ZONING RESOLUTION.** See Section 28-101.5.

**CHAPTER 3**  
**USE AND OCCUPANCY CLASSIFICATION**

**SECTION BC 301**  
**GENERAL**

**301.1 Scope.** The provisions of this chapter shall control the classification of all buildings and structures, and spaces therein, as to use and occupancy.

**SECTION BC 302**  
**CLASSIFICATION**

**302.1 General.** Structures or portions of structures shall be classified with respect to occupancy in one or more of the groups listed below. Structures with multiple uses shall be classified according to Section 302.3. Where a structure, or portion thereof, is proposed for a purpose which is not specifically provided for in this code, such structure, or portion thereof shall be classified in the group which the occupancy most nearly resembles, according to the fire safety and relative hazard involved, and as approved by the commissioner. Where reference is made in this code to the term, “main use or dominant occupancy of the building,” such term shall correspond to one of the occupancy groups listed in this section.

1. Assembly (see Section 303): Groups A-1, A-2, A-3, A-4 and A-5
2. Business (see Section 304): Group B
3. Educational (see Section 305): Group E
4. Factory and Industrial (see Section 306): Groups F-1 and F-2
5. High Hazard (see Section 307): Groups H-1, H-2, H-3, H-4 and H-5
6. Institutional (see Section 308): Groups I-1, I-2, I-3 and I-4
7. Mercantile (see Section 309): Group M
8. Residential (see Section 310): Groups R-1, R-2 and R-3
9. Storage (see Section 311): Groups S-1 and S-2
10. Utility and Miscellaneous (see Section 312): Group U

For a listing of Occupancy Group Classifications that corresponds with uses listed in the Zoning Resolution, refer to department rules.

**302.1.1 Incidental use areas.** Spaces that are listed in Table 302.1.1 and are incidental to the main occupancy shall be considered incidental use areas. Such spaces shall be separated or protected, or both, from adjoining occupancies in accordance with Table 302.1.1, or the building shall be classified as a mixed occupancy and comply with Section 302.3. Areas that are incidental to the main occupancy shall be classified in accordance with the main occupancy of the portion of the building in which the incidental use area is located.

**Exception:** Incidental use areas within and serving a dwelling unit are not required to comply with this section.

**TABLE 302.1.1**  
**INCIDENTAL USE AREAS**  
**(Table 302.1.1 attached to end of document)**

**302.1.1.1 Separation.** Where Table 302.1.1 requires a fire-resistance-rated separation, the incidental use area shall be separated from the remainder of the building with a fire barrier. Where Table 302.1.1 permits an automatic fire-extinguishing system without a fire barrier, the incidental use area shall be separated by construction capable of resisting the passage of smoke. The partitions shall extend from the floor to the underside of the fire-resistance-rated floor/ceiling assembly or fire-resistance rated roof/ceiling assembly or to the underside of the floor or roof deck above. Doors shall be self-closing or automatic-closing upon detection of smoke. Doors shall not have air transfer openings and shall not be undercut in excess of the clearance permitted in accordance with NFPA 80.

**302.2 Accessory use areas.** A room or a space of a different occupancy classification than the main occupancy that is subordinate and secondary to the main occupancy and necessary for the main occupancy to properly function shall be considered an accessory use area.

**302.2.1 Separation.** All accessory use areas shall be separated from the main occupancy by a fire barrier in accordance with Section 302.3.

**Exceptions:** The following accessory use spaces do not require a fire barrier from the principal occupancy:

1. Group A spaces with floor area equal to or less than 750 square feet (69.7 m<sup>2</sup>) and accessory to any other occupancy.
2. Group A spaces that are accessory to Group E occupancies.
3. Group A religious educational rooms and religious auditoriums with occupant loads of less than 100.

4. Group B, E, F, I, M, R, S, and U spaces that are accessory to another occupancy and where the accessory use area occupies a floor area not more than 10 percent of the area of the story in which it is located and does not exceed the tabular values in Table 503 for the allowable height or area for such use.
5. Groups B and M storage areas complying with footnote b of Table 302.3.2.

**TABLE 302.3.2**  
**REQUIRED SEPARATION OF OCCUPANCIES (HOURS)<sup>a</sup>**  
**(Table 302.3.2 attached to end of document)**

**302.3 Mixed occupancies.** Where a building is occupied by two or more uses not included in the same occupancy classification, the building or portion thereof shall comply with Section 302.3.1 or 302.3.2 or a combination of these sections.

**Exceptions:**

1. Occupancies separated in accordance with Section 508.
2. Areas of Group H-2, H-3, H-4 or H-5 occupancies shall be separated from any other occupancy in accordance with Section 302.3.2.
3. Where required by Table 415.3.2, areas of Group H-1, H-2 or H-3 occupancy shall be located in a separate and detached building or structure.
4. Accessory use areas in accordance with Section 302.2.
5. Incidental use areas in accordance with Section 302.1.1.

**302.3.1 Nonseparated occupancies.** Each portion of the building shall be individually classified as to occupancy.

The required type of construction for the entire building shall be determined by applying the height and area limitations for each of the applicable occupancies to the entire building. The most restrictive type of construction, so determined, shall apply to the entire building.

All other code requirements shall apply to each portion of the building based on the occupancy of that space except that the most restrictive applicable provisions of Section 403 and Chapter 9 shall apply to these nonseparated occupancies. Fire separations are not required between occupancies, except as required by other provisions.

**302.3.2 Separated occupancies.** Each portion of the building shall be individually classified as to occupancy and shall be completely separated from adjacent areas by vertical or horizontal fire barriers having a fire-resistance rating determined in accordance with

Table 302.3.2 for occupancies being separated. Where the building is equipped throughout with an automatic sprinkler system installed in accordance with Section 903.3.1.1, the fire-resistance ratings in Table 302.3.2 are permitted to be reduced by 1 hour, but in no case shall be less than that required for floor construction according to the type of construction, or less than 1 hour, whichever is higher. However, fire barriers separating Group H and I-2 occupancies shall not be permitted any reductions in fire-resistance ratings.

Each fire area shall comply with this code based on the occupancy of that space. Each fire area shall comply with the height limitations based on the occupancy of that space and the type of construction classification. In each story, the building area shall be such that the sum of the ratios of the floor area of each occupancy divided by the allowable area for each occupancy shall not exceed one.

**302.4 Spaces used for different purposes.** A room or space that is intended to be occupied at different times for different purposes shall comply with all the requirements that are applicable to each of the purposes for which the room or space will be occupied.

**302.5 Separation of different tenancies.** Spaces or dwelling units occupied by different tenants shall be separated by fire barriers having at least 1-hour fire resistance rating.

**Exceptions:**

1. Non-residential spaces occupied by different tenants located in buildings that are sprinklered throughout.
2. Tenant spaces in covered mall buildings complying with Section 402.

**SECTION BC 303**  
**ASSEMBLY GROUP A**

**303.1 Assembly Group A.** Assembly Group A occupancy includes, among others, the use of a building or structure or a portion thereof, excluding a dwelling unit, for the gathering together of any number of persons for purposes such as civic, social or religious functions, recreation, food or drink consumption, awaiting transportation, or similar group activities; or when occupied by 75 persons or more for educational or instructional purposes.

A Certificate of Operation shall be required, as per Section 28-117.1, for the following places of assembly:

1. Indoor places of assembly used or intended for use by 75 persons or more, including open spaces at 20 feet (6096 mm) or more above or below grade, such as roofs or roof terraces.
2. Outdoor places of assembly used and intended for use by 200 persons or more.

**Exceptions:**

1. A room or space used for assembly purposes by fewer than 75 persons and accessory to another occupancy shall be included as a part of that occupancy
2. A building or non-accessory tenant space used for assembly purposes by fewer than 75 persons shall be considered a Group B occupancy.

Assembly occupancies shall include the following:

A-1 Assembly uses, usually with fixed seating, intended for the production and viewing of the performing arts or motion pictures including, but not limited to:

Motion picture theaters

Symphony and concert halls

Television and radio studios admitting an audience

Theaters

A-2 Assembly uses intended for food and/or drink consumption including, but not limited to:

Banquet halls

Cabarets

Cafeterias, except as provided for in A-3

Dance halls

Night clubs

Restaurants

Taverns and bars

A-3 Assembly uses intended for worship, recreation or amusement and other assembly uses not classified elsewhere in Group A including, but not limited to:

Amusement arcades

Art galleries

Bowling alleys

Cafeterias for children up to and including the 12<sup>th</sup> grade

Classrooms and instructional rooms with 75 persons or more; such rooms with fewer than 75 persons shall be classified as Group B or E

Community halls

Courtrooms

Custodial care facilities with 75 or more persons, providing care to persons over the age of 2, where no more than four occupants are incapable of responding to an emergency situation without physical assistance from staff

Dance studio or instruction (not including food or drink consumption)

Exhibition halls

Funeral parlors

Gymnasiums (without spectator seating)  
Houses of worship  
Indoor swimming pools (without spectator seating)  
Indoor tennis courts (without spectator seating)  
Lecture halls  
Museums  
Waiting areas in transportation terminals  
Pool and billiard parlors  
School auditoriums

A-4 Assembly uses intended for viewing of indoor sporting events and activities with spectator seating including, but not limited to:

Arenas  
Skating rinks  
Swimming pools  
Tennis courts

A-5 Assembly uses intended for participation in or viewing outdoor activities including, but not limited to:

Amusement park structures  
Bleachers  
Grandstands  
Stadiums

## **SECTION BC 304** **BUSINESS GROUP B**

**304.1 Business Group B.** Business Group B occupancy includes, among others, the use of a building or structure, or a portion thereof, for office, professional, service-type transactions, or for conducting public or civic services, including the incidental storage of records and accounts and the incidental storage of limited quantities of stocks of goods for office use or purposes. Business Group B occupancies shall include, but not be limited to, the following:

Airport traffic control towers  
Animal hospitals, kennels and pounds  
Banks  
Barber and beauty shops  
Civic administration offices  
Clinic—outpatient, including group medical centers, and neighborhood family care centers  
Custodial care facilities with fewer than 75 persons, providing care to persons over the age of 2, where no more than four occupants are incapable of responding to an emergency situation without physical assistance from staff  
Dry cleaning and laundries; pick-up and delivery stations and self-service  
Educational occupancies above the 12th grade, where not classified in Group A. Such

occupancy may be used occasionally for educational purposes offered to children through the 12<sup>th</sup> grade

Electronic data processing

Laboratories; non-production testing and research, as per Section 419

Libraries when not classified in Group E

Motor vehicle showrooms

Offices

Post offices

Photocopying and printing shops using electronic printing equipment

Professional services (architects, attorneys, dentists, physicians, engineers, etc.)

Radio and television stations not admitting an audience

Telephone exchanges

### **SECTION BC 305** **EDUCATIONAL GROUP E**

**305.1 Educational Group E.** Educational Group E occupancy includes, among others, the use of a building or structure, or a portion thereof, by five or more persons at any one time for educational purposes offered to children through the 12<sup>th</sup> grade and where no more than two children are under the age of 2, including but not limited to, the following:

Academies

Day care facilities where no more than two children are under the age of 2

Libraries accessory to Group E occupancies

Schools

#### **Exceptions:**

1. Classrooms and instructional rooms with 75 or more persons shall be classified as Group A-3.
2. Day care services provided within a dwelling unit as described in Section 310.
3. Custodial care facilities with up to 30 children under the age of 2 are permitted to be classified as Group E when the rooms where such children are cared for are located on the level of exit discharge and each of these child care rooms has an exit door directly to the exterior.

**305.2 Reserved.**

### **SECTION BC 306** **FACTORY GROUP F**



**306.1 Factory Industrial Group F.** Factory Industrial Group F occupancy includes, among others, the use of a building or structure, or a portion thereof, for assembling, disassembling, fabricating, finishing, manufacturing, packaging, repair, cleaning, laundering or processing operations that are not classified as a Group H hazardous occupancy.

**306.2 Factory Industrial F-1 Moderate-Hazard Occupancy.** Factory industrial uses which are not classified as Factory Industrial F-2 Low Hazard shall be classified as F-1 Moderate Hazard and shall include, but not be limited to, the following:

Aircraft

Aircraft repairs

Automobiles and other motor vehicles, manufacturing

Automobiles and other motor vehicles, repairs

Bakeries

Beverages; alcoholic

Boats

Boat repairs

Brooms or brushes

Canvas or similar fabric

Carpets and rugs

Carpets and rugs, cleaning, using or storing solvents having a flash point between 100°F (38°C) and 138.2°F (59°C) (Tag. Closed-cup)

Clothing

Disinfectants

Dry cleaning and dyeing using or storing solvents having a flash point between 100°F (38°C) and 138.2°F (59°C) (Tag. Closed-cup)

Electric generation plants

Engines (including rebuilding)

Food processing, except meat slaughtering or preparation of fish for packing

Furniture

Hemp products

Jute products

Laboratories; for production (moderate-hazard), that may involve the synthesis or storage of materials that constitute a physical or health hazard in quantities below those found in Tables 307.7(1) and 307.7(2)

Leather products

Metals; finishing, plating, grinding, sharpening, polishing, cleaning, rustproofing, heat treatment, or similar processes

Millwork (sash & door)

Motion pictures filming (without spectators)

Musical instruments

Optical goods

Paper mills or products

Photographic film

Plastic products  
Printing or publishing  
Recreational vehicles  
Refuse incineration  
Shoes  
Soaps and detergents  
Textiles  
Tobacco  
Trailers  
Upholstering  
Wood; distillation  
Woodworking (cabinet) using no more than 2 quarts (1.9 L) per day or storing no more than 20 gallons (75.7 L) of paint, varnish, lacquer or shellac

**306.3 Factory Industrial F-2 Low-Hazard Occupancy.** Factory industrial uses that involve the cleaning, laundering, fabrication or manufacturing of noncombustible materials which during finishing, packing or processing do not involve a significant fire hazard shall be classified as F-2 occupancies and shall include, but not be limited to, the following:

Appliances  
Athletic equipment  
Automobile laundries  
Automobile wrecking establishments  
Beverages; bottling works  
Beverages; non-alcoholic  
Bicycles  
Brick and masonry  
Business machines  
Cameras and photo equipment  
Carpets and rugs, cleaning, using or storing solvents having a flash point above 138.2°F (59°C) (Tag. closed-cup)  
Ceramic products  
Construction and agricultural machinery  
Dry cleaning and dyeing using or storing solvents having a flash point above 138.2°F (59°C) (Tag. closed-cup)  
Electronics  
Food processing; meat slaughtering or preparation of fish for packing  
Foundries  
Glass products  
Gypsum  
Ice  
Laboratories; for production (low-hazard), that may involve the synthesis or storage of materials that constitute a physical or health hazard in quantities below those found in Tables 307.7(1) and 307.7(2)

Laundries

Machinery

Metal products (fabrication and assembly), not including flammable metals and alloys listed in Section 307

Plastic products; non-flammable

Printing; incidental to primary use, area not exceeding 2,000 square feet (185.8 m<sup>2</sup>)

Television filming (without spectators)

**306.4 Location restrictions.** Locations of spaces within a building classified in Factory Group F may be restricted pursuant to Section 508.8

### **SECTION BC 307** **HIGH-HAZARD GROUP H**

**307.1 High-Hazard Group H.** High-Hazard Group H occupancy includes, among others, the use of a building or structure, or a portion thereof, that involves the manufacturing, processing, generation or storage of materials that constitute a physical or health hazard in quantities in excess of those found in Tables 307.7(1) and 307.7(2) (see also definition of “Control area”).

**Exception:** Laboratories for non-production testing, research, experimental, instructional or educational purposes, in compliance with Section 419.

**307.2 Definitions.** The following words and terms shall, for the purposes of this section and as used elsewhere in this code, have the meanings shown herein.

**AEROSOL.** A product that is dispensed from an aerosol container by a propellant.

Aerosol products shall be classified by means of the calculation of their chemical heats of combustion and shall be designated Level 1, 2 or 3.

**Level 1 aerosol products.** Those with a total chemical heat of combustion that is greater than 0 and less than or equal to 8,600 British thermal units per pound (Btu/lb) (20 kJ/g).

**Level 2 aerosol products.** Those with a total chemical heat of combustion that is greater than 8,600 Btu/lb (20 kJ/g), but less than or equal to 13,000 Btu/lb (30 kJ/g).

**Level 3 aerosol products.** Those with a total chemical heat combustion that is greater than 13,000 Btu/lb (30 kJ/g).

**BARRICADE.** A structure or other artificial or natural barrier constructed in connection with the storage, handling and use of explosives that provides a shield from the impact of such explosion. A straight line from the top of any sidewall of a building containing explosives to the eave line of any magazine or other building or to a point 12 feet (3658 mm) above the center of a railway or highway shall pass through such barrier.

**Artificial barricade.** An artificial mound or revetment, including a barrier constructed of sandbags, with a minimum thickness of 3 feet (914 mm).

**Natural barricade.** Terrain or other natural features of the ground.

**BOILING POINT.** The temperature at which the vapor pressure of a liquid equals the atmospheric pressure of 14.7 pounds per square inch (psi) (101 kPa) gage or 760 mm of mercury. Where an accurate boiling point is unavailable for the material in question, or for mixtures which do not have a constant boiling point, for the purposes of this classification, the 20-percent evaporated point of a distillation performed in accordance with ASTM D 86 shall be used as the boiling point of the liquid.

**CLOSED SYSTEM.** The use of a solid or liquid hazardous material involving a closed vessel or system that remains closed during normal operations where vapors emitted by the product are not liberated outside of the vessel or system and the product is not exposed to the atmosphere during normal operations; and all uses of compressed gases. Examples of closed systems for solids and liquids include product conveyed through a piping system into a closed vessel, system or piece of equipment.

**COMBUSTIBLE DUST.** Finely divided solid material that is 420 microns or less in diameter, will pass through a U.S. standard No. 40 sieve and, when dispersed in air in insufficient concentrations, can be ignited by a flame, spark or other source of ignition.

**COMBUSTIBLE FIBERS.** Readily ignitable and free-burning fibers, such as cocoa fiber, cotton, excelsior, hay, hemp, henequen, istle, jute, kapok, oakum, sisal, Spanish moss, straw, tow, wastepaper or other natural or synthetic fibers that possess such qualities.

**Exception:** Moss used for medicinal purposes.

**COMBUSTIBLE LIQUID.** For the purposes of transportation, a combustible liquid as defined by the United States Department of Transportation. For all other purposes, a liquid, other than a compressed gas or cryogenic fluid, having a closed cup flash point at or above 100°F (38°C) classified as follows:

**Class II.** Liquids having a closed cup flash point at or above 100°F (38°C) and below 140°F (60°C).

**Class IIIA.** Liquids having a closed cup flash point at or above 140°F (60°C) and below 200°F (93°C).

**Class IIIB.** Liquids having a closed cup flash point at or above 200°F (93°C).

**COMPRESSED GAS.** A material, or mixture of materials which is a gas at 68°F (20°C) or less at 14.7 psia (101 kPa) of pressure; and has a boiling point of 68°F (20°C) or less at 14.7 psia (101 kPa) that is either liquefied, nonliquefied or in solution at that temperature and pressure, except those gases which have no other health- or physical-hazard properties are not considered to be compressed until the pressure in the packaging exceeds 41 psia (28 kPa) at 68°F (20°C). Compressed gases shall be classified as follows:

**Nonliquefied compressed gases.** Gases, other than those in solution, which are in a packaging under the charged pressure and are entirely gaseous at a temperature of 68°F (20°C).

**Liquefied compressed gases.** Gases that, in a packaging under the charged pressure, are partially liquid at a temperature of 68°F (20°C).

**Compressed gases in solution.** Nonliquefied gases that are dissolved in a solvent.

**Compressed gas mixtures.** A mixture of two or more compressed gases contained in a single packaging, the hazard properties of which are represented by the properties of the mixture as a whole.

**CONTROL AREA.** Spaces within a building that are enclosed and bounded by exterior walls, fire walls, fire barriers and roofs, or a combination thereof, where quantities of hazardous materials not exceeding the maximum allowable quantities per control area are stored, handled, or used, including any dispensing.

**CORROSIVE MATERIAL.** A material that causes full thickness destruction of human skin at the site of contact within specified periods of time when tested by methods described in DOTn 49 CFR § 173.136 and 173.137. Liquid that has a severe corrosion rate on steel or aluminum based on the criteria in DOTn 49 CFR § 173.173(c)(2) is also a corrosive material.

**CRYOGENIC FLUID.** A liquid having a boiling point lower than -150°F (-101°C) at 14.7 pounds per square inch absolute (psia) (an absolute pressure of 101 kPa).

**DEFLAGRATION.** An exothermic reaction, such as the extremely rapid oxidation of a flammable dust or vapor in air, in which the reaction progresses through the unburned material at a rate less than the velocity of sound. A deflagration can have an explosive effect.

**DETACHED BUILDING.** A separate single-story building, without a basement or crawl space, used for the storage or use of hazardous materials and located at an approved distance from other buildings and structures.

**DETONATION.** An exothermic reaction characterized by the presence of a shock wave in the material which establishes and maintains the reaction. The reaction zone progresses through the

material at a rate greater than the velocity of sound. The principal heating mechanism is one of shock compression. Detonations have an explosive effect.

**DISPENSING.** The pouring or transferring of any material from a container, tank or similar vessel, whereby dusts, fumes, mists, vapors, or gases are liberated to the atmosphere.

**EXPLOSIVE.** Any chemical compound, mixture or device, the primary or common purpose of which is to function by explosion. The term includes, but is not limited to, dynamite, black powder, pellet powder, initiating explosives, detonators, safety fuses, squibs, detonating cord, igniter cord, igniters and display fireworks, 1.3G (Class B, Special).

The term “explosive” includes any material determined to be within the scope of 18 USC Chapter 40, as amended, and also includes any material classified as an explosive other than consumer fireworks, 1.4G (Class C, Common) by the hazardous materials regulations of DOTn 49 CFR.

**High explosive.** Explosive material, such as dynamite, which can be caused to detonate by means of a No. 8 test blasting cap when unconfined.

**Low explosive.** Explosive material that will burn or deflagrate when ignited. It is characterized by a rate of reaction that is less than the speed of sound. Examples of low explosives include, but are not limited to, black powder; safety fuse; igniters; igniter cord; fuse lighters; fireworks, 1.3G (Class B, Special) and propellants, 1.3C.

**UN/DOTn Class 1 explosives.** The former classification system used by DOTn included the terms “high” and “low” explosives as defined herein. The following terms further define explosives under the current system applied by DOTn for all explosive materials defined as hazard Class 1 materials. Compatibility group letters are used in concert with the division to specify further limitations on each division noted (i.e., the letter G identifies the material as a pyrotechnic substance or article containing a pyrotechnic substance and similar materials).

**Division 1.1.** Explosives that have a mass explosion hazard. A mass explosion is one which affects almost the entire load instantaneously.

**Division 1.2.** Explosives that have a projection hazard but not a mass explosion hazard.

**Division 1.3.** Explosives that have a fire hazard and either a minor blast hazard or a minor projection hazard or both, but not a mass explosion hazard.

**Division 1.4.** Explosives that pose a minor explosion hazard. The explosive effects are largely confined to the package and no projection of fragments of appreciable size or range is to be expected. An external fire must not cause virtually instantaneous explosion of almost the entire contents of the package.

**Division 1.5.** Very insensitive explosives. This division is comprised of substances that have a mass explosion hazard, but that are so insensitive there is very little probability of initiation or of transition from burning to detonation under normal conditions of transport.

**Division 1.6.** Extremely insensitive articles which do not have a mass explosion hazard. This division is comprised of articles that contain only extremely insensitive detonating substances and which demonstrate a negligible probability of accidental initiation or propagation.

**FIREWORKS.** Any composition or device for the purpose of producing a visible or audible effect for entertainment purposes by combustion, deflagration or detonation that meets the definition of 1.4G fireworks or 1.3G fireworks as set forth herein.

**FIREWORKS, 1.3G.** (Formerly Class B, Special Fireworks.) Large fireworks devices, which are explosive materials, intended for use in fireworks displays and designed to produce audible or visible effects by combustion, deflagration or detonation. Such 1.3G fireworks include, but are not limited to, firecrackers containing more than 130 milligrams (2 grains) of explosive composition, aerial shells containing more than 40 grams of pyrotechnic composition, and other display pieces which exceed the limits for classification as 1.4G fireworks. Such 1.3G fireworks are also described as fireworks, 49 CFR pt. 172 by the DOTn.

**FIREWORKS, 1.4G.** (Formerly Class C, Common Fireworks.) Small fireworks devices containing restricted amounts of pyrotechnic composition designed primarily to produce visible or audible effects by combustion. Such 1.4G fireworks which comply with the construction, chemical composition and labeling regulations of the DOTn for fireworks, 49 CFR pt. 172, and the U.S. Consumer Product Safety Commission (CPSC) as set forth in 16 CFR pts. 1500 and 1507, are not explosive materials for the purpose of this code.

**FLAMMABLE GAS.** A material which is a gas at 68°F (20°C) or less at 14.7 pounds per square inch absolute (psia) (101 kPa) of pressure (a material that has a boiling point of 68°F (20°C) or less at 14.7 psia (101 kPa)) which:

1. Is ignitable at 14.7 psia (101 kPa) when in a mixture of 13 percent or less by volume with air; or
2. Has a flammable range at 14.7 psia (101 kPa) with air of at least 12 percent, regardless of the lower limit.

The limits specified shall be determined at 14.7 psia (101 kPa) of pressure and a temperature of 68°F (20°C) in accordance with ASTM E 681.

**FLAMMABLE LIQUEFIED GAS.** A liquefied compressed gas which, under a charged pressure, is partially liquid at a temperature of 68°F (20°C) and which is flammable.

**FLAMMABLE LIQUID.** For the purposes of transportation, a combustible liquid as defined by the United States Department of Transportation. For all other purposes, a liquid, other than a compressed gas or cryogenic fluid, having a closed cup flash point below 100°F (38°C) classified as follows:

**Class IA.** Liquids having a flash point below 73°F (23°C) and a boiling point below 100°F (38°C).

**Class IB.** Liquids having a flash point below 73°F (23°C) and a boiling point at or above 100°F (38°C).

**Class IC.** Liquids having a flash point at or above 73°F (23°C) and below 100°F (38°C)

**FLAMMABLE MATERIAL.** A material capable of being readily ignited from common sources of heat or at a temperature of 600°F (316°C) or less.

**FLAMMABLE SOLID.** A solid, other than a blasting agent or explosive, that is capable of causing fire through friction, absorption or moisture, spontaneous chemical change, or retained heat from manufacturing or processing, or which has an ignition temperature below 212°F (100°C) or which burns so vigorously and persistently when ignited as to create a serious hazard. A chemical shall be considered a flammable solid as determined in accordance with the test method of 16 CFR pt. 1500.44, if it ignites and burns with a self-sustained flame at a rate greater than 0.1 inch (2.5 mm) per second along its major axis. This shall include flammable metals, which are flammable pure metals or their flammable alloys.

**FLASH POINT.** The minimum temperature in degrees Fahrenheit at which a liquid will give off sufficient vapors to form an ignitable mixture with air near the surface or in the container, but will not sustain combustion. The flash point of a liquid shall be determined by appropriate test procedure and apparatus as specified in ASTM D 56, ASTM D 93 or ASTM D 3278.

**HANDLING.** The movement of a material in its container, the removal of the material from its container, or any other action or process that may affect the material, other than its storage or use.

**HAZARDOUS MATERIALS.** Those chemicals or substances that are physical hazards or health hazards as defined and classified in this section and the *New York City Fire Code*, whether the materials are in usable or waste condition.

**HEALTH HAZARD.** A classification of a chemical for which there is statistically significant evidence that acute or chronic health effects are capable of occurring in exposed persons. The term “health hazard” includes chemicals that are toxic or highly toxic, and corrosive.



**HIGHLY TOXIC MATERIAL.** A material that is lethal at the following doses or concentrations:

1. A chemical that has a median lethal dose (LD50) of 50 milligrams or less per kilogram of body weight when administered orally to albino rats weighing between 200 and 300 grams each; or
2. A chemical that has a median lethal dose (LD50) of 200 milligrams or less per kilogram of body weight when administered by continuous contact for 24 hours (or less if death occurs within 24 hours) with the bare skin of albino rabbits weighing between 2 and 3 kilograms each; or
3. A chemical that has a median lethal concentration (LC50) in air of 200 parts per million by volume or less of gas or vapor, or 2 milligrams per liter or less of mist, fume or dust, when administered by continuous inhalation for 1 hour (or less if death occurs within 1 hour) to albino rats weighing between 200 and 300 grams each.

**INCOMPATIBLE MATERIALS.** Materials that, if mixed or combined, could explode, generate heat, gases or other byproducts, or react in such a way hazardous to life or property.

**OPEN SYSTEM.** The use of a solid or liquid hazardous material involving a vessel or system that is continuously open to the atmosphere during normal operations and where vapors are liberated, or the product is exposed to the atmosphere during normal operations. Examples of open systems for solids and liquids include dispensing from or into open beakers or containers, dip tank and plating tank operations.

**ORGANIC PEROXIDE.** An organic compound having a double oxygen or peroxy (-O-O-) in its chemical structure. Organic peroxides can pose an explosion hazard (detonation or deflagration), can be shock sensitive, or can be susceptible to decomposition into various unstable compounds over an extended period of time and are classified as follows based upon their hazardous properties:

**Class I.** Organic peroxides that are capable of deflagration but not detonation.

**Class II.** Organic peroxides that burn very rapidly and that pose a moderate reactivity hazard.

**Class III.** Organic peroxides that burn rapidly and that pose a moderate reactivity hazard.

**Class IV.** Organic peroxides that burn in the same manner as ordinary combustibles and that pose a minimal reactivity hazard.

**Class V.** Organic peroxides that burn with less intensity than ordinary combustibles or do not sustain combustion and that pose no reactivity hazard.

**Unclassified detonable.** Organic peroxides that are capable of detonation and pose an extremely high explosion hazard through rapid explosive decomposition.

**OXIDIZER.** A material that readily yields oxygen or other oxidizing gas, such as bromine, chlorine and fluorine, or that readily reacts to promote or initiate combustion of combustible materials classified as follows:

**Class 1.** An oxidizer whose primary hazard is that it slightly increases the burning rate but which does not cause spontaneous ignition when it comes in contact with combustible materials.

**Class 2.** An oxidizer that will cause a moderate increase in the burning rate or that causes spontaneous ignition of combustible materials with which it comes in contact.

**Class 3.** An oxidizer that will cause a severe increase in the burning rate of combustible materials with which it comes in contact or that will undergo vigorous self-sustained decomposition due to contamination or exposure to heat.

**Class 4.** An oxidizer that can undergo an explosive reaction due to contamination or exposure to thermal or physical shock. Additionally, the oxidizer will enhance the burning rate and can cause spontaneous ignition of combustibles.

**OXIDIZING GAS.** A gas that can support and accelerate combustion of other materials.

**PHYSICAL HAZARD.** A chemical for which there is evidence that it is a combustible liquid, compressed gas, cryogenic, explosive, flammable gas, flammable liquid, flammable solid, organic peroxide, oxidizer, pyrophoric or unstable (reactive) or water-reactive material.

**PYROPHORIC MATERIAL.** A material with an autoignition temperature in air, at or below a temperature of 130°F (54°C).

**PYROTECHNIC COMPOSITION.** A chemical mixture that produces visible light displays or sounds through a self-propagating, heat-releasing chemical reaction which is initiated by ignition.

**STANDARD CUBIC FEET (SCF).** Cubic feet of gas at normal temperature and pressure (NTP).

**TOXIC MATERIAL.** A chemical that is lethal at the following doses or concentrations:

1. A chemical that has a median lethal dose (LD50) of more than 50 milligrams per kilogram, but not more than 500 milligrams per kilogram of body weight when administered orally to albino rats weighing between 200 and 300 grams each; or

2. A chemical that has a median lethal dose (LD50) of more than 200 milligrams per kilogram but not more than 1,000 milligrams per kilogram of body weight when administered by continuous contact for 24 hours (or less if death occurs within 24 hours) with the bare skin of albino rabbits weighing between 2 and 3 kilograms each; or
3. A chemical that has a median lethal concentration (LC50) in air of more than 200 parts per million but not more than 2,000 parts per million by volume of gas or vapor, or more than 2 milligrams per liter but not more than 20 milligrams per liter of mist, fume or dust, when administered by continuous inhalation for 1 hour (or less if death occurs within 1 hour) to albino rats weighing between 200 and 300 grams each.

**Exception:** For purposes of this code, chlorine shall be classified as a highly toxic material.

**UNSTABLE (REACTIVE) MATERIAL.** A material, other than an explosive, which in the pure state or as commercially produced, will vigorously polymerize, decompose, condense or become self-reactive and undergo other violent chemical changes, including explosion, when exposed to heat, friction or shock, or in the absence of an inhibitor, or in the presence of contaminants, or in contact with incompatible materials. Unstable (reactive) materials are shall be classified as follows:

**Class 1.** Materials that in themselves are normally stable but which can become unstable at elevated temperatures and pressure.

**Class 2.** Materials that in themselves are normally unstable and readily undergo violent chemical change but do not detonate. This class includes materials that can undergo chemical change with rapid release of energy at normal temperatures and pressures, and that can undergo violent chemical change at elevated temperatures and pressures.

**Class 3.** Materials that in themselves are capable of detonation or of explosive decomposition or explosive reaction but which require a strong initiating source or which must be heated under confinement before initiation. This class includes materials that are sensitive to thermal or mechanical shock at elevated temperatures and pressures.

**Class 4.** Materials that in themselves are readily capable of detonation or explosive decomposition or explosive reaction at normal temperatures and pressures. This class includes materials that are sensitive to mechanical or localized thermal shock at normal temperatures and pressures.

**WATER-REACTIVE MATERIAL.** A material that explodes; violently reacts; produces flammable, toxic or other hazardous gases; or evolves enough heat to cause self-ignition or ignition of nearby combustibles upon exposure to water or moisture. Water-reactive materials shall be classified as follows:

Class 1. Materials that may react with water with some release of energy, but not violently.

Class 2. Materials that may form potentially explosive mixtures with water.

Class 3. Materials that react explosively with water without requiring heat or confinement.

**307.3 High-Hazard Group H-1. Buildings and structures which contain materials that present a detonation hazard shall be classified as Group H-1. Such materials shall include, but not be limited to, the following:**

Explosives:

Division 1.1

Division 1.2

Division 1.3

**Exception:** Materials that are used and maintained in a form where either confinement or configuration will not elevate the hazard from a mass fire to mass explosion hazard shall be allowed in H-2 occupancies.

Division 1.4

**Exception:** Articles, including articles packaged for shipment, that are not regulated as an explosive under Bureau of Alcohol, Tobacco and Firearms regulations, or unpackaged articles used in process operations that do not propagate a detonation or deflagration between articles shall be allowed in H-3 occupancies.

Division 1.5

Division 1.6

Organic peroxides, unclassified detonable

Oxidizers, Class 4

Unstable (reactive) materials, Class 3 detonable and Class 4

Pyrophoric materials, detonable

Water-reactive materials, Class 2 and 3, detonable

No part of this section shall be construed to authorize the manufacture, storage, sale or use of explosives, including fireworks, if otherwise prohibited by the *New York City Fire Code* and unless in compliance with the requirements of the *New York City Fire Code*.

**307.4 High-Hazard Group H-2. Buildings and structures which contain materials that present a deflagration hazard or a hazard from accelerated burning shall be classified as Group H-2. Such materials shall include, but not be limited to, the following:**

Class I, II or IIIA flammable or combustible liquids which are used or stored in normally open containers or systems, or in closed containers or systems pressurized at more than 15 psi (103.4 kPa) gage.

Combustible dusts

Cryogenic fluids, flammable

Flammable gases

Organic peroxides, Class I

Oxidizers, Class 3, that are used or stored in normally open containers or systems, or in closed containers or systems pressurized at more than 15 psi (103.3 kPa) gage

Pyrophoric liquids, solids and gases, nondetonable

Unstable (reactive) materials, Class 3, nondetonable

Water-reactive materials, Class 3, nondetonable

No part of this section shall be construed to authorize an LPG-distribution facility if otherwise prohibited by the *New York City Fire Code*.

**307.5 High-Hazard Group H-3.** Buildings and structures that contain materials that readily support combustion or present a physical hazard shall be classified as Group H-3. Such materials shall include, but not be limited to, the following:

Class I, II or IIIA flammable or combustible liquids which are used or stored in normally closed containers or systems pressurized at less than 15 psi (103 kPa) gage.

Combustible fibers

Cryogenic fluids, oxidizing

Flammable solids

Organic peroxides, Classes II and III

Oxidizers, Classes 1 and 2

Oxidizing gases

Unstable (reactive) materials, Class 2

Water-reactive materials, Class 2, nondetonable

**307.6 High-Hazard Group H-4.** Buildings and structures which contain materials that are health hazards shall be classified as Group H-4. Such materials shall include, but not be limited to, the following:

Corrosives

Highly toxic materials

Toxic materials

**307.7 Group H-5 structures.** Semiconductor fabrication facilities and comparable research and development areas in which hazardous production materials (HPM) are used and the aggregate

quantity of materials is in excess of those listed in Tables 307.7(1) and 307.7(2). Such facilities and areas shall be designed and constructed in accordance with Section 415.9.

**TABLE 307.7(1)**  
**MAXIMUM ALLOWABLE QUANTITY PER CONTROL AREA OF HAZARDOUS**  
**MATERIALS POSING A PHYSICAL HAZARD<sup>a, j, m</sup>**  
**(Table 307.7(1) attached to end of document)**

**TABLE 307.7(2)**  
**MAXIMUM ALLOWABLE QUANTITY PER CONTROL AREA OF HAZARDOUS**  
**MATERIAL POSING A HEALTH HAZARD<sup>a, b, c</sup>**  
**(Table 307.7(2) attached to end of document)**

**307.8 Multiple hazards.** Buildings and structures containing a material or materials representing hazards that are classified in one or more of Groups H-1, H-2, H-3 and H-4 shall conform to the code requirements for each of the occupancies so classified.

**307.9 Exceptions:** The following shall not be classified in Group H, but shall be classified in the occupancy which they most nearly resemble. Hazardous materials in any quantity shall conform to the requirements of this code, including Section 414, and the *New York City Fire Code*.

1. Buildings and structures that contain not more than the maximum allowable quantities per control area of hazardous materials as shown in Tables 307.7(1) and 307.7(2) provided that such buildings are maintained in accordance with the *New York City Fire Code*.
2. Buildings utilizing control areas in accordance with Section 414.2 that contain not more than the maximum allowable quantities per control area of hazardous materials as shown in Tables 307.7(1) and 307.7(2).
3. Buildings and structures occupied for the application of flammable finishes, provided that such buildings or areas conform to the requirements of Section 416 and the *New York City Fire Code*.
4. Wholesale and retail sales and storage of flammable and combustible liquids in mercantile occupancies conforming to the *New York City Fire Code*.
5. Closed systems housing flammable or combustible liquids or gases utilized for the operation of machinery or equipment.
6. Cleaning establishments that utilize combustible liquid solvents having a flash point of 140°F (60°C) or higher in closed systems employing equipment listed by an approved testing agency, provided that this occupancy is separated from all other areas of the

building by 1-hour fire-resistance-rated fire barrier walls or horizontal assemblies or both.

7. Cleaning establishments that utilize a liquid solvent having a flash point at or above 200°F (93°C).

8. Liquor stores and distributors without bulk storage.

9. Refrigeration systems.

10. The storage or utilization of materials for agricultural purposes on the premises.

11. Stationary batteries utilized for facility emergency power, uninterrupted power supply or telecommunication facilities provided that the batteries are provided with safety venting caps and ventilation is provided in accordance with the *New York City Mechanical Code*.

12. Corrosives shall not include personal or household products in their original packaging used in retail display or commonly used building materials.

13. Buildings and structures occupied for aerosol storage shall be classified as Group S-1, provided that such buildings conform to the requirements of the *New York City Fire Code*.

14. Display and storage of nonflammable solid and nonflammable or noncombustible liquid hazardous materials in quantities not exceeding the maximum allowable quantity per control area in Group M or S occupancies complying with Section 414.2.4.

15. The storage of black powder, smokeless propellant and small arms primers in Groups M and R-3 and special industrial explosive devices in Groups B, F, M and S, provided such storage conforms to the quantity limits and requirements prescribed in the *New York City Fire Code*.

## **SECTION 308** **INSTITUTIONAL GROUP I**

**308.1 Institutional Group I.** Institutional Group I occupancy includes, among others, the use of a building or structure, or a portion thereof, in which people are cared for or live in a supervised environment, having physical limitations because of health or age are harbored for medical treatment or other care or treatment, or in which people are detained for penal or correctional purposes or in which the liberty of the occupants is restricted. Institutional occupancies shall be classified as Group I-1, I-2, I-3 or I-4.

**308.1.1 Definitions.** For definitions of terms related to Group I occupancy classification, see Section 310.2.

**308.2 Group I-1.** This occupancy shall include buildings, structures or parts thereof housing persons, on a 24-hour basis, who because of age, mental disability or other reasons, live in a supervised residential environment that provides personal care services. The occupants are capable of self-preservation and capable of responding to an emergency situation without physical assistance from staff. Such occupancy shall be subject to the New York State Multiple Dwelling Law. This group shall include, but not be limited to, the following:

Adult homes, where occupants are capable of self-preservation (see Section 308.2.1)

Alcohol and drug abuse rehabilitation centers

Assisted living facilities

Community Residences or Intermediate Care Facilities (see Section 308.2.2)

Congregate care facilities

Convalescent facilities

Enriched housing, where occupants are capable of self-preservation (see Section 308.2.1)

Halfway houses

Overnight child care facilities where all supervised occupants are under the age of 18, with no more than two children under the age of 2

Residential care facilities

Social rehabilitation facilities

**308.2.1 Adult homes and enriched housing.** Adult homes and enriched housing facilities operated pursuant to and meeting the additional construction requirements of Section 460 of the New York State Social Services Law and regulations of the New York State Department of Health offering care on a 24-hour basis to persons capable of self-preservation, in the same building, shall be classified as Group I-1.

**Exception:** Such a facility offering supervised care on a 24-hour basis for no more than 16 occupants capable of self preservation, in the same building, may be classified in Group R in accordance with Section 310.

**308.2.2 Community Residences or Intermediate Care Facilities.** Community Residences or Intermediate Care Facilities, operated pursuant to and meeting the additional construction requirements of the New York State Mental Hygiene Law and applicable regulations of the New York State Office of Mental Health and Office of Mental Retardation and Developmental Disabilities shall be classified as Group I-1.

**Exceptions:** Such facilities limited to 14 residents capable of self-preservation and three staff members per dwelling unit shall be classified as:

1. Group R-1, where such facility does not occupy more than two dwelling units in a residential building classified as R-1 of Type I or II construction, or one



dwelling unit in any other type of construction, and occupied on a transient basis;  
or

2. Group R-2 where such facility does not occupy more than two dwelling units in a residential building classified R-2 of Type I or II construction, or one dwelling unit in any other type of construction, and occupied on a long-term basis; or
3. Group R-3 where the number of dwelling units in the building does not exceed two.

**308.3 Group I-2.** This occupancy shall include buildings and structures used for medical, surgical, psychiatric, nursing or personal care on a 24-hour basis or overnight of more than two children under the age of 2, or more than three persons who are not capable of self-preservation and not capable of responding to an emergency situation without physical assistance from staff. This group shall include, but not be limited to, the following:

Adult homes, where occupants are not capable of self-preservation, operated pursuant to and meeting the additional construction requirements of Section 460 of the New York State Social Services Law and regulations of the New York State Department of Health

Community Residences or Intermediate Care Facilities, where occupants are not capable of self preservation, operated pursuant to and meeting the additional construction requirements of the New York State Mental Hygiene Law and applicable regulations of the New York State Office of Mental Health and Office of Mental Retardation and Developmental Disabilities

Enriched Housing, where occupants are not capable of self-preservation, operated pursuant to and meeting the additional construction requirements of Section 460 of the New York State Social Services Law and regulations of the New York State Department of Health

Hospitals

Nursing homes (both intermediate-care facilities and skilled nursing facilities)

Mental hospitals where patients are not under restraint

Detoxification facilities

**Exception:** Such a facility offering care on a 24-hour basis for 3 or fewer persons who are not capable of self preservation may occupy not more than one dwelling unit in a residential building classified in R-1, R-2 or R-3.

**308.4 Group I-3.** This occupancy shall include buildings and structures that are inhabited by more than five persons who are under restraint or security. An I-3 facility is occupied by persons who are generally incapable of self-preservation due to security measures not under the occupants' control. This group shall include, but not be limited to, the following:

Mental hospitals where patients are under restraint

Prisons

Jails

Reformatories  
Detention centers  
Correctional centers  
Prerelease centers

Buildings of Group I-3 shall be classified as one of the occupancy conditions indicated in Section 408.1.

**308.5 Group I-4.** This group shall include custodial care facilities providing care to more than two children under the age of 2, or to more than four persons over the age of 2 who are not capable of responding to an emergency situation without physical assistance from the staff. Such occupancy shall include, but not be limited to, adult custodial care facilities and day nurseries.

**Exceptions:**

1. Custodial care facility as described in Section 303.
2. Custodial care facility as described in Section 304.
3. Custodial care facility as described in Exception 3 of Section 305.1.
4. Such facility providing care within a dwelling unit as described in Section 310.
5. Such facility providing care to children under the age of 2 in houses of worship during religious functions.

**SECTION BC 309**  
**MERCANTILE GROUP M**

**309.1 Mercantile Group M.** Mercantile Group M occupancy includes, among others, buildings and structures or a portion thereof, for the display and sale of merchandise, and involves stocks of goods, wares or merchandise incidental to such purposes and accessible to the public. Mercantile occupancies shall include, but not be limited to, the following:

Department stores  
Drug stores  
Markets  
Motor fuel-dispensing facilities  
Retail or wholesale stores  
Sales rooms

**309.2 Quantity of hazardous materials.** The aggregate quantity of nonflammable solid and nonflammable or noncombustible liquid hazardous materials stored or displayed in a single control area of a Group M occupancy shall not exceed the quantities in Table 414.2.4.

**SECTION 310**  
**RESIDENTIAL GROUP R**

**310.1 Residential Group R.** Residential Group R includes, among others, the use of a building or structure, or a portion thereof, for dwelling or sleeping purposes when not classified as Institutional Group I. Buildings containing 3 or more dwelling units shall be subject to the New York State Multiple Dwelling Law. Residential occupancies shall be classified as Groups R-1, R-2, or R-3.

**310.1.1 Group R-1.** This occupancy shall include:

1. Residential buildings or spaces occupied, as a rule, transiently, for a period less than one month, as the more or less temporary abode of individuals or families who are lodged with or without meals, including, but not limited to, the following:

Class B multiple dwellings as defined in Section 27-2004 of the *New York City Housing Maintenance Code* and Section 4 of the New York State Multiple Dwelling Law

**Exception:** Class B multiple dwellings classified in Group I-1.

Club houses.  
Hotels (transient)  
Motels (transient)  
Rooming houses (boarding houses – transient)  
Settlement houses  
Vacation timeshares

2. College or school student dormitories, except for student apartments classified as an R-2 occupancy
3. Congregate living units owned and operated by a government agency or not-for-profit organization, where the number of occupants exceeds the limitations of a family as defined, including, but not limited to, the following:

Adult homes or enriched housing with 16 or fewer occupants requiring supervised care within the same building on a 24-hour basis  
Fraternity and sorority houses  
Homeless shelters

**310.1.2 Group R-2.** This occupancy shall include buildings or portions thereof containing sleeping units or more than two dwelling units that are occupied, as a rule, for shelter and sleeping accommodation on a long-term basis for a month or more at a time. Such occupancy shall be subject to the New York State Multiple Dwelling Law. This group shall include, but not be limited to, the following:

Adult homes or enriched housing with 16 or fewer occupants requiring supervised care on a 24-hour basis in the same building, provided that the number of occupants per dwelling unit does not exceed the definition of a family

Apartment houses

Apartment hotels (nontransient)

Class A multiple dwellings as defined in Section 27-2004 of the *New York City Housing Maintenance Code* and Section 4 of the New York State Multiple Dwelling Law, including the following:

1. Dwelling units where the resident of the unit provides custodial care to no more than four persons on less than a 24-hour basis and not overnight.
2. Dwelling units where the resident of the unit provides child custodial care as a family day care home registered with the New York City Department of Health and Mental Hygiene in accordance with the New York State Social Services Law with no more than six children between the ages of 2 and 13, or with no more than five children if any are under the age of 2, receiving supervised care on less than a 24-hour basis and not overnight.

**Exception:** Class A multiple dwellings classified in Group I-1.

Convents and monasteries with more than 20 occupants in the building

Student apartments

**310.1.3 Group R-3.** This occupancy shall include residential occupancies that are occupied for the shelter and sleeping accommodation of individuals on a month-to-month or longer-term basis, and that are not classified as R-1, R-2 or I. This occupancy shall include buildings or portions thereof containing no more than 2 apartments, occupied, as a rule, for shelter and sleeping accommodation on a long term basis for a month or more at a time, and are not classified in Group R-1, R-2 or I. This group shall include, but not be limited to, the following:

Convents and monasteries with fewer than 20 occupants in the building

Group homes

One- and two-family dwellings, including the following:

1. Dwelling units where the resident of the unit provides custodial care to no more than four persons on less than a 24-hour basis and not overnight.

2. Dwelling units where the resident of the unit provides child custodial care as a family day care home registered with the New York City Department of Health and Mental Hygiene in accordance with the New York State Social Services Law with no more than six children between the ages of 2 and 13, or with no more than five children if any are under the age of 2, receiving supervised care on less than a 24 hour basis and not overnight.

**310.2 Definitions.** The following words and terms shall, for the purposes of this section and as used elsewhere in this code, have the meanings shown herein.

**APARTMENT.** A dwelling unit providing permanent provisions for both sanitation and kitchen facilities, occupied or arranged to be occupied by not more than one family maintaining a common household.

**APARTMENT, STUDENT.** An apartment occupied or arranged to be occupied by students enrolled at a single accredited college or university and maintaining a common household pursuant to a lease, sublease, or occupancy agreement directly with such college or university.

**BOARDER (ROOMER, LODGER).** A person who pays a consideration for living within the household and does not occupy such space as an incident of employment.

**CONGREGATE LIVING UNIT.** A dwelling unit, comprised of one or more habitable rooms separated by non-rated partitions, occupied or arranged to be occupied by more than one family or by persons who are not maintaining a common household. Creation of or conversion to such unit shall be subject to Section 27-2077 of the *New York City Housing Maintenance Code*.

**CUSTODIAL CARE FACILITY.** A building or part thereof occupied by persons, on less than a 24-hour basis and not overnight, who because of age, disability or other reasons, receive personal care services by individuals other than parents or guardians, relatives by blood, marriage, domestic partnership, or adoption, in a place other than the home of the person cared for.

**DWELLING.** A building or structure which is occupied in whole or in part as the home, residence or sleeping place of one or more families.

**DWELLING, MULTIPLE.** A dwelling which is either rented, leased, let or hired out, to be occupied, or is occupied, as the residence or home of three or more families living independently of each other. A multiple dwelling does not include a building used for occupancies in Groups I-2, I-3 or I-4.

**DWELLING, ONE-FAMILY.** Any building or structure designed and occupied exclusively for residence purposes on a long-term basis for more than a month at a time by not more than one family. One-family dwellings shall also be deemed to include a dwelling located in a series

of one-family dwellings each of which faces or is accessible to a legal street or public thoroughfare, provided that each such dwelling unit is equipped as a separate dwelling unit with all essential services, and also provided that each such unit is arranged so that it may be approved as a legal one-family dwelling.

**DWELLING, TWO-FAMILY.** Any building or structure designed and occupied exclusively for residence purposes on a long-term basis for more than a month at a time by not more than two families. Two-family dwellings shall also be deemed to include a dwelling located in a series of two-family dwellings each of which faces or is accessible to a legal street or public thoroughfare, provided that each such dwelling is equipped as a separate dwelling with all essential services, and also provided that each such dwelling is arranged so that it may be approved as a legal two-family dwelling.

**DWELLING UNIT.** A single unit consisting of one or more habitable rooms and occupied or arranged to be occupied as a unit separate from all other units within a dwelling.

**FAMILY.**

1. A single person occupying a dwelling unit and maintaining a common household with not more than two boarders, roomers or lodgers; or
2. Two or more persons related by blood, adoption, legal guardianship, marriage or domestic partnership; occupying a dwelling unit and maintaining a common household with not more than two boarders, roomers or lodgers; or
3. Not more than three unrelated persons occupying a dwelling unit and maintaining a common household; or
4. Not more than three unrelated persons occupying a dwelling unit in a congregate housing or shared living arrangement and maintaining a common household; or
5. Members of a group home; or
6. Foster children placed in accordance with provisions of the New York State Social Services Law, their foster parent(s), and other persons related to the foster parents by blood, marriage or domestic partnership; where all residents occupy and maintain a common household with not more than two boarders, roomers or lodgers; or
7. Up to seven unrelated students enrolled at a single accredited college or university occupying a dwelling unit and maintaining a common household pursuant to a lease, sublease, or occupancy agreement directly with such college or university, provided that:
  - 7.1. The entire structure in which the dwelling unit is located is fully sprinklered in accordance with Chapter 9; and

7.2. Such occupancy does not exceed the maximums contained in Section 27-2075(a) of the *New York City Housing Maintenance Code*; and

7.3. Prior to commencement of such occupancy, and on an annual basis thereafter such college or university has submitted a fire safety plan containing fire safety and evacuation procedures for such dwelling unit that is acceptable to the Fire Commissioner and in compliance with any rules promulgated by the Fire Commissioner; and

7.4. The dwelling unit complies with additional occupancy and construction requirements as may be established by rule by the Housing Preservation and Development Commissioner.

A common household is deemed to exist if all household members have access to all parts of the dwelling unit. Lack of access to all parts of the dwelling unit establishes a rebuttable presumption that no common household exists.

**GROUP HOME.** A facility for the care and maintenance of not fewer than seven nor more than twelve children, supervised by the New York State Board of Social Welfare, and operated pursuant to and meeting any additional construction requirements of Section 374-c of the New York State Social Services Law and applicable regulations of the New York State Department of Social Services. Such a facility occupied by more than twelve children shall be classified as Group I-1.

**PERSONAL CARE SERVICE.** The care of residents who do not require chronic or convalescent medical or nursing care. Personal care involves responsibility for the safety of the resident while inside the building.

**RESIDENTIAL CARE/ASSISTED LIVING FACILITIES.** A building or part thereof housing persons, on a 24-hour basis, who because of age, mental disability or other reasons, live in a supervised residential environment which provides personal care services. The occupants are capable of self-preservation and are capable of responding to an emergency situation without physical assistance from staff. This classification shall include, but not be limited to, the following: residential board and care facilities, assisted living facilities, halfway houses, congregate care facilities, social rehabilitation facilities, alcohol and drug abuse rehabilitation centers and convalescent facilities.

**ROOMING HOUSE.** A dwelling (i) which was originally erected as a single- or two-family private dwelling pursuant to the *New York City Building Code* in effect prior to December 6, 1968, (ii) which is a “Class B converted dwelling” as such term is defined in the *New York City Housing Maintenance Code*, and (iii) which has more than half of its habitable rooms as sleeping units. The creation of or conversion to a rooming house shall be limited by Section 27-2077 of the *New York City Housing Maintenance Code*.

**SLEEPING UNIT.** A dwelling unit, which may contain either toilet or kitchen facilities but not both. Any sleeping unit housing more than one family shall also be classified as a congregate living unit. The creation of or conversion to sleeping units shall be limited by Section 27-2077 of the *New York City Housing Maintenance Code*.

## **SECTION BC 311** **STORAGE GROUPS**

**311.1 Storage Group S.** Storage Group S occupancy includes, among others, the use of a building or structure, or a portion thereof, for storage, such as for warehouses, storage rooms, freight depots and distribution centers, when not classified as a hazardous occupancy.

**311.2 Moderate-hazard storage, Group S-1.** Buildings occupied for storing any flammable or combustible materials that are likely to permit the development and production of fire with moderate rapidity including, but not limited to, storage of the following:

Aerosols, Levels 2 and 3  
Bags; cloth, burlap and paper  
Bamboos and rattan  
Baskets  
Belting; canvas and leather  
Books and paper in rolls or packs  
Boots and shoes  
Buttons, including cloth covered, pearl or bone  
Cardboard and cardboard boxes  
Clothing, woolen wearing apparel  
Cordage  
Furniture  
Furs  
Glues, mucilage, pastes and size  
Grains  
Horns and combs, other than celluloid  
Leather  
Linoleum  
Lumber  
Photo engravings  
Resilient flooring  
Silks  
Soaps  
Sugar  
Tires, bulk storage of  
Tobacco, cigars, cigarettes and snuff  
Upholstery and mattresses



Wax candles

**311.3 Low-hazard storage, Group S-2.** Includes, among others, buildings used for the storage of noncombustible materials such as products on wood pallets or in paper cartons with or without single thickness divisions; or in paper wrappings. Such products are permitted to have a negligible amount of plastic trim, such as knobs, handles or film wrapping. Storage uses shall include, but not be limited to, storage of the following:

Asbestos

Beverages up to and including 12-percent alcohol in metal, glass or ceramic containers

Cement in bags

Chalk and crayons

Dairy products in nonwaxed coated paper containers

Dry cell batteries

Electrical coils

Electrical motors

Empty cans

Food products

Foods in noncombustible containers

Fresh fruits and vegetables in nonplastic trays or containers

Frozen foods

Glass

Glass bottles, empty or filled with noncombustible liquids

Gypsum board

Inert pigments

Ivory

Meats

Metal cabinets

Metal desks with plastic tops and trim

Metal parts

Metals

Mirrors

Oil-filled and other types of distribution transformers

Parking garages, open or enclosed

Porcelain and pottery

Stoves

Talc and soapstones

Washers and dryers

## **SECTION BC 312** **UTILITY AND MISCELLANEOUS GROUP U**

**312.1 General.** Buildings and structures of an accessory character and miscellaneous structures not classified in any specific occupancy shall be constructed, equipped and maintained to

conform to the requirements of this code commensurate with the fire and life hazard incidental to their occupancy. Group U shall include, but not be limited to, the following:

Carports

Fences more than 6 feet (1829 mm) high

Private garages as per Section 406.1

Retaining walls

Sheds or greenhouses accessory to Group R-3 occupancies, that are: freestanding, less than 120 square feet (11.15 m<sup>2</sup>) in area, not permanently affixed to the ground, and used for household goods or items associated with the garden or lawn. Any other shed shall be classified as either S-1 or S-2.

Tanks

Towers

**TABLE 302.1.1  
INCIDENTAL USE AREAS**

<b>ROOM OR AREA</b>	<b>SEPARATION<sup>a</sup></b>
Furnace room where any piece of equipment is over 400,000 Btu per hour input	2 hour; or 1 hour and provide automatic fire-extinguishing system
Furnace room where any piece of equipment is 400,000 Btu per hour input or less, except in R-3 occupancy	1 hour or provide automatic sprinkler system
Rooms with any boiler over 15 psi and 10 horsepower	2 hour; or 1 hour and provide automatic fire-extinguishing system
Rooms with any boiler 15 psi or less and 10 horsepower or less, except in R-3 occupancy	1 hour or provide automatic sprinkler system
Mechanical and/or electrical equipment room, except in R-3 occupancy	1 hour or provide automatic sprinkler system
Refrigerant machinery rooms	1 hour or provide automatic sprinkler system
Parking garage (Section 406.2)	2 hours; or 1 hour and provide automatic fire-extinguishing system
Hydrogen cut-off rooms	2-hour fire barriers and floor/ceiling assemblies in all occupancy groups.
Incinerator rooms	2 hours and automatic sprinkler system
Paint shops, not classified as Group H, located in occupancies other than Group F	2 hours; or 1 hour and provide automatic fire-extinguishing system
Laboratories and vocational shops, not classified as Group H, located in Group E or I-2 occupancies	2 hour; or 1 hour and provide automatic fire-extinguishing system
Laundry rooms over 100 square feet, except within dwelling units	1 hour or provide automatic fire-extinguishing system
Storage rooms over 100 square feet, except in R-3 occupancy	1 hour or provide automatic fire-extinguishing system
Group I-3 cells equipped with padded surfaces	1 hour
Group I-2 waste and linen collection rooms	1 hour
Waste and linen collection rooms over 100 square feet	1 hour or provide automatic fire-extinguishing system
Stationary lead-acid battery systems having a liquid capacity of more than 100 gallons used for facility emergency power or uninterrupted power supplies	2-hour fire barriers and floor/ceiling assemblies in all occupancy groups
Rooms utilizing the electrical installation standards for "information technology rooms" as per Section 645.1 of the <i>New York City Electrical Code</i>	As may be required by the <i>New York City Electrical Code</i>

For SI: 1 square foot = 0.0929 m<sup>2</sup>, 1 pound per square inch = 6.9 kPa,  
1 British thermal unit = 0.293 watts, 1 horsepower = 746 watts,  
1 gallon = 3.785 L.

a. Where an automatic fire-extinguishing system is provided, it need only be provided in the incidental use room or area.

TABLE 302.3.2  
REQUIRED SEPARATION OF OCCUPANCIES (HOURS)<sup>a</sup>

USE	A-1	A-2	A-3	A-4	A-5	B <sup>b</sup>	E	F-1	F-2	H-1	H-2	H-3	H-4	H-5	I-1	I-2	I-3	I-4	M <sup>b</sup>	R-1	R-2	R-3, R-4	S-1	S-2 <sup>c</sup>	U
A-1	—	2	2	2	2	2	2	3	2	NP	4	3	2	4	2	2	2	2	2	2	2	2	3	2	1
A-2 <sup>d</sup>	—	—	2	2	2	2	2	3	2	NP	4	3	2	4	2	2	2	2	2	2	2	2	3	2	1
A-3	—	—	—	2	2	2	2	3	2	NP	4	3	2	4	2	2	2	2	2	2	2	2	3	2	1
A-4	—	—	—	—	2	2	2	3	2	NP	4	3	2	4	2	2	2	2	2	2	2	2	3	2	1
A-5	—	—	—	—	—	2	2	3	2	NP	4	3	2	4	2	2	2	2	2	2	2	2	3	2	1
B <sup>b</sup>	—	—	—	—	—	—	2	3	2	NP	2	1	1	1	2	2	2	2	2	2	2	2	3	2	1
E	—	—	—	—	—	—	—	3	2	NP	4	3	2	3	2	2	2	2	2	2	2	2	3	2	1
F-1	—	—	—	—	—	—	—	—	3	NP	2	1	1	1	3	3	3	3	3	3	3	3	3	3	3
F-2	—	—	—	—	—	—	—	—	—	NP	2	1	1	1	2	2	2	2	2	2	2	2	3	2	1
H-1	—	—	—	—	—	—	—	—	—	NP	NP	NP	NP	NP	NP	NP	NP	NP	NP	NP	NP	NP	NP	NP	NP
H-2	—	—	—	—	—	—	—	—	—	—	—	1	2	2	4	4	4	4	2	4	4	4	2	2	1
H-3	—	—	—	—	—	—	—	—	—	—	—	—	1	1	4	3	3	3	1	3	3	3	1	1	1
H-4	—	—	—	—	—	—	—	—	—	—	—	—	—	1	4	4	4	4	1	4	4	4	1	1	1
H-5	—	—	—	—	—	—	—	—	—	—	—	—	—	—	4	4	4	3	1	4	4	4	1	1	3
I-1	—	—	—	—	—	—	—	—	—	—	—	—	—	—	—	2	2	2	2	2	2	2	4	3	2
I-2	—	—	—	—	—	—	—	—	—	—	—	—	—	—	—	—	2	2	2	2	2	2	3	2	1
I-3	—	—	—	—	—	—	—	—	—	—	—	—	—	—	—	—	—	2	2	2	2	2	3	2	1
I-4	—	—	—	—	—	—	—	—	—	—	—	—	—	—	—	—	—	—	2	2	2	2	3	2	1
M <sup>b</sup>	—	—	—	—	—	—	—	—	—	—	—	—	—	—	—	—	—	—	—	2	2	2	3	2	1
R-1	—	—	—	—	—	—	—	—	—	—	—	—	—	—	—	—	—	—	—	—	2	2	3	2	1
R-2	—	—	—	—	—	—	—	—	—	—	—	—	—	—	—	—	—	—	—	—	—	—	3	2	1
R-3, R-4	—	—	—	—	—	—	—	—	—	—	—	—	—	—	—	—	—	—	—	—	—	—	3	2 <sup>d</sup>	1 <sup>d</sup>
S-1	—	—	—	—	—	—	—	—	—	—	—	—	—	—	—	—	—	—	—	—	—	—	—	3	3
S-2 <sup>e</sup>	—	—	—	—	—	—	—	—	—	—	—	—	—	—	—	—	—	—	—	—	—	—	—	—	1
U	—	—	—	—	—	—	—	—	—	—	—	—	—	—	—	—	—	—	—	—	—	—	—	—	—

For SI: 1 square foot = 0.0929 m<sup>2</sup>.

NP = Not Permitted.

- a. See Section 302.3.2 for reductions permitted.
- b. Occupancy separation need not be provided for storage areas with Groups B and M if any of the following conditions apply:
  1. The storage area is less than 10 percent of the floor area of the story; and less than 3000 square feet (278.7 m<sup>2</sup>).
  2. The storage area is provided with an automatic fire-extinguishing system and is less than 3,000 square feet (278.7 m<sup>2</sup>); or
  3. The storage area is less than 1,000 square feet (92.9 m<sup>2</sup>).
- c. See exception to Section 302.3.2.
- d. See Section 406.1.4
- e. Commercial kitchens need not be separated from the restaurant seating areas that they serve, provided:
  1. The cooking equipment is vented directly to the outdoors; and
  2. A draft curtain of noncombustible materials, at least 24 inches (610 mm) down from the ceiling, is provided to separate the cooking facilities from the restaurant seating areas; and
  3. Sprinkler heads constructed in accordance with the provisions of this code are provided in the kitchen side of the curtain, within 24 inches (610 mm) of the curtain opening, and any other openings including doors between the kitchen and the seating areas, and spaced not more than 48 inches (1210 mm) on center for each opening that is more than 60 inches (1524 mm) wide.

**TABLE 307.7(1)**  
**MAXIMUM ALLOWABLE QUANTITY PER CONTROL AREA OF HAZARDOUS MATERIALS POSING A PHYSICAL HAZARD<sup>a, i, m, n, q</sup>**

MATERIAL	CLASS	GROUP WHEN THE MAXIMUM ALLOWABLE QUANTITY IS EXCEEDED	STORAGE <sup>b</sup>			USE-CLOSED SYSTEMS <sup>b</sup>			USE-OPEN SYSTEMS <sup>b</sup>										
			Solid pounds (cubic feet)	Liquid gallons (pounds)	Gas SCF	Solid pounds (cubic feet)	Liquid gallons (pounds)	Gas SCF	Solid pounds (cubic feet)	Liquid gallons (pounds)									
Combustible liquid <sup>c, l, r</sup>	II	H-2 or H-3	N/A	120 <sup>d, e</sup>	N/A	N/A	120 <sup>d</sup>	N/A	N/A	30 <sup>d</sup>									
	IIA	H-2 or H-3		330 <sup>d, e</sup>			330 <sup>d</sup>			80 <sup>d</sup>									
	IIIB	N/A		13,200 <sup>e, f</sup>			13,200 <sup>e, f</sup>			3,300 <sup>f</sup>									
Combustible fiber	Loose	H-3	(100)	N/A	N/A	(100)	N/A	N/A	(20)	N/A									
	Baled		(1,000)			(1,000)			(200)										
Cryogenics flammable	N/A	H-2	N/A	45 <sup>d</sup>	N/A	N/A	45 <sup>d</sup>	N/A	N/A	10 <sup>d</sup>									
Cryogenics oxidizing	N/A	H-3	N/A	45 <sup>d</sup>	N/A	N/A	45 <sup>d</sup>	N/A	N/A	10 <sup>d</sup>									
Explosives	Division 1.1	H-1	1 <sup>e, g</sup>	(1) <sup>e, g</sup>	N/A	0.25 <sup>g</sup>	(0.25) <sup>g</sup>	N/A	0.25 <sup>g</sup>	(0.25) <sup>g</sup>									
	Division 1.2	H-1	1 <sup>e, g</sup>	(1) <sup>e, g</sup>	N/A	0.25 <sup>g</sup>	(0.25) <sup>g</sup>	N/A	0.25 <sup>g</sup>	(0.25) <sup>g</sup>									
	Division 1.3	H-1 or 2	5 <sup>e, g</sup>	(5) <sup>e, g</sup>	N/A	1 <sup>g</sup>	(1) <sup>g</sup>	N/A	1 <sup>g</sup>	(1) <sup>g</sup>									
	Division 1.4	H-3	50 <sup>e, g</sup>	(50) <sup>e, g</sup>	N/A	50 <sup>g</sup>	(50) <sup>g</sup>	N/A	N/A	N/A									
	Division 1.4G	H-3	125 <sup>d, e</sup>	N/A	N/A	N/A	N/A	N/A	N/A	N/A									
	Division 1.5	H-1	1 <sup>e, g</sup>	(1) <sup>e, g</sup>	N/A	0.25 <sup>g</sup>	(0.25) <sup>g</sup>	N/A	0.25 <sup>g</sup>	(0.25) <sup>g</sup>									
	Division 1.6	H-1	1 <sup>d, e, g</sup>	N/A	N/A	N/A	N/A	N/A	N/A	N/A									
Flammable gas	Gaseous	H-2	N/A	N/A	1,000 <sup>d, e</sup>	N/A	N/A	1,000 <sup>d, e</sup>	N/A	N/A									
	liquefied			30 <sup>d, e</sup>	N/A		30 <sup>d, e</sup>	N/A											
Flammable liquid <sup>c, k</sup>	IA <sup>o</sup>	H-2	N/A	30 <sup>d, e</sup>	N/A	N/A	30 <sup>d</sup>	N/A	N/A	10 <sup>d</sup>									
	IB and IC	or H-3		120 <sup>d, e</sup>			120 <sup>d</sup>			30 <sup>d</sup>									
Combination flammable Liquid (IA <sup>o</sup> , IB, IC)	N/A	H-2 or H-3	N/A	120 <sup>d, e, h</sup>	N/A	N/A	120 <sup>d, h</sup>	N/A	N/A	30 <sup>d, h</sup>									
Flammable solid Pigs, ingots, billets, heavy castings Light castings, light metallic products Scraps, shavings, powders, dusts	N/A	H-3	1,000 <sup>d, e</sup>	N/A	N/A	1,000 <sup>d</sup>	N/A	N/A	1,000 <sup>d</sup>	N/A									
			125 <sup>d, e</sup>			125 <sup>d</sup>			125 <sup>d</sup>										
			1 <sup>d, e</sup>			1 <sup>d</sup>			1 <sup>d</sup>										
Organic peroxide <sup>p</sup>	Unclassified	H-1	1 <sup>e, f</sup>	(1) <sup>e, g</sup>	N/A	0.25 <sup>g</sup>	(0.25) <sup>g</sup>	N/A	0.25 <sup>g</sup>	(0.25) <sup>g</sup>									
	Detonable																		
	I																		
	II										H-2	5 <sup>d, e</sup>	(5) <sup>d, e</sup>	N/A	1 <sup>d</sup>	(1)	N/A	1 <sup>d</sup>	(1) <sup>d</sup>
	III										H-3	50 <sup>d, e</sup>	(50) <sup>d, e</sup>	N/A	50 <sup>d</sup>	(50) <sup>d</sup>	N/A	10 <sup>d</sup>	(10) <sup>d</sup>
	IV										H-3	125 <sup>d, e</sup>	(125) <sup>d, e</sup>	N/A	125 <sup>d</sup>	(125) <sup>d</sup>	N/A	25 <sup>d</sup>	(25) <sup>d</sup>
V	N/A	NL	NL	N/A	NL	NL	N/A	NL	NL										
	N/A	NL	NL	N/A	NL	NL	N/A	NL	NL										
Oxidizer	4	H-1	1 <sup>e, g</sup>	(1) <sup>e, g</sup>	N/A	0.25 <sup>g</sup>	(0.25) <sup>g</sup>	N/A	0.25 <sup>g</sup>	(0.25) <sup>g</sup>									
	3 <sup>t</sup>	H-2	10 <sup>d, e</sup>	(10) <sup>d, e</sup>	N/A	2 <sup>d</sup>	(2) <sup>d</sup>	N/A	2 <sup>d</sup>	(2) <sup>d</sup>									
	2	H-3	250 <sup>d, e</sup>	(250) <sup>d, e</sup>	N/A	250 <sup>d</sup>	(250) <sup>d</sup>	N/A	50 <sup>d</sup>	(50) <sup>d</sup>									
	1	H-3	4,000 <sup>e, f</sup>	(4,000) <sup>e, f</sup>	N/A	4,000 <sup>f</sup>	(4,000) <sup>f</sup>	N/A	1,000 <sup>f</sup>	(1,000) <sup>f</sup>									
Oxidizing gas	Gaseous	H-3	N/A	N/A	1,500 <sup>d, e</sup>	N/A	N/A	1,500 <sup>d, e</sup>	N/A	N/A									
	liquefied		N/A	15 <sup>d, e</sup>	N/A	N/A	15 <sup>d, e</sup>	N/A	N/A	N/A									

**TABLE 307.7(1)—continued**  
**MAXIMUM ALLOWABLE QUANTITY PER CONTROL AREA OF HAZARDOUS MATERIALS POSING A PHYSICAL HAZARD<sup>a, j, m, n, q</sup>**

MATERIAL	CLASS	GROUP WHEN THE MAXIMUM ALLOWABLE QUANTITY IS EXCEEDED	STORAGE <sup>b</sup>			USE-CLOSED SYSTEMS <sup>b</sup>			USE-OPEN SYSTEMS <sup>b</sup>	
			Solid pounds (cubic feet)	Liquid gallons (pounds)	Gas (cubic feet at NTP)	Solid pounds (cubic feet)	Liquid gallons (pounds)	Gas (cubic feet at NTP)	Solid pounds (cubic feet)	Liquid gallons (pounds)
Pyrophoric material <sup>p</sup> detonable	N/A	H-1	1 <sup>e, g</sup>	(1) <sup>e, g</sup>	10 <sup>e, g</sup>	0.25 <sup>g</sup>	(0.25) <sup>g</sup>	2 <sup>e, g</sup>	0	0
Pyrophoric material <sup>p</sup> nondetonable	N/A	H-2	4 <sup>e, g</sup>	(4) <sup>e, g</sup>	50 <sup>e, g</sup>	1 <sup>g</sup>	(1) <sup>g</sup>	10 <sup>e, g</sup>	0	0
Unstable (reactive) <sup>p</sup> detonable	4	H-1	1 <sup>e, g</sup>	(1) <sup>e, g</sup>	10 <sup>d, g</sup>	0.25 <sup>g</sup>	(0.25) <sup>g</sup>	2 <sup>e, g</sup>	0.25 <sup>g</sup>	(0.25) <sup>g</sup>
	3	H-1	1 <sup>e, g</sup>	(1) <sup>e, g</sup>	10 <sup>d, g</sup>	0.25 <sup>g</sup>	(0.25) <sup>g</sup>	2 <sup>e, g</sup>	0.25 <sup>g</sup>	(0.25) <sup>g</sup>
Unstable (reactive) <sup>p</sup> nondetonable	4	H-1	1 <sup>e, g</sup>	(1) <sup>e, g</sup>	10 <sup>d, g</sup>	0.25 <sup>g</sup>	(0.25) <sup>g</sup>	2 <sup>e, g</sup>	0.25 <sup>g</sup>	(0.25) <sup>g</sup>
	3	H-1 or H-2	5 <sup>d, e</sup>	(5) <sup>d, e</sup>	50 <sup>d, e</sup>	1 <sup>d</sup>	(1)	10 <sup>d, e</sup>	1 <sup>d</sup>	(1) <sup>d</sup>
	2	H-3	50 <sup>d, e</sup>	(50) <sup>d, e</sup>	250 <sup>d, e</sup>	50 <sup>d</sup>	(50) <sup>d</sup>	250 <sup>d, e</sup>	10 <sup>d</sup>	(10) <sup>d</sup>
	1	N/A	NL	NL	750 <sup>d, e</sup>	NL	NL	NL	NL	NL
Water-reactive <sup>p</sup> detonable	3	H-1	1 <sup>e, g</sup>	(1) <sup>e, g</sup>	N/A	0.25 <sup>g</sup>	(0.25) <sup>g</sup>	N/A	0.25 <sup>g</sup>	(0.25) <sup>g</sup>
	2	H-1	1 <sup>e, g</sup>	(1) <sup>e, g</sup>	N/A	0.25 <sup>g</sup>	(0.25) <sup>g</sup>	N/A	0.25 <sup>g</sup>	(0.25) <sup>g</sup>
Water-reactive <sup>p</sup> nondetonable	3	H-2	5 <sup>d, e</sup>	(5) <sup>d, e</sup>	N/A	5 <sup>d</sup>	(5) <sup>d</sup>	N/A	1 <sup>d</sup>	(1) <sup>d</sup>
	2	H-3	50 <sup>d, e</sup>	(50) <sup>d, e</sup>	N/A	50 <sup>d</sup>	(50) <sup>d</sup>	N/A	10 <sup>d</sup>	(10) <sup>d</sup>
	1	N/A	NL	NL	N/A	NL	NL	N/A	NL	NL

For SI: 1 cubic foot = 0.023 m<sup>3</sup>, 1 pound = 0.454 kg, 1 gallon = 3.785 L.  
 NL = Not Limited; N/A = Not Applicable; UD = Unclassified Detonable

a. For use of control areas, see Section 414.2.

b. The aggregate quantity in storage, handling, and use shall not exceed the quantity listed for storage.

c. The quantities of alcoholic beverages in retail and wholesale sales occupancies shall not be limited providing the liquids are packaged in individual containers not exceeding 1.3 gallons. In retail and wholesale sales occupancies, the quantities of medicines, foodstuffs, consumer or industrial products, and cosmetics containing not more than 50 percent by volume of water-miscible liquids with the remainder of the solutions not being flammable, shall not be limited, provided that such materials are packaged in individual containers not exceeding 1.3 gallons.

d. Maximum allowable quantities, except for liquefied petroleum gas, and flammable liquid motor fuel, may be increased 100 percent in buildings equipped throughout with an automatic sprinkler system in accordance with Section 903.3.1.1. Where Note e applies, the quantities increased shall be as set forth in both notes.

e. Quantities, except for liquefied petroleum gas, and flammable liquid motor fuel, may be increased 100 percent when stored in approved cabinets, gas cabinets, exhausted enclosures or safety cans as specified in the *New York City Fire Code*. Where Note d applies, the quantities increased shall be as set forth in both notes.

f. The permitted quantities shall not be limited in a building equipped throughout with an automatic sprinkler system in accordance with Section 903.3.1.1.

g. Permitted only in buildings equipped throughout with an automatic sprinkler system in accordance with Section 903.3.1.1.

h. Containing not more than the maximum allowable quantity per control area of Class IA, IB or IC flammable liquids.

i. Stationary fuel oil storage tanks shall comply with the *New York City Fire Code*.

j. Quantities in parenthesis indicate quantity units in parenthesis at the head of each column.

k. A maximum quantity of 200 pounds of solid or 20 gallons of liquid Class 3 oxidizers is allowed when such materials are necessary for maintenance purposes, operation or sanitation of equipment. Storage containers and the manner of storage shall be approved.

m. For gallons of liquids, divide the amount in pounds by 10 in accordance with the *New York City Fire Code*.

n. For storage and display quantities in Group M and storage quantities in Group S occupancies complying with the *New York City Fire Code*.

o. For purposes of this table, gasoline and other flammable liquid motor fuels are classified as a Class IA flammable liquid.

p. Unclassified detonable organic peroxides, detonable pyrophoric materials, detonable unstable (reactive) materials, and detonable water-reactive materials (see the *New York City Fire Code*) are considered as explosives for purposes of storage.

q. The maximum allowable quantities shall be limited by Section 419 for chemical laboratories classified as Occupancy Group B and operating as non-production facilities for testing, research, experimental, instructional, or education purposes.

**TABLE 307.7(2)**  
**MAXIMUM ALLOWABLE QUANTITY PER CONTROL AREA OF HAZARDOUS MATERIAL POSING A HEALTH HAZARD<sup>a, b, c, j, k</sup>**

MATERIAL	STORAGE <sup>d</sup>			USE-CLOSED SYSTEMS <sup>d</sup>			USE-OPEN SYSTEMS <sup>d</sup>	
	Solid pounds <sup>e, f</sup>	Liquid gallons (pounds) <sup>e, f</sup>	Gas SCF <sup>e</sup>	Solid pounds <sup>e</sup>	Liquid gallons (pounds) <sup>e</sup>	Gas SCF <sup>e</sup>	Solid pounds <sup>e</sup>	Liquid gallons (pounds) <sup>e</sup>
Corrosive	5,000	500	810 <sup>f, g</sup>	5,000	500	810 <sup>f, g</sup>	1,000	100
Highly toxic	10	(10) <sup>i</sup>	20 <sup>h</sup>	10	(10) <sup>i</sup>	20 <sup>h</sup>	3	(3) <sup>i</sup>
Toxic	500	(500) <sup>i</sup>	810 <sup>f</sup>	500	(500) <sup>i</sup>	810 <sup>f</sup>	125	(125) <sup>i</sup>

For SI: 1 cubic foot = 0.028 m<sup>3</sup>, 1 pound = 0.454 kg, 1 gallon = 3.785 L.

a. For use of control areas, see Section 414.2.

b. In retail and wholesale sales occupancies, the quantities of medicines, foodstuffs, consumer or industrial products, and cosmetics, containing not more than 50 percent by volume of water-miscible liquids and with the remainder of the solutions not being flammable, shall not be limited, provided that such materials are packaged in individual containers not exceeding 1.3 gallons.

c. For storage and display quantities in Group M and storage quantities in Group S occupancies complying with the *New York City Fire Code*.

d. The aggregate quantity in storage, handling, and use shall not exceed the quantity listed for storage.

e. Quantities shall be increased 100 percent in buildings equipped throughout with an approved automatic sprinkler system in accordance with Section 903.3.1.1. Where Note f also applies, the increase for both notes shall be applied accumulatively.

f. Quantities may be increased 100 percent when stored in approved storage cabinets, gas cabinets or exhausted enclosures as specified in the *New York City Fire Code*. Where Note e applies, the quantities increased shall be as set forth in both notes.

g. A single container of anhydrous ammonia containing not more than 150 pounds in a single control area in a nonsprinklered building shall be considered a maximum allowable quantity. Two containers of anhydrous ammonia, each containing not more than 150 pounds, shall be considered a maximum allowable quantity provided the building is equipped throughout with an automatic sprinkler system in accordance with Section 903.3.1.1.

h. Allowed only when stored in approved exhausted gas cabinets or exhausted enclosures as specified in the *New York City Fire Code*.

i. Quantities in parenthesis indicate quantity units in parenthesis at the head of each column.

j. For gallons of liquids, divide the amount in pounds by 10 in accordance with the *New York City Fire Code*.

k. The maximum allowable quantities shall be limited by Section 419 for chemical laboratories classified as Occupancy Group B and operating as a non-production facilities for testing, research, experimental, instructional, or education purposes.

**CHAPTER 4**  
**SPECIAL DETAILED REQUIREMENTS BASED ON USE AND OCCUPANCY**

**SECTION BC 401**  
**SCOPE**

**401.1 Detailed use and occupancy requirements.** In addition to the occupancy and construction requirements in this code, the provisions of this chapter apply to the special uses and occupancies described herein.

**SECTION BC 402**  
**COVERED MALL BUILDINGS**

**402.1 Scope.** The provisions of this section shall apply to buildings or structures defined herein as covered mall buildings not exceeding three floor levels at any point nor more than three stories above grade. Except as specifically required by this section, covered mall buildings shall meet applicable provisions of this code.

**Exceptions:**

1. Foyers and lobbies of Groups B, R-1 and R-2 are not required to comply with this section.
2. Buildings need not comply with the provisions of this section where they fully comply with other applicable provisions of this code.

**402.1.1 Occupancy classification.** A mall in compliance with the provisions of this section shall be classified as occupancy group M.

**402.2 Definitions.** The following words and terms shall, for the purposes of this chapter and as used elsewhere in this code, have the meanings shown herein.

**ANCHOR BUILDING.** An exterior perimeter building of a group other than H having direct access to a covered mall building but having required means of egress independent of the mall.

**COVERED MALL BUILDING.** A single building enclosing a number of tenants and occupants such as retail stores, drinking and dining establishments, entertainment and amusement facilities, passenger transportation terminals, offices, and other similar uses wherein two or more tenants have a main entrance into one or more malls. For the purpose of this chapter, anchor buildings shall not be considered as a part of the covered mall building.

**FOOD COURT.** A public seating area located in the mall that serves adjacent food preparation tenant spaces.

**GROSS LEASABLE AREA.** The total floor area designed for tenant occupancy and exclusive use. The area of tenant occupancy is measured from the centerlines of joint partitions to the



outside of the tenant walls. All tenant areas, including areas used for storage, shall be included in calculating gross leasable area.

**MALL.** A roofed or covered common pedestrian area within a covered mall building that serves as access for two or more tenants and not to exceed three levels that are open to each other.

**402.3 Lease plan.** Each covered mall building owner shall provide the department and the Fire Department with a lease plan showing the location of each occupancy and its exits after the certificate of occupancy has been issued. No modifications or changes in occupancy or use shall be made from that shown on the lease plan without prior approval of the commissioner.

**402.4 Means of egress.** The covered mall building shall be provided with means of egress as required by this code. Where there is a conflict between the requirements of this code and the requirements of this section, the requirements of this section shall apply.

**402.4.1 Occupant load.** The calculated occupant load used to determine the required number of means of egress shall be in accordance with this section.

**402.4.1.1 Occupant load of tenant spaces.** The occupant load permitted in any individual tenant space in a covered mall building shall be determined in accordance with Chapter 10. Means of egress requirements for individual tenant spaces shall be based on the occupant load thus determined.

**402.4.1.2 Occupant load of mall.** In determining required means of egress of the mall, the total occupant load in the mall shall include the occupant load attributed to the mall as determined by Equation 4-1, plus the occupant load of the food court if any, plus the occupant load discharged into the mall from individual tenant spaces.

**402.4.1.2.1 Occupant load formula.** To determine the occupant load attributed to the mall, the number of square feet of floor area of the mall, excluding any food court, shall be divided by the occupant load factor (*OLF*) value determined by Equation 4-1.

**(Equation 4-1 attached to end of document)**

**402.4.1.2.2 OLF range.** The occupant load factor (*OLF*) is not required to be less than 30 and shall not exceed 50.

**402.4.1.2.3 Food courts.** The occupant load of a food court shall be determined in accordance with Section 1004 and shall be added to the occupant load of the mall.

**402.4.1.3 Anchor buildings.** The occupant load of anchor buildings opening into the mall shall not be included in computing the total number of occupants for the covered mall building.

**402.4.2 Number of means of egress.** The required number of means of egress shall be determined in accordance with this section.

**402.4.2.1 Number of means of egress within tenant spaces.** Wherever the distance of travel to the mall from any location within a tenant space used by persons other than employees exceeds 75 feet (22 860 mm) or the tenant space exceeds an occupant load of 50, no fewer than two means of egress shall be provided.

**402.4.2.2 Number of means of egress from the mall.** The number of means of egress from the mall shall be determined in accordance with Chapter 10 and shall be based upon an occupant load calculated in accordance with Section 402.4.1.2.

**402.4.3 Arrangements of means of egress.** Means of egress shall be arranged in accordance with this section.

**402.4.3.1 Anchor building means of egress.** Required means of egress for anchor buildings shall be provided independently from the mall means of egress system. The occupant load of anchor buildings opening into the mall shall not be included in determining means of egress requirements for the mall. The path of egress travel of malls shall not exit through anchor buildings. Malls terminating at an anchor building where no other means of egress has been provided shall be considered as a dead-end mall.

**402.4.3.2 Tenant spaces requiring more than one means of egress.** Where more than one means of egress is required from an individual tenant space as determined by Chapter 10, not more than 50 percent of the occupant load shall discharge into the mall.

**402.4.3.3 Large assembly occupancy.** Assembly occupancies with an occupant load of 500 or more shall be so located in the covered mall building such that their entrance will be immediately adjacent to a principal entrance to the mall and shall have not less than one-half of their required means of egress opening directly to the exterior of the covered mall building.

**402.4.4 Distance to exits.** The maximum permitted travel distance to exits in covered mall buildings shall be in accordance with this section.

**402.4.4.1 Distance to exits within tenant spaces.** The maximum travel distance from any point within an individual tenant space to its entrance to the mall or to an exit shall not exceed 200 feet (60 960 mm).

**402.4.4.2 Distance to exits within the mall.** The maximum distance of travel from any point within a mall to an exit shall not exceed 200 feet (60 960 mm).

**402.4.5 Access to exits.** Where more than one exit is required, they shall be so arranged that it is possible to travel in either direction from any point in a mall to separate exits. However, in dead ends not exceeding a length equal to twice the width of the mall measured at the narrowest location within the dead end portion of the mall, one direction of travel shall be permitted. The minimum width of an exit passageway or corridor from a mall shall be 66 inches (1676 mm).

**402.4.5.1 Exit passageway enclosures.** Where exit passageway enclosures provide a secondary means of egress from a tenant space, doors to the exit passageway enclosures shall be minimum 1-hour fire doors with panic hardware. Such doors shall be self-closing and be so maintained or shall be automatic closing by smoke detection.

**402.4.6 Service areas fronting on exit passageways.** Mechanical rooms, electrical rooms, building service areas and service elevators are permitted to open directly into exit passageways provided that the exit passageway is separated from such rooms by fire barriers providing the same fire-resistance rating as required for the exit passageway. Door swings from these rooms shall not project into the minimum width of such exit passageways.

**402.5 Mall width.** For the purpose of providing required egress, malls are permitted to be considered as corridors but need not comply with the requirements of Section 1005.1 of this code where the width of the mall is as specified in this section.

**402.5.1 Minimum width.** The minimum width of the mall shall be 20 feet (6096 mm). The mall width shall be sufficient to accommodate the occupant load served. There shall be a minimum of 10 feet (3048 mm) clear width to a height of 8 feet (2438 mm) between any projection of a tenant space bordering the mall and the nearest kiosk, vending machine, bench, display opening, food court or other obstruction to means of egress travel.

**402.6 Types of construction.** Covered mall buildings, including anchor buildings, shall be only of Type I, II, and IV construction. Their areas shall not be limited provided that the covered mall building and attached anchor buildings and parking garages are surrounded on all sides by a permanent open space of not less than 60 feet (18 288 mm) and the anchor buildings do not exceed three stories in height. The height of covered mall buildings, including anchor buildings, of Type IIB construction shall be limited to one story. The allowable height and area of anchor buildings greater than three stores in height shall comply with Section 503, as modified by Sections 504 and 506. The construction type of open parking garages and enclosed parking garages shall comply with Sections 406.3 and 406.4, respectively.

**402.7 Fire-resistance-rated separation.** Fire-resistance-rated separation is not required between tenant spaces and the mall. Fire-resistance-rated separation is not required between a food court and adjacent tenant spaces or the mall.

**402.7.1 Attached garage.** An attached parking garage for the storage of passenger vehicles having a capacity of not more than nine persons and open parking garages shall be considered as a separate building where it is separated from the covered mall building by a fire barrier having a fire-resistance rating of at least 2 hours. Openings in such barrier shall be 1½ hour fire-rated self-closing or shall be automatic closing upon the activation of a smoke detector or fire alarm.

**Exception:** Where an open parking garage or enclosed parking garage is separated from the covered mall building or anchor building by a distance greater than 10 feet (3048 mm), the provisions of Table 602 shall apply. Pedestrian walkways and tunnels that

attach the open parking garage or enclosed parking garage to the covered mall building or anchor building shall be constructed in accordance with Section 3104.

**402.7.2 Tenant separations.** Each tenant space shall be separated from other tenant spaces by a fire partition complying with Section 708. A tenant separation wall is not required between any tenant space and the mall.

**402.7.3 Anchor building separation.** An anchor building shall be separated from the covered mall building by fire walls complying with Section 705.

**Exception:** Anchor buildings of not more than three stories above grade that have an occupancy classification of the same uses permitted as tenants of the covered mall building shall be separated by 2-hour fire resistive fire barriers complying with Section 706. Openings between such buildings and the mall need not be protected.

**402.8 Automatic sprinkler system.** The covered mall building and buildings connected shall be provided throughout with an automatic sprinkler system in accordance with Section 903.3.1.1, that shall comply with the following:

1. The automatic sprinkler system shall be complete and operative throughout occupied space in the covered mall building prior to occupancy of any of the tenant spaces. Unoccupied tenant spaces shall be similarly protected unless provided with approved alternate protection.
2. Sprinkler protection for the mall shall be independent from that provided for tenant spaces or anchors. Where tenant spaces are supplied by the same system, they shall be independently controlled.

**Exception:** An automatic sprinkler system shall not be required in spaces or areas of open parking garages constructed in accordance with Section 406.2.

**402.8.1 Standpipe system.** The covered mall building shall be equipped throughout with a standpipe system as required by Section 905.3.3.

**402.9 Smoke control.** A smoke control system shall be provided in accordance with Section 909 for malls greater than one story in height.

**402.10 Kiosks.** Kiosks and similar structures (temporary or permanent) shall meet the following requirements:

1. Combustible kiosks or other structures shall not be located within the mall unless constructed of any of the following materials:
  - 1.1. Fire-retardant-treated wood complying with Section 2303.2.

1.2. Foam plastics having a maximum heat release rate not greater than 100 kW (105 Btu/h) when tested in accordance with the exhibit booth protocol in UL 1975.

1.3. Aluminum composite material (ACM) having a flame spread index of not more than 25 and a smoke-developed index of not more than 450 when tested as an assembly in the maximum thickness intended for use in accordance with ASTM E 84.

2. Kiosks or similar structures located within the mall shall be provided with approved fire suppression and detection devices.

3. The minimum horizontal separation between kiosks or groupings thereof and other structures within the mall shall be 20 feet (6096 mm).

4. Each kiosk or similar structure or groupings thereof shall have a maximum area of 300 square feet (28 m<sup>2</sup>).

**402.11 Security grilles and doors.** Horizontal sliding or vertical security grilles or doors that are a part of a required means of egress shall conform to the following:

1. They shall remain in the full open position during the period of occupancy by the general public.

2. Doors or grilles shall not be brought to the closed position when there are more than 10 persons occupying spaces served by a single exit or 50 persons occupying spaces served by more than one exit.

3. The doors or grilles shall be openable from within without the use of any special knowledge or effort where the space is occupied.

4. Where two or more exits are required, not more than one-half of the exits shall be permitted to include either a horizontal sliding or vertical rolling grille or doors.

**402.12 Emergency power.** Covered mall buildings exceeding 50,000 square feet (4645 m<sup>2</sup>) shall be provided with emergency power systems that are capable of operating the emergency voice/alarm communication system.

**402.13 Emergency voice/alarm communication system.** Covered mall buildings exceeding 50,000 square feet (4645 m<sup>2</sup>) in total floor area shall be provided with an emergency voice/alarm communication system. Emergency voice/alarm communication systems serving a mall, required or otherwise, shall be accessible to the Fire Department. The system shall be provided in accordance with Section 907.2.12.2.

**402.14 Plastic signs.** Within every store or level and from sidewall to sidewall of each tenant space facing the mall, plastic signs shall be limited as specified in Sections 402.14.1 through 402.14.5.

**402.14.1 Area.** Plastic signs shall not exceed 20 percent of the wall area facing the mall.

**402.14.2 Height and width.** Plastic signs shall not exceed a height of 36 inches (914 mm), except if the sign is vertical, the height shall not exceed 96 inches (2438 mm) and the width shall not exceed 36 inches (914 mm).

**402.14.3 Location.** Plastic signs shall be located a minimum distance of 18 inches (457 mm) from adjacent tenants.

**402.14.4 Plastics other than foam plastics.** Plastics other than foam plastics used in signs shall be light-transmitting plastics complying with Section 2606.4 or shall have a self-ignition temperature of 650°F (343°C) or greater when tested in accordance with ASTM D 1929, and a flame spread index not greater than 75 and smoke-developed index not greater than 450 when tested in the manner intended for use in accordance with ASTM E 84 or meet the acceptance criteria of Section 803.2.1 when tested in accordance with NFPA 286.

**402.14.4.1 Encasement.** Edges and backs of plastic signs in the mall shall be fully encased in metal.

**402.14.5 Foam plastics.** Foam plastics used in signs shall have flame-retardant characteristics such that the sign has a maximum heat-release rate of 150 kilowatts when tested in accordance with UL 1975 and the foam plastics shall have the physical characteristics specified in this section. Foam plastics used in signs installed in accordance with Section 402.14 shall not be required to comply with the flame spread and smoke-developed indexes specified in Section 2603.3.

**402.14.5.1 Density.** The minimum density of foam plastics used in signs shall not be less than 20 pounds per cubic foot (pcf) (320 kg/m<sup>3</sup>).

**402.14.5.2 Thickness.** The thickness of foam plastic signs shall not be greater than ½-inch (12.7 mm).

**402.15 Fire Department access to equipment.** Rooms or areas containing controls for air-conditioning systems, automatic fire-extinguishing systems or other detection, suppression or control elements shall be identified for use by the Fire Department.

## **SECTION BC 403** **HIGH-RISE BUILDINGS**

**403.1 Applicability.** The provisions of this section shall apply to buildings having occupied floors located more than 75 feet (22 860 mm) above the lowest level of fire department vehicle access.

**Exception:** The provisions of this section shall not apply to the following buildings and structures:

1. Buildings in Group R-3 classification.
2. Open parking garages in accordance with Section 406.3.
3. Buildings with an occupancy in Group A-5 in accordance with Section 303.1.
4. Low-hazard special industrial occupancies in accordance with Section 503.1.2.
5. Buildings with an occupancy in Group H-1, H-2 or H-3 in accordance with Section 415.

**403.2 Automatic sprinkler system.** Buildings and structures shall be equipped throughout with an automatic sprinkler system in accordance with Section 903.3.1.1. A secondary water supply shall be provided where required by Section 903.3.5.2 and in any building having occupied floors more than 300 feet (91 440 mm) above the lowest level of fire department vehicle access.

**403.3 Reserved.**

**403.4 Emergency escape and rescue.** Emergency escape and rescue openings required by Section 1025 are not required.

**403.5 Automatic fire detection.** Smoke detection shall be provided in accordance with Section 907.2.12.1.

**403.6 Emergency voice/alarm communication systems.** An emergency voice/alarm communication system shall be provided in accordance with Section 907.2.12.2.

**403.7 Fire Department communications system.** A two-way fire department communications system shall be provided for Fire Department use in accordance with Section 907.2.12.3.

**403.8 Fire command.** A fire command center complying with Section 911 shall be provided in a location approved by the Fire Department.

**403.9 Elevators.** Elevator operation and installation shall be in accordance with Chapter 30.

**403.9.1 Elevator lobbies.** Elevator lobbies shall be provided in accordance with Sections 403.9.1.1 and 403.9.1.2.

**403.9.1.1 Applicability.** Elevator lobbies shall be provided at the following locations:

1. Elevators opening onto a fire-resistance-rated corridor. In all occupancy groups, elevator lobbies shall be provided at any location where an elevator opens onto a fire-resistance rated corridor.
2. Elevators serving B occupancies. Notwithstanding item 1, Elevators that serve four or more stories that contain space classified in occupancy Group B, inclusive

of any lobby or entrance level, shall provide elevator lobbies at every level served by such elevator.

**Exceptions:** Elevator lobbies are not required under the following conditions:

1. Street-floor lobbies. Street-floor lobbies provided that the entire street floor is equipped with an automatic sprinkler system in accordance with Section 903.3.1.1.
2. Elevators without shafts. Elevators that are not required to be located in a shaft in accordance with Section 707.2.
3. Zero-clearance doors. Elevator openings provided with zero-clearance doors in addition to hoistway doors and elevator car doors. Such zero-clearance doors shall be tested in accordance with UL 1784 without an artificial bottom seal. When serving as an accessible route, such additional doors shall operate automatically and in compliance with Chapter 11.
4. Small floor areas. On floors with less than 2,500 square feet (232 m<sup>2</sup>), the commissioner may accept an alternative design or construction method that accomplishes the purposes of this section, or if the commissioner determines that compliance with this section is impracticable in whole or in part, the commissioner may authorize an exemption from the requirements of this section.
5. Pressurized elevator shafts. When the elevator is pressurized in accordance with the requirements of the commissioner.
6. Group R-2 occupancy.

**403.9.1.2 Construction.** Elevator lobbies shall be constructed in accordance with the following:

1. The lobbies shall be constructed as a smoke partition complying with Section 710.
2. The lobbies shall separate the elevator from all other spaces on the story.
3. The lobbies shall have at least one means of egress complying with Chapter 10 and other provisions of this code.
4. Access to an exit on any story through an elevator lobby shall be permitted provided that access to at least one other required exit does not require passing through the elevator lobby.



**403.9.2 Impact resistant elevator shafts.** Elevator shafts shall be constructed of impact resistant walls. Minimum impact resistance standards shall be established by rules of the department.

**403.10 Reserved.**

**403.11 Emergency power systems.** An emergency power system complying with Section 2702 shall be provided for emergency power loads specified in Sections 403.11.1 and 403.11.2.

**403.11.1 Emergency power loads in occupancies other than R-2.** In buildings of any occupancy group other than Group R-2, the following are classified as emergency power loads:

1. Exit signs and means of egress illumination required by Chapter 10; and
2. Elevator car lighting; and
3. Emergency voice/alarm communications systems; and
4. Automatic fire detection systems; and
5. Fire alarm systems; and
6. Power and lighting for the fire command center required by Section 403.8; and
7. Electrically powered fire pumps; and
8. Ventilation and automatic fire detection equipment for smokeproof enclosures; and
9. Elevators in accordance with Section 3003; and
10. Stair pressurization systems when provided.

**403.11.2 Emergency power loads in Group R-2 occupancies.** Buildings greater than 125 feet (38 100 mm) in height in R-2 occupancies shall be required to provide an emergency power system to support the following loads:

1. Exit signs and means of egress illumination required by Chapter 10;
2. At least one elevator serving all floors, or one elevator per bank where different banks serve different portions of the building;
3. Emergency voice communications systems; and
4. Electrically powered fire pumps, unless electrical power to the motor is taken ahead of the main from the street side of the house service switch.

For buildings in Group R-2 occupancies where a generator is used as the emergency power source, diesel or gas shall be permitted as the fuel source in accordance with Section 2702.1.

**403.12 Stairway door operation.** Doors opening into interior stair enclosures shall not be locked from either side. However, a door locked from the stair side may be permitted provided that such door is equipped with an automatic fail safe system for opening in the event of the activation of any automatic fire detection system, or when any elevator recall is activated, or when any signal is received from the fire command center. Such door shall be deemed as openable from the stair side. Stair reentry signs shall be posted throughout the stairway indicating that reentry is provided only during fire emergencies. Such signs shall be in accordance with Section 1026.4.2.

**403.12.1 Stairway communications system.** A telephone or other two-way communications system connected to an approved constantly attended station shall be provided at not less than every fifth floor in each required stairway where stair side doors are locked.

**403.13 Smokeproof exit enclosures.** Every required stairway serving occupied floors more than 75 feet (22 860 mm) above the lowest level of fire department vehicle access shall comply with Sections 909.20 and 1019.1.8.

**Exception for R-2 occupancies:** Smokeproof enclosures are not required in occupancy Group R-2 unless provided pursuant to Exception 2 of Section 912.1.

**403.14 Seismic considerations.** For seismic considerations, see Chapter 16.

**403.15 Impact resistant stair enclosures.** Exit stair enclosures shall be constructed of impact resistant walls. Minimum impact resistance standards shall be established by rules of the department.

**403.16 Exit path markings.** All high-rise buildings shall be provided with photoluminescent exit path markings conforming to Section 1026.

**Exception:** Buildings in Groups R-2.

**403.17 Outdoor air intakes.** For high-rise buildings, outdoor air intakes serving spaces above the second story and serving spaces greater than 10,000 square-feet (929 m<sup>2</sup>) of floor area shall be located in accordance with Section 401.5 of the *New York City Mechanical Code*.

**Exception:** Buildings in Groups R-2.

**403.18 Open web steel joists.** The use of open web steel joists shall be prohibited in high-rise buildings until the commissioner promulgates rules establishing minimum acceptable fireproofing methods.

## **SECTION BC 404**

## ATRIUMS

**404.1 General.** In other than Group H occupancies, and where permitted by Exception 5 in Section 707.2, the provisions of this section shall apply to buildings or structures containing vertical openings defined herein as atriums.

**404.1.1 Definition.** The following word and term shall, for the purposes of this chapter and as used elsewhere in this code, have the meaning shown herein.

**ATRIUM.** An opening connecting three or more stories other than enclosed stairways, elevators, hoistways, escalators, plumbing, electrical, air-conditioning or any other vertical openings that are not required to be enclosed by other provisions of this code, which is closed at the top and not defined as a mall. Stories, as used in this definition, do not include balconies within assembly groups or mezzanines that comply with Section 505.

**404.2 Use.** The floor of the atrium shall not be used for other than low fire hazard uses, and only approved materials and decorations in accordance with the *New York City Fire Code* shall be used in the atrium space.

**Exception:** The atrium floor area is permitted to be used for any approved use where the individual space is provided with an automatic sprinkler system in accordance with Section 903.3.1.1.

**404.3 Automatic sprinkler protection.** An approved automatic sprinkler system shall be installed throughout the entire building.

### **Exceptions:**

1. That area of a building adjacent to or above the atrium need not be sprinklered provided that portion of the building is separated from the atrium portion by a 2-hour fire barrier wall or horizontal assembly or both.
2. Where the ceiling of the atrium is more than 55 feet (16 764 mm) above the floor, sprinkler protection at the ceiling of the atrium is not required.

**404.4 Smoke control.** A smoke control system shall be installed in accordance with Section 909.

**Exception:** Smoke control is not required for floor openings meeting the requirements of Section 707.2, Exceptions 2 and 8.

**404.5 Enclosure of atriums.** Atrium spaces shall be separated from adjacent spaces by a 2-hour fire barrier wall.

### **Exceptions:**

1. A glass or glass-block wall forming a smoke partition where automatic sprinklers are

spaced 6 feet (1829 mm) or less along both sides of the separation wall, or on the room side only if there is not a walkway on the atrium side, and between 4 inches and 12 inches (102 mm and 305 mm) away from the glass and so designed that the entire surface of the glass is wet upon activation of the sprinkler system. The glass shall be installed in a gasketed frame so that the framing system deflects without breaking (loading) the glass before the sprinkler system operates.

2. The adjacent spaces of any three floors of the atrium shall not be required to be separated from the atrium where such spaces are included in computing the atrium volume for the design of the smoke control system.

**404.6 Emergency power.** Equipment required to provide smoke control shall be connected to an emergency power system in accordance with Section 909.11.

**404.7 Interior finish.** The interior finish of walls and ceilings of the atrium shall not be less than Class B with no reduction in class for sprinkler protection.

**404.8 Travel distance.** In other than the lowest level of the atrium, where the required means of egress is through the atrium space, the portion of exit access travel distance within the atrium space shall not exceed 200 feet (60 960 mm).

**404.9 Types of construction.** Buildings containing atriums shall be only of Type I, IIA, and IV construction.

## **SECTION BC 405** **UNDERGROUND BUILDINGS**

**405.1 General.** The provisions of this section apply to building spaces having a floor level used for human occupancy more than 30 feet (9144 mm) below the lowest level of exit discharge.

### **Exceptions:**

1. One- and two-family dwellings, sprinklered in accordance with Section 903.3.1.3.
2. Parking garages with automatic fire suppression systems in compliance with Section 405.3.
3. Fixed guideway transit systems.
4. Grandstands, bleachers, stadiums, arenas and similar facilities.
5. Where the lowest story is the only story that would qualify the building as an underground building and has an area not exceeding 1,500 square feet (139 m<sup>2</sup>) and has an occupant load less than 10.

**405.2 Construction requirements.** The underground portion of the building shall be of Type I construction.

**405.3 Automatic sprinkler system.** The highest level of exit discharge serving the underground portions of the building and all levels below shall be equipped with an automatic sprinkler system installed in accordance with Section 903.3.1.1. Water-flow switches and control valves shall be supervised in accordance with Section 903.4.

**405.4 Compartmentation.** Compartmentation shall be in accordance with Sections 405.4.1 through 405.4.3.

**405.4.1 Number of compartments.** A building having a floor level more than 60 feet (18 288 mm) below the lowest level of exit discharge shall be divided into a minimum of two compartments of approximately equal size. Such compartmentation shall extend through the highest level of exit discharge serving the underground portions of the building and all levels below.

**Exception:** The lowest story need not be compartmented where the area does not exceed 1,500 square feet (139 m<sup>2</sup>) and has an occupant load of less than 10.

**405.4.2 Smoke barrier penetration.** The separation between the two compartments shall be of minimum 2-hour fire barrier wall construction that shall extend from floor slab to floor deck above. Openings between the two compartments shall be limited to plumbing and electrical piping and conduit penetrations firestopped in accordance with Section 712. Doorways shall be protected by door assemblies that are automatic-closing by smoke detection in accordance with Section 715.3 and shall be provided with gasketing and a drop sill to minimize smoke leakage. Where provided, each compartment shall have an air supply and an exhaust system independent of the other compartments.

**405.4.3 Elevators.** Where elevators are provided, each compartment shall have direct access to an elevator. Where an elevator serves more than one compartment, an elevator lobby shall be provided and shall be separated from each compartment by a 2-hour fire barrier wall. Doors shall be gasketed, have a drop sill, and be automatic-closing by smoke detection installed in accordance with Section 907.10.

**405.5 Smoke control system.** A smoke control system shall be provided in accordance with Sections 405.5.1 and 405.5.2.

**405.5.1 Control system.** A smoke control system is required to control the migration of products of combustion in accordance with Section 909 and the provisions of this section. Smoke control shall restrict movement of smoke to the general area of fire origin and maintain means of egress in a usable condition.

**405.5.2 Smoke exhaust system.** Where compartmentation is required, each compartment shall have an independent smoke control system. The system shall be automatically activated and capable of manual operation in accordance with Section 907.2.18.

**405.6 Fire alarm systems.** A fire alarm system shall be provided where required by Section 907.2.19.

**405.7 Public address.** A public address system shall be provided where required by Section 907.2.19.1.

**405.8 Means of egress.** Means of egress shall be in accordance with Sections 405.8.1 and 405.8.2.

**405.8.1 Number of exits.** Each floor level shall be provided with a minimum of two exits. Where compartmentation is required by Section 405.4, each compartment shall have a minimum of one exit and shall also have an exit access doorway into the adjoining compartment.

**405.8.2 Smokeproof enclosure.** Every required stairway serving floor levels more than 30 feet (9144 mm) below its level of exit discharge shall comply with the requirements for a smokeproof enclosure as provided in Section 1019.1.8.

**405.9 Reserved.**

**405.10 Emergency power.** An emergency power system complying with Section 2702 shall be provided for emergency power loads specified in Section 405.10.1.

**405.10.1 Emergency power loads.** The following loads are classified as emergency power loads:

1. Emergency voice/alarm communications systems.
2. Fire alarm systems.
3. Automatic fire detection systems.
4. Elevator car lighting.
5. Means of egress and exit sign illumination as required by Chapter 10.
6. Smoke control system.
7. Ventilation and automatic fire detection equipment for smokeproof enclosures.
8. Fire pumps.
9. Elevators in accordance with Section 3003.
10. Stair pressurization systems when provided.

**405.11 Standpipe system.** The underground building shall be provided throughout with a standpipe system in accordance with Section 905.

**SECTION BC 406**  
**MOTOR VEHICLE-RELATED OCCUPANCIES**

**406.1 Private garages and carports.**

**406.1.1 Classification.** Private garages and carports, as defined by this section, shall be classified as Group U occupancy.

**406.1.2 Definitions.** The following words and terms shall, for the purposes of this chapter and as used elsewhere in this code, have the meanings shown herein.

**CARPORT.** A structure or portion of a structure, accessory to a Group R-2 or R-3 occupancy, open on at least two sides and unenclosed for at least 50 percent of perimeter, used for the parking or storage of passenger motor vehicles. Such facility shall not exceed 650 square feet (60.45 m<sup>2</sup>) in area and one story in height

**PRIVATE GARAGE.** An enclosed structure or portion of a structure, accessory to a Group R-2 or R-3 occupancy, used for the parking or storage of passenger motor vehicles. Such facility shall not exceed 650 square feet (60 m<sup>2</sup>) in area and one story in height.

**406.1.3 Floor construction.** Private garage and carport floors shall be of concrete or equivalent noncombustible material that will not absorb flammable liquids. The area of floor used for parking of vehicles shall be sloped to facilitate the movement of liquids to a drain. The sills of all door openings connecting a dwelling unit to a private garage shall be raised at least 4 inches (102 mm) above the floor level of the garage.

**Exception:** Asphalt surfaces shall be permitted at ground level in carports.

**406.1.3.1 Ramps.** Ramps shall have a gradient not exceeding one in seven, with nonslip surfaces, and shall be located entirely within the property line. However, upon application to the commissioner, steeper gradients may be accepted, but in no event greater than one in three.

**406.1.4 Separation.** Separations shall comply with the following:

- 1.** The private garage shall be separated from the dwelling unit and its attic area by means of a minimum 1-hour fire-rated construction. Garages beneath habitable rooms shall be separated from all habitable rooms above by not less than 1-hour fire-rated construction. Openings from a private garage directly into a room used for sleeping purposes shall not be permitted.
- 2.** No air used for heating, cooling, or ventilation shall be circulated through private

garages to dwelling areas.

3. A separation is not required between a Group R-3 occupancy and a carport, provided the carport does not have any enclosed areas above.

## **406.2 Parking garages, open or enclosed.**

**406.2.1 Classification.** Parking garages shall be either open, as per Section 406.3, or enclosed, as per Section 406.4. Parking garages shall also comply with the special provisions of Section 508.

**406.2.2 Definitions.** The following words and terms shall, for the purposes of this chapter and as used elsewhere in this code, have the meanings shown herein.

**PARKING GARAGE.** A structure or portion of a structure, other than a private garage or carport, used for the parking or storage of motor vehicles.

**406.2.3 General requirements.** All parking garages, open or enclosed, shall comply with the general provisions of this section.

**406.2.3.1 Clear height.** The clear height of each floor level in vehicle and pedestrian traffic areas shall not be less than 7 feet (2134 mm). Vehicle and pedestrian areas accommodating van-accessible parking required by Section 1106.5 shall conform to ICC A117.1.

**406.2.3.2 Guards.** Guards shall be provided in accordance with Section 1012 at exterior and interior vertical openings on floor and roof areas where vehicles are parked or moved and where the vertical distance to the ground or surface directly below exceeds 30 inches (762 mm).

**406.2.3.3 Vehicle barriers.** Parking areas shall be provided with exterior or interior walls or vehicle barriers, except at pedestrian or vehicular accesses, designed in accordance with Section 1607.7. Vehicle barriers not less than 2 feet (610 mm) high shall be placed at the ends of drive lanes and at the end of parking spaces where the difference in adjacent floor elevation is greater than 1 foot (305 mm).

**406.2.3.4 Ramps.** Ramps shall have a gradient not exceeding one in seven, with non-slip surfaces. A level landing having a minimum dimension of 20 feet (6096 mm) shall be provided at the discharge point of all ramps at the street level, within the property line. Ramps used for the movement of motor vehicles need not be enclosed when serving tiers above grade. Vehicle ramps may serve as part of a means of egress provided that such ramp complies with the requirements of Sections 1018.1.1 and 1018.1.2.

**406.2.3.5 Floor surface.** Parking surfaces shall be of concrete or similar noncombustible and nonabsorbent materials. The area of floor used for parking of vehicles shall be sloped to facilitate the movement of liquids to a drain.



**Exception:** Asphalt parking surfaces are permitted at ground level.

**406.2.3.6 Separation.** Parking garages shall be separated from other occupancies in accordance with Section 302.1.1.

**406.2.3.6.1 Openings prohibited.** Openings from a parking garage directly into a room used for sleeping purposes shall not be permitted.

**406.2.3.6.2 Special hazards.** Openings from a parking garage to any room in which there is a fuel-fired appliance shall be by means of a vestibule providing a two-doorway separation. Such vestibule and doorway shall be minimum 1-hour rated construction.

**Exception:** A single door, in compliance with Table 715.3, shall be permitted, provided the sources of ignition in the appliance are at least 18 inches (457 mm) above the floor.

**406.2.3.7 Fire fighter aisles.** In any parking garage or lot, one or more aisles, at least 24 inches (610 mm) in width, shall be provided to permit access by fire fighting personnel to all parts of the garage or lot. There shall not be more than three rows of parked motor vehicles between aisles.

### **406.3 Open parking garages.**

**406.3.1 Scope.** Except where specific provisions are made in the following subsections, other requirements of this code shall apply.

**406.3.2 Definitions.** The following words and terms shall, for the purposes of this chapter and as used elsewhere in this code, have the meanings shown herein.

**MECHANICAL-ACCESS OPEN PARKING GARAGES.** Open parking garages employing parking machines, lifts, elevators or other mechanical devices for vehicles moving from and to street level and in which public occupancy is prohibited above the street level.

**OPEN PARKING GARAGE.** A structure or portion of a structure with the openings as described in Section 406.3.3.1 that is used for the parking or storage of private motor vehicles as described in Section 406.3.4.

**RAMP-ACCESS OPEN PARKING GARAGES.** Open parking garages employing a series of continuously rising floors or a series of interconnecting ramps between floors permitting the movement of vehicles under their own power from and to the street level.

**406.3.3 Construction.** Open parking garages shall be of Type I, II or IV construction. Open parking garages shall meet the design requirements of Chapter 16. For vehicle barriers, see

Section 406.2.3.3.

**406.3.3.1 Openings.** For natural ventilation purposes, the exterior side of the structure shall have openings equal to 50 percent of the perimeter walls. The aggregate length of the openings considered to be providing natural ventilation shall constitute a minimum of 40 percent of the perimeter of the tier. Interior walls shall be at least 20 percent open.

**406.3.4 Uses.** Mixed uses shall be allowed in the same building as an open parking garage subject to the provisions of Sections 302.3, 402.7.1, 406.3.13, 508.3, 508.4 and 508.7.

**406.3.5 Area and height.** Area and height of open parking garages shall be limited as set forth in Chapter 5 for Group S-2 occupancies and as further provided for in Section 302.3.

**406.3.5.1 Single use.** When the open parking garage is used exclusively for the parking or storage of private motor vehicles, with no other uses in the building, the area and height shall be permitted to comply with Table 406.3.5.

**Exception:** The grade-level tier is permitted to contain an office, waiting and toilet rooms having a total combined area of not more than 1,000 square feet (93 m<sup>2</sup>). Such area need not be separated from the open parking garage. In open parking garages having a spiral or sloping floor, the horizontal projection of the structure at any cross section shall not exceed the allowable area per parking tier. In the case of an open parking garage having a continuous spiral floor, each 9 feet 6 inches (2896 mm) of height, or portion thereof, shall be considered a tier. The clear height of a parking tier shall not be less than 7 feet (2134 mm), except that a lower clear height is permitted in mechanical-access open parking garages where approved by the commissioner.

**TABLE 406.3.5**  
**OPEN PARKING GARAGES AREA AND HEIGHT**  
**(Table 406.3.5 attached to end of document)**

**406.3.6 Reserved**

**406.3.7 Exterior walls.** Exterior walls and openings in exterior walls shall comply with Tables 601 and 602. The distance from an adjacent property line shall be determined in accordance with Table 602 and Section 704.

**406.3.8 Means of egress.** Open parking garages shall meet the means of egress requirements of Chapter 10. However, where no persons other than parking attendants are permitted, required exit stairways shall not be less than 36 inches (914 mm) wide.

**406.3.9 Standpipes.** Standpipes shall be installed where required by the provisions of Section 905.

**406.3.10 Sprinkler systems.** Automatic sprinkler systems and standpipes shall be installed in accordance with the provisions of Section 903. An automatic dry sprinkler system may be

installed in unheated garages.

**406.3.11 Enclosure of vertical openings.** Enclosure shall not be required for vertical openings.

**406.3.12 Ventilation.** Openings specified in Section 406.3.3.1 shall satisfy natural ventilation requirements. Additional mechanical ventilation shall not be required.

**406.3.13 Prohibitions.** The following uses and alterations are not permitted:

1. Vehicle repair work.
2. Parking of commercial vehicles, buses, trucks and similar vehicles.
3. Partial or complete closing of required openings in exterior walls by tarpaulins or any other means.

**406.4 Enclosed parking garages.** Parking garages and portions thereof that do not meet the definition of open parking garages shall be classified as an enclosed parking garage and shall meet the requirements of this section.

**406.4.1 Heights and areas.** Enclosed parking garages shall be limited to the allowable heights and areas specified in Table 503. Permitted roof parking shall not be considered as a separate story.

**406.4.2 Ventilation.** A mechanical ventilation system shall be provided in accordance with the *New York City Mechanical Code*.

**406.5 Motor fuel-dispensing facilities.**

**406.5.1 Construction.** Motor fuel-dispensing facilities shall be designed and constructed in accordance with the *New York City Fire Code* and this section.

**406.5.2 Canopies.** Canopies under which fuels are dispensed shall have a clear, unobstructed height of not less than 14 feet (4267 mm) to the lowest projecting element in the vehicle drive-through area. Canopies and their supports over pumps shall be of noncombustible materials. However, panels constructed of light-transmitting plastic materials shall be permitted to be installed in canopies erected over motor vehicle fuel-dispensing station fuel dispensers, provided the panels are located at least 10 feet (3048 mm) from any building on the same property and face yards or streets not less than 40 feet (12 192 mm) in width on the other sides. The aggregate areas of plastics shall not exceed 1,000 square feet (93 m<sup>2</sup>). The maximum area of any individual panel shall not exceed 100 square feet (9.3 m<sup>2</sup>).

**406.5.3 Storage tanks.** Motor fuel storage tanks shall be installed below ground, except as authorized by the rules of the Fire Department. The installation and venting of storage tanks

shall be in accordance with the rules of the Fire Department and the requirements of the *New York City Fire Code*. Storage tanks installed below ground shall comply with the following:

1. The top of the storage tanks shall be at least 24 inches (below finished grade and at least 24 inches (610 mm) below the level of any cellar or basement floor within 10 feet (3048 mm) of the tanks.
2. Storage tanks shall be located so that the forces from any building foundation and support loads are not transmitted to the tanks. The distance from any part of a storage tank to the nearest wall of any basement, pit or cellar, or from any property line that may be built upon, shall not be less than 36 inches (914 mm).
3. Storage tanks shall be covered with a structurally supported reinforced concrete slab at least 8 inches (203 mm) thick, extending at least 12 inches (305 mm) beyond the horizontal outlines of the storage tanks, and placed over a cover of suitable clean backfill material. Such slab shall be designed and reinforced in accordance with ACI 318. All concrete shall have a minimum compressive strength of 4,000 pounds per square inch (27 580 kPa) at 28 days.
4. Storage tanks shall be placed on a 12-inch (305 mm) thick concrete base slab or installed in such other manner, secured against flotation, and approved by the department.

#### **406.6 Repair garages.**

**406.6.1 General.** Repair garages shall be constructed in accordance with the *New York City Fire Code* and this section. This occupancy shall not include motor fuel-dispensing facilities, as regulated in Section 406.5.

**406.6.2 Mixed uses.** Mixed uses shall be allowed in the same building as a repair garage subject to the provisions of Section 302.3.

**406.6.3 Ventilation.** Repair garages shall be mechanically ventilated in accordance with the *New York City Mechanical Code*. The ventilation system shall be controlled at the entrance to the garage.

**406.6.4 Floor surface.** Repair garage floors shall be of concrete or similar noncombustible and nonabsorbent materials.

**Exception:** Slip-resistant, nonabsorbent, interior floor finishes having a critical radiant flux not more than  $0.45 \text{ W/cm}^2$ , as determined by NFPA 253, shall be permitted.

**406.6.5 Heating equipment.** Heating equipment shall be installed in accordance with the *New York City Mechanical Code*.

**406.6.6 Gas detection system.** Repair garages used for repair of vehicles fueled by CNG,

LNG, or hydrogen, shall be provided with an approved flammable gas-detection system.

**406.6.6.1 System design.** The flammable gas-detection system shall be calibrated to the types of fuels or gases used by vehicles to be repaired. The gas detection system shall be designed to activate when the level of flammable gas exceeds 25 percent of the lower explosive limit. Gas detection shall also be provided in lubrication or chassis repair pits of garages used for repairing nonodorized LNG-fueled vehicles.

**406.6.6.2 Operation.** Activation of the gas detection system shall result in all of the following:

1. Initiation of distinct audible and visual alarm signals in the repair garage.
2. Deactivation of all heating systems located in the repair garage.
3. Activation of the mechanical ventilation and exhaust system, where the system is interlocked with gas detection.

**406.6.6.3 Failure of the gas detection system.** Failure of the gas detection system shall result in the deactivation of the heating system, activation of the mechanical ventilation system when the system is inter-locked with the gas detection system and cause a trouble signal to sound in an approved location.

## **406.7 Open Parking Lots.**

**406.7.1 General.** The provisions of this section shall govern the construction of open parking lots and to all such existing premises hereafter enlarged or changed in location.

**406.7.2 Definitions.** The following words and terms shall, for the purposes of this chapter and as used elsewhere in this code, have the meanings shown herein.

**OPEN PARKING LOT.** An exterior space with surfacing at grade used for the storage or sale of more than four motor vehicles, including but not limited to parking lots, motor vehicles sales lots, and accessory open parking spaces.

**406.7.3 Permit required.** Any premise intended to be occupied for the storage or sale of motor vehicles on an open parking lot shall require an application to be filed with the department in order to obtain a Certificate of Occupancy. Such Certificate of Occupancy shall indicate the maximum number of vehicles to be accommodated and the type of vehicle, whether private passenger or commercial, to be stored. An application for or including an open parking lot shall be accompanied by a plan exhibiting the following:

1. Dimensions of the lot and its location in relation to adjoining streets; and
2. Any structure(s) existing or to be erected on the plot; and
3. The relative elevations of the parking area, curbs and adjoining yards or courts; and

4. Structures, retaining walls, and open spaces on adjoining premises; and
5. Retaining walls to be built; and
6. Location and dimensions of curb cuts, driveways, and enclosures; and
7. Drainage diagram; and
8. Specification of surfacing material; and
9. Parking stall layout with dimensions; and
10. Analysis exhibiting compliance with the New York City Zoning Resolution; and
11. Other information as may be requested by the commissioner.

A copy of the plan or diagram approved by the department shall be kept on the premises. Certified, reduced size, legible copies may be used for this purpose. When an attendant's shelter is provided on the parking lot, the Certificate of Occupancy issued shall be posted and maintained under glass in the shelter.

**406.7.4 Locations prohibited.** All vehicular activities associated with the operation of open parking lots shall be entirely within the property lines of the premises. Vehicles shall not be permitted to encroach upon the sidewalks. No motor vehicle may be stored or parked in any location where it would obstruct a required window or required exit of any adjacent building.

**406.7.5 Surfacing.** All driveways, parking stalls, and open spaces used for the parking or storage of motor vehicles shall be surfaced with concrete asphalt, or equivalent durable, dustless material.

**406.7.5.1 Drainage.** Open parking lots shall be graded and maintained such that no drainage will flow onto abutting sidewalks and adjoining properties.

**406.7.5.2 Non-porous surfaces.** Where the surface paving of an open parking lot is non-porous, such lot shall be drained as required by the *New York City Plumbing Code*.

**406.7.5.3 Resurfacing.** Resurfacing of existing open parking lots shall comply with this section.

**406.7.6 Curb cuts.** For the purpose of this section, a curb cut shall include all splays when determining the total length of cut curb. Unless otherwise required by the New York City Zoning Resolution, all curb cuts shall comply with the following requirements:

1. The aggregate length of curb cuts shall not exceed 60 percent of any street frontage 100 feet (30 480 mm) or less in length. No single curb cut shall exceed 30 feet (9144

mm) in length, and there shall not be more than two curb cuts on any street frontage 100 feet (30 480 mm) or less in length. The minimum distance between two curb cuts shall be 5 feet (1524 mm).

2. For each 50 feet (15 240 mm) of street frontage length over 100 feet (30 480 mm), an additional curb cut no greater than 30 feet (9144 mm) in length may be permitted.
3. No curb cut shall commence within 8 feet (2438 mm) of a side lot line, except that on corner lots and lots with street frontage length of 50 feet (15 240 mm) or less, the curb cut may commence 30 inches (762 mm) from the side lot line.
4. No curb cut, including splays, shall be less than 10 feet (3048 mm) in length.

**406.7.7 Driveways.** Driveways serving passenger vehicles shall be a minimum of 8 feet (2438 mm) in width and shall not exceed the length of the curb cut, not including the lengths of the splays. For all other motor vehicles, the minimum width of driveways shall be 10 feet (3048 mm). Portions of the driveway located between the curb line and the lot line shall be paved in accordance with the requirements of the Department of Transportation for the construction of sidewalks.

**406.7.8 Curbs and bumpers.** Open parking lots shall be completely separated from adjoining premises and public sidewalks by curbs or bumpers of concrete, masonry, steel, heavy timber, or other similar and equally substantial materials, and shall be securely anchored so as to stop motor vehicles. Curbs and bumpers shall be at least 8 inches (203 mm) high and 8 inches (203 mm) wide.

**406.7.8.1 Openings.** Openings in required perimeter curbs and bumpers shall be permitted only for drainage, for motor vehicle entrances and exits, and for pedestrian entrances and exits. The width of an opening for motor vehicle access shall not exceed the length of the curb cut, not including the lengths of the splays. When an opening for pedestrian access is adjacent to a motor vehicle access opening, the two openings shall be separated by a permanent and substantial post. In no case shall any pedestrian entrance or exit exceed 5 feet (1524 mm) in width.

**406.7.9 Accessory uses and occupancies.** Parking lot offices, attendant shelters, storage facilities, and similar structures used in conjunction with open parking lots may be provided as an accessory use and shall comply with the applicable code provisions. Such accessory structures may be constructed of combustible materials subject to the limitations of Section D105.1.

**406.7.9.1 Motor fuel-dispensing facilities.** Motor fuel-dispensing facilities, accessory to open parking lots, shall comply with the requirements of Section 406.5 of this code and the *New York City Fire Code*. Motor fuel pumps shall be located at least 30 feet (9144 mm) from any parking space or interior lot line.

**406.7.10 Special provisions applicable to large open parking lots.** Open parking lots storing ten or more motor vehicles shall also be subject to the special provisions of this section.

**406.7.10.1 Curbs and bumpers.** Bumpers shall be situated not less than 1 foot (305 mm) from the perimeter edge of the open parking lot where vehicles are parked parallel to such perimeter edge, and not less than 4 feet (1219 mm) from the perimeter edge where vehicles are parked perpendicular to such perimeter edge. Openings shall be limited as provided for in Section 406.7.8.1.

**Exception:** A steel guardrail or other substantial barrier designed in accordance with the provisions of Section 1607.7.3, that will prevent any part of a vehicle from extending across a property line, may be accepted in lieu of bumpers.

**406.7.10.2 Screen enclosures.** Open parking lots shall provide a perimeter screen enclosure as per this section unless otherwise required by the New York City Zoning Resolution. Such screen enclosure may be constructed as a masonry wall, woven wire fence, iron picket fence, or uniformly painted fence of fire-resistant material at least 4 feet (1219 mm) high, but not more than 8 feet (2438 mm) above finished grade, subject to the limitations of Section 3111. Such enclosures shall completely separate the lot from adjoining premises and public sidewalks. Openings shall be limited as provided for in Section 406.7.8.1.

**Exception:** Screening shall not be required for any portion of the lot adjacent to an existing wall located at the lot line.

**406.7.10.3 Illumination.** Open parking lots operating between 6 p.m. and 6 a.m. shall be adequately illuminated to a minimum of 1 foot-candle measured at grade level, distributed over the entire area. Illumination provided with reflectors or floodlights shall be arranged such that the illumination is directed downward and away from adjacent premises.

**406.7.10.4 Fire fighter aisles.** In any open parking lot, one or more aisles, at least 24 inches (610 mm) in width, shall be provided to permit access by fire fighting personnel to all parts of the garage or lot. There shall not be more than three rows of parked motor vehicles between aisles.

## **SECTION BC 407** **GROUP I-2**

**407.1 General.** Occupancies in Group I-2 shall comply with the provisions of this section and other applicable provisions of this code.

**407.2 Corridors.** Corridors in occupancies in Group I-2 shall be continuous to the exits and separated from other areas in accordance with Section 407.3 except spaces conforming to Sections 407.2.1 through 407.2.4.



**407.2.1 Spaces of unlimited area.** Waiting areas and similar spaces constructed as required for corridors shall be permitted to be open to a corridor, only where all of the following criteria are met:

1. The spaces are not occupied for patient sleeping units, treatment rooms, hazardous or incidental use areas as defined in Section 302.1.1.
2. The open space is protected by an automatic fire detection system installed in accordance with Section 907.
3. The corridors onto which the spaces open, in the same smoke compartment, are protected by an automatic fire detection system installed in accordance with Section 907, or the smoke compartment in which the spaces are located is equipped throughout with quick-response sprinklers in accordance with Section 903.3.2.
4. The space is arranged so as not to obstruct access to the required exits.

**407.2.2 Nurses' stations.** Spaces for doctors' and nurses' charting, communications and related clerical areas shall be permitted to be open to the corridor, when such spaces are constructed as required for corridors.

**407.2.3 Mental health treatment areas.** Areas wherein mental health patients who are not capable of self-preservation are housed, or group meeting or multipurpose therapeutic spaces other than incidental use areas as defined in Section 302.1.1, under continuous supervision by facility staff, shall be permitted to be open to the corridor, where the following criteria are met:

1. Each area does not exceed 1,500 square feet (140 m<sup>2</sup>).
2. The area is located to permit supervision by the facility staff.
3. The area is arranged so as not to obstruct any access to the required exits.
4. The area is equipped with an automatic fire detection system installed in accordance with Section 907.2.
5. Not more than one such space is permitted in any one smoke compartment.
6. The walls and ceilings of the space are constructed as required for corridors.

**407.2.4 Gift shops.** Gift shops less than 500 square feet (46 m<sup>2</sup>) in area shall be permitted to be open to the corridor provided the gift shop and storage areas are fully sprinklered and storage areas are protected in accordance with Section 302.1.1.

**407.3 Corridor walls.** Corridor walls shall be constructed as smoke partitions.

**407.3.1 Corridor doors.** Corridor doors, other than those in a wall required to be rated by Section 302.1.1 or for the enclosure of a vertical opening or an exit, shall not have a required fire protection rating and shall not be required to be equipped with self-closing or automatic-closing devices, but shall provide an effective barrier to limit the transfer of smoke and shall be equipped with positive latching. Roller latches are not permitted. Other doors shall conform to Section 715.3.

**407.3.2 Locking devices.** Locking devices that restrict access to the patient room from the corridor, and that are operable only by staff from the corridor side, shall not restrict the means of egress from the patient room except for patient rooms in mental health facilities.

**407.4 Smoke barriers.** Smoke barriers shall be provided to subdivide every story used by patients for sleeping or treatment and to divide other stories with an occupant load of 50 or more persons, into at least two smoke compartments. Such stories shall be divided into smoke compartments with an area of not more than 22,500 square feet (2090 m<sup>2</sup>) and the travel distance from any point in a smoke compartment to a smoke barrier door shall not exceed 200 feet (60 960 mm). The smoke barrier shall be in accordance with Section 709.

**407.4.1 Refuge area.** At least 30 net square feet (2.8 m<sup>2</sup>) per patient shall be provided within the aggregate area of corridors, patient rooms, treatment rooms, lounge or dining areas and other low-hazard areas on each side of each smoke barrier. On floors not housing patients confined to a bed or litter, at least 6 net square feet (0.56 m<sup>2</sup>) per occupant shall be provided on each side of each smoke barrier for the total number of occupants in adjoining smoke compartments.

**407.4.2 Independent egress.** A means of egress shall be provided from each smoke compartment created by smoke barriers without having to return through the smoke compartment from which means of egress originated.

**407.5 Automatic sprinkler system.** Smoke compartments containing patient sleeping units shall be equipped throughout with an automatic fire sprinkler system in accordance with Section 903.3.1.1. The smoke compartments shall be equipped with approved quick-response or residential sprinklers in accordance with Section 903.3.2.

**407.6 Automatic fire detection.** Corridors in nursing homes (both intermediate-care and skilled nursing facilities), detoxification facilities and spaces permitted to be open to corridors by Section 407.2 shall be protected by an automatic fire detection system installed in accordance with Section 907.

**Exceptions:**

1. Corridor smoke detection is not required where patient sleeping units are provided with smoke detectors that comply with UL 268. Such detectors shall provide a visual display on the corridor side of each patient sleeping unit and an audible and visual alarm at the nursing station attending each unit.

2. Corridor smoke detection is not required where patient sleeping unit doors are equipped with automatic door-closing devices with integral smoke detectors on the unit sides installed in accordance with their listing, provided that the integral detectors perform the required alerting function.

**407.7 Secured yards.** Grounds are permitted to be fenced and gates therein are permitted to be equipped with locks, provided that safe dispersal areas having 30 net square feet (2.8 m<sup>2</sup>) for bed and litter patients and 6 net square feet (0.56 m<sup>2</sup>) for ambulatory patients and other occupants are located between the building and the fence. Such provided safe dispersal areas shall not be located less than 50 feet (15 240 mm) from the building they serve.

## **SECTION BC 408** **GROUP I-3**

**408.1 General.** Occupancies in Group I-3 shall comply with the provisions of this section and other applicable provisions of this code (see Section 308.4).

**408.1.1 Occupancy conditions.** Buildings of Group I-3 shall be classified as one of the occupancy conditions indicated in Sections 408.1.1.1 through 408.1.1.5.

**408.1.1.1 Condition 1.** This occupancy condition shall include buildings in which free movement is allowed from sleeping areas, and other spaces where access or occupancy is permitted, to the exterior via means of egress without restraint. A Condition 1 facility is permitted to be constructed as Group R.

**408.1.1.2 Condition 2.** This occupancy condition shall include buildings in which free movement is allowed from sleeping areas and any other occupied smoke compartment to one or more other smoke compartments. Egress to the exterior is impeded by locked exits and exit is not under an occupant's control.

**408.1.1.3 Condition 3.** This occupancy condition shall include buildings in which free movement is allowed within individual smoke compartments, such as within a residential unit comprised of individual sleeping unit(s) and/or group activity spaces, where egress is impeded by remote-controlled door release, leading by means of egress from such a smoke compartment to another smoke compartment.

**408.1.1.4 Condition 4.** This occupancy condition shall include buildings in which free movement is restricted from an occupied space. Remote-controlled release is provided to permit movement from sleeping units, activity spaces and other occupied areas within the smoke compartment to other smoke compartments and egress to the outside is impeded by locked exit and remote door release.

**408.1.1.5 Condition 5.** This occupancy condition shall include buildings in which free movement is restricted from an occupied space. Staff-controlled manual release is provided to permit movement from sleeping units, activity spaces and other occupied areas within the smoke compartment to other smoke compartments.

**408.2 Mixed occupancies.** Portions of buildings with an occupancy in Group I-3 that are classified as a different occupancy shall meet the applicable requirements of this code for such occupancies. Where security operations necessitate the locking of required means of egress, provisions shall be made for the release of occupants at all times. Means of egress from detention and correctional occupancies that traverse other use areas shall, as a minimum, conform to requirements for detention and correctional occupancies.

**Exception:** It is permissible to exit through a horizontal exit into other contiguous occupancies that do not conform to detention and correctional occupancy egress provisions but that do comply with requirements set forth in the appropriate occupancy, as long as the occupancy is not a high-hazard use.

**408.3 Means of egress.** Except as modified or as provided for in this section, the provisions of Chapter 10 shall apply.

**408.3.1 Door width.** Doors to resident sleeping units shall have a clear width of not less than 28 inches (711 mm).

**408.3.2 Sliding doors.** Where doors in a means of egress are of the horizontal-sliding type, the force to slide the door to its fully open position shall not exceed 50 pounds (220 N) with a perpendicular force against the door of 50 pounds (220 N).

**408.3.3 Spiral stairs.** Spiral stairs that conform to the requirements of Section 1009.9 are permitted for access to and between staff locations.

**408.3.4 Exit discharge.** Exits are permitted to discharge into a fenced or walled courtyard. Enclosed yards or courts shall be of a size to accommodate all occupants, a minimum of 50 feet (15 240 mm) from the building with a net area of 15 square feet (1.4 m<sup>2</sup>) per person.

**408.3.5 Sallyports.** A sallyport shall be permitted in a means of egress where there are provisions for continuous and unobstructed passage through the sallyport during an emergency egress condition.

**408.3.6 Vertical exit enclosures.** One of the required vertical exit enclosures in each building shall be permitted to have glazing installed in doors and interior walls at each landing level providing access to the enclosure, provided that the following conditions are met:

1. The vertical exit enclosure shall not serve more than four floor levels.
2. Vertical exit enclosure doors shall not be less than ¾-hour fire doors complying with Section 715.3
3. The total area of glazing at each floor level shall not exceed 5,000 square inches (3.23 m<sup>2</sup>) and individual panels of glazing shall not exceed 1,296 square inches (0.84 m<sup>2</sup>).

4. The glazing shall be protected on both sides by an automatic fire sprinkler system. The sprinkler system shall be designed to wet completely the entire surface of any glazing affected by fire when actuated.
5. The glazing shall be in a gasketed frame and installed in such a manner that the framing system will deflect without breaking (loading) the glass before the sprinkler system operates.
6. Obstructions, such as curtain rods, drapery traverse rods, curtains, drapes or similar materials shall not be installed between the automatic sprinklers and the glazing.

**408.4 Locks.** Egress doors are permitted to be locked in accordance with the applicable use condition. Doors from an area of refuge to the exterior are permitted to be locked with a key in lieu of locking methods described in Section 408.4.1. The keys to unlock the exterior doors shall be available at all times and the locks shall be operable from both sides of the door.

**408.4.1 Remote release.** Remote release of locks on doors in a means of egress shall be provided with reliable means of operation, remote from the resident living areas, to release locks on all required doors. In Occupancy Conditions 3 or 4, the arrangement, accessibility and security of the release mechanism(s) required for egress shall be such that with the minimum available staff at any time, the lock mechanisms are capable of being released within 2 minutes.

**Exception:** Provisions for remote locking and unlocking of occupied rooms in Occupancy Condition 4 are not required provided that not more than 10 locks are necessary to be unlocked in order to move occupants from one smoke compartment to a refuge area within 3 minutes. The opening of necessary locks shall be accomplished with not more than two separate keys.

**408.4.2 Power-operated doors and locks.** Power-operated sliding doors or power-operated locks for swinging doors shall be operable by a manual release mechanism at the door, and either emergency power or a remote mechanical operating release shall be provided.

**Exception:** Emergency power is not required in facilities with 10 locks or less complying with the exception to Section 408.4.1.

**408.4.3 Redundant operation.** Remote release, mechanically operated sliding doors or remote release, mechanically operated locks shall be provided with a mechanically operated release mechanism at each door, or shall be provided with a redundant remote release control.

**408.4.4 Relock capability.** Doors remotely unlocked under emergency conditions shall not automatically relock when closed unless specific action is taken at the remote location to enable doors to relock.

**408.5 Vertical openings.** Vertical openings shall be enclosed in accordance with Section 707.

**Exception:** A floor opening between floor levels of residential housing areas is permitted without enclosure protection between the levels, provided that both of the following conditions are met:

1. The entire normally occupied areas so interconnected are open and unobstructed so as to enable observation of the areas by supervisory personnel.
2. Means of egress capacity is sufficient to provide simultaneous egress for all occupants from all interconnected levels and areas.

The height difference between the highest and lowest finished floor levels shall not exceed 23 feet (7010 mm). Each story, considered separately, has at least one-half of its individual required means of egress capacity provided by exits leading directly out of that story without traversing to another story within the interconnected area.

**408.6 Smoke barrier.** Occupancies in Group I-3 shall have smoke barriers complying with Section 709 to divide every story occupied by residents for sleeping, or any other story having an occupant load of 50 or more persons, into at least two smoke compartments.

**Exception:** Spaces having direct exit to one of the following, provided that the locking arrangement of the doors involved complies with the requirements for doors at the compartment barrier for the use condition involved:

1. A public way.
2. A building separated from the resident housing area by a 2-hour fire-resistance-rated assembly or 50 feet (15 240 mm) of open space.
3. A secured yard or court having a holding space 50 feet (15 240 mm) from the housing area that provides 6 square feet (0.56 m<sup>2</sup>) or more of refuge area per occupant, including residents, staff and visitors.

**408.6.1 Smoke compartments.** The maximum number of residents in any smoke compartment shall be 200. The travel distance to a door in a smoke barrier from any room door required as exit access shall not exceed 150 feet (45 720 mm). The travel distance to a door in a smoke barrier from any point in a room shall not exceed 200 feet (60 960 mm).

**408.6.2 Refuge area.** At least 6 net square feet (0.56 m<sup>2</sup>) per occupant shall be provided on each side of each smoke barrier for the total number of occupants in adjoining smoke compartments. This space shall be readily available wherever the occupants are moved across the smoke barrier in a fire emergency.

**408.6.3 Independent egress.** A means of egress shall be provided from each smoke compartment created by smoke barriers without having to return through the smoke compartment from which means of egress originates.

**408.7 Subdivision of resident housing areas.** Sleeping areas and any contiguous day room, group activity space or other common spaces where residents are housed shall be separated from other spaces in accordance with Sections 408.7.1 through 408.7.4.

**408.7.1 Occupancy Conditions 3 and 4.** Each sleeping area in Occupancy Conditions 3 and 4 shall be separated from the adjacent common spaces by a smoke-tight partition where the travel distance from the sleeping area through the common space to the exit access corridor exceeds 50 feet (15 240 mm).

**408.7.2 Occupancy Condition 5.** Each sleeping area in Occupancy Condition 5 shall be separated from adjacent sleeping areas, corridors and common spaces by a smoke-tight partition. Additionally, common spaces shall be separated from the exit access corridor by a smoke-tight partition.

**408.7.3 Openings in room face.** The aggregate area of openings in a solid sleeping room face in Occupancy Conditions 2, 3, 4 and 5 shall not exceed 120 square inches (77 419 mm<sup>2</sup>). The aggregate area shall include all openings including door undercuts, food passes and grilles. Openings shall be not more than 36 inches (914 mm) above the floor. In Occupancy Condition 5, the openings shall be closeable from the room side.

**408.7.4 Smoke-tight doors.** Doors in openings in partitions required to be smoke tight by Section 408.7 shall be substantial doors, of construction that will resist the passage of smoke. Latches and door closures are not required on cell doors.

**408.8 Windowless buildings.** For the purposes of this section, a windowless building or portion of a building is one with nonopenable windows, windows not readily breakable or without windows. Windowless buildings shall be provided with an engineered smoke control system to provide ventilation (mechanical or natural) in accordance with Section 909 for each windowless smoke compartment.

## **SECTION BC 409**

### **MOTION PICTURE PROJECTION ROOMS**

**409.1 General.** The provisions of this section shall apply to rooms in which ribbon-type cellulose acetate or other safety film is utilized in conjunction with electric arc, xenon or other light-source projection equipment that develops hazardous gases, dust or radiation. The projection, use or storage of film having a nitrocellulose base (commonly known as nitrate film) shall not be permitted except under conditions specified in special permits when issued by the Fire Department. Safety film meeting the specification and test standards of NFPA 40 may be projected, used or stored.

**409.1.1 Projection room required.** Every motion picture machine projecting film as

mentioned within the scope of this section shall be enclosed in a projection room. Appurtenant electrical equipment, such as rheostats, transformers and generators, shall be within the projection room or in an adjacent room of equivalent construction.

**409.2 Construction of projection rooms.** Every projection room shall be of permanent construction consistent with the construction requirements for the type of building in which the projection room is located. Openings are not required to be protected. The room shall have a floor area of not less than 80 square feet (7.44 m<sup>2</sup>) for a single machine and at least 40 square feet (3.7 m<sup>2</sup>) for each additional machine. Each motion picture projector, floodlight, spotlight or similar piece of equipment shall have a clear working space of not less than 30 inches by 30 inches (762 mm by 762 mm) on each side and at the rear thereof, but only one such space shall be required between two adjacent projectors. The projection room and the rooms appurtenant thereto shall have a ceiling height of not less than 7 feet 6 inches (2286 mm). The aggregate of openings for projection equipment shall not exceed 25 percent of the area of the wall between the projection room and the auditorium. Openings shall be provided with glass or other approved material, so as to close completely the opening.

**409.3 Projection room and equipment ventilation.** Ventilation shall be provided in accordance with the *New York City Mechanical Code*.

#### **409.3.1 Projection room.**

**409.3.1.1 Supply air.** Each projection room shall be provided with adequate air supply inlets so arranged as to provide well-distributed air throughout the room. Air inlet ducts shall provide an amount of air equivalent to the amount of air being exhausted by projection equipment. Air is permitted to be taken from the outside; from adjacent spaces within the building, provided the volume and infiltration rate is sufficient; or from the building air-conditioning system, provided it is so arranged as to provide sufficient air when other systems are not in operation.

**409.3.1.2 Exhaust air.** Projection rooms are permitted to be exhausted through the lamp exhaust system. The lamp exhaust system shall be positively interconnected with the lamp so that the lamp will not operate unless there is the required airflow. Exhaust air ducts shall terminate at the exterior of the building in such a location that the exhaust air cannot be readily recirculated into any air supply system. The projection room ventilation system is permitted to also serve appurtenant rooms, such as the generator and rewind rooms.

Each projection machine shall be provided with an exhaust duct that will draw air from each lamp and exhaust it directly to the outside of the building. The lamp exhaust is permitted to serve to exhaust air from the projection room to provide room air circulation. Such ducts shall be of rigid materials, except for a flexible connector approved for the purpose. The projection lamp or projection room exhaust system, or both, is permitted to be combined but shall not be interconnected with any other exhaust or return system, or both, within the building.



**409.4 Lighting control.** Provisions shall be made for control of the auditorium lighting and the means of egress lighting systems of theaters from inside the projection room and from at least one other convenient point in the building.

**409.5 Miscellaneous equipment.** Each projection room shall be provided with rewind and film storage facilities.

## **SECTION BC 410** **STAGES AND PLATFORMS**

**410.1 Applicability.** The provisions of this section shall apply to all parts of buildings and structures that contain stages or platforms and similar appurtenances as herein defined.

**410.2 Definitions.** The following words and terms shall, for the purposes of this section and as used elsewhere in this code, have the meanings shown herein.

**FLY GALLERY.** A raised floor area above a stage from which the movement of scenery and operation of other stage effects are controlled.

**GRIDIRON.** The structural framing over a stage supporting equipment for hanging or flying scenery and other stage effects.

**PINRAIL.** A rail on or above a stage through which belaying pins are inserted and to which lines are fastened.

**PLATFORM.** A raised area within a building used for worship, the presentation of music, plays or other entertainment; the head table for special guests; the raised area for lecturers and speakers; boxing and wrestling rings; theater- in-the-round stages; and similar purposes wherein there are no overhead hanging curtains, drops, scenery or stage effects other than lighting and sound. A temporary platform is one installed for not more than 30 days.

**PROSCENIUM WALL.** The wall that separates the stage from the auditorium or assembly seating area.

**STAGE.** A space within a building utilized for entertainment or presentations, which includes overhead hanging curtains, drops, scenery or stage effects other than lighting and sound. Stage area shall be measured to include the entire performance area and adjacent backstage and support areas not separated from the performance area by fire-resistance- rated construction. Stage height shall be measured from the lowest point on the stage floor to the highest point of the roof or floor deck above the stage.

**410.3 Stages.** Stage construction shall comply with Sections 410.3.1 through 410.3.7.

**410.3.1 Stage construction.** Stage floors shall be constructed of materials as required for floors for the type of construction of the building in which such stages are located. Where areas below the stage are used for other occupancies, such stage floor shall be constructed in

accordance with the requirements for separated occupancies as per Chapter 3.

**Exceptions:**

1. Stages of Type IIB or IV construction with a nominal 2-inch (51 mm) wood deck, provided that the stage is separated from other areas in accordance with Section 410.3.4.
2. In all types of construction, the finished floor shall be constructed of wood or approved noncombustible materials. Openings through stage floors shall be equipped with tight-fitting, solid wood trap doors with approved safety locks. The room or space below the stage into which the traps or lifts open shall be completely enclosed by construction having at least the fire-resistance rating required for the stage floor, and such room or space shall not be used as a workshop or storage area. Storage shall not be deemed to include the location in this area of scenery or scenic elements used during a performance. However, no combustible material that has a flame spread rating greater than 25 or that has not been rendered flameproof in accordance with the rules of the Fire Commissioner may be stored in this location at any time.

**410.3.1.1 Stage height and area.** Stage areas shall be measured to include the entire performance area and adjacent backstage and support areas not separated from the performance area by fire-resistance-rated construction. Stage height shall be measured from the lowest point on the stage floor to the highest point of the roof or floor deck above the stage.

**410.3.2 Galleries, gridirons, catwalks and pinrails.** Beams designed only for the attachment of portable or fixed theater equipment, gridirons, galleries and catwalks shall be constructed of noncombustible materials. Floors of fly galleries and catwalks shall be constructed of noncombustible material. These areas shall not be considered to be floors, stories, mezzanines or levels in applying this code.

**410.3.3 Exterior stage doors.** Where protection of openings is required, exterior exit doors shall be protected with fire doors that comply with Section 715. Exterior openings that are located on the stage for means of egress or loading and unloading purposes, and that are likely to be open during occupancy of the theater, shall be constructed with vestibules to prevent air drafts into the auditorium.

**410.3.4 Proscenium wall.** Where the stage height is greater than 50 feet (15 240 mm), all portions of the stage shall be completely separated from the seating area by a proscenium wall with not less than a 2-hour fire-resistance rating extending continuously from the foundation to the roof.

**410.3.5 Proscenium curtain.** The proscenium opening of every stage with a height greater than 50 feet (15 240 mm) shall be provided with a curtain of approved material or an approved water curtain complying with Section 903.3.1.1. The curtain shall be designed and

installed to intercept hot gases, flames and smoke, and to prevent a glow from a severe fire on the stage from showing on the auditorium side for a period of 20 minutes. The closing of the curtain from the full open position shall be affected in less than 30 seconds, but the last 8 feet (2438 mm) of travel shall require not less than 5 seconds.

**410.3.5.1 Activation.** The curtain shall be activated by rate-of-rise heat detection installed in accordance with Section 907.10 operating at a rate of temperature rise of 15 to 20°F per minute (8 to 11°C per minute), and by an auxiliary manual control.

**410.3.5.2 Fire test.** A sample curtain with a minimum of two vertical seams shall be subjected to the standard fire test specified in ASTM E 119 for a period of 30 minutes. The curtain shall overlap the furnace edges by an amount that is appropriate to seal the top and sides. The curtain shall have a bottom pocket containing a minimum of 4 pounds per linear foot (58 N/m) of batten. The exposed surface of the curtain shall not glow, and flame or smoke shall not penetrate the curtain during the test period. Unexposed surface temperature and hose stream test requirements are not applicable to the proscenium fire safety curtain test.

**410.3.5.3 Smoke test.** Curtain fabrics shall have a smoke-developed rating of 25 or less when tested in accordance with ASTM E 84.

**410.3.5.4 Tests.** The completed proscenium curtain shall be subjected to operating tests prior to the issuance of a certificate of occupancy.

**410.3.6 Scenery.** All scenery or scenic elements shall be of noncombustible materials, or of materials having a flame-spread rating not exceeding 25, or of materials that have been rendered flameproof in compliance with the rules of the Fire Commissioner. Scenery and scenic elements not complying with the above requirements may be used only when expressly permitted by the Fire Department.

**410.3.7 Stage ventilation.** Emergency ventilation shall be provided for stages larger than 1,000 square feet (93 m<sup>2</sup>) in floor area, or with a stage height greater than 50 feet (15 240 mm). Such ventilation shall comply with Section 410.3.7.1 or 410.3.7.2.

**410.3.7.1 Roof vents.** Two or more vents constructed to open automatically by approved heat-activated devices and with an aggregate clear opening area of not less than 5 percent of the area of the stage shall be located near the center and above the highest part of the stage area. Supplemental means shall be provided for manual operation of the ventilator. Curbs shall be provided as required for skylights in Section 2610.2. Vents shall be labeled.

**410.3.7.2 Smoke control.** Smoke control in accordance with Section 909 shall be provided to maintain the smoke layer interface not less than 6 feet (1829 mm) above the highest level of the assembly seating or above the top of the proscenium opening where a proscenium wall is provided in compliance with Section 410.3.4.

**410.4 Platform construction.** Permanent platforms shall be constructed of materials as required for the type of construction of the building in which the permanent platform is located. Permanent platforms are permitted to be constructed in accordance with the following:

1. The area below the platform shall be enclosed on all sides with solid construction.
2. Platforms constructed of untreated wood shall not exceed an area of 400 square feet (37 m<sup>2</sup>). Platforms constructed of fire retardant treated wood shall not exceed an area of 1,200 square feet (111 m<sup>2</sup>). Platforms constructed of noncombustible materials shall not be limited in area.
3. Where wood is used, the floor of the platform shall be a least 1 inch (25 mm) nominal thickness. Such floor shall be laid on a solid, noncombustible backing, or shall have all spaces between supporting members fire blocked with noncombustible material.

Where the space beneath the permanent platform is used for storage or any other purpose other than equipment, wiring or plumbing, the floor construction shall not be less than 1-hour fire-resistant construction. Where the space beneath the permanent platform is used only for equipment, wiring or plumbing, the underside of the permanent platform need not be protected.

**410.4.1 Temporary platforms.** Platforms installed for a period of not more than 30 days are permitted to be constructed of any materials permitted by the code. The space between the floor and the platform above shall only be used for plumbing and electrical wiring to platform equipment.

**410.5 Dressing and appurtenant rooms.** Dressing and appurtenant rooms shall comply with Sections 410.5.1 through 410.5.4.

**410.5.1 Separation from stage.** Where the stage height is greater than 50 feet (15 240 mm), the stage shall be separated from dressing rooms, scene docks, property rooms, workshops, storerooms and compartments appurtenant to the stage and other parts of the building by a fire barrier wall and horizontal assemblies, or both, with not less than a 2-hour fire-resistance rating with approved opening protectives. For stage heights of 50 feet (15 240 mm) or less, the required stage separation shall be a fire barrier wall and horizontal assemblies, or both, with not less a 1-hour fire-resistance rating with approved opening protectives.

**410.5.2 Separation from each other.** Dressing rooms, scene docks, property rooms, workshops, storerooms and compartments appurtenant to the stage shall be separated from each other by fire barrier wall and horizontal assemblies, or both, with not less than a 1-hour fire-resistance rating with approved opening protectives.

**410.5.3 Opening protectives.** Openings other than to trunk rooms and the necessary doorways at stage level shall not connect such rooms with the stage, and such openings shall be protected with fire door assemblies that comply with Section 715.

**410.5.4 Stage exits.** At least one approved means of egress shall be provided from each side of the stage; and from each side of the space under the stage. At least one means of escape shall be provided from each fly gallery and from the gridiron. A steel ladder, alternating tread stairway or spiral stairway is permitted to be provided from the gridiron to a scuttle in the stage roof.

**410.6 Automatic sprinkler system.** Stages shall be equipped with an automatic fire-extinguishing system in accordance with Chapter 9. The system shall be installed under the roof and gridiron, in the tie and fly galleries and in places behind the proscenium wall of the stage and in dressing rooms, lounges, workshops and storerooms accessory to such stages:

- 1 Automatic sprinklers shall be placed above all rigging lofts; and above all stage areas, other than those portions of stage areas specifically designated on approved plans as performing areas that do not have rigging lofts above and that are not at any time used for storage purposes. Sprinklers above rigging lofts shall be located so that no gridiron or other obstruction intervenes between the sprinkler heads and the scenery or scenic elements.
2. When any part of a stage is sprinklered in accordance with the provisions of Item 1 of this section, or when rigging lofts are provided, such stage areas and rigging lofts shall be completely separated from audience areas by a deluge sprinkler system designed to form a vertical water curtain, with heads spaced to provide a water density of at least 3 gallons per minute per linear foot. A deluge valve actuated by a “rate of rise system “and” fixed temperature system shall control the water curtain system. The heat actuating devices shall be located on not more than 10 foot (3048 mm) centers around the perimeter of the sprinklered area or as otherwise required for the type of device used to assure operation of the system. In addition to the automatic controls, manual-operating devices shall be located at the voice/alarm communication system required by Section 410.8, and adjacent to at least one exit from the stage. Such exit shall be remote from the voice/alarm communication system.
3. When openings are provided in the stage floor for stage lifts, trap doors or stairs, sprinklers spaced 5 feet (1524 mm) on centers shall be provided around the opening at the ceiling below the stage, and baffles at least 12 inches (305 mm) in depth shall be installed around the perimeter of the opening.
4. All valves controlling sprinkler supplies shall be provided with tamper switches wired to an annunciator panel located at the voice/alarm communication system required by Section 410.8.
5. The operation of any section of the sprinkler system and the deluge system shall activate the emergency ventilating equipment required in Section 410.3.7 and shall be provided with central station supervision in addition to the required local alarm.
6. The water flow alarm, tamper switches and deluge system equipment shall be provided with central station supervision in addition to the required local alarm.

**Exception:** Sprinklers are not required under stage areas less than 4 feet (1219 mm) in clear height utilized exclusively for storage of tables and chairs, provided the concealed space is separated from the adjacent spaces by not less than 5/8-inch (15.9 mm) Type X gypsum board.

**410.7 Standpipes.** Standpipe systems shall be provided in accordance with Section 905.

**410.8 Voice/alarm communication system.** Stages shall be provided with a voice/alarm communication system in accordance with Section 907.2.1.1.

**410.9 Construction in seating areas.**

**410.9.1 Scenery and scenic elements in seating areas.** Scenery or scenic elements may be placed in seating sections if such elements:

1. Are noncombustible, or of materials that have been rendered flameproof in accordance with the rules of the Fire Commissioner, or have a flame spread rating of 25 or less.
2. Are adequately braced or secured.
3. Do not obstruct the required visibility of, or paths of travel to, exit openings.

**410.9.2 Platforms or runways in seating areas.** Platforms or runways for performances, to accommodate the operation of cameras, electronic equipment, or motion picture projection machines not using carbon-arc or other light source that emits a gaseous discharge may be constructed in seating sections, provided such platforms or runways comply with the requirements of Section 410.4, except Item 1 and Section 410.8.

**410.10 Stage lighting.** Stage lights shall be placed such that they will not develop temperatures on the surface of any material that will cause that material to ignite, or smoke, or cause its flame proofing to deteriorate.

## **SECTION BC 411**

### **SPECIAL AMUSEMENT BUILDINGS**

**411.1 General.** Special amusement buildings having an occupant load of 75 or more shall comply with the requirements for the appropriate Group A occupancy and this section. Amusement buildings having an occupant load of less than 75 shall comply with the requirements for a Group B occupancy and this section.

**Exception:** Amusement buildings or portions thereof that are without walls or a roof and constructed to prevent the accumulation of smoke. All decorative material shall be non-combustible or composed of flame retardant fabric.

**411.2 Special amusement building.** A special amusement building is any temporary or permanent building or portion thereof that is occupied for amusement, entertainment or

educational purposes and that contains a device or system that conveys passengers or provides a walkway along, around or over a course in any direction so arranged that the means of egress path is not readily apparent due to visual or audio distractions or is intentionally confounded or is not readily available because of the nature of the attraction or mode of conveyance through the building or structure.

**411.3 Automatic fire detection.** Special amusement buildings shall be equipped with an automatic fire detection system, in accordance with Section 907.

**411.4 Automatic sprinkler system.** Special amusement buildings shall be equipped throughout with an automatic sprinkler system in accordance with Section 903.3.1.1. Where the special amusement building is temporary, the sprinkler water supply shall be of an approved temporary means.

**Exception:** Automatic fire sprinklers are not required where the total floor area of a temporary special amusement building is less than 1,000 square feet (93 m<sup>2</sup>) and the travel distance from any point to an exit is less than 50 feet (15 240 mm).

**411.5 Alarm.** Actuation of a single smoke detector, the automatic sprinkler system or other automatic fire detection device shall immediately sound an alarm at the building at a constantly attended location from which emergency action can be initiated including the capability of manual initiation of requirements in Section 907.2.11.2.

**411.6 Emergency voice/alarm communications system.** An emergency voice/alarm communications system shall be provided in accordance with Sections 907.2.11 and 907.2.12.2, which is also permitted to serve as a public address system and shall be audible throughout the entire special amusement building.

**411.7 Exit marking.** Exit signs shall be installed at the required exit or exit access doorways of amusement buildings. Approved directional exit markings shall also be provided. Where mirrors, mazes or other designs are utilized that disguise the path of egress travel such that they are not apparent, approved low-level exit signs and directional path markings shall be provided and located not more than 8 inches (203 mm) above the walking surface and on or near the path of egress travel. Such markings shall become visible in an emergency. The directional exit marking shall be activated by the automatic fire detection system and the automatic sprinkler system in accordance with Section 907.2.11.2.

**411.8 Interior finish.** The interior finish shall be Class A in accordance with Section 803.1.

## **SECTION BC 412** **AIRCRAFT-RELATED OCCUPANCIES**

**412.1 Reserved.**

**412.2 Reserved.**

412.3 Reserved.

412.4 Reserved.

**412.5 Heliports and helistops.**

**412.5.1 General.** Heliports and helistops may be erected on buildings or other locations where they are constructed in accordance with this section.

**412.5.2 Definitions.** The following words and terms shall, for the purposes of this chapter and as used elsewhere in this code, have the meanings shown herein.

**HELIPORT.** An area of land or water or a structural surface that is designed or used for the landing and taking off of helicopters, and any appurtenant areas that are designed or used for heliport facilities and operations.

**HELISTOP.** An area of land or water or a structural surface that is designed or used for the landing or takeoff of helicopters, and any appurtenant areas, but that is not designed or used for fueling, defueling, maintenance, repairs or storage of helicopters.

**412.5.3 Size.** The touchdown or landing area for helicopters of less than 3,500 pounds (1588 kg) shall be a minimum of 20 feet (6096 mm) in length and width. The touchdown area shall be surrounded on all sides by a clear area having a minimum average width at roof level of 15 feet (4572 mm) but with no width less than 5 feet (1524 mm).

**412.5.4 Design.** Helicopter landing areas and the supports thereof on the roof of a building shall be noncombustible construction. Landing areas shall be designed to confine any flammable liquid spillage to the landing area itself and provisions shall be made to drain such spillage away from any exit or stairway serving the helicopter landing area or from a structure housing such exit or stairway. For structural design requirements, see Section 1605.5.

**412.5.5 Means of egress.** The means of egress from heliports and helistops shall comply with the provisions of Chapter 10. Landing areas located on buildings or structures shall have two or more means of egress. For landing platforms or roof areas less than 60 feet (18 288 mm) in length, or less than 2,000 square feet (186 m<sup>2</sup>) in area, the second means of egress may be a fire escape or ladder leading to the floor below.

**412.5.6 Rooftop heliports and helistops.** Rooftop heliports and helistops shall comply with NFPA 418 and the *New York City Fire Code*.

**SECTION BC 413**  
**COMBUSTIBLE STORAGE**

**413.1 General.** Storage of combustible materials in attics, under-floor spaces, concealed spaces, and below-grade storage rooms shall comply with this section.



**413.2 Attic, under-floor and concealed spaces.** Attic, under-floor and concealed spaces used for storage of combustible materials shall be protected on the storage side as required for 1-hour fire-resistant construction. Openings shall be protected by assemblies that are self-closing and are of noncombustible construction or solid wood core not less than 1¾ inch (45 mm) in thickness.

**Exceptions:**

1. Areas protected by approved automatic sprinkler systems.
2. Group R-3 and U occupancies.
3. Buildings and areas classified in Storage Occupancy Groups S-1 and S-2.

**413.3 High-piled stock or rack storage.** High-piled stock or rack storage in any occupancy group shall comply with the *New York City Fire Code*.

**SECTION BC 414**  
**HAZARDOUS MATERIALS**

**414.1 General.** The provisions of this section shall apply to buildings and structures occupied for the manufacturing, processing, dispensing, use or storage of hazardous materials.

**414.1.1 Other provisions.** Buildings and structures with an occupancy in Group H shall also comply with the applicable provisions of Section 415 and the *New York City Fire Code*, including, but not limited to, location, installation, and mechanical provisions.

**414.1.2 Materials.** The safe design of hazardous material occupancies is material dependent. Individual material requirements are also found in Sections 307 and 415, and in the *New York City Mechanical Code* and the *New York City Fire Code*.

**414.1.2.1 Aerosols.** Level 2 and 3 aerosol products shall be stored and displayed in accordance with the *New York City Fire Code*.

**414.1.3 Information required.** Separate floor plans shall be submitted for buildings and structures with an occupancy in Group H, identifying the locations of anticipated contents and processes so as to reflect the nature of each occupied portion of every building and structure. A report identifying hazardous materials including, but not limited to, materials representing hazards that are classified in Group H to be stored or used, shall be submitted and the methods of protection from such hazards shall be indicated on the construction documents. The opinion and report shall be prepared by a qualified person, firm or corporation approved by the commissioner and shall be provided without charge to the department.

**414.2 Control areas.** Control areas shall be those spaces within a building where quantities of hazardous materials not exceeding the maximum quantities allowed by this code are stored, dispensed, used or handled.

**414.2.1 Construction requirements.** Control areas shall be separated from each other by not less than a 1-hour fire barrier constructed in accordance with Chapter 7.

**414.2.2 Number.** The maximum number of control areas within a building shall be in accordance with Table 414.2.2.

**TABLE 414.2.2**  
**DESIGN AND NUMBER OF CONTROL AREAS**  
**(Table 414.2.2 attached to end of document)**

**414.2.3 Separation.** The required fire-resistance rating for fire barrier assemblies shall be in accordance with Table 414.2.2. The floor construction of the control area, and the construction supporting the floor of the control area, shall have a minimum 2-hour fire-resistance rating and shall comply with the additional requirements of the *New York City Fire Code*.

**414.2.4 Hazardous material in Group M display and storage areas and in Group S storage areas.** The aggregate quantity of nonflammable solid and nonflammable or noncombustible liquid hazardous materials permitted within a single control area of a Group M or S occupancy or an outdoor control area is permitted to exceed the maximum allowable quantities per control area specified in Tables 307.7(1) and 307.7(2) without classifying the building or use as a Group H occupancy, provided that the materials are displayed and stored in accordance with the *New York City Fire Code* and quantities do not exceed the maximum allowable specified in Table 414.2.4.

**TABLE 414.2.4**  
**MAXIMUM ALLOWABLE QUANTITY PER INDOOR AND OUTDOOR**  
**CONTROL AREA IN GROUP M AND S OCCUPANCIES**  
**NONFLAMMABLE SOLIDS AND NONFLAMMABLE AND**  
**NONCOMBUSTIBLE LIQUIDS<sup>d,e,f</sup>**  
**(Table 414.2.4 attached to end of document)**

**414.2.4.1 Below-grade storage of flammable or combustible mixtures accessory to Group M establishments.** Class I liquids shall not be stored in below-grade locations. Storage of Class II and Class III liquids, accessory to retail stores, and partly or completely below grade shall be permitted, provided that such below-grade area is equipped throughout with an automatic sprinkler system in accordance with Section 903.3.1.1 and enclosed by fire barriers having a fire-resistance rating of at least 2 hours, constructed in accordance with the construction type of the building. Openings shall be protected by self-closing assemblies having a fire-resistance rating of at least 1½ hours.

**Exception:** Class IIIB liquids may be stored in below-grade locations that are not provided throughout with an automatic sprinkler system when such liquids are stored

in a room that is separated, vertically and horizontally, from surrounding spaces by fire barriers of not less than 2-hour fire-resistance rating and such room is provided with an automatic sprinkler system.

**414.3 Ventilation.** Rooms, areas or spaces of Group H in which explosive, corrosive, combustible, flammable or highly toxic dusts, mists, fumes, vapors or gases are or may be emitted due to the processing, use, handling or storage of materials shall be mechanically ventilated as required by the *New York City Fire Code* and the *New York City Mechanical Code*. Ducts conveying explosives or flammable vapors, fumes or dusts shall extend directly to the exterior of the building without entering other spaces. Exhaust ducts shall not extend into or through ducts and plenums.

**Exception:** Ducts conveying vapor or fumes having flammable constituents less than 25 percent of their lower flammable limit (LFL) are permitted to pass through other spaces.

Emissions generated at workstations shall be confined to the area in which they are generated as specified in the *New York City Fire Code* and the *New York City Mechanical Code*.

The location of supply and exhaust openings shall be in accordance with the *New York City Mechanical Code*. Exhaust air contaminated by highly toxic material shall be treated in accordance with the *New York City Fire Code*.

A manual shutoff control for ventilation equipment required by this section shall be provided outside the room adjacent to the principal access door to the room. The switch shall be of the break-glass type and shall be labeled: VENTILATION SYSTEM EMERGENCY SHUTOFF.

**414.4 Hazardous material systems.** Systems involving hazardous materials shall be suitable for the intended application. Controls shall be designed to prevent materials from entering or leaving process or reaction systems at other than the intended time, rate or path. Automatic controls, where provided, shall be designed to be fail safe.

**414.5 Inside storage, dispensing and use.** The inside storage, dispensing and use of hazardous materials in excess of the maximum allowable quantities per control area of Tables 307.7(1) and 307.7(2) shall be in accordance with Sections 414.5.1 through 414.5.5 of this code and the *New York City Fire Code*.

**414.5.1 Explosion control.** Explosion control shall be provided in accordance with the *New York City Fire Code* as required by Table 414.5.1 where quantities of hazardous materials specified in that table exceed the maximum allowable quantities in Table 307.7(1) or where a structure, room or space is occupied for purposes involving explosion hazards as required by Section 415 or the *New York City Fire Code*.

**TABLE 414.5.1**  
**EXPLOSION CONTROL REQUIREMENTS<sup>a</sup>**  
**(Table 414.5.1 attached to end of document)**

**414.5.2 Monitor control equipment.** Monitor control equipment shall be provided where required by the *New York City Fire Code*.

**414.5.3 Automatic fire detection systems.** Group H occupancies shall be provided with an automatic fire detection system in accordance with Section 907.2.

**414.5.4 Emergency power.** Where mechanical ventilation, treatment systems, temperature control, alarm, detection or other electrically operated systems are required, such systems shall be provided with an emergency power system in accordance with the *New York City Electrical Code*.

**Exceptions:**

1. Storage areas for Class I and II oxidizers.
2. Storage areas for Class III, IV and V organic peroxides.
3. Emergency power for mechanical ventilation, treatment systems and temperature control systems shall not be required where an approved fail-safe engineered system is installed.

**414.5.5 Spill control, drainage and containment.** Rooms, buildings or areas occupied for the storage of solid and liquid hazardous materials shall be provided with a means to control spillage and to contain or drain off spillage and fire protection water discharged in the storage area where required in the *New York City Fire Code*. The methods of spill control shall be in accordance with the *New York City Fire Code*.

**414.5.6 Storage of medical gases.** When required by the *New York City Fire Code*, a one-hour room shall be provided for the storage of medical gases inside of buildings, with the protected openings and ventilation provisions as required by the *New York City Fire Code*.

**414.6 Outdoor storage, dispensing and use.** The outdoor storage, dispensing and use of hazardous materials shall be in accordance with the *New York City Fire Code*.

**414.6.1 Weather protection.** Where weather protection is provided for sheltering outdoor hazardous material storage or use areas, such storage or use shall be considered outdoor storage or use, provided that all of the following conditions are met:

1. Structure supports and walls shall not obstruct more than one side nor more than 25 percent of the perimeter of the storage or use area.
2. The distance from the structure and the structure supports to buildings, lot lines, public ways or means of egress to a public way shall not be less than the distance required for an outside hazardous material storage or use area without weather protection.

3. The overhead structure shall be of approved noncombustible construction with a maximum area of 1,500 square feet (140 m<sup>2</sup>).

**Exception:** The increases permitted by Section 506 apply.

**414.7 Emergency alarms.** Emergency alarms for the detection and notification of an emergency condition in Group H occupancies shall be provided as set forth herein.

**414.7.1 Storage.** An approved manual emergency alarm system shall be provided in buildings, rooms or areas used for storage of hazardous materials. Emergency alarm-initiating devices shall be installed outside of each interior exit or exit access door of storage buildings, rooms or areas. Activation of an emergency alarm-initiating device shall sound a local alarm to alert occupants of an emergency situation involving hazardous materials.

**414.7.2 Dispensing, use and handling.** Where hazardous materials having a hazard ranking of 3 or 4 in accordance with NFPA 704 are transported through corridors or exit enclosures, there shall be an emergency telephone system, a local manual alarm station or an approved alarm-initiating device at not more than 150-foot (45 720 mm) intervals and at each exit and exit access doorway throughout the transport route. The signal shall be relayed to an approved central station, or remote supervising station service or constantly attended on-site location and shall also initiate a local audible alarm.

**414.7.3 Supervision.** Emergency alarm systems shall be supervised by an approved central, proprietary or remote station service or shall initiate an audible and visual signal at a constantly attended on-site location.

## **SECTION BC 415** **GROUPS H-1, H-2, H-3, H-4 AND H-5**

**415.1 Scope.** The provisions of this section shall apply to the storage and use of hazardous materials in excess of the maximum allowable quantities per control area listed in Section 307.9. Buildings and structures with an occupancy in Group H shall also comply with the applicable provisions of Section 414 and the *New York City Fire Code*, including, but not limited to, location and installation provisions.

**415.2 Definitions.** The following words and terms shall, for the purposes of this chapter and as used elsewhere in the code, have the meanings shown herein.

**CONTINUOUS GAS-DETECTION SYSTEM.** A gas detection system where the analytical instrument is maintained in continuous operation and sampling is performed without interruption. Analysis is allowed to be performed on a cyclical basis at intervals not to exceed 30 minutes.

**EMERGENCY CONTROL STATION.** An approved location on the premises of a semiconductor fabrication facility staffed by trained personnel that monitor the operation of equipment and systems including alert and alarm signals.

**EXHAUSTED ENCLOSURE.** A device, typically consisting of a hood equipped with a fan, that serves to capture and exhaust fumes, mist, vapors and gases generated at a workstation or other local environment. An exhausted enclosure does not include a room provided with general ventilation.

**FABRICATION AREA.** An area within a semiconductor fabrication facility in which processes using hazardous production materials are conducted.

**FLAMMABLE VAPORS OR FUMES.** The concentration of flammable constituents in air that exceed 25 percent of their lower flammable limit (LFL).

**GAS CABINET.** A fully enclosed, noncombustible enclosure used to provide an isolated environment for compressed gas containers in storage or use, including any doors and access ports for exchanging containers and accessing pressure-regulating controls.

**GAS ROOM.** A separately ventilated, fully enclosed room in which only compressed gases and associated equipment and supplies are stored or used.

**HAZARDOUS PRODUCTION MATERIAL (HPM).** A solid, liquid or gas associated with semiconductor manufacturing that has a degree-of-hazard rating in health, flammability or reactivity of Class 3 or 4 as ranked by NFPA 704 and that is used directly in research, laboratory or production processes that have as their end product materials that are not hazardous.

**HPM FLAMMABLE LIQUID.** An HPM liquid that is defined as either a Class I flammable liquid or a Class II or Class IIIA combustible liquid.

**HPM ROOM.** A room used in conjunction with or serving a Group H-5 occupancy, where HPM is stored or used and that is classified as a Group H-2, H-3 or H-4 occupancy.

**IMMEDIATELY DANGEROUS TO LIFE AND HEALTH (IDLH).** The concentration of air-borne contaminants that poses a threat of death, immediate or delayed permanent adverse health effects, or effects that could prevent escape from such an environment as established by the National Institute of Occupational Safety and Health (NIOSH) based on both toxicity and flammability. It generally is expressed in parts per million by volume (ppm v/v) or milligrams per cubic meter ( $\text{mg}/\text{m}^3$ ). If adequate data do not exist for precise establishment of IDLH concentrations, an independent certified industrial hygienist, industrial toxicologist, appropriate regulatory agency or other source approved by the Fire Commissioner shall make such determination.

**LIQUID.** A material that has a melting point that is equal to or less than 68°F (20°C) and a boiling point that is greater than 68°F (20°C) at 14.7 pounds per square inch absolute (psia) (101 kPa). When not otherwise identified, the term “liquid” includes both flammable and combustible liquids.

**LIQUID STORAGE ROOM.** A room classified as a Group H-3 occupancy used for the storage of flammable or combustible liquids in an unopened condition.

**LIQUID USE, DISPENSING AND MIXING ROOMS.** Rooms in which Class I, II and IIIA flammable or combustible liquids are used, dispensed or mixed in open containers.

**LOWER FLAMMABLE LIMIT (LFL).** The minimum concentration of vapor in air at which propagation of flame will occur in the presence of an ignition source. The LFL is sometimes referred to as “LEL” or “lower explosive limit.”

**NORMAL TEMPERATURE AND PRESSURE (NTP).** A temperature of 70°F (21°C) and a pressure of 1 atmosphere [14.7 psia (101 kPa)].

**SERVICECORRIDOR.** A fully enclosed passage used for transporting HPM and other purposes, but not as a required means of egress.

**SOLID.** A material that has a melting point, decomposes or sublimates at a temperature greater than 68°F (20°C).

**WORKSTATION.** A defined space within a fabrication area in which a specific function, laboratory procedure or research activity relating to semiconductor manufacture is conducted. A workstation may include equipment using HPM, hazardous materials storage cabinets, flammable liquid storage cabinets or gas cabinets, ventilation equipment, fire protection devices, detection devices, and electrical devices.

**415.3 Location on property.** Group H shall be located on property in accordance with the other provisions of this chapter. In Group H-2 or H-3, not less than 25 percent of the perimeter wall of the occupancy shall be an exterior wall.

**Exceptions:**

1. Liquid use, dispensing and mixing rooms having a floor area of not more than 500 square feet (47 m<sup>2</sup>) need not be located on the outer perimeter of the building where they are in accordance with the *New York City Fire Code* and NFPA 30.
2. Liquid storage rooms having a floor area of not more than 1,000 square feet (93 m<sup>2</sup>) need not be located on the outer perimeter where they are in accordance with the *New York City Fire Code* and NFPA 30.
3. Spray paint booths that comply with the *New York City Fire Code* need not be located on the outer perimeter.

**415.3.1 Group H minimum distance to lot lines.** Regardless of any other provisions, buildings containing Group H occupancies shall be set back a minimum distance from lot lines as set forth in Items 1 through 4 below. Distances shall be measured from the walls enclosing the occupancy to lot lines, including those on a public way. Distances to assumed

property lines drawn for the purposes of determination of exterior wall and opening protection are not to be used to establish the minimum distance for separation of buildings on sites where explosives are manufactured or used when separation is provided in accordance with the quantity distance tables specified for explosive materials in the *New York City Fire Code*.

1. Group H-1. Not less than 75 feet (22 860 mm) and not less than required by the *New York City Fire Code*.

**Exceptions:**

1. Fireworks manufacturing buildings separated in accordance with NFPA 1124.
2. Buildings containing the following materials when separated in accordance with Table 415.3.1:
  - 2.1. Organic peroxides, unclassified detonable.
  - 2.2. Unstable reactive materials Class 4.
  - 2.3. Unstable reactive materials, Class 3 detonable.
  - 2.4. Detonable pyrophoric materials.
2. Group H-2. Not less than 30 feet (9144 mm) where the area of the occupancy exceeds 1,000 square feet (93 m<sup>2</sup>), and it is not required to be located in a detached building.
3. Groups H-2 and H-3. Not less than 50 feet (15 240 mm) where a detached building is required (see Table 415.3.2).
4. Groups H-2 and H-3. Occupancies containing materials with explosive characteristics shall be separated as required by the *New York City Fire Code*. Where separations are not specified, the distances required shall not be less than the distances required by Table 415.3.1.

**TABLE 415.3.1**  
**MINIMUM SEPARATION DISTANCES FOR BUILDINGS CONTAINING EXPLOSIVE**  
**MATERIALS**

**(Table 415.3.1 attached to end of document.)**

**415.3.2 Group H-1 and H-2 or H-3 detached buildings.** Where a detached building is required by Table 415.3.2, there are no requirements for wall and opening protection based on location on property.

**TABLE 415.3.2**  
**REQUIRED DETACHED STORAGE**



(Table 415.3.2 attached to end of document.)

415.4 Special provisions for Group H-1 occupancies. Group H-1 occupancies shall be in buildings used for no other purpose, shall not exceed one story in height and be without basement, crawl spaces or other under-floor spaces. Roofs shall be of lightweight construction with suitable thermal insulation to prevent sensitive material from reaching its decomposition temperature. Group H-1 occupancies containing materials that are in themselves both physical and health hazards in quantities exceeding the maximum allowable quantities per control area in Table 307.7(2) shall comply with requirements for both Group H-1 and H-4 occupancies.

415.4.1 Floors in storage rooms. Floors in storage areas for organic peroxides, pyrophoric materials and unstable (reactive) materials shall be of liquid-tight, noncombustible construction.

415.5 Special provisions for Group H-2 and H-3 occupancies. Group H-2 and H-3 occupancies containing quantities of hazardous materials in excess of those set forth in Table 415.3.2 shall be in buildings used for no other purpose, shall not exceed one story in height and shall be without basements, crawl spaces or other under-floor spaces. Group H-2 and H-3 occupancies containing water-reactive materials shall be resistant to water penetration. Piping for conveying liquids shall not be over or through areas containing water reactives, unless isolated by approved liquid-tight construction.

Exception: Fire protection piping.

415.5.1 Floors in storage rooms. Floors in storage areas for organic peroxides, oxidizers, pyrophoric materials, unstable (reactive) materials and water-reactive solids and liquids shall be of liquid-tight, noncombustible construction.

415.5.2 Waterproof room. Rooms or areas used for the storage of water-reactive solids and liquids shall be constructed in a manner that resists the penetration of water through the use of waterproof materials. Piping carrying water for other than approved automatic fire sprinkler systems shall not be within such rooms or areas.

415.6 Smoke and heat venting. Smoke and heat vents complying with Section 910 shall be installed in the following locations:

1. In occupancies classified as Group H-2 or H-3, any of which are over 15,000 square feet (1394 m<sup>2</sup>) in a single floor area.

Exception: Buildings of noncombustible construction containing only noncombustible materials.

2. In areas of buildings in Group H used for storing Class 2, 3 and 4 liquid and solid oxidizers, Class 1 and unclassified detonable organic peroxides, unstable (reactive) materials, or Class 2 or 3 water-reactive materials as required for a high hazard commodity classification as defined in the *New York City Fire Code*.

**415.7 Group H-2.** Occupancies in Group H-2 shall be constructed in accordance with Sections 415.7.1 through 415.7.4 and the *New York City Fire Code*.

**415.7.1 Combustible dusts, grain processing and storage.** The provisions of Sections 415.7.1.1 through 415.7.1.5 shall apply to buildings in which materials that produce combustible dusts are stored or handled. Buildings that store or handle combustible dusts shall comply with the applicable provisions of NFPA 61, NFPA 69, NFPA 120, NFPA 484, NFPA 651, NFPA 654, NFPA 655, NFPA 664 and NFPA 85, and the *New York City Fire Code*.

**415.7.1.1 Type of construction and height exceptions.** Buildings shall be constructed in compliance with the height and area limitations of Table 503 for Group H-2; except that where erected of Type I or II construction, the heights and areas of grain elevators and similar structures shall be unlimited, and where of Type IV construction, the maximum height shall be 65 feet (19 812 mm) and except further that, in isolated areas, the maximum height of Type IV structures shall be increased to 85 feet (25 908 mm).

**415.7.1.2 Grinding rooms.** Every room or space occupied for grinding or other operations that produce combustible dusts shall be enclosed with fire barriers and horizontal assemblies or both that have not less than a 2-hour fire-resistance rating where the area is not more than 3,000 square feet (279 m<sup>2</sup>), and not less than a 4-hour fire-resistance rating where the area is greater than 3,000 square feet (279 m<sup>2</sup>).

**415.7.1.3 Conveyors.** Conveyors, chutes, piping and similar equipment passing through the enclosures of rooms or spaces shall be constructed dirt tight and vapor tight, and be of approved noncombustible materials complying with Chapter 30.

**415.7.1.4 Explosion control.** Explosion control shall be provided as specified in the *New York City Fire Code*, or spaces shall be equipped with the equivalent mechanical ventilation complying with the *New York City Mechanical Code*.

**415.7.1.5 Grain elevators.** Grain elevators, malt houses and buildings for similar occupancies shall not be located within 30 feet (9144 mm) of interior lot lines or structures on the same lot, except where erected along a railroad right-of-way.

**415.7.1.6 Coal pockets.** Coal pockets located less than 30 feet (9144 mm) from interior lot lines or from structures on the same lot shall be constructed of not less than Type IB construction. Where more than 30 feet (9144 mm) from interior lot lines, or where erected along a railroad right-of-way, the minimum type of construction of such structures not more than 65 feet (19 812 mm) in height shall be Type IV.

**415.7.2 Flammable and combustible liquids.** The storage, handling, processing and transporting of flammable and combustible liquids shall be in accordance with this section, the *New York City Mechanical Code* and the *New York City Fire Code*.

**415.7.2.1 Mixed occupancies.** Where the storage tank area is located in a building of two or more occupancies, and the quantity of liquid exceeds the maximum allowable quantity for one control area, the use shall be completely separated from adjacent fire areas in accordance with the requirements of Section 302.3.2.

**415.7.2.1.1 Height exception.** Where storage tanks are located within only a single-story building, the height limitation of Section 503 shall not apply for Group H.

**415.7.2.2 Tank protection.** Storage tanks shall be noncombustible and protected from physical damage. A fire barrier wall or horizontal assemblies or both around the storage tank(s) shall be permitted as the method of protection from physical damage.

**415.7.2.3 Tanks.** Storage tanks shall be approved tanks conforming to the requirements of the *New York City Fire Code*.

**415.7.2.4 Suppression.** Group H shall be equipped throughout with an approved automatic sprinkler system, installed in accordance with Section 903.

**415.7.2.5 Leakage containment.** A liquid-tight containment area compatible with the stored liquid shall be provided. The method of spill control, drainage control and secondary containment shall be in accordance with the *New York City Fire Code*.

**Exception:** Rooms where only double-wall storage tanks conforming to Section 415.7.2.3 are used to store Class I, II and IIIA flammable and combustible liquids shall not be required to have a leakage containment area.

**415.7.2.6 Leakage alarm.** An approved automatic alarm shall be provided to indicate a leak in a storage tank and room. The alarm shall sound an audible signal, 15 dBa above the ambient sound level, at every point of entry into the room in which the leaking storage tank is located. An approved sign shall be posted on every entry door to the tank storage room indicating the potential hazard of the interior room environment, or the sign shall state: WARNING, WHEN ALARM SOUNDS, THE ENVIRONMENT WITHIN THE ROOM MAY BE HAZARDOUS. The leakage alarm shall also be supervised in accordance with Chapter 9 to transmit a trouble signal.

**415.7.2.7 Tank vent.** Storage tank vents for Class I, II or IIIA liquids shall terminate to the outdoor air in accordance with the *New York City Fire Code*.

**415.7.2.8 Room ventilation.** Storage tank areas storing Class I, II or IIIA liquids shall be provided with mechanical ventilation. The mechanical ventilation system shall be in accordance with the *New York City Mechanical Code* and the *New York City Fire Code*.

**415.7.2.9 Explosion venting.** Where Class I liquids are being stored, explosion venting shall be provided in accordance with the *New York City Fire Code*.

**415.7.2.10 Tank openings other than vents.** Tank openings other than vents from tanks inside buildings shall be designed to ensure that liquids or vapor concentrations are not released inside the building.

**415.7.3 Liquefied petroleum gas-distribution facilities.** Propane, butane, propylene, butylene and other liquefied petroleum gas-distribution facilities shall conform to the provisions of the *New York City Fire Code*.

**415.7.4 Dry cleaning plants.** The construction and installation of dry cleaning plants shall be in accordance with the requirements of this code, the *New York City Mechanical Code*, the *New York City Plumbing Code* and NFPA 32. Dry cleaning solvents and systems shall be classified in accordance with the *New York City Fire Code*.

**415.8 Groups H-3 and H-4.** Groups H-3 and H-4 shall be constructed in accordance with the applicable provisions of this code and the *New York City Fire Code*.

**415.8.1 Gas rooms.** When gas rooms are provided, such rooms shall be separated from other areas by not less than a 1-hour fire barrier.

**415.8.2 Floors in storage rooms.** Floors in storage areas for corrosive liquids and highly toxic or toxic materials shall be of liquid-tight, noncombustible construction.

**415.8.3 Separation—highly toxic solids and liquids.** Highly toxic solids and liquids not stored in approved hazardous materials storage cabinets shall be isolated from other hazardous materials storage by construction having a 1-hour fire-resistance rating.

## **415.9 Group H-5.**

**415.9.1 General.** In addition to the requirements set forth elsewhere in this code, Group H-5 shall comply with the provisions of Section 415.9 and the *New York City Fire Code*, including, but not limited to, automatic sprinkler protection for workstations, gas cabinets, exhausted enclosures, pass-throughs in exit access corridors, and exhaust ducts.

### **415.9.2 Fabrication areas.**

#### **415.9.2.1 Hazardous materials in fabrication areas.**

**415.9.2.1.1 Aggregate quantities.** The aggregate quantities of hazardous materials stored and used in a single fabrication area shall not exceed the quantities set forth in Table 415.9.2.1.1.

**Exception:** The quantity limitations for any hazard category in Table 415.9.2.1.1 shall not apply where the fabrication area contains quantities of hazardous materials not exceeding the maximum allowable quantities per control area established by Tables 307.7(1) and 307.7(2).

**TABLE 415.9.2.1.1**  
**QUANTITY LIMITS FOR HAZARDOUS MATERIALS IN A SINGLE**  
**FABRICATION AREA IN GROUP H-5<sup>a</sup>**  
**(Table 415.9.2.1.1 attached to end of document)**

**415.9.2.1.2 Hazardous production materials.** The maximum quantities of hazardous production materials stored in a single fabrication area shall not exceed the maximum allowable quantities per control area established by Tables 307.7(1) and 307.7(2).

**415.9.2.2 Separation.** Fabrication areas, whose sizes are limited by the quantity of hazardous materials allowed by Table 415.9.2.1.1, shall be separated from each other, from exit access corridors, and from other parts of the building by not less than 1-hour fire barriers.

**Exceptions:**

1. Doors within such fire barrier walls, including doors to corridors, shall be only self-closing fire assemblies having a fire-protection rating of not less than  $\frac{3}{4}$  hour.
2. Windows between fabrication areas and exit access corridors are permitted to be fixed glazing listed and labeled for a fire protection rating of at least  $\frac{3}{4}$  hour in accordance with Section 715.

**415.9.2.3 Location of occupied levels.** Occupied levels of fabrication areas shall be located at or above the first story above grade plane.

**415.9.2.4 Floors.** Except for surfacing, floors within fabrication areas shall be of noncombustible construction. Openings through floors of fabrication areas are permitted to be unprotected where the interconnected levels are used solely for mechanical equipment directly related to such fabrication areas (see also Section 415.9.2.5). Floors forming a part of an occupancy separation shall be liquid tight.

**415.9.2.5 Shafts and openings through floors.** Elevator shafts, vent shafts and other openings through floors shall be enclosed when required by Section 707. Mechanical, duct and piping penetrations within a fabrication area shall not extend through more than two floors. The annular space around penetrations for cables, cable trays, tubing, piping, conduit or ducts shall be sealed at the floor level to restrict the movement of air. The fabrication area, including the areas through which the ductwork and piping extend, shall be considered a single conditioned environment.

**415.9.2.6 Ventilation.** Mechanical exhaust ventilation shall be provided throughout the fabrication area at the rate of not less than 1 cubic foot per minute per square foot ( $0.044 \text{ L/S/m}^2$ ) of floor area. The exhaust air duct system of one fabrication area shall not connect to another duct system outside that fabrication area within the building.

A ventilation system shall be provided to capture and exhaust fumes and vapors at workstations.

Two or more operations at a workstation shall not be connected to the same exhaust system where either one or the combination of the substances removed could constitute a fire, explosion or hazardous chemical reaction within the exhaust duct system.

Exhaust ducts penetrating occupancy separations shall be contained in a shaft of equivalent fire-resistance construction. Exhaust ducts shall not penetrate firewalls.

Fire dampers shall not be installed in exhaust ducts.

#### **415.9.2.7 Transporting hazardous production materials to fabrication areas.**

Hazardous production materials shall be transported to fabrication areas through enclosed piping or tubing systems that comply with Section 415.9.6.1, through service corridors complying with Section 415.9.4, or in exit access corridors as permitted in the exception to Section 415.9.3. The handling or transporting of hazardous production materials within service corridors shall comply with the *New York City Fire Code*.

#### **415.9.2.8 Electrical.**

**415.9.2.8.1 General.** Electrical equipment and devices within the fabrication area shall comply with the *New York City Electrical Code*. The requirements for hazardous locations need not be applied where the average air change is at least four times that set forth in Section 415.9.2.6 and where the number of air changes at any location is not less than three times that required by Section 415.9.2.6. The use of recirculated air shall be permitted.

**415.9.2.8.2 Workstations.** Workstations shall not be energized without adequate exhaust ventilation. See Section 415.9.2.6 for workstation exhaust ventilation requirements.

**415.9.3 Exit access corridors.** Exit access corridors shall comply with Chapter 10 and shall be separated from fabrication areas as specified in Section 415.9.2.2. Exit access corridors shall not contain HPM and shall not be used for transporting such materials, except through closed piping systems as provided in Section 415.9.6.3.

**Exception:** Where existing fabrication areas are altered or modified, HPM is allowed to be transported in existing exit access corridors, subject to the following conditions:

1. Corridors. Exit access corridors adjacent to the fabrication area where the alteration work is to be done shall comply with Section 1016 for a length determined as follows:

1.1. The length of the common wall of the corridor and the fabrication area; and

- 1.2. For the distance along the exit access corridor to the point of entry of HPM into the exit access corridor serving that fabrication area.
2. Emergency alarm system. There shall be an emergency telephone system, a local manual alarm station or other approved alarm-initiating device within exit access corridors at not more than 150-foot (45 720 mm) intervals and at each exit and exit access doorway. The signal shall be relayed to an approved central, proprietary or remote station service or the emergency control station and shall also initiate a local audible alarm.
3. Pass-throughs. Self-closing doors having a fire-protection rating of not less than 1 hour shall separate pass-throughs from existing exit access corridors. Pass-throughs shall be constructed as required for the exit access corridors, and protected by an approved automatic fire-extinguishing system.

#### **415.9.4 Service corridors.**

**415.9.4.1 Occupancy.** Service corridors shall be classified as Group H-5.

**415.9.4.2 Use conditions.** Service corridors shall be separated from exit access corridors as required by Section 415.9.2.2. Service corridors shall not be used as a required exit access corridor.

**415.9.4.3 Mechanical ventilation.** Service corridors shall be mechanically ventilated as required by Section 415.9.2.6 or at not less than six air changes per hour, whichever is greater.

**415.9.4.4 Means of egress.** The maximum distance of travel from any point in a service corridor to an exit, exit access corridor or door into a fabrication area shall not exceed 75 feet (22 860 mm). Dead ends shall not exceed 4 feet (1219 mm) in length. There shall be not less than two exits, and not more than one-half of the required means of egress shall require travel into a fabrication area. Doors from service corridors shall swing in the direction of egress travel and shall be self-closing.

**415.9.4.5 Minimum width.** The minimum clear width of a service corridor shall be 5 feet (1524 mm), or 33 inches (838 mm) wider than the widest cart or truck used in the service corridor, whichever is greater.

**415.9.4.6 Emergency alarm system.** Emergency alarm systems shall be provided in accordance with this section and Sections 414.7.1 and 414.7.2. The maximum allowable quantity per control area provisions shall not apply to emergency alarm systems required for HPM.

**415.9.4.6.1 Service corridors.** An emergency alarm system shall be provided in service corridors, with at least one alarm device in each service corridor.

**415.9.4.6.2 Exit access corridors and exit enclosures.** Emergency alarms for exit access corridors and exit enclosures shall comply with Section 414.7.2.

**415.9.4.6.3 Liquid storage rooms, HPM rooms and gas rooms.** Emergency alarms for liquid storage rooms, HPM rooms and gas rooms shall comply with Section 414.7.1.

**415.9.4.6.4 Alarm-initiating devices.** An approved emergency telephone system, local alarm manual pull stations, or other approved alarm-initiating devices are allowed to be used as emergency alarm-initiating devices.

**415.9.4.6.5 Alarm signals.** Activation of the emergency alarm system shall sound a local alarm and transmit a signal to the emergency control station.

#### **415.9.5 Storage of hazardous production materials.**

**415.9.5.1 General.** Storage of HPM in fabrication areas shall be within approved or listed storage cabinets or gas cabinets, or within a workstation. The storage of hazardous production materials in quantities greater than those listed in Tables 307.7(1) or 307.7(2) shall be in liquid storage rooms, HPM rooms or gas rooms as appropriate for the materials stored. The storage of other hazardous materials shall be in accordance with other applicable provisions of this code and the *New York City Fire Code*.

#### **415.9.5.2 Construction.**

**415.9.5.2.1 HPM rooms and gas rooms.** HPM rooms and gas rooms shall be separated from other areas by not less than a 2-hour fire barrier where the area is 300 square feet (27.9 m<sup>2</sup>) or more and not less than a 1-hour fire barrier where the area is less than 300 square feet (27.9 m<sup>2</sup>).

**415.9.5.2.2 Liquid storage rooms.** Liquid storage rooms shall be constructed in accordance with the following requirements:

- 1. Rooms in excess of 500 square feet (46.5 m<sup>2</sup>) shall have at least one exterior door approved for Fire Department access.**
- 2. Rooms shall be separated from other areas by fire barriers having a fire-resistance rating of not less than 1-hour for rooms up to 150 square feet (13.9 m<sup>2</sup>) in area and not less than 2 hours where the room is more than 150 square feet (13.9 m<sup>2</sup>) in area.**
- 3. Shelving, racks and wainscoting in such areas shall be of noncombustible construction or wood of not less than 1-inch (25 mm) nominal thickness.**



4. Rooms used for the storage of Class I flammable liquids shall not be located in a basement.

**415.9.5.2.3 Floors.** Except for surfacing, floors of HPM rooms and liquid storage rooms shall be of noncombustible liquid-tight construction. Raised grating over floors shall be of noncombustible materials.

**415.9.5.3 Location.** Where HPM rooms, liquid storage rooms and gas rooms are provided, they shall have at least one exterior wall and such wall shall be not less than 30 feet (9144 mm) from property lines, including property lines adjacent to public ways.

**415.9.5.4 Explosion control.** Explosion control shall be provided where required by Section 414.5.1.

**415.9.5.5 Exits.** Where two exits are required from HPM rooms, liquid storage rooms and gas rooms, one shall be directly to the outside of the building.

**415.9.5.6 Doors.** Doors in a fire barrier wall, including doors to corridors, shall be self-closing fire assemblies having a fire-protection rating of not less than  $\frac{3}{4}$  hour.

**415.9.5.7 Ventilation.** Mechanical exhaust ventilation shall be provided in liquid storage rooms, HPM rooms and gas rooms at the rate of not less than 1 cubic foot per minute per square foot ( $0.044 \text{ L/S/m}^2$ ) of floor area or six air changes per hour, whichever is greater, for categories of material.

Exhaust ventilation for gas rooms shall be designed to operate at a negative pressure in relation to the surrounding areas and direct the exhaust ventilation to an exhaust system.

**415.9.5.8 Emergency alarm system.** An approved emergency alarm system shall be provided for HPM rooms, liquid storage rooms and gas rooms.

Emergency alarm-initiating devices shall be installed outside of each interior exit door of such rooms.

Activation of an emergency alarm-initiating device shall sound a local alarm and transmit a signal to the emergency control station.

An approved emergency telephone system, local alarm manual pull stations or other approved alarm-initiating devices are allowed to be used as emergency alarm-initiating devices.

#### **415.9.6 Piping and tubing.**

**415.9.6.1 General.** Hazardous production materials piping and tubing shall comply with this section and ANSI B31.3.

#### **415.9.6.2 Supply piping and tubing.**

**415.9.6.2.1 HPM having a health-hazard ranking of 3 or 4.** Systems supplying HPM liquids or gases having a health-hazard ranking of 3 or 4 shall be welded throughout, except for connections, to the systems that are within a ventilated enclosure if the material is a gas, or an approved method of drainage or containment is provided for the connections if the material is a liquid.

**415.9.6.2.2 Location in service corridors.** Hazardous production materials supply piping or tubing in service corridors shall be exposed to view.

**415.9.6.2.3 Excess flow control.** Where HPM gases or liquids are carried in pressurized piping above 15 pounds per square inch gauge (psig) (103.4 kPa), excess flow control shall be provided. Where the piping originates from within a liquid storage room, HPM room or gas room, the excess flow control shall be located within the liquid storage room, HPM room or gas room. Where the piping originates from a bulk source, the excess flow control shall be located as close to the bulk source as practical.

**415.9.6.3 Installations in exit access corridors and above other occupancies.** The installation of hazardous production material piping and tubing within the space defined by the walls of exit access corridors and the floor or roof above or in concealed spaces above other occupancies shall be in accordance with Section 415.9.6.2 and the following conditions:

1. Automatic sprinklers shall be installed within the space unless the space is less than 6 inches (152 mm) in the least dimension.
2. Ventilation not less than six air changes per hour shall be provided. The space shall not be used to convey air from any other area.
3. Where the piping or tubing is used to transport HPM liquids, a receptor shall be installed below such piping or tubing. The receptor shall be designed to collect any discharge or leakage and drain it to an approved location. The 1-hour enclosure shall not be used as part of the receptor.
4. HPM supply piping and tubing and HPM nonmetallic waste lines shall be separated from the exit access corridor and from occupancies other than Group H-5 by construction as required for walls or partitions that have a fire protection rating of not less than 1 hour. Where gypsum wallboard is used, joints on the piping side of the enclosure are not required to be taped, provided the joints occur over framing members. Access openings into the enclosure shall be protected by approved fire-resistance-rated assemblies.

5. Readily accessible manual or automatic remotely activated fail-safe emergency shutoff valves shall be installed on piping and tubing other than waste lines at the following locations:

5.1. At branch connections into the fabrication area.

5.2. At entries into exit access corridors.

**Exception:** Transverse crossings of the corridors by supply piping that is enclosed within a ferrous pipe or tube for the width of corridor need not comply with Items 1 through 5.

**415.9.6.4 Identification.** Piping, tubing and HPM waste lines shall be identified in accordance with ANSI A13.1 to indicate the material being transported.

**415.9.7 Continuous gas-detection systems.** A continuous gas-detection system shall be provided for HPM gases when the physiological warning properties of the gas are at a higher level than the accepted permissible exposure limit (PEL) for the gas and for flammable gases in accordance with this section.

**415.9.7.1 Where required.** A continuous gas-detection system shall be provided in the areas identified in Sections 415.9.7.1.1 through 415.9.7.1.4.

**415.9.7.1.1 Fabrication areas.** A continuous gas-detection system shall be provided in fabrication areas when gas is used in the fabrication area.

**415.9.7.1.2 HPM rooms.** A continuous gas-detection system shall be provided in HPM rooms when gas is used in the room.

**415.9.7.1.3 Gas cabinets, exhausted enclosures and gas rooms.** A continuous gas-detection system shall be provided in gas cabinets and exhausted enclosures. A continuous gas-detection system shall be provided in gas rooms when gases are not located in gas cabinets or exhausted enclosures.

**415.9.7.1.4 Exit access corridors.** When gases are transported in piping placed within the space defined by the walls of an exit access corridor, and the floor or roof above the exit access corridor, a continuous gas-detection system shall be provided where piping is located and in the exit access corridor.

**Exception:** A continuous gas-detection system is not required for occasional transverse crossings of the corridors by supply piping that is enclosed in a ferrous pipe or tube for the width of the corridor.

**415.9.7.2 Gas-detection system operation.** The continuous gas-detection system shall be capable of monitoring the room, area or equipment in which the gas is located at or below the PEL or ceiling limit of the gas for which detection is provided. For flammable

gases, the monitoring detection threshold level shall be vapor concentrations in excess of 20 percent of the lower explosive limit (LFL). Monitoring for highly toxic and toxic gases shall also comply with the requirements for such material in the *New York City Fire Code*.

**415.9.7.2.1 Alarms.** The gas detection system shall initiate a local alarm and transmit a signal to the emergency control station when a short-term hazard condition is detected. The alarm shall be both visual and audible and shall provide warning both inside and outside the area where the gas is detected.

**415.9.7.2.2 Shutoff of gas supply.** The gas detection system shall automatically close the shutoff valve at the source on gas supply piping and tubing related to the system being monitored for which gas is detected when a short-term hazard condition is detected. Automatic closure of shutoff valves shall comply with the following:

1. Where the gas-detection sampling point initiating the gas detection system alarm is within a gas cabinet or exhausted enclosure, the shutoff valve in the gas cabinet or exhausted enclosure for the specific gas detected shall automatically close.
2. Where the gas-detection sampling point initiating the gas detection system alarm is within a room and compressed gas containers are not in gas cabinets or an exhausted enclosure, the shutoff valves on all gas lines for the specific gas detected shall automatically close.
3. Where the gas-detection sampling point initiating the gas detection system alarm is within a piping distribution manifold enclosure, the shutoff valve supplying the manifold for the compressed gas container of the specific gas detected shall automatically close.

**Exception:** Where the gas-detection sampling point initiating the gas detection system alarm is at the use location or within a gas valve enclosure of a branch line downstream of a piping distribution manifold, the shutoff valve for the branch line located in the piping distribution manifold enclosure shall automatically close.

**415.9.8 Manual fire alarm system.** An approved manual fire alarm system shall be provided throughout buildings containing Group H-5. Activation of the alarm system shall initiate a local alarm and transmit a signal to the emergency control station. The fire alarm system shall be designed and installed in accordance with Section 907.

**415.9.9 Emergency control station.** An emergency control station shall be provided on the premises at an approved location, outside of the fabrication area and shall be continuously staffed by trained personnel. The emergency control station shall receive signals from emergency equipment and alarm and detection systems. Such emergency equipment and alarm and detection systems shall include, but not necessarily be limited to, the following

where such equipment or systems are required to be provided either in Section 415.9 or elsewhere in this code:

1. Automatic fire sprinkler system alarm and monitoring systems.
2. Manual fire alarm systems.
3. Emergency alarm systems.
4. Continuous gas-detection systems.
5. Smoke detection systems.
6. Emergency power system.

**415.9.10 Emergency power system.** An emergency power system shall be provided in Group H-5 occupancies where required in Section 415.9.10.1. The emergency power system shall be designed to supply power automatically to required electrical systems when the normal electrical supply system is interrupted.

**415.9.10.1 Where required.** Emergency power shall be provided for electrically operated equipment and connected control circuits for the following systems:

1. HPM exhaust ventilation systems.
2. HPM gas cabinet ventilation systems.
3. HPM exhausted enclosure ventilation systems.
4. HPM gas room ventilation systems.
5. HPM gas detection systems.
6. Emergency alarm systems.
7. Manual fire alarm systems.
8. Automatic sprinkler system monitoring and alarm systems.
9. Electrically operated systems required elsewhere in this code applicable to the use, storage or handling of HPM.

**415.9.10.2 Exhaust ventilation systems.** Exhaust ventilation systems are allowed to be designed to operate at not less than one-half the normal fan speed on the emergency power system where it is demonstrated that the level of exhaust will maintain a safe atmosphere.

#### **415.9.11 Fire sprinkler system protection in exhaust ducts for HPM.**

**415.9.11.1 General.** Automatic fire sprinkler system protection shall be provided in exhaust ducts conveying vapors, fumes, mists or dusts generated from HPM in accordance with this section and the *New York City Mechanical Code*.

**415.9.11.2 Metallic and noncombustible, nonmetallic exhaust ducts.** Automatic fire sprinkler system protection shall be provided in metallic and noncombustible, nonmetallic exhaust ducts where all of the following conditions apply:

1. Where the largest cross-sectional diameter is equal to or greater than 10 inches (254 mm).
2. The ducts are within the building.
3. The ducts are conveying flammable vapors or fumes.

**415.9.11.3 Combustible nonmetallic exhaust ducts.** Automatic fire sprinkler system protection shall be provided in combustible nonmetallic exhaust ducts where the largest cross-sectional diameter of the duct is equal to or greater than 10 inches (254 mm).

#### **Exceptions:**

1. Ducts listed or approved for applications without automatic fire sprinkler system protection.
2. Ducts not more than 12 feet (3658 mm) in length installed below ceiling level.

**415.9.11.4 Automatic sprinkler locations.** Sprinkler systems shall be installed at 12-foot (3658 mm) intervals in horizontal ducts and at changes in direction. In vertical ducts, sprinklers shall be installed at the top and at alternate floor levels.

### **SECTION BC 416** **APPLICATION OF FLAMMABLE FINISHES**

**416.1 General.** The provisions of this section shall apply to the construction, installation and use of buildings and structures, or parts thereof, for the spraying of flammable paints, varnishes and lacquers or other flammable materials or mixtures or compounds used for painting, varnishing, staining or similar purposes. Such construction and equipment shall comply with the *New York City Fire Code*.

**416.2 Spray rooms.** Spray rooms shall be enclosed with fire barrier walls and horizontal assemblies or both with not less than a 2-hour fire-resistance rating. Floors shall be waterproofed and drained in an approved manner.

**416.2.1 Surfaces.** The interior surfaces of spray rooms shall be smooth and shall be so constructed to permit the free passage of exhaust air from all parts of the interior and to facilitate washing and cleaning, and shall be so designed to confine residues within the room. Aluminum shall not be used.

**416.3 Spraying spaces.** Spraying spaces shall be ventilated with an exhaust system capable of at least 6 air changes per hour to prevent the accumulation of flammable mist or vapors in accordance with the *New York City Mechanical Code*. Where such spaces are not separately enclosed, noncombustible spray curtains shall be provided to restrict the spread of flammable vapors.

**416.3.1 Surfaces.** The interior surfaces of spraying spaces shall be smooth and continuous without edges, and shall be so constructed to permit the free passage of exhaust air from all parts of the interior and to facilitate washing and cleaning, and shall be so designed to confine residues within the spraying space. Aluminum shall not be used.

**416.4 Fire protection.** An automatic fire-extinguishing system shall be provided in all spray, dip and immersing spaces and storage rooms, and shall be installed in accordance with Chapter 9.

## **SECTION BC 417** **DRYING ROOMS**

**417.1 General.** A drying room or dry kiln installed within a building shall be constructed entirely of approved noncombustible materials or assemblies of such materials regulated by the approved rules or as required in the general and specific sections of Chapter 4 for special occupancies, where applicable to the general requirements of Chapter 28, and in accordance with the *New York City Fire Code*.

**417.2 Piping clearance.** Overhead heating pipes shall have a clearance of not less than 2 inches (51 mm) from combustible contents in the dryer.

**417.3 Insulation.** Where the operating temperature of the dryer is 175°F (79°C) or more, metal enclosures shall be insulated from adjacent combustible materials by not less than 12 inches (305 mm) of airspace, or the metal walls shall be lined with ¼-inch (6.4 mm) insulating mill board or other approved equivalent insulation.

**417.4 Fire Protection.** Drying rooms designed for high-hazard materials and processes, including special occupancies as provided for in Chapter 4, shall be protected by an approved automatic sprinkler or fire-extinguishing system conforming to the provisions of Chapter 9.

## **SECTION BC 418** **ORGANIC COATINGS**

**418.1 Building features.** Manufacturing of organic coatings shall be done only in buildings that do not have pits or basements and shall comply with the *New York City Fire Code*. Such buildings shall be protected by an approved automatic sprinkler system in accordance with

Chapter 9.

**418.2 Location.** Organic coating manufacturing operations and operations incidental to or connected therewith shall not be located in buildings having other occupancies.

**418.3 Process mills.** Mills operating with close clearances and that process flammable and heat-sensitive materials, such as nitrocellulose, shall be classified as Group H1 occupancy.

**418.4 Tank storage.** Storage areas for flammable and combustible liquid tanks inside of structures shall be located at or above grade and shall be separated from the processing area by not less than 2-hour fire-resistance-rated fire barriers.

**418.5 Nitrocellulose storage.** Nitrocellulose storage shall be located on a detached pad or in a separate structure or a room enclosed with no less than 2-hour fire-resistance-rated fire barriers.

**418.6 Finished products.** Storage rooms for finished products that are flammable or combustible liquids shall be separated from the processing area by fire barriers having a fire-resistance rating of at least 2 hours, and openings in the walls shall be protected with approved opening protectives.

**SECTION BC 419**  
**NON-PRODUCTION CHEMICAL LABORATORIES**

**419.1 General.** The provisions of this section shall govern the design, construction and chemical quantity limitations of buildings and portions thereof occupied or designed to be occupied as a non-production laboratory. Non-production laboratories shall be classified into occupancy groups in accordance with Section 419.5. The provisions of this section shall not apply to production laboratories classified in occupancy groups F or H.

**419.2 Standards.** Except as otherwise provided in this section, non-production laboratories shall meet the design, construction and chemical quantity limitation requirements for laboratory unit fire hazard class D, as set forth in NFPA 45, and the *New York City Mechanical Code*. The storage arrangement, handling and use of chemicals within non-production laboratories and accessory storage rooms, and the operation and maintenance of non-production laboratories shall comply with the requirements of the *New York City Fire Code*, and the rules of the Fire Commissioner.

**419.3 Prohibitions.** It shall be unlawful in any non-production laboratory to:

1. Store or use any explosive.
2. Store or use any unclassified detonable organic peroxide, detonable pyrophoric material, detonable unstable (reactive) material or detonable water-reactive material.
3. Store or use any Class 4 unstable (reactive) material.



4. Store or use any Class 4 oxidizing material.

5. Store or use any flammable gas below-grade.

**419.4 Definitions.** The following words and terms shall, for the purposes of this section, and as used elsewhere in this code, have the meanings shown herein.

**LABORATORY BUILDING.** A structure consisting wholly or principally of one or more laboratory units.

**LABORATORY CHEMICAL.** A material with a health, flammability, or instability hazard rating of 2, 3, or 4 as defined in NFPA 704.

**LABORATORY, NON-PRODUCTION.** A building or portion thereof wherein chemicals or gases are used or synthesized on a non-production basis for testing, research, experimental, instructional or educational purposes.

**LABORATORY UNIT.** An enclosed space of a minimum 1-hour fire-rated construction, designed or used as a non-production laboratory. Laboratory units may include one or more separate laboratory work areas, and accessory storage rooms or spaces within or contiguous with the laboratory unit, such as offices and lavatories.

**STORAGE CABINET.** A cabinet designed and constructed in accordance with UL 1275, Flammable Liquid Storage Cabinets, and used for the storage of not more than 60 gallons (227 L) of flammable and combustible liquids.

**STORAGE ROOM.** A room where laboratory chemicals or gases are stored and not otherwise used or synthesized.

**419.5 Classification.** Buildings or portions thereof occupied as a non-production laboratory may be classified as Group B occupancy provided they comply with the provisions of Section 419. Non-production laboratories not in compliance with the provisions of Section 419.7 for laboratory chemical quantity limitations shall be classified as Group H occupancy.

**419.5.1 Accessory use non-production laboratories.** Accessory non-production laboratories occupying an area not more than 10 percent of the area of the story in which it is located and not exceeding the tabular values in Table 503 for the allowable height or area for such use shall be classified according to the main occupancy.

## **419.6 Fire protection.**

**419.6.1 Sprinkler system.** Laboratory units shall be provided throughout with an automatic sprinkler system in accordance with Section 903.3.1.1. The entire building shall be provided throughout with an automatic sprinkler system when the aggregate floor area of all laboratory units within any building exceeds 20,000 square feet (1858 m<sup>2</sup>).

**419.6.2 Standpipe and hose system.** In all non-production laboratory buildings that are two or more stories above or below the grade level (level of exit discharge), standpipes shall be installed in accordance with Section 905.2.

**419.6.3 Fire alarm system.** A manual fire alarm system shall be installed in accordance with Section 907.2.2, Section 907.2.3, or Section 907.2.6, as applicable.

## **419.7 Quantity limitations.**

**419.7.1 Flammable and combustible liquids.** The density and total quantity of flammable and combustible liquids allowed within a laboratory unit, outside of storage rooms, shall comply with Table 10.1.1 of NFPA 45 for laboratory unit fire hazard class D.

**Exceptions:** The following exceptions apply to other than educational or instructional laboratories:

1. The density of flammable and combustible liquids allowed within a laboratory unit may be increased to those set forth in Table 10.1.1 of NFPA 45 for laboratory unit fire hazard class B provided the total quantity of flammable and combustible liquid, including any in storage cabinets or safety cans, does not exceed 25 gallons (95 L).
2. The density of flammable and combustible liquids allowed within a laboratory unit may be increased to those set forth in Table 10.1.1 of NFPA 45 for laboratory unit fire hazard class B provided the total quantity of flammable and combustible liquid, including any in storage cabinets or safety cans, does not exceed 30 gallons (114 L) and the walls, floors and ceilings of the laboratory unit are separated from all adjoining areas by 2-hour fire rated construction.
3. Based on a density of 1 gallon per 100 square feet (3.785 L per 9.3 m<sup>2</sup>) of area, the quantity of flammable and combustible liquid allowed within a laboratory unit, excluding quantities in storage cabinets or safety cans, may be increased to 100 gallons (379 L), and the total quantities of flammable and combustible liquids, including quantities in storage cabinets or safety cans, may be increased to 200 gallons (775 L) provided the walls, floors and ceilings of the laboratory unit are separated from all adjoining areas by 2-hour fire rated construction.

**419.7.2 Flammable solids.** The total quantity of flammable solids allowed within a laboratory unit, excluding any quantities in a storage room, shall not exceed 10 pounds (4.5 kg).

**Exception:** The total quantity of flammable solids allowed within a laboratory unit that is provided with walls, floors and ceilings that separate the laboratory unit from all adjoining areas by 2-hour fire rated construction shall not exceed 15 pounds (6.8 kg).

**419.7.3 Oxidizers and organic peroxides.** The total quantity of solid and liquid oxidizers and organic peroxides combined allowed within a laboratory unit, excluding any quantities in a storage room, shall not exceed 40 pounds (18 kg), provided not more than 2 pounds (0.908 kg) of which are Class 3 oxidizers and 1 pound (0.454 kg) of which are Class I organic peroxides.

**Exception:** The total quantity of solid and liquid oxidizers and organic peroxides combined allowed within a laboratory unit that is provided with walls, floors and ceilings that separate the laboratory unit from all adjoining areas by 2-hour fire rated construction shall not exceed 50 pounds (23 kg), provided not more than 2 pounds (0.908 kg) of which are Class 3 oxidizers and 1 pound (0.454 kg) of which are Class I organic peroxides.

**419.7.4 Unstable (reactive).** The total quantity of unstable (reactive) material allowed within a laboratory unit, excluding any quantities in a storage room, shall not exceed 6 pounds (2.7 kg), provided not more than 1 pound (0.454 kg) of which are Class 3 unstable (reactive).

**Exception:** The total quantity of unstable (reactive) material allowed within a laboratory unit that is provided with walls, floors and ceilings that separate the laboratory unit from all adjoining areas by 2-hour fire rated construction shall not exceed 12 pounds (5.4 kg), provided not more than 1 pound (0.454 kg) of which are Class 3 unstable (reactive).

**419.7.5 Water reactive material.** The total quantity of water reactive material allowed within a laboratory unit, excluding any quantities in a storage room, shall not exceed 2.5 pounds (1.1 kg).

**Exception:** The total quantity of water reactive material allowed within a laboratory unit that is provided with walls, floors and ceilings that separate the laboratory unit from all adjoining areas by 2-hour fire rated construction shall not exceed 5 pounds (2.3 kg).

**419.7.6 Pyrophoric material.** The total quantity of solid or liquid pyrophoric material allowed within a laboratory unit, excluding any quantities in a storage room, shall not exceed 0.5 pounds (0.227 kg).

**Exception:** The total quantity of pyrophoric material allowed within a laboratory unit that is provided with walls, floors and ceilings that separate the laboratory unit from all adjoining areas by 2-hour fire rated construction shall not exceed 1 pound (0.454 kg).

**419.7.7 Highly toxic material.** The total quantity of solid or liquid highly toxic material allowed within a laboratory unit, excluding any quantities in a storage room, shall not exceed 5 pounds (0.227 kg).

**419.7.8 Toxic material.** The total quantity of solid or liquid toxic material allowed within a laboratory unit, excluding any quantities in a storage room, shall not exceed 250 pounds (946 L).

**419.7.9 Corrosive material.** The total quantity of solid or liquid corrosive material allowed within a laboratory unit, excluding any quantity in a storage room, shall not exceed 250 gallons (946 L).

**419.7.10 Highly toxic and toxic gases.** In educational and instructional laboratories, the total quantity of highly toxic and toxic gases combined allowed within a laboratory unit, excluding any quantities in a storage room, shall not exceed 20 standard cubic feet (0.56 standard cubic m).

**419.8 Storage room classification.** Storage rooms for laboratory chemicals accessory to a laboratory unit shall be classified as occupancy group S-1 provided they comply with the provisions of Section 419.9. Storage rooms not in compliance with the provisions of Section 419.9 for laboratory chemical quantity limitations shall be classified as Group H occupancy.

**419.9 Storage rooms.** In addition to the quantities allowed within a laboratory unit by Section 419.7, laboratory chemicals that are accessory to a laboratory unit may be stored, whether outside of or entirely within a laboratory unit, in dedicated storage rooms complying with all of the following:

1. Storage room capacity shall be limited to a maximum of 300 gallons (1136 L) of laboratory chemicals, not to exceed 5 gallons per square foot (0.125 L/m<sup>2</sup>) of floor area.
2. Flammable gas storage rooms shall be limited to 2,500 standard cubic feet (71 standard cubic m) of flammable gas.
3. Storage rooms shall be enclosed by a minimum of 2-hour rated fire barriers.
4. Storage rooms shall be equipped with a continuously operated ventilation system that provides at least 6 changes of air per hour and vents to the outdoors.
5. Each entrance to the storage room shall be provided with a minimum 1½-hour rated self-closing fire door.
6. Each entrance to the storage room shall be provided with a sill at the doorway, except that no sill shall be required in storage rooms containing only flammable gases.
7. Storage rooms shall be equipped with an automatic sprinkler system providing at least one sprinkler for each 90 square feet (8.4 m<sup>2</sup>) or portion thereof.
8. Laboratory chemicals that are incompatible with each other shall not be stored in the same storage room unless in compliance with the *New York City Fire Code* for separation of incompatible materials.
9. Storage rooms shall not open directly to an exit or any enclosed exit access component.
10. The floor of any storage room storing flammable gases shall be located at or above grade.

**419.10 Ventilation.** Non-production laboratories shall be ventilated in accordance with Section 407 of the *New York City Mechanical Code*.

**(Equation 4-1)**

$$OLF = \frac{(0.00007)(GLA) + 25}{\text{where:}}$$

where:

OLF = The occupant load factor (square feet per person).

GLA = The gross leasable area (square feet).

TABLE 406.3.5  
OPEN PARKING GARAGES AREA AND HEIGHT

TYPE OF CONSTRUCTION	AREA PER TIER (square feet)	HEIGHT (in tiers)		
		Ramp access	Mechanical access	
			Automatic sprinkler system	
			No	Yes
IA	Unlimited	Unlimited	Unlimited	Unlimited
IB	Unlimited	12 tiers	12 tiers	18 tiers
IIA	50,000	10 tiers	10 tiers	15 tiers
IIIB	50,000	8 tiers	8 tiers	12 tiers
IV	50,000	4 tiers	4 tiers	4 tiers

For SI: 1 square foot = 0.0929 m<sup>2</sup>.

**TABLE 414.2.2  
DESIGN AND NUMBER OF CONTROL AREAS**

FLOOR LEVEL		PERCENTAGE OF THE MAXIMUM ALLOWABLE QUANTITY PER CONTROL AREA <sup>a</sup>	NUMBER OF CONTROL AREAS PER FLOOR <sup>b</sup>	FIRE-RESISTANCE RATING FOR FIRE BARRIERS IN HOURS <sup>c</sup>
Above grade	Higher than 9	5	1	2
	7-9	5	2	2
	6	12.5	2	2
	5	12.5	2	2
	4	12.5	2	2
	3	50	2	1
	2	75	3	1
	1	100	4	1
Below grade	1	75	3	1
	2	50	2	1
	Lower than 2	Not Allowed	Not Allowed	Not Allowed

- a. Percentages shall be of the maximum allowable quantity per control area shown in Tables 307.7(1) and 307.7(2), with all increases allowed in the notes to those tables.
- b. There shall be a maximum of two control areas per floor in Group M occupancies and in buildings or portions of buildings having Group S occupancies with storage conditions and quantities in accordance with Section 414.2.4.
- c. Fire barriers shall include walls and floors as necessary to provide separation from other portions of the building.

**TABLE 414.2.4  
 MAXIMUM ALLOWABLE QUANTITY PER INDOOR AND OUTDOOR CONTROL AREA IN GROUP M AND S OCCUPANCIES  
 NONFLAMMABLE SOLIDS AND NONFLAMMABLE AND NONCOMBUSTIBLE LIQUIDS <sup>d,e,f</sup>**

CONDITION		MAXIMUM ALLOWABLE QUANTITY PER CONTROL	
Material <sup>a</sup>	Class	Solids pounds	Liquids gallons
<b>Health-hazard materials—nonflammable and noncombustible solids and liquids</b>			
Corrosives <sup>b,c</sup>	Not Applicable	9,750	975
Highly toxics	Not Applicable	20 <sup>b,c</sup>	2 <sup>b,c</sup>
Toxics <sup>b,c</sup>	Not Applicable	1,000	100
<b>Physical-hazard materials—nonflammable and noncombustible solids and liquids</b>			
Oxidizers <sup>b,c</sup>	4	Not Allowed	Not Allowed
	3	1,150 <sup>g</sup>	115
	2	2,250 <sup>h</sup>	225
	1	18,000 <sup>i,j</sup>	1,800 <sup>i,j</sup>
Unstable (reactives) <sup>b,c</sup> detonable	4	Not Allowed	Not Allowed
	3	550	55
	2	1,150	115
	1	Not Limited	Not Limited
Water reactives nondetonable	3 <sup>b,c</sup>	550	55
	2 <sup>b,c</sup>	1,150	115
	1	Not Limited	Not Limited

For SI: 1 pound = 0.454 kg, 1 gallon = 3.785 L.

- a. Hazard categories are as specified in the *New York City Fire Code*.
- b. Maximum allowable quantities shall be increased 100 percent in buildings that are sprinklered in accordance with Section 903.3.1.1. When Note c also applies, the increase for both notes shall be applied cumulatively.
- c. Maximum allowable quantities shall be increased 100 percent when stored in approved storage cabinets, in accordance with the *New York City Fire Code*. When Note b also applies, the increase for both notes shall be applied cumulatively.
- d. See Table 414.2.2 for design and number of control areas.
- e. Allowable quantities for other hazardous material categories shall be in accordance with Section 307.
- f. Maximum quantities shall be increased 100 percent in outdoor control areas.
- g. Maximum amounts are permitted to be increased to 2,250 pounds when individual packages are in the original sealed containers from the manufacturer or packager and do not exceed 10 pounds each.
- h. Maximum amounts are permitted to be increased to 4,500 pounds when individual packages are in the original sealed containers from the manufacturer or packager and do not exceed 10 pounds each.
- i. Quantities are unlimited where protected by an automatic sprinkler system.
- j. Quantities are unlimited in an outdoor control area.



**TABLE 414.5.1  
EXPLOSION CONTROL REQUIREMENTS<sup>a</sup>**

<u>MATERIAL</u>	<u>CLASS</u>	<u>EXPLOSION CONTROL METHODS</u>	
		<u>Barricade construction</u>	<u>Explosion (deflagration) venting or explosion (deflagration) prevention systems<sup>b</sup></u>
<b><u>HAZARD CATEGORY</u></b>			
<u>Combustible dusts<sup>c</sup></u>	=	<u>Not Required</u>	<u>Required</u>
<u>Cryogenic flammables</u>	=	<u>Not Required</u>	<u>Required</u>
<u>Explosives</u>	<u>Division 1.1</u>	<u>Required</u>	<u>Not Required</u>
	<u>Division 1.2</u>	<u>Required</u>	<u>Not Required</u>
	<u>Division 1.3</u>	<u>Not Required</u>	<u>Required</u>
	<u>Division 1.4</u>	<u>Not Required</u>	<u>Required</u>
	<u>Division 1.5</u>	<u>Required</u>	<u>Not Required</u>
	<u>Division 1.6</u>	<u>Required</u>	<u>Not Required</u>
<u>Flammable gas</u>	<u>Gaseous</u>	<u>Not Required</u>	<u>Required</u>
	<u>Liquefied</u>	<u>Not Required</u>	<u>Required</u>
<u>Flammable liquid</u>	<u>IA<sup>d</sup></u>	<u>Not Required</u>	<u>Required</u>
	<u>IB<sup>e</sup></u>	<u>Not Required</u>	<u>Required</u>
<u>Organic peroxides<sup>g</sup></u>	<u>Unclassified detonable</u>	<u>Required</u>	<u>Not Permitted</u>
	<u>I</u>	<u>Required</u>	<u>Not Permitted</u>
<u>Oxidizer liquids and solids</u>	4	<u>Required</u>	<u>Not Permitted</u>
<u>Pyrophoric material<sup>h</sup></u>	<u>Detonable</u>	<u>Required</u>	<u>Not Permitted</u>
<u>Pyrophoric gas<sup>h</sup></u>	<u>Nondetonable</u>	<u>Not Required</u>	<u>Required</u>
<u>Unstable (reactive)<sup>h</sup></u>	4	<u>Required</u>	<u>Not Permitted</u>
	<u>3 Detonable</u>	<u>Required</u>	<u>Not Permitted</u>
	<u>3 Nondetonable</u>	<u>Not Required</u>	<u>Required</u>
<u>Water-reactive liquids and solids<sup>h</sup></u>	<u>3 Detonable</u>	<u>Required</u>	<u>Not Permitted</u>
	<u>3 Nondetonable</u>	<u>Not Required</u>	<u>Required</u>
	<u>2 Detonable</u>	<u>Required</u>	<u>Not Permitted</u>
	<u>2 Nondetonable</u>	<u>Not Required</u>	<u>Required</u>
<b><u>SPECIAL USES</u></b>			
<u>Grain processing</u>	=	<u>Not Required</u>	<u>Required</u>
<u>Where explosion hazards exist<sup>f</sup></u>	<u>Detonation</u>	<u>Required</u>	<u>Not Permitted</u>
	<u>Deflagration</u>	<u>Not Required</u>	<u>Required</u>

a. See Section 414.1.3.

b. See the *New York City Fire Code*.

c. As generated during manufacturing or processing. See definition of "Combustible dust" in Chapter 3.

d. Storage or use.

e. In open use or dispensing.

f. Rooms containing dispensing and use of hazardous materials when an explosive environment can occur because of the characteristics or nature of the hazardous materials or as a result of the dispensing or use process.

g. Considered as explosives for the purposes of storage.

**TABLE 415.3.1  
MINIMUM SEPARATION DISTANCES FOR BUILDINGS CONTAINING EXPLOSIVES<sup>e</sup>**

<b>QUANTITY OF EXPLOSIVES<sup>a,d</sup></b>		<b>MINIMUM DISTANCE (feet)</b>		
		<b>Lot lines<sup>b</sup> and inhabited buildings<sup>c</sup></b>		<b>Separation of magazines<sup>e</sup></b>
<b>Pounds over</b>	<b>Pounds not over</b>	<b>Barricaded</b>	<b>Unbarricaded</b>	
2	5	70	140	12
5	10	90	180	16
10	20	110	220	20
20	30	125	250	22
30	40	140	280	24
40	50	150	300	28
50	75	170	340	30
75	100	190	380	32
100	125	200	400	36
125	150	215	430	38
150	200	235	470	42
200	250	255	510	46
250	300	270	540	48
300	400	295	590	54
400	500	320	640	58
500	600	340	680	62
600	700	355	710	64
700	800	375	750	66
800	900	390	780	70
900	1,000	400	800	72

For SI: 1 pound = 0.454 kg, 1 foot = 304.8 mm.

- The number of pounds of explosives listed is the number of pounds of trinitrotoluene (TNT) or the equivalent pounds of other explosive.
- The distance listed is the distance to lot line, including lot lines at public ways.
- For the purpose of this table, an inhabited building is any building on the same property that is regularly occupied by people. Where two or more buildings containing explosives or magazines are located on the same property, each building or magazine shall comply with the minimum distance specified from inhabited buildings and, in addition, they shall be separated from each other by not less than the distance shown for "Separation of magazines," except that the quantity of explosives contained in detonator buildings or magazines shall govern in regard to the spacing of said buildings or magazines from buildings or magazines, as a group, shall be considered as one building or magazine, and the total quantity of explosives stored in such group shall be treated as if the explosive were in a single building or magazine located on the site of any building or magazine of the group, and shall comply with the minimum distance specified from other magazines or inhabited buildings.
- Storage of explosives in a quantity exceeding 1,000 pounds in one magazine is prohibited.
- Magazine is a building or structure, other than an operating building, approved for storage of explosive materials. Portable or mobile magazines not

exceeding 120 square feet (11 m<sup>2</sup>) in area need not comply with the requirements of this code, however, all magazines shall comply with the New York City Fire Code.

f. This table shall not apply to the temporary storage incidental to transportation.

**TABLE 415.3.2  
REQUIRED DETACHED STORAGE**

<b>DETACHED STORAGE IS REQUIRED WHEN THE QUANTITY OF MATERIAL EXCEEDS THAT LISTED HEREIN</b>			
<b>Material</b>	<b>Class</b>	<b>Solids and Liquids (tons)<sup>a,b</sup></b>	<b>Gases (cubic feet)<sup>a,b</sup></b>
<u>Explosives</u>	<u>Division 1.1</u> <u>Division 1.2</u> <u>Division 1.3</u> <u>Division 1.4</u> <u>Division 1.4<sup>c</sup></u> <u>Division 1.5</u> <u>Division 1.6</u>	<u>Maximum Allowable Quantity</u> <u>Maximum Allowable Quantity</u> <u>Maximum Allowable Quantity</u> <u>Maximum Allowable Quantity</u> <u>1</u> <u>Maximum Allowable Quantity</u> <u>Maximum Allowable Quantity</u>	<u>Not Applicable</u>
<u>Oxidizers</u>	<u>Class 4</u>	<u>Maximum Allowable Quantity</u>	<u>Maximum Allowable Quantity</u>
<u>Unstable (reactives) detonable</u>	<u>Class 3 or 4</u>	<u>Maximum Allowable Quantity</u>	<u>Maximum Allowable Quantity</u>
<u>Oxidizer, liquids and solids</u>	<u>Class 3</u> <u>Class 2</u>	<u>1,200</u> <u>2,000</u>	<u>Not Applicable</u> <u>Not Applicable</u>
<u>Organic peroxides</u>	<u>Detonable</u> <u>Class I</u> <u>Class II</u> <u>Class III</u>	<u>Maximum Allowable Quantity</u> <u>Maximum Allowable Quantity</u> <u>25</u> <u>50</u>	<u>Not Applicable</u> <u>Not Applicable</u> <u>Not Applicable</u> <u>Not Applicable</u>
<u>Unstable (reactives) nondetonable</u>	<u>Class 3</u> <u>Class 2</u>	<u>1</u> <u>25</u>	<u>2,000</u> <u>10,000</u>
<u>Water reactives</u>	<u>Class 3</u> <u>Class 2</u>	<u>1</u> <u>25</u>	<u>Not Applicable</u> <u>Not Applicable</u>
<u>Pyrophoric gases</u>	<u>Not Applicable</u>	<u>Not Applicable</u>	<u>2,000</u>

For SI: 1 ton = 906 kg, 1 cubic foot = 0.02832 M<sup>3</sup>.

- For materials that are detonable, the distance to other buildings or lot lines shall be as specified in Table 415.3.1 based on trinitrotoluene (TNT) equivalence of the material. For materials classified as explosives, see the *New York City Fire Code*. Unclassified detonable organic peroxides, detonable pyrophoric materials, detonable unstable (reactive) materials and detonable water-reactive materials shall be considered as explosives for the purposes of storage.
- “Maximum Allowable Quantity” means the maximum allowable quantity per control area set forth in Table 307.7(1).
- Limited to Division 1.4 materials and articles, including articles packaged for shipment, that are not regulated as an explosive under Bureau of Alcohol, Tobacco and Firearms (BATF) regulations or unpackaged articles used in process operations that do not propagate a detonation or deflagration between articles, providing the net explosive weight of individual articles does not exceed 1 pound.

**TABLE 415.9.2.1.1  
QUANTITY LIMITS FOR HAZARDOUS MATERIALS IN A SINGLE FABRICATION AREA IN GROUP H-5<sup>a</sup>**

<b>HAZARD CATEGORY</b>	<b>SOLIDS (pounds per square foot)</b>	<b>LIQUIDS (gallons per square feet)</b>	<b>GAS (SCF/ square feet)</b>
<b><u>PHYSICAL-HAZARD MATERIALS</u></b>			
Combustible dust	Note b	Not Applicable	Not Applicable
Combustible fiber Loose Baled	Note b Note b	Not Applicable	Not Applicable
Combustible liquid II IIIA IIIB	Not Applicable	0.01 0.02 Not Limited 0.04	Not Applicable
Combination Class I, II and IIIA			
Cryogenic gas Flammable Oxidizing	Not Applicable	Not Applicable	Note c 1.25
Explosives	Note b	Note b	Note b
Flammable gas Gaseous Liquefied	Not Applicable	Not Applicable	Note b Note c
Flammable liquid IA IB IC	Not Applicable	0.0025 0.025 0.025 0.025 0.04	Not Applicable
Combination Class IA, IB and IC Combination Class I, II and IIIA			
Flammable solid	0.001	Not Applicable	Not Applicable
Organic peroxide Unclassified detonable Class I Class II Class III Class IV Class V	Note b Note b 0.025 0.1 Not Limited Not limited	Not Applicable	Not Applicable
Oxidizing gas Gaseous			1.25 1.25
Combination of gaseous and liquefied	Not Applicable	Not Applicable	1.25
Oxidizer Class 4 Class 3 Class 2 Class 1 Combination Class 1, 2, 3	Note b 0.003 0.003 0.003 0.003 0.003	Note b 0.003 0.003 0.003 0.003	Not Applicable
Pyrophoric material	Note b	0.00125	Notes c and d
Unstable reactive Class 4 Class 3 Class 2 Class 1	Note b 0.025 0.1 Not Limited	Note b 0.0025 0.01 Not Limited	Note b Note b Note b Not Limited
Water reactive Class 3 Class 2 Class 1	Note b 0.25 Not Limited	0.00125 0.025 Not Limited	Not Applicable
<b><u>HEALTH-HAZARD MATERIALS</u></b>			
Corrosives	Not Limited	Not Limited	Not Limited
Highly toxic	Not Limited	Not Limited	Note c
Toxics	Not Limited	Not Limited	Note c

For SI: 1 pound per square foot = 4.882 kg/m<sup>2</sup>, 1 gallon per square foot = 0.025 L/m<sup>2</sup>, 1 cubic foot = 0.02832 M<sup>3</sup>.

a. Hazardous materials within piping shall not be included in the calculated quantities.

b. Quantity of hazardous materials in a single fabrication shall not exceed the maximum allowable quantities per control area in Tables 307.7(1) and 307.7(2).

c. The aggregate quantity of flammable, pyrophoric, toxic and highly toxic gases shall not exceed 9,000 SCF.

d. The aggregate quantity of pyrophoric gases in the building shall not exceed the amounts set forth in Table 415.3.2.

**CHAPTER 5**  
**GENERAL BUILDING HEIGHTS AND AREAS**

**SECTION BC 501**  
**GENERAL**

**501.1 Scope.** The provisions of this chapter control the height and area of structures hereafter erected and additions to existing structures.

**501.2 Premises identification.** Approved numbers or addresses shall be provided for new buildings and shall be placed in such a position as to be clearly visible and legible from the street or roadway fronting the property. Address numbers shall be Arabic numerals or alphabet letters and shall be a minimum 4 inches (102 mm) in height and stroke of minimum 0.5 inch (12.7 mm) of a contrasting color to the background itself.

**501.3 Fire Department access.**

**501.3.1 Frontage.** Every building, exclusive of accessory buildings, shall have at least 8 percent of the total perimeter of the building adjoining a street or frontage space. For the purposes of this section, building perimeter shall be measured at that story having the maximum enclosed floor area; and buildings provided with a front yard or front setback no deeper than 30 feet (9144 mm) in compliance with the Zoning Resolution shall be considered as adjoining the street or frontage space.

**501.3.2 Building access.** Provisions shall be made for access by the Fire Department to every building in accordance with this section.

**Exception:** The provisions of Section 501.3.2 shall not apply to any story that is completely protected by an automatic sprinkler system complying with Section 903.3.1. Such exception shall not apply to access to cellars or basements as required by Section 54 of the New York State Multiple Dwelling Law.

**501.3.2.1 Above grade.** Access shall be provided directly from the outdoors to each story below a height of 100 feet (30 480 mm) except to the first story or ground floor, by at least one window or readily identifiable access panel within each 50 feet (15 240 mm) or fraction thereof of horizontal length of every wall that fronts on a street or frontage space. All windows shall be openable from the inside or breakable from both the inside and the outside, and shall have a size when open of at least 24 inches by 36 inches (610 mm by 914 mm). Panels shall be openable from both the inside and outside and shall have a height when open of 48 inches (1219 mm) and a width of at least 32 inches (813 mm). The sill of the window or panel shall not be higher than 36 inches (914 mm) above the inside floor.

**Exception:** Where not all of the windows are openable or breakable, the windows intended to satisfy the requirements of Section 501.3.2.1 shall be readily identifiable.

**501.3.2.2 Below grade.** Access shall be provided directly from the outdoors to the first basement or cellar story below grade, except as provided below, within each 100 feet (30 480 mm) or fraction thereof of horizontal length of every wall that fronts on a street or frontage space. Such access shall be by stairs, doors, windows or other means that provide an opening 48 inches (1219 mm) high and 32 inches (813 mm) wide, the sill of which shall not be higher than 36 inches (914 mm) above the inside floor. If an areaway is used to provide below grade access, the minimum horizontal dimension shall be at least one-third the depth of the areaway or 6 feet (1829 mm) whichever is less.

1. One- and two-family dwellings need not provide direct access.
2. Any building classified in occupancy group R-2 not more than three stories in height and with not more than two dwelling units on any story need not provide direct access when such first basement or cellar story is used for dwelling units or for uses accessory to the residential use in the building.
3. Except as provided in item 2 above, for buildings classified in occupancy group R-1 or R-2 only one direct access from the outdoors to the first basement or cellar story consisting of a stair or door shall be required when such story is used for dwelling units or for uses accessory to the residential use in the building.

**501.3.2.3 Signs obstructing openings.** Where wall signs are erected to cover doors or windows of existing buildings, access panels shall be provided as necessary to comply with the requirements of Sections 501.3.2.1 and 501.3.2.2.

**501.3.2.4 Location.** Wherever practicable, one access opening in each story shall provide access to a stairway, or where there is no stairway at the exterior wall, one access opening in each story shall be located as close as practicable to a stairway.

## **SECTIONS BC 502** **DEFINITIONS**

**502.1 Definitions.** The following words and terms shall, for the purposes of this chapter and as used elsewhere in this code, have the meanings shown herein.

**AREA, BUILDING.** The area included within surrounding exterior walls (or exterior walls and firewalls) exclusive of vent shafts and courts. Areas of the building not provided with surrounding walls shall be included in the building area if such areas are included within the horizontal projection of the roof or floor above.

**BASEMENT.** A story partly below the grade plane and having less than one-half its clear height (measured from finished floor to finished ceiling) below the grade plane (see "Story", "Story above grade plane" in Section 502.1).

**CELLAR.** That portion of a building that is partly or wholly underground, and having one-half or more of its clear height (measured from finished floor to finished ceiling) below the grade plane. Cellars shall not be counted as stories in measuring the height of the buildings.

**FRONTAGE SPACE.** A street; or an open space adjoining a building not less than 30 feet (9144 mm) in any dimension. Such open space shall be accessible from a street by a driveway, lane, private road or alley at least 20 feet (6096 mm) in width. Frontage space including accessways shall be permanently maintained free of all obstructions that might interfere with its use by the Fire Department.

**GRADE PLANE.** A reference plane representing the level of the curb as established by the city engineer in the Borough President's office, measured at the center of the front of a building. Where a building faces on more than one street, the grade plane shall be the average of the levels of the curbs at the center of each front.

**Exception:** The grade plane shall not be referenced to the level of the curb, but shall be considered the average elevation of the final grade adjoining all exterior walls of a building, calculated from final grade elevations taken at intervals of 10 feet (3048 mm) around the perimeter of the building where:

1. No curb elevation has been legally established on the city map; or
2. Every part of the building is set back more than 25 feet (7620 mm) from a street line.

**HEIGHT, BUILDING.** The vertical distance from the grade plane to the average height of the highest roof surfaces.

**HEIGHT, STORY.** The vertical distance from top to top of two successive finished floor surfaces; and, for the topmost story, from the top of the floor finish to the top of the ceiling joists or, where there is not a ceiling, to the top of the roof rafters.

**INDUSTRIAL EQUIPMENT PLATFORM.** An unoccupied, elevated platform in an industrial occupancy used exclusively for mechanical systems or industrial process equipment, including the associated elevated walkways, stairs and ladders necessary to access the platform (see Section 505.5).

**MEZZANINE.** An intermediate level or levels between the floor and ceiling of any story with an aggregate floor area of not more than one-third of the area of the room or space in which the level or levels are located (see Section 505).



**STORY ABOVE GRADE PLANE.** Any story having its finished floor surface entirely above grade plane, except that a basement shall also be considered a story above grade plane (also see “Basement” and “Story”).

**STORY.** That portion of a building included between the upper surface of a floor and the upper surface of the floor or roof next above (also see “Basement” and “Mezzanine”).

### **SECTION BC 503** **GENERAL HEIGHT AND AREA LIMITATIONS**

**503.1 General.** The height and area for buildings of different construction types shall be governed by the intended use and occupancy of the building and shall not exceed the limits in Table 503 except as modified hereafter. Each part of a building included within the exterior walls or the exterior walls and fire walls where provided shall be permitted to be a separate building.

**503.1.1 Basements.** Basements need not be included in the total allowable area provided:

1. They do not exceed the area permitted for a one-story building; and
2. The finished surface of the floor above the basement does not exceed 6 feet (1829 mm) above grade plane.

**503.1.2 Special industrial occupancies.** Buildings and structures of Type I and II construction designed to house low-hazard industrial processes that require large areas and unusual heights to accommodate craneways or special machinery and equipment including, among others, rolling mills; structural metal fabrication shops and foundries; or the production and distribution of electric, gas or steam power, shall be exempt from the height and area limitations of Table 503.

**503.1.3 Buildings on same tax lot.** Two or more buildings on the same tax lot and under the same ownership and control shall be regulated as separate buildings, or shall be considered as portions of one building if the height of each building and the aggregate area of buildings are within the limitations of Table 503 as modified by Sections 504 and 506. The provisions of this code applicable to the aggregate building shall be applicable to each building.

**503.1.4 Type I construction.** Buildings of Type I construction permitted to be of unlimited tabular heights and areas in accordance with Table 503 are not required to comply with the special requirements that allow unlimited area buildings in Section 507 or unlimited height in Sections 503.1.2 and 504.3 or increased height and areas for other types of construction.

### **TABLE 503** **ALLOWABLE HEIGHT AND BUILDING AREAS** **Height limitations show as stories and feet above grade plane.**

**Area limitations are to be determined by the definition of “Area, building,” per floor.**

**(Table 503 attached to end of document)**

**503.2 Reserved.**

## **SECTION BC 504** **HEIGHT MODIFICATIONS**

**504.1 General.** The heights permitted by Table 503 shall only be increased in accordance with this section.

**Exception:** The height of one-story aircraft hangars, aircraft paint hangars and buildings used for the manufacturing of aircraft shall not be limited if the building is provided with an automatic fire-extinguishing system in accordance with Chapter 9 and is entirely surrounded by public ways or yards not less in width than one and one-half times the height of the building.

**504.2 Automatic sprinkler system increase.** Where a building is equipped throughout with an approved automatic sprinkler system in accordance with Section 903.3.1.1, the value specified in Table 503 for maximum height is increased by 20 feet (6096 mm) and the maximum number of stories is increased by one story. These increases are permitted in addition to the area increase in accordance with Sections 506.2 and 506.3. For Group R buildings equipped throughout with an approved automatic sprinkler system in accordance with Section 903.3.1.2, the value specified in Table 503 for maximum height is increased by 20 feet (6096 mm) and the maximum number of stories is increased by one story, but shall not exceed six stories or 60 feet (18 288 mm), respectively.

### **Exceptions:**

1. Group I-2 of Type IIB, III, IV or V construction.
2. Group H-1, H-2, H-3 or H-5.
3. Fire-resistance rating substitution in accordance with Table 601, Note d.

**504.3 Rooftop structures.** Rooftop structures including but not limited to roof tanks and their supports, ventilating, air conditioning and similar building service equipment, bulkheads, penthouses, chimneys, and parapet walls 4 feet (1219 mm) or less in height shall not be included in the height of the building or considered an additional story unless the aggregate area of all such structures exceeds 33 and one-third percent of the area of the roof of the building upon which they are erected. Rooftop structures shall be constructed in accordance with Section 1509.

## **SECTION BC 505** **MEZZANINES**

**505.1 General.** A mezzanine or mezzanines in compliance with this section shall be considered a portion of the floor below. Such mezzanines shall not contribute to either the building area or number of stories as regulated by Section 503.1. The area of the mezzanine shall be included in determining the fire area defined in Section 702. The clear height above and below the mezzanine floor construction shall not be less than 7 feet (2134 mm).

**Exception:** The clear height of habitable spaces above or below mezzanines within dwelling units shall not be less than 8 feet (2438 mm).

**505.2 Area limitation.** The aggregate area of a mezzanine or mezzanines within a room or space shall not exceed one-third of the area of that room or space in which they are located. The enclosed portions of a room or space shall not be included in determining the permissible floor area of the mezzanine. The area of the mezzanine shall not contribute to the determination of the floor area of the room or space below.

**Exception:**

1. The aggregate area of mezzanines in buildings and structures of Type I or II construction for special industrial occupancies in accordance with Section 503.1.2 shall not exceed two-thirds of the area of the room.
2. The aggregate area of a mezzanine or mezzanines within a dwelling unit shall not exceed one-third of the net floor area of such dwelling unit, whether or not portions of such dwelling unit are enclosed. The area of the mezzanine shall not contribute to the determination of the floor area of the dwelling unit below.

**505.3 Egress.** Each occupant of a mezzanine shall have access to at least two independent means of egress where the common path of egress travel exceeds the limitations of Section 1013.3. Where a stairway provides a means of exit access from a mezzanine, the maximum travel distance includes the distance traveled on the stairway measured in the plane of the tread nosing.

**Exceptions:**

1. A single means of egress shall be permitted in accordance with Section 1014.1.
2. Accessible means of egress shall be provided in accordance with Section 1007.

**505.4 Openness.** A mezzanine shall be open and unobstructed to the room in which such mezzanine is located except for walls or railings not more than 42 inches (1067 mm) high, columns and posts.

**Exceptions:**

1. Mezzanines or portions thereof are not required to be open to the room in which the mezzanines are located, provided that the occupant load of the aggregate area of the enclosed space does not exceed 10.
2. A mezzanine having two or more means of egress is not required to be open to the room in which the mezzanine is located, if at least one of the means of egress provides direct access to an exit from the mezzanine level.
3. Mezzanines or portions thereof are not required to be open to the room in which the mezzanines are located, provided that the aggregate floor area of the enclosed space does not exceed 10 percent of the mezzanine area.
4. In industrial facilities, mezzanines used for control equipment are permitted to be glazed on all sides.
5. In Group F occupancies of unlimited area, meeting the requirements of Section 507.2 or 507.3, mezzanines or portions thereof are not required to be open to the room in which the mezzanines are located, provided that an approved fire alarm system is installed throughout the entire building or structure and notification appliances are installed throughout the mezzanines in accordance with the provisions of NFPA 72. In addition, the fire alarm system shall be initiated by automatic sprinkler water flow.

**505.5 Industrial equipment platforms.** Industrial equipment platforms in buildings shall not be considered as a portion of the floor below. Such equipment platforms shall not contribute to either the building area or the number of stories as regulated by Section 503.1. The area of the industrial equipment platform shall not be included in determining the fire area. Industrial equipment platforms shall not be a part of any mezzanine, and such platforms and the walkways, stairs and ladders providing access to an equipment platform shall not serve as a part of the means of egress from the building.

**505.5.1 Area limitations.** The aggregate area of all industrial equipment platforms within a room shall not exceed two-thirds of the area of the room in which they occur. Where an equipment platform is located in the same room as a mezzanine, the area of the mezzanine shall be determined by Section 505.2, and the combined aggregate area of the equipment platforms and mezzanines shall not exceed two-thirds of the room in which they occur.

**505.5.2 Fire suppression.** Where located in a building that is required to be protected by an automatic sprinkler system, industrial equipment platforms shall be fully protected by sprinklers above and below the platform, where required by the standards referenced in Section 903.3.

**505.5.3 Guards.** Equipment platforms shall have guards where required by Section 1012.1.

**SECTION BC 506**  
**AREA MODIFICATIONS**

**506.1 General.** The areas limited by Table 503 shall be permitted to be increased due to frontage ( $I_f$ ) and automatic sprinkler system protection ( $I_s$ ) in accordance with the following:

**(Equation 5-1 attached to end of document)**

**506.2 Frontage increase.** Where a building has more than 25 percent of its perimeter adjoining a public way or open space having a minimum width of 20 feet (6096 mm), the frontage increase shall be determined in accordance with the following:

**(Equation 5-2 attached to end of document)**

**506.2.1 Width limits.**  $W$  must be at least 20 feet (6096 mm) and the quantity  $W$  divided by 30 shall not exceed 1.0. Where the value of  $W$  varies along the perimeter of the building, the calculation performed in accordance with Equation 5-2 shall be based on the weighted average of each portion of exterior wall and open space where the value of  $W$  is between 20 and 30 feet (6096 and 9144 mm).

**Exception:** The quantity  $W$  divided by 30 shall be permitted to not exceed 2.0 when all of the following conditions exist:

1. The building is permitted to be unlimited in area by Section 507; and
2. The only provision preventing unlimited area is compliance with the 60-foot (18 288 mm) public way or yard requirement, as applicable.

**506.2.2 Open space limits.** Such open space shall be either on the same zoning lot or dedicated for public use and shall be accessed from a street or approved fire lane.

**506.3 Automatic sprinkler system increase.** Where a building is protected throughout with an approved automatic sprinkler system in accordance with Section 903.3.1.1, the area limitation in Table 503 is permitted to be increased by an additional 200 percent ( $I_s = 200$  percent) for multistory buildings and an additional 300 percent ( $I_s = 300$  percent) for single-story buildings. These increases are permitted in addition to the height and story increases in accordance with Section 504.2.

**Exceptions:**

1. Buildings with an occupancy in Group H-1, H-2 or H-3.
2. Fire-resistance rating substitution in accordance with Table 601, Note d.

**506.4 Area determination.** The maximum area of a building with more than one story shall be determined by multiplying the allowable area per floor ( $A_a$ ), as determined in Section 506.1, by the number of stories as listed below.

1. For two-story buildings, multiply by 2;
2. For three-story or higher buildings, multiply by 3; and
3. No story shall exceed the allowable area per floor ( $A_a$ ), as determined in Section 506.1 for the occupancies on that floor.

**Exceptions:**

1. Unlimited area buildings in accordance with Section 507.
2. In group R occupancies 6 stories or less in height, the maximum area of a building equipped throughout with an automatic sprinkler system in accordance with Section 903.3.1.2 shall be determined by multiplying the allowable area per floor ( $A_a$ ), as determined in Section 506.1 by the number of stories.

**SECTION BC 507**  
**UNLIMITED AREA BUILDINGS**

**507.1 Nonsprinklered, one story.** The area of a one-story, Group F-2 or S-2 building of other than Type V construction shall not be limited when the building is surrounded and adjoined on all sides by public ways or yards not less than 60 feet (18 288 mm) in width.

**507.2 Sprinklered, one story.** The area of a one-story, Group B, F, M or S building or a one-story Group A-4 building of other than Type V construction shall not be limited when the building is provided with an automatic sprinkler system throughout in accordance with Section 903.3.1.1, and is surrounded and adjoined on all sides by public ways or yards not less than 60 feet (18 288 mm) in width. However, in Group F-2 and S-2 occupancies, one-story rack storage facilities of Type I and II construction that are not accessible to the public shall not be limited in height provided that such buildings conform to the requirements of this section and NFPA 231C.

**Exception:** The automatic sprinkler system shall not be required in areas occupied for indoor participant sports, such as tennis, skating, swimming and equestrian activities, in occupancies in Group A-4, provided that:

1. Exit doors directly to the outside are provided for occupants of the participant sports areas; and
2. The building is equipped with a fire alarm system with manual fire alarm boxes installed in accordance with Section 907.

**507.3 Sprinklered, two story.** The area of a two-story, Group B, F, M or S building shall not be limited when the building is provided with an automatic sprinkler system in accordance with Section 903.3.1.1 throughout, and is surrounded and adjoined on all sides by public ways or yards not less than 60 feet (18 288 mm) in width.

**507.4 Reduced open space.** The permanent open space of 60 feet (18 288 mm) required in Sections 507.1, 507.2 and 507.3 shall be permitted to be reduced to not less than 40 feet (12 192 mm) provided the following requirements are met:

1. The reduced open space shall not be allowed for more than 75 percent of the perimeter of the building.
2. The exterior wall facing the reduced open space shall have a minimum fire-resistance rating of 3 hours.
3. Openings in the exterior wall, facing the reduced open space, shall have opening protectives with a fire-resistance rating of 3 hours.

**507.5 Group A buildings.** The area of a Group A-1, A-2, A-3, or A-4 building of Type IIA, IIIA, or IV construction shall not be limited where the building is equipped throughout with an automatic sprinkler system in accordance with Section 903.3.1.1. The area of a one-story, Group A-3 building used as a church, community hall, dance hall, exhibition hall, gymnasium, lecture hall, indoor swimming pool or tennis court of Type IIB construction shall not be limited when all of the following criteria are met:

1. The building shall not have a stage other than a platform.
2. The building shall be equipped throughout with an automatic sprinkler system in accordance with Section 903.3.1.1.
3. The assembly floor shall be located at or within 21 inches (533 mm) of street or grade level and all exits are provided with ramps complying with Section 1010.1 to the street or grade level.
4. The building shall be surrounded and adjoined on all sides by public ways or yards not less than 60 feet (18 288 mm) in width.

**507.6 High-hazard occupancy groups.** Group H-2, H-3 and H-4 fire areas shall be permitted in unlimited area buildings having occupancies in Groups F and S, in accordance with the limitations of this section. Fire areas located at the perimeter of the unlimited area building shall not exceed 10 percent of the area of the building, nor the area limitations specified in Table 503 as modified by Section 506.2, based upon the percentage of the perimeter of the fire area that fronts on a street or other unoccupied space. Other fire areas shall not exceed 25 percent of the area limitations specified in

Table 503. Fire-resistance-rating requirements of fire barrier assemblies shall be in accordance with Table 302.3.2.

**507.7 Reserved.**

**507.8 Group E buildings.** The area of a Group E building of Type IIA, IIIA or IV construction shall not be limited where the building is protected throughout with an approved automatic sprinkler system in accordance with Section 903.3.1.1. The area of a one-story Group E building of Type II, IIIA or IV construction shall not be limited when the following criteria are met:

1. Each classroom shall have not less than two means of egress, with one of the means of egress being a direct exit to the outside of the building complying with Section 1017.
2. The building is equipped throughout with an automatic sprinkler system in accordance with Section 903.3.1.1.
3. The building is surrounded and adjoined on all sides by public ways or yards not less than 60 feet (18 288 mm) in width.

**507.9 Motion picture theaters.** In buildings of Type II, IIIA and IV construction, the area of one-story motion picture theaters shall not be limited when the building is provided with an automatic sprinkler system throughout in accordance with Section 903.3.1.1 and is surrounded and adjoined on all sides by public ways or yards not less than 60 feet (18 288 mm) in width.

**507.10 Group B buildings.** The area of a Group B building of Type IIA, IIIA or IV construction shall not be limited where the building is protected throughout with an approved automatic sprinkler system in accordance with Section 903.3.1.1.

**507.11 Group F-2 buildings.** The area of a Group F-2 building of Type IIA, IIIA or IV construction shall not be limited where the building is protected throughout with an approved automatic sprinkler system in accordance with Section 903.3.1.1.

**507.12 Group M buildings.** The area of a Group M building of Type IIA, IIIA or IV construction shall not be limited where the building is protected throughout with an approved automatic sprinkler system in accordance with Section 903.3.1.1.

**507.13 Group R buildings.** The area of a Group R1 and R-2 building of Type IIA, IIIA or IV construction shall not be limited where the building is protected throughout with an approved automatic sprinkler system in accordance with Sections 903.3.1.1 or 903.3.1.2, as applicable.



**507.14 Group S-2 buildings.** The area of a Group S-2 building of Type IB, IIA, IIIA or IV construction shall not be limited where the building is protected throughout with an approved automatic sprinkler system in accordance with Section 903.3.1.1.

## **SECTION BC 508** **SPECIAL PROVISIONS**

**508.1 General.** The provisions in this section shall permit the use of special conditions that are exempt from, or modify, the specific requirements of this chapter regarding the allowable heights and areas of buildings based on the occupancy classification and type of construction, provided the special condition complies with the provisions specified in this section for such condition and other applicable requirements of this code.

**508.2 Group S-2 enclosed parking garage with Group A, B, M or R above.** A basement and/or the first story above grade plane of a building shall be considered as a separate and distinct building for the purpose of determining area limitations, continuity of fire walls, limitation of number of stories and type of construction, when all of the following conditions are met:

1. The basement and/or the first story above grade plane is of Type IA construction and is separated from the building above with a horizontal floor assembly having a minimum 3-hour fire-resistance rating.
2. Shaft, stairway, ramp or escalator enclosures through the horizontal floor assembly shall have a minimum of 2-hour fire-resistance rating with opening protectives in accordance with Table 715.3.

**Exception:** Where the enclosure walls below the horizontal floor assembly have a minimum of 3-hour fire-resistance rating with opening protectives in accordance with Table 715.3, the enclosure walls extending above the horizontal floor assembly shall be permitted to have a 1-hour fire-resistance rating provided:

1. The building above the horizontal floor assembly is not required to be of Type I construction;
  2. The enclosure connects less than four stories, and
  3. The enclosure opening protectives above the horizontal floor assembly have a minimum 1-hour fire protection rating.
3. The building above the horizontal floor assembly contains only Group A having an assembly room with an occupant load of less than 300, or Group B, M or R; and
  4. The building below the horizontal floor assembly is a Group S-2 enclosed parking garage, used for the parking and storage of private motor vehicles.

**Exceptions:**

1. Entry lobbies, mechanical rooms, accessory storage and similar uses incidental to the operation of the building shall be permitted.
2. Group A having an assembly room with an occupant load of less than 300, or Group B or M shall be permitted in addition to those uses incidental to the operation of the building, provided that the entire structure below the horizontal floor assembly is protected throughout by an approved automatic sprinkler system.
5. The maximum building height in feet/meters as measured from the grade plane shall not exceed the limits set forth in Table 503 for the least restrictive type of construction involved.

**508.3 Group S-2 enclosed parking garage with Group S-2 open parking garage above.** A Group S-2 enclosed parking garage located in the basement or first story below a Group S-2 open parking garage shall be classified as a separate and distinct building for the purpose of determining the type of construction when the following conditions are met:

1. The allowable area of the structure shall be such that the sum of the ratios of the actual area divided by the allowable area for each separate occupancy shall not exceed 1.0.
2. The Group S-2 enclosed parking garage is of Type I or II construction and is at least equal to the fire-resistance requirements of the Group S-2 open parking garage.
3. The height and the number of the floors above the basement shall be limited as specified in Table 406.3.5.
4. The floor assembly separating the Group S-2 enclosed parking garage and Group S-2 open parking garage shall be protected as required for the floor assembly of the Group S-2 enclosed parking garage. Openings between the Group S-2 enclosed parking garage and Group S-2 open parking garage, except exit openings, shall not be required to be protected.
5. The Group S-2 enclosed parking garage is used exclusively for the parking or storage of private motor vehicles, but shall be permitted to contain an accessory office, waiting room and toilet room having a total area of not more than 1,000 square feet (93 m<sup>2</sup>), and mechanical equipment rooms incidental to the operation of the building.

**508.4 Parking beneath Group R.** Where a maximum one-story above grade plane Group S-2 parking garage, enclosed or open, or combination thereof, of Type I

construction or open of Type IV construction, with grade entrance, is provided under a building of Group R, the number of stories to be used in determining the minimum type of construction shall be measured from the floor above such a parking area. The horizontal floor assembly between the parking garage and the Group R above shall comply with the type of construction required for the parking garage and shall also provide a fire-resistance rating not less than the mixed occupancy separation required in Section 302.3.2.

**508.5 Reserved.**

**508.6 Group R-2 buildings of Type IIA construction.** The height limitation for buildings of Type IIA construction in Group R-2 shall be increased to nine stories and 100 feet (30 480 mm) where the building is separated by not less than 50 feet (15 240 mm) from any other building on the lot and from property lines, the exits are segregated in an area enclosed by a 2-hour fire-resistance-rated fire wall and the first-floor construction has a fire-resistance rating of not less than 1½ hours.

**508.7 Open parking garage beneath Groups A, I, B, M and R.** Open parking garages constructed under Groups A, I, B, M and R shall not exceed the height and area limitations permitted under Section 406.3. The height and area of the portion of the building above the open parking garage shall not exceed the limitations in Section 503 for the upper occupancy. The height, in both feet and stories, of the portion of the building above the open parking garage shall be measured from grade plane and shall include both the open parking garage and the portion of the building above the parking garage.

**508.7.1 Fire separation.** Fire separation assemblies between the parking occupancy and the upper occupancy shall correspond to the required fire-resistance rating prescribed in Table 302.3.2 for the occupancies involved. The type of construction shall apply to each occupancy individually, except that structural members, including main bracing within the open parking structure, which is necessary to support the upper occupancy, shall be protected with the more restrictive fire-resistance-rated assemblies of the groups involved as shown in Table 601. Means of egress for the upper occupancy shall conform to Chapter 10 and shall be separated from the parking occupancy by fire barriers having at least a 2-hour fire-resistance rating as required by Section 706, with self-closing doors complying with Section 715. Means of egress from the open parking garage shall comply with Section 406.3.

**508.8 Industrial uses in buildings containing Group R.** No space classified as Factory Industrial Group F shall be located above the second story of any building of Type III, IV, or V construction containing a space classified as Residential Group R-1 or R-2.

$$A_a = A_t + \left[ \frac{A_t I_f}{100} \right] + \left[ \frac{A_t I_s}{100} \right] \quad \text{(Equation 5-1)}$$

where:

- $A_a$  = Allowable area per floor (square feet).
- $A_t$  = Tabular area per floor in accordance with Table 503 (square feet).
- $I_f$  = Area increase due to frontage (percent) as calculated in accordance with Section 506.2.
- $I_s$  = Area increase due to sprinkler protection (percent) as calculated in accordance with Section 506.3.

$$I_f = 100 \left[ \frac{F}{P} - 0.25 \right] \frac{W}{30} \quad \text{(Equation 5-2)}$$

where:

- $I_f$  = Area increase due to frontage.
- $F$  = Building perimeter which fronts on a public way or open space having 20 feet (6096 mm) open minimum width (feet).
- $P$  = Perimeter of entire building (feet).
- $W$  = Width of public way or open space (feet) in accordance with Section 506.2.1.

**506.2.1 Width limits.**  $W$  must be at least 20 feet (6096 mm) and the quantity  $W$  divided by 30 shall not exceed 1.0. Where the value of  $W$  varies along the perimeter of the

**TABLE 503 -ALLOWABLE HEIGHT AND BUILDING AREAS**

**Height limitations shown as stories and feet above grade plane.**

**Area limitations as determined by the definition of "Area, building," per floor.**

GROUP	Hgt(feet) Hgt(S)	TYPE OF CONSTRUCTION								
		TYPE I		TYPE II		TYPE III		TYPE IV	TYPE V	
		A	B	A	B	A	B	HT	A	B
		UL	160	65	55	65	55	65	50	40
A-1	S	UL	UL	6	3	6	3	6	3	2
	A	UL	UL	17,500	10,500	14,700	5,600	15,000	8,400	5,500
A-2	S	UL	UL	6	3	6	3	6	3	2
	A	UL	UL	17,500	9,500	14,000	5,600	15,000	8,400	5,500
A-3	S	UL	UL	6	3	6	3	6	3	2
	A	UL	UL	17,500	9,500	14,000	5,600	15,000	8,400	5,500
A-4	S	UL	UL	6	3	6	3	6	3	2
	A	UL	UL	17,500	9,500	14,000	5,600	15,000	8,400	5,500
A-5	S	UL	UL	UL	UL	UL	UL	6	UL	UL
	A	UL	UL	UL	UL	UL	UL	UL	UL	UL
B	S	UL	UL	6	3	6	3	6	3	2
	A	UL	UL	37,500	10,500	28,000	5,600	36,000	8,400	5,500
E	S	UL	UL	4	3	4	3	6	3	2
	A	UL	UL	26,000	10,500	23,000	5,600	25,500	8,400	5,500
F-1	S	UL	UL	5	3	5	2	5	3	2
	A	UL	UL	12,500	7,500	7,500	3,000	10,000	3,000	1,000
F-2	S	UL	UL	6	3	6	3	6	3	2
	A	UL	UL	37,500	10,500	28,000	5,600	30,000	8,400	5,500
H-1	S	1	1	1	1	1	1	1	1	NP
	A	21,000	16,500	11,000	7,500	9,500	7,000	10,500	7,500	NP
H-2	S	UL	3	2	1	2	1	2	1	1
	A	21,000	16,500	11,000	7,500	9,500	7,000	10,500	7,500	3,000
H-3	S	UL	6	4	2	4	2	4	2	1
	A	UL	60,000	26,500	14,00	17,500	13,000	25,000	10,000	5,000
H-4	S	UL	7	5	3	5	3	5	3	2
	A	UL	UL	37,500	17,500	28,000	17,500	36,000	18,000	6,500
H-5	S	3	3	3	3	3	3	3	3	2
	A	UL	UL	37,500	23,000	28,000	19,000	36,000	18,000	9,000
I-1	S	UL	UL	6	NP	4	3	4	NP	NP
	A	UL	UL	19,000	NP	16,500	5,600	18,000	NP	NP
I-2	S	UL	6	4	4	5	3	5	3	NP
	A	UL	UL	7,000	3,500	5,000	1,200	6,500	2,000	NP
I-3	S	UL	4	4	3	4	2	4	3	NP
	A	UL	UL	7,000	3,500	5,000	1,200	6,500	2,000	NP
I-4	S	UL	UL	3	3	3	3	3	2	2
	A	UL	UL	26,500	9,500	23,000	5,600	25,500	8,400	5,500
M	S	UL	UL	6	3	6	3	6	3	2
	A	UL	UL	21,500	7,500	18,500	5,600	14,000	8,400	5,500
R-1	S	UL	UL	6	NP	6	NP	6	NP	NP
	A	UL	UL	UL	NP	24,000	NP	20,500	NP	NP
R-2	S	UL	UL	6	NP	6	3	6	NP	NP
	A	UL	UL	UL	NP	24,000	5,600	20,500	NP	NP
R-3	S	UL	UL	6	3	6	3	6	3	3
	A	UL	UL	17,500	10,500	14,700	5,600	30,000	8,400	5,500

<u>S-1</u>	<u>S</u> <u>A</u>	<u>UL</u> <u>UL</u>	<u>6</u> 48,000	<u>5</u> 12,000	<u>3</u> 7,500	<u>4</u> 7,500	<u>3</u> 7,500	<u>4</u> 7,500	<u>3</u> 5,000	<u>2</u> 1,000
<u>S-2<sup>b,c</sup></u>	<u>S</u> <u>A</u>	<u>UL</u> <u>UL</u>	<u>UL</u> <u>UL</u>	<u>6</u> 15,000	<u>3</u> 10,000	<u>6</u> 10,000	<u>4</u> 8,500	<u>6</u> 10,000	<u>3</u> 8,400	<u>2</u> 5,500
<u>U<sup>c</sup></u>	<u>S</u> <u>A</u>	<u>UL</u> <u>UL</u>	<u>5</u> 35,000	<u>4</u> 19,000	<u>2</u> 8,500	<u>3</u> 14,000	<u>2</u> 8,500	<u>4</u> 18,000	<u>2</u> 9,000	<u>1</u> 5,500

For SI: 1 foot = 304.8 mm, 1 square foot = 0.0929 m<sup>2</sup>.

UL = Unlimited, NP = Not permitted.

b. For open parking structures, see Section 406.3.

c. For private garages, see Section 406.1.



Not permitted in Fire District



Not permitted in Fire District without sprinklers

**CHAPTER 6**  
**TYPES OF CONSTRUCTION**

**SECTION BC 601**  
**GENERAL**

**601.1 Scope.** The provisions of this chapter shall control the classification of buildings as to type of construction with respect to occupancy and exterior fire separation distance.

**SECTION BC 602**  
**CONSTRUCTION CLASSIFICATION**

**602.1 General.** Buildings and structures erected or to be erected, altered or extended in height or area shall be classified in one of the five construction types defined in Sections 602.2 through 602.5. The building elements shall have a fire-resistance rating not less than that specified in Table 601 and exterior walls shall have a fire-resistance rating not less than that specified in Table 602. Buildings constructed or altered inside the fire district shall further comply with Appendix D.

**602.1.1 Minimum requirements.** A building or portion thereof shall not be required to conform to the details of a type of construction higher than that type, which meets the minimum requirements based on occupancy even though certain features of such a building actually conform to a higher type of construction. Classification shall be that of the minimum requirement unless all of the requirements for the higher type of construction are met.

**602.2 Types I and II.** Type I and II construction are those types of construction in which the building elements listed in Table 601 are of noncombustible materials.

**602.3 Type III.** Type III construction is that type of construction in which the exterior walls are of noncombustible materials and the interior building elements are of any material permitted by this code. Fire-retardant-treated wood framing complying with Section 2303.2 shall be permitted within exterior wall assemblies of a 2-hour rating or less.

**Exceptions:**

- 1. In Group I-1, R-1, and R-2 occupancies, all exterior walls, fire walls, exit passageways, and shaft enclosures shall be non-combustible.**
- 2. In Group F occupancies subject to Section 270(1) of the New York State Labor Law, all exterior wall assemblies and all structural elements shall meet the requirements for a “fireproof building” as such term is defined in Section 264 of such law.**
- 3. Inside the fire district, exterior load-bearing walls shall be constructed of noncombustible material.**



4. Inside the fire district, exterior nonload-bearing walls may be constructed with fire-retardant-treated wood complying with Section 2303.2 where the building is equipped throughout with an automatic sprinkler system in accordance with Sections 903.3.1.1 through 903.3.1.3, unless otherwise prohibited by Exception 1 or 2 above.

**602.4 Type IV.** Type IV construction (Heavy Timber, HT) is that type of construction in which the exterior walls are of noncombustible materials and the interior building elements are of solid or laminated wood without concealed spaces. The details of Type IV construction shall comply with the provisions of this section. Fire-retardant-treated-wood framing complying with Section 2303.2 shall be permitted within exterior wall assemblies with a 2-hour rating or less.

**Exceptions:**

1. In Group I-1, R-1, and R-2 occupancies, all exterior walls, fire walls, exit passageways, and shaft enclosures shall be non-combustible.
2. In Group F occupancies subject to Section 270(1) of the New York State Labor Law, all exterior wall assemblies and all structural elements shall meet the requirements for a “fireproof building” as defined in Section 264 of such law.
3. Inside the fire district, exterior load-bearing walls shall be constructed of noncombustible material.
4. Inside the fire district, exterior non-bearing walls may be constructed with fire-retardant-treated wood complying with Section 2303.2 where the building is equipped throughout with an automatic sprinkler system in accordance with Sections 903.3.1.1 through 903.3.1.3, unless otherwise prohibited by Exception 1 or 2 above.

**602.4.1 Columns.** Wood columns shall be sawn or glued laminated and shall not be less than 8 inches (203 mm) nominal in any dimension where supporting floor loads and not less than 6 inches (152 mm) nominal in width and not less than 8 inches (203 mm) nominal in depth where supporting roof and ceiling loads only. Columns shall be continuous or superimposed and connected in an approved manner.

**602.4.2 Floor framing.** Wood beams and girders shall be of sawn or glued-laminated timber and shall be not less than 6 inches (152 mm) nominal in width and not less than 10 inches (254 mm) nominal in depth. Framed sawn or glued-laminated timber arches, which spring from the floor line and support floor loads, shall be not less than 8 inches (203 mm) nominal in any dimension. Framed timber trusses supporting floor loads shall have members of not less than 8 inches (203 mm) nominal in any dimension.

**602.4.3 Roof framing.** Wood-frame or glued-laminated arches for roof construction, which spring from the floor line or from grade and do not support floor loads, shall have members not less than 6 inches (152 mm) nominal in width and have less than 8 inches (203 mm) nominal in depth for the lower half of the height and not less than 6 inches (152 mm) nominal in depth for the upper half. Framed or glued laminated arches for roof construction that spring from the top of walls or wall abutments, framed timber trusses and other roof framing, which do not support floor loads, shall have members not less than 4 inches (102 mm) nominal in width and not less than 6 inches (152 mm) nominal in depth. Spaced members shall be permitted to be composed of two or more pieces not less than 3 inches (76 mm) nominal in thickness where blocked solidly throughout their intervening spaces or where spaces are tightly closed by a continuous wood cover plate of not less than 2 inches (51 mm) nominal in thickness secured to the underside of the members. Splice plates shall be not less than 3 inches (76 mm) nominal in thickness. Where protected by approved automatic sprinklers under the roof deck, framing members shall be not less than 3 inches (76 mm) nominal in width.

**602.4.4 Floors.** Floors shall be without concealed spaces. Wood floors shall be of sawn or glued-laminated planks, splined or tongue-and-groove, of not less than 3 inches (76 mm) nominal in thickness covered with 1-inch (25 mm) nominal dimension tongue-and-groove flooring, laid crosswise or diagonally, or 0.5-inch (12.7 mm) particleboard or planks not less than 4 inches (102 mm) nominal in width set on edge close together and well spiked and covered with 1-inch (25mm) nominal dimension flooring or <sup>15</sup>/<sub>32</sub>-inch (12 mm) wood structural panel or 0.5-inch (12.7 mm) particleboard. The lumber shall be laid so that no continuous line of joints will occur except at points of support. Floors shall not extend closer than 0.5 inch (12.7 mm) to walls. Such 0.5-inch (12.7 mm) space shall be covered by a molding fastened to the wall and so arranged that it will not obstruct the swelling or shrinkage movements of the floor. Corbeling of masonry walls under the floor shall be permitted to be used in place of molding.

**602.4.5 Roofs.** Roofs shall be without concealed spaces and wood roof decks shall be sawn or glued laminated, splined or tongue-and-groove plank, not less than 2 inches (51 mm) thick, 1<sup>1</sup>/<sub>8</sub>-inch-thick (32 mm) wood structural panel (exterior glue), or of planks not less than 3 inches (76 mm) nominal in width, set on edge close together and laid as required for floors. Other types of decking shall be permitted to be used if providing equivalent fire resistance and structural properties.

**602.4.6 Partitions.** Partitions shall be of solid wood construction formed by not less than two layers of 1-inch (25 mm) matched boards or laminated construction 4 inches (102 mm) thick, or of 1-hour fire-resistance-rated construction.

**602.4.7 Exterior structural members.** Where a horizontal separation of 20 feet (6096 mm) or more is provided, wood columns and arches conforming to heavy

timber sizes shall be permitted to be used externally, except as prohibited by Section 602.4 for Occupancy Groups F, I-1, R-1 and R-2.

**602.5 Type V.** Type V construction is that type of construction in which the structural elements, exterior walls and interior walls are of any materials permitted by this code. Type V construction shall not be permitted inside the fire district.

**Exception:** In Group F occupancies subject to Section 270(1) of the New York State Labor Law, all exterior wall assemblies and all structural elements shall meet the requirements for a “fireproof building” as defined in Section 264 of such law.

**SECTION BC 603**  
**COMBUSTIBLE MATERIAL IN TYPE I**  
**AND II CONSTRUCTION**

**603.1 Allowable materials.** Combustible materials shall be permitted in buildings of Type I or II construction in the following applications and in accordance with Sections 603.1.1 through 603.1.3.

1. Fire-retardant-treated wood, complying with Section 2303.2, shall be permitted in:

1.1. Nonbearing interior partitions where the required fire-resistance rating is 1 hour or less.

**Exception:** Public corridors and exits shall be constructed of noncombustible materials.

1.2. Roof construction as permitted in Table 601, Note c, Item 3.

2. Thermal and acoustical insulation, other than foam plastics, having a flame spread index of not more than 25.

**Exceptions:**

1. Insulation placed between two layers of combustible materials without an intervening airspace shall be allowed to have a flame spread index of not more than 100.

2. Insulation installed between a finished floor and solid decking without intervening airspace shall be allowed to have a flame spread index of not more than 200.

3. Foam plastics in accordance with Chapter 26.

4. Roof coverings that have an A or B classification as defined in Section 1505.
5. Interior floor finish and interior finish, trim and millwork such as doors, door frames, window sashes and frames, as permitted by Chapter 8.
6. Where not installed over 15 feet (4572 mm) above grade, show windows, nailing or furring strips, wooden bulkheads below show windows, their frames, aprons and show cases, as permitted by Section 1405.
7. Finished flooring applied directly to the floor slab or to wood sleepers that are firestopped in accordance with Section 717.2.7, where combustible finish flooring is permitted by Chapter 8.
8. Partitions dividing portions of stores, offices or similar places occupied by one tenant only and which do not establish a corridor serving an occupant load of 30 or more shall be permitted to be constructed of fire-retardant-treated wood, 1-hour fire-resistance-rated construction or of wood panels or similar light construction up to 6 feet (1829 mm) in height.
9. Platforms as permitted in Section 410.
10. Combustible exterior wall coverings in accordance with Chapter 14.
11. Blocking such as for handrails, millwork, cabinets and window and door frames.
12. Light-transmitting plastics as permitted by Chapter 26.
13. Mastics and caulking materials applied to provide flexible seals between components of exterior wall construction.
14. Exterior plastic veneer installed in accordance with Section 2605.2.
15. Nailing or furring strips as permitted by Section 803.4.
16. Heavy timber as permitted by Note c, Item 2, Table 601 and Section 602.4.7.
17. Aggregates, component materials and admixtures as permitted by Section 703.2.2.
18. Sprayed cementitious and mineral fiber fire-resistance-rated materials installed to comply with Section 1704.11.

19. Materials used to protect penetrations in fire-resistance-rated assemblies in accordance with Section 712.
20. Materials used to protect joints in fire-resistance-rated assemblies in accordance with Section 713.
21. Materials allowed in the concealed spaces of buildings of Type I and II construction in accordance with Section 717.5.
22. Materials exposed within plenums complying with Section 602 of the *New York City Mechanical Code*.

**603.1.1 Ducts.** The use of nonmetallic ducts shall be permitted when installed in accordance with the limitations of the *New York City Mechanical Code*.

**603.1.2 Piping.** The use of combustible piping materials shall be permitted when installed in accordance with the limitations of the *New York City Plumbing Code*.

**603.1.3 Electrical.** The use of electrical wiring methods with combustible insulation, tubing, raceways and related components shall be permitted when installed in accordance with the limitations of the *New York City Electrical Code*.

**TABLE 601**  
**FIRE-RESISTANCE RATING REQUIREMENTS FOR BUILDING ELEMENTS**  
**(hours)**  
**(Table 601 attached to end of document)**

**TABLE 602**  
**FIRE-RESISTANCE RATING REQUIREMENTS FOR EXTERIOR WALLS**  
**BASED ON FIRE SEPARATION DISTANCE<sup>a</sup>**  
**(Table 602 attached to end of document)**

**TABLE 601**  
**FIRE-RESISTANCE RATING REQUIREMENTS FOR BUILDING ELEMENT (hours)**

<b>BUILDING ELEMENT</b>	<b>TYPE I</b>		<b>TYPE II</b>		<b>TYPE III</b>		<b>TYPE IV</b>	<b>TYPE V<sup>i</sup></b>	
	<b>A</b>	<b>B</b>	<b>A<sup>d</sup></b>	<b>B</b>	<b>A<sup>d</sup></b>	<b>B</b>	<b>HT</b>	<b>A<sup>d</sup></b>	<b>B</b>
<u>Structural frame<sup>a</sup></u> <u>Including columns, girders, trusses</u>	<u>3<sup>b</sup></u>	<u>2<sup>b</sup></u>	<u>1</u>	<u>0</u>	<u>1</u>	<u>0</u>	<u>HT</u>	<u>1</u>	<u>0</u>
<u>Bearing walls</u> <u>Exterior<sup>f,g</sup></u> <u>Interior</u>	<u>3</u> <u>3<sup>b</sup></u>	<u>2</u> <u>2<sup>b</sup></u>	<u>1</u> <u>1</u>	<u>0</u> <u>0</u>	<u>2</u> <u>1</u>	<u>2</u> <u>0</u>	<u>2</u> <u>1/HT</u>	<u>1</u> <u>1</u>	<u>0</u> <u>0</u>
<u>Nonbearing walls and partitions</u> <u>Exterior</u>	<u>See Table 602</u>								
<u>Nonbearing walls and partitions</u> <u>Interior<sup>e</sup></u>	<u>0</u>	<u>0</u>	<u>0</u>	<u>0</u>	<u>0</u>	<u>0</u>	<u>See Section 602.4.6</u>	<u>0</u>	<u>0</u>
<u>Floor construction<sup>h</sup></u> <u>Including supporting beams and joists</u>	<u>2</u>	<u>2</u>	<u>1</u>	<u>0</u>	<u>1</u>	<u>0</u>	<u>HT</u>	<u>1</u>	<u>0</u>
<u>Roof construction</u> <u>Including supporting beams and joists</u>	<u>1 1/2<sup>c</sup></u>	<u>1<sup>c</sup></u>	<u>1<sup>c</sup></u>	<u>0</u>	<u>1<sup>c</sup></u>	<u>0</u>	<u>HT</u>	<u>1<sup>c</sup></u>	<u>0</u>

For SI: 1 foot = 304.8 mm.

a. The structural frame shall be considered to be the columns and the girders, beams, trusses and spandrels having direct connections to the columns and bracing members designed to carry gravity loads. The members of floor or roof panels which have no connection to the columns shall be considered secondary members and not a part of the structural frame.

b. Roof supports: Fire-resistance ratings of structural frame and bearing walls are permitted to be reduced by 1 hour where supporting a roof only.

c. 1. Except in Factory-Industrial (F-1), Hazardous (H), Mercantile (M) and Moderate-Hazard Storage (S-1) occupancies, fire protection of structural members shall not be required, including protection of roof framing and decking where every part of the roof construction is 20 feet or more above any floor immediately below. Fire-retardant-treated wood members shall be allowed to be used for such unprotected members.

2. Except in Factory-Industrial (F) occupancies subject to regulation under Sections 264(1) and 264(2) of the New York State Labor Law, and in Group I-1, R-1, and Group R-2 occupancies, in all occupancies heavy timber shall be allowed where a 1-hour or less fire-resistance rating is required.

3. Except in Factory-Industrial (F) occupancies subject to regulation under Sections 264(1) and 264(2) of the New York State Labor Law, and in Group I-1, R-1, and Group R-2 occupancies, in Type I and II construction, fire-retardant-treated wood shall be allowed in buildings including girders and trusses as part of the roof construction when the building is:

- i. Type II construction of any height; or
- ii. Type I construction two stories or less; or when over two stories, the vertical distance from the upper floor to the roof is 20 feet or more.

d. An approved automatic sprinkler system in accordance with Section 903.3.1.1 shall be allowed to be substituted for 1-hour fire-resistance-rated construction, provided such system is not otherwise required by other provisions of the code or used for an allowable area increase in accordance with Section 506.3 or an allowable height increase in accordance with Section 504.2. The 1-hour substitution for the fire resistance of exterior walls shall not be permitted.

e. Not less than the fire-resistance rating required by other sections of this code.

f. Not less than the fire-resistance rating based on fire separation distance (see Table 602).

g. See footnote (d) of Table 602.

h. See Section 711.3 for additional requirements.

i. Type V construction is not permitted inside fire districts.

**TABLE 602**  
**FIRE-RESISTANCE RATING REQUIREMENTS FOR EXTERIOR WALLS BASED ON FIRE**  
**SEPARATION DISTANCE<sup>a,d,e</sup>**

FIRE SEPARATION DISTANCE (feet)	TYPE OF CONSTRUCTION	GROUP H	GROUP F-1, M, S-1	GROUP A, B, E, F-2, I, R <sup>b</sup> , S-2, U
< 5 <sup>c</sup>	All	3	2	1
≥ 5	IA	3	2	1
< 10	Others	2	1	1
≥ 10	IA, IB	2	1	1
< 30	IIB, VB	1	0	0
	Others	1	1	1
≥ 30	All	0	0	0

For SI: 1 foot = 304.8 mm.

a. Load-bearing exterior walls shall also comply with the fire-resistance rating requirements of Table 601.

b. Group R-3 and Group U when used as accessory to Group R-3 shall not be required to have a fire-resistance rating where the fire separation distance is 3 feet or more.

c. See Section 705.1.1 for party walls.

d. Inside the fire district, exterior load bearing walls of Type II buildings shall have a fire-resistance rating not less than prescribed below:

< 5 2 hours

> (or equal) 5 and <10 2 hours

> (or equal) 10 < 30 1 hour

> (or equal) 30 As per table 602.

e. Inside the fire district, exterior non-load bearing walls of Type II buildings shall have a fire resistance rating not less than prescribed below:

< 5 As per table 602

> (or equal) 5 and <10 As per table 602

> (or equal) 10 < 30 1 hour

> (or equal) 30 As per table 602.

**CHAPTER 7**  
**FIRE-RESISTANCE-RATED CONSTRUCTION**

**SECTION BC 701**  
**GENERAL**

**701.1 Scope.** The provisions of this chapter shall govern the materials and assemblies used for structural fire resistance and fire-resistance-rated construction separation of adjacent spaces to safeguard against the spread of fire and smoke within a building and the spread of fire to or from buildings.

**SECTION BC 702**  
**DEFINITIONS**

**702.1 Definitions.** The following words and terms shall, for the purposes of this chapter, and as used elsewhere in this code, have the meanings shown herein.

**ANNULAR SPACE.** The opening around the penetrating item.

**CEILING RADIATION DAMPER.** A listed device installed in a ceiling membrane of a fire-resistance-rated floor/ceiling or roof/ceiling assembly to limit automatically the radiative heat transfer through an air inlet/outlet opening.

**COMBINATION FIRE/SMOKE DAMPER.** A listed device installed in ducts and air transfer openings designed to close automatically upon the detection of heat and to also resist the passage of air and smoke. The device is installed to operate automatically, controlled by a smoke detection system, and where required, is capable of being positioned from a remote command station.

**CONCEALED SPACES.** Enclosed spaces within partitions, walls, floors, roofs, stairs, furring, pipe chases and column enclosures and other similar spaces.

**DAMPER.** See “Ceiling radiation damper,” “Combination fire/smoke damper,” “Fire damper” and “Smoke damper.”

**DRAFT STOP.** A material, device or construction installed to restrict the movement of air within open spaces of concealed areas of building components such as crawl spaces, floor/ceiling assemblies, roof/ceiling assemblies and attics.

**F RATING.** The time period that the through-penetration fire stop system limits the spread of fire through the penetration when tested in accordance with ASTM E 814.

**FIRE AREA.** The aggregate floor area enclosed and bounded by firewalls, fire barriers, exterior walls or fire-resistance-rated horizontal assemblies of a building.



**FIRE BARRIER.** A fire-resistance-rated vertical or horizontal assembly of materials complying with Section 706 designed to restrict the spread of fire in which openings are protected.

**FIRE DAMPER.** A listed device, installed in ducts and air transfer openings of an air distribution system or smoke control system, designed to close automatically upon detection of heat, to interrupt migratory airflow, and to restrict the passage of flame. Fire dampers are classified for use in either static systems that will automatically shut down in the event of a fire, or in a dynamic system that continues to operate during a fire. A dynamic fire damper is tested and rated for closure under airflow.

**FIRE DOOR.** The door component of a fire door assembly.

**FIRE DOOR ASSEMBLY.** Any combination of a fire door, frame, hardware, and other accessories that together, as an opening protective, provide a specific degree of fire protection to the opening.

**FIRE PARTITION.** A vertical assembly of materials complying with Section 708, designed to restrict the spread of fire in which openings are protected.

**FIRE PROTECTION RATING.** The period of time that an opening protective assembly will maintain the ability to confine a fire as determined by tests prescribed in Section 715. Ratings are stated in hours or minutes.

**FIRE RESISTANCE** That property of materials or their assemblies that prevents or retards the passage of excessive heat, hot gases or flames under conditions of use.

**FIRE-RESISTANCE RATING.** The period of time a building element, component or assembly maintains the ability to withstand fire exposure, continues to perform a given structural function, or both, as determined by the tests, or the methods based on tests, prescribed in Section 703.

**FIRE-RESISTANT JOINT SYSTEM.** An assemblage of specific materials or products that are designed, tested, and fire-resistance rated in accordance with either ASTM E 1966 or UL 2079 to resist for a prescribed period of time the passage of fire through joints made in or between fire-resistance-rated assemblies.

**FIRE SEPARATION DISTANCE.** The distance measured from the building face to the closest interior tax lot line, to the centerline of a street or other public space, or to an imaginary line between two buildings on the same tax lot. The distance shall be measured at right angles from the face of the wall.

**FIRE WALL.** A fire-resistance-rated smoke-tight wall having protected openings, which restricts the spread of fire and extends continuously from the foundation to or through the

roof, with sufficient structural stability under fire conditions to allow collapse of construction on either side without collapse of the wall.

**FIRE WINDOW ASSEMBLY.** A window, as an opening protective, constructed and glazed to give protection against the passage of fire, smoke, and hot gases.

**FIREBLOCKING.** A building material or an assembly of building materials that may or may not have a fire-resistance rating installed to resist the free passage of flame or hot gases to other areas of the building through concealed spaces in accordance with Section 717.

**FIRESTOPPING.** A through-penetration firestop or a membrane penetration firestop.

**FLOOR FIRE DOOR ASSEMBLY.** A combination of a fire door, a frame, hardware and other accessories installed, as an opening protective, in a horizontal plane, which together provide a specific degree of fire protection to a through opening in a fire-resistance-rated floor (see Section 712.4.6).

**MEMBRANE PENETRATION.** An opening made through one side (wall, floor or ceiling membrane) of an assembly.

**MEMBRANE PENETRATION FIRESTOP.** A material, device, or assemblage of specific materials or products that is designed, tested and fire-resistance rated to resist for a prescribed time period the passage of flame and heat through openings in a protective membrane in order to accommodate cables, cable trays, conduit, tubing, pipes or similar items.

**PENETRATION FIRESTOP.** A through-penetration firestop or a membrane penetration firestop.

**SELF-CLOSING.** As applied to a fire door or other opening, means equipped with an approved device that will ensure closing after having been opened.

**SHAFT.** An enclosed space extending through one or more stories of a building, connecting vertical openings in successive floors, or floors and roof.

**SHAFT ENCLOSURE.** The walls or construction forming the boundaries of a shaft.

**SMOKE BARRIER.** A continuous membrane, either vertical or horizontal, such as a wall, floor, or ceiling assembly, that is designed and constructed in accordance with Section 709 to restrict the movement of smoke.

**SMOKE COMPARTMENT.** A space within a building enclosed by smoke barriers on all sides, including the top and bottom.

**SMOKE DAMPER.** A listed device installed in ducts and air transfer openings that is designed to resist the passage of air and smoke. The device is installed to operate automatically, controlled by a smoke detection system, and where required, is capable of being positioned from a remote command station.

**SMOKE PARTITION.** A continuous vertical assembly that is designed and constructed to restrict the movement of smoke and is not generally required to have a fire-resistance rating in accordance with Section 710.

**T RATING.** The time period that the penetration firestop system, including the penetrating item, limits the maximum temperature rise to 325°F (163°C) above its initial temperature through the penetration on the nonfire side when tested in accordance with ASTM E 814.

**THROUGH PENETRATION.** An opening that passes through an entire assembly.

**THROUGH-PENETRATION FIRESTOP SYSTEM.** An assemblage of specific materials or products that are designed, tested and fire-resistance rated to resist for a prescribed period of time the spread of fire through penetrations. The F and T rating criteria for penetration firestop systems shall be in accordance with ASTM E 814. See definitions of “F rating” and “T rating.”

## **SECTION BC 703** **FIRE-RESISTANCE RATINGS AND FIRE TESTS**

**703.1 Scope.** Materials prescribed herein for fire resistance shall conform to the requirements of this chapter.

**703.2 Fire-resistance ratings.** The fire-resistance rating of building elements shall be determined in accordance with the test procedures set forth in ASTM E 119 or in accordance with Section 703.3. Where materials, systems or devices that have not been tested as part of a fire-resistance-rated assembly are incorporated into the assembly, sufficient data shall be made available to the commissioner to show that the required fire-resistance rating is not reduced. Materials and methods of construction used to protect joints and penetrations in fire-resistance- rated building elements shall not reduce the required fire-resistance rating.

**Exception:** In determining the fire-resistance rating of exterior bearing walls, compliance with the ASTM E 119 criteria for unexposed surface temperature rise and ignition of cotton waste due to passage of flame or gases is required only for a period of time corresponding to the required fire-resistance rating of an exterior nonbearing wall with the same fire separation distance, and in a building of the same group. When the fire-resistance rating determined in accordance with this exception exceeds the fire-resistance rating determined in accordance with ASTM E 119, the fire exposure time period, water pressure, and application duration criteria for the hose

stream test of ASTM E 119 shall be based upon the fire-resistance rating determined in accordance with this exception.

**703.2.1 Nonsymmetrical wall construction.** Interior walls and partitions of nonsymmetrical construction shall be tested with both faces exposed to the furnace, and the assigned fire-resistance rating shall be the shortest duration obtained from the two tests conducted in compliance with ASTM E 119. When evidence is furnished to show that the wall was tested with the least fire-resistant side exposed to the furnace, subject to acceptance of the commissioner, the wall need not be subjected to tests from the opposite side (see Section 704.5 for exterior walls).

**703.2.2 Combustible components.** Combustible aggregates may be integrated with other materials to form a non-combustible material provided that the entire mixture, in the form in which it is to be used in construction, meets the requirement of this code for noncombustible construction.

**703.2.3 Restrained classification.** Fire-resistance-rated assemblies tested under ASTM E 119 shall not be considered to be restrained unless evidence satisfactory to the commissioner is furnished by the registered design professional showing that the construction qualifies for a restrained classification in accordance with ASTM E 119. Restrained construction shall be identified on the plans.

**703.3 Alternative methods for determining fire resistance** The application of any of the alternative methods listed in this section shall be based on the fire exposure and acceptance criteria specified in ASTM E 119. The required fire resistance of a building element shall be permitted to be established by any of the following methods or procedures:

1. Fire-resistance designs documented in approved sources.
2. Prescriptive designs of fire-resistance-rated building elements as prescribed in Section 720.
3. Calculations in accordance with Section 721.
4. Engineering analysis based on a comparison of building element designs having fire-resistance ratings as determined by the test procedures set forth in ASTM E 119.
5. Alternative protection methods as allowed by Section 104.1.

**703.4 Noncombustibility tests.** The tests indicated in Sections 703.4.1 and 703.4.2 shall serve as criteria for acceptance of building materials as set forth in Sections 602.2, 602.3 and 602.4 in Type I, II, III and IV construction. The term “noncombustible” does not apply to the flame spread characteristics of interior finish or trim materials. A material

shall not be classified as a noncombustible building construction material if it is subject to an increase in combustibility or flame spread beyond the limitations herein established through the effects of age, fabrication or erection techniques, moisture or other atmospheric conditions.

**703.4.1 Elementary materials.** Materials required to be noncombustible shall be tested in accordance with ASTM E 136.

**703.4.2 Composite materials.** Materials having a structural base of noncombustible material as determined in accordance with Section 703.4.1 with a surfacing not more than 0.125 inch (3.18 mm) thick that has a flame spread index not greater than 50 when tested in accordance with ASTM E 84 shall be acceptable as noncombustible materials.

## **SECTION BC 704** **EXTERIOR WALLS**

**704.1 General.** Exterior walls shall be fire-resistance rated and have opening protection as required by this section. Exterior wall construction shall comply with the provisions of Chapter 14 and Appendix D where applicable.

**704.2 Projections.** Cornices, eave overhangs, exterior balconies and similar architectural appendages, including but not limited to, fascias, belt courses, pilasters, surrounds, gutters, leaders, half-timber work, shutters, trellises, which extend beyond the floor area shall conform to the requirements of this section and Section 1406, provided, if removed or destroyed, will not reduce the structural stability of the building enclosure, and installed so as not to reduce the required fire resistance rating of the enclosure. Exterior egress balconies and exterior exit stairways shall comply with the requirements of this section, Section 1013.5, and Section 1022.1. Projections shall not extend beyond the distance determined by the following two methods, whichever results in the lesser projection:

1. A point one-third the distance to the lot line from an assumed vertical plane located where protected openings are required in accordance with Section 704.8.
2. More than 12 inches (305mm) into areas where openings are prohibited.

**704.2.1 Type III, IV or V construction.** Projections from walls of Type III, IV or V construction shall be of any approved material.

**704.2.2 Combustible projections.** Combustible projections located where openings are not permitted or where protection of openings is required shall be of at least 1-hour fire-resistance-rated construction, Type IV construction, or as required by Section 1406.3.

**704.3 Buildings on the same lot.** For the purposes of determining the required wall and opening protection and roof-covering requirements, buildings on the same tax lot shall be assumed to have an imaginary line between them.

**Exception:** Two or more buildings on the same tax lot shall either be regulated as separate buildings or shall be considered as portions of one building if the aggregate area of such buildings is within the limits specified in Chapter 5 for a single building. Where the buildings contain different occupancy groups or are of different types of construction, the area shall be that allowed for the most restrictive occupancy or construction.

**704.4 Materials.** Exterior walls shall be of materials permitted by the building type of construction.

**704.5 Fire-resistance ratings.** Exterior walls shall be fire-resistance rated in accordance with Tables 601, 602, and Appendix D where applicable. The fire-resistance rating of exterior walls with a fire-separation distance of greater than 5 feet (1524 mm) shall be rated for exposure to fire from the inside. The fire-resistance rating of exterior walls with a fire-separation distance of 5 feet (1524 mm) or less shall be rated for exposure to fire from both sides.

**704.6 Structural stability.** The wall shall extend to the height required by Section 704.11 and shall have sufficient structural stability such that it will remain in place for the duration of time indicated by the required fire-resistance rating.

**704.7 Unexposed surface temperature.** Where protected openings are not limited by Section 704.8, the limitation on the rise of temperature on the unexposed surface of exterior walls as required by ASTM E 119 shall not apply. Where protected openings are limited by Section 704.8, the limitation on the rise of temperature on the unexposed surface of exterior walls as required by ASTM E 119 shall not apply provided that a correction is made for radiation from the unexposed exterior wall surface in accordance with the following formula:

**(Equation 7-1 attached to end of document)**

**FIGURE 704.7**  
**EQUIVALENT OPENING FACTOR**  
**(Figure 704.7 attached to end of document)**

**704.8 Allowable area of openings.** The maximum area of unprotected or protected openings permitted in an exterior wall in any story shall not exceed the values set forth in Table 704.8. Where both unprotected and protected openings are located in the exterior wall in any story, the total area of the openings shall comply with the following formula:

**(Equation 7-2 attached to end of document)**

**TABLE 704.8**  
**MAXIMUM AREA OF EXTERIOR WALL OPENINGS<sup>a</sup>**  
**(Table 704.8 revised and attached to end of document)**

**704.8.1 Automatic sprinkler system.** In buildings equipped throughout with an automatic sprinkler system in accordance with Section 903.3.1.1, the maximum allowable area of unprotected openings in occupancies other than Groups H-1, H-2 and H-3 shall be the same as the tabulated limitations for protected openings.

**704.8.2 First story.** In occupancies other than Group H, unlimited unprotected openings are permitted in the first story of exterior walls facing a street that have a fire separation distance of greater than 15 feet (4572 mm), or facing an unoccupied space. The unoccupied space shall be on the same lot or dedicated for public use, shall not be less than 30 feet (9144 mm) in width, and shall have access from a street by a posted fire lane in accordance with the *New York City Fire Code*.

**704.9 Vertical separation of openings.** Openings in exterior walls in adjacent stories shall be separated vertically to protect against fire spread on the exterior of the buildings where the openings are within 5 feet (1524 mm) of each other horizontally in accordance with Section 715.4.8. Such openings shall be separated vertically at least 3 feet (914 mm) by spandrel girders, exterior walls or other similar assemblies that have a fire-resistance rating of at least 1 hour or by flame barriers that extend horizontally at least 30 inches (762 mm) beyond the exterior wall and that are at least as wide as the opening. Flame barriers shall also have a fire-resistance rating of at least 1 hour. The unexposed surface temperature limitations specified in ASTM E 119 shall not apply to the flame barriers or vertical separation unless otherwise required by the provisions of this code. Where a curtain wall assembly is used on the exterior wall, the intersection between the floor assembly and curtain wall assembly shall be protected in accordance with Section 713.4.

**Exceptions:**

1. This section shall not apply to buildings that are three stories or less in height.
2. This section shall not apply to buildings equipped throughout with an automatic sprinkler system in accordance with Section 903.3.1.1 or 903.3.1.2.
3. This section shall not apply to open parking garages.
4. This section shall not apply to buildings where the main use or dominant occupancy is classified as Occupancy Group A, E, I, or R.

**704.10 Vertical exposure.** For buildings on the same tax lot, approved protectives shall be provided in every opening that is less than 15 feet (4572 mm) vertically above the roof of an adjoining building or adjacent structure that is within a horizontal fire-separation

distance of 15 feet (4572 mm) of the wall in which the opening is located.

**Exception:** Opening protectives are not required where the roof construction has a fire-resistance rating of not less than 1 hour for a minimum distance of 10 feet (3048 mm) from the adjoining building and the entire length and span of the supporting elements for the fire-resistance-rated roof assembly has a fire-resistance rating of not less than 1 hour.

**704.11 Parapets.** Parapets shall be provided on exterior walls of buildings.

**Exceptions:** A parapet need not be provided on an exterior wall where any of the following conditions exist:

1. The wall is not required to be fire-resistance rated in accordance with Table 602 because of fire separation distance.
2. The building has an area of not more than 1,000 square feet (93 m<sup>2</sup>) on every floor.
3. Walls that terminate at roofs of not less than 2-hour fire-resistance-rated construction.
4. One-hour fire-resistance-rated exterior walls that terminate at the underside of the roof sheathing, deck or slab, provided that the entire building is covered with a Class A roof covering. Such roof shall not have openings located within 10 feet (3048 mm) of the 1-hour fire-resistance-rated exterior wall and not within 5 feet (1524 mm) for Groups R and U.
  - 4.1. Where the roof/ceiling framing elements are parallel to the walls, such framing and elements supporting such framing shall not be of less than 1-hour fire-resistance-rated construction for a width of 4 feet (1219 mm) measured from the interior side of the wall for Groups R and U and 10 feet (3048 mm) for other occupancies; or
  - 4.2. Where roof/ceiling framing elements are not parallel to the wall, the entire span of such framing and elements supporting such framing shall not be of less than 1-hour fire-resistance-rated construction.
5. In occupancies of Groups R-2 and R-3, both provided with a Class A or B roof covering, the exterior wall shall be permitted to terminate at the roof sheathing or deck in Type III, IV and V construction provided:



- 5.1. The roof sheathing or deck is constructed of approved noncombustible materials or of fire-retardant-treated wood, for a distance of 4 feet (1219 mm) from the perimeter; or
- 5.2. The roof is protected with 0.625-inch (15.88 mm) Type X gypsum board directly beneath the underside of the roof sheathing or deck, supported by a minimum of nominal 2-inch (51 mm) ledgers attached to the sides of the roof framing members, for a minimum distance of 4 feet (1219 mm).
6. Where the wall is permitted to have at least 25 percent of the exterior wall areas containing unprotected openings based on fire separation distance as determined in accordance with Section 704.8.

**704.11.1 Parapet construction.** Parapets shall have the same fire-resistance rating as that required for the supporting wall, and on any side adjacent to a roof surface, shall have noncombustible faces for the uppermost 18 inches (457 mm), including counterflashing and coping materials. The height of the parapet shall not be less than 30 inches (762 mm) above the point where the roof surface and the wall intersect. Where the roof slopes toward a parapet at a slope greater than two units vertical in 12 units horizontal (16.7-percent slope), the parapet shall extend to the same height as any portion of the roof within a fire separation distance where protection of wall openings is required, but in no case shall the height be less than 30 inches (762 mm).

**704.12 Opening protection.** Windows required to be protected in accordance with Section 704.8, 704.9, or 704.10 shall comply with Section 715.4.8. Other openings required to be protected with fire doors or shutters in accordance with Sections 704.8, 704.9 and 704.10 shall comply with Section 715.3.

**Exception:** Fire protective assemblies are not required where the building is protected throughout by an automatic sprinkler system and the exterior openings are protected by an approved water curtain using automatic sprinklers approved for that use. The sprinklers and the water curtain shall be installed in accordance with NFPA 13, as modified in Appendix Q.

**704.12.1 Unprotected openings.** Where protected openings are not required by Section 704, windows and doors shall be constructed of any approved materials. Glazing shall conform to the requirements of Chapters 24 and 26.

**704.13 Joints.** Joints made in or between exterior walls required by this section to have a fire-resistance rating shall comply with Section 713.

**Exception:** Joints in exterior walls that are permitted to have unprotected openings.

**704.13.1 Voids.** The void created at the intersection of a floor/ceiling assembly and

an exterior curtain wall assembly shall be protected in accordance with Section 713.4.

**704.14 Ducts and air transfer openings.** Penetrations by air ducts and air transfer openings in fire-resistance-rated exterior walls required to have protected openings shall comply with Section 716.

**Exception:** Foundation vents installed in accordance with this code are permitted.

## **SECTION BC 705** **FIRE WALLS**

**705.1 General.** Each portion of a building separated by one or more fire walls that comply with the provisions of this section shall be considered a separate building. The extent and location of such fire walls shall provide a complete separation. Where a fire wall also separates groups that are required to be separated by a fire barrier wall, the most restrictive requirements of each separation shall apply. Concealed spaces in cornices and eaves shall comply with the provisions of Section 705.5.2.

**705.1.1 Party walls.** Any wall located on a property line between adjacent buildings, which is used or adapted for joint service between the two buildings, shall be constructed as a fire wall in accordance with Section 705, and shall create separate buildings.

**705.1.2 Walls separating attached one- and two-family dwellings.** Attached one- and two-family dwellings shall be separated by walls constructed in accordance with Section 705 or Appendix M.

**705.2 Structural stability.** Fire walls shall have sufficient structural stability under fire conditions to allow collapse of construction on either side without collapse of the wall for the duration of time indicated by the required fire-resistance rating.

**705.3 Materials.** Fire walls shall be constructed of any approved noncombustible materials.

**705.4 Fire-resistance rating.** Fire walls shall have a fire-resistance rating of not less than that required by Table 705.4.

### **TABLE 705.4** **FIRE WALL FIRE-RESISTANCE RATINGS GROUP FIRE-RESISTANCE** **RATING (hours)**

**(Table 705.4 attached to end of document)**

**705.5 Horizontal continuity.** Fire walls shall be continuous from exterior wall to exterior wall and shall extend at least 18 inches (457 mm) beyond the exterior surface of exterior walls.

**Exceptions:**

1. Fire walls shall be permitted to terminate at the interior surface of combustible exterior sheathing or siding provided the exterior wall has a fire-resistance rating of at least 1 hour for a horizontal distance of at least 4 feet (1219 mm) on both sides of the fire wall. Openings within such exterior walls shall be protected by fire assemblies having a fire protection rating of not less than  $\frac{3}{4}$  hour.
2. Fire walls shall be permitted to terminate at the interior surface of noncombustible exterior sheathing, exterior siding or other noncombustible exterior finishes provided the sheathing, siding, or other exterior noncombustible finish extends a horizontal distance of at least 4 feet (1219 mm) on both sides of the fire wall.
3. Fire walls shall be permitted to terminate at the interior surface of noncombustible exterior sheathing where the building on each side of the fire wall is protected by an automatic sprinkler system installed in accordance with Section 903.3.1.1 or 903.3.1.2.

**705.5.1 Exterior walls.** Where the fire wall intersects the exterior walls, the fire-resistance rating for the exterior walls on both sides of the fire wall shall have a 1-hour fire-resistance rating with  $\frac{3}{4}$ -hour opening protection where opening protection is required. The fire-resistance rating of the exterior wall shall extend a minimum of 4 feet (1219 mm) on each side of the intersection of the fire wall to exterior wall. Exterior wall intersections at fire walls that form an angle equal to or greater than 180 degrees (3.14 rad) do not need exterior wall protection.

**705.5.2 Horizontal projecting elements.** Fire walls shall extend to the outer edge of horizontal projecting elements such as balconies, roof overhangs, canopies, marquees and architectural projections that are within 4 feet (1219 mm) of the fire wall.

**Exceptions:**

1. Noncombustible horizontal projecting elements without concealed spaces provided the exterior wall behind and below the projecting element has not less than 1-hour fire-resistance-rated construction for a distance not less than the depth of the projecting element on both sides of the fire wall. Openings within such exterior walls shall be protected by fire assemblies having a fire protection rating of not less than  $\frac{3}{4}$  hour.
2. Noncombustible horizontal projecting elements with concealed spaces, provided a minimum 1-hour fire-resistance-rated wall extends through the concealed space. The projecting element shall be separated from the

building by a minimum of 1-hour fire-resistance-rated construction for a distance on each side of the firewall equal to the depth of the projecting element. The wall is not required to extend under the projecting element where the building exterior wall is a minimum of 1-hour fire-resistance rated for a distance on each side of the firewall equal to the depth of the projecting element. Openings within such exterior walls shall be protected by fire assemblies having a fire protection rating of not less than ¾ hour.

**705.6 Vertical continuity.** Fire walls shall extend from the foundation through the roof, to form a parapet at least 30 inches (762 mm) in height. Such parapet shall in no event extend to a point less than 4 inches (102 mm) above the highest point of peaked or gabled roof.

**Exceptions:**

1. Where a two-hour fire wall is permitted in accordance with Table 705.4, such wall shall be permitted to terminate at the underside of the roof sheathing, deck or slab provided:
  - 1.1. The lower roof assembly within 4 feet (1219 mm) of the wall has not less than a 1-hour fire-resistance rating and the entire length and span of supporting elements for the rated roof assembly has a fire-resistance rating of not less than 1 hour; and
  - 1.2. Openings in the roof shall not be located within 4 feet (1219 mm) of the fire wall; and
  - 1.3. Each building shall be provided with not less than a Class A roof covering.
2. In buildings of Type I or II constructions, fire walls shall be permitted to terminate at the underside of noncombustible roof sheathing, deck, or slabs where both buildings are provided with not less than a Class A roof covering. Openings in the roof shall not be located within 4 feet (1219 mm) of the fire wall.
3. In buildings of Type III, IV and V construction, fire walls shall be permitted to terminate at the underside of noncombustible roof sheathing or decks provided:
  - 3.1. There are no openings in the roof within 4 feet (1219 mm) of the fire wall; and
  - 3.2. The roof is covered with a minimum Class A roof covering.

4. Buildings located above a parking garage designed in accordance with Section 508.2 shall be permitted to have the fire walls for the buildings located above the parking garage extend from the horizontal separation between the parking garage and the buildings.

**705.7 Combustible framing in fire walls.** Adjacent combustible members entering into a concrete or masonry firewall from opposite sides shall not have less than a 4-inch (102 mm) distance between embedded ends. Where combustible members frame into hollow walls or walls of hollow units, hollow spaces shall be solidly filled for the full thickness of the wall and for a distance not less than 4 inches (102 mm) above, below and between the structural members, with noncombustible materials approved for fire blocking.

**705.8 Openings.** Each opening through a fire wall, a party wall, or a through wall between two buildings shall be protected in accordance with Section 715.3 and shall not exceed 120 square feet (11 m<sup>2</sup>), with no dimension greater than 12 feet (3658 mm). The aggregate width of openings at any floor level shall not exceed 25 percent of the length of the wall.

**Exception:** Openings shall not be limited to 120 square feet (11 m<sup>2</sup>) where both buildings are equipped throughout with an automatic sprinkler system installed in accordance with Section 903.3.1.1. However, the aggregate width of all openings at any one floor level shall not exceed 25 percent of the length of the wall.

**705.9 Penetrations.** Penetrations through fire walls shall comply with Section 712.

**705.10 Joints.** Joints made in or between fire walls shall comply with Section 713.

**705.11 Ducts and air transfer openings.** Ducts and air transfer openings shall not penetrate fire walls.

**Exception:** Penetrations by ducts and air transfer openings of fire walls that are not on a tax lot line shall be allowed provided the penetrations comply with Sections 712 and 716. The size and aggregate width of all openings shall not exceed the limitations of Section 705.8.

## **SECTION BC 706** **FIRE BARRIERS**

**706.1 General.** Fire barriers used for separation of shafts, exits, exit passageways, horizontal exits or incidental use areas, to separate different occupancies, to separate a single occupancy into different fire areas, or to separate other areas where a fire barrier is required elsewhere in this code or the *New York City Fire Code*, shall comply with this section.

**706.2 Materials.** The walls and floor assemblies shall be of materials permitted by the

building type of construction.

**706.3 Fire-resistance rating.** The fire-resistance rating of the walls and floor assemblies shall comply with this section.

**706.3.1 Shaft enclosures.** The fire-resistance rating of the fire barrier separating building areas from a shaft shall comply with Section 707.4.

**706.3.2 Exit enclosures.** The fire-resistance rating of the fire barrier separating building areas from an exit shall comply with Section 1019.1.

**706.3.3 Exit passageway.** The fire-resistance rating of the separation between building areas and an exit passageway shall comply with Section 1020.1.

**706.3.4 Horizontal exit.** The fire-resistance rating of the separation between building areas connected by a horizontal exit shall comply with Section 1021.1.

**706.3.5 Incidental use areas.** The fire barrier separating incidental use areas shall have a fire-resistance rating of not less than that indicated in Table 302.1.1.

**706.3.6 Separation of mixed occupancies.** Where the provisions of Section 302.3.2 are applicable, the fire barrier separating mixed occupancies shall have a fire-resistance rating of not less than that indicated in Section 302.3.2 based on the occupancies being separated.

**706.3.7 Single-occupancy fire areas.** The fire barrier separating a single occupancy into different fire areas shall have a fire-resistance rating of not less than that indicated in Table 706.3.7.

**TABLE 706.3.7**  
**FIRE-RESISTANCE RATING REQUIREMENTS FOR FIRE BARRIER**  
**ASSEMBLIES BETWEEN FIRE AREAS OCCUPANCY GROUP FIRE-**  
**RESISTANCE RATING (hours)**  
**(Table 706.3.7 attached to end of document)**

**706.3.8 Atriums.** The fire-resistance rating of the fire barrier separating atriums shall comply with Section 404.5.

**706.4 Continuity of fire barrier walls.** Fire barrier walls shall extend from the top of the floor/ceiling assembly below to the underside of the floor or roof slab or deck above and shall be securely attached thereto. These walls shall be continuous through concealed spaces such as the space above a suspended ceiling. The supporting construction for fire barrier walls shall be protected to afford the required fire-resistance rating of the fire barrier supported except for 1-hour fire-resistance-rated incidental use area separations as required by Table 302.1.1 in buildings of Type IIB, IIIB and VB construction. Hollow

vertical spaces within the fire barrier wall shall be fire-stopped at every floor level.

**Exceptions:**

1. The maximum required fire-resistance rating for assemblies supporting fire barriers separating tank storage as provided for in Section 415.7.2.1 shall be 2 hours, but not less than required by Table 601 for the building construction type.
2. Shaft enclosure shall be permitted to terminate at a top enclosure complying with Section 707.12.

**706.5 Horizontal fire barriers.** Horizontal fire barriers shall be constructed in accordance with Section 711.

**706.6 Exterior walls.** Where exterior walls serve as a part of a required fire-resistance-rated enclosure, such walls shall comply with the requirements of Section 704 for exterior walls, and the fire-resistance-rated enclosure requirements of Section 706 shall not apply.

**Exception:** Exterior walls required to be fire-resistance rated in accordance with Section 1022.6.

**706.7 Openings.** Openings in a fire barrier wall shall be protected in accordance with Section 715. Openings shall be limited to a maximum aggregate width of 25 percent of the length of the wall, and the maximum area of any single opening shall not exceed 120 square feet (11 m<sup>2</sup>). Openings in vertical exit enclosures and exit passageways shall also comply with Sections 1019.1.1 and 1020.4, respectively.

**Exceptions:**

1. Openings shall not be limited to 120 square feet (11 m<sup>2</sup>) where adjoining fire areas are equipped throughout with an automatic sprinkler system in accordance with Section 903.3.1.1.
2. Openings for fire doors serving an exit enclosure shall not be limited to an aggregate width of 25 percent of the length of the wall.
3. Openings shall not be limited to 120 square feet (11 m<sup>2</sup>) or an aggregate width of 25 percent of the length of the wall where the opening protective assembly has been tested in accordance with ASTM E 119 and has a minimum fire-resistance rating not less than the fire-resistance rating of the wall.
4. Openings permitted in atrium enclosures shall comply with the provisions of Section 404.5.

**706.8 Penetrations.** Penetrations through fire barriers shall comply with Section 712.

**706.8.1 Prohibited penetrations.** Penetrations into an exit enclosure shall only be allowed when permitted by Sections 1019.12 and 1020.5.

**706.9 Joints.** Joints made in or between fire barriers shall comply with Section 713.

**706.10 Ducts and air transfer openings.** Penetrations by ducts and air transfer openings shall comply with Sections 712 and 716.

**706.10.1 Prohibited ducts and air transfer openings.** Penetrations by ducts and air transfer openings into an exit enclosure shall only be allowed when permitted by Sections 1019.1.2 and 1020.5.

## **SECTION BC 707** **SHAFT ENCLOSURES**

**707.1 General.** The provisions of this section shall apply to vertical shafts where such shafts are required to protect openings and penetrations through floor/ceiling and roof/ceiling assemblies.

**707.2 Shaft enclosure required.** Openings through a floor/ceiling assembly shall be protected by a shaft enclosure complying with this section.

### **Exceptions:**

- 1. A shaft enclosure is not required for openings totally within an individual residential dwelling unit and connecting four stories or less where such dwelling unit is fully sprinklered in accordance with Section 903.3.1.1, 903.3.1.2 or 903.3.1.3.**
- 2. A shaft enclosure is not required in a building equipped throughout with an automatic sprinkler system in accordance with Section 903.3.1.1 for an escalator opening or stairway which is not a portion of the means of egress protected according to Item 2.1 or 2.2:**
  - 2.1. Where the area of the floor opening between stories does not exceed twice the horizontal projected area of the escalator or stairway and the opening is protected by a draft curtain and closely spaced sprinklers in accordance with NFPA 13, as modified in Appendix Q. In other than Groups B and M, this application is limited to openings that do not connect more than four stories.**
  - 2.2. Where the opening is protected by approved power-operated automatic shutters at every floor penetrated. The shutters shall be of**



noncombustible construction and have a fire-resistance rating of not less than 1.5 hours. The shutter shall be so constructed as to close immediately upon the actuation of a smoke detector installed in accordance with Section 907.11 and shall completely shut off the well opening. Escalators shall cease operation when the shutter begins to close. The shutter shall operate at a speed of not more than 30 feet per minute (152.4 mm/s) and shall be equipped with a sensitive leading edge to arrest its progress where in contact with any obstacle, and to continue its progress on release therefrom.

3. A shaft enclosure is not required for penetrations by pipe, tube, conduit, wire, cable, and vents protected in accordance with Section 712.4.
4. A shaft enclosure is not required for penetrations by ducts protected in accordance with Section 712.4. Grease ducts shall be protected in accordance with the *New York City Mechanical Code*.
5. In other than Group H Occupancies, a shaft enclosure is not required for floor openings complying with the provisions for atriums in Section 404.
6. A shaft enclosure is not required for approved masonry chimneys, where annular space protection is provided at each floor level in accordance with Section 717.2.5.
7. In other than Groups I-2 and I-3, a shaft enclosure is not required for a floor opening that complies with all of the following:
  - 7.1. Does not connect more than two stories.
  - 7.2. Is not part of the required means of egress system except as permitted in Section 1019.1.
  - 7.3. Is not concealed within the building construction.
  - 7.4. Is not open to a corridor in Group I and R occupancies where such corridor is required to be fire-resistance rated in accordance with Table 1016.1.
  - 7.5. Is not open to a corridor on nonsprinklered floors in any occupancy where such corridor is required to be fire-resistance rated in accordance with Table 1016.1.
  - 7.6. Is separated from floor openings serving other floors by construction conforming to required shaft enclosures.

8. A shaft enclosure is not required for automobile ramps in open parking garages and enclosed parking garages constructed in accordance with Sections 406.3 and 406.4, respectively.
9. A shaft enclosure is not required for floor openings between a mezzanine and the floor below.
10. A shaft enclosure is not required for joints protected by a fire-resistant joint system in accordance with Section 713.
11. Where permitted by other sections of this code.

**707.3 Materials.** The shaft enclosure shall be of materials permitted by the building type of construction.

**Exception:** Noncombustible materials shall be used for shaft enclosures in Groups I-1, R-1 and R-2 buildings irrespective of the building type of construction.

**707.4 Fire-resistance rating.** Shaft enclosures shall have a fire-resistance rating of not less than 2 hours where penetrating three stories or more and not less than 1 hour where penetrating fewer than three stories. The number of stories connected by the shaft enclosure shall include any basements or cellars, but not any mezzanines. Shaft enclosures shall be constructed as fire barriers in accordance with Section 706. Shaft enclosures shall have a fire-resistance rating not less than the floor assembly penetrated, but need not exceed 2 hours.

**707.5 Continuity.** Where the roof construction is of combustible materials, shaft enclosure walls shall extend through the roof construction at least 30 inches (762 mm) above the roof. Where the roof construction is of noncombustible materials, shaft enclosure walls shall extend from the top of the floor/ceiling assembly below to the underside of the floor or roof slab or deck above and shall be securely attached thereto. These walls shall be continuous through concealed spaces such as the space above a suspended ceiling. The supporting construction shall be protected to afford the required fire-resistance rating of the element supported. Hollow vertical spaces within the shaft enclosure construction wall shall be firestopped at every floor level.

**Exception:** A shaft enclosure of a refuse or laundry chute shall extend through combustible or noncombustible roof construction at least 6 feet (1829 mm) above the roof.

**707.6 Exterior walls.** Where exterior walls serve as a part of a required shaft enclosure, such walls shall comply with the requirements of Section 704 for exterior walls and the fire-resistance-rated enclosure requirements of Section 707.4 shall not apply.

**Exception:** Exterior walls required to be fire-resistance rated in accordance with

Section 1022.6.

**707.7 Openings.** Openings in a shaft enclosure shall be protected in accordance with Section 715 as required for fire barriers. Such openings shall be self-closing or automatic-closing by smoke detection. Automatic-closing by smoke detection is not permitted for required vertical exit doors.

**707.7.1 Prohibited openings.** Openings other than those necessary for the purpose of the shaft shall not be permitted in shaft enclosures.

**707.8 Penetrations.** Penetrations in a shaft enclosure shall be protected in accordance with Section 712 as required for fire barriers.

**707.8.1 Prohibited penetrations.** Penetrations other than those necessary for the purpose of the shaft shall not be permitted in shaft enclosures.

**Exception:** Duct penetrations in accordance with Section 707.10, as permitted in Sections 1019.1.2, 1019.1.3, and 1020.5.

**707.9 Joints.** Joints in a shaft enclosure shall comply with Section 713.

**707.10 Ducts and air transfer openings.** Penetrations of a shaft enclosure by ducts and air transfer openings shall comply with Sections 712 and 716.

**707.11 Enclosure at the bottom.** Shafts that do not extend to the bottom of the building or structure shall:

1. Be enclosed at the lowest level with construction of the same fire-resistance rating as the lowest floor through which the shaft passes, but not less than the rating required for the shaft enclosure; or
2. Terminate in a room having a use related to the purpose of the shaft. The room shall be separated from the remainder of the building by construction having a fire-resistance rating and opening protectives at least equal to the protection required for the shaft enclosure.

**Exceptions:**

1. The fire-resistance-rated room separation is not required provided there are no openings in or penetrations of the shaft enclosure to the interior of the building except at the bottom. The bottom of the shaft shall be closed off around the penetrating items with materials permitted by Section 717.3.1 for draft stopping, or the room shall be provided with an approved automatic fire suppression system.

2. A shaft enclosure containing a refuse chute or laundry chute shall not be used for any other purpose and shall terminate in a room protected in accordance with Section 707.13.4.
3. The fire-resistance-rated room separation and the protection at the bottom of the shaft are not required provided there are no combustibles in the shaft and there are no openings or other penetrations through the shaft enclosure to the interior of the building.

**707.12 Enclosure at the top.** A shaft enclosure that does not extend to the underside of the roof deck of the building shall be enclosed at the top with construction of the same fire-resistance rating as the topmost floor penetrated by the shaft, but not less than the fire-resistance rating required for the shaft enclosure.

**707.13 Refuse and laundry chutes.** Refuse and laundry chutes, access and termination rooms and incinerator rooms shall meet the requirements of Sections 707.13.1 through 707.13.6.

**Exception:** Chutes serving and contained within a single dwelling unit.

**707.13.1 Refuse and laundry chute enclosures.** A shaft enclosure containing a refuse or laundry chute shall not be used for any other purpose and shall have a fire-resistance rating of 2 hours. Openings into the shaft, including those from access rooms and termination rooms, shall be protected in accordance with this section and Section 715. Openings into chutes shall not be located in exit access corridors. Opening protectives shall be self-closing.

**707.13.2 Materials.** A shaft enclosure containing a refuse or laundry chute shall be constructed of noncombustible materials.

**707.13.3 Refuse and laundry chute access rooms.** Access openings for refuse and laundry chutes shall be located in dedicated rooms or compartments completely enclosed by construction that has a fire-resistance rating of not less than 2 hours. Openings into the access rooms shall be protected by opening protectives having a fire protection rating of not less than 1½ hour and shall be self-closing. Openings may be automatic-closing upon the detection of smoke provided that the storage of refuse, including recyclables, or laundry is not permitted in such access rooms.

**Exception:** Access openings for refuse or laundry chutes located within a dwelling unit need not be located within a separate room or compartment.

**707.13.4 Termination room.** Refuse and laundry chutes shall discharge into an enclosed room completely separated from the remainder of the building by construction that has a fire-resistance rating of not less than 3 hours. Openings into the termination room shall be protected by opening protectives having a fire

protection rating of not less than 3 hours and shall be self-closing.

**707.13.5 Incinerator room.** Incinerator rooms shall comply with Table 302.1.1.

**707.13.6 Automatic fire sprinkler system.** An approved automatic fire sprinkler system shall be installed in accordance with Section 903.2.10.2.

**707.14 Elevator and dumbwaiter shafts.** Elevator hoist way and dumbwaiter enclosures shall be constructed in accordance with Section 707.4 and Chapter 30.

**707.14.1 Elevator lobby.** Elevator lobbies shall be provided in accordance with Section 403.9.1.

## **SECTION BC 708** **FIRE PARTITIONS**

**708.1 General.** The following wall assemblies shall comply with this section.

1. Walls separating tenant spaces in covered mall buildings as required by Section 402.7.2.
2. Walls as required by Section 1016.1.

**708.2 Materials.** The walls shall be of materials permitted by the building type of construction.

**708.3 Fire-resistance rating.** The fire-resistance rating of the walls shall be 1 hour.

**Exception:** Interior corridor walls as permitted by Table 1016.1.

**708.4 Continuity.** Fire partitions shall extend from the top of the floor assembly below to the underside of the floor or roof slab or deck above or to the fire-resistance-rated floor/ceiling or roof/ceiling assembly above, and shall be securely attached thereto. If the partitions are not continuous to the deck, the space between the ceiling and the deck above shall be fire blocked or draft stopped in accordance with Sections 717.2.1 and 717.3.1 at the partition line. The supporting construction shall be protected to afford the required fire-resistance rating of the wall supported.

### **Exceptions:**

1. The fire partition separating tenant spaces in a mall, complying with Section 402.7.2, is not required to extend beyond the underside of a ceiling that is not part of a fire-resistance-rated assembly. A wall is not required in attic or ceiling spaces above tenant separation walls.

2. Fire blocking or draft stopping is not required at the partition line in Group R-2 buildings that do not exceed four stories in height provided the attic space is subdivided by draft stopping into areas not exceeding 3,000 square feet (279 m<sup>2</sup>) or above every two dwelling units, whichever is smaller.
3. Fire blocking or draft stopping is not required at the partition line in buildings equipped with an automatic sprinkler system installed throughout in accordance with Section 903.3.1.1 or 903.3.1.2 provided that automatic sprinklers are installed in combustible floor/ceiling and roof/ceiling spaces.

**708.5 Exterior walls.** Where exterior walls serve as a part of a required fire-resistance-rated enclosure, such walls shall comply with the requirements of Section 704 for exterior walls and the fire-resistance-rated enclosure requirements of Section 708.3 shall not apply.

**708.6 Openings.** Openings in a fire partition shall be protected in accordance with Section 715.

**708.7 Penetrations.** Penetrations through fire partitions shall comply with Section 712.

**708.8 Joints.** Joints made in or between fire partitions shall comply with Section 713.

**708.9 Ducts and air transfer openings.** Penetrations by ducts and air transfer openings shall comply with Sections 712 and 716.

## **SECTION BC 709** **SMOKE BARRIERS**

**709.1 General.** Smoke barriers shall comply with this section.

**709.2 Materials.** Smoke barriers shall be of materials permitted by the building type of construction.

**709.3 Fire-resistance rating.** A 1-hour fire-resistance rating is required for smoke barriers.

**Exception:** Smoke barriers constructed of minimum 0.10-inch-thick (2.5 mm) steel in Group I-3 buildings.

**709.4 Continuity.** Smoke barriers shall form an effective membrane continuous from outside wall to outside wall and from floor slab to floor or roof deck above, including continuity through concealed spaces, such as those found above suspended ceilings, and interstitial structural and mechanical spaces. The supporting construction shall be protected to afford the required fire-resistance rating of the wall or floor supported in buildings of other than Type IIB, IIIB or VB construction.

**Exception:** Smoke barrier walls are not required in interstitial spaces where such spaces are designed and constructed with ceilings that provide resistance to the passage of fire and smoke equivalent to that provided by the smoke barrier walls.

**709.5 Openings.** Openings in a smoke barrier shall be protected in accordance with Section 715.

**Exception:** In Group I-2, where such doors are installed across corridors, a pair of opposite-swinging doors without a center mullion shall be installed having vision panels with approved fire-resistance-rated glazing materials in approved fire-resistance-rated frames, the area of which shall not exceed that tested. The doors shall be close fitting within operational tolerances, and shall not have undercuts, louvers or grilles. The doors shall have head and jamb stops, astragals or rabbets at meeting edges and automatic-closing devices. Positive-latching devices are not required.

**709.6 Penetrations.** Penetrations through smoke barriers shall comply with Section 712.

**709.7 Joints.** Joints made in or between smoke barriers shall comply with Section 713.

**709.8 Duct and air transfer openings.** Penetrations by duct and air transfer openings shall comply with Sections 712 and 716.

## **SECTION BC 710** **SMOKE PARTITIONS**

**710.1 General.** Smoke partitions installed as required elsewhere in the code shall comply with this section.

**710.2 Materials.** Smoke partitions shall be constructed of noncombustible materials. Glazing may be used provided it is heat-strengthened or tempered glazing complying and shall otherwise comply with Chapter 24, and shall be protected by sprinkler heads installed in a maximum of 6 feet (1829 mm) on center on each side of the smoke partition.

**710.3 Fire-resistance rating.** Unless required elsewhere in the code, smoke partitions are not required to have a fire-resistance rating.

**710.4 Continuity.** Smoke partitions shall extend from the floor to the underside of the floor or roof deck above or to the underside of the ceiling above where the ceiling membrane is constructed to limit the transfer of smoke.

**710.5 Openings.** Windows shall be sealed to resist the free passage of smoke or be automatic-closing upon detection of smoke. Doors in smoke partitions shall comply with this section.

**710.5.1 Louvers.** Doors in smoke partitions shall not include louvers.

**710.5.2 Smoke and draft-control doors.** Where required elsewhere in the code, doors in smoke partitions shall be tested in accordance with UL 1784 with an artificial bottom seal installed across the full width of the bottom of the door assembly. The air leakage rate of the door assembly shall not exceed 3.0 cubic feet per minute per square foot [ $\text{ft}^3/(\text{min ft}^2)$ ] ( $0.015424 \text{ m}^3/\text{sm}^2$ ) of door opening at 0.10 inch (24.9 Pa) of water for both the ambient temperature test and the elevated temperature exposure test.

**710.5.3 Self-closing or automatic-closing doors.** Where required elsewhere in the code, doors in smoke partitions shall be self-closing or automatic-closing in accordance with Section 715.3.7.3.

**710.6 Penetrations and joints.** The space around penetrating items and in joints shall be filled with an approved material to limit the free passage of smoke.

**710.7 Ducts and air transfer openings.** Air transfer openings in smoke partitions shall be provided with a smoke damper complying with Section 716.3.2.

**Exception:** Where the installation of a smoke damper will interfere with the operation of a required smoke control system in accordance with Section 909, approved alternative protection shall be utilized.

## **SECTION BC 711** **HORIZONTAL ASSEMBLIES**

**711.1 General.** Floor and roof assemblies required to have a fire-resistance rating shall comply with this section.

**711.2 Materials.** The floor and roof assemblies shall be of materials permitted by the building type of construction.

**Exception:** Horizontal floor or roof assemblies shall be of noncombustible materials when such assemblies serve as a horizontal offset to a fire wall or fire barrier that is required to be noncombustible.

**711.3 Fire-resistance rating.** The fire-resistance rating of floor and roof assemblies shall not be less than that required by the building type of construction. Where the floor assembly separates mixed occupancies, the assembly shall have a fire-resistance rating of not less than that required by Section 302.3.2 based on the occupancies being separated. Where the floor assembly separates a single occupancy into different fire areas, the assembly shall have a fire-resistance rating of not less than that required by Section 706.3.7. Floor assemblies separating dwelling units in Group I-1 or R Occupancies shall



be a minimum of 1-hour fire-resistance-rated construction.

**711.3.1 Ceiling panels.** Where the weight of lay-in ceiling panels, used as part of fire-resistance-rated floor/ceiling or roof/ceiling assemblies, is not adequate to resist an upward force of 1 lb/ft.<sup>2</sup> (48 Pa), wire or other approved devices shall be installed above the panels to prevent vertical displacement under such upward force.

**711.3.2 Access doors.** Access doors shall be permitted in ceilings of fire-resistance-rated floor/ceiling and roof/ceiling assemblies provided such doors are tested in accordance with ASTM E 119 as horizontal assemblies and labeled by an approved agency for such purpose.

**711.3.3 Unusable space.** In 1-hour fire-resistance-rated floor construction, the ceiling membrane is not required to be installed over unusable crawl spaces not intended for occupancy or storage, less than 24 inches (610 mm) in height. In 1-hour fire-resistance-rated roof construction, the floor membrane is not required to be installed where the unusable attic space above is not intended for occupancy or storage.

**711.4 Continuity.** Assemblies shall be continuous without openings, penetrations or joints except as permitted by this section and Sections 707.2, 712.4 and 713. Skylights and other penetrations through a fire-resistance-rated roof deck are permitted to be unprotected, provided that the structural integrity of the fire-resistance-rated roof construction is maintained. Unprotected skylights shall not be permitted in roof construction required to be fire-resistance rated in accordance with Section 704.10. The supporting construction shall be protected to afford the required fire-resistance rating of the horizontal assembly supported.

**711.5 Penetrations.** Penetrations through fire-resistance-rated horizontal assemblies shall comply with Section 712.

**711.6 Joints.** Joints made in or between fire-resistance-rated horizontal assemblies shall comply with Section 713. The void created at the intersection of a floor/ceiling assembly and an exterior curtain wall assembly shall be protected in accordance with Section 713.4.

**711.7 Ducts and air transfer openings.** Penetrations by ducts and air transfer openings shall comply with Sections 712 and 716.

## **SECTION BC 712** **PENETRATIONS**

**712.1 Scope.** The provisions of this section shall govern the materials and methods of construction used to protect through penetrations and membrane penetrations.

**712.1.1 Special inspection.** All through-penetration and membrane-penetration

firestop systems shall comply with the special inspection requirements of Chapter 17.

**712.2 Installation details.** Where sleeves are used, they shall be securely fastened to the assembly penetrated. The space between the item contained in the sleeve and the sleeve itself and any space between the sleeve and the assembly penetrated shall be protected in accordance with this section. Insulation and coverings on or in the penetrating item shall not penetrate the assembly unless the specific material used has been tested as part of the assembly in accordance with this section.

**712.3 Fire-resistance-rated walls.** Penetrations into or through fire walls, fire barriers, smoke barrier walls, and fire partitions shall comply with this section.

**712.3.1 Through penetrations.** Through penetrations of fire-resistance-rated walls shall comply with Section 712.3.1.1 or 712.3.1.2.

**Exception:** Where the penetrating items are steel, ferrous or copper pipes or steel conduits, the annular space between the penetrating item and the fire-resistance-rated wall shall be permitted to be protected as follows:

1. In concrete or masonry walls where the penetrating item is a maximum 6-inch (152 mm) nominal diameter and the opening is a maximum 144 square inches (0.0929 m<sup>2</sup>), concrete, grout or mortar shall be permitted where installed the full thickness of the wall or the thickness required to maintain the fire-resistance rating; or
2. The material used to fill the annular space shall prevent the passage of flame and hot gases sufficient to ignite cotton waste where subjected to ASTM E 119 time-temperature fire conditions under a minimum positive pressure differential of 0.01 inch (2.49 Pa) of water at the location of the penetration for the time period equivalent to the fire-resistance rating of the construction penetrated.

**712.3.1.1 Fire-resistance-rated assemblies.** Penetrations shall be installed as tested in an approved fire-resistance-rated assembly.

**712.3.1.2 Through-penetration firestop system.** Through penetrations shall be protected by an approved penetration fire stop system installed as tested in accordance with ASTM E 814 or UL 1479, with a minimum positive pressure differential of 0.01 inch (2.49 Pa) of water and shall have an F rating of not less than the required fire-resistance rating of the wall penetrated.

**712.3.2 Membrane penetrations.** Membrane penetrations shall be protected by a membrane penetration firestop installed in accordance with Section 712.3.1. Where walls and partitions are required to have a minimum 1-hour fire-resistance rating, recessed fixtures shall be installed such that the required fire resistance will not be

reduced.

**Exceptions:**

1. Steel electrical boxes that do not exceed 16 square inches (0.0103 m<sup>2</sup>) in area provided the total area of such openings does not exceed 100 square inches (0.0645 m<sup>2</sup>) for any 100 square feet (9.29 m<sup>2</sup>) of wall area. Outlet boxes on opposite sides of the wall shall be separated as shown:
  - 1.1. By a horizontal distance of not less than 24 inches (610 mm);
  - 1.2. By a horizontal distance of not less than the depth of the wall cavity where the wall cavity is filled with cellulose loose fill, rock wool or slag mineral wool insulation;
  - 1.3. By solid fire blocking in accordance with Section 717.2.1;
  - 1.4. By protecting both outlet boxes by listed putty pads; or
  - 1.5. By other listed materials and methods.
2. Membrane penetrations for listed electrical outlet boxes of any material are permitted provided such boxes have been tested for use in fire-resistance-rated assemblies and are installed in accordance with the instructions included in the listing. Outlet boxes on opposite sides of the wall shall be separated as follows:
  - 2.1. By a horizontal distance of not less than 24 inches (610 mm);
  - 2.2. By solid fire blocking in accordance with Section 717.2.1;
  - 2.3. By protecting both outlet boxes by listed putty pads; or
  - 2.4. By other listed materials and methods.
3. The annular space created by the penetration of a fire sprinkler provided it is covered by a metal escutcheon plate.

**712.3.3 Ducts and air transfer openings.** Penetrations of fire-resistance-rated walls by ducts and air transfer openings that are not protected with fire dampers shall comply with this section.

**712.3.4 Dissimilar materials.** Noncombustible penetrating items shall not connect to combustible items beyond the point of fire stopping unless it can be demonstrated to the commissioner that the fire-resistance integrity of the wall is maintained.

**712.4 Horizontal assemblies.** Penetrations of a floor, floor/ceiling assembly or the ceiling membrane of a roof/ceiling assembly shall be protected in accordance with Section 707. Penetrations permitted by Exceptions 3 and 4 of Section 707.2 shall comply with Sections 712.4.1 through 712.4.4.

**Exception:** Penetrations located within the same room or undivided area as floor openings not required to have a shaft enclosure in accordance with Exceptions 1, 2, 5, 7, 8 or 9 in Section 707.2.

**712.4.1 Through penetrations.** Through penetrations of fire-resistance-rated horizontal assemblies shall comply with Section 712.4.1.1 or 712.4.1.2.

**Exceptions:**

1. Penetrations by steel, ferrous or copper conduits, pipes, tubes, vents, concrete, or masonry through a single fire-resistance-rated floor assembly where the annular space is protected with materials that prevent the passage of flame and hot gases sufficient to ignite cotton waste where subjected to ASTM E 119 time-temperature fire conditions under a minimum positive pressure differential of 0.01 inch (2.49 Pa) of water at the location of the penetration for the time period equivalent to the fire-resistance rating of the construction penetrated. Penetrating items with a maximum 6-inch (152 mm) nominal diameter shall not be limited to the penetration of a single fire-resistance-rated floor assembly provided that the area of the penetration does not exceed 144 square inches (92 900 mm<sup>2</sup>) in any 100 square feet (9.3m<sup>2</sup>) of floor area.
2. Penetrations in a single concrete floor by steel, ferrous or copper conduits, pipes, tubes and vents with a maximum 6-inch (152 mm) nominal diameter provided concrete, grout or mortar is installed the full thickness of the floor or the thickness required to maintain the fire-resistance rating. The penetrating items with a maximum 6-inch (152 mm) nominal diameter shall not be limited to the penetration of a single concrete floor provided that the area of the penetration does not exceed 144 square inches (0.0929 m<sup>2</sup>).
3. Electrical outlet boxes of any material are permitted provided that such boxes are tested for use in fire-resistance-rated assemblies and installed in accordance with the tested assembly.

**712.4.1.1 Fire-resistance-rated assemblies.** Penetrations shall be installed as tested in the approved fire-resistance-rated assembly.

**712.4.1.2 Through-penetration firestop system.** Through penetrations shall be

protected by an approved through-penetration fire stop system installed and tested in accordance with ASTM E 814 or UL 1479, with a minimum positive pressure differential of 0.01 inch (2.49 Pa) of water. The system shall have an F rating and a T rating of not less than 1 hour but not less than the required rating of the floor penetrated.

**Exception:** Floor penetrations contained and located within the cavity of a wall do not require a T rating.

**712.4.2 Membrane penetrations.** Penetrations of membranes that are part of a fire-resistance-rated horizontal assembly shall comply with Section 712.4.1.1 or 712.4.1.2. Where floor/ceiling assemblies are required to have a minimum 1-hour fire-resistance rating, recessed fixtures shall be installed such that the required fire resistance will not be reduced.

**Exceptions:**

1. Membrane penetrations by steel, ferrous or copper conduits, electrical outlet boxes, pipes, tubes, vents, concrete, or masonry-penetrating items where the annular space is protected either in accordance with Section 712.4.1 or to prevent the free passage of flame and the products of combustion. Such penetrations shall not exceed an aggregate area of 100 square inches (64 500 mm<sup>2</sup>) in any 100 square feet (9.3 m<sup>2</sup>) of ceiling area in assemblies tested without penetrations.
2. Membrane penetrations by listed electrical outlet boxes of any material are permitted provided such boxes have been tested for use in fire-resistance-rated assemblies and are installed in accordance with the instructions included in the listing.
3. The annular space created by the penetration of a fire sprinkler provided it is covered by a metal escutcheon plate.

**712.4.3 Nonfire-resistance-rated assemblies.** Penetrations of horizontal assemblies without a required fire-resistance rating shall meet the requirements of Section 707 or shall comply with Sections 712.4.3.1 through 712.4.3.2.

**712.4.3.1 Noncombustible penetrating items.** Noncombustible penetrating items that connect not more than three stories are permitted provided that the annular space is filled with an approved noncombustible material to resist the free passage of flame and the products of combustion.

**712.4.3.2 Penetrating items.** Penetrating items that connect not more than two stories are permitted provided that the annular space is filled with an approved material to resist the free passage of flame and the products of combustion.

**712.4.4 Ducts and air transfer openings.** Penetrations of horizontal assemblies by ducts and air transfer openings that are not required to have dampers shall comply with this section. Ducts and air transfer openings that are protected with dampers shall comply with Section 716.

**712.4.5 Dissimilar materials.** Noncombustible penetrating items shall not connect to combustible materials beyond the point of fire stopping unless it can be demonstrated that the fire-resistance integrity of the horizontal assembly is maintained.

**712.4.6 Floor fire doors.** Floor fire door assemblies used to protect openings in fire-resistance-rated floors shall be tested in the horizontal position in accordance with ASTM E 119, and shall achieve a fire-resistance rating not less than the assembly being penetrated. Floor fire doors shall be labeled by an approved agency.

### **SECTION BC 713** **FIRE-RESISTANT JOINT SYSTEMS**

**713.1 General.** Joints installed in or between fire-resistance-rated walls, floor or floor/ceiling assemblies and roofs or roof/ceiling assemblies shall be protected by an approved fire-resistant joint system designed to resist the passage of fire for a time period not less than the required fire-resistance rating of the wall, floor or roof in or between which it is installed. Fire-resistant joint systems shall be tested in accordance with Section 713.3. The void created at the intersection of a floor/ceiling assembly and an exterior curtain wall assembly shall be protected in accordance with Section 713.4.

**Exception:** Fire-resistant joint systems shall not be required for joints in all of the following locations:

1. Floors within a single dwelling unit.
2. Floors where the joint is protected by a shaft enclosure in accordance with Section 707.
3. Floors within atriums where the space adjacent to the atrium is included in the volume of the atrium for smoke control purposes.
4. Floors within malls.
5. Floors within open parking structures.
6. Mezzanine floors.
7. Walls that are permitted to have unprotected openings.

8. Roofs where openings are permitted.

9. Control joints not exceeding a maximum width of 0.625 inch (15.9 mm) and tested in accordance with ASTM E 119.

**713.2 Installation.** Fire-resistant joint systems shall be securely installed in or on the joint for its entire length so as not to dislodge, loosen or otherwise impair its ability to accommodate expected building movements and to resist the passage of fire and hot gases.

**713.3 Fire test criteria.** Fire-resistant joint systems shall be tested in accordance with the requirements of either ASTM E 1966 or UL 2079. Nonsymmetrical wall joint systems shall be tested with both faces exposed to the furnace, and the assigned fire-resistance rating shall be the shortest duration obtained from the two tests. When evidence is furnished to show that the wall was tested with the least fire-resistant side exposed to the furnace, subject to acceptance of the commissioner, the wall need not be subjected to tests from the opposite side.

**Exception:** For exterior walls with a horizontal fire separation distance greater than 5 feet (1524 mm), the joint system shall be required to be tested for interior fire exposure only.

**713.4 Exterior curtain wall/floor intersection.** Where fire resistance-rated floor or floor/ceiling assemblies are required, voids created at the intersection of the exterior curtain wall assemblies and such floor assemblies shall be sealed with an approved material or system to prevent the interior spread of fire. Such material or systems shall be securely installed and capable of preventing the passage of flame and hot gases sufficient to ignite cotton waste where subjected to ASTM E 119 time-temperature fire conditions under a minimum positive pressure differential of 0.01 inch (0.254 mm) of water column (2.5 Pa) for the time period at least equal to the fire-resistance rating of the floor assembly. Height and fire-resistance requirements for curtain wall spandrels shall comply with Section 704.9.

## **SECTION BC 714**

### **FIRE-RESISTANCE RATING OF STRUCTURAL MEMBERS**

**714.1 Requirements.** The fire-resistance rating of structural members and assemblies shall comply with the requirements for the type of construction and shall not be less than the rating required for the fire-resistance-rated assemblies supported.

**Exception:** Fire barriers and fire partitions as provided in Sections 706.4 and 708.4, respectively.

**714.1.1 Inspection of Fire Protection.** The installation of all required sprayed-on fire protection shall be subject to the special inspection requirements of Section 1704.11.

**714.2 Protection of structural members.** Protection of columns, girders, trusses, beams, lintels or other structural members that are required to have a fire-resistance rating shall comply with this section.

**714.2.1 Individual protection.** Columns, girders, trusses, beams, lintels or other structural members that are required to have a fire-resistance rating and that support more than one floor or a roof, or support a load-bearing wall or a non-load-bearing wall more than one story high, shall be individually protected on all sides for the full length with materials having the required fire-resistance rating. Girders, trusses, beams, lintels or other structural members required to have a fire-resistance rating and that support only one floor or a roof, and/or a non-bearing wall not more than one story high, shall be protected by individual encasement, by a membrane or ceiling protection as specified in Section 711, or by a combination of both, which together provide the required fire-resistance rating. Columns shall also comply with Section 714.2.2.

**714.2.2 Column protection.** Where columns require a fire-resistance rating, the entire column, including its connections to beams or girders, shall be individually protected. Where the column extends through a ceiling, fire resistance of the column shall be continuous from the top of the floor through the ceiling space to the top of the column.

**714.2.3 Truss protection.** The required thickness and construction of fire-resistance-rated assemblies enclosing trusses shall be based on the results of full-scale tests or combinations of tests on truss components or on approved calculations based on such tests that satisfactorily demonstrate that the assembly has the required fire resistance

**714.2.4 Attachments to structural members.** The edges of lugs, brackets, rivets and bolt heads attached to structural members shall be protected to the highest fire-resistance rating of the members connected.

**714.2.5 Reinforcing.** Thickness of protection for concrete or masonry reinforcement shall be measured to the outside of the reinforcement, including stirrups, ties and spiral reinforcing ties.

**714.3 Embedments and enclosures.** Pipes, wires, conduits, ducts or other service facilities shall not be embedded in the required fire protection of a structural member that is required to be individually encased; except that pipes, wires, and conduits may be installed in the space between the required fire protection and the structural member protected, provided that where such facilities pierce the required fire protection, the area of the penetration does not exceed two percent of the area of the fire protection on any one face, the penetrations are closed off with close-fitting metal escutcheons or plates, and the concealed space shall be firestopped at each story.



**714.4 Impact protection.** Where the fire protective covering of a structural member is subject to impact damage from moving vehicles, the handling of merchandise or other activity, the fire protective covering shall be protected by corner guards or by a substantial jacket of metal or other noncombustible material to a height adequate to provide full protection, but not less than 5 feet (1524 mm) from the finished floor.

**714.5 Exterior structural members.** Load-bearing structural members located within the exterior walls or exposed to the outdoors shall be provided with the highest fire-resistance rating as determined in accordance with the following:

1. As required by Table 601 for the type of building element based on the type of construction of the building; and
2. As required by Table 601 for exterior bearing walls based on the type of construction; and
3. As required by Table 602 for exterior walls based on the fire separation distance.

**714.6 Lintel protection.** Lintels over openings wider than 4 feet (1219 mm) in masonry walls, other than in walls of masonry veneer on wood frame structures, shall be fire protected as required by Section 714.2, when the full load over the opening is not relieved by a masonry arch of required strength.

**Exceptions:**

1. The members of an assembled metal lintel that support only outer face masonry that is securely bonded or anchored to backing need not be fire protected, provided that the inner members of the assembly support the full load imposed.
2. The use of stone lintels in spans exceeding 4 feet (1219 mm) shall not be permitted unless supplemented by fire protected structural members or masonry arches of the required strength to support the superimposed loads.

**714.7 Seismic isolation systems.** Fire-resistance ratings for the isolation system shall meet the fire-resistance rating required for the columns, walls, or other structural elements in which the isolation system is installed in accordance with Table 601.

Isolation systems required to have a fire-resistance rating shall be protected with approved materials or construction assemblies designed to provide the same degree of fire resistance as the structural element in which it is installed when tested in accordance with ASTM E 119 (see Section 703.2).

Such isolation system protection applied to isolator units shall be capable of retarding the transfer of heat to the isolator unit in such a manner that the required gravity load-

carrying capacity of the isolator unit will not be impaired after exposure to the standard time-temperature curve fire test prescribed in ASTM E 119 for a duration not less than that required for the fire resistance rating of the structure element in which it is installed.

Such isolation system protection applied to isolator units shall be suitably designed and securely installed so as not to dislodge, loosen, sustain damage, or otherwise impair its ability to accommodate the seismic movements for which the isolator unit is designed and to maintain its integrity for the purpose of providing the required fire-resistance protection.

## **SECTION BC 715** **OPENING PROTECTIVES**

**715.1 General.** Opening protectives required by other sections of this code shall comply with the provisions of this section.

**715.2 Fire-resistance-rated glazing.** Labeled fire-resistance-rated glazing tested as part of a fire-resistance-rated wall assembly in accordance with ASTM E 119 shall not be required to comply with this section.

**715.3 Fire door and shutter assemblies.** Approved fire door and fire shutter assemblies shall be constructed of any material or assembly of component materials that conforms to the test requirements of Section 715.3.1, 715.3.2 or 715.3.3 and the fire protection rating indicated in Table 715.3. Fire door assemblies and shutters shall be installed in accordance with the provisions of this section and NFPA 80.

### **Exceptions:**

1. Labeled protective assemblies that conform to the requirements of this section or UL 10A, UL 14B and UL 14C for tin-clad fire door assemblies.
2. Floor fire doors shall comply with Section 712.4.6.

### **TABLE 715.3** **FIRE DOOR AND FIRE SHUTTER FIRE PROTECTION RATINGS** **TYPE OF ASSEMBLY REQUIRED ASSEMBLY RATING (hours) MINIMUM** **FIRE DOOR AND FIRE SHUTTER ASSEMBLY RATING (hours)** **(Table 715.3 as revised and original attached to end of document)**

**715.3.1 Side-hinged or pivoted swinging doors.** Side-hinged and pivoted swinging doors shall be tested in accordance with NFPA 252 or UL 10C. After 5 minutes into the NFPA 252 test, the neutral pressure level in the furnace shall be established at 40 inches (1016 mm) or less above the sill.

**715.3.2 Other types of doors.** Other types of doors, including swinging elevator doors, shall be tested in accordance with NFPA 252 or UL 10B. The pressure in the furnace shall be maintained as nearly equal to the atmospheric pressure as possible. Once established, the pressure shall be maintained during the entire test period.

**715.3.3 Door assemblies in corridors and smoke barriers.** Fire door assemblies located in corridor walls or smoke barrier walls having a fire-resistance rating in accordance with Table 715.3 shall be tested in accordance with NFPA 252 or UL 10C. Glazing material in any part of the door assembly, including transom lites and sidelites, shall be tested in accordance with NFPA 257 in accordance with Section 715.4. Fire door assemblies shall also meet the requirements for a smoke- and draft-control door assembly tested in accordance with UL 1784 with an artificial bottom seal installed across the full width of the bottom of the door assembly. The air leakage rate of the door assembly shall not exceed 3.0 cfm per square foot (0.01524 m<sup>3</sup>/slm<sup>2</sup>) of door opening at 0.10 inch (24.9 Pa) of water for both the ambient temperature and elevated temperature tests. Louvers shall be prohibited.

**Exceptions:**

1. Viewports that require a hole not larger than 1 inch (25 mm) in diameter through the door, have at least an 0.25-inch-thick (6.4 mm) glass disc and the holder is of metal that will not melt out where subject to temperatures of 1,700°F (927°C).
2. Corridor door assemblies in occupancies of Group I-2 shall be in accordance with Section 407.3.1.

**715.3.4 Doors in vertical exit enclosures and exit passageways.** Fire door assemblies in vertical exit enclosures and exit passageways shall have a maximum transmitted temperature end point of not more than 450°F (232°C) above ambient at the end of 30 minutes of standard fire test exposure.

**Exception:** The maximum transmitted temperature end point is not required in buildings equipped throughout with an automatic sprinkler system installed in accordance with Section 903.3.1.1 or 903.3.1.2.

**715.3.4.1 Glazing in doors.** Fire-protection-rated glazing in excess of 100 square inches (0.065 m<sup>2</sup>) shall be permitted in fire door assemblies when tested in accordance with NFPA 252 as components of the door assemblies and not as glass lights, and shall have a maximum transmitted temperature end point of 450°F (232°C) in accordance with Section 715.3.4.

**Exception:** The maximum transmitted temperature end point is not required in buildings equipped throughout with an automatic sprinkler system installed in accordance with Section 903.3.1.1 or 903.3.1.2.

**715.3.5 Labeled protective assemblies.** Fire door assemblies shall be labeled by an approved agency. The labels shall comply with NFPA 80, and shall be permanently affixed to the door or frame.

**715.3.5.1 Fire door labeling requirements.** Fire doors shall be labeled showing the name of the manufacturer, the name of the third-party inspection agency, the fire protection rating and, where required for fire doors in exit enclosures by Section 715.3.4, the maximum transmitted temperature end point. Smoke and draft control doors complying with UL 1784 shall be labeled as such. Labels shall be approved and permanently affixed. The label shall be applied at the factory or location where fabrication and assembly are performed.

**715.3.5.2 Oversized doors.** Oversized fire doors shall bear an oversized fire door label by an approved agency or shall be provided with a certificate of inspection furnished by an approved testing agency. When a certificate of inspection is furnished by an approved testing agency, the certificate shall state that the door conforms to the requirements of design, materials and construction, but has not been subjected to the fire test.

**715.3.5.3 Smoke and draft control door labeling requirements.** Smoke and draft control doors complying with UL 1784 shall be labeled in accordance with Section 715.3.5.1 and shall show the letter “S” on the fire rating label of the door. This marking shall indicate that the door and frame assembly are in compliance when listed or labeled gasketing is also installed.

**715.3.5.4 Fire door frame labeling requirements.** Fire door frames shall be labeled showing the names of the manufacturer and the third-party inspection agency.

**715.3.6 Glazing material.** Fire-protection-rated glazing conforming to the opening protection requirements in Section 715.3 shall be permitted in fire door assemblies.

**715.3.6.1 Size limitations.** Wired glass used in fire doors shall comply with Table 715.4.3. Other fire-protection- rated glazing shall comply with the size limitations of NFPA 80.

**Exceptions:**

1. Fire-protection-rated glazing in fire doors located in fire walls shall be prohibited except that where serving as a horizontal exit, a self-closing swinging door shall be permitted to have a vision panel of not more than 100 square inches (0.065 m<sup>2</sup>) without a dimension exceeding 10 inches (254 mm).

2. Fire-protection-rated glazing shall not be installed in fire doors having a 1½-hour fire protection rating intended for installation in fire barriers, unless the glazing is not more than 100 square inches (0.065 m<sup>2</sup>) in area.

**715.3.6.2 Exit and elevator protectives.** Approved fire-protection-rated glazing used in fire doors in elevator and stairway shaft enclosures shall be so located as to furnish clear vision of the passageway or approach to the elevator or stairway.

**715.3.6.3 Labeling.** Fire-protection-rated glazing shall bear a label or other identification showing the name of the manufacturer, the test standard and the fire protection rating. Such label or other identification shall be issued by an approved agency and shall be permanently affixed.

**715.3.6.4 Safety glazing.** Fire-protection-rated glazing installed in fire doors or fire window assemblies in areas subject to human impact in hazardous locations shall comply with Chapter 24.

**715.3.7 Door closing.** Fire doors shall be self-closing or automatic-closing in accordance with this section.

**Exception:** Fire doors located in common walls separating sleeping units in Group R-1 shall be permitted without automatic-closing or self-closing devices.

**715.3.7.1 Latch required.** Unless otherwise specifically permitted, single fire doors and both leaves of pairs of side-hinged swinging fire doors shall be provided with an active latch bolt that will secure the door when it is closed.

**715.3.7.2 Automatic-closing fire door assemblies.** Automatic-closing fire door assemblies shall be self-closing in accordance with NFPA 80.

**715.3.7.3 Smoke-activated doors.** Automatic-closing fire doors installed in the following locations shall be automatic-closing by the actuation of smoke detectors installed in accordance with Section 907.10 or by loss of power to the smoke detector or hold-open device. Fire doors that are automatic-closing by smoke detection shall not have more than a 10-second delay before the door starts to close after the smoke detector is actuated.

1. Doors installed across a corridor.
2. Doors that protect openings in horizontal exits, exits or exit access corridors required to be of fire-resistance-rated construction.
3. Doors that protect openings in walls required to be fire-resistance rated by Table 302.1.1.

4. Doors installed in smoke barriers in accordance with Section 709.5.
5. Doors installed in fire partitions in accordance with Section 708.6.
6. Doors installed in a fire wall in accordance with Section 705.8.

**715.3.7.4 Doors in pedestrian ways.** Vertical sliding or vertical rolling steel fire doors in openings through which pedestrian's travel shall be heat activated or activated by smoke detectors with alarm verification.

**715.3.8 Swinging fire shutters.** Where fire shutters of the swinging type are installed in exterior openings, not less than one row in every three vertical rows shall be arranged to be readily opened from the outside, and shall be identified by distinguishing marks or letters not less than 6 inches (152 mm) high.

**715.3.9 Rolling fire shutters.** Where fire shutters of the rolling type are installed, such shutters shall include approved automatic-closing devices.

**715.4 Fire-protection rated glazing.** Glazing in fire window assemblies shall be fire protection rated in accordance with this section and Table 715.4. Glazing in fire doors shall comply with Section 715.3.6. Fire-protection-rated glazing installed as an opening protective in fire partitions, smoke barriers and fire barriers shall be tested in accordance with and shall meet the acceptance criteria of NFPA 257 for a fire protection rating of 45 minutes. Fire-protection-rated glazing shall also comply with NFPA 80. Fire-protection-rated glazing required in accordance with Section 704.12 for exterior wall opening protection shall be tested in accordance with and shall meet the acceptance criteria of NFPA 257 for a fire protection rating as required in Section 715.4.7.

**Exception:** Wired glass in accordance with Section 715.4.3.

**TABLE 715.4**  
**FIRE WINDOW ASSEMBLY FIRE PROTECTION RATINGS**  
**(Table 715.4 attached to end of document)**

**715.4.1 Testing under positive pressure.** NFPA 257 shall evaluate fire-protection-rated glazing under positive pressure. Within the first 10 minutes of a test, the pressure in the furnace shall be adjusted so at least two-thirds of the test specimen is above the neutral pressure plane, and the neutral pressure plane shall be maintained at that height for the balance of the test.

**715.4.2 Nonsymmetrical glazing systems.** Nonsymmetrical fire-protection-rated glazing systems in fire partitions, fire barriers or in exterior walls with a fire separation of 5 feet (1524 mm) or less pursuant to Section 704 shall be tested with both faces exposed to the furnace, and the assigned fire protection rating shall be the

shortest duration obtained from the two tests conducted in compliance with NFPA 257.

**715.4.3 Wired glass.** Steel window frame assemblies of 0.125-inch (3.2 mm) minimum solid section or of not less than nominal 0.048-inch-thick (1.2 mm) formed sheet steel members fabricated by pressing, mitering, riveting, interlocking or welding and having provision for glazing with ¼-inch (6.4 mm) wired glass where securely installed in the building construction and glazed with ¼-inch (6.4 mm) labeled wired glass shall be deemed to meet the requirements for a ¾-hour fire window assembly. Wired glass panels shall conform to the size limitations set forth in Table 715.4.3.

**TABLE 715.4.3**  
**LIMITING SIZES OF WIRED GLASS PANELS**  
**(Table 715.4.3 attached to end of table)**

**715.4.4 Nonwired glass.** Glazing other than wired glass in fire window assemblies shall be fire-protection-rated glazing installed in accordance with and complying with the size limitations set forth in NFPA 80.

**715.4.5 Installation.** Fire-protection-rated glazing shall be in the fixed position or be automatic-closing and shall be installed in approved frames.

**715.4.6 Window mullions.** Metal mullions that exceed a nominal height of 12 feet (3658 mm) shall be protected with materials to afford the same fire-resistance rating as required for the wall construction in which the protective is located.

**715.4.7 Interior fire window assemblies.** Fire-protection-rated glazing used in fire window assemblies located in fire partitions and fire barriers shall be limited to use in assemblies with a maximum fire-resistance rating of 1 hour in accordance with this section.

**715.4.7.1 Where permitted.** Fire-protection-rated glazing shall be limited to fire partitions designed in accordance with Section 708 and fire barriers utilized in the applications set forth in Sections 706.3.5 and 706.3.6 where the fire-resistance rating does not exceed 1 hour.

**715.4.7.2 Size limitations.** The total area of windows shall not exceed 25 percent of the area of a common wall with any room.

**715.4.8 Exterior fire window assemblies.** Exterior openings, other than doors, required to be protected by Section 704.12, where located in a wall required by Table 602 to have a fire-resistance rating of greater than 1 hour, shall be protected with an assembly having a fire protection rating of not less than 1½ hours. Exterior openings required to be protected by Section 704.8, where located in a wall required by Table

602 to have a fire-resistance rating of 1 hour, shall be protected with an assembly having a fire protection rating of not less than ¾ hour. Exterior openings required to be protected by Section 704.9 or 704.10 shall be protected with an assembly having a fire protection rating of not less than ¾ hour. Openings in nonfire-resistance-rated exterior wall assemblies that require protection in accordance with Section 704.8, 704.9 or 704.10 shall have a fire protection rating of not less than ¾ hour.

**715.4.9 Labeling requirements.** Fire-protection-rated glazing shall bear a label or other identification showing the name of the manufacturer, the test standard, and the fire protection rating. Such label or identification shall be issued by an approved agency and shall be permanently affixed.

## **SECTION BC 716**

### **DUCTS AND AIR TRANSFER OPENINGS**

**716.1 General.** The provisions of this section shall govern the protection of ducts and air transfer openings in fire-resistance-rated assemblies.

**716.1.1 Ducts and air transfer openings without dampers.** Ducts and air transfer openings that penetrate fire-resistance-rated assemblies and are not required by this section to have dampers shall comply with the requirements of Section 712.

**716.2 Installation.** Fire dampers, smoke dampers, combination fire/smoke dampers and ceiling dampers located within air distribution and smoke control systems shall be installed in accordance with the requirements of this section, the *New York City Mechanical Code*, the manufacturer's installation instructions and listing.

**716.2.1 Smoke control system.** Where the installation of a fire damper will interfere with the operation of a required smoke control system in accordance with Section 909, approved alternative protection shall be utilized.

**716.2.1.1 Remote control.** Provisions for operation by remote control of combination fire/smoke dampers shall be in accordance with Section 607.3.1.1 of the *New York City Mechanical Code*.

**716.2.2 Hazardous exhaust ducts.** Fire dampers for hazardous exhaust duct systems shall comply with the *New York City Mechanical Code*.

**716.2.3 Supply air systems.** Smoke dampers in supply airhandling systems having a capacity equal to or greater than 15,000 cfm (7.1 m<sup>3</sup>/s) shall be installed in accordance with Section 607.2.3 of the *New York City Mechanical Code*.

**716.3 Damper testing and ratings.** Dampers shall be listed and bear the label of an approved testing agency indicating compliance with the standards in this section. Fire dampers shall comply with the requirements of UL 555. Only fire dampers labeled for



use in dynamic systems shall be installed in heating, ventilation and air-conditioning systems designed to operate with fans on during a fire. Smoke dampers shall comply with the requirements of UL 555S. Combination fire/smoke dampers shall comply with the requirements of both UL 555 and UL 555S. Ceiling radiation dampers shall comply with the requirements of UL 555C.

**716.3.1 Fire protection rating.** Fire dampers shall have the minimum fire protection rating specified in Table 716.3.1 for the type of penetration.

**TABLE 716.3.1**  
**FIRE DAMPER RATING**  
**(Table 716.3.1 attached to end of document)**

**716.3.1.1 Fire damper actuating device.** The fire damper actuating device shall meet one of the following requirements:

1. The operating temperature shall be approximately 50°F (10°C) above the normal temperature within the duct system, but not less than 160°F (71°C).
2. The operating temperature shall be not more than 286°F (141°C) where located in a smoke control system complying with Section 909.
3. Where a combination fire/smoke damper is located in a smoke control system complying with Section 909, the operating temperature rating shall be approximately 50°F (10°C) above the maximum smoke control system designed operating temperature, or a maximum temperature of 350°F (177°C). The temperature shall not exceed the UL 555S degradation test temperature rating for a combination fire/smoke damper.

**716.3.2 Smoke damper ratings.** Smoke damper leakage ratings shall not be less than Class II. Elevated temperature ratings shall not be less than 250°F (121°C).

**716.3.2.1 Smoke damper actuation methods.** The smoke damper shall close upon actuation of a listed smoke detector or detectors installed in accordance with Section 907.10 and one of the following methods, as applicable:

1. Where a damper is installed within a duct, a smoke detector shall be installed in the duct within 5 feet (1524 mm) of the damper with no air outlets or inlets between the detector and the damper. The detector shall be listed for the air velocity, temperature and humidity anticipated at the point where it is installed. Other than in mechanical smoke control systems, dampers shall be closed upon fan shutdown where local smoke detectors require a minimum velocity to operate.

2. Where a damper is installed above smoke barrier doors in a smoke barrier, a spot-type detector listed for releasing service shall be installed on either side of the smoke barrier door opening.
3. Where a damper is installed within an unducted opening in a wall, a spot-type detector listed for releasing service shall be installed within 5 feet (1524 mm) horizontally of the damper.
4. Where a damper is installed in a corridor wall, the damper shall be permitted to be controlled by a smoke detection system installed in the corridor.
5. Where a total-coverage smoke detector system is provided within areas served by a heating, ventilation and air-conditioning (HVAC) system, dampers shall be permitted to be controlled by the smoke detection system.
6. Smoke dampers that are part of an engineered smoke control system shall be controlled in accordance with Section 607.3.2.1 of the *New York City Mechanical Code*.

**716.4 Access and identification.** Fire and smoke dampers shall be provided with an approved means of access, large enough to permit inspection and maintenance of the damper and its operating parts. The access shall not affect the integrity of fire-resistance-rated assemblies. The access openings shall not reduce the fire-resistance rating of the assembly. Access points shall be permanently identified on the exterior by a label having letters not less than 0.5 inch (12.7 mm) in height reading: SMOKE DAMPER or FIRE DAMPER followed by an identification marking that is individual and unique to the damper accessed.

**716.5 Where required.** Fire dampers, smoke dampers, combination fire/smoke dampers and ceiling radiation dampers shall be provided as specified in this section. Where an assembly is required to have both fire dampers and smoke dampers, combination fire/smoke dampers or a fire damper and a smoke damper shall be required.

**Exceptions:**

1. Smoke dampers shall not be required on air systems other than where necessary for the proper function of that system where the system is designed specifically to:
  - 1.1. Function as an engineered smoke-control system, including the provision of continuous air movement with the air-handling system;
  - 1.2. Provide air to other areas of the building during a fire emergency; or

- 1.3. Provide pressure differentials during a fire emergency.
2. Smoke dampers shall not be required to be located within a prescribed distance of a fire rated enclosure where isolation smoke dampers are used in air-handling equipment.
3. Smoke dampers shall not be required in ducts where the air continues to move and the air-handling system installed is arranged to prevent recirculation of exhaust or return air under fire emergency conditions

**716.5.1 Fire walls.** Ducts and air transfer openings permitted in fire walls in accordance with Section 705.11 shall be protected with approved fire dampers and smoke dampers installed in accordance with their listing.

**716.5.2 Fire barriers.** Duct and air transfer openings of fire barriers shall be protected with approved fire dampers installed in accordance with their listing. In addition, smoke dampers shall be installed in penetrations of public corridor walls in accordance with Section 716.5.4.1.

**Exception:** Fire dampers are not required at penetrations of fire barriers where any of the following apply:

1. Penetrations are tested in accordance with ASTM E 119 as part of the fire-resistance-rated assembly.
2. Ducts are used as part of an approved smoke control system in accordance with Section 716.2.1 and Section 909.
3. Such walls are penetrated by ducted HVAC systems, have a required fire-resistance rating of 1 hour or less, are in areas of other than Group H and are in buildings equipped throughout with an automatic sprinkler system in accordance with Section 903.3.1.1 or 903.3.1.2. For the purposes of this exception, a ducted HVAC system shall be a duct system for conveying supply, return or exhaust air as part of the structure's HVAC system. Such a duct system shall be constructed of sheet steel not less than 26 gage thickness and shall be continuous from the air-handling appliance or equipment to the air outlet and inlet terminals.

**716.5.2.1 Public corridors.** A listed smoke damper designed to resist the passage of smoke shall be provided at each point a duct or air transfer opening penetrates a public corridor wall constructed as a fire barrier.

**Exceptions:**

1. Smoke dampers are not required where the building is equipped throughout with an approved smoke control system in accordance with Section 909, and smoke dampers are not necessary for the operation and control of the system.
2. Smoke dampers are not required in corridor penetrations where the duct is constructed of steel not less than 0.019-inch (0.48 mm) in thickness and there are no openings serving the corridor.
3. Smoke dampers are not required in corridor penetrations in Group R-2 buildings and spaces.

**716.5.3 Shaft enclosures.** Ducts and air transfer openings shall not penetrate a shaft serving as an exit enclosure except as permitted by Section 1020.5.

**716.5.3.1 Penetrations of shaft enclosures.** Shaft enclosures that are permitted to be penetrated by ducts and air transfer openings shall be protected with approved fire and smoke dampers installed in accordance with their listing.

**Exceptions:**

1. Fire dampers are not required at penetrations of shafts where:
  - 1.1. Steel exhaust subducts are extended at least 22 inches (559 mm) vertically in exhaust shafts provided there is a continuous airflow upward to the outside, or
  - 1.2. Penetrations are tested in accordance with ASTM E 119 as part of the rated assembly, or
  - 1.3. Ducts are used as part of an approved smoke control system designed and installed in accordance with Section 909, and where the fire damper will interfere with the operation of the smoke control system, or
  - 1.4. The penetrations are in parking garage exhaust or supply shafts that are separated from other building shafts by not less than 2-hour fire-resistance-rated construction.
2. In Group B occupancies, equipped throughout with an automatic sprinkler system in accordance with Section 903.3.1.1, smoke dampers are not required at penetrations of shafts where:
  - 2.1. Bathroom and toilet room exhaust openings with steel exhaust subducts, having a wall thickness of at least 0.019 inches (0.48

mm) that extend at least 22 inches (559 mm) vertically and the exhaust fan at the upper terminus, powered continuously in accordance with the provisions of Section 909.11, maintains airflow upward to the outside, or

- 2.2. Ducts are used as part of an approved smoke control system, designed and installed in accordance with Section 909, and where the smoke damper will interfere with the operation of the smoke control system, or
3. Smoke dampers are not required at penetration of exhaust or supply shafts in parking garages that are separated from other building shafts by not less than 2-hour fire-resistance-rated construction.
4. Fire dampers and smoke dampers shall not be required at a shaft where the shaft is acting as an extension of the mechanical equipment room that it serves and the shaft and mechanical equipment room maintain fire and smoke separation required by the greater of the two spaces from the occupied portions of the building and meet the requirements of Section 707.11.
5. Smoke dampers shall not be required to be located within a prescribed distance of a fire rated enclosure where isolation smoke dampers are used in air-handling equipment.
6. Smoke dampers shall not be required in ducts where the air continues to move and the air-handling system installed is arranged to prevent recirculation of exhaust or return air under fire emergency conditions.
7. Smoke dampers shall not be required in exhaust ducts or shafts where the exhaust fan is maintained in operation during occupancy, such as in bathroom and toilet room exhausts.

**716.5.3.2 Limitations.** Shafts that constitute air ducts shall be limited in accordance with Section 607.5.5.2 of the *New York City Mechanical Code*.

**716.5.4 Fire partitions.** Duct penetrations in fire partitions shall be protected with approved fire dampers installed in accordance with their listing.

**Exceptions:** In occupancies other than Group H, fire dampers are not required where any of the following apply:

1. The partitions are tenant separation and interior corridor walls in buildings equipped throughout with an automatic sprinkler system in accordance with Section 903.3.1.1 or 903.3.1.2 and the duct is protected as a through

penetration in accordance with Section 712.

2. The duct system is constructed of approved materials in accordance with the *New York City Mechanical Code* and the duct penetrating the wall meets all of the following minimum requirements:

2.1. The duct shall not exceed 100 square inches (0.06 m<sup>2</sup>).

2.2. The duct shall be constructed of steel a minimum of 0.0217 inch (0.55 mm) in thickness.

2.3. The duct shall not have openings that communicate the corridor with adjacent spaces or rooms.

2.4. The duct shall be installed above a ceiling.

2.5. The duct shall not terminate at a wall register in the fire-resistance-rated wall.

2.6. A minimum 12-inch-long (0.30 m) by 0.060-inch-thick (1.52 mm) steel sleeve shall be centered in each duct opening. The sleeve shall be secured to both sides of the wall and all four sides of the sleeve with minimum 1-1/2-inch by 1-1/2-inch by 0.060-inch (0.038 m by 0.038 m by 1.52 mm) steel retaining angles. The retaining angles shall be secured to the sleeve and the wall with No. 10 (M5) screws. The annular space between the steel sleeve and wall opening shall be filled with rock (mineral) wool batting or approved equivalent on all sides.

**716.5.5 Smoke barriers.** A listed smoke damper designed to resist the passage of smoke shall be provided at each point a duct or air transfer opening penetrates a smoke barrier. Smoke dampers and smoke damper actuation methods shall comply with Section 716.3.2.1.

**Exception:** Smoke dampers are not required where the openings in ducts are limited to a single smoke compartment and the ducts are constructed of steel.

**716.6 Horizontal assemblies.** Penetrations by ducts and air transfer openings of a floor, floor/ceiling assembly or the ceiling membrane of a roof/ceiling assembly shall be protected by a shaft enclosure that complies with Section 707 or shall comply with this section.

**716.6.1 Through penetrations.** In occupancies other than Groups I-2 and I-3, a duct and air transfer opening system constructed of approved materials in accordance with the *New York City Mechanical Code* that penetrates a fire-resistance-rated

floor/ceiling assembly that connects not more than two stories is permitted without shaft enclosure protection provided a fire damper is installed at the floor line and the penetration is fire blocked in accordance with Section 717.2.5.

**Exception:** A duct serving a dwelling unit is permitted to penetrate three floors or less without a fire damper at each floor provided it meets all of the following requirements.

1. The duct shall be contained and located within the cavity of a wall and shall be constructed of steel not less than 0.019 inch (0.48 mm) (26 gage) in thickness.
2. The duct shall open into only one dwelling unit and the duct system shall be continuous from the unit to the exterior of the building.
3. The duct shall not exceed 5-inch (127 mm) nominal diameter and the total area of such ducts shall not exceed 100 square inches (0.065 m<sup>2</sup>) in any 100 square feet (9.3 m<sup>2</sup>) of floor area.
4. The annular space around the duct is protected with materials that prevent the passage of flame and hot gases sufficient to ignite cotton waste where subjected to ASTM E 119 time-temperature conditions under a minimum positive pressure differential of 0.01 inch (2.49 Pa) of water at the location of the penetration for the time period equivalent to the fire-resistance rating of the construction penetrated.
5. Grille openings located in a ceiling of a fire-resistance-rated floor/ceiling or roof/ceiling assembly shall be protected with a ceiling radiation damper in accordance with Section 716.6.2.

**716.6.2 Membrane penetrations.** Where duct systems constructed of approved materials in accordance with the *New York City Mechanical Code* penetrate a ceiling of a fire-resistance-rated floor/ceiling or roof/ceiling assembly, shaft enclosure protection is not required provided an approved ceiling radiation damper and firestopping is installed at the ceiling line. Where a duct is not attached to a diffuser that penetrates a ceiling of a fire-resistance-rated floor/ceiling or roof/ceiling assembly, shaft enclosure protection is not required provided an approved ceiling radiation damper and firestopping is installed at the ceiling line. Ceiling radiation dampers shall be tested in accordance with UL 555C and constructed in accordance with the details listed in a fire-resistance-rated assembly or shall be labeled to function as a heat barrier for air-handling outlet/inlet penetrations in the ceiling of a fire-resistance-rated assembly. Ceiling radiation dampers shall not be required where ASTM E 119 fire tests have shown that ceiling radiation dampers are not necessary in order to maintain the fire-resistance rating of the assembly. Ceiling radiation dampers shall not be required where exhaust duct penetrations are protected in accordance

with Section 712.4.2 and the exhaust ducts are located within the cavity of a wall, and do not pass through another dwelling unit or tenant space.

**716.6.3 Non-fire-resistance-rated assemblies.** Duct systems constructed of approved materials in accordance with the *New York City Mechanical Code* that penetrate non-fire-resistance-rated floor assemblies and that connect not more than two stories are permitted without shaft enclosure protection provided that the annular space between the assembly and the penetrating duct is filled with an approved noncombustible material to resist the free passage of flame and the products of combustion. Duct systems constructed of approved materials in accordance with the *New York City Mechanical Code* that penetrate non-fire-resistance-rated floor assemblies and that connect not more than three stories are permitted without shaft enclosure protection provided that the annular space between the assembly and the penetrating duct is filled with an approved noncombustible material to resist the free passage of flame and the products of combustion, and a fire damper is installed at each floor line.

**Exception:** Fire dampers are not required in ducts within individual residential dwelling units.

**716.7 Flexible ducts and air connectors.** Flexible ducts and air connectors shall not pass through any fire-resistance-rated assembly. Flexible air connectors shall not pass through any wall, floor or ceiling.

## **SECTION BC 717** **CONCEALED SPACES**

**717.1 General.** Fire blocking and draft stopping shall be installed in combustible and noncombustible concealed locations in accordance with this section. Fire blocking shall comply with Section 717.2. Draft stopping in floor/ceiling spaces and attic spaces shall comply with Sections 717.3 and 717.4, respectively. The permitted use of combustible materials in concealed spaces of noncombustible buildings shall be limited to the applications indicated in Section 717.5. Installations of fire blocking and draft stopping shall comply with the special inspection requirements of Chapter 17.

**Exception:** Concealed spaces that are sprinklered in accordance with Chapter 9 or are constructed as a shaft.

**717.2 Fireblocking.** In combustible and noncombustible construction, fire blocking shall be installed to cut off concealed draft openings (both vertical and horizontal) and shall form an effective barrier between floors, between a top story and a roof or attic space. Fire blocking shall be installed in the locations specified in Sections 717.2.2 through 717.2.7.

**717.2.1 Fireblocking materials.** Fire blocking shall consist of 2-inch (51 mm)



nominal lumber or two thicknesses of 1-inch (25 mm) nominal lumber with broken lap joints or one thickness of 0.719-inch (18.3 mm) wood structural panel with joints backed by 0.719-inch (18.3 mm) wood structural panel or one thickness of 0.75-inch (19 mm) particleboard with joints backed by 0.75-inch (19 mm) particleboard. Gypsum board, cement fiber board, batts or blankets of mineral wool or glass fiber or other approved materials installed in such a manner as to be securely retained in place shall be permitted as an acceptable fire block. Batts or blankets of mineral or glass fiber or other approved nonrigid materials shall be permitted for compliance with the 10-foot (3048 mm) horizontal fire blocking in walls constructed using parallel rows of studs or staggered studs. Loose-fill insulation material shall not be used as a fire block unless specifically tested in the form and manner intended for use to demonstrate its ability to remain in place and to retard the spread of fire and hot gases. The integrity of fire blocks shall be maintained.

**717.2.1.1 Double stud walls.** Batts or blankets of mineral or glass fiber or other approved nonrigid materials shall be allowed as fire blocking in walls constructed using parallel rows of studs or staggered studs.

**717.2.2 Concealed wall spaces.** Fire blocking shall be provided in concealed spaces of stud walls and partitions, including furred spaces, and parallel rows of studs or staggered studs, as follows:

1. Vertically at the ceiling and floor levels.
2. Horizontally at intervals not exceeding 10 feet (3048 mm).

**717.2.3 Connections between horizontal and vertical spaces.** Fire blocking shall be provided at interconnections between concealed vertical stud wall or partition spaces and concealed horizontal spaces created by an assembly of floor joists or trusses, and between concealed vertical and horizontal spaces such as occur at soffits, drop ceilings, cove ceilings and similar locations.

**717.2.4 Stairways.** Fire blocking shall be provided in concealed spaces between stair stringers at the top and bottom of the run. Enclosed spaces under stairs shall also comply with Section 1019.1.5.

**717.2.5 Ceiling and floor openings.** Where annular space protection is provided in accordance with Exception 6 of Section 707.2, Exception 1 of Section 712.4.2, or Section 712.4.3, fire blocking shall be installed at openings around vents, pipes, ducts, chimneys and fireplaces at ceiling and floor levels, with an approved material to resist the free passage of flame and the products of combustion. Factory-built chimneys and fireplaces shall be fire blocked in accordance with UL 103 and UL 127.

**717.2.6 Architectural trim.** Fire blocking shall be installed within concealed spaces of exterior wall finish and other exterior architectural elements where permitted to be

of combustible construction in Section 1406 or where erected with combustible frames, at maximum intervals of 20 feet (6096 mm). If non-continuous, such elements shall have closed ends, with at least 4 inches (102 mm) of separation between sections.

**Exceptions:**

1. Fire blocking of cornices is not required in single-family dwellings. Fire blocking of cornices of a two-family dwelling is required only at the line of dwelling unit separation.
2. Fire blocking shall not be required where installed on noncombustible framing and the face of the exterior wall finish exposed to the concealed space is covered by one of the following materials:
  - 2.1. Aluminum having a minimum thickness of 0.019 inch (0.5 mm).
  - 2.2. Corrosion-resistant steel having a base metal thickness not less than 0.016 inch (0.4 mm) at any point.
  - 2.3. Other approved noncombustible materials.

**717.2.7 Concealed sleeper spaces.** Where wood sleepers are used for laying wood flooring on masonry or concrete fire-resistance-rated floors, the space between the floor slab and the underside of the wood flooring shall be filled with an approved material to resist the free passage of flame and products of combustion or fire blocked in such a manner that there will be no open spaces under the flooring that will exceed 20 square feet (1.86 m<sup>2</sup>) in area and such space shall be filled solidly under permanent partitions so that there is no communication under the flooring between adjoining rooms.

**Exceptions:**

1. Fire blocking is not required for slab-on-grade floors in gymnasiums.
2. Fire blocking is required only at the juncture of each alternate lane and at the ends of each lane in a bowling facility.

**717.3 Draft stopping in floors.** In combustible and noncombustible construction, draft stopping shall be installed to subdivide floor/ceiling assemblies in the locations prescribed in Sections 717.3.2 through 717.3.3.

**717.3.1 Draft stopping materials.** In noncombustible construction, draft stopping shall be of noncombustible materials. In combustible construction, draft stopping materials shall not be less than 0.5-inch (12.7 mm) gypsum board, 0.375-inch (9.5

mm) wood structural panel, 0.375-inch (9.5 mm) particleboard or other approved materials adequately supported. The integrity of draft stops shall be maintained.

**717.3.2 Group R.** Draft stopping shall be provided in floor/ceiling spaces in Group R buildings. Draft stopping shall be located above and in line with the dwelling unit separations.

**Exceptions:**

1. Draft stopping is not required in buildings equipped throughout with an automatic sprinkler system in accordance with Section 903.3.1.1.
2. Draft stopping is not required in buildings equipped throughout with an automatic sprinkler system in accordance with Section 903.3.1.2, provided that automatic sprinklers are also installed in the combustible concealed spaces.
3. Where laminated wood I-joist assemblies are used, the space between the ceiling and the floor or roof above shall be divided into approximately equal areas not greater than 500 square feet (46.5 m<sup>2</sup>).
4. Draft stopping shall not be required where the structural members within the concealed ceiling space are individually protected on all sides for their full length with materials having the required fire resistance rating.

**717.3.3 Other groups.** In occupancies other than Group R, draft stopping shall be installed so that horizontal floor areas do not exceed 3,000 square feet (279 m<sup>2</sup>).

**Exceptions:**

1. Draft stopping is not required in buildings equipped throughout with an automatic sprinkler system in accordance with Section 903.3.1.1.
2. Draft stopping shall not be required where the structural members within the concealed ceiling space are individually protected on all sides for their full length with materials having the required fire resistance rating.

**717.4 Draft stopping in attics.** In combustible and noncombustible construction, draft stopping shall be installed to subdivide attic spaces and concealed roof spaces in the locations prescribed in Sections 717.4.2 and 717.4.3. Ventilation of concealed roof spaces shall be maintained in accordance with Section 1203.2.

**717.4.1 Draft stopping materials.** Materials utilized for draft stopping of attic spaces shall comply with Section 717.3.1.

**717.4.1.1 Openings.** Openings in draft stop partitions provided in accordance with Section 1209.2 shall be protected by self-closing doors with automatic latches constructed as required for the partitions.

**717.4.2 Groups R-1 and R-2.** Draft stopping shall be provided in attics, mansards, overhangs or other concealed roof spaces of Group R-2 buildings with three or more dwelling units and in all Group R-1 buildings. Draft stopping shall be installed above, and in line with, dwelling unit separation walls that do not extend to the underside of the roof sheathing above.

**Exceptions:**

1. Draft stopping shall not be required where the structural members within the concealed attic space are individually protected on all sides for their full length with materials having the required fire resistance rating.
2. Draft stopping is not required in buildings equipped throughout with an automatic sprinkler system in accordance with Section 903.3.1.1.
3. In occupancies in Group R-2 that do not exceed four stories in height, the attic space shall be subdivided by draft stops into areas not exceeding 3,000 square feet (279 m<sup>2</sup>) or above every two dwelling units, whichever is smaller.
4. Draft stopping is not required in buildings equipped throughout with an automatic sprinkler system in accordance with Section 903.3.1.2, provided that automatic sprinklers are also installed in the combustible concealed spaces.
5. Where laminated wood I-joint assemblies are used, the space between the ceiling and the floor or roof above shall be divided into approximately equal areas not greater than 500 square feet (46.5 m<sup>2</sup>).

**717.4.3 Other groups.** Draft stopping shall be installed in attics and concealed roof spaces, such that any horizontal area does not exceed 3,000 square feet (279 m<sup>2</sup>).

**Exceptions:**

1. Draft stopping is not required in buildings equipped throughout with an automatic sprinkler system in accordance with Section 903.3.1.1.
2. Draft stopping shall not be required where the structural members within the concealed attic space are individually protected on all sides for their full length with materials having the required fire resistance rating.

3. Where laminated wood I-joist assemblies are used, the space between the ceiling and the floor or roof above shall be divided into approximately equal areas not greater than 500 square feet (46.5 m<sup>2</sup>).

**717.5 Combustibles in concealed spaces in Type I or II construction.** Combustibles shall not be permitted in concealed spaces of buildings of Type I or II construction.

**Exceptions:**

1. Combustible materials in accordance with Section 603.
2. Combustible materials complying with Section 602 of the *New York City Mechanical Code*.
3. Class A interior finish materials.
4. Combustible piping within partitions or enclosed shafts installed in accordance with the provisions of this code. Combustible piping shall be permitted within concealed ceiling spaces where installed in accordance with the *New York City Mechanical Code* and the *New York City Plumbing Code*.

**SECTION BC 718**  
**FIRE-RESISTANCE REQUIREMENTS FOR PLASTER**

**718.1 Thickness of plaster.** The minimum thickness of gypsum plaster or portland cement plaster used in a fire-resistance-rated system shall be determined by the prescribed fire tests. The plaster thickness shall be measured from the face of the lath where applied to gypsum lath or metal lath.

**718.2 Plaster equivalents.** For fire-resistance purposes, 0.5 inch (12.7 mm) of unsanded gypsum plaster shall be deemed equivalent to 0.75 inch (19.1 mm) of one-to-three gypsum sand plaster or 1 inch (25 mm) of portland cement sand plaster.

**718.3 Noncombustible furring.** In buildings of Type I and II construction, plaster shall be applied directly on concrete or masonry or on approved noncombustible plastering base and furring.

**718.4 Double reinforcement.** Plaster protection more than 1 inch (25 mm) in thickness shall be reinforced with an additional layer of approved lath embedded at least 0.75 inch (19.1 mm) from the outer surface and fixed securely in place.

**Exception:** Solid plaster partitions or where otherwise determined by fire tests.

**718.5 Plaster alternatives for concrete.** In reinforced concrete construction, gypsum plaster or portland cement plaster is permitted to be substituted for 0.5 inch (12.7 mm) of

the required poured concrete protection, except that a minimum thickness of 0.375 inch (9.5 mm) of poured concrete shall be provided in reinforced concrete floors and 1 inch (25 mm) in reinforced concrete columns in addition to the plaster finish. The concrete base shall be prepared in accordance with Section 2510.7.

## **SECTION BC 719** **THERMAL-AND SOUND-INSULATING MATERIALS**

**719.1 General.** Insulating materials, including facings such as vapor retarders and vapor-permeable membranes, similar coverings, and all layers of single and multilayer reflective foil insulations, shall comply with the requirements of this section. Where a flame spread index or a smoke-development index is specified in this section, such index shall be determined in accordance with ASTM E 84. Any material that is subject to an increase in flame spread index or smoke-development index beyond the limits herein established through the effects of age, moisture, or other atmospheric conditions shall not be permitted. Fiberboard insulation shall comply with Chapter 23 and the requirements of this section. Foam plastic insulation shall comply with Chapter 26 and the requirements of this section. Duct and pipe coverings and linings in plenums shall comply with the *New York City Mechanical Code*.

**Exceptions:** Exterior Insulation Finish Systems (EIFS) shall comply with Chapter 14 and Chapter 26.

**719.1.1 Noncombustible construction.** Insulating materials used in noncombustible construction must either:

1. Satisfactorily pass a test for determining non-combustibility of elementary materials, based on the test procedures of ASTM E 136; or
2. Have a flame spread index not greater than 25, a smoke-development index not greater than 50, and be without evidence of continued progressive combustion when tested in accordance with ASTM E 84.

**719.1.2 Combustible construction.** Insulating materials used in combustible construction shall have a flame spread index not greater than 25, a smoke-development index not greater than 450, and be without evidence of continuous progressive combustion when tested in accordance with ASTM E 84.

**719.2 Concealed installation.** Insulating materials, where concealed as installed in buildings of any type construction, shall comply with Sections 719.1, 719.1.1 and 719.1.2. Concealed insulation shall be separated from the building interior by a thermal barrier consisting of at least ½-inch (12.7 mm) thick gypsum wallboard or approved equivalent.

**Exception:** Cellulose loose-fill insulation that is not spray applied, complying with the requirements of Section 719.6, shall only be required to meet the smoke-development index of not more than 450.

**719.2.1 Facings.** Where such materials are installed in concealed spaces in buildings of Type III, IV or V construction, the flame spread and smoke-development limits do not apply to facings, coverings, and layers of reflective foil insulation that are installed behind and in substantial contact with the unexposed surface of the ceiling, wall or floor finish.

**719.3 Exposed installation.** Insulation materials, where exposed as installed in buildings of any type construction, shall have a flame spread index of not more than 25 and a smoke-development index of not more than 50.

**Exception:** Cellulose loose-fill insulation that is not spray applied complying with the requirements of Section 719.6 shall only be required to meet the smoke-development index of not more than 50.

**719.3.1 Attic floors.** Exposed insulation materials installed on attic floors shall have a critical radiant flux of not less than 0.12 watt per square centimeter when tested in accordance with ASTM E 970.

**719.3.2 Toxicity.** Upon exposure to fire, insulating materials used in building interiors, including facings such as vapor retarders and vapor permeable membranes, similar coverings, and all layers of single and multi-layer reflective foil insulation, shall not produce products of decomposition or combustion that are more toxic in point of concentration than those given off by wood or paper when decomposing or burning under comparable conditions in accordance with test standards approved by the department.

**719.4 Loose-fill insulation.** Loose-fill insulation materials that cannot be mounted in the ASTM E 84 apparatus without a screen or artificial supports shall comply with the flame spread and smoke-developed limits of Sections 719.2 and 719.3 when tested in accordance with CAN/ULC S102.2.

**Exception:** Cellulose loose-fill insulation shall not be required to comply with this test method, provided such insulation complies with the requirements of Section 719.6.

**719.5 Roof insulation.** The use of combustible roof insulation not complying with Sections 719.2 and 719.3 shall be permitted in any type construction provided it is applied on top of roof decking or slab and is covered with approved roof coverings directly applied thereto.

**719.6 Cellulose loose-fill insulation.** Cellulose loose-fill insulation shall comply with

CPSC 16 CFR, Part 1209 and CPSC 16 CFR, Part 1404. Each package of such insulating material shall be clearly labeled in accordance with CPSC 16 CFR, Part 1209 and CPSC 16 CFR, Part 1404.

**719.7 Insulation and covering on pipe and tubing.** Insulation and covering on pipe and tubing shall comply with the requirements of the *New York City Mechanical Code*.

## **SECTION BC 720** **PRESCRIPTIVE FIRE RESISTANCE**

**720.1 General.** The provisions of this section contain prescriptive details of fire-resistance-rated building elements. The materials of construction listed in Tables 720.1(1), 720.1(2), and 720.1(3) shall be assumed to have the fire-resistance ratings prescribed therein. Where materials that change the capacity for heat dissipation are incorporated into a fire-resistance-rated assembly, fire test results or other substantiating data shall be made available to the commissioner to show that the required fire-resistance-rating time period is not reduced.

**720.1.1 Thickness of protective coverings.** The thickness of fire-resistant materials required for protection of structural members shall be not less than set forth in Table 720.1(1), except as modified in this section. The figures shown shall be the net thickness of the protecting materials and shall not include any hollow space in back of the protection.

**720.1.2 Unit masonry protection.** Where required, metal ties shall be embedded in transverse joints of unit masonry for protection of steel columns. Such ties shall be as set forth in Table 720.1(1) or be equivalent thereto.

**720.1.3 Reinforcement for cast-in-place concrete column protection.** Cast-in-place concrete protection for steel columns shall be reinforced at the edges of such members with wire ties of not less than 0.18 inch (4.6 mm) in diameter wound spirally around the columns on a pitch of not more than 8 inches (203 mm) or by equivalent reinforcement.

**720.1.4 Plaster application.** The finish coat is not required for plaster protective coatings where they comply with the design mix and thickness requirements of Tables 720.1(1), 720.1(2) and 720.1(3).

**720.1.5 Bonded prestressed concrete tendons.** For members having a single tendon or more than one tendon installed with equal concrete cover measured from the nearest surface, the cover shall not be less than that set forth in Table 720.1(1). For members having multiple tendons installed with variable concrete cover, the average tendon cover shall not be less than that set forth in Table 720.1(1), provided:

1. The clearance from each tendon to the nearest exposed surface is used to



determine the average cover.

2. In no case can the clear cover for individual tendons be less than one-half of that set forth in Table 720.1(1). A minimum cover of 0.75 inch (19.1 mm) for slabs and 1 inch (25 mm) for beams is required for any aggregate concrete.
3. For the purpose of establishing a fire-resistance rating, tendons having a clear covering less than that set forth in Table 720.1(1) shall not contribute more than 50 percent of the required ultimate moment capacity for members less than 350 square inches (0.226 m<sup>2</sup>) in cross-sectional area and 65 percent for larger members. For structural design purposes, however, tendons having a reduced cover are assumed to be fully effective.

**TABLE 720.1(1)**  
**MINIMUM PROTECTION OF STRUCTURAL PARTS BASED ON TIME PERIODS FOR VARIOUS NONCOMBUSTIBLE INSULATING MATERIALS<sup>m</sup>**  
**(Table 720.1 (1) attached to end of document)**

**TABLE 720.1(2)**  
**RATED FIRE-RESISTANCE PERIODS FOR VARIOUS WALLS AND PARTITIONS<sup>a,d</sup>**  
**(Table 720.1 (2) attached to end of document)**

**TABLE 720.1(3)**  
**MINIMUM PROTECTION FOR FLOOR AND ROOF SYSTEMS<sup>a,d</sup>**  
**(Table 720.1(3) attached to end of document)**

**SECTION 721**  
**CALCULATED FIRE RESISTANCE**

**721.1 General.** The provisions of this section contain procedures by which the fire resistance of specific materials or combinations of materials is established by calculations. These procedures apply only to the information contained in this section and shall not be otherwise used. The calculated fire resistance of concrete, concrete masonry, and clay masonry assemblies shall be permitted in accordance with ACI 216.1/TMS 0216.1. The calculated fire resistance of steel assemblies shall be permitted in accordance with Chapter 5 of ASCE/SFPE 29.

**721.1.1 Definitions.** The following words and terms shall, for the purposes of this chapter and as used elsewhere in this code, have the meanings shown herein.

**CERAMIC FIBER BLANKET.** A mineral wool insulation material made of alumina-silica fibers and weighing 4 to 10 pounds per cubic foot (pcf) (64 to 160 kg/m<sup>3</sup>).

**CONCRETE, CARBONATE AGGREGATE.** Concrete made with aggregates consisting mainly of calcium or magnesium carbonate, such as limestone or dolomite, and containing 40 percent or less quartz, chert, or flint.

**CONCRETE, CELLULAR.** A lightweight insulating concrete made by mixing a preformed foam with portland cement slurry and having a dry unit weight of approximately 30 pcf (480 kg/m<sup>3</sup>).

**CONCRETE, LIGHTWEIGHT AGGREGATE.** Concrete made with aggregates of expanded clay, shale, slag or slate or sintered fly ash or any natural lightweight aggregate meeting ASTM C 330 and possessing equivalent fire-resistance properties and weighing 85 to 115 pcf (1360 to 1840 kg/m<sup>3</sup>).

**CONCRETE, PERLITE.** A lightweight insulating concrete having a dry unit weight of approximately 30 pcf (480 kg/m<sup>3</sup>) made with perlite concrete aggregate. Perlite aggregate is produced from a volcanic rock which, when heated, expands to form a glass-like material of cellular structure.

**CONCRETE, SAND-LIGHTWEIGHT.** Concrete made with a combination of expanded clay, shale, slag, slate, sintered fly ash, or any natural lightweight aggregate meeting ASTM C 330 and possessing equivalent fire-resistance properties and natural sand. Its unit weight is generally between 105 and 120 pcf (1680 and 1920 kg/m<sup>3</sup>).

**CONCRETE, SILICEOUS AGGREGATE.** Concrete made with normal-weight aggregates consisting mainly of silica or compounds other than calcium or magnesium carbonate, which contains more than 40-percent quartz, chert, or flint.

**CONCRETE, VERMICULITE.** A lightweight insulating concrete made with vermiculite concrete aggregate which is laminated micaceous material produced by expanding the ore at high temperatures. When added to a portland cement slurry the resulting concrete has a dry unit weight of approximately 30 pcf (480 kg/m<sup>3</sup>).

**GLASS FIBERBOARD.** Fibrous glass roof insulation consisting of inorganic glass fibers formed into rigid boards using a binder. The board has a top surface faced with asphalt and kraft reinforced with glass fiber.

**MINERAL BOARD.** A rigid felted thermal insulation board consisting of either felted mineral fiber or cellular beads of expanded aggregate formed into flat rectangular units.

**721.2 Concrete assemblies.** The provisions of this section contain procedures by which the fire-resistance ratings of concrete assemblies are established by calculations.

**721.2.1 Concrete walls.** Cast-in-place and precast concrete walls shall comply with Section 721.2.1.1. Multiwythe concrete walls shall comply with Section 721.2.1.2.

Joints between precast panels shall comply with Section 721.2.1.3. Concrete walls with gypsum wallboard or plaster finish shall comply with Section 721.2.1.4.

**721.2.1.1 Cast-in-place or precast walls.** The minimum equivalent thickness of cast-in-place or precast concrete walls for fire-resistance ratings of 1 hour to 4 hours are shown in Table 721.2.1.1. For solid walls with flat vertical surfaces, the equivalent thickness is the same as the actual thickness. The values in Table 721.2.1.1 apply to plain, reinforced or prestressed concrete walls.

**TABLE 721.2.1.1**  
**MINIMUM EQUIVALENT THICKNESS OF CAST-IN-PLACE OR PRECAST**  
**CONCRETE WALLS, LOAD-BEARING OR NONLOAD-BEARING**  
**(Table 721.2.1.1 attached to end of document)**

**721.2.1.1.1 Hollow-core precast wall panels.** For hollow-core precast concrete wall panels in which the cores are of constant cross section throughout the length, calculation of the equivalent thickness by dividing the net cross-sectional area (the gross cross section minus the area of the cores) of the panel by its width shall be permitted.

**721.2.1.1.2 Core spaces filled.** Where all of the core spaces of hollow-core wall panels are filled with loose-fill material, such as expanded shale, clay, or slag, or vermiculite or perlite, the fire-resistance rating of the wall is the same as that of a solid wall of the same concrete type and of the same overall thickness.

**721.2.1.1.3 Tapered cross sections.** The thickness of panels with tapered cross sections shall be that determined at a distance  $2t$  or 6 inches (152 mm), whichever is less, from the point of minimum thickness, where  $t$  is the minimum thickness.

**721.2.1.1.4 Ribbed or undulating surfaces.** The equivalent thickness of panels with ribbed or undulating surfaces shall be determined by one of the following expressions:

For  $s \geq 4t$ , the thickness to be used shall be  $t$

For  $s \leq 2t$ , the thickness to be used shall be  $t_e$

For  $4t > s > 2t$ , the thickness to be used shall be

**(Equation 7-3 attached to end of document)**

**721.2.1.2 Multiwythe walls.** For walls that consist of two wythes of different types of concrete, the fire-resistance ratings shall be permitted to be determined from Figure 721.2.1.2.

**TABLE 721.2.1.2(1)**  
**VALUES OF  $R_n^{0.59}$  FOR USE IN EQUATION 7-4**  
**(Table 721.2.1.2(1) attached to end of document)**

**TABLE 721.2.1.2(2)**  
**FIRE-RESISTANCE RATINGS BASED ON  $R^{0.59}$**   
**(Table 721.2.1.2(2) attached to end of document)**

**FIGURE 721.2.1.2**  
**FIRE-RESISTANCE RATINGS OF TWO-WYTHE CONCRETE WALLS**  
**(Figure 721.2.1.2 attached to end of document)**

**721.2.1.2.1 Two or more wythes.** The fire-resistance rating for wall panels consisting of two or more wythes shall be permitted to be determined by the formula:

**(Equation 7-4 attached to end of document)**

**721.2.1.2.2 Foam plastic insulation.** The fire-resistance ratings of precast concrete wall panels consisting of a layer of foam plastic insulation sandwiched between two wythes of concrete shall be permitted to be determined by use of Equation 7-4. Foam plastic insulation with a total thickness of less than 1 inch (25 mm) shall be disregarded. The  $Rn$  value for thickness of foam plastic insulation of 1 inch (25 mm) or greater, for use in the calculation, is 5 minutes; therefore  $Rn^{0.59} = 2.5$ .

**721.2.1.3 Joints between precast wall panels.** Joints between precast concrete wall panels which are not insulated as required by this section shall be considered as openings in walls. Uninsulated joints shall be included in determining the percentage of openings permitted by Table 704.8. Where openings are not permitted or are required by this code to be protected, the provisions of this section shall be used to determine the amount of joint insulation required. Insulated joints shall not be considered openings for purposes of determining compliance with the allowable percentage of openings in Table 704.8.

**721.2.1.3.1 Ceramic fiber joint protection.** Figure 721.2.1.3.1 shows thicknesses of ceramic fiber blankets to be used to insulate joints between precast concrete wall panels for various panel thicknesses and for joint widths of  $\frac{3}{8}$  inch (9.5 mm) and 1 inch (25 mm) for fire-resistance ratings of 1 hour to 4 hours. For joint widths between  $\frac{3}{8}$  inch (9.5 mm) and 1 inch (25 mm), the thickness of ceramic fiber blanket is allowed to be determined by direct interpolation. Other tested and labeled materials are acceptable in place of ceramic fiber blankets.

**FIGURE 721.2.1.3.1**

**CERAMIC FIBER JOINT PROTECTION**  
**(Figure 721.2.1.3.1 attached to end of document)**

**721.2.1.4 Walls with gypsum wallboard or plaster finishes.** The fire-resistance rating of cast-in-place or precast concrete walls with finishes of gypsum wallboard or plaster applied to one or both sides shall be permitted to be calculated in accordance with the provisions of this section.

**TABLE 721.2.1.4(1)**  
**MULTIPLYING FACTOR FOR FINISHES ON NONFIRE-EXPOSED SIDE OF**  
**WALL**  
**(Table 721.2.1.4(1) attached to end of document)**

**TABLE 721.2.1.4(2)**  
**TIME ASSIGNED TO FINISH MATERIALS ON FIRE-EXPOSED SIDE OF**  
**WALL**  
**(Table 721.2.1.4 (2) attached to end of document)**

**721.2.1.4.1 Nonfire-exposed side.** Where the finish of gypsum wallboard or plaster is applied to the side of the wall not exposed to fire, the contribution of the finish to the total fire-resistance rating shall be determined as follows: The thickness of the finish shall first be corrected by multiplying the actual thickness of the finish by the applicable factor determined from Table 721.2.1.4(1) based on the type of aggregate in the concrete. The corrected thickness of finish shall then be added to the actual or equivalent thickness of concrete and fire-resistance rating of the concrete and finish determined from Table 721.2.1.1, Figure 721.2.1.2 or Table 721.2.1.2(1).

**721.2.1.4.2 Fire-exposed side.** Where gypsum wallboard or plaster is applied to the fire-exposed side of the wall, the contribution of the finish to the total fire-resistance rating shall be determined as follows: The time assigned to the finish as established by Table 721.2.1.4(2) shall be added to the fire-resistance rating determined from Table 721.2.1.1 or Figure 721.2.1.2, or Table 721.2.1.2(1) for the concrete alone, or to the rating determined in Section 721.2.1.4.1 for the concrete and finish on the nonfire-exposed side.

**721.2.1.4.3 Nonsymmetrical assemblies.** For a wall having no finish on one side or different types or thicknesses of finish on each side, the calculation procedures of Sections 721.2.1.4.1 and 721.2.1.4.2 shall be performed twice, assuming either side of the wall to be the fire-exposed side. The fire-resistance rating of the wall shall not exceed the lower of the two values.

**Exception:** For an exterior wall with more than 5 feet (1524 mm) of horizontal separation, the fire shall be assumed to occur on the interior side only.

**721.2.1.4.4 Minimum concrete fire-resistance rating.** Where finishes applied to one or both sides of a concrete wall contribute to the fire-resistance rating, the concrete alone shall provide not less than one-half of the total required fire-resistance rating. Additionally, the contribution to the fire resistance of the finish on the nonfire-exposed side of a load-bearing wall shall not exceed one-half the contribution of the concrete alone.

**721.2.1.4.5 Concrete finishes.** Finishes on concrete walls that are assumed to contribute to the total fire-resistance rating of the wall shall comply with the installation requirements of Section 721.3.2.5.

**721.2.2 Concrete floor and roof slabs.** Reinforced and prestressed floors and roofs shall comply with Section 721.2.2.1. Multicourse floors and roofs shall comply with Sections 721.2.2.2 and 721.2.2.3, respectively.

**721.2.2.1 Reinforced and prestressed floors and roofs.** The minimum thicknesses of reinforced and prestressed concrete floor or roof slabs for fire-resistance ratings of 1 hour to 4 hours are shown in Table 721.2.2.1.

**TABLE 721.2.2.1**  
**MINIMUM SLAB THICKNESS (inches)**  
**(Table 721.2.2.1 attached to end of document)**

**721.2.2.1.1 Hollow-core prestressed slabs.** For hollow-core prestressed concrete slabs in which the cores are of constant cross section throughout the length, the equivalent thickness shall be permitted to be obtained by dividing the net cross-sectional area of the slab including grout in the joints, by its width.

**721.2.2.1.2 Slabs with sloping soffits.** The thickness of slabs with sloping soffits (see Figure 721.2.2.1.2) shall be determined at a distance  $2t$  or 6 inches (152 mm), whichever is less, from the point of minimum thickness, where  $t$  is the minimum thickness.

**FIGURE 721.2.2.1.2**  
**DETERMINATION OF SLAB THICKNESS FOR SLOPING SOFFITS**  
**(Table 721.2.2.1.2 attached to end of document)**

**721.2.2.1.3 Slabs with ribbed soffits.** The thickness of slabs with ribbed or undulating soffits (see Figure 721.2.2.1.3) shall be determined by one of the following expressions, whichever is applicable:

- For  $s \geq 4t$ , the thickness to be used shall be  $t$
- For  $s \leq 2t$ , the thickness to be used shall be  $te$

For  $4t > s > 2t$ , the thickness to be used shall be

(Equation 7-5 attached to end of document)

**FIGURE 721.2.2.1.3**  
**SLABS WITH RIBBED OR UNDULATING SOFFITS**  
**(Figure 721.2.2.1.3 attached to end of document)**

721.2.2.2 Multicourse floors. The fire-resistance ratings of floors that consist of a base slab of concrete with a topping (overlay) of a different type of concrete shall comply with Figure 721.2.2.2.

**FIGURE 721.2.2.2**  
**FIRE-RESISTANCE RATINGS FOR TWO-COURSE CONCRETE FLOORS**  
**(Figure 721.2.2.2 attached to end of document)**

721.2.2.3 Multicourse roofs. The fire-resistance ratings of roofs which consist of a base slab of concrete with a topping (overlay) of an insulating concrete or with an insulating board and built-up roofing shall comply with Figures 721.2.2.3(1) and 721.2.2.3(2).

721.2.2.3.1 Heat transfer. For the transfer of heat, three-ply built-up roofing contributes 10 minutes to the fire-resistance rating. The fire-resistance rating for concrete assemblies such as those shown in Figure 721.2.2.3(1) shall be increased by 10 minutes. This increase is not applicable to those shown in Figure 721.2.2.3(2).

**FIGURE 721.2.2.3(1)**  
**FIRE-RESISTANCE RATINGS FOR CONCRETE ROOF ASSEMBLIES**  
**(Figure 721.2.2.3(1) attached to end of document)**

**FIGURE 721.2.2.3(2)**  
**FIRE-RESISTANCE RATINGS FOR CONCRETE ROOF ASSEMBLIES**  
**(Figure 721.2.2.3(2) attached to end of document)**

721.2.2.4 Joints in precast slabs. Joints between adjacent precast concrete slabs need not be considered in calculating the slab thickness provided that a concrete topping at least 1 inch (25 mm) thick is used. Where no concrete topping is used, joints must be grouted to a depth of at least one-third the slab thickness at the joint, but not less than 1 inch (25 mm), or the joints must be made fire resistant by other approved methods.

721.2.3 Concrete cover over reinforcement. The minimum thickness of concrete cover over reinforcement in concrete slabs, reinforced beams and prestressed beams shall comply with this section.

**721.2.3.1 Slab cover.** The minimum thickness of concrete cover to the positive moment reinforcement shall comply with Table 721.2.3(1) for reinforced concrete and Table 721.2.3(2) for prestressed concrete. These tables are applicable for solid or hollow-core one-way or two-way slabs with flat undersurfaces. These tables are applicable to slabs that are either cast in place or precast. For precast prestressed concrete not covered elsewhere, the procedures contained in PCI MNL 124 shall be acceptable.

**721.2.3.2 Reinforced beam cover.** The minimum thickness of concrete cover to the positive moment reinforcement (bottom steel) for reinforced concrete beams is shown in Table 721.2.3(3) for fire-resistance ratings of 1 hour to 4 hours.

**721.2.3.3 Prestressed beam cover.** The minimum thickness of concrete cover to the positive moment prestressing tendons (bottom steel) for restrained and unrestrained prestressed concrete beams and stemmed units shall comply with the values shown in Tables 721.2.3(4) and 721.2.3(5) for fire-resistance ratings of 1 hour to 4 hours. Values in Table 721.2.3(4) apply to beams 8 inches (203 mm) or greater in width. Values in Table 721.2.3(5) apply to beams or stems of any width, provided the cross-section area is not less than 40 square inches (25 806 mm<sup>2</sup>). In case of differences between the values determined from Table 721.2.3(4) or 721.2.3(5), it is permitted to use the smaller value. The concrete cover shall be calculated in accordance with Section 721.2.3.3.1. The minimum concrete cover for nonprestressed reinforcement in prestressed concrete beams shall comply with Section 721.2.3.2.

**721.2.3.3.1 Calculating concrete cover.** The concrete cover for an individual tendon is the minimum thickness of concrete between the surface of the tendon and the fire-exposed surface of the beam, except that for ungrouped ducts, the assumed cover thickness is the minimum thickness of concrete between the surface of the duct and the fire-exposed surface of the beam. For beams in which two or more tendons are used, the cover is assumed to be the average of the minimum cover of the individual tendons. For corner tendons (tendons equal distance from the bottom and side), the minimum cover used in the calculation shall be one-half the actual value. For stemmed members with two or more prestressing tendons located along the vertical centerline of the stem, the average cover shall be the distance from the bottom of the member to the centroid of the tendons. The actual cover for any individual tendon shall not be less than one-half the smaller value shown in Tables 721.2.3(4) and 721.2.3(5), or 1 inch (25 mm), whichever is greater.

**TABLE 721.2.3(1)**  
**COVER THICKNESS FOR REINFORCED CONCRETE FLOOR OR ROOF**  
**SLABS (inches)**  
**(Table 721.2.3(1) attached to end of document)**



**TABLE 721.2.3(2)**  
**COVER THICKNESS FOR REINFORCED CONCRETE FLOOR OR ROOF**  
**SLABS (inches)**  
**(Table 721.2.3(2) attached to end of document)**

**TABLE 721.2.3(3)**  
**MINIMUM COVER FOR MAIN REINFORCING BARS OF REINFORCED**  
**CONCRETE BEAMS<sup>c</sup> (APPLICABLE TO ALL TYPES OF STRUCTURAL**  
**CONCRETE)**  
**(Table 721.2.3(3) attached to end of document)**

**TABLE 721.2.3(4)**  
**MINIMUM COVER FOR PRESTRESSED CONCRETE BEAMS 8 INCHES OR**  
**GREATER IN WIDTH**  
**(Table 721.2.3(4) attached to end of document)**

**TABLE 721.2.3(5)**  
**MINIMUM COVER FOR PRESTRESSED CONCRETE BEAMS OF ALL**  
**WIDTHS**  
**(Table 721.2.3(5) attached to end of document)**

**721.2.4 Concrete columns.** Concrete columns shall comply with this section.

**TABLE 721.2.4**  
**MINIMUM DIMENSION OF CONCRETE COLUMNS (inches)**  
**(Table 721.2.4 attached to end of document)**

**721.2.4.1 Minimum size.** The minimum overall dimensions of reinforced concrete columns for fire-resistance ratings of 1 hour to 4 hours shall comply with Table 721.2.4.

**721.2.4.2 Minimum cover for R/C columns.** The minimum thickness of concrete cover to the main longitudinal reinforcement in columns, regardless of the type of aggregate used in the concrete, shall not be less than 1 inch (25 mm) times the number of hours of required fire resistance or 2 inches (51 mm), whichever is less.

**721.2.4.3 Columns built into walls.** The minimum dimensions of Table 721.2.4 do not apply to a reinforced concrete column that is built into a concrete or masonry wall provided all of the following are met:

1. The fire-resistance rating for the wall is equal to or greater than the required rating of the column;

2. The main longitudinal reinforcing in the column has cover not less than that required by Section 721.2.4.2; and
3. Openings in the wall are protected in accordance with Table 715.4.

Where openings in the wall are not protected as required by Section 715.4, the minimum dimension of columns required to have a fire-resistance rating of 3 hours or less shall be 8 inches (203 mm), and 10 inches (254 mm) for columns required to have a fire-resistance rating of 4 hours, regardless of the type of aggregate used in the concrete.

**721.2.4.4 Precast cover units for steel columns.** See Section 721.5.1.4.

**721.3 Concrete masonry.** The provisions of this section contain procedures by which the fire-resistance ratings of concrete masonry are established by calculations.

**721.3.1 Equivalent thickness.** The equivalent thickness of concrete masonry construction shall be determined in accordance with the provisions of this section.

**721.3.1.1 Concrete masonry unit plus finishes.** The equivalent thickness of concrete masonry assemblies,  $T_{ea}$ , shall be computed as the sum of the equivalent thickness of the concrete masonry unit,  $T_e$ , as determined by Section 721.3.1.2, 721.3.1.3, or 721.3.1.4, plus the equivalent thickness of finishes,  $T_{ef}$ , determined in accordance with Section 721.3.2:

**(Equation 7-6 attached to end of document)**

**721.3.1.2 UngROUTED or partially grouted construction.**  $T_e$  shall be the value obtained for the concrete masonry unit determined in accordance with ASTM C 140.

**721.3.1.3 Solid grouted construction.** The equivalent thickness,  $T_e$ , of solid grouted concrete masonry units is the actual thickness of the unit.

**721.3.1.4 Airspaces and cells filled with loose-fill material.** The equivalent thickness of completely filled hollow concrete masonry is the actual thickness of the unit when loose-fill materials are: sand, pea gravel, crushed stone, or slag that meet ASTM C 33 requirements; pumice, scoria, expanded shale, expanded clay, expanded slate, expanded slag, expanded fly ash, or cinders that comply with ASTM C 331; or perlite or vermiculite meeting the requirements of ASTM C 549 and ASTM C 516, respectively.

**721.3.2 Concrete masonry walls.** The fire-resistance rating of walls and partitions constructed of concrete masonry units shall be determined from Table 721.3.2. The rating shall be based on the equivalent thickness of the masonry and type of aggregate

used.

**721.3.2.1 Finish on nonfire-exposed side.** Where plaster or gypsum wallboard is applied to the side of the wall not exposed to fire, the contribution of the finish to the total fire-resistance rating shall be determined as follows: The thickness of gypsum wallboard or plaster shall be corrected by multiplying the actual thickness of the finish by applicable factor determined from Table 721.2.1.4(1). This corrected thickness of finish shall be added to the equivalent thickness of masonry and the fire-resistance rating of the masonry and finish determined from Table 721.3.2.

**721.3.2.2 Finish on fire-exposed side.** Where plaster or gypsum wallboard is applied to the fire-exposed side of the wall, the contribution of the finish to the total fire-resistance rating shall be determined as follows: The time assigned to the finish as established by Table 721.2.1.4(2) shall be added to the fire-resistance rating determined in Section 721.3.2 for the masonry alone, or in Section 721.3.2.1 for the masonry and finish on the nonfire-exposed side.

**721.3.2.3 Nonsymmetrical assemblies.** For a wall having no finish on one side or having different types or thicknesses of finish on each side, the calculation procedures of this section shall be performed twice, assuming either side of the wall to be the fire-exposed side. The fire-resistance rating of the wall shall not exceed the lower of the two values calculated.

**Exception:** For exterior walls with more than 5 feet (1524 mm) of horizontal separation, the fire shall be assumed to occur on the interior side only.

**721.3.2.4 Minimum concrete masonry fire-resistance rating.** Where the finish applied to a concrete masonry wall contributes to its fire-resistance rating, the masonry alone shall provide not less than one-half the total required fire-resistance rating.

**721.3.2.5 Attachment of finishes.** Installation of finishes shall be as follows:

1. Gypsum wallboard and gypsum lath applied to concrete masonry or concrete walls shall be secured to wood or steel furring members spaced not more than 16 inches (406 mm) on center (o.c).
2. Gypsum wallboard shall be installed with the long dimension parallel to the furring members and shall have all joints finished.
3. Other aspects of the installation of finishes shall comply with the applicable provisions of Chapters 7 and 25.

**TABLE 721.3.2**

**MINIMUM EQUIVALENT THICKNESS (inches) OF BEARING OR  
NONBEARING CONCRETE MASONRY WALLS<sup>a,b,c,d</sup>**

**(Table 721.3.2 attached to end of document)**

**721.3.3 Multiwythe masonry walls.** The fire-resistance rating of wall assemblies constructed of multiple wythes of masonry materials shall be permitted to be based on the fire-resistance rating period of each wythe and the continuous airspace between each wythe in accordance with the following formula:

**(Equation 7-7 attached to end of document)**

**721.3.4 Concrete masonry lintels.** Fire-resistance ratings for concrete masonry lintels shall be determined based upon the nominal thickness of the lintel and the minimum thickness of concrete masonry or concrete, or any combination thereof, covering the main reinforcing bars, as determined according to Table 721.3.4, or by approved alternate methods.

**TABLE 721.3.4**

**MINIMUM COVER OF LONGITUDINAL REINFORCEMENT IN FIRE-  
RESISTANCE-RATED REINFORCED CONCRETE MASONRY LINTELS  
(inches)**

**(Table 721.3.4 attached to end of document)**

**721.3.5 Concrete masonry columns.** The fire-resistance rating of concrete masonry columns shall be determined based upon the least plan dimension of the column in accordance with Table 721.3.5 or by approved alternate methods.

**TABLE 721.3.5**

**MINIMUM DIMENSION OF CONCRETE MASONRY COLUMNS (inches)**

**(Table 721.3.5 attached to end of document)**

**721.4 Clay brick and tile masonry.** The provisions of this section contain procedures by which the fire-resistance ratings of clay brick and tile masonry are established by calculations.

**721.4.1 Masonry walls.** The fire-resistance rating of masonry walls shall be based upon the equivalent thickness as calculated in accordance with this section. The calculation shall take into account finishes applied to the wall and airspaces between wythes in multiwythe construction.

**721.4.1.1 Equivalent thickness.** The fire-resistance ratings of walls or partitions constructed of solid or hollow clay masonry units shall be determined from Table 721.4.1(1) or 721.4.1(2). The equivalent thickness of the clay masonry unit shall be determined by Equation 7-8 when using Table 721.4.1(1). The fire-resistance rating determined from Table 721.4.1(1) shall be permitted to be used in the

calculated fire-resistance rating procedure in Section 721.4.2.

**721.4.1.1.1 Hollow clay units.** The equivalent thickness,  $T_e$ , shall be the value obtained for hollow clay units as determined in accordance with ASTM C 67.

**(Equation 7-8 attached to end of document)**

**721.4.1.1.2 Solid grouted clay units.** The equivalent thickness of solid grouted clay masonry units shall be taken as the actual thickness of the units.

**721.4.1.1.3 Units with filled cores.** The equivalent thickness of the hollow clay masonry units is the actual thickness of the unit when completely filled with loose-fill materials of: sand, pea gravel, crushed stone, or slag that meet ASTM C 33 requirements; pumice, scoria, expanded shale, expanded clay, expanded slate, expanded slag, expanded fly ash, or cinders in compliance with ASTM C 331; or perlite or vermiculite meeting the requirements of ASTM C 549 and ASTM C 516, respectively.

**721.4.1.2 Plaster finishes.** Where plaster is applied to the wall, the total fire-resistance rating shall be determined by the formula:

**(Equation 7-9 attached to end of document)**

**721.4.1.3 Multiwythe walls with airspace.** Where a continuous airspace separates multiple wythes of the wall or partition, the total fire-resistance rating shall be determined by the formula:

**(Equation 7-10 attached to end of document)**

**721.4.1.4 Nonsymmetrical assemblies.** For a wall having no finish on one side or having different types or thicknesses of finish on each side, the calculation procedures of this section shall be performed twice, assuming either side to be the fire-exposed side of the wall. The fire resistance of the wall shall not exceed the lower of the two values determined.

**Exception:** For exterior walls with more than 5 feet (1524 mm) of horizontal separation, the fire shall be assumed to occur on the interior side only.

**TABLE 721.4.1(1)**

**FIRE-RESISTANCE PERIODS OF CLAY MASONRY WALLS**

**(Table 721.4.1(1) attached to end of document)**

**TABLE 721.4.1(2)**

**FIRE-RESISTANCE RATINGS FOR BEARING STEEL FRAME BRICK VENEER WALLS OR PARTITIONS**

**(Table 721.4.1(2) attached to end of document)**

**TABLE 721.4.1(3)**  
**VALUES OF  $R_n^{0.59}$**

**(Table 721.4.1(3) attached to end of document)**

**TABLE 721.4.1(4)**  
**COEFFICIENTS FOR PLASTER,  $pl^a$**   
**(Table 721.4.1(4) attached to end of document)**

**TABLE 721.4.1(5)**  
**REINFORCED MASONRY LINTELS**  
**(Table 721.4.1(5) attached to end of document)**

**TABLE 721.4.1(6)**  
**REINFORCED CLAY MASONRY COLUMNS**  
**(Table 721.4.1(6) attached to end of document)**

**721.4.2 Multiwythe walls.** The fire-resistance rating for walls or partitions consisting of two or more dissimilar wythes shall be permitted to be determined by the formula:

**(Equation 7-11 attached to end of document)**

**721.4.2.1 Multiwythe walls of different material.** For walls that consist of two or more wythes of different materials (concrete or concrete masonry units) in combination with clay masonry units, the fire-resistance rating of the different materials shall be permitted to be determined from Table 721.2.1.1 for concrete; Table 721.3.2 for concrete masonry units or Table 721.4.1(1) or 721.4.1(2) for clay and tile masonry units.

**721.4.3 Reinforced clay masonry lintels.** Fire-resistance ratings for clay masonry lintels shall be determined based on the nominal width of the lintel and the minimum covering for the longitudinal reinforcement in accordance with Table 721.4.1(5).

**721.4.4 Reinforced clay masonry columns.** The fire-resistance ratings shall be determined based on the last plan dimension of the column in accordance with Table 721.4.1(6). The minimum cover for longitudinal reinforcement shall be 2 inches (51 mm).

**721.5 Steel assemblies.** The provisions of this section contain procedures by which the fire-resistance ratings of steel assemblies are established by calculations.

**721.5.1 Structural steel columns.** The fire-resistance ratings of steel columns shall be based on the size of the element and the type of protection provided in accordance with this section.

**721.5.1.1 General.** These procedures establish a basis for determining the fire resistance of column assemblies as a function of the thickness of fire-resistant material and, the weight,  $W$ , and heated perimeter,  $D$ , of steel columns. As used in these sections,  $W$  is the average weight of a structural steel column in pounds per linear foot. The heated perimeter,  $D$ , is the inside perimeter of the fire-resistant material in inches as illustrated in Figure 721.5.1(1).

**721.5.1.1.1 Nonload-bearing protection.** The application of these procedures shall be limited to column assemblies in which the fire-resistant material is not designed to carry any of the load acting on the column.

**721.5.1.1.2 Embedments.** In the absence of substantiating fire-endurance test results, ducts, conduit, piping, and similar mechanical, electrical, and plumbing installations shall not be embedded in any required fire-resistant materials.

**721.5.1.1.3 Weight-to-perimeter ratio.** Table 721.5.1(1) contains weight-to-heated-perimeter ratios ( $W/D$ ) for both contour and box fire-resistant profiles, for the wide flange shapes most often used as columns. For different fire-resistant protection profiles or column cross sections, the weight-to-heated-perimeter ratios ( $W/D$ ) shall be determined in accordance with the definitions given in this section.

**721.5.1.2 Gypsum wallboard protection.** The fire resistance of structural steel columns with weight to-heated-perimeter ratios ( $W/D$ ) less than or equal to 3.65 and which are protected with Type X gypsum wallboard shall be permitted to be determined from the following expression:

**(Equation 7-12 attached to end of document)**

**721.5.1.2.1 Attachment.** The gypsum wallboard shall be supported as illustrated in either Figure 721.5.1(2) for fire-resistance ratings of 4 hours or less, or Figure 721.5.1(3) for fire-resistance ratings of 3 hours or less.

**FIGURE 721.5.1(1)**  
**DETERMINATION OF THE HEATED PERIMETER OF STRUCTURAL STEEL**  
**COLUMNS**

**(Figure 721.5.1(1) attached to end of document)**

**FIGURE 721.5.1(2)**  
**GYPSUM WALLBOARD PROTECTED STRUCTURAL STEEL COLUMNS**  
**WITH SHEET STEEL COLUMN COVERS**

**(Figure 721.5.1(2) attached to end of document)**

**FIGURE 721.5.1(3)**  
**GYPSUM WALLBOARD PROTECTED STRUCTURAL STEEL COLUMNS**  
**WITH STEEL STUD/SCREW ATTACHMENT SYSTEM**  
**(Figure 721.5.1(3) attached to end of document)**

**FIGURE 721.5.1(4)**  
**FIRE RESISTANCE OF STRUCTURAL STEEL COLUMNS**  
**PROTECTED WITH VARIOUS THICKNESSES OF TYPE X GYPSUM**  
**WALLBOARD**  
**(Figure 721.5.1(4) attached to end of document)**

**FIGURE 721.5.1(5)**  
**WIDE FLANGE STRUCTURAL STEEL COLUMNS WITH**  
**SPRAY-APPLIED FIRE-RESISTANT MATERIALS**  
**(Figure 721.5.1(5) attached to end of document)**

**FIGURE 721.5.1(6)**  
**CONCRETE PROTECTED STRUCTURAL STEEL COLUMNS<sup>a</sup>**  
**(Figure 721.5.1(6) attached to end of document)**

**FIGURE 721.5.1(7)**  
**CONCRETE OR CLAY MASONRY PROTECTED**  
**STRUCTURAL STEEL COLUMNS**  
**(Figure 721.5.1(7) attached to end of document)**

**721.5.1.2.2 Gypsum wallboard equivalent to concrete.** The determination of the fire resistance of structural steel columns from Figure 721.5.1(4) is permitted for various thicknesses of gypsum wallboard as a function of the weight-to-heated-perimeter ratio ( $W/D$ ) of the column. For structural steel columns with weight-to-heated-perimeter ratios ( $W/D$ ) greater than 3.65, the thickness of gypsum wallboard required for specified fire-resistance ratings shall be the same as the thickness determined for aW14 x 233 wide flange shape.

**721.5.1.3 Spray-applied fire-resistant materials.** The fire resistance of wide-flange structural steel columns protected with spray-applied fire-resistant materials, as illustrated in Figure 721.5.1(5), shall be permitted to be determined from the following expression:

**(Equation 7-13 attached to end of document)**

**721.5.1.3.1 Material-dependent constants.** The material-dependent constants,  $C1$  and  $C2$ , shall be determined for specific fire-resistant materials on the basis of standard fire endurance tests in accordance with Section 703.2. Unless evidence is submitted to the commissioner substantiating a broader



application, this expression shall be limited to determining the fire resistance of structural steel columns with weight-to-heated-perimeter ratios ( $W/D$ ) between the largest and smallest columns for which standard fire-endurance test results are available.

**721.5.1.3.2 Spray-applied identification.** Spray-applied fire-resistant materials shall be identified by density and thickness required for a given fire-resistance rating.

**721.5.1.4 Concrete-protected columns.** The fire resistance of structural steel columns protected with concrete, as illustrated in Figure 721.5.1(6) (a) and (b), shall be permitted to be determined from the following expression:

**(Equation 7-14 attached to end of document)**

**721.5.1.4.1 Reentrant space filled.** For wide-flange steel columns completely encased in concrete with all reentrant spaces filled [Figure 721.5.1(6)(c)], the thermal capacity of the concrete within the reentrant spaces shall be permitted to be added to the thermal capacity of the steel column, as follows:

**(Equation 7-15 attached to end of document)**

**721.5.1.4.2 Concrete properties unknown.** If specific data on the properties of concrete are not available, the values given in Table 721.5.1(2) are permitted.

**721.5.1.4.3 Minimum concrete cover.** For structural steel column encased in concrete with all reentrant spaces filled, Figure 721.5.1(6)(c) and Tables 721.5.1(7) and 721.5.1(8) indicate the thickness of concrete cover required for various fire-resistance ratings for typical wide-flange sections. The thicknesses of concrete indicated in these tables also apply to structural steel columns larger than those listed.

**721.5.1.4.4 Minimum precast concrete cover.** For structural steel columns protected with precast concrete column covers as shown in Figure 721.5.1(6)(a), Tables 721.5.1(9) and 721.5.1(10) indicate the thickness of the column covers required for various fire-resistance ratings for typical wide-flange shapes. The thicknesses of concrete given in these tables also apply to structural steel columns larger than those listed.

**721.5.1.4.5 Masonry protection.** The fire resistance of structural steel columns protected with concrete masonry units or clay masonry units as illustrated in Figure 721.5.1(7), shall be permitted to be determined from the following expression:

**(Equation 7-16 attached to end of document)**

**721.5.1.4.6 Equivalent concrete masonry thickness.** For structural steel columns protected with concrete masonry, Table 721.5.1(5) gives the equivalent thickness of concrete masonry required for various fire-resistance ratings for typical column shapes. For structural steel columns protected with clay masonry, Table 721.5.1(6) gives the equivalent thickness of concrete masonry required for various fire-resistance ratings for typical column shapes.

**TABLE 721.5.1(1)**  
**W/DRATIOS FOR STEEL COLUMNS**  
**(Table 721.5.1(1) attached to end of document)**

**TABLE 721.5.1(2)**  
**PROPERTIES OF CONCRETE**  
**(Table 721.5.1(2) attached to end of document)**

**TABLE 721.5.1(3)**  
**THERMAL CONDUCTIVITY OF CONCRETE OR CLAY**  
**MASONRY UNITS**  
**(Table 721.5.1(3) attached to end of document)**

**TABLE 721.5.1(4)**  
**WEIGHT-TO-HEATED-PERIMETER RATIOS (W/D)**  
**FOR TYPICAL WIDE FLANGE BEAM AND GIRDER SHAPES**  
**(Table 721.5.1(4) attached to end of document)**

**TABLE 721.5.1(5)**  
**FIRE RESISTANCE OF CONCRETE MASONRY PROTECTED STEEL**  
**COLUMNS**  
**(Table 721.5.1(5) attached to end of document)**

**TABLE 721.5.1(6)**  
**FIRE RESISTANCE OF CLAY MASONRY PROTECTED STEEL COLUMNS**  
**(Table 721.5.1(6) attached to end of document)**

**TABLE 721.5.1(7)**  
**MINIMUM COVER (inch) FOR STEEL COLUMNS**  
**ENCASED IN NORMAL-WEIGHT CONCRETE<sup>a</sup>**  
**[FIGURE 721.5.1(6)(c)]**  
**(Table 721.5.1(7) attached to end of document)**

**TABLE 721.5.1(8)**  
**MINIMUM COVER (inch) FOR STEEL COLUMNS ENCASED IN**  
**STRUCTURAL LIGHTWEIGHT CONCRETE<sup>a</sup>**

**[FIGURE 721.5.1(6)(c)]**

**(Table 721.5.1(8) attached to end of document)**

**TABLE 721.5.1(9)**

**MINIMUM COVER (inch) FOR STEEL COLUMNS  
IN NORMAL-WEIGHT PRECAST COVERS<sup>a</sup>**

**[FIGURE 721.5.1(6)(a)]**

**(Table 721.5.1(9) attached to end of document)**

**TABLE 721.5.1(10)**

**MINIMUM COVER (inch) FOR STEEL COLUMNS  
IN STRUCTURAL LIGHTWEIGHT PRECAST COVERS<sup>a</sup>**

**[FIGURE 721.5.1(6)(a)]**

**(Table 721.5.1(10) attached to end of document)**

**721.5.2 Structural steel beams and girders.** The fire-resistance ratings of steel beams and girders shall be based upon the size of the element and the type of protection provided in accordance with this section.

**721.5.2.1 Determination of fire resistance** These procedures establish a basis for determining resistance of structural steel beams and girders which differ in size from that specified in approved fire-resistant assemblies as a function of the thickness of fire-resistant material and the weight ( $W$ ) and heated perimeter ( $D$ ) of the beam or girder. As used in these sections,  $W$  is the average weight of a structural steel member in pounds per linear foot (plf). The heated perimeter,  $D$ , is the inside perimeter of the fire-resistant material in inches as illustrated in Figure 721.5.2.

**721.5.2.1.1 Weight-to-heated perimeter.** The weight-to-heated-perimeter ratios ( $W/D$ ), for both contour and box fire-resistant protection profiles, for the wide flange shapes most often used as beams or girders are given in Table 721.5.1(4). For different shapes, the weight-to-heated-perimeter ratios ( $W/D$ ) shall be determined in accordance with the definitions given in this section.

**721.5.2.1.2 Beam and girder substitutions.** Except as provided for in Section 721.5.2.2, structural steel beams in approved fire-resistant assemblies shall be considered the minimum permissible size. Other beam or girder shapes shall be permitted to be substituted provided that the weight-to-heated-perimeter ratio ( $W/D$ ) of the substitute beam is equal to or greater than that of the beam specified in the approved assembly.

**721.5.2.2 Spray-applied fire-resistant materials.** The provisions in this section apply to unrestrained structural steel beams and girders protected with spray-applied fire-resistant materials. Larger or smaller unrestrained beam and girder shapes shall be permitted to be substituted for beams specified in approved

unrestrained or restrained fire-resistant assemblies provided that the thickness of the fire-resistant material is adjusted in accordance with the following expression:

**(Equation 7-17 attached to end of document)**

**721.5.2.2.1 Minimum thickness.** Equation 7-17 is limited to beams with a weight-to-heated-perimeter ratio ( $W/D$ ) of 0.37 or greater. The minimum thickness of fire-resistant material shall not be less than 3/8 inch (9.5 mm).

**721.5.2.3 Structural steel trusses.** The fire resistance of structural steel trusses protected with fire-resistant materials spray applied to each of the individual truss elements shall be permitted to be determined in accordance with this section. The thickness of the fire-resistant material shall be determined in accordance with Section 721.5.1.3. The weight-to-heated-perimeter ratio ( $W/D$ ) of truss elements which can be simultaneously exposed to fire on all sides shall be determined on the same basis as columns, as specified in Section 721.5.1.1. The weight-to-heated-perimeter ratio ( $W/D$ ) of truss elements which directly support floor or roof construction shall be determined on the same basis as beams and girders, as specified in Section 721.5.2.1.

**FIGURE 721.5.2**  
**DETERMINATION OF THE HEATED PERIMETER**  
**OF STRUCTURAL STEEL BEAMS AND GIRDERS**  
**(Figure 721.5.2 attached to end of document)**

**721.6 Wood assemblies.** The provisions of this section contain procedures by which the fire-resistance ratings of wood assemblies are established by calculations.

**721.6.1 General.** This section contains procedures for calculating the fire-resistance ratings of walls, floor/ceiling and roof/ceiling assemblies based in part on the standard method of testing referenced in Section 703.2.

**721.6.1.1 Maximum fire-resistance rating.** Fire-resistance ratings calculated using the procedures in this section shall be used only for 1-hour rated assemblies.

**721.6.1.2 Dissimilar membranes.** Where dissimilar membranes are used on a wall assembly, the calculation shall be made from the least fire-resistant (weaker) side.

**721.6.2 Walls, floors and roofs.** These procedures apply to both load-bearing and nonload-bearing assemblies.

**721.6.2.1 Fire-resistance rating of wood frame assemblies.** The fire-resistance rating of a wood frame assembly is equal to the sum of the time assigned to the membrane on the fire-exposed side, the time assigned to the framing members

and the time assigned for additional contribution by other protective measures such as insulation. The membrane on the unexposed side shall not be included in determining the fire resistance of the assembly.

**721.6.2.2 Time assigned to membranes.** Table 721.6.2(1) indicates the time assigned to membranes on the fire-exposed side.

**721.6.2.3 Exterior walls.** For an exterior wall having more than 5 feet (1524 mm) of horizontal separation, the wall is assigned a rating dependent on the interior membrane and the framing as described in Tables 721.6.2(1) and 721.6.2(2). The membrane on the outside of the nonfire-exposed side of exterior walls having more than 5 feet (1524 mm) of horizontal separation may consist of sheathing, sheathing paper, and siding as described in Table 721.6.2(3).

**721.6.2.4 Floors and roofs.** In the case of a floor or roof, the standard test provides only for testing for fire exposure from below. Except as noted in Section 703.3, Item 5, floor or roof assemblies of wood framing shall have an upper membrane consisting of a subfloor and finished floor conforming to Table 721.6.2(4) or any other membrane that has a contribution to fire resistance of at least 15 minutes in Table 721.6.2(1).

**721.6.2.5 Additional protection.** Table 721.6.2(5) indicates the time increments to be added to the fire resistance where glass fiber, rock wool, slag mineral wool, or cellulose insulation is incorporated in the assembly.

**721.6.2.6 Fastening.** Fastening of wood frame assemblies and the fastening of membranes to the wood framing members shall be done in accordance with Chapter 23.

**TABLE 721.6.2(1)**  
**TIME ASSIGNED TO WALLBOARD MEMBRANES<sup>a,b,c,d</sup>**  
**(Table 721.6.2(1) attached to end of document)**

**TABLE 721.6.2(2)**  
**TIME ASSIGNED FOR CONTRIBUTION OF WOOD FRAME<sup>a,b,c</sup>**  
**(Table 721.6.2(2) attached to end of document)**

**TABLE 721.6.2(3)**  
**MEMBRANE<sup>a</sup> ON EXTERIOR FACE OF WOOD STUD WALLS**  
**(Table 721.6.2(3) attached to end of document)**

**TABLE 721.6.2(4)**  
**FLOORING OR ROOFING OVER WOOD FRAMING<sup>a</sup>**  
**(Table 721.6.2(4) attached to end of document)**

**TABLE 721.6.2(5) TIME ASSIGNED FOR ADDITIONAL PROTECTION**  
**(Table 721.6.2(5) attached to end of document)**

**(Equations 7-18 through 7-21 attached to end of document)**

**721.6.3.1 Equation 7-21.** Equation 7-21 applies only where the unexposed face represents the smaller side of the column. If a column is recessed into a wall, its full dimension shall be used for the purpose of these calculations.

**721.6.3.2 Allowable loads.** Allowable loads on beams and columns are determined using design values given in ANSI/AF&PA NDS.

**721.6.3.3 Fastener protection.** Where minimum 1-hour fire resistance is required, connectors and fasteners shall be protected from fire exposure by 1½ inches (38 mm) of wood, or other approved covering or coating for a 1-hour rating. Typical details for commonly used fasteners and connectors are shown in AITC Technical Note 7.

**721.6.3.4 Minimum size.** Wood members are limited to dimensions of 6 inches (152 mm) nominal or greater. Glued-laminated timber beams utilize standard laminating combinations except that a core lamination is removed. The tension zone is moved inward and the equivalent of an extra nominal 2-inch-thick (51 mm) outer tension lamination is added.

**721.7 Other reference documents.** Refer to Section 703.3, Item 1, and NBS BMS 71 and NBSTRBM-44 for fire-resistance ratings of materials and assemblies.

**FIGURE 721.6.3(1)**  
**LOAD FIGURE**

**(Figure 721.6.3(1) attached to end of document)**

**FIGURE 721.6.3(2)**  
**EFFECTIVE LENGTH FACTORS**

**(Figure 721.6.3(2) attached to end of document)**

$$A_e = A + (A_f \times F_{co}) \quad (\text{Equation 7-1})$$

where:

$A_e$  = Equivalent area of protected openings.

$A$  = Actual area of protected openings.

$A_f$  = Area of exterior wall surface in the story under consideration exclusive of openings, on which the temperature limitations of ASTM E 119 for walls are exceeded.

$F_{co}$  = An "equivalent opening factor" derived from Figure 704.7 based on the average temperature of the unexposed wall surface and the fire-resistance rating of the wall.

$$\frac{A}{a} + \frac{A_u}{a_u} \leq 1.0 \quad (\text{Equation 7-2})$$

where:

$A$  = Actual area of protected openings, or the equivalent area of protected openings,  $A_e$  (see Section 704.7).

$a$  = Allowable area of protected openings.

$A_u$  = Actual area of unprotected openings.

$a_u$  = Allowable area of unprotected openings.

$$t + \left( \frac{4t}{s} - 1 \right) \left( t_e - t \right) \quad (\text{Equation 7-3})$$

where:

$s$  = Spacing of ribs or undulations.

$t$  = Minimum thickness.

$t_e$  = Equivalent thickness of the panel calculated as the net cross-sectional area of the panel divided by the width, in which the maximum thickness used in the calculation shall not exceed  $2t$ .

$$R = (R_1^{0.59} + R_2^{0.59} + \dots + R_n^{0.59})^{1.7} \quad (\text{Equation 7-4})$$

where:

$R$  = The fire endurance of the assembly, minutes.

$R_1, R_2,$  and  $R_n$  = The fire endurances of the individual wythes, minutes. Values of  $R_n^{0.59}$  for use in Equation 7-4 are given in Table 721.2.1.2(1). Calculated fire-resistance ratings are shown in Table 721.2.1.2(2).

$$t + \left( \frac{4t}{s} - 1 \right) \left( t_e - t \right) \quad (\text{Equation 7-5})$$

where:

$s$  = Spacing of ribs or undulations.

$t$  = Minimum thickness.

$t_e$  = Equivalent thickness of the slab calculated as the net area of the slab divided by the width, in which the maximum thickness used in the calculation shall not exceed  $2t$ .

$$T_{ca} = T_e + T_{cf} \quad (\text{Equation 7-6})$$

$T_e = V_n/LH$  = Equivalent thickness of concrete masonry unit (inch) (mm).

where:

$V_n$  = Net volume of masonry unit (inch<sup>3</sup>) (mm<sup>3</sup>).

$L$  = Specified length of masonry unit (inch) (mm).

$H$  = Specified height of masonry unit (inch) (mm).

$$R_A = (R_1^{0.59} + R_2^{0.59} + \dots + R_n^{0.59} + A_1 + A_2 + \dots + A_n)^{1.7} \quad (\text{Equation 7-7})$$

where:

$R_A$  = Fire endurance rating of the assembly (hours).

$R_1, R_2, \dots, R_n$  = Fire endurance rating of wythes for 1, 2,  $n$  (hours), respectively.

$A_1, A_2, \dots, A_n$  = 0.30, factor for each continuous airspace for 1, 2,  $\dots, n$ , respectively, having a depth of  $1/2$  inch (12.7 mm) or more between wythes.

$$T_e = V_n/LH \quad (\text{Equation 7-8})$$

where:

$T_e$  = The equivalent thickness of the clay masonry unit (inches).

$V_n$  = The net volume of the clay masonry unit (inch<sup>3</sup>).

$L$  = The specified length of the clay masonry unit (inches).

$H$  = The specified height of the clay masonry unit (inches).

$$R = (R_n^{0.59} + pl)^{1.7} \quad (\text{Equation 7-9})$$

where:

$R$  = The fire endurance of the assembly (hours).

$R_n$  = The fire endurance of the individual wall (hours).

$pl$  = Coefficient for thickness of plaster.

Values for  $R_n^{0.59}$  for use in Equation 7-9 are given in Table 721.4.1(3). Coefficients for thickness of plaster shall be selected from Table 721.4.1(4) based on the actual thickness of plaster applied to the wall or partition and whether one or two sides of the wall are plastered.

$$R = (R_1^{0.59} + R_2^{0.59} + \dots + R_n^{0.59} + as)^{1.7} \quad (\text{Equation 7-10})$$

where:

$R$  = The fire endurance of the assembly (hours).

$R_1, R_2$  and  $R_n$  = The fire endurance of the individual wythes (hours).

$as$  = Coefficient for continuous airspace.

Values for  $R_n^{0.59}$  for use in Equation 7-10 are given in Table 721.4.1(3). The coefficient for each continuous airspace of  $1/2$  inch to  $3 1/2$  inches (12.7 to 89 mm) separating two individual wythes shall be 0.3.



$$R = (R_1^{0.59} + R_2^{0.59} + \dots + R_n^{0.59})^{1.7} \quad (\text{Equation 7-11})$$

where:

$R$  = The fire endurance of the assembly (hours).

$R_1, R_2$  and  $R_n$  = The fire endurance of the individual wythes (hours).

Values for  $R_n^{0.59}$  for use in Equation 7-11 are given in Table 721.4.1(3).

$$R = 130 \left[ \frac{h(W/D)}{2} \right]^{0.75} \quad (\text{Equation 7-12})$$

where:

$R$  = Fire resistance (minutes).

$h$  = Total thickness of gypsum wallboard (inches).

$D$  = Heated perimeter of the structural steel column (inches).

$W'$  = Total weight of the structural steel column and gypsum wallboard protection (pounds per linear foot).

$W'$  =  $W + 50hD/144$ .

$$R = [C_1 (W/D) + C_2] h \quad (\text{Equation 7-13})$$

where:

$R$  = Fire resistance (minutes).

$h$  = Thickness of spray-applied fire-resistant material (inches).

$D$  = Heated perimeter of the structural steel column (inches).

$C_1$  and  $C_2$  = Material-dependent constants.

$W$  = Weight of structural steel column (pounds per linear foot).

$$R = R_o (1 + 0.03m) \quad (\text{Equation 7-14})$$

where:

$$R_o = 10 (W/D)^{0.7} + 17 (h^{1.6}/k_c^{0.2}) \times (1 + 26 (H/p_c c_h (L + h))^{0.8})$$

As used in these expressions:

$R$  = Fire endurance at equilibrium moisture conditions (minutes).

$R_o$  = Fire endurance at zero moisture content (minutes).

$m$  = Equilibrium moisture content of the concrete by volume (percent).

$W$  = Average weight of the steel column (pounds per linear foot).

$D$  = Heated perimeter of the steel column (inches).

$h$  = Thickness of the concrete cover (inches).

$k_c$  = Ambient temperature thermal conductivity of the concrete (Btu/hr ft °F).

$H$  = Ambient temperature thermal capacity of the steel column =  $0.11W$  (Btu/ft °F).

$p_c$  = Concrete density (pounds per cubic foot).

$c_c$  = Ambient temperature specific heat of concrete (Btu/lb °F).

$L$  = Interior dimension of one side of a square concrete box protection (inches).

$$H = 0.11W + (p_c c_c / 144) (b_f d - A_s) \quad (\text{Equation 7-15})$$

where:

$b_f$  = Flange width of the steel column (inches).

$d$  = Depth of the steel column (inches).

$A_s$  = Cross-sectional area of the steel column (square inches).

$$R = 0.17 (W/D)^{0.7} + [0.285 (T_e^{1.6}/K^{0.2})] \\ [1.0 + 42.7 \{ (A_s/d_m T_e) / (0.25p + T_e) \}^{0.8}] \quad \text{(Equation 7-16)}$$

where:

$R$  = Fire-resistance rating of column assembly (hours).

$W$  = Average weight of steel column (pounds per foot).

$D$  = Heated perimeter of steel column (inches) [see Figure 721.5.1(7)].

$T_e$  = Equivalent thickness of concrete or clay masonry unit (inches) (see Table 721.3.2 Note a or Section 721.4.1).

$K$  = Thermal conductivity of concrete or clay masonry unit (Btu/hr ft °F) [see Table 721.5.1(3)].

$A_s$  = Cross-sectional area of steel column (square inches).

$d_m$  = Density of the concrete or clay masonry unit (pounds per cubic foot).

$p$  = Inner perimeter of concrete or clay masonry protection (inches) [see Figure 721.5.1(7)].

$$h_2 = \left[ \frac{(W_1 / D_1) + 0.60}{(W_2 / D_2) + 0.60} \right] h_1 \quad \text{(Equation 7-17)}$$

where:

$h$  = Thickness of spray-applied fire-resistant material in inches.

$W$  = Weight of the structural steel beam or girder in pounds per linear foot.

$D$  = Heated perimeter of the structural steel beam or girder in inches.

Subscript 1 refers to the beam and fire-resistant material thickness in the approved assembly.

Beams:  $2.54Zb (4 - 2(b/d))$  for beams which may be exposed to fire on four sides. (Equation 7-18)

$2.54Zb (4 - (b/d))$  for beams which may be exposed to fire on three sides. (Equation 7-19)

Columns:  $2.54Zd (3 - (d/b))$  for columns which may be exposed to fire on four sides (Equation 7-20)

$2.54Zd (3 - (d/2b))$  for columns which may be exposed to fire on three sides. (Equation 7-21)

where:

$b$  = The breadth (width) of a beam or larger side of a column before exposure to fire (inches).

$d$  = The depth of a beam or smaller side of a column before exposure to fire (inches).

$Z$  = Load factor, based on Figure 720.6.3(1).

$$F = F_{dc} + K(WA\Delta P)/2(W-d) \quad \text{(Equation 9-1)}$$

where:

$A$  = Door area, square feet (m<sup>2</sup>).

$d$  = Distance from door handle to latch edge of door, feet (m).

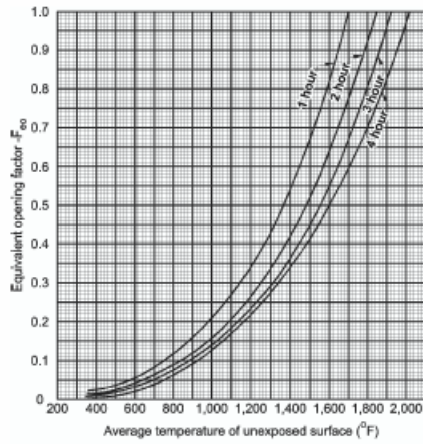
$F$  = Total door opening force, pounds (N).

$F_{dc}$  = Force required to overcome closing device, pounds (N).

$K$  = Coefficient 5.2 (1.0).

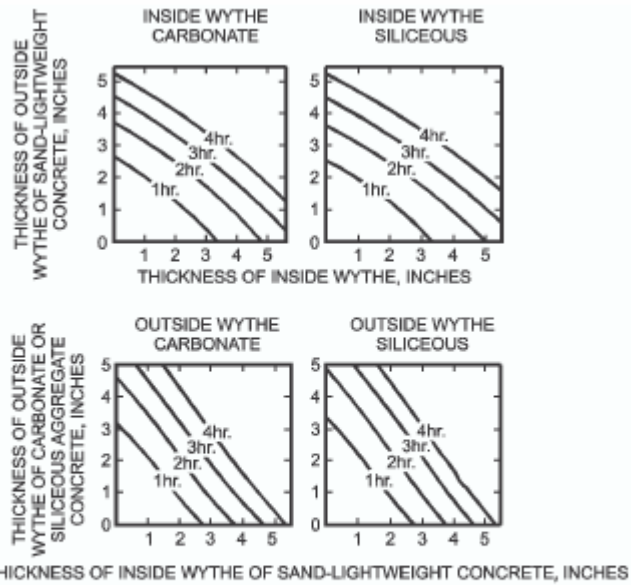
$W$  = Door width, feet (m).

$\Delta P$  = Design pressure difference, inches of water (Pa).



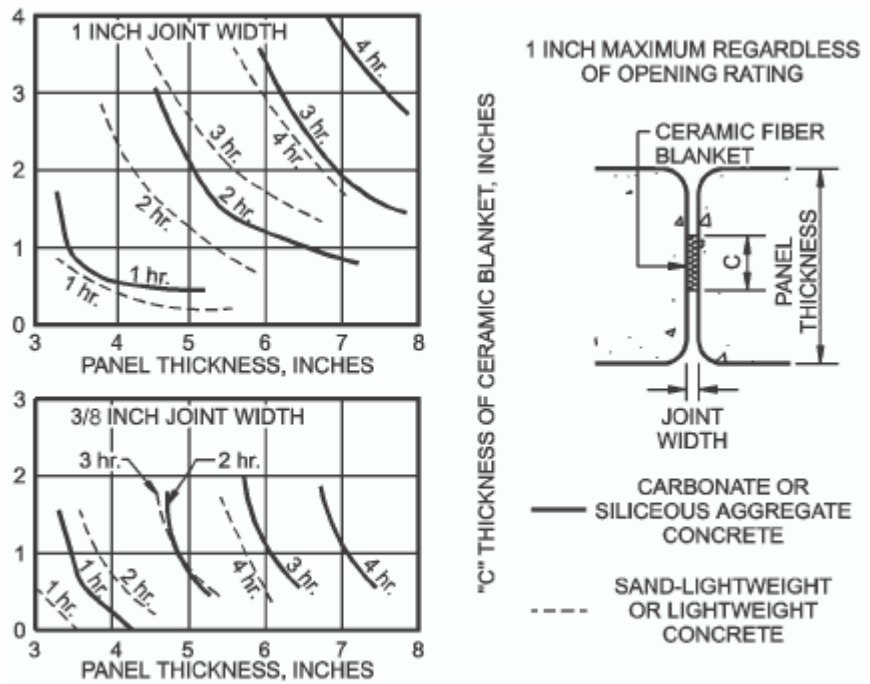
For SI:  $^{\circ}\text{C} = [(^{\circ}\text{F}) - 32] / 1.8$ .

FIGURE 704.7  
EQUIVALENT OPENING FACTOR



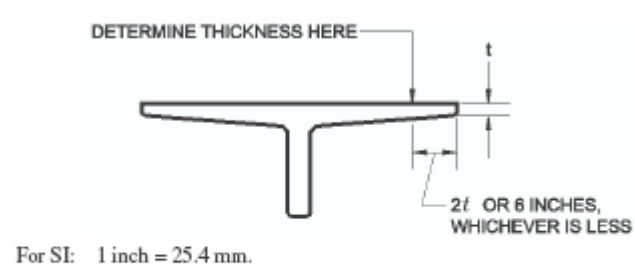
For SI: 1 inch = 25.4 mm.

**FIGURE 721.2.1.2  
FIRE-RESISTANCE RATINGS OF  
TWO-WYTHE CONCRETE WALLS**

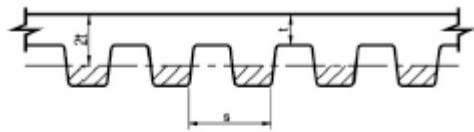


For SI: 1 inch = 25.4 mm.

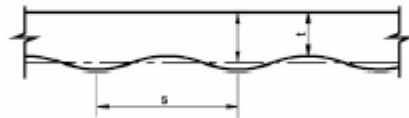
**FIGURE 721.2.1.3.1  
CERAMIC FIBER JOINT PROTECTION**



**FIGURE 721.2.2.1.2**  
**DETERMINATION OF SLAB THICKNESS**  
**FOR SLOPING SOFFITS**

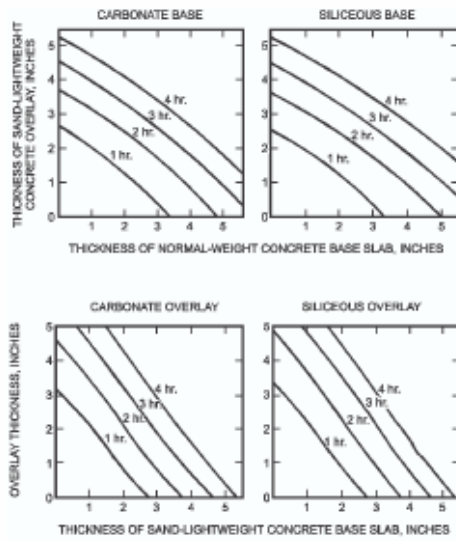


NEGLECT SHADED AREA IN CALCULATION OF EQUIVALENT THICKNESS



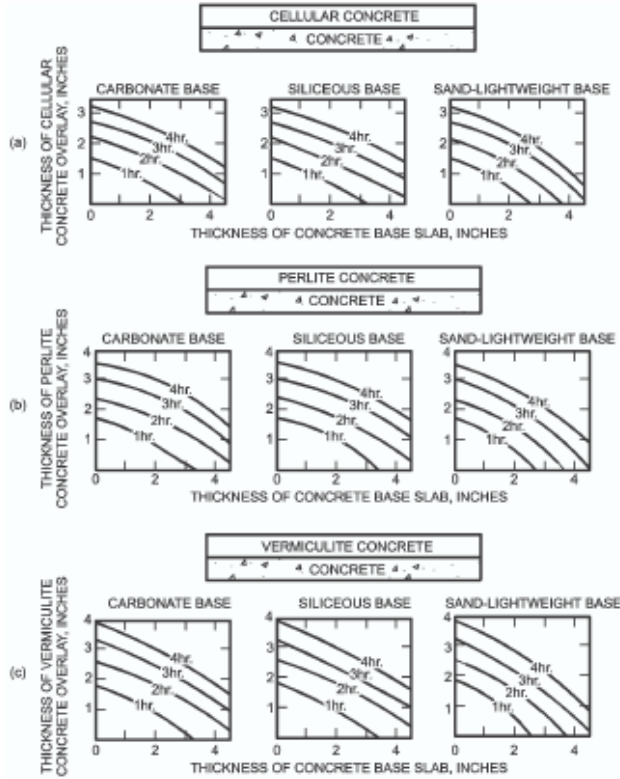
For SI: 1 inch = 25.4 mm.

**FIGURE 721.2.2.1.3**  
**SLABS WITH RIBBED OR UNDULATING SOFFITS**



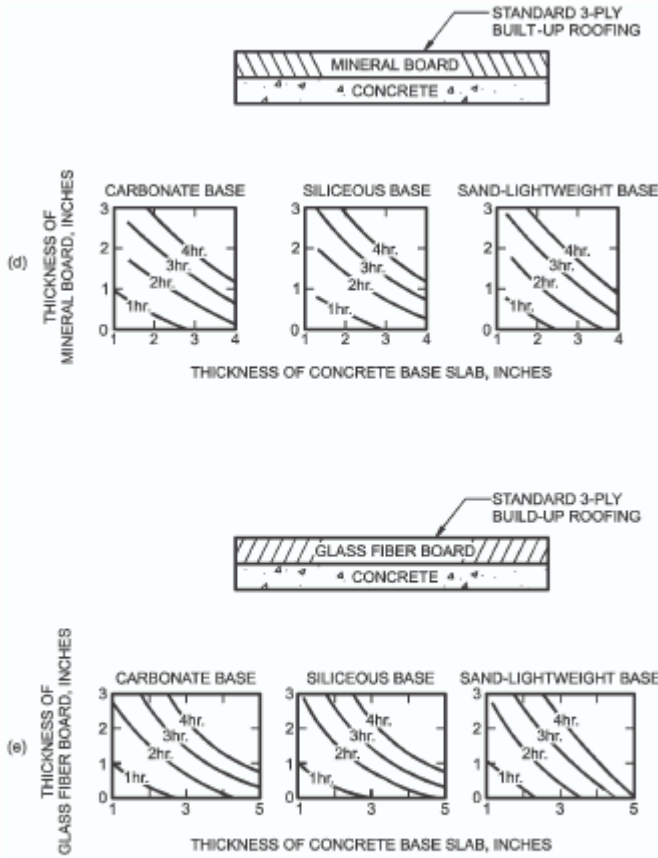
For SI: 1 inch = 25.4 mm.

**FIGURE 721.2.2.2  
FIRE-RESISTANCE RATINGS FOR TWO-COURSE  
CONCRETE FLOORS**



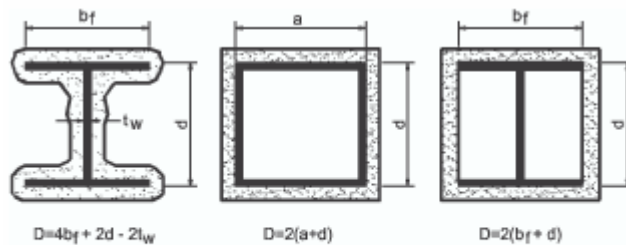
For SI: 1 inch = 25.4 mm.

**FIGURE 721.2.2.3(1)  
FIRE-RESISTANCE RATINGS FOR CONCRETE  
ROOF ASSEMBLIES**

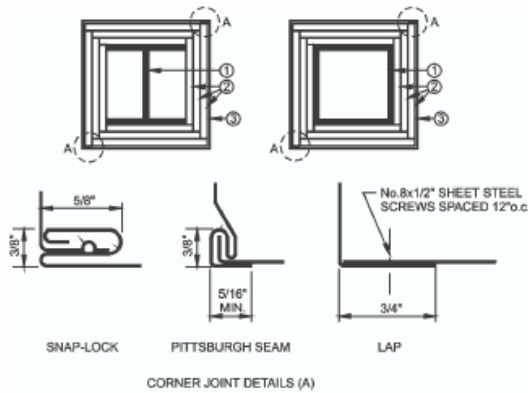


For SI: 1 inch = 25.4 mm.

**FIGURE 721.2.2.3(2)**  
**FIRE-RESISTANCE RATINGS FOR CONCRETE**  
**ROOF ASSEMBLIES**



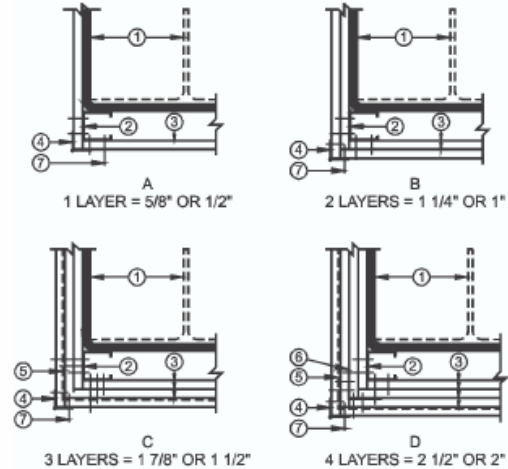
**FIGURE 721.5.1(1)**  
**DETERMINATION OF THE HEATED PERIMETER**  
**OF STRUCTURAL STEEL COLUMNS**



**FIGURE 721.5.1(2)**  
**GYPSON WALLBOARD PROTECTED STRUCTURAL STEEL**  
**COLUMNS WITH SHEET STEEL COLUMN COVERS**

For SI: 1 inch = 25.4 mm, 1 foot = 305 mm.

- Structural steel column, either wide flange or tubular shapes.
- Type X gypsum wallboard in accordance with ASTM C 36. For single-layer applications, the wallboard shall be applied vertically with no horizontal joints. For multiple-layer applications, horizontal joints are permitted at a minimum spacing of 8 feet, provided that the joints in successive layers are staggered at least 12 inches. The total required thickness of wallboard shall be determined on the basis of the specified fire-resistance rating and the weight-to-heated-perimeter ratio ( $W/D$ ) of the column. For fire-resistance ratings of 2 hours or less, one of the required layers of gypsum wallboard may be applied to the exterior of the sheet steel column covers with 1-inch long Type S screws spaced 1 inch from the wallboard edge and 8 inches on center. For such installations, 0.0149-inch minimum thickness galvanized steel corner beads with 1 1/2-inch legs shall be attached to the wallboard with Type S screws spaced 12 inches on center.
- For fire-resistance ratings of 3 hours or less, the column covers shall be fabricated from 0.0239-inch minimum thickness galvanized or stainless steel. For 4-hour fire-resistance ratings, the column covers shall be fabricated from 0.0239-inch minimum thickness stainless steel. The column covers shall be erected with the Snap Lock or Pittsburgh joint details. For fire-resistance ratings of 2 hours or less, column covers fabricated from 0.0269-inch minimum thickness galvanized or stainless steel shall be permitted to be erected with lap joints. The lap joints shall be permitted to be located anywhere around the perimeter of the column cover. The lap joints shall be secured with 1/2-inch-long No. 8 sheet metal screws spaced 12 inches on center. The column covers shall be provided with a minimum expansion clearance of 1/8 inch per linear foot between the ends of the cover and any restraining construction.

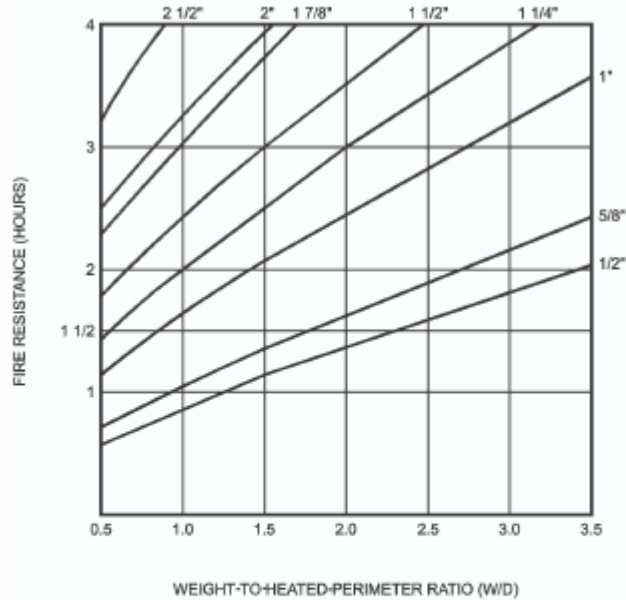


**FIGURE 721.5.1(3)**  
**GYPSON WALLBOARD PROTECTED STRUCTURAL STEEL**  
**COLUMNS WITH STEEL STUD/SCREW ATTACHMENT SYSTEM**

For SI: 1 inch = 25.4 mm, 1 foot = 305 mm.

- Structural steel column, either wide flange or tubular shapes.
- 1 3/8-inch deep studs fabricated from 0.0179-inch minimum thickness galvanized steel with 1 5/16 or 1 7/16-inch legs. The length of the steel studs shall be 1/2 inch less than the height of the assembly.
- Type X gypsum wallboard in accordance with ASTM C 36. For single-layer applications, the wallboard shall be applied vertically with no horizontal joints. For multiple-layer applications, horizontal joints are permitted at a minimum spacing of 8 feet, provided that the joints in successive layers are staggered at least 12 inches. The total required thickness of wallboard shall be determined on the basis of the specified fire-resistance rating and the weight-to-heated-perimeter ratio ( $W/D$ ) of the column.
- Galvanized 0.0149-inch minimum thickness steel corner beads with 1 1/2-inch legs attached to the wallboard with 1-inch-long Type S screws spaced 12 inches on center.
- No. 18 SWG steel tie wires spaced 24 inches on center.
- Sheet metal angles with 2-inch legs fabricated from 0.0221-inch minimum thickness galvanized steel.
- Type S screws, 1 inch long, shall be used for attaching the first layer of wallboard to the steel studs and the third layer to the sheet metal angles at 24 inches on center. Type S screws 1 3/4-inch long shall be used for attaching the second layer of wallboard to the steel studs and the fourth layer to the sheet metal angles at 12 inches on center. Type S screws 2 1/4 inches long shall be used for attaching the third layer of wallboard to the steel studs at 12 inches on center.

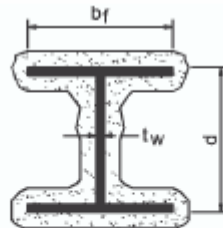




For SI: 1 inch = 25.4 mm, 1 pound per linear foot/inch = 0.059 kg/m/mm.

**FIGURE 721.5.1(4)**  
**FIRE RESISTANCE OF STRUCTURAL STEEL COLUMNS**  
**PROTECTED WITH VARIOUS THICKNESSES OF**  
**TYPE X GYPSUM WALLBOARD**

- a. The W/D ratios for typical wide flange columns are listed in Table 721.5.1(1). For other column shapes, the W/D ratios shall be determined in accordance with Section 720.5.1.1.



**FIGURE 721.5.1(5)**  
**WIDE FLANGE STRUCTURAL STEEL COLUMNS WITH**  
**SPRAY-APPLIED FIRE-RESISTANT MATERIALS**

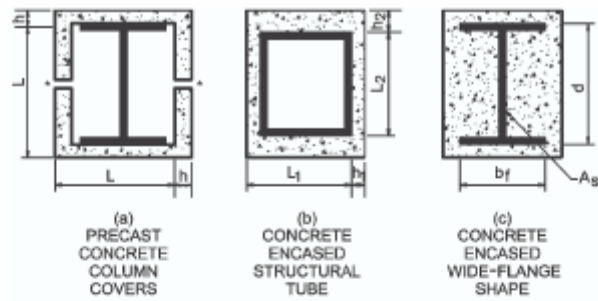
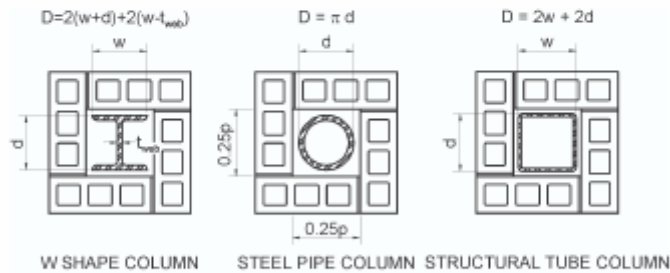


FIGURE 721.5.1(6)

**CONCRETE PROTECTED STRUCTURAL STEEL COLUMNS<sup>a</sup>**

- When the inside perimeter of the concrete protection is not square,  $L$  shall be taken as the average of  $L_1$  and  $L_2$ . When the thickness of concrete cover is not constant,  $h$  shall be taken as the average of  $h_1$  and  $h_2$ .
- Joints shall be protected with a minimum 1 inch thickness of ceramic fiber blanket but in no case less than one-half the thickness of the column cover (see Section 720.2.1.3).

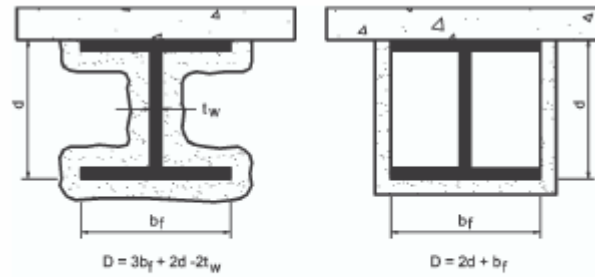


For SI: 1 inch = 25.4 mm.

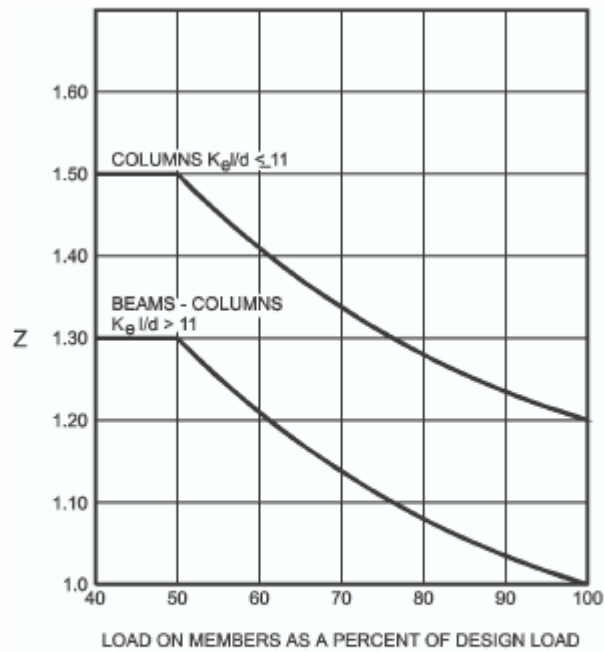
FIGURE 721.5.1(7)

**CONCRETE OR CLAY MASONRY PROTECTED STRUCTURAL STEEL COLUMNS**

- $d$  = Depth of a wide flange column, outside diameter of pipe column, or outside dimension of structural tubing column (inches).
- $t_{web}$  = Thickness of web of wide flange column (inches).
- $w$  = Width of flange of wide flange column (inches).



**FIGURE 721.5.2**  
**DETERMINATION OF THE HEATED PERIMETER**  
**OF STRUCTURAL STEEL BEAMS AND GIRDERS**



**FIGURE 721.6.3(1)**  
**LOAD FIGURE**

- $K_g$  = The effective length factor as noted in Figure 721.6.3(2).
- $l$  = The unsupported length of columns (inches).













BUCKLING MODES						
THEORETICAL $K_g$ VALUE	0.5	0.7	1.0	1.0	2.0	2.0
RECOMMENDED DESIGN $K_g$ WHEN IDEAL CONDITIONS APPROXIMATED	0.65	0.80	1.2	1.0	2.10	2.4
END CONDITION CODE						
			ROTATION FIXED, TRANSLATION FIXED	ROTATION FREE, TRANSLATION FIXED	ROTATION FIXED, TRANSLATION FREE	ROTATION FREE, TRANSLATION FREE

FIGURE 721.6.3(2)  
EFFECTIVE LENGTH FACTORS

**TABLE 704.8  
MAXIMUM AREA OF EXTERIOR WALL OPENINGS<sup>a,d</sup>**

<b>CLASSIFICATION OF OPENING</b>	<b>FIRE SEPARATION DISTANCE (feet)</b>							
	0 to 3 <sup>a,h</sup>	Greater than 3 and not more than 5 <sup>b</sup>	Greater than 5 and not more than 10 <sup>d,f</sup>	Greater than 10 and not more than 15 <sup>c,d,f</sup>	Greater than 15 and not more than 20 <sup>e,f</sup>	Greater than 20 and not more than 25 <sup>e,f</sup>	Greater than 25 and not more than 30 <sup>e,f</sup>	Greater than 30
Unprotected	Not Permitted <sup>e</sup>	Not Permitted <sup>b,g,k</sup>	10%	15%	25%	45%	70%	No Limit
Protected	Not Permitted <sup>i,j</sup>	15% <sup>k</sup>	25% <sup>k</sup>	45% <sup>k</sup>	75% <sup>k</sup>	No Limit <sup>k</sup>	No Limit <sup>k</sup>	No Limit

For SI: 1 foot = 304.8 mm.

- a. Values given are percentage of the area of the exterior wall.
- b. For occupancies in Group R-3, the maximum percentage of unprotected and protected exterior wall openings shall be 25 percent.
- c. The area of openings in an open parking structure with a fire separation distance of greater than 10 feet shall not be limited.
- d. For occupancies in Group H-2 or H-3, unprotected openings shall not be permitted for openings with a fire separation distance of 15 feet or less.
- e. For requirements for fire walls for buildings with differing roof heights, see Section 705.6.1.
- f. The area of unprotected and protected openings is not limited for occupancies in Group R-3, with a fire separation distance greater than 5 feet.
- g. Buildings whose exterior bearing wall, exterior nonbearing wall and exterior structural frame are not required to be fire-resistance rated shall be permitted to have unlimited unprotected openings.
- h. Includes accessory buildings to Group R-3.
- i. Protected openings through a wall or walls between buildings shall comply with Section 705.8.
- j. Protected openings within a fire separation distance of 3 feet or less are permitted for buildings classified in Occupancy Groups R-2 and R-3 provided such openings do not exceed 10% of the area of the façade of the story in which they are located. These openings shall not be credited towards meeting any mandatory natural light or ventilation requirements.
- k. In Groups R-2 and R-3 occupancies with an exterior separation distance greater than 3 feet, openings shall be in accordance with percentages indicated as "Protected" Classification of Opening in Table 704.8. However, such openings shall not be required to be protected.
- l. Upon special application, the commissioner may permit exterior wall openings to be constructed in excess of the permitted area established by Table 704.8 if such openings at the time of their construction are located at least sixty feet in a direct line from any neighboring building, unless otherwise permitted by Section 704.3 for buildings on the same lot. If any neighboring building is later altered or constructed to come within the above distance limitation, the affected exterior openings shall immediately be closed with construction meeting the fire-resistance rating requirements for exterior wall construction of the building in which they are located. Such additional openings shall not be credited toward meeting any of the mandatory natural light or ventilation requirements unless they also comply with applicable provisions of Chapter 12 and the zoning resolution.

**TABLE 705.4  
FIRE WALL FIRE-RESISTANCE RATINGS**

GROUP	FIRE-RESISTANCE RATING (hours)
A, B, E, H-4, I, R-1, R-2, U	3 <sup>a</sup>
F-1, H-3 <sup>b</sup> , H-5, M, S-1	3
H-1, H-2	4 <sup>b</sup>
F-2, S-2, R-3, R-4	2

a. Walls shall be not less than 2-hour fire-resistance rated where separating buildings of Type II or V construction.

b. For Group H-1, H-2 or H-3 buildings, also see Sections 415.4 and 415.5.

**TABLE 706.3.7  
FIRE-RESISTANCE RATING REQUIREMENTS FOR FIRE  
BARRIER ASSEMBLIES BETWEEN FIRE AREAS**

OCCUPANCY GROUP	FIRE-RESISTANCE RATING (hours)
H-1, H-2	4
F-1, H-3, S-1	3
A, B, E, F-2, H-4, H-5, I, M, R, S-2	2
U	1

**TABLE 715.3  
FIRE DOOR AND FIRE SHUTTER FIRE PROTECTION RATINGS**

<u>TYPE OF ASSEMBLY</u>	<u>REQUIRED ASSEMBLY RATING (hours)</u>	<u>MINIMUM FIRE DOOR AND FIRE SHUTTER ASSEMBLY RATING (hours)</u>
Fire walls and fire barriers having a required fire-resistance rating greater than 1 hour	4	$\frac{3}{4}$
	3	$\frac{3}{4}$ <sup>a</sup>
	2	$\frac{1}{2}$
	$\frac{1}{2}$	$\frac{1}{2}$
Fire barriers having a required fire-resistance rating of 1 hour: Shaft exit enclosure and exit passageway walls Other fire barriers	1	$\frac{1}{4}$
	$\frac{1}{2}$	$\frac{3}{4}$
Fire partitions: Corridor walls Other partitions	1	$\frac{3}{4}$
	$\frac{1}{2}$	$\frac{3}{4}$
Exterior walls	3	$\frac{1}{2}$
	2	$\frac{1}{2}$
	1	$\frac{3}{4}$

- a. Two doors, each with a fire protection rating of 1½-hours, installed on opposite sides of the same opening in a fire wall, shall be deemed equivalent in fire protection rating to one 3-hour fire door.

**TABLE 715.4  
FIRE WINDOW ASSEMBLY FIRE PROTECTION RATINGS**

<b>TYPE OF ASSEMBLY</b>	<b>REQUIRED ASSEMBLY RATING (hours)</b>	<b>MINIMUM FIRE WINDOW ASSEMBLY RATING (hours)</b>
Interior walls:		
Fire walls	All	NP <sup>a</sup>
Fire barriers and fire partitions	> 1	NP <sup>a</sup>
	1	<sup>3</sup> / <sub>4</sub>
Smoke barriers	1	<sup>3</sup> / <sub>4</sub>
Exterior walls	>1	1 <sup>1</sup> / <sub>2</sub>
	1	<sup>3</sup> / <sub>4</sub>
Party walls	All	NP <sup>a</sup>

a. Not permitted except as specified in Section 715.2.

**TABLE 715.4.3  
FIRE DOOR AND FIRE SHUTTER FIRE PROTECTION RATINGS**

<b><u>OPENING FIRE PROTECTION RATING</u></b>	<b><u>MAXIMUM AREA (square inches)</u></b>	<b><u>MAXIMUM HEIGHT (inches)</u></b>	<b><u>MAXIMUM WIDTH (inches)</u></b>
3 hours	0	0	0
1 ½ - hour doors in exterior walls	0	0	0
1 and 1 ½ hours	100	33	10
<sup>3</sup> / <sub>4</sub> hours	1,296	54	54
Fire window assemblies	1,296	54	54

For SI: 1 inch = 25.4 mm, 1 square inch = 645.2 mm<sup>2</sup>

**TABLE 716.3.1  
FIRE DAMPER RATING**

<b>TYPE OF PENETRATION</b>	<b>MINIMUM DAMPER RATING (hour)</b>
Less than 3-hour fire-resistance-rated assemblies	1.5
3-hour or greater fire-resistance-rated assemblies	3



**TABLE 720.1(1)  
MINIMUM PROTECTION OF STRUCTURAL PARTS BASED ON TIME PERIODS  
FOR VARIOUS NONCOMBUSTIBLE INSULATING MATERIALS<sup>m</sup>**

STRUCTURAL PARTS TO BE PROTECTED	ITEM NUMBER	INSULATING MATERIAL USED	MINIMUM THICKNESS OF INSULATING MATERIAL FOR THE FOLLOWING FIRE-RESISTANCE PERIODS (inches)			
			4 hour	3 hour	2 hour	1 hour
1. Steel columns and all of primary trusses	1-1.1	Carbonate, lightweight and sand-lightweight aggregate concrete, members 6" × 6" or greater (not including sandstone, granite and siliceous gravel). <sup>a</sup>	2½	2	1½	1
	1-1.2	Carbonate, lightweight and sand-lightweight aggregate concrete, members 8" × 8" or greater (not including sandstone, granite and siliceous gravel). <sup>a</sup>	2	1½	1	1
	1-1.3	Carbonate, lightweight and sand-lightweight aggregate concrete, members 12" × 12" or greater (not including sandstone, granite and siliceous gravel). <sup>a</sup>	1½	1	1	1
	1-1.4	Siliceous aggregate concrete and concrete excluded in Item 1-1.1, members 6" × 6" or greater. <sup>a</sup>	3	2	1½	1
	1-1.5	Siliceous aggregate concrete and concrete excluded in Item 1-1.1, members 8" × 8" or greater. <sup>a</sup>	2½	2	1	1
	1-1.6	Siliceous aggregate concrete and concrete excluded in Item 1-1.1, members 12" × 12" or greater. <sup>a</sup>	2	1	1	1
	1-2.1	Clay or shale brick with brick and mortar fill. <sup>a</sup>	3¾	—	—	2¼
	1-3.1	4" hollow clay tile in two 2" layers; ½" mortar between tile and column; ⅜" metal mesh 0.046" wire diameter in horizontal joints; tile fill. <sup>a</sup>	4	—	—	—
	1-3.2	2" hollow clay tile; ¾" mortar between tile and column; ⅜" metal mesh 0.046" wire diameter in horizontal joints; limestone concrete fill; <sup>a</sup> plastered with ¾" gypsum plaster.	3	—	—	—
	1-3.3	2" hollow clay tile with outside wire ties 0.08" diameter at each course of tile or ⅜" metal mesh 0.046" diameter wire in horizontal joints; limestone or trap-rock concrete fill <sup>1</sup> extending 1" outside column on all sides	—	—	3	—
	1-3.4	2" hollow clay tile with outside wire ties 0.08" diameter at each course of tile with or without concrete fill; ¾" mortar between tile and column.	—	—	—	2
	1-4.1	Cement plaster over metal lath wire tied to ¾" cold-rolled vertical channels with 0.049" (No. 18 B.W. gage) wire ties spaced 3" to 6" on center. Plaster mixed 1:2 ½ by volume, cement to sand.	—	—	2½ <sup>b</sup>	7/8
	1-5.1	Vermiculite concrete, 1:4 mix by volume over paperbacked wire fabric lath wrapped directly around column with additional 2" × 2" 0.065"/0.065" (No. 16/16 B.W. gage) wire fabric placed ¾" from outer concrete surface. Wire fabric tied with 0.049" (No. 18 B.W. gage) wire spaced 6" on center for inner layer and 2" on center for outer layer.	2	—	—	—
	1-6.1	Perlite or vermiculite gypsum plaster over metal lath wrapped around column and furred 1¼" from column flanges. Sheets lapped at ends and tied at 6" intervals with 0.049" (No. 18 B.W. gage) tie wire. Plaster pushed through to flanges.	1½	1	—	—
	1-6.2	Perlite or vermiculite gypsum plaster over self-furring metal lath wrapped directly around column, lapped 1" and tied at 6" intervals with 0.049" (No. 18 B.W. gage) wire.	1¾	1¾	1	—
	1-6.3	Perlite or vermiculite gypsum plaster on metal lath applied to ¾" cold-rolled channels spaced 24" apart vertically and wrapped flatwise around column.	1½	—	—	—
	1-6.4	Perlite or vermiculite gypsum plaster over two layers of ½" plain full-length gypsum lath applied tight to column flanges. Lath wrapped with 1" hexagonal mesh of No. 20 gage wire and tied with doubled 0.035" diameter (No. 18 B.W. gage) wire ties spaced 23" on center. For three-coat work, the plaster mix for the second coat shall not exceed 100 pounds of gypsum to 2½ cubic feet of aggregate for the 3-hour system.	2½	2	—	—

(continued)

**TABLE 720.1(1)—continued  
MINIMUM PROTECTION OF STRUCTURAL PARTS BASED ON TIME PERIODS  
FOR VARIOUS NONCOMBUSTIBLE INSULATING MATERIALS<sup>m</sup>**

STRUCTURAL PARTS TO BE PROTECTED	ITEM NUMBER	INSULATING MATERIAL USED	MINIMUM THICKNESS OF INSULATING MATERIAL FOR THE FOLLOWING FIRE-RESISTANCE PERIODS (inches)			
			4 hour	3 hour	2 hour	1 hour
1. Steel columns and all of primary trusses (continued)	1-6.5	Perlite or vermiculate gypsum plaster over one layer of 1/2" plain full-length gypsum lath applied tight to column flanges. Lath tied with doubled 0.049" (No. 18 B.W. gage) wire ties spaced 23" on center and scratch coat wrapped with 1" hexagonal mesh 0.035" (No. 20 B.W. gage) wire fabric. For three-coat work, the plaster mix for the second coat shall not exceed 100 pounds of gypsum to 2 1/2 cubic feet of aggregate.	—	2	—	—
	1-7.1	Multiple layers of 1/2" gypsum wallboard <sup>c</sup> adhesively <sup>d</sup> secured to column flanges and successive layers. Wallboard applied without horizontal joints. Corner edges of each layer staggered. Wallboard layer below outer layer secured to column with doubled 0.049" (No. 18 B.W. gage) steel wire ties spaced 15" on center. Exposed corners taped and treated.	—	—	2	1
	1-7.2	Three layers of 5/8" Type X gypsum wallboard. <sup>c</sup> First and second layer held in place by 1/8" diameter by 1 3/8" long ring shank nails with 5/16" diameter heads spaced 24" on center at corners. Middle layer also secured with metal straps at mid-height and 18" from each end, and by metal corner bead at each corner held by the metal straps. Third layer attached to corner bead with 1" long gypsum wallboard screws spaced 12" on center.	—	—	1 7/8	—
	1-7.3	Three layers of 5/8" Type X gypsum wallboard, <sup>c</sup> each layer screw attached to 1 5/8" steel studs 0.018" thick (No. 25 carbon sheet steel gage) at each corner of column. Middle layer also secured with 0.049" (No. 18 B.W. gage) double-strand steel wire ties, 24" on center. Screws are No. 6 by 1" spaced 24" on center for inner layer, No. 6 by 1 5/8" spaced 12" on center for middle layer and No. 8 by 2 1/4" spaced 12" on center for outer layer.	—	1 7/8	—	—
	1-8.1	Wood-fibered gypsum plaster mixed 1:1 by weight gypsum-to-sand aggregate applied over metal lath. Lath lapped 1" and tied 6" on center at all end, edges and spacers with 0.049" (No. 18 B.W. gage) steel tie wires. Lath applied over 1/2" spacers made of 3/4" furring channel with 2" legs bent around each corner. Spacers located 1" from top and bottom of member and a maximum of 40" on center and wire tied with a single strand of 0.049" (No. 18 B.W. gage) steel tie wires. Corner bead tied to the lath at 6" on center along each corner to provide plaster thickness.	—	—	1 5/8	—
2. Webs or flanges of steel beams and girders	2-1.1	Carbonate, lightweight and sand-lightweight aggregate concrete (not including sandstone, granite and siliceous gravel) with 3" or finer metal mesh placed 1" from the finished surface anchored to the top flange and providing not less than 0.025 square inch of steel area per foot in each direction.	2	1 1/2	1	1
	2-1.2	Siliceous aggregate concrete and concrete excluded in Item 2-1.1 with 3" or finer metal mesh placed 1" from the finished surface anchored to the top flange and providing not less than 0.025 square inch of steel area per foot in each direction.	2 1/2	2	1 1/2	1
	2-2.1	Cement plaster on metal lath attached to 3/4" cold-rolled channels with 0.049" (No. 18 B.W. gage) wire ties spaced 3" to 6" on center. Plaster mixed 1:2 1/2 by volume, cement to sand.	—	—	2 1/2 <sup>b</sup>	7/8
	2-3.1	Vermiculite gypsum plaster on a metal lath cage, wire tied to 0.165" diameter (No. 8 B.W. gage) steel wire hangers wrapped around beam and spaced 16" on center. Metal lath ties spaced approximately 5" on center at cage sides and bottom.	—	7/8	—	—

(continued)

**TABLE 720.1(1)—continued  
MINIMUM PROTECTION OF STRUCTURAL PARTS BASED ON TIME PERIODS  
FOR VARIOUS NONCOMBUSTIBLE INSULATING MATERIALS<sup>m</sup>**

STRUCTURAL PARTS TO BE PROTECTED	ITEM NUMBER	INSULATING MATERIAL USED	MINIMUM THICKNESS OF INSULATING MATERIAL FOR THE FOLLOWING FIRE-RESISTANCE PERIODS (inches)			
			4 hour	3 hour	2 hour	1 hour
2. Webs or flanges of steel beams and girders (continued)	2-4.1	Two layers of $5/8$ " Type X gypsum wallboard <sup>c</sup> are attached to U-shaped brackets spaced 24" on center. 0.018" thick (No. 25 carbon sheet steel gage) $1\frac{1}{8}$ " deep by 1" galvanized steel runner channels are first installed parallel to and on each side of the top beam flange to provide a $1/2$ " clearance to the flange. The channel runners are attached to steel deck or concrete floor construction with approved fasteners spaced 12" on center. U-shaped brackets are formed from members identical to the channel runners. At the bent portion of the U-shaped bracket, the flanges of the channel are cut out so that $1\frac{1}{8}$ " deep corner channels can be inserted without attachment parallel to each side of the lower flange.  As an alternate, 0.021" thick (No. 24 carbon sheet steel gage) 1" x 2" runner and corner angles may be used in lieu of channels, and the web cutouts in the U-shaped brackets may be omitted. Each angle is attached to the bracket with $1/2$ "-long No. 8 self-drilling screws. The vertical legs of the U-shaped bracket are attached to the runners with one $1/2$ " long No. 8 self-drilling screw. The completed steel framing provides a $2\frac{1}{8}$ " and $1\frac{1}{2}$ " space between the inner layer of wallboard and the sides and bottom of the steel beam, respectively. The inner layer of wallboard is attached to the top runners and bottom corner channels or corner angles with $1\frac{1}{4}$ "-long No. 6 self-drilling screws spaced 16" on center. The outer layer of wallboard is applied with $1\frac{3}{4}$ "-long No. 6 self-drilling screws spaced 8" on center. The bottom corners are reinforced with metal corner beads.	—	—	$1\frac{1}{4}$	—
	2-4.2	Three layers of $5/8$ " Type X gypsum wallboard <sup>c</sup> attached to a steel suspension system as described immediately above utilizing the 0.018" thick (No. 25 carbon sheet steel gage) 1" x 2" lower corner angles. The framing is located so that a $2\frac{1}{8}$ " and 2" space is provided between the inner layer of wallboard and the sides and bottom of the beam, respectively. The first two layers of wallboard are attached as described immediately above. A layer of 0.035" thick (No. 20 B.W. gage) 1" hexagonal galvanized wire mesh is applied under the soffit of the middle layer and up the sides approximately 2". The mesh is held in position with the No. 6 $1\frac{5}{8}$ "-long screws installed in the vertical leg of the bottom corner angles. The outer layer of wallboard is attached with No. 6 $2\frac{1}{4}$ "-long screws spaced 8" on center. One screw is also installed at the mid-depth of the bracket in each layer. Bottom corners are finished as described above.	—	$1\frac{7}{8}$	—	—
3. Bonded pretensioned reinforcement in prestressed concrete <sup>e</sup>	3-1.1	Carbonate, lightweight, sand-lightweight and siliceous <sup>f</sup> aggregate concrete Beams or girders	4 <sup>g</sup>	3 <sup>g</sup>	$2\frac{1}{2}$	$1\frac{1}{2}$
		Solid slabs <sup>h</sup>		2	$1\frac{1}{2}$	1
4. Bonded or unbonded post-tensioned tendons in prestressed concrete <sup>e,i</sup>	4-1.1	Carbonate, lightweight, sand-lightweight and siliceous <sup>f</sup> aggregate concrete Unrestrained members: Solid slabs <sup>h</sup> Beams and girders <sup>j</sup> 8" wide greater than 12" wide	—	2	$1\frac{1}{2}$	—
			3	$4\frac{1}{2}$ $2\frac{1}{2}$	$2\frac{1}{2}$ 2	$1\frac{3}{4}$ $1\frac{1}{2}$
	4-1.2	Carbonate, lightweight, sand-lightweight and siliceous aggregate Restrained members: <sup>k</sup> Solid slabs <sup>h</sup> Beams and girders <sup>j</sup> 8" wide greater than 12" wide	$1\frac{1}{4}$	1	$3/4$	—
			$2\frac{1}{2}$ 2	2 $1\frac{3}{4}$	$1\frac{3}{4}$ $1\frac{1}{2}$	— —

(continued)

**TABLE 720.1(1)—continued  
MINIMUM PROTECTION OF STRUCTURAL PARTS BASED ON TIME PERIODS  
FOR VARIOUS NONCOMBUSTIBLE INSULATING MATERIALS<sup>m</sup>**

STRUCTURAL PARTS TO BE PROTECTED	ITEM NUMBER	INSULATING MATERIAL USED	MINIMUM THICKNESS OF INSULATING MATERIAL FOR THE FOLLOWING FIRE-RESISTANCE PERIODS (inches)			
			4 hour	3 hour	2 hour	1 hour
5. Reinforcing steel in reinforced concrete columns, beams girders and trusses	5-1.1	Carbonate, lightweight and sand-lightweight aggregate concrete, members 12" or larger, square or round. (Size limit does not apply to beams and girders monolithic with floors.)	1½	1½	1½	1½
		Siliceous aggregate concrete, members 12" or larger, square or round. (Size limit does not apply to beams and girders monolithic with floors.)	2	1½	1½	1½
6. Reinforcing steel in reinforced concrete joists <sup>l</sup>	6-1.1	Carbonate, lightweight and sand-lightweight aggregate concrete.	1¼	1¼	1	¾
	6-1.2	Siliceous aggregate concrete.	1¾	1½	1	¾
7. Reinforcing and tie rods in floor and roof slabs <sup>l</sup>	7-1.1	Carbonate, lightweight and sand-lightweight aggregate concrete.	1	1	¾	¾
	7-1.2	Siliceous aggregate concrete.	1¼	1	1	¾

For SI: 1 inch = 25.4 mm, 1 square inch = 645.2 mm<sup>2</sup>, 1 cubic foot = 0.0283 m<sup>3</sup>.

- a. Reentrant parts of protected members to be filled solidly.
- b. Two layers of equal thickness with a ¾-inch airspace between.
- c. For all of the construction with gypsum wallboard described in Table 720.1(1), gypsum base for veneer plaster of the same size, thickness and core type shall be permitted to be substituted for gypsum wallboard, provided attachment is identical to that specified for the wallboard and the joints on the face layer are reinforced, and the entire surface is covered with a minimum of 1/16-inch gypsum veneer plaster.
- d. An approved adhesive qualified under ASTM E 119.
- e. Where lightweight or sand-lightweight concrete having an oven-dry weight of 110 pounds per cubic foot or less is used, the tabulated minimum cover shall be permitted to be reduced 25 percent, except that in no case shall the cover be less than ¾ inch in slabs or 1½ inches in beams or girders.
- f. For solid slabs of siliceous aggregate concrete, increase tendon cover 20 percent.
- g. Adequate provisions against spalling shall be provided by U-shaped or hooked stirrups spaced not to exceed the depth of the member with a clear cover of 1 inch.
- h. Prestressed slabs shall have a thickness not less than that required in Table 720.1(3) for the respective fire resistance time period.
- i. Fire coverage and end anchorages shall be as follows: Cover to the prestressing steel at the anchor shall be ½ inch greater than that required away from the anchor. Minimum cover to steel-bearing plate shall be 1 inch in beams and ¾ inch in slabs.
- j. For beam widths between 8 inches and 12 inches, cover thickness shall be permitted to be determined by interpolation.
- k. Interior spans of continuous slabs, beams and girders shall be permitted to be considered restrained.
- l. For use with concrete slabs having a comparable fire endurance where members are framed into the structure in such a manner as to provide equivalent performance to that of monolithic concrete construction.
- m. Generic fire-resistance ratings (those not designated as PROPRIETARY\* in the listing) in GA 600 shall be accepted as if herein listed.

**TABLE 720.1(2)**  
**RATED FIRE-RESISTANCE PERIODS FOR VARIOUS WALLS AND PARTITIONS <sup>a, b, p</sup>**

MATERIAL	ITEM NUMBER	CONSTRUCTION	MINIMUM FINISHED THICKNESS FACE-TO-FACE <sup>b</sup> (inches)			
			4 hour	3 hour	2 hour	1 hour
1. Brick of clay or shale	1-1.1	Solid brick of clay or shale <sup>c</sup>	6	4.9	3.8	2.7
	1-1.2	Hollow brick, not filled.	5.0	4.3	3.4	2.3
	1-1.3	Hollow brick unit wall, grout or filled with perlite vermiculite or expanded shale aggregate.	6.6	5.5	4.4	3.0
	1-2.1	4" nominal thick units at least 75 percent solid backed with a hat-shaped metal furring channel <sup>3</sup> / <sub>4</sub> " thick formed from 0.021" sheet metal attached to the brick wall on 24" centers with approved fasteners, and <sup>1</sup> / <sub>2</sub> " Type X gypsum wallboard attached to the metal furring strips with 1"-long Type S screws spaced 8" on center.	—	—	5 <sup>d</sup>	—
2. Combination of clay brick and load-bearing hollow clay tile	2-1.1	4" solid brick and 4" tile (at least 40 percent solid).	—	8	—	—
	2-1.2	4" solid brick and 8" tile (at least 40 percent solid).	12	—	—	—
3. Concrete masonry units	3-1.1 <sup>e, g</sup>	Expanded slag or pumice.	4.7	4.0	3.2	2.1
	3-1.2 <sup>e, g</sup>	Expanded clay, shale or slate.	5.1	4.4	3.6	2.6
	3-1.3 <sup>f</sup>	Limestone, cinders or air-cooled slag.	5.9	5.0	4.0	2.7
	3-1.4 <sup>e, g</sup>	Calcareous or siliceous gravel.	6.2	5.3	4.2	2.8
4. Solid concrete <sup>h, i</sup>	4-1.1	Siliceous aggregate concrete.	7.0	6.2	5.0	3.5
		Carbonate aggregate concrete.	6.6	5.7	4.6	3.2
		Sand-lightweight concrete.	5.4	4.6	3.8	2.7
		Lightweight concrete.	5.1	4.4	3.6	2.5
5. Glazed or unglazed facing tile, nonload-bearing	5-1.1	One 2" unit cored 15 percent maximum and one 4" unit cored 25 percent maximum with <sup>3</sup> / <sub>4</sub> " mortar-filled collar joint. Unit positions reversed in alternate courses.	—	6 <sup>3</sup> / <sub>8</sub>	—	—
	5-1.2	One 2" unit cored 15 percent maximum and one 4" unit cored 40 percent maximum with <sup>3</sup> / <sub>4</sub> " mortar-filled collar joint. Unit positions side with <sup>3</sup> / <sub>4</sub> " gypsum plaster. Two wythes tied together every fourth course with No. 22 gage corrugated metal ties.	—	6 <sup>3</sup> / <sub>4</sub>	—	—
	5-1.3	One unit with three cells in wall thickness, cored 29 percent maximum.	—	—	6	—
	5-1.4	One 2" unit cored 22 percent maximum and one 4" unit cored 41 percent maximum with <sup>1</sup> / <sub>4</sub> " mortar-filled collar joint. Two wythes tied together every third course with 0.030" (No. 22 galvanized sheet steel gage) corrugated metal ties.	—	—	6	—
	5-1.5	One 4" unit cored 25 percent maximum with <sup>3</sup> / <sub>4</sub> " gypsum plaster on one side.	—	—	4 <sup>3</sup> / <sub>4</sub>	—
	5-1.6	One 4" unit with two cells in wall thickness, cored 22 percent maximum.	—	—	—	4
	5-1.7	One 4" unit cored 30 percent maximum with <sup>3</sup> / <sub>4</sub> " vermiculite gypsum plaster on one side.	—	—	4 <sup>1</sup> / <sub>2</sub>	—
	5-1.8	One 4" unit cored 39 percent maximum with <sup>3</sup> / <sub>4</sub> " gypsum plaster on one side.	—	—	—	4 <sup>1</sup> / <sub>2</sub>

(continued)

**TABLE 720.1(2)—continued**  
**RATED FIRE-RESISTANCE PERIODS FOR VARIOUS WALLS AND PARTITIONS <sup>a,o,p</sup>**

MATERIAL	ITEM NUMBER	CONSTRUCTION	MINIMUM FINISHED THICKNESS FACE-TO-FACE <sup>b</sup> (inches)			
			4 hour	3 hour	2 hour	1 hour
6. Solid gypsum plaster	6-1.1	$\frac{3}{4}$ " by 0.055" (No. 16 carbon sheet steel gage) vertical cold-rolled channels, 16" on center with 2.6-pound flat metal lath applied to one face and tied with 0.049" (No. 18 B.W. Gage) wire at 6" spacing. Gypsum plaster each side mixed 1:2 by weight, gypsum to sand aggregate.	—	—	—	2 <sup>d</sup>
	6-1.2	$\frac{3}{4}$ " by 0.055" (No. 16 carbon sheet steel gage) cold-rolled channels 16" on center with metal lath applied to one face and tied with 0.049" (No. 18 B.W. gage) wire at 6" spacing. Perlite or vermiculite gypsum plaster each side. For three-coat work, the plaster mix for the second coat shall not exceed 100 pounds of gypsum to 2 $\frac{1}{2}$ cubic feet of aggregate for the 1-hour system.	—	—	2 $\frac{1}{2}$ <sup>d</sup>	2 <sup>d</sup>
	6-1.3	$\frac{3}{4}$ " by 0.055" (No. 16 carbon sheet steel gage) vertical cold-rolled channels, 16" on center with $\frac{3}{8}$ " gypsum lath applied to one face and attached with sheet metal clips. Gypsum plaster each side mixed 1:2 by weight, gypsum to sand aggregate.	—	—	—	2 <sup>d</sup>
	6-2.1	Studless with $\frac{1}{2}$ " full-length plain gypsum lath and gypsum plaster each side. Plaster mixed 1:1 for scratch coat and 1:2 for brown coat, by weight, gypsum to sand aggregate.	—	—	—	2 <sup>d</sup>
	6-2.2	Studless with $\frac{1}{2}$ " full-length plain gypsum lath and perlite or vermiculite gypsum plaster each side.	—	—	2 $\frac{1}{2}$ <sup>d</sup>	2 <sup>d</sup>
	6-2.3	Studless partition with $\frac{3}{8}$ " rib metal lath installed vertically adjacent edges tied 6" on center with No. 18 gage wire ties, gypsum plaster each side mixed 1:2 by weight, gypsum to sand aggregate.	—	—	—	2 <sup>d</sup>
7. Solid perlite and portland cement	7-1.1	Perlite mixed in the ratio of 3 cubic feet to 100 pounds of portland cement and machine applied to stud side of 1 $\frac{1}{2}$ " mesh by 0.058-inch (No. 17 B.W. gage) paper-backed woven wire fabric lath wire-tied to 4"-deep steel trussed wire studs 16" on center. Wire ties of 0.049" (No. 18 B.W. gage) galvanized steel wire 6" on center vertically.	—	—	3 $\frac{1}{8}$ <sup>d</sup>	—
8. Solid neat wood fibered gypsum plaster	8-1.1	$\frac{3}{4}$ " by 0.055-inch (No. 16 carbon sheet steel gage) cold-rolled channels, 12" on center with 2.5-pound flat metal lath applied to one face and tied with 0.049" (No. 18 B.W. gage) wire at 6" spacing. Neat gypsum plaster applied each side.	—	—	2 <sup>d</sup>	—
9. Solid wallboard partition	9-1.1	One full-length layer $\frac{1}{2}$ " Type X gypsum wallboard <sup>e</sup> laminated to each side of 1" full-length V-edge gypsum coreboard with approved laminating compound. Vertical joints of face layer and coreboard staggered at least 3".	—	—	2 <sup>d</sup>	—
10. Hollow (studless) gypsum wallboard partition	10-1.1	One full-length layer of $\frac{5}{8}$ " Type X gypsum wallboard <sup>e</sup> attached to both sides of wood or metal top and bottom runners laminated to each side of 1" x 6" full-length gypsum coreboard ribs spaced 24" on center with approved laminating compound. Ribs centered at vertical joints of face plies and joints staggered 24" in opposing faces. Ribs may be recessed 6" from the top and bottom.	—	—	—	2 $\frac{1}{4}$ <sup>d</sup>
	10-1.2	1" regular gypsum V-edge full-length backing board attached to both sides of wood or metal top and bottom runners with nails or 1 $\frac{5}{8}$ " drywall screws at 24" on center. Minimum width of runners 1 $\frac{5}{8}$ ". Face layer of $\frac{1}{2}$ " regular full-length gypsum wallboard laminated to outer faces of backing board with approved laminating compound.	—	—	4 $\frac{5}{8}$ <sup>d</sup>	—

(continued)

**TABLE 720.1(2)—continued  
RATED FIRE-RESISTANCE PERIODS FOR VARIOUS WALLS AND PARTITIONS <sup>a,c,p</sup>**

MATERIAL	ITEM NUMBER	CONSTRUCTION	MINIMUM FINISHED THICKNESS FACE-TO-FACE <sup>b</sup> (inches)			
			4 hour	3 hour	2 hour	1 hour
11. Noncombustible studs—interior partition with plaster each side	11-1.1	3 1/4" x 0.044" (No. 18 carbon sheet steel gage) steel studs spaced 24" on center. 5/8" gypsum plaster on metal lath each side mixed 1:2 by weight, gypsum to sand aggregate.	—	—	—	4 3/4 <sup>d</sup>
	11-1.2	3 3/8" x 0.055" (No. 16 carbon sheet steel gage) approved nailable <sup>e</sup> studs spaced 24" on center. 5/8" neat gypsum wood-fibered plaster each side over 3/8" rib metal lath nailed to studs with 6d common nails, 8" on center. Nails driven 1 1/4" and bent over.	—	—	5 5/8	—
	11-1.3	4" x 0.044" (No. 18 carbon sheet steel gage) channel-shaped steel studs at 16" on center. On each side approved resilient clips pressed onto stud flange at 16" vertical spacing. 1/4" pencil rods snapped into or wire tied onto outer loop of clips, metal lath wire-tied to pencil rods at 6" intervals, 1" perlite gypsum plaster, each side.	—	7 5/8 <sup>d</sup>	—	—
	11-1.4	2 1/2" x 0.044" (No. 18 carbon sheet steel gage) steel studs spaced 16" on center. Wood fibered gypsum plaster mixed 1:1 by weight gypsum to sand aggregate applied on 3/4"-pound metal lath wire tied to studs, each side. 3/4" plaster applied over each face, including finish coat.	—	—	4 1/4 <sup>d</sup>	—
12. Wood studs interior partition with plaster each side	12-1.1 <sup>1,m</sup>	2" x 4" wood studs 16" on center with 5/8" gypsum plaster on metal lath. Lath attached by 4d common nails bent over or No. 14 gage by 1 1/4" by 3/4" crown width staples spaced 6" on center. Plaster mixed 1:1 1/2 for scratch coat and 1:3 for brown coat, by weight, gypsum to sand aggregate.	—	—	—	5 1/8
	12-1.2 <sup>1</sup>	2" x 4" wood studs 16" on center with metal lath and 7/8" neat wood-fibered gypsum plaster each side. Lath attached by 6d common nails, 7" on center. Nails driven 1 1/4" and bent over.	—	—	5 1/2 <sup>d</sup>	—
	12-1.3 <sup>1</sup>	2" x 4" wood studs 16" on center with 3/8" perforated or plain gypsum lath and 1/2" gypsum plaster each side. Lath nailed with 1 1/8" by No. 13 gage by 1 9/64" head plasterboard blue nails, 4" on center. Plaster mixed 1:2 by weight, gypsum to sand aggregate.	—	—	—	5 1/4
	12-1.4 <sup>1</sup>	2" x 4" wood studs 16" on center with 3/8" Type X gypsum lath and 1/2" gypsum plaster each side. Lath nailed with 1 1/8" by No. 13 gage by 1 9/64" head plasterboard blue nails, 5" on center. Plaster mixed 1:2 by weight, gypsum to sand aggregate.	—	—	—	5 1/4
13. Noncombustible studs—interior partition with gypsum wallboard each side	13-1.1	0.018" (No. 25 carbon sheet steel gage) channel-shaped studs 24" on center with one full-length layer of 5/8" Type X gypsum wallboard <sup>a</sup> applied vertically attached with 1" long No. 6 drywall screws to each stud. Screws are 8" on center around the perimeter and 12" on center on the intermediate stud. The wallboard may be applied horizontally when attached to 3 5/8" studs and the horizontal joints are staggered with those on the opposite side. Screws for the horizontal application shall be 8" on center at vertical edges and 12" on center at intermediate studs.	—	—	—	2 7/8 <sup>d</sup>
	13-1.2	0.018" (No. 25 carbon sheet steel gage) channel-shaped studs 25" on center with two full-length layers of 1/2" Type X gypsum wallboard <sup>a</sup> applied vertically each side. First layer attached with 1"-long, No. 6 drywall screws, 8" on center around the perimeter and 12" on center on the intermediate stud. Second layer applied with vertical joints offset one stud space from first layer using 1 5/8" long, No. 6 drywall screws spaced 9" on center along vertical joints, 12" on center at intermediate studs and 24" on center along top and bottom runners.	—	—	3 5/8 <sup>d</sup>	—
	13-1.3	0.055" (No. 16 carbon sheet steel gage) approved nailable metal studs <sup>c</sup> 24" on center with full-length 5/8" Type X gypsum wallboard <sup>a</sup> applied vertically and nailed 7" on center with 6d cement-coated common nails. Approved metal fastener grips used with nails at vertical butt joints along studs.	—	—	—	4 7/8

(continued)

**TABLE 720.1(2)—continued**  
**RATED FIRE-RESISTANCE PERIODS FOR VARIOUS WALLS AND PARTITIONS a.o.p**

MATERIAL	ITEM NUMBER	CONSTRUCTION	MINIMUM FINISHED THICKNESS FACE-TO-FACE <sup>b</sup> (inches)			
			4 hour	3 hour	2 hour	1 hour
14. Wood studs—interior partition with gypsum wallboard each side	14-1.1 <sup>h,m</sup>	2" × 4" wood studs 16" on center with two layers of 3/8" regular gypsum wallboard <sup>c</sup> each side, 4d cooler <sup>a</sup> or wallboard <sup>a</sup> nails at 8" on center first layer, 5d cooler <sup>a</sup> or wallboard <sup>a</sup> nails at 8" on center second layer with laminating compound between layers, joints staggered. First layer applied full length vertically, second layer applied horizontally or vertically	—	—	—	5
	14-1.2 <sup>l,m</sup>	2" × 4" wood studs 16" on center with two layers 1/2" regular gypsum wallboard <sup>c</sup> applied vertically or horizontally each side <sup>k</sup> , joints staggered. Nail base layer with 5d cooler <sup>a</sup> or wallboard <sup>a</sup> nails at 8" on center face layer with 8d cooler <sup>a</sup> or wallboard <sup>a</sup> nails at 8" on center.	—	—	—	5 1/2
	14-1.3 <sup>l,m</sup>	2" × 4" wood studs 24" on center with 5/8" Type X gypsum wallboard <sup>c</sup> applied vertically or horizontally nailed with 6d cooler <sup>a</sup> or wallboard <sup>a</sup> nails at 7" on center with end joints on nailing members. Stagger joints each side.	—	—	—	4 3/4
	14-1.4 <sup>l</sup>	2" × 4" fire-retardant-treated wood studs spaced 24" on center with one layer of 5/8" Type X gypsum wallboard <sup>c</sup> applied with face paper grain (long dimension) parallel to studs. Wallboard attached with 6d cooler <sup>a</sup> or wallboard <sup>a</sup> nails at 7" on center.	—	—	—	4 3/4 <sup>d</sup>
	14-1.5 <sup>l,m</sup>	2" × 4" wood studs 16" on center with two layers 5/8" Type X gypsum wallboard <sup>c</sup> each side. Base layers applied vertically and nailed with 6d cooler <sup>a</sup> or wallboard <sup>a</sup> nails at 9" on center. Face layer applied vertically or horizontally and nailed with 8d cooler <sup>a</sup> or wallboard <sup>a</sup> nails at 7" on center. For nail-adhesive application, base layers are nailed 6" on center. Face layers applied with coating of approved wallboard adhesive and nailed 12" on center.	—	—	6	—
	14-1.6 <sup>l</sup>	2" × 3" fire-retardant-treated wood studs spaced 24" on center with one layer of 5/8" Type X gypsum wallboard <sup>c</sup> applied with face paper grain (long dimension) at right angles to studs. Wallboard attached with 6d cement-coated box nails spaced 7" on center.	—	—	—	3 5/8 <sup>d</sup>
15. Exterior or interior walls	15-1.1 <sup>l,m</sup>	Exterior surface with 3/4" drop siding over 1/2" gypsum sheathing on 2" × 4" wood studs at 16" on center, interior surface treatment as required for 1-hour-rated exterior or interior 2" × 4" wood stud partitions. Gypsum sheathing nailed with 1 3/4" by No. 11 gage by 7/16" head galvanized nails at 8" on center. Siding nailed with 7d galvanized smooth box nails.	—	—	—	Varies
	15-1.2 <sup>h,m</sup>	2" × 4" wood studs 16" on center with metal lath and 3/4" cement plaster on each side. Lath attached with 6d common nails 7" on center driven to 1" minimum penetration and bent over. Plaster mix 1:4 for scratch coat and 1:5 for brown coat, by volume, cement to sand.	—	—	—	5 3/8
	15-1.3 <sup>l,m</sup>	2" × 4" wood studs 16" on center with 7/8" cement plaster (measured from the face of studs) on the exterior surface with interior surface treatment as required for interior wood stud partitions in this table. Plaster mix 1:4 for scratch coat and 1:5 for brown coat, by volume, cement to sand.	—	—	—	Varies
	15-1.4	3 5/8" No. 16 gage noncombustible studs 16" on center with 7/8" cement plaster (measured from the face of the studs) on the exterior surface with interior surface treatment as required for interior, nonbearing, noncombustible stud partitions in this table. Plaster mix 1:4 for scratch coat and 1:5 for brown coat, by volume, cement to sand.	—	—	—	Varies <sup>d</sup>

(continued)



**TABLE 720.1(2)—continued**  
**RATED FIRE-RESISTANCE PERIODS FOR VARIOUS WALLS AND PARTITIONS <sup>a,o,p</sup>**

MATERIAL	ITEM NUMBER	CONSTRUCTION	MINIMUM FINISHED THICKNESS FACE-TO-FACE <sup>b</sup> (inches)			
			4 hour	3 hour	2 hour	1 hour
15. Exterior or interior walls (continued)	15-1.5 <sup>m</sup>	2 1/4" x 3 3/4" clay face brick with cored holes over 1/2" gypsum sheathing on exterior surface of 2" x 4" wood studs at 16" on center and two layers 5/8" Type X gypsum wallboard <sup>c</sup> on interior surface. Sheathing placed horizontally or vertically with vertical joints over studs nailed 6" on center with 1 3/4" x No. 11 gage by 7/16" head galvanized nails. Inner layer of wallboard placed horizontally or vertically and nailed 8" on center with 6d cooler <sup>a</sup> or wallboard <sup>a</sup> nails. Outer layer of wallboard placed horizontally or vertically and nailed 8" on center with 8d cooler <sup>a</sup> or wallboard <sup>a</sup> nails. All joints staggered with vertical joints over studs. Outer layer joints taped and finished with compound. Nail heads covered with joint compound. 0.035 inch (No. 20 galvanized sheet gage) corrugated galvanized steel wall ties 3/4" by 6 3/8" attached to each stud with two 8d cooler <sup>a</sup> or wallboard <sup>a</sup> nails every sixth course of bricks.	—	—	10	—
	15-1.6 <sup>l,m</sup>	2" x 6" fire-retardant-treated wood studs 16" on center. Interior face has two layers of 5/8" Type X gypsum with the base layer placed vertically and attached with 6d box nails 12" on center. The face layer is placed horizontally and attached with 8d box nails 8" on center at joints and 12" on center elsewhere. The exterior face has a base layer of 5/8" Type X gypsum sheathing placed vertically with 6d box nails 8" on center at joints and 12" on center elsewhere. An approved building paper is next applied, followed by self-furred exterior lath attached with 2 1/2", No. 12 gage galvanized roofing nails with a 3/8" diameter head and spaced 6" on center along each stud. Cement plaster consisting of a 1/2" brown coat is then applied. The scratch coat is mixed in the proportion of 1:3 by weight, cement to sand with 10 pounds of hydrated lime and 3 pounds of approved additives or admixtures per sack of cement. The brown coat is mixed in the proportion of 1:4 by weight, cement to sand with the same amounts of hydrated lime and approved additives or admixtures used in the scratch coat.	—	—	8 1/4	—
	15-1.7 <sup>l,m</sup>	2" x 6" wood studs 16" on center. The exterior face has a layer of 5/8" Type X gypsum sheathing placed vertically with 6d box nails 8" on center at joints and 12" on center elsewhere. An approved building paper is next applied, followed by 1" by No. 18 gage self-furred exterior lath attached with 8d by 2 1/2" long galvanized roofing nails spaced 6" on center along each stud. Cement plaster consisting of a 1/2" scratch coat, a bonding agent and a 1/2" brown coat and a finish coat is then applied. The scratch coat is mixed in the proportion of 1:3 by weight, cement to sand with 10 pounds of hydrated lime and 3 pounds of approved additives or admixtures per sack of cement. The brown coat is mixed in the proportion of 1:4 by weight, cement to sand with the same amounts of hydrated lime and approved additives or admixtures used in the scratch coat. The interior is covered with 3/8" gypsum lath with 1" hexagonal mesh of 0.035 inch (No. 20 B.W. gage) woven wire lath furred out 5/16" and 1" perlite or vermiculite gypsum plaster. Lath nailed with 1 1/8" by No. 13 gage by 19/64" head plasterboard glued nails spaced 5" on center. Mesh attached by 1 3/4" by No. 12 gage by 3/8" head nails with 3/8" furrings, spaced 8" on center. The plaster mix shall not exceed 100 pounds of gypsum to 2 1/2 cubic feet of aggregate.	—	—	8 3/8	—
	15-1.8 <sup>l,m</sup>	2" x 6" wood studs 16" on center. The exterior face has a layer of 5/8" Type X gypsum sheathing placed vertically with 6d box nails 8" on center at joints and 12" on center elsewhere. An approved building paper is next applied, followed by 1 1/2" by No. 17 gage self-furred exterior lath attached with 8d by 2 1/2" long galvanized roofing nails spaced 6" on center along each stud. Cement plaster consisting of a 1/2" scratch coat, and a 1/2" brown coat is then applied. The plaster may be placed by machine. The scratch coat is mixed in the proportion of 1:4 by weight, plastic cement to sand. The brown coat is mixed in the proportion of 1:5 by weight, plastic cement to sand. The interior is covered with 3/8" gypsum lath with 1" hexagonal mesh of No. 20 gage woven wire lath furred out 5/16" and 1" perlite or vermiculite gypsum plaster. Lath nailed with 1 1/8" by No. 13 gage by 19/64" head plasterboard glued nails spaced 5" on center. Mesh attached by 1 3/4" by No. 12 gage by 3/8" head nails with 3/8" furrings, spaced 8" on center. The plaster mix shall not exceed 100 pounds of gypsum to 2 1/2 cubic feet of aggregate.	—	—	8 3/8	—

(continued)

**TABLE 720.1(2)—continued  
RATED FIRE-RESISTANCE PERIODS FOR VARIOUS WALLS AND PARTITIONS <sup>a,o,p</sup>**

MATERIAL	ITEM NUMBER	CONSTRUCTION	MINIMUM FINISHED THICKNESS FACE-TO-FACE <sup>b</sup> (inches)			
			4 hour	3 hour	2 hour	1 hour
15. Exterior or interior walls (continued)	15-1.9	4" No. 18 gage, nonload-bearing metal studs, 16" on center, with 1" portland cement lime plaster [measured from the back side of the 3/4-pound expanded metal lath] on the exterior surface. Interior surface to be covered with 1" of gypsum plaster on 3/4-pound expanded metal lath proportioned by weight—1:2 for scratch coat, 1:3 for brown, gypsum to sand. Lath on one side of the partition fastened to 1/4" diameter pencil rods supported by No. 20 gage metal clips, located 16" on center vertically, on each stud. 3" thick mineral fiber insulating batts friction fitted between the studs.	—	—	6 1/2 <sup>d</sup>	—
	15-1.10	Steel studs 0.060" thick, 4" deep or 6" at 16" or 24" centers, with 1/2" Glass Fiber Reinforced Concrete (GFRC) on the exterior surface. GFRC is attached with flex anchors at 24" on center, with 5" leg welded to studs with two 1/2"-long flare-bevel welds, and 4" foot attached to the GFRC skin with 5/8"-thick GFRC bonding pads that extend 2 1/2" beyond the flex anchor foot on both sides. Interior surface to have two layers of 1/2" Type X gypsum wallboard. <sup>e</sup> The first layer of wallboard to be attached with 1"-long Type S buglehead screws spaced 24" on center and the second layer is attached with 1 5/8"-long Type S screws spaced at 12" on center. Cavity is to be filled with 5" of 4 pcf (nominal) mineral fiber batts. GFRC has 1 1/2" returns packed with mineral fiber and caulked on the exterior.	—	—	6 1/2	—
	15-1.11	Steel studs 0.060" thick, 4" deep or 6" at 16" or 24" centers, respectively, with 1/2" Glass Fiber Reinforced Concrete (GFRC) on the exterior surface. GFRC is attached with flex anchors at 24" on center, with 5" leg welded to studs with two 1/2"-long flare-bevel welds, and 4" foot attached to the GFRC skin with 5/8"-thick GFRC bonding pads that extend 2 1/2" beyond the flex anchor foot on both sides. Interior surface to have one layer of 5/8" Type X gypsum wallboard <sup>e</sup> , attached with 1 1/4"-long Type S buglehead screws spaced 12" on center. Cavity is to be filled with 5" of 4 pcf (nominal) mineral fiber batts. GFRC has 1 1/2" returns packed with mineral fiber and caulked on the exterior.	—	—	—	6 1/8
	15-1.12 <sup>g</sup>	2" x 6" wood studs at 16" with double top plates, single bottom plate; interior and exterior sides covered with 5/8" Type X gypsum wallboard, 4' wide, applied horizontally or vertically with vertical joints over studs, and fastened with 2 1/4" Type S drywall screws, spaced 12" on center. Cavity filled with 5 1/2" mineral wool insulation.	—	—	—	6 3/4
	15-1.13 <sup>g</sup>	2" x 6" wood studs at 16" with double top plates, single bottom plate; interior and exterior sides covered with 5/8" Type X gypsum wallboard, 4' wide, applied horizontally or vertically with vertical joints over studs, and fastened with 2 1/4" Type S drywall screws, spaced 7" on center. Cavity to be filled with 5 1/2" mineral wool insulation minimum 2.58 pcf (nominal).	—	—	—	6 3/4
	15-1.14 <sup>g</sup>	2" x 4" wood studs at 16" with double top plates, single bottom plate; interior and exterior sides covered with 5/8" Type X gypsum wallboard and sheathing, respectively, 4' wide, applied horizontally or vertically with vertical joints over studs, and fastened with 2 1/4" Type S drywall screws, spaced 12" on center. Cavity to be filled with 3 1/2" mineral wool insulation.	—	—	—	4 3/4
	15-1.15 <sup>g</sup>	2" x 4" wood studs at 16" with double top plates, single bottom plate; interior sides covered with 5/8" Type X gypsum wallboard, 4' wide, applied horizontally unblocked, and fastened with 2 1/4" Type S drywall screws, spaced 12" on center, wallboard joints covered with paper tape and joint compound, fastener heads covered with joint compound. Exterior covered with 3/8" wood structural panels (oriented strand board), applied vertically, horizontal joints blocked and fastened with 6d common nails (bright)—12" on center in the field, 6" on center panel edges. Cavity to be filled with 3 1/2" mineral wool insulation. Rating established for exposure from interior side only.	—	—	—	4 1/2

(continued)

**TABLE 720.1(2)—continued**  
**RATED FIRE-RESISTANCE PERIODS FOR VARIOUS WALLS AND PARTITIONS<sup>a,o,p</sup>**

MATERIAL	ITEM NUMBER	CONSTRUCTION	MINIMUM FINISHED THICKNESS FACE-TO-FACE <sup>b</sup> (inches)			
			4 hour	3 hour	2 hour	1 hour
15. Exterior or interior walls (continued)	15-1.16 <sup>q</sup>	2" × 6" (51 mm × 152 mm) wood studs at 16" centers with double top plates, single bottom plate; interior side covered with 5/8" Type X gypsum wallboard, 4' wide, applied horizontally or vertically with vertical joints over studs and fastened with 2 1/4" Type S drywall screws, spaced 12" on center, exterior side covered with 7/16" wallboard joints covered with paper tape and joint compound, fastener heads covered with joint compound; wood structural panels (oriented strand board) fastened with 6d common nails (bright) spaced 12" on center in the field and 6" on center along the panel edges. Cavity to be filled with 5 1/2" mineral wool insulation. Rating established from the gypsum-covered side only.	—	—	—	6 <sup>9</sup> / <sub>16</sub>
	15-1.17 <sup>q</sup>	2" × 6" wood studs at 24" centers with double top plates, single bottom plate; interior and exterior side covered with two layers of 5/8" Type X gypsum wallboard, 4' wide, applied horizontally with vertical joints over studs. Base layer fastened with 2 1/4" Type S drywall screws, spaced 24" on center, and face layer fastened with Type S drywall screws, spaced 8" on center, wallboard joints covered with paper tape and joint compound, fastener heads covered with joint compound. Cavity to be filled with 5 1/2" mineral wool insulation.	—	—	7 <sup>3</sup> / <sub>4</sub>	—
16. Exterior walls rated for fire resistance from the inside only in accordance with Section 704.5.	16-1.1 <sup>q</sup>	2" × 4" wood studs at 16" centers with double top plates, single bottom plate; interior side covered with 5/8" Type X gypsum wallboard, 4' wide, applied horizontally unblocked, and fastened with 2 1/4" Type S drywall screws, spaced 12" on center, wallboard joints covered with paper tape and joint compound, fastener heads covered with joint compound. Exterior covered with 3/8" wood structural panels (oriented strand board), applied vertically, horizontal joints blocked and fastened with 6d common nails (bright) — 12" on center in the field, and 6" on center panel edges. Cavity to be filled with 3 1/2" mineral wool insulation. Rating established for exposure from interior side only.	—	—	—	4 1/2

For SI: 1 inch = 25.4 mm, 1 square inch = 645.2 mm<sup>2</sup>, 1 cubic foot = 0.0283 m<sup>3</sup>.

- a. Staples with equivalent holding power and penetration shall be permitted to be used as alternate fasteners to nails for attachment to wood framing.
- b. Thickness shown for brick and clay tile are nominal thicknesses unless plastered, in which case thicknesses are net. Thickness shown for concrete masonry and clay masonry is equivalent thickness defined in Section 721.3.1 for concrete masonry and Section 721.4.1.1 for clay masonry. Where all cells are solid grouted or filled with silicone-treated perlite loose-fill insulation; vermiculite loose-fill insulation; or expanded clay, shale or slate lightweight aggregate, the equivalent thickness shall be the thickness of the block or brick using specified dimensions as defined in Chapter 21. Equivalent thickness may also include the thickness of applied plaster and lath or gypsum wallboard, where specified.
- c. For units in which the net cross-sectional area of cored brick in any plane parallel to the surface containing the cores is at least 75 percent of the gross cross-sectional area measured in the same plane.
- d. Shall be used for nonbearing purposes only.
- e. For all of the construction with gypsum wallboard described in this table, gypsum base for veneer plaster of the same size, thickness and core type shall be permitted to be substituted for gypsum wallboard, provided attachment is identical to that specified for the wallboard, and the joints on the face layer are reinforced and the entire surface is covered with a minimum of 1/16-inch gypsum veneer plaster.
- f. The fire-resistance time period for concrete masonry units meeting the equivalent thicknesses required for a 2-hour fire-resistance rating in Item 3, and having a thickness of not less than 7 1/8 inches is 4 hours when cores which are not grouted are filled with silicone-treated perlite loose-fill insulation; vermiculite loose-fill insulation; or expanded clay, shale or slate lightweight aggregate, sand or slag having a maximum particle size of 3/4 inch.
- g. The fire-resistance rating of concrete masonry units composed of a combination of aggregate types or where plaster is applied directly to the concrete masonry shall be determined in accordance with ACI 216.1/TMS 216. Lightweight aggregates shall have a maximum combined density of 65 pounds per cubic foot.
- h. See also Note b. The equivalent thickness shall be permitted to include the thickness of cement plaster or 1.5 times the thickness of gypsum plaster applied in accordance with the requirements of Chapter 25.
- i. Concrete walls shall be reinforced with horizontal and vertical temperature reinforcement as required by Chapter 19.
- j. Studs are welded truss wire studs with 0.18 inch (No. 7 B.W. gage) flange wire and 0.18 inch (No. 7 B.W. gage) truss wires.
- k. Nailable metal studs consist of two channel studs spot welded back to back with a crimped web forming a nailing groove.
- l. Wood structural panels shall be permitted to be installed between the fire protection and the wood studs on either the interior or exterior side of the wood frame assemblies in this table, provided the length of the fasteners used to attach the fire protection are increased by an amount at least equal to the thickness of the wood structural panel.
- m. The design stress of studs shall be reduced to 78 percent of allowable  $F'_c$  with the maximum not greater than 78 percent of the calculated stress with studs having a slenderness ratio  $l/d$  of 33.
- n. For properties of cooler or wallboard nails, see ASTM C 514, ASTM C 547 or ASTM F 1667.
- o. Generic fire-resistance ratings (those not designated as PROPRIETARY\* in the listing) in the GA 600 shall be accepted as if herein listed.
- p. NCMA TEK 5-8, shall be permitted for the design of fire walls.
- q. The design stress of studs shall be equal to a maximum of 100 percent of the allowable  $F'_c$  calculated in accordance with Section 2306.

**TABLE 720.1(3)  
MINIMUM PROTECTION FOR FLOOR AND ROOF SYSTEMS<sup>a,9</sup>**

FLOOR OR ROOF CONSTRUCTION	ITEM NUMBER	CEILING CONSTRUCTION	THICKNESS OF FLOOR OR ROOF SLAB (inches)				MINIMUM THICKNESS OF CEILING (inches)			
			4 hour	3 hour	2 hour	1 hour	4 hour	3 hour	2 hour	1 hour
1. Siliceous aggregate concrete	1-1.1	Slab (no ceiling required). Minimum cover over nonprestressed reinforcement shall not be less than $\frac{3}{4}$ inch. <sup>b</sup>	7.0	6.2	5.0	3.5	—	—	—	—
2. Carbonate aggregate concrete	2-1.1		6.6	5.7	4.6	3.2	—	—	—	—
3. Sand-lightweight concrete	3-1.1		5.4	4.6	3.8	2.7	—	—	—	—
4. Lightweight concrete	4-1.1		5.1	4.4	3.6	2.5	—	—	—	—
5. Reinforced concrete	5-1.1	Slab with suspended ceiling of vermiculite gypsum plaster over metal lath attached to $\frac{3}{4}$ " cold-rolled channels spaced 12" on center. Ceiling located 6" minimum below joists.	3	2	—	—	1	$\frac{3}{4}$	—	—
	5-2.1	$\frac{3}{8}$ " Type X gypsum wallboard <sup>c</sup> attached to 0.018 inch (No. 25 carbon sheet steel gage) by $\frac{7}{8}$ " deep by $2\frac{5}{8}$ " hat-shaped galvanized steel channels with 1"-long No. 6 screws. The channels are spaced 24" on center, span 35" and are supported along their length at 35" intervals by 0.033-inch (No. 21 galvanized sheet gage) galvanized steel flat strap hangers having formed edges that engage the lips of the channel. The strap hangers are attached to the side of the concrete joists with $\frac{5}{32}$ " by $1\frac{1}{4}$ " long power-driven fasteners. The wallboard is installed with the long dimension perpendicular to the channels. All end joints occur on channels and supplementary channels are installed parallel to the main channels, 12" each side, at end joint occurrences. The finished ceiling is located approximately 12" below the soffit of the floor slab.	—	—	$2\frac{1}{2}$	—	—	—	$\frac{5}{8}$	—
6. Steel joists constructed with a poured reinforced concrete slab on metal lath forms or steel form units <sup>d, e</sup>	6-1.1	Gypsum plaster on metal lath attached to the bottom cord with single No. 16 gage or doubled No. 18 gage wire ties spaced 6" on center. Plaster mixed 1:2 for scratch coat, 1:3 for brown coat, by weight, gypsum-to-sand aggregate for 2-hour system. For 3-hour system plaster is neat.	—	—	$2\frac{1}{2}$	$2\frac{1}{4}$	—	—	$\frac{3}{4}$	$\frac{5}{8}$
	6-2.1	Vermiculite gypsum plaster on metal lath attached to the bottom chord with single No.16 gage or doubled 0.049-inch (No. 18 B.W. gage) wire ties spaced 6" on center.	—	2	—	—	—	$\frac{5}{8}$	—	—
	6-3.1	Cement plaster over metal lath attached to the bottom chord of joists with single No. 16 gage or doubled 0.049-inch (No. 18 B.W. gage) wire ties spaced 6" on center. Plaster mixed 1:2 for scratch coat, 1:3 for brown coat for 1-hour system and 1:1 for scratch coat, 1:1 $\frac{1}{2}$ for brown coat for 2-hour system, by weight, cement to sand.	—	—	—	2	—	—	—	$\frac{5}{8}$ <sup>f</sup>
	6-4.1	Ceiling of $\frac{5}{8}$ " Type X wallboard <sup>c</sup> attached to $\frac{7}{8}$ " deep by $2\frac{5}{8}$ " by 0.021 inch (No. 25 carbon sheet steel gage) hat-shaped furring channels 12" on center with 1" long No. 6 wallboard screws at 8" on center. Channels wire tied to bottom chord of joists with doubled 0.049 inch (No. 18 B.W. gage) wire or suspended below joists on wire hangers. <sup>g</sup>	—	—	$2\frac{1}{2}$	—	—	—	$\frac{5}{8}$	—
	6-5.1	Wood-fibered gypsum plaster mixed 1:1 by weight gypsum to sand aggregate applied over metal lath. Lath tied 6" on center to $\frac{3}{4}$ " channels spaced $13\frac{1}{2}$ " on center. Channels secured to joists at each intersection with two strands of 0.049 inch (No. 18 B.W. gage) galvanized wire.	—	—	$2\frac{1}{2}$	—	—	—	$\frac{3}{4}$	—

(continued)

**TABLE 720.1(3)—continued  
MINIMUM PROTECTION FOR FLOOR AND ROOF SYSTEMS<sup>a,q</sup>**

FLOOR OR ROOF CONSTRUCTION	ITEM NUMBER	CEILING CONSTRUCTION	THICKNESS OF FLOOR OR ROOF SLAB (inches)				MINIMUM THICKNESS OF CEILING (inches)			
			4 hour	3 hour	2 hour	1 hour	4 hour	3 hour	2 hour	1 hour
7. Reinforced concrete slabs and joists with hollow clay tile fillers laid end to end in rows 2½" or more apart; reinforcement placed between rows and concrete cast around and over tile.	7-1.1	5/8" gypsum plaster on bottom of floor or roof construction.	—	—	8 <sup>b</sup>	—	—	—	5/8	—
	7-1.2	None	—	—	—	5½ <sup>i</sup>	—	—	—	—
8. Steel joists constructed with a reinforced concrete slab on top poured on a ½" deep steel deck. <sup>e</sup>	8-1.1	Vermiculite gypsum plaster on metal lath attached to ¾" cold-rolled channels with 0.049" (No. 18 B.W. gage) wire ties spaced 6" on center.	2½ <sup>j</sup>	—	—	—	¾	—	—	—
9. 3" deep cellular steel deck with concrete slab on top. Slab thickness measured to top.	9-1.1	Suspended ceiling of vermiculite gypsum plaster base coat and vermiculite acoustical plaster on metal lath attached at 6" intervals to ¾" cold-rolled channels spaced 12" on center and secured to 1½" cold-rolled channels spaced 36" on center with 0.065" (No. 16 B.W. gage) wire. 1½" channels supported by No. 8 gage wire hangers at 36" on center. Beams within envelope and with a 2½" airspace between beam soffit and lath have a 4-hour rating.	2½	—	—	—	1⅛ <sup>k</sup>	—	—	—
10. 1½"-deep steel roof deck on steel framing. Insulation board, 30 pcf density, composed of wood fibers with cement binders of thickness shown bonded to deck with unified asphalt adhesive. Covered with a Class A or B roof covering.	10-1.1	Ceiling of gypsum plaster on metal lath. Lath attached to ¾" furring channels with 0.049" (No. 18 B.W. gage) wire ties spaced 6" on center. ¾" channel saddle tied to 2" channels with doubled 0.065" (No. 16 B.W. gage) wire ties. 2" channels spaced 36" on center suspended 2" below steel framing and saddle-tied with 0.165" (No. 8 B.W. gage) wire. Plaster mixed 1:2 by weight, gypsum-to-sand aggregate.	—	—	1⅞	1	—	—	¾ <sup>l</sup>	¾ <sup>l</sup>
11. 1½"-deep steel roof deck on steel-framing wood fiber insulation board, 17.5 pcf density on top applied over a 15-lb asphalt-saturated felt. Class A or B roof covering.	11-1.1	Ceiling of gypsum plaster on metal lath. Lath attached to ¾" furring channels with 0.049" (No. 18 B.W. gage) wire ties spaced 6" on center. ¾" channels saddle tied to 2" channels with doubled 0.065" (No. 16 B.W. gage) wire ties. 2" channels spaced 36" on center suspended 2" below steel framing and saddle tied with 0.165" (No. 8 B.W. gage) wire. Plaster mixed 1:2 for scratch coat and 1:3 for brown coat, by weight, gypsum-to-sand aggregate for 1-hour system. For 2-hour system, plaster mix is 1:2 by weight, gypsum-to-sand aggregate.	—	—	1½	1	—	—	7/8 <sup>g</sup>	¾ <sup>l</sup>

(continued)

TABLE 720.1(3)—continued  
 MINIMUM PROTECTION FOR FLOOR AND ROOF SYSTEMS<sup>a,q</sup>

FLOOR OR ROOF CONSTRUCTION	ITEM NUMBER	CEILING CONSTRUCTION	THICKNESS OF FLOOR OR ROOF SLAB (inches)				MINIMUM THICKNESS OF CEILING (inches)			
			4 hour	3 hour	2 hour	1 hour	4 hour	3 hour	2 hour	1 hour
12. 1½" deep steel roof deck on steel-framing insulation of rigid board consisting of expanded perlite and fibers impregnated with integral asphalt waterproofing; density 9 to 12 pcf secured to metal roof deck by ½" wide ribbons of waterproof, cold-process liquid adhesive spaced 6" apart. Steel joist or light steel construction with metal roof deck, insulation, and Class A or B built-up roof covering. <sup>e</sup>	12-1.1	Gypsum-vermiculite plaster on metal lath wire tied at 6" intervals to ¾" furring channels spaced 12" on center and wire tied to 2" runner channels spaced 32" on center. Runners wire tied to bottom chord of steel joists.	—	—	1	—	—	7/8	—	
13. Double wood floor over wood joists spaced 16" on center. <sup>mn</sup>	13-1.1	Gypsum plaster over 3/8" Type X gypsum lath. Lath initially applied with not less than four 1½" by No. 13 gage by 19/64" head plasterboard blued nails per bearing. Continuous stripping over lath along all joist lines. Stripping consists of 3" wide strips of metal lath attached by 1½" by No. 11 gage by ½" head roofing nails spaced 6" on center. Alternate stripping consists of 3" wide 0.049" diameter wire stripping weighing 1 pound per square yard and attached by No.16 gage by 1½" by ¾" crown width staples, spaced 4" on center. Where alternate stripping is used, the lath nailing may consist of two nails at each end and one nail at each intermediate bearing. Plaster mixed 1:2 by weight, gypsum-to-sand aggregate.	—	—	—	—	—	7/8	—	
	13-1.2	Cement or gypsum plaster on metal lath. Lath fastened with 1½" by No. 11 gage by 7/16" head barbed shank roofing nails spaced 5" on center. Plaster mixed 1:2 for scratch coat and 1:3 for brown coat, by weight, cement to sand aggregate.	—	—	—	—	—	5/8	—	
	13-1.3	Perlite or vermiculite gypsum plaster on metal lath secured to joists with 1½" by No. 11 gage by 7/16" head barbed shank roofing nails spaced 5" on center.	—	—	—	—	—	5/8	—	
	13-1.4	½" Type X gypsum wallboard <sup>c</sup> nailed to joists with 5d cooler <sup>o</sup> or wallboard <sup>o</sup> nails at 6" on center. End joints of wallboard centered on joists.	—	—	—	—	—	—	1/2	
14. Plywood stressed skin panels consisting of 3/8"-thick interior C-D (exterior glue) top stressed skin on 2" x 6" nominal (minimum) stringers. Adjacent panel edges joined with 8d common wire nails spaced 6" on center. Stringers spaced 12" maximum on center.	14-1.1	½"-thick wood fiberboard weighing 15 to 18 pounds per cubic foot installed with long dimension parallel to stringers or 3/8" C-D (exterior glue) plywood glued and/or nailed to stringers. Nailing to be with 5d cooler <sup>o</sup> or wallboard <sup>o</sup> nails at 12" on center. Second layer of ½" Type X gypsum wallboard <sup>c</sup> applied with long dimension perpendicular to joists and attached with 8d cooler <sup>o</sup> or wallboard <sup>o</sup> nails at 6" on center at end joints and 8" on center elsewhere. Wallboard joints staggered with respect to fiberboard joints.	—	—	—	—	—	—	1	

(continued)

TABLE 720.1(3)—continued  
 MINIMUM PROTECTION FOR FLOOR AND ROOF SYSTEMS<sup>a,9</sup>

FLOOR OR ROOF CONSTRUCTION	ITEM NUMBER	CEILING CONSTRUCTION	THICKNESS OF FLOOR OR ROOF SLAB (inches)				MINIMUM THICKNESS OF CEILING (inches)			
			4 hour	3 hour	2 hour	1 hour	4 hour	3 hour	2 hour	1 hour
15. Vermiculite concrete slab proportioned 1:4 (portland cement to vermiculite aggregate) on a 1½"-deep steel deck supported on individually protected steel framing. Maximum span of deck 6'-10" where deck is less than 0.019 inch (No. 26 carbon steel sheet gage) or greater. Slab reinforced with 4" × 8" 0.109/0.083" (No. 12/14 B.W. gage) welded wire mesh.	15-1.1	None	—	—	—	3 <sup>j</sup>	—	—	—	—
16. Perlite concrete slab proportioned 1:6 (portland cement to perlite aggregate) on a 1¼"-deep steel deck supported on individually protected steel framing. Slab reinforced with 4" × 8" 0.109/0.083" (No. 12/14 B.W. gage) welded wire mesh.	16-1.1	None	—	—	—	3½ <sup>j</sup>	—	—	—	—
17. Perlite concrete slab proportioned 1:6 (portland cement to perlite aggregate) on a 9/16"-deep steel deck supported by steel joists 4' on center. Class A or B roof covering on top.	17-1.1	Perlite gypsum plaster on metal lath wire tied to ¾" furring channels attached with 0.065-inch (No. 16 B.W. gage) wire ties to lower chord of joists.	—	2 <sup>p</sup>	2 <sup>p</sup>	—	—	7/8	¾	—
18. Perlite concrete slab proportioned 1:6 (portland cement to perlite aggregate) on 1¼"-deep steel deck supported on individually protected steel framing. Maximum span of deck 6'-10" where deck is less than 0.019" (No. 26 carbon sheet steel gage) and 8'-0" where deck is 0.019" (No. 26 carbon sheet steel gage) or greater. Slab reinforced with 0.042" (No. 19 B.W. gage) hexagonal wire mesh. Class A or B roof covering on top.	18-1.1	None	—	2¼ <sup>p</sup>	2¼ <sup>p</sup>	—	—	—	—	—

(continued)

TABLE 720.1(3)—continued  
 MINIMUM PROTECTION FOR FLOOR AND ROOF SYSTEMS<sup>a,9</sup>

FLOOR OR ROOF CONSTRUCTION	ITEM NUMBER	CEILING CONSTRUCTION	THICKNESS OF FLOOR OR ROOF SLAB (inches)				MINIMUM THICKNESS OF CEILING (inches)			
			4 hour	3 hour	2 hour	1 hour	4 hour	3 hour	2 hour	1 hour
19. Floor and beam construction consisting of 3"-deep cellular steel floor unit mounted on steel members with 1:4 (proportion of portland cement to perlite aggregate) perlite-concrete floor slab on top.	19-1.1	Suspended envelope ceiling of perlite gypsum plaster on metal lath attached to 3/4" cold-rolled channels, secured to 1 1/2" cold-rolled channels spaced 42" on center supported by 0.203 inch (No. 6 B.W. gage) wire 36" on center. Beams in envelope with 3" minimum airspace between beam soffit and lath have a 4-hour rating.	2 <sup>P</sup>	—	—	—	1 <sup>I</sup>	—	—	—
20. Perlite concrete proportioned 1:6 (portland cement to perlite aggregate) poured to 1/8-inch thickness above top of corrugations of 1 5/16"-deep galvanized steel deck maximum span 8'-0" for 0.024-inch (No. 24 galvanized sheet gage) or 6' 0" for 0.019-inch (No. 26 galvanized sheet gage) with deck supported by individually protected steel framing. Approved polystyrene foam plastic insulation board having a flame spread not exceeding 75 (1" to 4" thickness) with vent holes that approximate 3 percent of the board surface area placed on top of perlite slurry. A 2' by 4' insulation board contains six 2 3/4" diameter holes. Board covered with 2 1/4" minimum perlite concrete slab.	20-1.1	None	—	—	Varies	—	—	—	—	—

(continued)



TABLE 720.1(3)—continued  
 MINIMUM PROTECTION FOR FLOOR AND ROOF SYSTEMS<sup>a,4</sup>

FLOOR OR ROOF CONSTRUCTION	ITEM NUMBER	CEILING CONSTRUCTION	THICKNESS OF FLOOR OR ROOF SLAB (inches)				MINIMUM THICKNESS OF CEILING (inches)				
			4 hour	3 hour	2 hour	1 hour	4 hour	3 hour	2 hour	1 hour	
21. Slab reinforced with mesh consisting of 0.042 inch (No. 19 B.W. gage) galvanized steel wire twisted together to form 2" hexagons with straight 0.065 inch (No. 16 B.W. gage) galvanized steel wire woven into mesh and spaced 3". Alternate slab reinforcement shall be permitted to consist of 4" x 8", 0.109/0.238-inch (No. 12/4 B.W. gage), or 2" x 2", 0.083/0.083-inch (No. 14/14 B.W. gage) welded wire fabric. Class A or B roof covering on top.	21-1.1	None	—	—	Varies	—	—	—	—	—	—
22. Wood joists, floor trusses and flat or pitched roof trusses spaced a maximum 24" o.c. with 1/2" wood structural panels with exterior glue applied at right angles to top of joist or top chord of trusses with 8d nails. The wood structural panel thickness shall not be less than nominal 1/2" less than required by Chapter 23.	22-1.1	Base layer 5/8" Type X gypsum wallboard applied at right angles to joist or truss 24" o.c. with 1 1/4" Type S or Type W drywall screws 24" o.c. Face layer 5/8" Type X gypsum wallboard or veneer base applied at right angles to joist or truss through base layer with 1 7/8" Type S or Type W drywall screws 12" o.c. at joints and intermediate joist or truss. Face layer Type G drywall screws placed 2" back on either side of face layer end joints, 12" o.c.	—	—	—	Varies	—	—	—	—	1 1/4
23. Steel joists, floor trusses and flat or pitched roof trusses spaced a maximum 24" o.c. with 1/2" wood structural panels with exterior glue applied at right angles to top of joist or top chord of trusses with No. 8 screws. The wood structural panel thickness shall not be less than nominal 1/2" nor less than required by Chapter 22.	23-1.1	Base layer 5/8" Type X gypsum board applied at right angles to steel framing 24" on center with 1" Type S drywall screws spaced 24" on center. Face layer 5/8" Type X gypsum board applied at right angles to steel framing attached through base layer with 1 5/8" Type S drywall screws 12" on center at end joints and intermediate joints and 1 1/2" Type G drywall screws 12 inches on center placed 2" back on either side of face layer end joints. Joints of the face layer are offset 24" from the joints of the base layer.	—	—	—	Varies	—	—	—	—	1 1/4
24. Wood I-joist (minimum joist depth 9 1/4" with a minimum flange depth of 1 5/16" and a minimum flange cross-sectional area of 2.3 square inches) at 24" o.c. spacing with 1 x 4 (nominal) wood furring strip spacer applied parallel to and covering the bottom of the bottom flange of each member, tacked in place. 2" mineral fiber insulation, 3.5 pcf (nominal) installed adjacent to the bottom flange of the I-joist and supported by the 1 x 4 furring strip spacer.	24-1.1	1/2" deep single leg resilient channel 16" on center (channels doubled at wallboard end joints), placed perpendicular to the furring strip and joist and attached to each joist by 1 1/8" Type S drywall screws. 5/8" Type C gypsum wallboard applied perpendicular to the channel with end joints staggered at least 4' and fastened with 1 1/8" Type S drywall screws spaced 7" on center. Wallboard joints to be taped and covered with joint compound.	—	—	—	Varies	—	—	—	—	—

(continued)

**Table 720.1(3) Notes.**

For SI: 1 inch = 25.4 mm, 1 foot = 304.8 mm, 1 pound = 0.454 kg, 1 cubic foot = 0.0283 m<sup>3</sup>,  
1 pound per square inch = 6.895 kPa = 1 pound per lineal foot = 1.4882 kg/m.

- a. Staples with equivalent holding power and penetration shall be permitted to be used as alternate fasteners to nails for attachment to wood framing.
- b. When the slab is in an unrestrained condition, minimum reinforcement cover shall not be less than 1<sup>5</sup>/<sub>8</sub> inches for 4-hour (siliceous aggregate only); 1<sup>1</sup>/<sub>4</sub> inches for 4- and 3-hour; 1 inch for 2-hour (siliceous aggregate only); and 3<sup>3</sup>/<sub>4</sub> inch for all other restrained and unrestrained conditions.
- c. For all of the construction with gypsum wallboard described in this table, gypsum base for veneer plaster of the same size, thickness and core type shall be permitted to be substituted for gypsum wallboard, provided attachment is identical to that specified for the wallboard, and the joints on the face layer are reinforced and the entire surface is covered with a minimum of 1<sup>1</sup>/<sub>8</sub>-inch gypsum veneer plaster.
- d. Slab thickness over steel joists measured at the joists for metal lath form and at the top of the form for steel form units.
- e. (a) The maximum allowable stress level for H-Series joists shall not exceed 22,000 psi.  
(b) The allowable stress for K-Series joists shall not exceed 26,000 psi, the nominal depth of such joist shall not be less than 10 inches and the nominal joist weight shall not be less than 5 pounds per lineal foot.
- f. Cement plaster with 15 pounds of hydrated lime and 3 pounds of approved additives or admixtures per bag of cement.
- g. Gypsum wallboard ceilings attached to steel framing shall be permitted to be suspended with 1<sup>1</sup>/<sub>2</sub>-inch cold-formed carrying channels spaced 48 inches on center, which are suspended with No. 8 SWG galvanized wire hangers spaced 48 inches on center. Cross-furring channels are tied to the carrying channels with No. 18 SWG galvanized wire hangers spaced 48 inches on center. Cross-furring channels are tied to the carrying channels with No. 18 SWG galvanized wire (double strand) and spaced as required for direct attachment to the framing. This alternative is also applicable to those steel framing assemblies recognized under Note q.
- h. Six-inch hollow clay tile with 2-inch concrete slab above.
- i. Four-inch hollow clay tile with 1<sup>1</sup>/<sub>2</sub>-inch concrete slab above.
- j. Thickness measured to bottom of steel form units.
- k. Five-eighths inch of vermiculite gypsum plaster plus 1<sup>1</sup>/<sub>2</sub> inch of approved vermiculite acoustical plastic.
- l. Furring channels spaced 12 inches on center.
- m. Double wood floor shall be permitted to be either of the following:
  - (a) Subfloor of 1-inch nominal boarding, a layer of asbestos paper weighing not less than 14 pounds per 100 square feet and a layer of 1-inch nominal tongue-and-groove finished flooring; or
  - (b) Subfloor of 1-inch nominal tongue-and-groove boarding or 1<sup>5</sup>/<sub>32</sub>-inch wood structural panels with exterior glue and a layer of 1-inch nominal tongue-and-groove finished flooring or 1<sup>9</sup>/<sub>32</sub>-inch wood structural panel finish flooring or a layer of Type I Grade M-1 particleboard not less than 3<sup>3</sup>/<sub>8</sub>-inch thick.
- n. The ceiling shall be permitted to be omitted over unusable space, and flooring shall be permitted to be omitted where unusable space occurs above.
- o. For properties of cooler or wallboard nails, see ASTM C 514, ASTM C 547 or ASTM F 1667.
- p. Thickness measured on top of steel deck unit.
- q. Generic fire-resistance ratings (those not designated as PROPRIETARY\* in the listing) in the GA 600 shall be accepted as if herein listed.

**TABLE 721.2.1.1  
MINIMUM EQUIVALENT THICKNESS OF CAST-IN-PLACE  
OR PRECAST CONCRETE WALLS, LOAD-BEARING  
OR NONLOAD-BEARING**

CONCRETE TYPE	MINIMUM SLAB THICKNESS (inches) FOR FIRE-RESISTANCE RATING OF				
	1-hour	1½-hour	2-hour	3-hour	4-hour
Siliceous	3.5	4.3	5.0	6.2	7.0
Carbonate	3.2	4.0	4.6	5.7	6.6
Sand-Lightweight	2.7	3.3	3.8	4.6	5.4
Lightweight	2.5	3.1	3.6	4.4	5.1

For SI: 1 inch = 25.4 mm.

**TABLE 721.2.1.2(1)  
VALUES OF  $R_n^{0.59}$  FOR USE IN EQUATION 7-4**

TYPE OF MATERIAL	THICKNESS OF MATERIAL (inches)											
	1½	2	2½	3	3½	4	4½	5	5½	6	6½	7
Siliceous aggregate concrete	5.3	6.5	8.1	9.5	11.3	13.0	14.9	16.9	18.8	20.7	22.8	25.1
Carbonate aggregate concrete	5.5	7.1	8.9	10.4	12.0	14.0	16.2	18.1	20.3	21.9	24.7	27.2 <sup>c</sup>
Sand-lightweight concrete	6.5	8.2	10.5	12.8	15.5	18.1	20.7	23.3	26.0 <sup>c</sup>	Note c	Note c	Note c
Lightweight concrete	6.6	8.8	11.2	13.7	16.5	19.1	21.9	24.7	27.8 <sup>c</sup>	Note c	Note c	Note c
Insulating concrete <sup>a</sup>	9.3	13.3	16.6	18.3	23.1	26.5 <sup>c</sup>	Note c	Note c	Note c	Note c	Note c	Note c
Airspace <sup>b</sup>	—	—	—	—	—	—	—	—	—	—	—	—

For SI: 1 inch = 25.4 mm, 1 pound per cubic foot = 16.02 kg/m<sup>3</sup>.

a. Dry unit weight of 35 pcf or less and consisting of cellular, perlite or vermiculite concrete.

b. The  $R_n^{0.59}$  value for one ½" to 3 ½" airspace is 3.3. The  $R_n^{0.59}$  value for two ½" to 3 ½" airspaces is 6.7.

c. The fire-resistance rating for this thickness exceeds 4 hours.

**TABLE 721.2.1.2(2)  
FIRE-RESISTANCE RATINGS BASED ON  $R^{0.59}$**

$R^a$ , MINUTES	$R^{0.59}$
60	11.20
120	16.85
180	21.41
240	25.37

a. Based on Equation 7-4.

**TABLE 721.2.1.4(1)**  
**MULTIPLYING FACTOR FOR FINISHES ON NONFIRE-EXPOSED SIDE OF WALL**

TYPE OF FINISH APPLIED TO MASONRY WALL	TYPE OF AGGREGATE USED IN CONCRETE OR CONCRETE MASONRY			
	Concrete: siliceous or carbonate Masonry: siliceous or calcareous gravel	Concrete: sand lightweight concrete Masonry: limestone, cinders or unexpected slag	Concrete: lightweight concrete Masonry: expanded shale, clay or slate	Concrete: pumice, or expanded slag
Portland cement-sand plaster	1.00	0.75 <sup>a</sup>	0.75 <sup>a</sup>	0.50 <sup>a</sup>
Gypsum-sand plaster or gypsum wallboard	1.25	1.00	1.00	1.00
Gypsum-vermiculite or perlite plaster	1.75	1.50	1.50	1.25

For SI: 1 inch = 25.4 mm.

a. For portland cement-sand plaster  $\frac{3}{8}$  inch or less in thickness and applied directly to the masonry on the nonfire-exposed side of the wall, the multiplying factor shall be 1.00.

**TABLE 721.2.1.4(2)**  
**TIME ASSIGNED TO FINISH MATERIALS ON FIRE-EXPOSED SIDE OF WALL**

FINISH DESCRIPTION	TIME (minute)
Gypsum wallboard	
$\frac{3}{8}$ inch	10
$\frac{1}{2}$ inch	15
$\frac{5}{8}$ inch	20
2 layers of $\frac{3}{8}$ inch	25
1 layer $\frac{3}{8}$ inch, 1 layer $\frac{1}{2}$ inch	35
2 layers $\frac{1}{2}$ inch	40
Type X gypsum wallboard	
$\frac{1}{2}$ inch	25
$\frac{5}{8}$ inch	40
Portland cement-sand plaster applied directly to concrete masonry	See Note a
Portland cement-sand plaster on metal lath	
$\frac{3}{4}$ inch	20
$\frac{7}{8}$ inch	25
1 inch	30
Gypsum sand plaster on $\frac{3}{8}$ -inch gypsum lath	
$\frac{1}{2}$ inch	35
$\frac{5}{8}$ inch	40
$\frac{3}{4}$ inch	50
Gypsum sand plaster on metal lath	
$\frac{3}{4}$ inch	50
$\frac{7}{8}$ inch	60
1 inch	80

For SI: 1 inch = 25.4 mm.

a. The actual thickness of portland cement-sand plaster, provided it is  $\frac{5}{8}$  inch or less in thickness, shall be permitted to be included in determining the equivalent thickness of the masonry for use in Table 721.3.2.

**TABLE 721.2.2.1**  
**MINIMUM SLAB THICKNESS (inches)**

CONCRETE TYPE	FIRE-RESISTANCE RATING (hour)				
	1	1½	2	3	4
Siliceous	3.5	4.3	5.0	6.2	7.0
Carbonate	3.2	4.0	4.6	5.7	6.6
Sand-lightweight	2.7	3.3	3.8	4.6	5.4
Lightweight	2.5	3.1	3.6	4.4	5.1

For SI: 1 inch = 25.4 mm.

**TABLE 721.2.3(1)**  
**COVER THICKNESS FOR REINFORCED CONCRETE FLOOR OR ROOF SLABS (inches)**

CONCRETE AGGREGATE TYPE	FIRE-RESISTANCE RATING (hours)									
	Restrained					Unrestrained				
	1	1½	2	3	4	1	1½	2	3	4
Siliceous	$\frac{3}{4}$	$\frac{3}{4}$	$\frac{3}{4}$	$\frac{3}{4}$	$\frac{3}{4}$	$\frac{3}{4}$	$\frac{3}{4}$	1	1½	1½
Carbonate	$\frac{3}{4}$	$\frac{3}{4}$	$\frac{3}{4}$	$\frac{3}{4}$	$\frac{3}{4}$	$\frac{3}{4}$	$\frac{3}{4}$	$\frac{3}{4}$	1½	1½
Sand-lightweight or lightweight	$\frac{3}{4}$	$\frac{3}{4}$	$\frac{3}{4}$	$\frac{3}{4}$	$\frac{3}{4}$	$\frac{3}{4}$	$\frac{3}{4}$	$\frac{3}{4}$	1½	1½

For SI: 1 inch = 25.4 mm.

**TABLE 721.2.3(2)**  
**COVER THICKNESS FOR REINFORCED CONCRETE FLOOR OR ROOF SLABS (inches)**

CONCRETE AGGREGATE TYPE	FIRE-RESISTANCE RATING (hours)									
	Restrained					Unrestrained				
	1	1½	2	3	4	1	1½	2	3	4
Siliceous	¾	¾	¾	¾	¾	1⅛	1½	1¾	2¾	2¾
Carbonate	¾	¾	¾	¾	¾	1	1⅜	1⅝	2½	2¼
Sand-lightweight or lightweight	¾	¾	¾	¾	¾	1	1⅜	1½	2	2¼

For SI: 1 inch = 25.4 mm.

**TABLE 721.2.3(3)**  
**MINIMUM COVER FOR MAIN REINFORCING BARS OF REINFORCED CONCRETE BEAMS<sup>c</sup>**  
**(APPLICABLE TO ALL TYPES OF STRUCTURAL CONCRETE)**

RESTRAINED OR UNRESTRAINED <sup>a</sup>	BEAM WIDTH <sup>b</sup> (inches)	FIRE-RESISTANCE RATING (hours)				
		1	1½	2	3	4
Restrained	5	¾	¾	¾	1 <sup>a</sup>	1¼ <sup>a</sup>
	7	¾	¾	¾	¾	¾
	≥ 10	¾	¾	¾	¾	¾
Unrestrained	5	¾	1	1¼	—	—
	7	¾	¾	¾	1¾	3
	≥ 10	¾	¾	¾	1	1¾

For SI: 1 inch = 25.4 mm, 1 foot = 304.8 mm.

- Tabulated values for restrained assemblies apply to beams spaced more than 4 feet on center. For restrained beams spaced 4 feet or less on center, minimum cover of ¾ inch is adequate for ratings of 4 hours or less.
- For beam widths between the tabulated values, the minimum cover thickness can be determined by direct interpolation.
- The cover for an individual reinforcing bar is the minimum thickness of concrete between the surface of the bar and the fire-exposed surface of the beam. For beams in which several bars are used, the cover for corner bars used in the calculation shall be reduced to one-half of the actual value. The cover for an individual bar must be not less than one-half of the value given in Table 721.2.3(3) nor less than ¼ inch.

**TABLE 721.2.3(4)**  
**MINIMUM COVER FOR PRESTRESSED CONCRETE BEAMS 8 INCHES OR GREATER IN WIDTH**

RESTRAINED OR UNRESTRAINED <sup>a</sup>	CONCRETE AGGREGATE TYPE	BEAM WIDTH <sup>b</sup> (inches)	FIRE-RESISTANCE RATING (hours)				
			1	1½	2	3	4
Restrained	Carbonate or siliceous	8	1½	1½	1½	1¾ <sup>a</sup>	2½ <sup>a</sup>
	Carbonate or siliceous	≥ 12	1½	1½	1½	1½	1⅞ <sup>a</sup>
	Sand lightweight	8	1½	1½	1½	1½	2 <sup>a</sup>
	Sand lightweight	≥ 12	1½	1½	1½	1½	1⅝ <sup>a</sup>
Unrestrained	Carbonate or siliceous	8	1½	1¾	2½	5 <sup>c</sup>	—
	Carbonate or siliceous	≥ 12	1½	1½	1⅞ <sup>a</sup>	2½	3
	Sand lightweight	8	1½	1½	2	¾	—
	Sand lightweight	≥ 12	1½	1½	1⅝	2	2½

For SI: 1 inch = 25.4 mm, 1 foot = 304.8 mm.

- Tabulated values for restrained assemblies apply to beams spaced more than 4 feet on center. For restrained beams spaced 4 feet or less on center, minimum cover of ¾ inch is adequate for 4-hour ratings or less.
- For beam widths between 8 inches and 12 inches, minimum cover thickness can be determined by direct interpolation.
- Not practical for 8-inch-wide beam but shown for purposes of interpolation.

**TABLE 721.2.3(5)  
MINIMUM COVER FOR PRESTRESSED CONCRETE BEAMS OF ALL WIDTHS**

RESTRAINED OR UNRESTRAINED <sup>a</sup>	CONCRETE AGGREGATE TYPE	BEAM AREA <sup>b</sup> A (square inches)	FIRE-RESISTANCE RATING (hours)				
			1	1½	2	3	4
Restrained	All	40 ≤ A ≤ 150	1½	1½	2	2½	—
	Carbonate or siliceous	150 < A ≤ 300	1½	1½	1½	1¾	2½
		300 < A	1½	1½	1½	1½	2
	Sand lightweight	150 < A	1½	1½	1½	1½	2
Unrestrained	All	40 ≤ A ≤ 150	2	2½	—	—	—
	Carbonate or siliceous	150 < A ≤ 300	1½	1¾	2½	—	—
		300 < A	1½	1½	2	3 <sup>c</sup>	4 <sup>c</sup>
	Sand lightweight	150 < A	1½	1½	2	3 <sup>c</sup>	4 <sup>c</sup>

For SI: 1 inch = 25.4 mm, 1 foot = 304.8 mm.

- Tabulated values for restrained assemblies apply to beams spaced more than 4 feet on center. For restrained beams spaced 4 feet or less on center, minimum cover of ¾ inch is adequate for 4-hour ratings or less.
- The cross-sectional area of a stem is permitted to include a portion of the area in the flange, provided the width of the flange used in the calculation does not exceed three times the average width of the stem.
- U-shaped or hooped stirrups spaced not to exceed the depth of the member and having a minimum cover of 1 inch shall be provided.

**TABLE 721.2.4  
MINIMUM DIMENSION OF CONCRETE COLUMNS (inches)**

TYPES OF CONCRETE	FIRE-RESISTANCE RATING (hours)				
	1	1½	2 <sup>a</sup>	3 <sup>a</sup>	4 <sup>b</sup>
Siliceous	8	9	10	12	14
Carbonate	8	9	10	11	12
Sand-lightweight	8	8½	9	10½	12

For SI: 1 inch = 25 mm.

- The minimum dimension is permitted to be reduced to 8 inches for rectangular columns with two parallel sides at least 36 inches in length.
- The minimum dimension is permitted to be reduced to 10 inches for rectangular columns with two parallel sides at least 36 inches in length.

**TABLE 721.3.2  
MINIMUM EQUIVALENT THICKNESS (inches) OF BEARING OR NONBEARING CONCRETE MASONRY WALLS<sup>a,b,c,d</sup>**

TYPE OF AGGREGATE	FIRE-RESISTANCE RATING (hours)														
	½	¾	1	1¼	1½	1¾	2	2¼	2½	2¾	3	3¼	3½	3¾	4
Pumice or expanded slag	1.5	1.9	2.1	2.5	2.7	3.0	3.2	3.4	3.6	3.8	4.0	4.2	4.4	4.5	4.7
Expanded shale, clay or slate	1.8	2.2	2.6	2.9	3.3	3.4	3.6	3.8	4.0	4.2	4.4	4.6	4.8	4.9	5.1
Limestone, cinders or unexpanded slag	1.9	2.3	2.7	3.1	3.4	3.7	4.0	4.3	4.5	4.8	5.0	5.2	5.5	5.7	5.9
Calcareous or siliceous gravel	2.0	2.4	2.8	3.2	3.6	3.9	4.2	4.5	4.8	5.0	5.3	5.5	5.8	6.0	6.2

For SI: 1 inch = 25.4 mm.

- Values between those shown in the table can be determined by direct interpolation.
- Where combustible members are framed into the wall, the thickness of solid material between the end of each member and the opposite face of the wall, or between members set in from opposite sides, shall not be less than 93 percent of the thickness shown in the table.
- Requirements of ASTM C 55, ASTM C 73 or ASTM C 90 shall apply.
- Minimum required equivalent thickness corresponding to the hourly fire-resistance rating for units with a combination of aggregate shall be determined by linear interpolation based on the percent by volume of each aggregate used in manufacture.

**TABLE 721.3.4  
MINIMUM COVER OF LONGITUDINAL  
REINFORCEMENT IN FIRE-RESISTANCE-RATED  
REINFORCED CONCRETE MASONRY LINTELS (inches)**

NOMINAL WIDTH OF LINTEL (inches)	FIRE-RESISTANCE RATING (hours)			
	1	2	3	4
6	1½	2	—	—
8	1½	1½	1¾	3
10 or greater	1½	1½	1½	1¾

For SI: 1 inch = 25.4 mm.

**TABLE 721.3.5  
MINIMUM DIMENSION OF  
CONCRETE MASONRY COLUMNS (inches)**

FIRE-RESISTANCE RATING (hours)			
1	2	3	4
8	10	12	14

For SI: 1 inch = 25.4 mm.

**TABLE 721.4.1(1)  
FIRE-RESISTANCE PERIODS OF CLAY MASONRY WALLS**

MATERIAL TYPE	MINIMUM REQUIRED EQUIVALENT THICKNESS FOR FIRE RESISTANCE <sup>a,b,c</sup> (inches)			
	1 hour	2 hour	3 hour	4 hour
Solid brick of clay or shale <sup>d</sup>	2.7	3.8	4.9	6.0
Hollow brick or tile of clay or shale, unfilled	2.3	3.4	4.3	5.0
Hollow brick or tile of clay or shale, grouted or filled with materials specified in Section 721.4.1.1.3	3.0	4.4	5.5	6.6

For SI: 1 inch = 25.4 mm.

a. Equivalent thickness as determined from Section 721.4.1.1.

b. Calculated fire resistance between the hourly increments listed shall be determined by linear interpolation.

c. Where combustible members are framed in the wall, the thickness of solid material between the end of each member and the opposite face of the wall, or between members set in from opposite sides, shall not be less than 93 percent of the thickness shown.

d. For units in which the net cross-sectional area of cored brick in any plane parallel to the surface containing the cores is at least 75 percent of the gross cross-sectional area measured in the same plane.

**TABLE 721.4.1(2)**  
**FIRE-RESISTANCE RATINGS FOR BEARING STEEL FRAME**  
**BRICK VENEER WALLS OR PARTITIONS**

WALL OR PARTITION ASSEMBLY	PLASTER SIDE EXPOSED (hours)	BRICK FACED SIDE EXPOSED (hours)
Outside facing of steel studs: $\frac{1}{2}$ " wood fiberboard sheathing next to studs, $\frac{3}{4}$ " airspace formed with $\frac{3}{4}$ " $\times$ 1 $\frac{5}{8}$ " wood strips placed over the fiberboard and secured to the studs; metal or wire lath nailed to such strips, $3\frac{3}{4}$ " brick veneer held in place by filling $\frac{3}{4}$ " airspace between the brick and lath with mortar. Inside facing of studs: $\frac{3}{4}$ " unsanded gypsum plaster on metal or wire lath attached to $\frac{5}{16}$ " wood strips secured to edges of the studs.	1.5	4
Outside facing of steel studs: 1" insulation board sheathing attached to studs, 1" airspace, and $3\frac{3}{4}$ " brick veneer attached to steel frame with metal ties every 5th course. Inside facing of studs: $\frac{7}{8}$ " sanded gypsum plaster (1:2 mix) applied on metal or wire lath attached directly to the studs.	1.5	4
Same as above except use $\frac{7}{8}$ " vermiculite—gypsum plaster or 1" sanded gypsum plaster (1:2 mix) applied to metal or wire.	2	4
Outside facing of steel studs: $\frac{1}{2}$ " gypsum sheathing board, attached to studs, and $3\frac{3}{4}$ " brick veneer attached to steel frame with metal ties every 5th course. Inside facing of studs: $\frac{1}{2}$ " sanded gypsum plaster (1:2 mix) applied to $\frac{1}{2}$ " perforated gypsum lath securely attached to studs and having strips of metal lath 3 inches wide applied to all horizontal joints of gypsum lath.	2	4

For SI: 1 inch = 25.4 mm.



**TABLE 721.4.1(3)  
VALUES OF  $R_n^{0.59}$**

$R_n^{0.59}$	$R$ (hours)
1	1.0
2	1.50
3	1.91
4	2.27

**TABLE 721.4.1(4)  
COEFFICIENTS FOR PLASTER,  $pl^a$**

THICKNESS OF PLASTER (inch)	ONE SIDE	TWO SIDE
$1/2$	0.3	0.6
$5/8$	0.37	0.75
$3/4$	0.45	0.90

For SI: 1 inch = 25.4 mm.

a. Values listed in table are for 1:3 sanded gypsum plaster.

**TABLE 721.4.1(5)  
REINFORCED MASONRY LINTELS**

NOMINAL LINTEL WIDTH (inches)	MINIMUM LONGITUDINAL REINFORCEMENT COVER FOR FIRE RESISTANCE (inch)			
	1 hour	2 hour	3 hour	4 hour
6	$1\frac{1}{2}$	2	NP	NP
8	$1\frac{1}{2}$	$1\frac{1}{2}$	$1\frac{3}{4}$	3
10 or more	$1\frac{1}{2}$	$1\frac{1}{2}$	$1\frac{1}{2}$	$1\frac{3}{4}$

For SI: 1 inch = 25.4 mm.

NP = Not permitted.

**TABLE 721.4.1(6)  
REINFORCED CLAY MASONRY COLUMNS**

COLUMN SIZE	FIRE-RESISTANCE RATING (hour)			
	1	2	3	4
Minimum column dimension (inches)	8	10	12	14

For SI: 1 inch = 25.4 mm.

**TABLE 721.5.1(1)  
W/D RATIOS FOR STEEL COLUMNS**

STRUCTURAL SHAPE	CONTOUR PROFILE	BOX PROFILE	STRUCTURAL SHAPE	CONTOUR PROFILE	BOX PROFILE
W14 × 233	2.49	3.65	W10 × 112	1.78	2.57
× 211	2.28	3.35	× 100	1.61	2.33
× 193	2.10	3.09	× 88	1.43	2.08
× 176	1.93	2.85	× 77	1.26	1.85
× 159	1.75	2.60	× 68	1.13	1.66
× 145	1.61	2.39	× 60	1.00	1.48
× 132	1.52	2.25	× 54	0.91	1.34
× 120	1.39	2.06	× 49	0.83	1.23
× 109	1.27	1.88	× 45	0.87	1.24
× 99	1.16	1.72	× 39	0.76	1.09
× 90	1.06	1.58	× 33	0.65	0.93
× 82	1.20	1.68			
× 74	1.09	1.53	W8 × 67	1.34	1.94
× 68	1.01	1.41	× 58	1.18	1.71
× 61	0.91	1.28	× 48	0.99S	1.44
× 53	0.89	1.21	× 40	0.83	1.23
× 48	0.81	1.10	× 35	0.73	1.08
× 43	0.73	0.99	× 31	0.65	0.97
			× 28	0.67	0.96
W12 × 190	2.46	3.51	× 24	0.58	0.83
× 170	2.22	3.20	× 21	0.57	0.77
× 152	2.01	2.90	× 18	0.49	0.67
× 136	1.82	2.63			
× 120	1.62	2.36	W6 × 25	0.69	1.00
× 106	1.44	2.11	× 20	0.56	0.82
× 96	1.32	1.93	× 16	0.57	0.78
× 87	1.20	1.76	× 15	0.42	0.63
× 79	1.10	1.61	× 12	0.43	0.60
× 72	1.00	1.48	× 9	0.33	0.46
× 65	0.91	1.35			
× 58	0.91	1.31	W5 × 19	0.64	0.93
× 53	0.84	1.20	× 16	0.54	0.80
× 50	0.89	1.23			
× 45	0.81	1.12	W4 × 13	0.54	0.79
× 40	0.72	1.00			

For SI: 1 pound per linear foot per inch = 0.059 kg/m/mm.

**TABLE 721.5.1(2)  
PROPERTIES OF CONCRETE**

PROPERTY	NORMAL WEIGHT CONCRETE	STRUCTURAL LIGHTWEIGHT CONCRETE
Thermal conductivity ( $k_c$ )	0.95 Btu/hr ft °F	0.35 Btu/hr ft °F
Specific heat ( $c_p$ )	0.20 Btu/lb °F	0.20 Btu/lb °F
Density ( $P_c$ )	145 lb/ft <sup>3</sup>	110 lb/ft <sup>3</sup>
Equilibrium (free) moisture content (m) by volume	4%	5%

For SI: 1 inch = 25.4 mm, 1 foot = 304.8 mm, 1 lb/ft<sup>3</sup> = 16.0185 kg/m<sup>3</sup>, Btu/hr ft °F = 1.731 W/(m · K)

**TABLE 721.5.1(3)  
THERMAL CONDUCTIVITY OF CONCRETE OR CLAY  
MASONRY UNITS**

DENSITY ( $d_m$ ) OF UNITS (lb/ft <sup>3</sup> )	THERMAL CONDUCTIVITY (K) OF UNITS (Btu/hr ft °F)
<b>Concrete Masonry Units</b>	
80	0.207
85	0.228
90	0.252
95	0.278
100	0.308
105	0.340
110	0.376
115	0.416
120	0.459
125	0.508
130	0.561
135	0.620
140	0.685
145	0.758
150	0.837
<b>Clay Masonry Units</b>	
120	1.25
130	2.25

For SI: 1 pound per cubic foot = 16.0185 kg/m<sup>3</sup>, Btu per hour foot °F = 1.731 W/(m · K).

**TABLE 721.5.1(4)**  
**WEIGHT-TO-HEATED-PERIMETER RATIOS (W/D)**  
**FOR TYPICAL WIDE FLANGE BEAM AND GIRDER SHAPES**

STRUCTURAL SHAPE	CONTOUR PROFILE	BOX PROFILE	STRUCTURAL SHAPE	CONTOUR PROFILE	BOX PROFILE
W36 × 300	2.47	3.33	× 68	0.92	1.21
× 280	2.31	3.12	× 62	0.92	1.14
× 260	2.16	2.92	× 55	0.82	1.02
× 245	2.04	2.76			
× 230	1.92	2.61	W21 × 147	1.83	2.60
× 210	1.94	2.45	× 132	1.66	2.35
× 194	1.80	2.28	× 122	1.54	2.19
× 182	1.69	2.15	× 111	1.41	2.01
× 170	1.59	2.01	× 101	1.29	1.84
× 160	1.50	1.90	× 93	1.38	1.80
× 150	1.41	1.79	× 83	1.24	1.62
× 135	1.28	1.63	× 73	1.10	1.44
			× 68	1.03	1.35
W33 × 241	2.11	2.86	× 62	0.94	1.23
× 221	1.94	2.64	× 57	0.93	1.17
× 201	1.78	2.42	× 50	0.83	1.04
× 152	1.51	1.94	× 44	0.73	0.92
× 141	1.41	1.80			
× 130	1.31	1.67	W18 × 119	1.69	2.42
× 118	1.19	1.53	× 106	1.52	2.18
			× 97	1.39	2.01
W30 × 211	2.00	2.74	× 86	1.24	1.80
× 191	1.82	2.50	× 76	1.11	1.60
× 173	1.66	2.28	× 71	1.21	1.59
× 132	1.45	1.85	× 65	1.11	1.47
× 124	1.37	1.75	× 60	1.03	1.36
× 116	1.28	1.65	× 55	0.95	1.26
× 108	1.20	1.54	× 50	0.87	1.15
× 99	1.10	1.42	× 46	0.86	1.09
			× 40	0.75	0.96
W27 × 178	1.85	2.55	× 35	0.66	0.85
× 161	1.68	2.33			
× 146	1.53	2.12	W16 × 100	1.56	2.25
× 114	1.36	1.76	× 89	1.40	2.03
× 102	1.23	1.59	× 77	1.22	1.78
× 94	1.13	1.47	× 67	1.07	1.56
× 84	1.02	1.33	× 57	1.07	1.43
			× 50	0.94	1.26
			× 45	0.85	1.15
W24 × 162	1.85	2.57	× 40	0.76	1.03
× 146	1.68	2.34	× 36	0.69	0.93
× 131	1.52	2.12	× 31	0.65	0.83
× 117	1.36	1.91	× 26	0.55	0.70
× 104	1.22	1.71			
× 94	1.26	1.63	W14 × 132	1.83	3.00
× 84	1.13	1.47	× 120	1.67	2.75
× 76	1.03	1.34	× 109	1.53	2.52

*(continued)*

**TABLE 721.5.1(4)—continued  
WEIGHT-TO-HEATED-PERIMETER RATIOS (W/D)  
FOR TYPICAL WIDE FLANGE BEAM AND GIRDER SHAPES**

STRUCTURAL SHAPE	CONTOUR PROFILE	BOX PROFILE	STRUCTURAL SHAPE	CONTOUR PROFILE	BOX PROFILE
× 99	1.39	2.31	× 30	0.79	1.12
× 90	1.27	2.11	× 26	0.69	0.98
× 82	1.41	2.12	× 22	0.59	0.84
× 74	1.28	1.93	× 19	0.59	0.78
× 68	1.19	1.78	× 17	0.54	0.70
× 61	1.07	1.61	× 15	0.48	0.63
× 53	1.03	1.48	× 12	0.38	0.51
× 48	0.94	1.35			
× 43	0.85	1.22	W8 × 67	1.61	2.55
× 38	0.79	1.09	× 58	1.41	2.26
× 34	0.71	0.98	× 48	1.18	1.91
× 30	0.63	0.87	× 40	1.00	1.63
× 26	0.61	0.79	× 35	0.88	1.44
× 22	0.52	0.68	× 31	0.79	1.29
			× 28	0.80	1.24
W12 × 87	1.44	2.34	× 24	0.69	1.07
× 79	1.32	2.14	× 21	0.66	0.96
× 72	1.20	1.97	× 18	0.57	0.84
× 65	1.09	1.79	× 15	0.54	0.74
× 58	1.08	1.69	× 13	0.47	0.65
× 53	0.99	1.55	× 10	0.37	0.51
× 50	1.04	1.54			
× 45	0.95	1.40	W6 × 25	0.82	1.33
× 40	0.85	1.25	× 20	0.67	1.09
× 35	0.79	1.11	× 16	0.66	0.96
× 30	0.69	0.96	× 15	0.51	0.83
× 26	0.60	0.84	× 12	0.51	0.75
× 22	0.61	0.77	× 9	0.39	0.57
× 19	0.53	0.67			
× 16	0.45	0.57	W5 × 19	0.76	1.24
× 14	0.40	0.50	× 16	0.65	1.07
W10 × 112	2.14	3.38	W4 × 13	0.65	1.05
× 100	1.93	3.07			
× 88	1.7	2.75			
× 77	1.52	2.45			
× 68	1.35	2.20			
× 60	1.20	1.97			
× 54	1.09	1.79			
× 49	0.99	1.64			
× 45	1.03	1.59			
× 39	0.94	1.40			
× 33	0.77	1.20			

For SI: Pounds per linear foot per inch = 0.059 kg/m/mm.

**TABLE 721.5.1(5)  
FIRE RESISTANCE OF CONCRETE MASONRY PROTECTED STEEL COLUMNS**

COLUMN SIZE	CONCRETE MASONRY DENSITY POUNDS PER CUBIC FOOT	MINIMUM REQUIRED EQUIVALENT THICKNESS FOR FIRE-RESISTANCE RATING OF CONCRETE MASONRY PROTECTION ASSEMBLY $T_g$ , (inches)				COLUMN SIZE	CONCRETE MASONRY DENSITY POUNDS PER CUBIC FOOT	MINIMUM REQUIRED EQUIVALENT THICKNESS FOR FIRE-RESISTANCE RATING OF CONCRETE MASONRY PROTECTION ASSEMBLY $T_g$ , (inches)			
		1-hour	2-hour	3-hour	4-hour			1-hour	2-hour	3-hour	4-hour
W14 × 82	80	0.74	1.61	2.36	3.04	W10 × 68	80	0.72	1.58	2.33	3.01
	100	0.89	1.85	2.67	3.40		100	0.87	1.83	2.65	3.38
	110	0.96	1.97	2.81	3.57		110	0.94	1.95	2.79	3.55
	120	1.03	2.08	2.95	3.73		120	1.01	2.06	2.94	3.72
W14 × 68	80	0.83	1.70	2.45	3.13	W10 × 54	80	0.88	1.76	2.53	3.21
	100	0.99	1.95	2.76	3.49		100	1.04	2.01	2.83	3.57
	110	1.06	2.06	2.91	3.66		110	1.11	2.12	2.98	3.73
	120	1.14	2.18	3.05	3.82		120	1.19	2.24	3.12	3.90
W14 × 53	80	0.91	1.81	2.58	3.27	W10 × 45	80	0.92	1.83	2.60	3.30
	100	1.07	2.05	2.88	3.62		100	1.08	2.07	2.90	3.64
	110	1.15	2.17	3.02	3.78		110	1.16	2.18	3.04	3.80
	120	1.22	2.28	3.16	3.94		120	1.23	2.29	3.18	3.96
W14 × 43	80	1.01	1.93	2.71	3.41	W10 × 33	80	1.06	2.00	2.79	3.49
	100	1.17	2.17	3.00	3.74		100	1.22	2.23	3.07	3.81
	110	1.25	2.28	3.14	3.90		110	1.30	2.34	3.20	3.96
	120	1.32	2.38	3.27	4.05		120	1.37	2.44	3.33	4.12
W12 × 72	80	0.81	1.66	2.41	3.09	W8 × 40	80	0.94	1.85	2.63	3.33
	100	0.91	1.88	2.70	3.43		100	1.10	2.10	2.93	3.67
	110	0.99	1.99	2.84	3.60		110	1.18	2.21	3.07	3.83
	120	1.06	2.10	2.98	3.76		120	1.25	2.32	3.20	3.99
W12 × 58	80	0.88	1.76	2.52	3.21	W8 × 31	80	1.06	2.00	2.78	3.49
	100	1.04	2.01	2.83	3.56		100	1.22	2.23	3.07	3.81
	110	1.11	2.12	2.97	3.73		110	1.29	2.33	3.20	3.97
	120	1.19	2.23	3.11	3.89		120	1.36	2.44	3.33	4.12
W12 × 50	80	0.91	1.81	2.58	3.27	W8 × 24	80	1.14	2.09	2.89	3.59
	100	1.07	2.05	2.88	3.62		100	1.29	2.31	3.16	3.90
	110	1.15	2.17	3.02	3.78		110	1.36	2.42	3.28	4.05
	120	1.22	2.28	3.16	3.94		120	1.43	2.52	3.41	4.20
W12 × 40	80	1.01	1.94	2.72	3.41	W8 × 18	110	1.22	2.20	3.01	3.72
	100	1.17	2.17	3.01	3.75		100	1.36	2.40	3.25	4.01
	110	1.25	2.28	3.14	3.90		110	1.42	2.50	3.37	4.14
	120	1.32	2.39	3.27	4.06		120	1.48	2.59	3.49	4.28

(continued)

**TABLE 721.5.1(5)—continued**  
**FIRE RESISTANCE OF CONCRETE MASONRY PROTECTED STEEL COLUMNS**

NOMINAL TUBE SIZE (inches)	CONCRETE MASONRY DENSITY, POUNDS PER CUBIC FOOT	MINIMUM REQUIRED EQUIVALENT THICKNESS FOR FIRE-RESISTANCE RATING OF CONCRETE MASONRY PROTECTION ASSEMBLY $T_p$ , (inches)				NOMINAL PIPE SIZE (inches)	CONCRETE MASONRY DENSITY, POUNDS PER CUBIC FOOT	MINIMUM REQUIRED EQUIVALENT THICKNESS FOR FIRE-RESISTANCE RATING OF CONCRETE MASONRY PROTECTION ASSEMBLY $T_p$ , (inches)			
		1-hour	2-hour	3-hour	4-hour			1-hour	2-hour	3-hour	4-hour
4 × 4 × 1/2 wall thickness	80	0.93	1.90	2.71	3.43	4 double extra strong 0.674 wall thickness	80	0.80	1.75	2.56	3.28
	100	1.08	2.13	2.99	3.76		100	0.95	1.99	2.85	3.62
	110	1.16	2.24	3.13	3.91		110	1.02	2.10	2.99	3.78
	120	1.22	2.34	3.26	4.06		120	1.09	2.20	3.12	3.93
4 × 4 × 3/8 wall thickness	80	1.05	2.03	2.84	3.57	4 extra strong 0.337 wall thickness	80	1.12	2.11	2.93	3.65
	100	1.20	2.25	3.11	3.88		100	1.26	2.32	3.19	3.95
	110	1.27	2.35	3.24	4.02		110	1.33	2.42	3.31	4.09
	120	1.34	2.45	3.37	4.17		120	1.40	2.52	3.43	4.23
4 × 4 × 1/4 wall thickness	80	1.21	2.20	3.01	3.73	4 standard 0.237 wall thickness	80	1.26	2.25	3.07	3.79
	100	1.35	2.40	3.26	4.02		100	1.40	2.45	3.31	4.07
	110	1.41	2.50	3.38	4.16		110	1.46	2.55	3.43	4.21
	120	1.48	2.59	3.50	4.30		120	1.53	2.64	3.54	4.34
6 × 6 × 1/2 wall thickness	80	0.82	1.75	2.54	3.25	5 double extra strong 0.750 wall thickness	80	0.70	1.61	2.40	3.12
	100	0.98	1.99	2.84	3.59		100	0.85	1.86	2.71	3.47
	110	1.05	2.10	2.98	3.75		110	0.91	1.97	2.85	3.63
	120	1.12	2.21	3.11	3.91		120	0.98	2.02	2.99	3.79
6 × 6 × 3/8 wall thickness	80	0.96	1.91	2.71	3.42	5 extra strong 0.375 wall thickness	80	1.04	2.01	2.83	3.54
	100	1.12	2.14	3.00	3.75		100	1.19	2.23	3.09	3.85
	110	1.19	2.25	3.13	3.90		110	1.26	2.34	3.22	4.00
	120	1.26	2.35	3.26	4.05		120	1.32	2.44	3.34	4.14
6 × 6 × 1/4 wall thickness	80	1.14	2.11	2.92	3.63	5 standard 0.258 wall thickness	80	1.20	2.19	3.00	3.72
	100	1.29	2.32	3.18	3.93		100	1.34	2.39	3.25	4.00
	110	1.36	2.43	3.30	4.08		110	1.41	2.49	3.37	4.14
	120	1.42	2.52	3.43	4.22		120	1.47	2.58	3.49	4.28
8 × 8 × 1/2 wall thickness	80	0.77	1.66	2.44	3.13	6 double extra strong 0.864 wall thickness	80	0.59	1.46	2.23	2.92
	100	0.92	1.91	2.75	3.49		100	0.73	1.71	2.54	3.29
	110	1.00	2.02	2.89	3.66		110	0.80	1.82	2.69	3.47
	120	1.07	2.14	3.03	3.82		120	0.86	1.93	2.83	3.63
8 × 8 × 3/8 wall thickness	80	0.91	1.84	2.63	3.33	6 extra strong 0.432 wall thickness	80	0.94	1.90	2.70	3.42
	100	1.07	2.08	2.92	3.67		100	1.10	2.13	2.98	3.74
	110	1.14	2.19	3.06	3.83		110	1.17	2.23	3.11	3.89
	120	1.21	2.29	3.19	3.98		120	1.24	2.34	3.24	4.04
8 × 8 × 1/4 wall thickness	80	1.10	2.06	2.86	3.57	6 standard 0.280 wall thickness	80	1.14	2.12	2.93	3.64
	100	1.25	2.28	3.13	3.87		100	1.29	2.33	3.19	3.94
	110	1.32	2.38	3.25	4.02		110	1.36	2.43	3.31	4.08
	120	1.39	2.48	3.38	4.17		120	1.42	2.53	3.43	4.22

For SI: 1 inch = 25.4 mm, 1 pound per cubic foot = 16.02 kg/m<sup>3</sup>.  
Note: Tabulated values assume 1-inch air gap between masonry and steel section.

**TABLE 721.5.1(6)  
FIRE RESISTANCE OF CLAY MASONRY PROTECTED STEEL COLUMNS**

COLUMN SIZE	CLAY MASONRY DENSITY, POUNDS PER CUBIC FOOT	MINIMUM REQUIRED EQUIVALENT THICKNESS FOR FIRE-RESISTANCE RATING OF CLAY MASONRY PROTECTION ASSEMBLY T <sub>r</sub> (Inches)				COLUMN SIZE	CLAY MASONRY DENSITY, POUNDS PER CUBIC FOOT	MINIMUM REQUIRED EQUIVALENT THICKNESS FOR FIRE-RESISTANCE RATING OF CLAY MASONRY PROTECTION ASSEMBLY T <sub>r</sub> (Inches)			
		1-hour	2-hour	3-hour	4-hour			1-hour	2-hour	3-hour	4-hour
W14 × 82	120	1.23	2.42	3.41	4.29	W10 × 68	120	1.27	2.46	3.26	4.35
	130	1.40	2.70	3.78	4.74		130	1.44	2.75	3.83	4.80
W14 × 68	120	1.34	2.54	3.54	4.43	W10 × 54	120	1.40	2.61	3.62	4.51
	130	1.51	2.82	3.91	4.87		130	1.58	2.89	3.98	4.95
W14 × 53	120	1.43	2.65	3.65	4.54	W10 × 45	120	1.44	2.66	3.67	4.57
	130	1.61	2.93	4.02	4.98		130	1.62	2.95	4.04	5.01
W14 × 43	120	1.54	2.76	3.77	4.66	W10 × 33	120	1.59	2.82	3.84	4.73
	130	1.72	3.04	4.13	5.09		130	1.77	3.10	4.20	5.13
W12 × 72	120	1.32	2.52	3.51	4.40	W8 × 40	120	1.47	2.70	3.71	4.61
	130	1.50	2.80	3.88	4.84		130	1.65	2.98	4.08	5.04
W12 × 58	120	1.40	2.61	3.61	4.50	W8 × 31	120	1.59	2.82	3.84	4.73
	130	1.57	2.89	3.98	4.94		130	1.77	3.10	4.20	5.17
W12 × 50	120	1.43	2.65	3.66	4.55	W8 × 24	120	1.66	2.90	3.92	4.82
	130	1.61	2.93	4.02	4.99		130	1.84	3.18	4.28	5.25
W12 × 40	120	1.54	2.77	3.78	4.67	W8 × 18	120	1.75	3.00	4.01	4.91
	130	1.72	3.05	4.14	5.10		130	1.93	3.27	4.37	5.34
<b>Steel tubing</b>						<b>Steel pipe</b>					
Nominal tube size (Inches)	Clay masonry density, pounds per cubic foot	Minimum required equivalent thickness for fire-resistance rating of clay masonry protection assembly T <sub>r</sub> (Inches)				Nominal pipe size (Inches)	Clay masonry density, pounds per cubic foot	Minimum required equivalent thickness for fire-resistance rating of clay masonry protection assembly T <sub>r</sub> (Inches)			
		1-hour	2-hour	3-hour	4-hour			1-hour	2-hour	3-hour	4-hour
4 × 4 × 1/2 wall thickness	120	1.44	2.72	3.76	4.68	4 double extra strong 0.674 wall thickness	120	1.26	2.55	3.60	4.52
	130	1.62	3.00	4.12	5.11		130	1.42	2.82	3.96	4.95
4 × 4 × 3/8 wall thickness	120	1.56	2.84	3.88	4.78	4 extra strong 0.337 wall thickness	120	1.60	2.89	3.92	4.83
	130	1.74	3.12	4.23	5.21		130	1.77	3.16	4.28	5.25
4 × 4 × 1/4 wall thickness	120	1.72	2.99	4.02	4.92	4 standard 0.237 wall thickness	120	1.74	3.02	4.05	4.95
	130	1.89	3.26	4.37	5.34		130	1.92	3.29	4.40	5.37
6 × 6 × 1/2 wall thickness	120	1.33	2.58	3.62	4.52	5 double extra strong 0.750 wall thickness	120	1.17	2.44	3.48	4.40
	130	1.50	2.86	3.98	4.96		130	1.33	2.72	3.84	4.83
6 × 6 × 3/8 wall thickness	120	1.48	2.74	3.76	4.67	5 extra strong 0.375 wall thickness	120	1.55	2.82	3.85	4.76
	130	1.65	3.01	4.13	5.10		130	1.72	3.09	4.21	5.18
6 × 6 × 1/4 wall thickness	120	1.66	2.91	3.94	4.84	5 standard 0.258 wall thickness	120	1.71	2.97	4.00	4.90
	130	1.83	3.19	4.30	5.27		130	1.88	3.24	4.35	5.32
8 × 8 × 1/2 wall thickness	120	1.27	2.50	3.52	4.42	6 double extra strong 0.864 wall thickness	120	1.04	2.28	3.32	4.23
	130	1.44	2.78	3.89	4.86		130	1.19	2.60	3.68	4.67
8 × 8 × 3/8 wall thickness	120	1.43	2.67	3.69	4.59	6 extra strong 0.432 wall thickness	120	1.45	2.71	3.75	4.65
	130	1.60	2.95	4.05	5.02		130	1.62	2.99	4.10	5.08
8 × 8 × 1/4 wall thickness	120	1.62	2.87	3.89	4.78	6 standard 0.280 wall thickness	120	1.65	2.91	3.94	4.84
	130	1.79	3.14	4.24	5.21		130	1.82	3.19	4.30	5.27



**TABLE 721.5.1(7)**  
**MINIMUM COVER (inch) FOR STEEL COLUMNS**  
**ENCASED IN NORMAL-WEIGHT CONCRETE<sup>a</sup>**  
**[FIGURE 721.5.1(6)(c)]**

STRUCTURAL SHAPE	FIRE-RESISTANCE RATING (hours)				
	1	1 1/2	2	3	4
W14 × 233	1	1	1	1 1/2	2
× 176				2 1/2	2
× 132			1 1/2		
× 90		1 1/2		2 1/2	3
× 61			1 1/2		
× 48		1 1/2		2 1/2	3
× 43			1 1/2		
W12 × 152	1	1		2	2 1/2
× 96			1 1/2		
× 65		1 1/2		2 1/2	3
× 50			1 1/2		
× 40		1 1/2		2 1/2	3
W10 × 88	1		1 1/2		
× 49		1 1/2		2 1/2	3 1/2
× 45			1 1/2		
× 39		1 1/2		2 1/2	3 1/2
× 33			1 1/2		
W8 × 67	1	1		1 1/2	2 1/2
× 58			1 1/2		
× 48		1 1/2		2 1/2	3 1/2
× 31			1 1/2		
× 21		1 1/2		2 1/2	3 1/2
× 18			1 1/2		
W6 × 25	1	1 1/2		2	3
× 20			2		
× 16		2		3	4
× 15			2		
× 9		1 1/2		2 1/2	3 1/2

For SI: 1 inch = 25.4 mm.

a. The tabulated thicknesses are based upon the assumed properties of normal-weight concrete given in Table 721.5.1(2).

**TABLE 721.5.1(8)**  
**MINIMUM COVER (inch) FOR STEEL COLUMNS**  
**ENCASED IN STRUCTURAL LIGHTWEIGHT CONCRETE<sup>a</sup>**  
**[FIGURE 721.5.1(6)(c)]**

STRUCTURAL SHAPE	FIRE-RESISTANCE RATING (HOURS)					
	1	1 1/2	2	3	4	
W14 × 233	1	1	1	1	1 1/2	
× 193				1 1/2	2	2 1/2
× 74						
× 61				1 1/2	2	2 1/2
× 43						
W12 × 65	1	1	1	1 1/2	2	
× 53				1 1/2	2	2 1/2
× 40						
W10 × 112	1	1	1	1 1/2	2	
× 88				1 1/2	2	2 1/2
× 60						
× 33				1 1/2	2	2 1/2
W8 × 35	1	1	1 1/2			
× 28				2 1/2	3	4
× 24						
× 18				2 1/2	3	4

For SI: 1 inch = 25.4 mm.

a. The tabulated thicknesses are based upon the assumed properties of structural lightweight concrete given in Table 721.5.1(2).

**TABLE 721.5.1(9)**  
**MINIMUM COVER (inch) FOR STEEL COLUMNS**  
**IN NORMAL-WEIGHT PRECAST COVERS<sup>a</sup>**  
**[FIGURE 721.5.1(6)(a)]**

STRUCTURAL SHAPE	FIRE-RESISTANCE RATING (hours)						
	1	1 1/2	2	3	4		
W14 × 233	1 1/2	1 1/2	1 1/2	2 1/2	3		
× 211					3 1/2		
× 176							
× 145			2				
× 109			3				
× 99							
× 61				4			
× 43				4 1/2			
W12 × 190			1 1/2	1 1/2		1 1/2	2 1/2
× 152					3		
× 120							
× 96							
× 87	4						
× 58	4 1/2						
× 40							
W10 × 112		1 1/2			1 1/2	2	3 1/2
× 88	4						
× 77							
× 54							
× 33			4 1/2				
W8 × 67	1 1/2	1 1/2	2	3	4		
× 58							
× 48							
× 28					4 1/2		
× 21							
× 18						4	
W6 × 25	1 1/2	1 1/2	2	3 1/2	4 1/2		
× 20							
× 16							
× 12					4		
× 9							
× 9						5	

For SI: 1 inch = 25.4 mm.

a. The tabulated thicknesses are based upon the assumed properties of normal-weight concrete given in Table 721.5.1(2).

**TABLE 721.5.1(10)**  
**MINIMUM COVER (inch) FOR STEEL COLUMNS**  
**IN STRUCTURAL LIGHTWEIGHT PRECAST COVERS<sup>a</sup>**  
**[FIGURE 721.5.1(6)(a)]**

STRUCTURAL SHAPE	FIRE-RESISTANCE RATING (hours)						
	1	1 1/2	2	3	4		
W14 × 233	1 1/2	1 1/2	1 1/2	2	2 1/2		
× 176					3		
× 145							
× 132			2 1/2				
× 109							
× 99							
× 68				3 1/2			
× 43			3				
W12 × 190			1 1/2	1 1/2		1 1/2	2
× 152					3		
× 136							
× 106							
× 96	4						
× 87	4 1/2						
× 65							
× 40		3 1/2					
W10 × 112	1 1/2	1 1/2			1 1/2	2	3
× 100							
× 88							
× 77							
× 60			3 1/2				
× 39	3						
× 33							
W8 × 67		1 1/2	1 1/2	2	2 1/2	3	
× 48							
× 35	3 1/2						
× 28							
× 18						4	
W6 × 25	1 1/2					1 1/2	2
× 15							
× 9		4					
× 9							

For SI: 1 inch = 25.4 mm.

a. The tabulated thicknesses are based upon the assumed properties of structural lightweight concrete given in Table 721.5.1(2).

**TABLE 721.6.2(1)**  
**TIME ASSIGNED TO WALLBOARD MEMBRANES<sup>a,b,c,d</sup>**

DESCRIPTION OF FINISH	TIME <sup>a</sup> (minutes)
$\frac{3}{8}$ -inch wood structural panel bonded with exterior glue	5
$\frac{15}{32}$ -inch wood structural panel bonded with exterior glue	10
$\frac{19}{32}$ -inch wood structural panel bonded with exterior glue	15
$\frac{3}{8}$ -inch gypsum wallboard	10
$\frac{1}{2}$ -inch gypsum wallboard	15
$\frac{5}{8}$ -inch gypsum wallboard	30
$\frac{1}{2}$ -inch Type X gypsum wallboard	25
$\frac{5}{8}$ -inch Type X gypsum wallboard	40
Double $\frac{3}{8}$ -inch gypsum wallboard	25
$\frac{1}{2}$ + $\frac{3}{8}$ -inch gypsum wallboard	35
Double $\frac{1}{2}$ -inch gypsum wallboard	40

For SI: 1 inch = 25.4 mm.

- a. These values apply only when membranes are installed on framing members which are spaced 16 inches o.c.
- b. Gypsum wallboard installed over framing or furring shall be installed so that all edges are supported, except  $\frac{5}{8}$ -inch Type X gypsum wallboard shall be permitted to be installed horizontally with the horizontal joints staggered 24 inches each side and unsupported but finished.
- c. On wood frame floor/ceiling or roof/ceiling assemblies, gypsum board shall be installed with the long dimension perpendicular to framing members and shall have all joints finished.
- d. The membrane on the unexposed side shall not be included in determining the fire resistance of the assembly. When dissimilar membranes are used on a wall assembly, the calculation shall be made from the least fire-resistant (weaker) side.
- e. The time assigned is not a finished rating.

**TABLE 721.6.2(2)**  
**TIME ASSIGNED FOR CONTRIBUTION OF WOOD FRAME<sup>a,b,c</sup>**

DESCRIPTION	TIME ASSIGNED TO FRAME (minutes)
Wood studs 16 inches o.c.	20
Wood floor and roof joists 16 inches o.c.	10

For SI: 1 inch = 25.4 mm.

- This table does not apply to studs or joists spaced more than 16 inches o.c.
- All studs shall be nominal 2 × 4 and all joists shall have a nominal thickness of at least 2 inches.
- Allowable spans for joists shall be determined in accordance with Sections 2308.8, 2308.10.2 and 2308.10.3.

**TABLE 721.6.2(3)**  
**MEMBRANE<sup>a</sup> ON EXTERIOR FACE OF WOOD STUD WALLS**

SHEATHING	PAPER	EXTERIOR FINISH
<sup>5</sup> / <sub>8</sub> -inch T & G lumber	Sheathing paper	Lumber siding
<sup>5</sup> / <sub>16</sub> -inch exterior glue plywood		Wood shingles and shakes
<sup>1</sup> / <sub>2</sub> -inch gypsum wallboard		<sup>1</sup> / <sub>4</sub> -inch wood structural panels—exterior type
<sup>5</sup> / <sub>8</sub> -inch gypsum wallboard		<sup>1</sup> / <sub>4</sub> -inch hardboard
<sup>1</sup> / <sub>2</sub> -inch fiberboard		Metal siding
		Stucco on metal lath
		Masonry veneer
None	—	<sup>3</sup> / <sub>8</sub> -inch exterior-grade wood structural panels

For SI: 1 pound/cubic feet = 16.0185 kg/m<sup>2</sup>.

- Any combination of sheathing, paper, and exterior finish is permitted.

**TABLE 721.6.2(4)**  
**FLOORING OR ROOFING OVER WOOD FRAMING<sup>a</sup>**

ASSEMBLY	STRUCTURAL MEMBERS	SUBFLOOR OR ROOF DECK	FINISHED FLOORING OR ROOFING
Floor	Wood	<sup>15</sup> / <sub>32</sub> -inch wood structural panels or <sup>11</sup> / <sub>16</sub> inch T & G softwood	Hardwood or softwood flooring on building paper resilient flooring, parquet floor felted-synthetic fiber floor coverings, carpeting, or ceramic tile on <sup>3</sup> / <sub>8</sub> -inch-thick panel-type underlay
			Ceramic tile on 1 <sup>1</sup> / <sub>4</sub> -inch mortar bed
Roof	Wood	<sup>15</sup> / <sub>32</sub> -inch wood structural panels or <sup>11</sup> / <sub>16</sub> inch T & G softwood	Finished roofing material with or without insulation

For SI: 1 inch = 25.4 mm.

- This table applies only to wood joist construction. It is not applicable to wood truss construction.

**TABLE 721.6.2(5)**  
**TIME ASSIGNED FOR ADDITIONAL PROTECTION**

DESCRIPTION OF ADDITIONAL PROTECTION	FIRE RESISTANCE (minutes)
Add to the fire-resistance rating of wood stud walls if the spaces between the studs are completely filled with glass fiber mineral wool batts weighing not less than 2 pounds per cubic foot (0.6 pound per square foot of wall surface) or rockwool or slag material wool batts weighing not less than 3.3 pounds per cubic foot (1 pound per square foot of wall surface), or cellulose insulation having a nominal density not less than 2.6 pounds per cubic foot.	15

For SI: 1 pound/cubic foot = 16.0185 kg/m<sup>3</sup>.

**CHAPTER 8**  
**INTERIOR FINISHES**

**SECTION BC 801**  
**GENERAL**

**801.1 Scope.** Provisions of this chapter shall govern the use of materials used as interior finishes, trim and decorative materials.

**801.1.1 Interior finishes.** These provisions shall limit the allowable flame spread and smoke development based on location and occupancy classification.

**Exceptions:**

1. Materials having a thickness less than 0.036 inch (0.91 mm) applied directly to a non-combustible, or fire-retardant treated wood, substrate.
2. Exposed portions of structural members complying with the requirements for buildings of Type IV construction in Section 602.4.

**801.1.2 Applicability in flood hazard areas.** For buildings in flood hazard areas as established in Appendix G, interior finishes, trim and decorative materials below the design flood elevation shall be flood-damage-resistant materials.

**801.2 Application.** Combustible materials complying with the requirements of this chapter shall be permitted to be used as finish for walls, ceilings, floors and other interior surfaces of buildings.

**801.2.1 Windows.** Show windows in the first story of buildings shall be permitted to be of wood or of unprotected metal framing.

**801.2.2 Foam plastics.** Foam plastics shall not be used as interior finish or trim except as provided in Section 2603.7 or 2604.

**SECTION BC 802**  
**DEFINITIONS**

**802.1 General.** The following words and terms shall, for the purposes of this chapter and as used elsewhere in this code, have the meanings shown herein.

**EXPANDED VINYL WALL COVERING.** Wall covering consisting of a woven textile backing, an expanded vinyl base coat layer and a non-expanded vinyl skin coat. The expanded base coat layer is a homogeneous vinyl layer that contains a blowing agent. During processing, the blowing agent decomposes, causing this layer to expand by forming closed cells. The total thickness of the wall covering is approximately 0.055 inch to 0.070 inch (1.4 mm to 1.8 mm).

**FLAME RESISTANCE.** That property of materials or combinations of component materials that restricts the spread of flame in accordance with NFPA 701.

**FLAME SPREAD.** The propagation of flame over a surface.

**FLAME SPREAD INDEX.** The numerical value assigned to a material tested in accordance with ASTM E 84.

**INTERIOR FINISH.** Interior finish includes interior wall and ceiling finish and interior floor finish.

**INTERIOR FLOOR FINISH.** The exposed floor surfaces of buildings including coverings applied over a finished floor or stair, including risers.

**INTERIOR WALL AND CEILING FINISH.** The exposed interior surfaces of buildings including, but not limited to: fixed or movable walls and partitions; columns; ceilings; and interior wainscoting, paneling or other finish applied structurally or for decoration, acoustical correction, surface insulation, structural fire resistance or similar purposes, but not including trim.

**SMOKE-DEVELOPED INDEX.** The numerical value assigned to a material tested in accordance with ASTM E 84.

**TRIM.** Picture molds, chair rails, baseboards, handrails, door and window frames and similar decorative or protective materials used in fixed applications.

### **SECTION BC 803** **WALL AND CEILING FINISHES**

**803.1 General.** Interior wall and ceiling finishes shall be classified in accordance with ASTM E 84. Such interior finish materials shall be grouped in the following classes in accordance with their flame spread index.

Class A: Flame spread 0-25.

Class B: Flame spread 26-75.

Class C: Flame spread 76-200.

**Exception:** Materials, other than textiles, tested in accordance with Section 803.2.

**803.1.1 Smoke developed index.** Smoke developed index shall range from 0-450 with the following restrictions:

Exits, corridors

<u>Occupancy Group I</u>	<u>50</u>
<u>Rooms in which the net floor area per occupant is 10 square feet or less</u>	<u>100</u>

**Exception:** Materials other than textiles, tested in accordance with Section 803.2.

**803.2. Interior wall or ceiling finishes other than textiles.** Interior wall or ceiling finishes, other than textiles, shall be permitted to be tested in accordance with NFPA 286. Finishes tested in accordance with NFPA 286 shall comply with Sections 803.2.1 and 803.2.2.

**803.2.1 Acceptance criteria.** During the 40 kW exposure, the interior finish shall comply with Item 1. During the 160 kW exposure, the interior finish shall comply with Item 2. During the entire test, the interior finish shall comply with Item 3.

1. During the 40 kW exposure, flames shall not spread to the ceiling.
2. During the 160 kW exposure, the interior finish shall comply with the following:
  - 2.1. Flame shall not spread to the outer extremity of the sample on any wall or ceiling.
  - 2.2. Flashover, as defined in NFPA 286, shall not occur.
3. The total smoke released throughout the NFPA 286 test shall not exceed 1,000 m<sup>2</sup>.

**803.2.2 Toxicity.** Interior wall or ceiling finishes, other than textiles, upon exposure to fire, shall not produce products of decomposition or combustion that are more toxic in point of concentration than those given off by wood or paper when decomposing or burning under comparable conditions.

**803.3 Stability.** Interior finish materials regulated by this chapter shall be applied or otherwise fastened in such a manner that such materials will not readily become detached where subjected to room temperatures of 200°F (93°C) for not less than 30 minutes.

**803.4 Application.** Where these materials are applied on walls, ceilings or structural elements required to have a fire-resistance rating or to be of noncombustible construction, they shall comply with the provisions of this section.

**803.4.1 Direct attachment and furred construction.** Where walls and ceilings are required by any provision in this code to be of fire-resistance-rated or noncombustible construction, the interior finish material shall be applied directly against such construction or to furring strips not exceeding 1.75 inches (44 mm) applied directly against such surfaces. The intervening spaces between such furring strips shall be

filled with inorganic or Class A material or shall be fire blocked at a maximum of 8 feet (2438 mm) in any direction in accordance with Section 717.

**803.4.2 Set-out construction.** Where walls and ceilings are required to be of fire-resistance-rated or noncombustible construction and walls are set out or ceilings are dropped distances greater than specified in Section 803.4.1, Class A finish materials shall be used except where interior finish materials are protected on both sides by an automatic sprinkler system or attached to noncombustible backing or furring strips installed as specified in Section 803.4.1. The hangers and assembly members of such dropped ceilings that are below the main ceiling line shall be of noncombustible materials, except that in Type III and V construction, fire-retardant-treated wood shall be permitted. The construction of each set-out wall shall be of fire-resistance-rated construction as required elsewhere in this code.

**803.4.3 Heavy timber construction.** Wall and ceiling finishes of all classes as permitted in this chapter that are installed directly against the wood decking or planking of Type IV construction or to wood furring strips applied directly to the wood decking or planking shall be fire blocked as specified in Section 803.4.1.

**803.4.4 Materials.** An interior wall or ceiling finish that is not more than 0.25 inch (6.4 mm) thick shall be applied directly against a noncombustible backing.

**Exceptions:**

1. Class A materials.
2. Materials where the qualifying tests were made with the material suspended or furred out from the noncombustible backing.

**803.5 Interior finish requirements based on occupancy group.** Interior wall and ceiling finish shall have a flame spread index not greater than that specified in Table 803.5 for the group and location designated. Interior wall and ceiling finish materials, other than textiles, tested in accordance with NFPA 286 and meeting the acceptance criteria of Sections 803.2.1 and 803.2.2, shall be permitted to be used where a Class A classification in accordance with ASTM E 84 is required.

**TABLE 803.5**  
**INTERIOR WALL AND CEILING FINISH REQUIREMENTS BY**  
**OCCUPANCY<sup>K</sup>**  
**(Table 803.5 attached to end of document)**

**803.6 Textiles.** Where used as interior wall or ceiling finish materials, textiles, including materials having woven or non-woven, napped, tufted, looped or similar surface, shall comply with the requirements of this section.

**803.6.1 Textile wall coverings.** Textile wall coverings shall have a Class A flame



spread index in accordance with ASTM E 84 and be protected by automatic sprinklers installed in accordance with Section 903.3.1.1 or 903.3.1.2 or the covering shall meet the criteria of Section 803.6.1.1 or 803.6.1.2 when tested in the manner intended for use in accordance with NFPA 265 using the product mounting system, including adhesive.

**803.6.1.1 Method A test protocol.** During the Method A protocol, flame shall not spread to the ceiling during the 40 kW exposure. During the 150 kW exposure, the textile wall covering shall comply with all of the following:

1. Flame shall not spread to the outer extremity of the sample on the 8-foot by 12-foot (2438 mm by 3658 mm) wall.
2. The specimen shall not burn to the outer extremity of the 2-foot-wide (610 mm) samples mounted in the corner of the room.
3. Burning droplets deemed capable of igniting textile wall coverings or that burn for 30 seconds or more shall not form.
4. Flashover, as defined in NFPA 265, shall not occur.
5. The maximum net instantaneous peak heat release rate, determined by subtracting the burner output from the maximum heat release rate, does not exceed 300 kW.

**803.6.1.2 Method B test protocol.** During the Method B protocol, flames shall not spread to the ceiling at any time during the 40 kW exposure. During the 150 kW exposure, the textile wall covering shall comply with the following:

1. Flame shall not spread to the outer extremities of the samples on the 8-foot by 12-foot (2438 mm by 3658 mm) walls.
2. Flashover, as described in NFPA 265, shall not occur.

**803.6.2 Textile ceiling finish.** Where used as a ceiling finish, carpet and similar textile materials shall have a Class A flame spread index in accordance with ASTM E 84 and be protected by automatic sprinklers.

**803.7 Expanded vinyl wall coverings.** Expanded vinyl wall coverings shall comply with the requirements for textile wall and ceiling materials and their use shall comply with Section 803. 5.

**Exception:** Expanded vinyl wall or ceiling coverings complying with Section 803.2 shall not be required to comply with Section 803.1 or 803.5.

**803.8 Insulation.** Thermal and acoustical insulation shall comply with Section 719.

**803.9 Acoustical ceiling systems.** The quality, design, fabrication and erection of metal suspension systems for acoustical tile and lay-in panel ceilings in buildings or structures shall conform with the provisions of this chapter and other applicable requirements of this code.

**803.9.1 Materials and installation.** Acoustical materials complying with the interior finish requirements of Section 803 shall be installed in accordance with the manufacturer's recommendations and applicable provisions for applying interior finish.

**803.9.1.1 Suspended acoustical ceilings.** Acoustical ceilings that are to be suspended below floor or roof construction by means of a framing system shall consist of supporting hangers of minimum ¼ inch (6.4 mm) diameter steel rods, carrying channels of minimum 1½ inch (38 mm) deep cold-rolled steel weighing 0.457 pounds per linear foot (0.707 kg/m), and a supporting grid complying with Appendix R. Use of wire hangers shall not be permitted. Direct hung suspension systems shall not be permitted.

**Exception:** Acoustical ceiling systems in Groups R-2 and R-3 occupancies shall be permitted to be installed in accordance with ASTM C 635 and ASTM C 636 without modifications.

**803.9.1.2 Fire-resistance-rated construction.** Acoustical ceiling systems that are part of fire-resistance-rated construction shall be installed in the same manner used in the assembly tested and shall comply with the provisions of Chapter 7.

## **SECTION BC 804** **INTERIOR FLOOR FINISH**

**804.1 General.** Interior floor finish and floor covering materials shall comply with this section

**804.2 Classification.** Interior floor finish and floor covering materials required by Section 804.5.1 to be of Class I or II materials shall be classified in accordance with NFPA 253. The classification referred to herein corresponds to the classifications determined by NFPA 253 as follows: Class I, 0.45 watts/cm<sup>2</sup> or greater; Class II, 0.22 watts/cm<sup>2</sup> or greater.

**804.3 Testing and identification.** Floor covering materials shall be tested by an approved agency in accordance with NFPA 253 and identified by a hang tag or other suitable method so as to identify the manufacturer or supplier and style, and shall indicate the interior floor finish or floor covering classification according to Section 804.2. Carpet-type floor coverings shall be tested as proposed for use, including underlayment. Test reports confirming the information provided in the manufacturer's product identification shall be furnished to the department upon request.

**804.4 Application.** Combustible materials installed in or on floors of buildings of Type I or II construction shall conform with the requirements of Sections 804.4.1 through 804.4.4.

**Exception:** Stages and platforms constructed in accordance with Sections 410.3 and 410.4, respectively.

**804.4.1 Sub-floor construction.** Floor sleepers, bucks and nailing blocks shall not be constructed of combustible materials, unless the space between the fire-resistance-rated floor construction and the flooring is either solidly filled with approved noncombustible materials or fireblocked in accordance with Section 717, and provided that such open spaces shall not extend under or through permanent partitions or walls.

**804.4.2 Wood finish flooring.** Wood finish flooring is permitted to be attached directly to the embedded or fireblocked wood sleepers and shall be permitted where cemented directly to the top surface of approved fire-resistance-rated construction or directly to a wood subfloor attached to sleepers as provided for in Section 804.4.1.

**804.4.3 Insulating boards.** Combustible insulating boards not more than 0.5-inch (12.7 mm) thick and covered with approved finished flooring are permitted, where attached directly to a noncombustible floor assembly or to wood subflooring attached to sleepers as provided for in Section 804.4.1.

**804.4.4 Carpet-type floor coverings.** Carpet-type floor coverings are permitted where cemented directly to the top surface of approved fire-resistance-rated construction or directly to a wood subfloor attached to sleepers as provided for in Section 804.4.1.

**804.5 Interior floor finish limitations.** In buildings and spaces classified in Occupancy Group H and in all exits and exit passageways of any Occupancy Group, floor finishes shall be of non-combustible materials.

**Exception:** Interior floor finish may be of combustible materials in the following spaces. Carpet-type materials must be able to withstand a minimum critical radiant flux as specified in Section 804.5.1.

1. Buildings of Type VB Construction
2. Interior stairs in buildings of Types III, IV and V Construction in Occupancy Groups B, F, M or S-2, when the buildings are two stories in height or less.
3. Interior stairs in buildings of Types III, IV and V Construction in Occupancy Group R-2 and R-3 when the buildings are three stories in height or less.
4. Interior stairs in buildings of Types III, IV and V Construction in Occupancy

Group R-2 when occupied by three families or less.

**804.5.1 Minimum critical radiant flux.** Interior floor finishes shall not be less than Class I in Occupancy Groups I-2 and I-3 and not less than Class II in Occupancy Groups A, B, E, H, I- 4, M, R-1, R-2 and S. In all other Occupancy Groups, the interior floor finish shall comply with the DOC FF-1 “pill test” (CPSC 16 CFR, Part 1630).

## **SECTION BC 805** **DECORATIONS AND TRIM**

**805.1 Decorations.** All decorations shall comply with the requirements of the *New York City Fire Code*.

**805.2 Reserved.**

**805.3 Trim.** Material used as interior trim shall have minimum Class C flame spread as required by Section 803.1 and smoke-developed index as required by Section 803.1.1. Combustible trim, excluding handrails and guardrails, shall not exceed 10 percent of the aggregate wall or ceiling area in which it is located.

**805.4 Foam plastic as trim.** Foam plastic used as trim shall be permitted in Group R-3 occupancies, within individual dwelling units of Group R-1 and R-2 occupancies, and where approved in accordance with the special provisions of Section 2603.8. Foam plastics used as trim in any occupancy shall comply with the requirements of Section 2604.2.

**805.5 Pyroxylin plastic.** Imitation leather or other material consisting of or coated with a pyroxylin or similarly hazardous base shall not be used in Group A occupancies.

**TABLE 803.5**  
**INTERIOR WALL AND CEILING FINISH REQUIREMENTS BY OCCUPANCY<sup>K</sup>**

GROUP	SPRINKLERED			NONSPRINKLERED		
	Vertical exits and exit passageways <sup>a,b</sup>	Exit access corridors and other exitways	Rooms and enclosed spaces <sup>c</sup>	Vertical exits and exit passageways <sup>a,b</sup>	Exit access corridors and other exitways	Rooms and enclosed spaces <sup>c</sup>
A-1 & A-2	B	B	C	A	A <sup>d</sup>	B <sup>e</sup>
A-3 <sup>f</sup> , A-4, A-5	B	B	C	A	A <sup>d</sup>	C
B, E, M, R-1	B	B	B	A	A	C
F	B	C	C	A	B	B
H	B	B	C <sup>g</sup>	A	A	B
I-1	B	C	C	A	B	B
I-2	B	B	B <sup>h,i</sup>	A	A	B
I-3	A	A <sup>j</sup>	C	A	A	B
I-4	B	B	B <sup>h,i</sup>	A	A	B
R-2	B	B	C	A	A	C
R-3	C	C	C	C	C	C
S	B	C	C	A	B	C
U	No restrictions			No restrictions		

For SI: 1 inch = 25.4 mm, 1 square foot = 0.0929 m<sup>2</sup>.

- a. Class C interior finish materials shall be permitted for wainscoting or paneling of not more than 1,000 square feet of applied surface area in the grade lobby where applied directly to a noncombustible base or over furring strips applied to a noncombustible base and fireblocked as required by Section 803.4.1.
- b. In vertical exits of buildings less than three stories in height of other than Group I-3, Class B interior finish for nonsprinklered buildings and Class C interior finish for sprinklered buildings shall be permitted.
- c. Requirements for rooms and enclosed spaces shall be based upon spaces enclosed by partitions. Where a fire-resistance rating is required for structural elements, the enclosing partitions shall extend from the floor to the ceiling. Partitions that do not comply with this shall be considered enclosing spaces and the rooms or spaces on both sides shall be considered one. In determining the applicable requirements for rooms and enclosed spaces, the specific occupancy thereof shall be the governing factor regardless of the group classification of the building or structure.
- d. Lobby areas in A-1, A-2 and A-3 occupancies shall not be less than Class B materials.
- e. Class C interior finish materials shall be permitted in places of assembly with an occupant load of 300 persons or less.
- f. For churches and places of worship, wood used for ornamental purposes, trusses, paneling or chancel furnishing shall be permitted.
- g. Class B material required where building exceeds two stories.
- h. Class C interior finish materials shall be permitted in administrative spaces.
- i. Class C interior finish materials shall be permitted in rooms with a capacity of four persons or less.
- j. Class B materials shall be permitted as wainscoting extending not more than 48 inches above the finished floor in exit access corridors.
- k. Finish materials as provided for in other sections of this code.
- l. Applies when the vertical exits, exit passageways, exit access corridors or exitways, or rooms and spaces are protected by a sprinkler system installed in accordance with Section 903.3.1.1 or 903.3.1.2.

**CHAPTER 9**  
**FIRE PROTECTION SYSTEMS**

**SECTION BC 901**  
**GENERAL**

**901.1 Scope.** The provisions of this chapter shall specify where fire protection systems are required and shall apply to the design, installation and operation of fire protection systems.

**901.1.1 Referenced standards.** Where this code makes reference to the nationally recognized standards NFPA 13, NFPA 13D, NFPA 13R, NFPA 14, or NFPA 72, such standard shall be as modified for New York City in accordance with Appendix Q.

**901.2 Fire protection systems.** Fire protection systems shall be installed, repaired, operated and maintained in accordance with this code and the *New York City Fire Code*. Any fire protection system for which an exception or reduction to the provisions of this code has been granted shall be considered to be a required system.

**Exception:** Any fire protection system or portion thereof not required by this code shall be permitted to be installed provided that such system meets the requirements of this code.

**901.3 Modifications.** No person shall remove or modify any fire protection system installed or maintained under the provisions of this code or the *New York City Fire Code* without approval by the commissioner.

**901.4 Threads.** Threads provided for Fire Department connections to sprinkler systems, standpipes, yard hydrants or any other fire hose connection shall be compatible with the connections used by the Fire Department.

**901.5 Acceptance tests.** Fire protection systems shall be tested in accordance with the requirements of this code and the *New York City Fire Code*. When required, the tests shall be conducted in the presence of the department or an approved agency. Tests required by this code, the *New York City Fire Code* and the standards listed in this code shall be conducted at the expense of the owner or the owner's representative. It shall be unlawful to occupy portions of a structure until the required fire protection systems within that portion of the structure have been tested and approved.

**901.6 Supervisory service.** Where required, fire protection systems shall be monitored by an approved supervising station in accordance with NFPA 72.

**901.6.1 Automatic sprinkler systems.** Automatic sprinkler systems shall be monitored by an approved supervising station.

**Exceptions:**

1. A supervising station is not required for automatic sprinkler systems protecting one- and two-family dwellings.
2. Limited area sprinkler systems serving fewer than 20 sprinkler heads.

**901.6.2 Fire alarm systems.** Fire alarm systems required by the provisions of Section 907.2 of this code and the *New York City Fire Code* shall be monitored by an approved supervising station in accordance with Section 907.14.

**Exceptions:**

1. Single- and multiple-station smoke alarms and carbon monoxide alarms required by Section 907.2.10.
2. Smoke detectors in Group I-3 occupancies.
3. Supervisory service is not required for automatic sprinkler systems in one- and two-family dwellings.

**901.6.3 Group H.** Manual fire alarm, automatic fire-extinguishing and emergency alarm systems in Group H occupancies shall be monitored by an approved supervising station.

**901.7 Fire areas.** Where buildings, or portions thereof, are divided into fire areas so as not to exceed the limits established for requiring a fire protection system in accordance with this chapter, such fire areas shall be separated by fire barriers having a fire-resistance rating of not less than that determined in accordance with Section 706.3.7.

**SECTION BC 902**  
**DEFINITIONS**

**902.1 Definitions.** The following words and terms shall, for the purposes of this chapter, and as used elsewhere in this code, have the meanings shown herein.

**ALARM NOTIFICATION APPLIANCE.** A fire alarm system component such as a bell, horn, speaker, light or text display that provides audible, tactile or visible outputs, or any combination thereof.

**ALARM SIGNAL.** A signal indicating an emergency requiring immediate action, such as a signal indicative of fire.

**ANNUNCIATOR.** A unit containing one or more indicator lamps, alphanumeric displays or other equivalent means in which each indication provides status information about a circuit, condition or location.

**AUDIBLE ALARM NOTIFICATION APPLIANCE.** A notification appliance that alerts by the sense of hearing.

**AUTOMATIC.** As applied to fire protection devices, any device, equipment, or system that initiates a system function as a result of a predetermined temperature rise, rate of temperature rise or combustion products, without the necessity for human intervention.

**AUTOMATIC FIRE-EXTINGUISHING SYSTEM.** An approved system of devices and equipment that automatically detects a fire and discharges an approved fire-extinguishing agent onto or in the area of a fire.

**AUTOMATIC SPRINKLER SYSTEM.** An automatic fire-extinguishing system utilizing water, designed in accordance with fire protection engineering standards. The system includes a suitable water supply and a network of specially sized or hydraulically designed piping installed in a structure or area, generally overhead, to which automatic sprinklers are connected in a systematic pattern. The system is usually activated by heat from a fire and discharges water over the fire area.

**AVERAGE AMBIENT SOUND LEVEL.** The root mean square, A-weighted sound pressure level measured over a 24-hour period.

**CARBON DIOXIDE EXTINGUISHING SYSTEMS.** An automatic fire-extinguishing system supplying carbon dioxide (CO<sub>2</sub>) from a pressurized vessel through fixed pipes and nozzles. The system includes a manual- or automatic-actuating mechanism.

**CARBON MONOXIDE ALARM.** A single- or multiple-station alarm responsive to carbon monoxide and not connected to a system.

**CARBON MONOXIDE DETECTOR.** A listed device that senses carbon monoxide.

**CARBON MONOXIDE PRODUCING EQUIPMENT.** Any furnace, boiler, water heater, fireplace, cooking appliance, gas clothes dryer, apparatus, appliance or device that burns coal, kerosene, oil, wood, fuel gases and other petroleum products including, but not limited to, methane, natural gas, liquefied natural gas and manufactured fuel gases.

**CEILING LIMIT.** The maximum concentration of an air-borne contaminant to which one may be exposed, as published in DOL 29 CFR Part 1910.1000.

**CENTRAL STATION.** A facility that receives alarm signals from a protected premise and/or retransmits such alarm signals to a Fire Department communication office.

**CLEAN AGENT.** Electrically nonconducting, volatile or gaseous fire extinguishant that does not leave a residue upon evaporation.



**COMMERCIAL COOKING SYSTEM.** A system consisting of commercial cooking equipment, exhaust hood, filters, exhaust duct system, fire suppression system and other related appurtenances designed to capture grease-laden cooking vapors and exhaust them safely to the outdoors.

**CONSTANTLY ATTENDED LOCATION.** A designated location at a facility staffed by trained personnel on a continuous basis where alarm or supervisory signals are monitored and facilities are provided for notification of the Fire Department or other emergency services.

**DELUGE SPRINKLER SYSTEM.** A sprinkler system employing open sprinklers attached to a piping system connected to a water supply through a valve that is opened by the operation of a detection system installed in the same areas as the sprinklers. When this valve opens, water flows into the piping system and discharges from all sprinklers attached thereto.

**DETECTOR, HEAT.** A fire detector that senses heat produced by burning substances. Heat is the energy produced by combustion that causes substances to rise in temperature.

**DRY-CHEMICAL EXTINGUISHING SYSTEM.** A fire extinguishing system designed to discharge a powder composed of small particles, usually of sodium bicarbonate, potassium bicarbonate, urea-potassium-based bicarbonate, potassium chloride or monoammonium phosphate, with added particulate material supplemented by special treatment to provide resistance to packing, resistance to moisture absorption (caking) and the proper flow capabilities.

**EMERGENCY ALARM SYSTEM.** A system to provide indication and warning of an emergency condition involving hazardous materials.

**EMERGENCY VOICE/ALARM COMMUNICATIONS.** Dedicated manual or automatic facilities for originating and distributing voice instructions, as well as alert and evacuation signals pertaining to a fire emergency, to the occupants of a building.

**FIRE ALARM BOX, MANUAL.** See “Manual Fire Alarm Box.”

**FIRE ALARM CONTROL PANEL.** A system component that receives inputs from automatic and manual fire alarm devices and is capable of supplying power to detection devices and transponder(s) or off-premises transmitter(s). The control panel is capable of providing a transfer of power to the notification appliances and transfer of condition to relays or devices.

**FIRE ALARM SIGNAL.** A signal initiated by a fire alarm-initiating device such as a manual fire alarm box, automatic fire detector, water flow switch, or other device whose activation is indicative of the presence of a fire or fire signature.

**FIRE ALARM SYSTEM.** A system or portion of a combination system consisting of

components and circuits arranged to monitor and annunciate the status of fire alarm or supervisory signal-initiating devices and to initiate the appropriate response to those signals.

**FIRE COMMAND CENTER.** The principal attended or unattended location where the status of detection, alarm communications and control systems is displayed, and from which the system(s) can be manually controlled.

**FIRE DETECTOR, AUTOMATIC.** A device designed to detect the presence of a fire signature and to initiate action.

**FIRE PROTECTION SYSTEM.** Approved devices, equipment and systems or combinations of systems used to detect a fire, activate an alarm, extinguish or control a fire, control or manage smoke and products of a fire or any combination thereof.

**FIRE SAFETY FUNCTIONS.** Building and fire control functions that are intended to increase the level of life safety for occupants or to control the spread of harmful effects of fire.

**FOAM-EXTINGUISHING SYSTEM.** A fire extinguishing system designed to discharge a foam made from concentrates, either mechanically or chemically, over the area to be protected.

**HALOGENATED EXTINGUISHING SYSTEM.** An automatic fire-extinguishing system using one or more of the following halogen elements: fluorine, chlorine, bromine and iodine.

**INITIATING DEVICE.** A system component that originates transmission of a change-of-state condition, such as in a smoke detector, manual fire alarm box or supervisory switch.

**LIMITED AREA SPRINKLER SYSTEM.** An automatic sprinkler system serving fewer than 20 sprinkler heads on any single connection.

**LISTED.** See Chapter 1 of Title 28 of the *Administrative Code*.

**MANUAL FIRE ALARM BOX.** A manually operated device used to initiate an alarm signal.

**MULTIPLE-STATION ALARM DEVICE.** Two or more single-station alarm devices that are capable of interconnection such that actuation of one causes all integral or separate audible alarms to operate. It also can consist of one single-station alarm device having connections to other detectors or to a manual fire alarm box.

**MULTIPLE-STATION SMOKE ALARM.** Two or more single-station smoke alarm devices that are capable of interconnection such that actuation of one causes all integral

or separate audible alarms to operate.

**PRESIGNAL SYSTEM.** A fire alarm system having a feature that allows initial fire alarm signals to sound in a constantly attended central location and for which a human action is subsequently required to achieve a general alarm, or a feature that allows the control equipment to delay the general alarm by more than 1 minute after the start of the alarm processing.

**RECORD DRAWINGS.** Drawings (“as built”) that document the location of all devices, appliances, wiring sequences, wiring methods and connections of the components of a fire alarm system as installed.

**SINGLE-STATION SMOKE ALARM.** An assembly incorporating the detector, the control equipment and the alarm-sounding device in one unit, operated from a power supply either in the unit or obtained at the point of installation.

**SMOKE ALARM.** A single- or multiple-station alarm responsive to smoke and not connected to a system.

**SMOKE DETECTOR.** A listed device that senses visible or invisible particles of combustion.

**SMOKEPROOF ENCLOSURE.** An exit stairway designed and constructed so that the movement of the products of combustion produced by a fire occurring in any part of the building into the enclosure is limited.

**STANDPIPE SYSTEM.** Piping installed in a building or structure that serves to transfer water from a water supply to hose connections at one or more locations in a building or structure for firefighting purposes, including the following types of systems:

**Automatic dry.** A dry standpipe system, normally filled with pressurized air, that is arranged through the use of a device, such as dry pipe valve, to admit water into the system piping automatically upon the opening of a hose valve. The water supply for an automatic dry standpipe system shall be capable of supplying the system demand.

**Automatic wet.** A wet standpipe system that has a water supply that is capable of supplying the system demand automatically.

**Manual dry.** A dry standpipe system that does not have a permanent water supply attached to the system. Manual dry standpipe systems require water from a Fire Department pumper to be pumped into the system through the Fire Department connection in order to meet the system demand.

**Manual wet.** A wet standpipe system connected to a water supply for the purpose of maintaining water within the system but that does not have a water supply capable of delivering the system demand attached to the system. Manual-wet standpipe systems

require water from a Fire Department pumper to be pumped into the system in order to meet the system demand.

**Semiautomatic dry.** A dry standpipe system that is arranged through the use of a device, such as a deluge valve, to admit water into the system piping upon activation of a remote control device located at a hose connection. A remote control activation device shall be provided at each hose connection. The water supply for a semiautomatic dry standpipe system shall be capable of supplying the system demand.

**STANDPIPE SYSTEM, CLASSES OF.** Standpipe classes are as follows:

**Class I system.** A system providing 2.5-inch (64 mm) hose connections to supply water for use by the Fire Department and those trained in handling heavy fire streams.

**Class II system.** A system providing 1.5-inch (38 mm) hose stations to supply water for use primarily by the building occupants or by the Fire Department during initial response.

**Class III system.** A system providing 1.5-inch (38 mm) hose stations to supply water for use by building occupants and 2.5-inch (64 mm) hose connections to supply a larger volume of water for use by the Fire Department and those trained in handling heavy fire streams.

**SUPERVISING STATION.** A facility that receives signals and at which personnel are in attendance at all times to respond to these signals.

**SUPERVISORY SERVICE.** The service required to monitor performance of guard tours and the operative condition of fixed suppression systems or other systems for the protection of life and property.

**SUPERVISORY SIGNAL.** A signal indicating the need for action in connection with the supervision of guard tours, fire suppression systems or equipment, fire alarm systems, or the maintenance features of related systems.

**SUPERVISORY SIGNAL-INITIATING DEVICE.** An initiation device, such as a valve supervisory switch, water-level indicator or low-air pressure switch on a dry-pipe sprinkler system, whose change of state signals an off-normal condition and its restoration to normal of a fire protection or life safety system, or a need for action in connection with the supervision of guard tours, fire suppression systems or equipment, fire alarm systems, or the maintenance features of related systems.

**TIRES, BULK STORAGE OF.** Storage of tires where the area available for storage exceeds 20,000 cubic feet (566 m<sup>3</sup>).

**TROUBLE SIGNAL.** A signal initiated by the fire alarm system or device indicative of

a fault in a monitored circuit or component.

**VISIBLE ALARM NOTIFICATION APPLIANCE.** A notification appliance that alerts by the sense of sight.

**WET-CHEMICAL EXTINGUISHING SYSTEM.** A solution of water and potassium-carbonate-based chemical, potassium-acetate-based chemical or a combination thereof, forming an extinguishing agent.

**WIRELESS PROTECTION SYSTEM.** A system or a part of a system that can transmit and receive signals without the aid of wire.

**ZONE.** A defined area within the protected premises. A zone can define an area from which a signal can be received, an area to which a signal can be sent or an area in which a form of control can be executed.

### **SECTION BC 903** **AUTOMATIC SPRINKLER SYSTEMS**

**903.1 General.** Automatic sprinkler systems shall comply with this section. Installation of automatic sprinkler systems shall comply with the special inspection requirements of Chapter 17.

**903.1.1 Alternative protection.** Where the discharge of water would be hazardous, alternative automatic fire-extinguishing systems complying with Section 904 shall be permitted in lieu of automatic sprinkler protection where recognized by the applicable standard and approved by the commissioner.

**903.1.2 Construction documents.** Construction documents for automatic sprinkler systems shall contain plans that include the following data and information:

1. The location and size of water supplies and the location, spacing, number, and type of sprinkler heads to be used, with approximate location and size of all feed mains, valves and other essential features of the system. For hydraulically calculated systems, hydraulic data substantiating pipe sizes shown shall be submitted and hydraulic reference points and areas must be indicated on the plan.
2. A diagram showing the proposed sprinkler system in relation to principal construction features of the building, such as its size, walls, columns, and partitions; and such other information as may be necessary for the evaluation of the system.
3. The location, number, and type of any electrical or automatic devices or alarms to be used in the system.

4. In buildings where a new separate fire sprinkler system is required, the available water pressure at the top and bottom floors of each zone shall be shown on the riser diagram.
5. For street pressure-fed systems and fire pumps, a statement from the New York City Department of Environmental Protection, giving the minimum water pressure in the main serving the building.

**903.2 Where required.** Approved automatic sprinkler systems in new buildings and structures shall be provided in the locations described in this section.

**Exception:** Sprinklers shall not be required in electrical equipment rooms where all of the following conditions are met:

1. The room is dedicated to electrical equipment only.
2. Only dry-type electrical equipment is used.
3. Equipment is installed in a 2-hour fire-rated enclosure including protection for penetrations.
4. No combustible storage is permitted to be stored in the room.

**903.2.1 Group A.** An automatic sprinkler system shall be provided throughout buildings and portions thereof used as Group A occupancies as provided in this section. The automatic sprinkler system shall be provided throughout the floor area where the Group A occupancy is located, and in all floors between the Group A occupancy and the level of exit discharge. In all Group A occupancies providing live entertainment, dressing rooms and property rooms used in conjunction with such assembly occupancy shall be provided with an automatic sprinkler system. Stages shall comply with Section 410.6.

**903.2.1.1 Group A-1.** An automatic sprinkler system shall be provided for Group A-1 occupancies where any one of the following conditions exists:

1. The fire area exceeds 12,000 square feet (1115 m<sup>2</sup>).
2. The fire area has an occupant load of 300 or more.
3. The aggregate occupant load of all fire areas occupied by Group A, located on any given floor other than the level of exit discharge, is 300 or more.
4. The fire area contains a multitheater complex.

**903.2.1.2 Group A-2.** An automatic sprinkler system shall be provided for Group

A-2 occupancies where any one of the following conditions exists:

1. The fire area exceeds 5,000 square feet (464.5 m<sup>2</sup>).
2. The fire area has an occupant load of 300 or more.
3. The aggregate occupant load of all fire areas occupied by Group A, located on any given floor other than the level of exit discharge, is 300 or more.
4. The A-2 occupancy is used as a cabaret.

**903.2.1.3 Group A-3.** An automatic sprinkler system shall be provided for Group A-3 occupancies where any one of the following conditions exists:

1. The fire area exceeds 12,000 square feet (1115 m<sup>2</sup>).
2. The fire area has an occupant load of 300 or more.
3. The aggregate occupant load of all fire areas occupied by Group A, located on any given floor other than the level of exit discharge, is 300 or more.

**Exception:** Areas used exclusively as participant sports areas where the main floor area is located at the same level as the level of exit discharge of the main entrance and exit.

**903.2.1.4 Group A-4.** An automatic sprinkler system shall be provided for Group A-4 occupancies where any one of the following conditions exists:

1. The fire area exceeds 12,000 square feet (1115 m<sup>2</sup>).
2. The fire area has an occupant load of 300 or more.
3. The aggregate occupant load of all fire areas occupied by Group A, located on any given floor other than the level of exit discharge, is 300 or more.

**Exception:** Areas used exclusively as participant sports areas where the main floor area is located at the same level as the level of exit discharge of the main entrance and exit.

**903.2.1.5 Group A-5.** An automatic sprinkler system shall be provided in all enclosed areas of the structure, including but not limited to the concession concourse, concession stands, retail areas, press boxes and other accessory use areas in excess of 1,000 square feet (93 m<sup>2</sup>).

**903.2.2 Group E.** An automatic sprinkler system shall be provided for Group E occupancies as follows:

1. Throughout all Group E fire areas greater than 20,000 square feet (1858 m<sup>2</sup>) in area.
2. Throughout every portion of educational buildings below the level of exit discharge.

**Exception:** An automatic sprinkler system is not required in any fire area or area below the level of exit discharge where every classroom throughout the building has at least one exterior exit door at ground level without intervening corridors, passageways, or exit enclosures.

**903.2.3 Group F.** An automatic sprinkler system shall be provided throughout all buildings containing a Group F occupancy where any one of the following conditions exists:

1. Where a Group F-1 fire area exceeds 12,000 square feet (1115 m<sup>2</sup>);
2. Where a Group F-1 fire area is located more than three stories above grade; or
3. Where the combined area of all Group F-1 fire areas on all floors, including any mezzanines, exceeds 24,000 square feet (2230 m<sup>2</sup>); or
4. Where required by Section 280 of the New York State Labor Law for “factory buildings” defined in Section 2 of such law.

**903.2.3.1 Woodworking operations.** An automatic sprinkler system shall be provided throughout any Group F-1 occupancy fire area that contains wood working operations in excess of 2,500 square feet (232 m<sup>2</sup>) in area that generate finely divided combustible waste or use finely divided combustible materials.

**903.2.3.2 Repair garages.** An automatic sprinkler system shall be provided throughout all buildings used as repair garages in accordance with Section 406, as follows:

1. Buildings two or more stories in height, including basements, with a fire area containing a repair garage exceeding 10,000 square feet (929 m<sup>2</sup>).
2. One-story buildings with a fire area containing a repair garage exceeding 12,000 square feet (1115 m<sup>2</sup>).
3. Buildings with a repair garage servicing vehicles parked in the basement.

**903.2.3.3 Group F-1 fire areas.** An automatic sprinkler system shall be provided



throughout any Group F-1 occupancy fire area where any one of the following conditions exists:

1. The fire area exceeds 7,500 square feet (697 m<sup>2</sup>).
2. The fire area of any size is located more than 3 stories above grade.

**903.2.4 Group H.** Automatic sprinkler systems shall be provided in high-hazard occupancies as required in Sections 903.2.4.1 through 903.2.4.3 and the *New York City Fire Code*.

**903.2.4.1 General.** An automatic sprinkler system shall be installed in Group H occupancies. An automatic sprinkler system shall be installed throughout buildings with a main use or dominant occupancy of Group H.

**903.2.4.2 Group H-5.** An automatic sprinkler system shall be installed throughout buildings containing Group H-5 occupancies. The design of the sprinkler system shall not be less than that required by this code for the occupancy hazard classifications in accordance with Table 903.2.4.2. Where the design area of the sprinkler system consists of a corridor protected by one row of sprinklers, the maximum number of sprinklers required to be calculated is 13.

**TABLE 903.2.4.2**  
**GROUP H-5 SPRINKLER DESIGN CRITERIA**  
**(Table 903.2.4.2 attached to end of document)**

**903.2.4.3 Pyroxylin plastics.** An automatic sprinkler system shall be provided in buildings, or portions thereof, where cellulose nitrate film or pyroxylin plastics are manufactured, stored or handled in quantities exceeding 100 pounds (45 kg).

**903.2.5 Group I.** An automatic sprinkler system shall be provided in Group I occupancies. An automatic sprinkler system shall be installed throughout buildings with a main use or dominant occupancy of Group I.

**Exception:** An automatic sprinkler system installed in accordance with Section 903.3.1.2 or 903.3.1.3 shall be allowed in Group I-1 facilities.

**903.2.6 Group M.** An automatic sprinkler system shall be provided throughout buildings containing a Group M occupancy where any one of the following conditions exists:

1. Where a Group M fire area exceeds 12,000 square feet (1115 m<sup>2</sup>);
2. Where the combined area of all Group M fire areas on all floors, including any mezzanines, exceeds 24,000 square feet (2230 m<sup>2</sup>).

**903.2.6.1 High-piled storage.** An automatic sprinkler system shall be provided in accordance with the *New York City Fire Code* in all buildings of Group M where storage of merchandise is in high-piled or rack storage arrays.

**903.2.6.2 Group M fire areas.** An automatic sprinkler system shall be provided throughout any Group M occupancy fire area where any one of the following conditions exists:

1. The fire area exceeds 7,500 square feet (697 m<sup>2</sup>).
2. The fire area of any size is located more than 3 stories above grade.
3. The fire area of any size is located in a high-rise building.
4. The fire area of any size contains an unenclosed stair or escalator connecting two or more floors.

**903.2.7 Group R.** An automatic sprinkler system shall be installed in Group R fire areas. An automatic sprinkler system shall be installed throughout buildings with a main use or dominant occupancy of Group R.

**Exception:** An automatic sprinkler system shall not be required in detached one- and two-family dwellings and multiple single-family dwellings (town houses), provided that such structures are not more than three stories above grade plane in height and have separate means of egress.

**903.2.8 Group S-1.** An automatic sprinkler system shall be provided throughout all buildings containing a Group S-1 occupancy where any one of the following conditions exists:

1. A Group S-1 fire area exceeds 12,000 square feet (1115 m<sup>2</sup>);
2. The building is greater than 1,000 square feet (92.9 m<sup>2</sup>) in area and the main use or dominant occupancy is Group S-1; or
3. The combined area of all Group S-1 fire areas on all floors, including any mezzanines, exceeds 24,000 square feet (2230 m<sup>2</sup>).

**903.2.8.1 Group S-1 fire areas.** An automatic sprinkler system shall be provided throughout any Group S-1 occupancy fire area where any one of the following conditions exists:

1. The fire area exceeds 500 square feet (46 m<sup>2</sup>).
2. The fire area of any size is located more than 3 stories above grade.

**903.2.8.2 Bulk storage of tires.** Buildings and structures where the area for the storage of tires exceeds 500 square feet (47 m<sup>2</sup>) or 7,500 cubic feet (212 m<sup>3</sup>) shall be equipped throughout with an automatic sprinkler system in accordance with Section 903.3.1.1.

**903.2.9 Group S-2.** An automatic sprinkler system shall be installed throughout buildings greater than 5,000 square feet (465 m<sup>2</sup>) in area where the main use or dominant occupancy is Group S-2.

**903.2.9.1 Commercial parking garages.** An automatic sprinkler system shall be provided throughout buildings used for storage of commercial trucks or buses where the fire area exceeds 5,000 square feet (465 m<sup>2</sup>).

**903.2.9.2 Group S-2 fire areas.** An automatic sprinkler system shall be provided throughout any Group S-2 occupancy fire area greater than 5,000 square feet (465 m<sup>2</sup>).

**903.2.9.3 Parking garages.** An automatic sprinkler system shall be provided throughout buildings classified as enclosed parking garages in accordance with Section 406.4 or where an open or enclosed parking garage is located beneath other occupancy groups.

**Exception:** Parking garages located beneath Group R-3 occupancies.

**903.2.10 All occupancies.** An automatic sprinkler system shall be installed in the locations set forth in Sections 903.2.10.1 through 903.2.10.6.

**903.2.10.1 Above or below-grade stories.** An automatic sprinkler system shall be installed throughout every above or below grade story of all buildings where the floor area exceeds 1,500 square feet (139.4 m<sup>2</sup>) and where there is not provided at least one of the following types of exterior wall openings:

- 1. Openings below grade that lead directly to ground level by an exterior stairway complying with Section 1009 or an outside ramp complying with Section 1010. Openings shall be located in each 50 linear feet (15 240 mm), or fraction thereof, of exterior walls facing onto a street, public way or frontage space, in the story on at least one side.**
- 2. Openings entirely above the adjoining ground level totaling at least 20 square feet (1.86 m<sup>2</sup>) in each 50 linear feet (15 240 mm), or fraction thereof, of exterior walls facing onto a street, public way or frontage space, in the story on at least one side.**

**903.2.10.1.1 Opening dimensions and access.** Such openings shall have a minimum dimension of not less than 30 inches (762 mm). Such openings shall be accessible to the Fire Department from the exterior and shall not be

obstructed in a manner that fire fighting or rescue cannot be accomplished from the exterior.

**903.2.10.1.2 Openings on one side only.** Where such openings in a story are provided on only one side and the opposite wall of such story is more than 100 feet (30 480 mm) from such openings, the story shall be equipped throughout with an approved automatic sprinkler system, or openings as specified above shall be provided on at least two sides of the story.

**903.2.10.1.3 Below-grade stories.** Where any portion of a below-grade story is located more than 75 feet (22 860 mm) from openings required by Section 903.2.10.1, the below-grade story shall be equipped throughout with an approved automatic sprinkler system.

**903.2.10.2 Rubbish and linen chutes.** An automatic sprinkler system shall be installed at the top of rubbish and linen chutes, in chute access rooms, and in their terminal rooms. Chutes extending through three or more floors shall have additional sprinkler heads installed within such chutes at alternate floors. Chute sprinklers shall be accessible for servicing.

**903.2.10.3 Buildings over 55 feet in height.** An automatic sprinkler system shall be installed throughout buildings with a floor level having an occupant load of 30 or more that is located 55 feet (16 764 mm) or more above the lowest level of fire department vehicle access.

**903.2.10.4 Steel-plated and vault-like occupancies.** An automatic sprinkler system shall be installed throughout all steel-plated or similarly reinforced or secured vault-like occupancies regardless of area.

**903.2.10.5 Refuse collection and disposal areas.** An automatic sprinkler system shall be installed throughout all areas used for the storage and sorting of refuse and recyclables.

**903.2.10.6 Laundry drying areas.** An automatic sprinkler system shall be installed in spaces in which two or more clothes drying machines are installed. Sprinkler heads shall be spaced to cover the areas 5 feet (1524 mm) on all sides of the drying machines.

**903.2.11 During construction.** Automatic sprinkler systems required during construction, alteration and demolition operations shall be provided in accordance with Chapter 33 and the *New York City Fire Code*.

**903.2.12 Other hazards.** Automatic sprinkler protection shall be provided for the hazards indicated in Sections 903.2.12.1 and 903.2.12.2.

**903.2.12.1 Ducts conveying hazardous exhausts.** Where required by the *New*

York City Mechanical Code, automatic sprinklers shall be provided in ducts conveying hazardous exhaust, or flammable or combustible materials.

**Exception:** Ducts in which the largest cross-sectional diameter of the duct is less than 10 inches (254 mm).

**903.2.12.2 Commercial cooking operations.** An automatic sprinkler system shall not be installed in a commercial kitchen exhaust hood and duct system. Fire extinguishing systems shall be installed in commercial cooking systems in accordance with Section 904.11

**903.2.13 Other buildings, occupancies, and areas.** In addition to the requirements of Section 903.2, the provisions indicated in Table 903.2.13 also require the installation of a suppression system for certain buildings and areas. Suppression systems shall also be required as provided for in other sections of this code, the *New York City Fuel Gas Code*, and the *New York City Mechanical Code*.

**TABLE 903.2.13**  
**ADDITIONAL REQUIRED SUPPRESSION SYSTEMS**  
**(Table 903.2.13 attached to end of document)**

**903.3 Installation requirements.** Automatic sprinkler systems shall be designed and installed in accordance with Sections 903.3.1 through 903.3.7.

**903.3.1 Standards.** Sprinkler systems shall be designed and installed in accordance with Section 903.3.1.1, 903.3.1.2 or 903.3.1.3.

**903.3.1.1 NFPA 13 sprinkler systems.** Where the provisions of this code require that a building or portion thereof be equipped throughout with an automatic sprinkler system in accordance with Section 903.3.1.1, sprinklers shall be installed throughout in accordance with NFPA 13 as modified in Appendix Q except as provided in Section 903.3.1.1.1.

**903.3.1.1.1 Exempt locations protected by other means.** Automatic sprinklers shall not be required in the following rooms or areas where such rooms or areas are protected with an approved automatic fire detection system in accordance with Section 907.2 that will respond to visible or invisible particles of combustion and an alternative extinguishing system in accordance with Section 904. Sprinklers shall not be omitted from any room merely because it is damp, of fire-resistance-rated construction or contains electrical equipment.

1. Any room where the application of water, or flame and water, constitutes a serious life or fire hazard.
2. Any room or space where sprinklers are considered undesirable

because of the nature of the contents, when approved by the commissioner.

3. Generator and transformer rooms separated from the remainder of the building by walls and floor/ceiling or roof/ceiling assemblies having a fire-resistance rating of not less than 2 hours.

**903.3.1.2 NFPA 13R sprinkler systems.** Where allowed in buildings of Group R, up to and including six stories in height, automatic sprinkler systems shall be installed throughout in accordance with NFPA 13R as modified in Appendix Q.

**903.3.1.2.1 Balconies.** Sprinkler protection shall be provided for exterior balconies and ground-floor patios of dwelling units where the building is of Type V construction and automatic sprinkler protection is required for the Group R occupancy. Side wall sprinklers that are used to protect such areas shall be permitted to be located such that their deflectors are within 1 inch (25 mm) to 6 inches (152 mm) below the structural members, and a maximum distance of 14 inches (356 mm) below the deck of the exterior balconies that are constructed of open wood joist construction.

**903.3.1.3 NFPA 13D sprinkler systems.** Where allowed, automatic sprinkler systems in one- and two-family dwellings shall be installed throughout in accordance with NFPA 13D as modified .

**903.3.2 Quick-response and residential sprinklers.** Where automatic sprinkler systems are required by this code, quick-response or residential automatic sprinklers shall be installed in the following areas in accordance with Section 903.3.1 and their listings:

1. Throughout all spaces within a smoke compartment containing patient dwelling units in Group I-2 in accordance with this code.
2. Dwelling units in Group R and I-1 occupancies.
3. Light-hazard occupancies as defined in NFPA 13.

**903.3.3 Obstructed locations.** Automatic sprinklers shall be installed with due regard to obstructions that will delay activation or obstruct the water distribution pattern. Automatic sprinklers shall be installed in or under covered kiosks, displays, booths, concession stands, or equipment that exceeds 4 feet (1219 mm) in width. Not less than a 3-foot (914 mm) clearance shall be maintained between automatic sprinklers and the top of piles of combustible fibers.

**Exception:** Kitchen equipment under exhaust hoods protected with a fire-extinguishing system in accordance with Section 904.

**903.3.4 Actuation.** Automatic sprinkler systems shall be automatically actuated unless otherwise specifically provided in this code.

**903.3.5 Water supplies.** Water supplies for automatic sprinkler systems shall comply with this section and the standards referenced in Section 903.3.1. The potable water supply shall be protected against back flow in accordance with the requirements of this section, the *New York City Plumbing Code*, and Rules of the New York City Department of Environmental Protection.

**903.3.5.1 Domestic services.** Where the domestic service provides the water supply for the automatic sprinkler system, the supply shall be in accordance with NFPA 13.

**903.3.5.1.1 Limited area sprinkler systems.** Limited area sprinkler systems serving fewer than 20 sprinklers on any single connection are permitted to be connected to the domestic service where a wet automatic standpipe is not available. Limited area sprinkler systems connected to domestic water supplies shall comply with NFPA 13.

The domestic service shall be capable of supplying the simultaneous domestic demand and the sprinkler demand required to be hydraulically calculated by NFPA 13, NFPA 13R or NFPA 13D.

**903.3.5.1.2 Residential combination services.** A single combination water supply shall be permitted in accordance with NFPA 13R.

**903.3.5.2 Secondary water supply.** A secondary on-site water supply equal to the hydraulically calculated sprinkler demand, including the hose stream requirement, shall be provided for high-rise buildings in Seismic Design Category C or D as determined by this code, and in any high-rise building greater than 300 feet (91 440 mm) in height. The secondary water supply shall have a duration not less than 30 minutes as determined by the occupancy hazard classification in accordance with NFPA 13.

**903.3.6 Hose threads.** Fire hose threads used in connection with automatic sprinkler systems shall be approved and compatible with Fire Department hose threads.

**903.3.7 Fire Department connections.** The location of Fire Department connections shall be installed in accordance with Section 905 of this code.

**903.4 Sprinkler system monitoring and alarms.** All valves controlling the water supply for automatic sprinkler systems, pumps, tanks, water levels and temperatures, critical air pressures and water-flow switches on all sprinkler systems shall be electrically supervised by the fire alarm system.

**Exceptions:**

1. Automatic sprinkler systems protecting one- and two-family dwellings.
2. Automatic sprinkler systems installed in accordance with NFPA13R where a common supply main is used to supply both domestic water and the automatic sprinkler systems and a separate shutoff valve for the automatic sprinkler system is not provided.
3. Jockey pump control valves that are sealed or locked in the open position.
4. Control valves to commercial kitchen hoods, paint spray booths or dip tanks that are sealed or locked in the open position.
5. Valves controlling the fuel supply to fire pump engines that are sealed or locked in the open position.
6. Trim valves to pressure switches in dry, preaction and deluge sprinkler systems that are sealed or locked in the open position.

**903.4.1 Signals.** Alarm, supervisory and trouble signals shall be distinctly different and automatically transmitted to an approved central station, remote supervising station or proprietary supervising station as defined in NFPA 72 or, when approved by the commissioner, shall sound an audible signal at a constantly attended location.

**Exceptions:**

1. Underground key or hub valves in roadway boxes provided by the city or a public utility are not required to be monitored.
2. Back flow prevention device test valves, located in limited area sprinkler system supply piping, shall be locked in the open position. In occupancies required to be equipped with a fire alarm system, the back flow preventer valves shall be electrically supervised by a tamper switch installed in accordance with NFPA 72 and separately annunciated.

**903.4.2 Alarms.** Approved audible devices shall be connected to every automatic sprinkler system. Such sprinkler water-flow alarm devices shall be activated by water flow equivalent to the flow of a single sprinkler of the smallest orifice size installed in the system. Alarm devices shall be provided on the exterior of the building in an approved location. Where a fire alarm system is installed, actuation of the automatic sprinkler system shall actuate the building fire alarm system.

**903.4.3 Floor control valves.** Approved supervised indicating control valves shall be provided at the point of connection to the riser on each floor in high-rise buildings.

**903.5 Testing and maintenance.** Sprinkler systems shall be tested and maintained in



accordance with the *New York City Fire Code*.

**SECTION BC 904**  
**ALTERNATIVE AUTOMATIC FIRE-EXTINGUISHING SYSTEMS**

**904.1 General.** Automatic fire-extinguishing systems, other than automatic sprinkler systems, shall be designed, installed, inspected, tested and maintained in accordance with the provisions of this section, the *New York City Fire Code*, and the applicable referenced standards.

**904.1.1 Construction documents.** Construction documents for alternative automatic fire-extinguishing systems shall be approved by the Fire Department and shall contain plans that include at least the following data and information:

1. Commercial kitchen suppression systems:
  - 1.1. Location of all surface, plenum and duct nozzles; surface dimensions and location of all cooking appliances; the location of automatic fuel shut-off and statement as to type (gas or electric); location and distance of the remote control or manual pull station;
  - 1.2. Identification of the grease filters to be used in any kitchen hood; the dimensions of all hoods and all related ducts, including termination of duct at the exterior of the building;
  - 1.3. Identification of: the fire suppression piping system; the make and model of the system; the type of extinguishing agent and number and size of agent containers; size, length, and type of all piping that will be used; the number and location of all fusible links or detectors and the temperature setting; any surface, plenum and duct nozzles.
2. For extinguishing agent systems, the plan should also include type and concentration of the extinguishing agent, the method of providing power supply to smoke or heat detectors, fire rating of partitions, location of all audible/visible alarms within and outside the location involved and the details of construction of the room to contain the extinguishing agent. If the area is not sprinklered, the following information is required:
  - 2.1. The size and location of the reserve supply, and
3. The plans must note whether the proposed system is connected to the building's fire alarm system.

**Exception:** For that portion of a fire suppression piping system within an approved pre-engineered system, a schematic isometric diagram shall be acceptable in lieu of full plans, provided that the location and method of pressure relief must be indicated with areas and volumes to where said relief is taken.

**904.2 Where required.** Automatic fire-extinguishing systems installed as an alternative to the required automatic sprinkler systems of Section 903 shall be approved by the commissioner. Automatic fire-extinguishing systems shall not be considered alternatives for the purposes of exceptions or reductions permitted by other requirements of this code.

**Exception:** Automatic fire-extinguishing systems installed in Group H occupancies as an alternative to the required automatic sprinkler systems of Section 903 shall be approved by the Fire Commissioner.

**904.2.1 Hood system suppression.** Each required commercial kitchen exhaust hood and duct system required by the *New York City Fire Code* or the *New York City Mechanical Code* to have a Type I hood shall be protected with an approved automatic fire-extinguishing system installed in accordance with this code.

**904.3 Installation.** Automatic fire-extinguishing systems shall be installed in accordance with this section.

**904.3.1 Electrical wiring.** Electrical wiring shall be in accordance with the *New York City Electrical Code*.

**904.3.2 Actuation.** Automatic fire-extinguishing systems shall be automatically actuated and provided with a manual means of actuation in accordance with Section 904.11.1.

**904.3.3 System interlocking.** Automatic equipment interlocks with fuel shutoffs, ventilation controls, door closers, window shutters, conveyor openings, smoke and heat vents and other features necessary for proper operation of the fire-extinguishing system shall be provided as required by the design and installation standard utilized for the hazard.

**904.3.4 Alarms and warning signs.** Where alarms are required to indicate the operation of automatic fire-extinguishing systems, distinctive audible and visible alarms and warning signs shall be provided to warn of pending agent discharge. Where exposure to automatic-extinguishing agents poses a hazard to persons and a delay is required to ensure the evacuation of occupants before agent discharge, a separate warning signal shall be provided to alert occupants once agent discharge has begun. Audible signals shall be in accordance with Section 907.9.2.

**904.3.5 Monitoring.** Where a building fire alarm system is installed, automatic fire-extinguishing systems shall be monitored by the building fire alarm system in accordance with NFPA 72.

**904.4 Inspection and testing.** Automatic fire-extinguishing systems shall be inspected and tested in accordance with the provisions of this section prior to acceptance.

**904.4.1 Inspection.** Prior to conducting final acceptance tests, the following items shall be inspected:

1. Hazard specification for consistency with design hazard.
2. Type, location and spacing of automatic- and manual-initiating devices.
3. Size, placement and position of nozzles or discharge orifices.
4. Location and identification of audible and visible alarm devices.
5. Identification of devices with proper designations.
6. Operating instructions.

**904.4.2 Alarm testing.** Notification appliances, connections to fire alarm systems and connections to approved supervising stations shall be tested in accordance with this section and Section 907 to verify proper operation.

**904.4.2.1 Audible and visible signals.** The audibility and visibility of notification appliances signaling agent discharge or system operation, where required, shall be verified.

**904.4.3 Monitor testing.** Connections to protected premises and supervising station fire alarm systems shall be tested to verify proper identification and retransmission of alarms from automatic fire-extinguishing systems.

**904.5 Wet-chemical systems.** Wet-chemical extinguishing systems shall be installed, maintained, periodically inspected and tested in accordance with the *New York City Fire Code*.

**904.6 Dry-chemical systems.** Dry-chemical extinguishing systems shall be installed, maintained, periodically inspected and tested in accordance with the *New York City Fire Code*. New dry-chemical extinguishing systems are not permitted for the protection of kitchen equipment.

**904.7 Foam systems.** Foam-extinguishing systems shall be installed, maintained, periodically inspected and tested in accordance with the *New York City Fire Code*.

**904.8 Carbon dioxide systems.** Carbon dioxide extinguishing systems shall be installed, maintained, periodically inspected and tested in accordance with the *New York City Fire Code*.

**904.9 Halon systems.** Halogenated extinguishing systems shall not be permitted. However, existing systems shall be maintained, periodically inspected and tested in accordance with the *New York City Fire Code*.

**904.10 Clean-agent systems.** Clean-agent fire-extinguishing systems shall be installed, maintained, periodically inspected and tested in accordance with the *New York City Fire Code*.

**904.11 Commercial cooking systems.** The automatic fire-extinguishing system for commercial cooking systems shall be of a type recognized for protection of commercial cooking equipment and exhaust systems of the type and arrangement protected. Pre-engineered automatic wet-chemical extinguishing systems shall be approved by the Fire Commissioner, tested in accordance with UL 300, and listed and labeled for the intended application. The protected area shall include the area under the hood and over the cooking equipment, the area above or behind the filters and the opening of the hood into the branch duct. Where a pre-engineered system is installed and the size of the protected area exceeds that allowed for a single pre-engineered system, additional pre-engineered systems arranged for simultaneous operation shall be provided. Other types of automatic fire-extinguishing systems shall be listed and labeled for specific use as protection for commercial cooking operations. The system shall be installed in accordance with this code, its listing and the manufacturer's installation instructions. Automatic fire-extinguishing systems of the following types shall be installed in accordance with the *New York City Fire Code* and the referenced standard indicated, as shown:

1. Carbon dioxide extinguishing systems, in accordance with the *New York City Fire Code*.
2. Wet-chemical extinguishing systems, in accordance with the *New York City Fire Code*.

**904.11.1 Manual system operation.** A manual actuation device shall be located at or near a means of egress from the cooking areas, a minimum of 10 feet (3048 mm) and a maximum of 20 feet (6096 mm) from the kitchen exhaust system. The manual activation device shall be located at a minimum of 42 inches (1067 mm) and a maximum of 48 inches (1219 mm) above the floor at its center. The manual actuation device shall require a maximum force of 40 pounds (178 N) and a maximum movement of 14 inches (356 mm) to actuate the fire suppression system.

**Exception:** Automatic sprinkler systems shall not be required to be equipped with manual actuation means.

**904.11.2 System interconnection.** The actuation of the fire suppression system shall automatically shut down the fuel or electrical power supply to the cooking equipment. The fuel and electrical supply reset shall be manual.

**904.11.3 Carbon dioxide systems.** When carbon dioxide systems are used, there shall be a nozzle at the top of the ventilating duct. Additional nozzles that are symmetrically arranged to give uniform distribution shall be installed within vertical ducts exceeding 20 feet (6096 mm) and horizontal ducts exceeding 50 feet (15 240 mm). Dampers shall be installed at either the top or the bottom of the duct and shall

be arranged to operate automatically upon activation of the fire-extinguishing system. Where the damper is installed at the top of the duct, the top nozzle shall be immediately below the damper. Automatic carbon dioxide fire-extinguishing systems shall be sufficiently sized to protect against all hazards venting through a common duct simultaneously.

**904.11.3.1 Ventilation system.** Commercial-type cooking equipment protected by an automatic carbon dioxide-extinguishing system shall be arranged to shut off the ventilation system upon activation.

**904.11.4 Special provisions for automatic sprinkler systems.** Automatic sprinkler systems protecting commercial-type cooking equipment shall be supplied from a separate, readily accessible, indicating-type control valve that is identified.

**904.11.4.1 Listed sprinklers.** Sprinklers used for the protection of fryers shall be listed for that application and installed in accordance with their listing.

**904.12 Water-mist systems.** Water-mist fire-extinguishing systems shall be installed, maintained, periodically inspected and tested in accordance with the *New York City Fire Code*.

## **SECTION BC 905** **STANDPIPE SYSTEMS**

**905.1 General.** Standpipe systems shall be provided in buildings and structures in accordance with this section. Fire hose threads used in connection with standpipe systems shall be approved by the Fire Commissioner. The location of Fire Department hose connections shall be approved by the Fire Commissioner. Standpipe systems in buildings used for high-piled combustible storage shall be in accordance with the *New York City Fire Code*. Installation of standpipe systems shall comply with the special inspection requirements of Chapter 17.

Any space or room that contains equipment of such nature that the use of water would be ineffective in fighting a fire therein, or would be otherwise hazardous, shall have a conspicuous sign on each door opening on such space or room stating the nature of the use and the warning: "IN CASE OF FIRE, USE NO WATER".

**905.1.1 Construction documents.** Construction documents for standpipe systems shall contain plans that include at least the following data and information:

1. The locations and sizes of all risers, cross-connections, hose racks, valves, siamese connections, sources of water supply, piping, and other essential features of the system;
2. A floor plan for each group of floors that have typical riser locations and no special features within such group of floor levels, with the indication in title

block of such plan indicating clearly the floors to which the arrangement is applicable;

3. A riser diagram showing the essential features of the system, including the risers, cross-connections, valves, siamese connections, tanks, pumps, sources of water supply, pipe sizes, capacities, floor heights, zone pressures, and other essential data and features of the system; and
4. The available water pressure at the top and bottom floors of each zone, and at each floor where the weight pipe fittings change, shall be shown on the riser diagram.
5. For street pressure-fed systems and fire pumps, a statement from the New York City Department of Environmental Protection, giving the minimum water pressure in the main serving the building.

**905.2 Installation standards.** Standpipe systems shall be installed in accordance with this section and NFPA 14 as modified in Appendix Q.

**905.3 Required installations.** Standpipe systems shall be installed where required by Sections 905.3.1 through 905.3.6 and in the locations indicated in Sections 905.4, 905.5 and 905.6. Standpipe systems are permitted to be combined with automatic sprinkler systems.

**Exception:** Standpipe systems are not required in buildings occupied entirely by Group R-3.

**905.3.1 Applicability.** Class III standpipe systems shall be installed throughout the following buildings:

1. In buildings 2 stories or more in height with floor area of 10,000 square feet (929 m<sup>2</sup>) or greater on any story;
2. In buildings 3 stories or more in height with floor area of 7,500 square feet (697 m<sup>2</sup>) or greater on any story;
3. In buildings of any area with a floor level having an occupant load of 30 or more that is located 55 feet (16 764 mm) or more above the lowest level of fire department vehicle access.
4. In buildings of any area, constructed in accordance with Section 403, with occupied floors located 75 feet (22 860 mm) or more above the lowest level of fire department vehicle access.

**Exceptions:**

1. Class I standpipes are allowed in buildings equipped throughout with an automatic sprinkler system in accordance with Section 903.3.1.1 or 903.3.1.2 provided that the following additional requirements are met:
  - 1.1. A locked storage cabinet shall be provided on the main entrance floor in a location approved by the Fire Commissioner near the standpipe riser enclosure. Such cabinet shall contain at least three open nozzles, two 1.5 inch (38 mm) spanner wrenches, two 2.5 inch (64 mm) spanner wrenches, two 2.5 inch (64 mm) by 1.5 inch (38 mm) non-swivel reducing couplings, and 375 feet (114 m) of 1.5 inch (38 mm) hose. However, the hose may be omitted when serving Group R-2 occupancies.
    - 1.1.1. A key for unlocking the storage cabinet shall be kept in a location where it is readily available to authorized persons, but not available to the general public. A sign shall be placed on the storage cabinet indicating the location of such key.
    - 1.1.2. An additional labeled key shall be kept in a locked receptacle near the storage cabinet openable by a Fire Department standard key. Such receptacle shall be labeled, "FOR FIRE DEPARTMENT USE ONLY."
    - 1.1.3. A metal sign shall be placed in each stair enclosure on the main entrance floor stating clearly where the storage cabinet is located.
  - 1.2. Hose valves are capped with a hose valve cap fastened to the valve with a chain.
2. Class I manual standpipes are allowed in open parking garages where the highest floor is located not more than 150 feet (45 720 mm) above the lowest level of fire department vehicle access.
3. Class I manual dry standpipes are allowed in open parking garages that are subject to freezing temperatures, provided that the hose connections are located as required for Class II standpipes in accordance with Section 905.5.
4. Class I standpipes are allowed in below-grade stories equipped throughout with an automatic sprinkler system.
5. Standpipe outlets may be omitted in portions of first floors or basements that are completely separated from the entrance hall or enclosed stairways leading to the upper floors, provided that portable

fire extinguishers are installed, subject to the approval of the Fire Commissioner.

**905.3.2 Group A.** Class I automatic wet standpipes shall be provided in nonsprinklered Group A buildings having an occupant load exceeding 1,000 persons.

**Exceptions:**

1. Open-air-seating spaces without enclosed spaces.
2. Class I automatic dry and semiautomatic dry standpipes or manual wet standpipes are allowed in buildings where the highest floor surface used for human occupancy is 75 feet (22 860 mm) or less above the lowest level of fire department vehicle access. Dry standpipes are permitted only where subject to freezing temperatures.

**905.3.3 Covered mall buildings.** Covered mall buildings and buildings connected thereto shall be equipped throughout with a Class I automatic wet standpipe system, except as permitted by Section 905.3.3.1 through 905.3.3.3.

**905.3.3.1 Covered mall building height.** Covered mall buildings where the highest occupied floor level is located not more than 30 feet (9144 mm) above the lowest level of the fire department vehicle access shall be permitted to be provided with Class I hose connections connected to the mall sprinkler system in accordance with NFPA 13 Section 8.16.5.2 regarding Hose Connections for Fire Department Use and under the following conditions:

1. Any individual outlet shall be capable of delivering water flow at a rate of 250 gallons per minute (946 L/m) while concurrently supplying the mall sprinkler demand; and
2. Each of the two most hydraulically remote outlets shall be capable of concurrently delivering 250 gallons per minute (946 L/m) at a pressure of 100 pounds per square inch (689.4 kPa) with no mall sprinkler demand, based on a supply pressure at the system Fire Department connection of not more than 175 pounds per square inch (1207 kPa). Adequacy of the water supply available to the Fire Department to meet the hydraulic calculations shall be demonstrated by the registered design professional.

**905.3.3.2 Location of hose connections.** Hose connections shall be provided in accordance with Section 905.4 and at each of the following locations:

1. Within the mall at the entrance to each exit passageway or exit.
2. At each floor-level landing within enclosed stairways opening directly on the mall.



3. At exterior public entrances to the mall.

**905.3.3.3 Installation standard.** Except as provided in Sections 905.3.3.1 and 905.3.3.2, the Class I hose connections and Fire Department connections shall be designed in conformance with NFPA 14.

**905.3.4 Stages.** Stages greater than 1,000 square feet in area (93 m<sup>2</sup>) shall be equipped with a Class III wet standpipe system with 1.5-inch and 2.5-inch (38 mm and 64 mm) hose connections on each side of the stage.

**Exception:** Where the building or area is equipped throughout with an automatic sprinkler system, the hose connections are allowed to be supplied from the automatic sprinkler system in accordance with NFPA 13 Section 8.16.5.2 and shall have a flow rate of not less than that required by NFPA 14 for Class III standpipes.

**905.3.4.1 Hose and cabinet.** The 1.5-inch (38 mm) hose connections shall be equipped with sufficient lengths of 1.5-inch (38 mm) hose to provide fire protection for the stage area. Hose connections shall be equipped with an approved adjustable fog nozzle and be mounted in a cabinet or on a rack.

**905.3.5 Underground buildings.** Underground buildings shall be equipped throughout with a Class I automatic wet or manual wet standpipe system.

**905.3.6 Helistops and heliports.** Buildings with a helistop or heliport that are equipped with a standpipe shall extend the standpipe to the roof level on which the helistop or heliport is located in accordance with the *New York City Fire Code*. All portions of the helistop and heliport area shall be within 150 feet (45 720 mm) of a 2.5 inch (64 mm) outlet on a Class I or III standpipe, in accordance with the *New York City Fire Code*.

**905.4 Location of Class I standpipe hose connections.** Class I standpipe hose connections shall be provided in all of the following locations:

1. In every required stairway, a hose connection shall be provided for each floor level above or below grade. Hose connections shall be readily accessible and located at the riser on each floor level landing and on the entrance floor above the standpipe riser control valve. Non-required enclosed stairways are not required to have hose connections. Stairways without hose connections shall have a sign on the door to the stairway stating, "No standpipe connections in stairway".
2. On each side of the wall adjacent to the exit opening of a horizontal exit.
3. In every exit passageway at the entrance from the exit passageway to the other areas of a building.

4. In covered mall buildings, in accordance with Section 905.3.3.2.
5. Where the roof has a slope of less than four units vertical in 12 units horizontal (33.3-percent slope), each standpipe shall be provided with a hose connection located either on the roof or at the highest landing of stairways with stair access to the roof. An additional hose connection shall be provided at the top of the most hydraulically remote standpipe for testing purposes.
6. Where the most remote portion of a floor or story is more than 150 feet (45 720 mm) from a hose connection, additional hose connections shall be provided in approved locations. For the purposes of this section, a penthouse with an occupant load greater than 10 shall be considered a story.

**905.4.1 Protection.** Risers and laterals of Class I standpipe systems not located within an enclosed stairway or pressurized enclosure shall be protected by a degree of fire resistance equal to that required for vertical enclosures in the building in which they are located. No standpipe riser shall be placed in any shaft containing a gas or fuel pipeline.

**Exception:** In buildings equipped throughout with an approved automatic sprinkler system, laterals that are not located within an enclosed stairway or pressurized enclosure are not required to be enclosed in fire-resistance-rated construction.

**905.4.2 Interconnection.** In buildings where more than one standpipe is provided, the standpipes shall be interconnected in accordance with NFPA 14.

**905.5 Location of Class II standpipe hose connections.** Class II standpipe hose connections shall be accessible and located so that all portions of the building are within 30 feet (9144 mm) of a nozzle attached to 100 feet (30 480 mm) of hose.

**905.5.1 Groups A-1 and A-2.** In Group A-1 and A-2 occupancies with occupant loads of more than 1,000, hose connections shall be located on each side of any stage.

**905.5.2 Protection.** Fire-resistance-rated protection of risers and laterals of Class II standpipe systems is not required.

**905.6 Location of Class III standpipe hose connections.** Class III standpipe systems shall have hose connections located as required for Class I standpipes in Section 905.4 and shall have Class II hose connections as required in Section 905.5.

**905.6.1 Protection.** Risers and laterals of Class III standpipe systems shall be protected as required for Class I systems in accordance with Section 905.4.1.

**905.6.2 Interconnection.** In buildings where more than one standpipe is provided,

the standpipes shall be interconnected in accordance with NFPA 14.

**905.7 Cabinets.** Cabinets containing fire-fighting equipment such as standpipes, fire hoses, fire extinguishers or Fire Department valves shall not be blocked from use or obscured from view.

**905.7.1 Cabinet equipment identification.** Cabinets shall be identified in an approved manner by a permanently attached sign with white letters not less than 2 inches (51 mm) high and a red background color, indicating the equipment contained therein.

**Exception:** Doors that have either an approved visual identification clear glass panel or a complete glass door panel are not required to be marked.

**905.7.2 Locking cabinet doors.** Cabinets shall be unlocked.

**Exceptions:**

1. Visual identification panels of glass or other approved transparent frangible material that is easily broken and allows access.
2. Approved locking arrangements.
3. Locking of cabinets shall be permitted in Group I-3.

**905.8 Dry standpipes.** Dry standpipes shall not be installed.

**Exception:** Where subject to freezing and in accordance with NFPA 14.

**905.9 Valve supervision.** Valves controlling water supplies shall be supervised in the open position so that a change in the normal position of the valve will generate a supervisory signal at the supervising station required by Section 903.4. Where a fire alarm system is provided, a signal shall also be transmitted to the control unit.

**Exceptions:**

1. Valves to underground key or hub valves in roadway boxes provided by the city or a public utility do not require supervision.
2. Valves locked in the normal position and inspected as provided in this code in buildings not equipped with a fire alarm system.

**905.10 During construction.** Standpipe systems required during construction, alteration and demolition operations shall be provided in accordance with Section 3303.8.

**SECTION BC 906**

## **PORTABLE FIRE EXTINGUISHERS**

**906.1 General.** Portable fire extinguishers shall be provided in occupancies and locations as required by the *New York City Fire Code*.

## **SECTION BC 907** **FIRE ALARM AND DETECTION SYSTEMS**

**907.1 General.** This section covers the application, installation, performance and maintenance of fire alarm systems and their components. Systems shall be designed and installed in accordance with NFPA 72 as modified in Appendix Q and the *New York City Electrical Code*.

**907.1.1 Construction documents.** Construction documents for fire alarm systems shall be submitted for review and approval to the department and the Fire Department prior to system installation. Construction documents shall include, but not be limited to, all of the following:

1. A floor plan that indicates the use of all rooms.
2. Locations of alarm-initiating and notification appliances.
3. Alarm control and trouble signaling equipment.
4. Annunciation.
5. Power connection.
6. Fire alarm riser diagram and all fire alarm devices indicated on the floor plans. Quantities of devices on the floor plans shall match the quantities indicated on the riser diagram.
7. Copies of any variances granted by the department or the Fire Department.
8. Legend of all fire alarm symbols and abbreviations used.
9. Design criteria for fire alarm audibility in various occupancies indicated on plans.
10. Fire alarm sequence of operation for the fire alarm control panel and the central station transmitter.
11. The interface of fire safety control functions

**907.1.2 Equipment.** Systems and their components shall be listed for the purpose for which they are installed.

**907.2 Where required.** An approved manual, automatic or manual and automatic fire alarm system shall be provided in accordance with Sections 907.2.1 through 907.2.21. Where automatic sprinkler protection, installed in accordance with Section 903.3.1.1 or 903.3.1.2, is provided and connected to the building fire alarm system, automatic heat detection required by this section shall not be required. An approved automatic fire detection system shall be installed in accordance with the provisions of this code, the *New York City Mechanical Code*, and NFPA 72. Devices, combinations of devices, appliances and equipment shall comply with Section 907.1.2. The automatic fire detectors shall be smoke detectors, except that an approved alternative type of detector shall be installed in spaces such as boiler rooms where, during normal operation, products of combustion are present in sufficient quantity to actuate a smoke detector. All initiating devices related to fire or life safety, other than smoke alarms, shall be connected to the fire alarm system.

In all occupancies where an automatic fire alarm system is required by this section, selective coverage smoke detectors shall be located as follows, unless partial or total coverage automatic detection is specified.

1. In each mechanical equipment, electrical, transformer, telephone equipment or similar room, in elevator machine rooms, and in elevator lobbies.
2. In air distribution systems in accordance with Section 606 of the *New York City Mechanical Code*.

**907.2.1 Group A.** A manual and automatic fire alarm system shall be installed in accordance with NFPA 72 in Group A occupancies having an occupant load of 300 or more. Portions of Group E occupancies occupied for assembly purposes shall be provided with a fire alarm system as required for the Group E occupancy.

**Exceptions:**

1. Manual fire alarm boxes are not required where the building is equipped throughout with an automatic sprinkler system and the notification appliances will activate upon sprinkler water flow.
2. A manual fire alarm system shall be installed in spaces meeting the definition for cabaret having an occupant load of 75 or more, including associated stages, dressing rooms, and property rooms.

**907.2.1.1 System initiation in Group A occupancies.** Activation of the fire alarm in Group A-1 occupancies with an occupant load of 300 or more, and in all other Group A occupancies with an occupant load of 1,000 or more, shall initiate a presignal system at a constantly attended location from which the Fire Department shall be notified and live voice evacuation instructions shall be initiated using an emergency voice/alarm communications system in accordance

with NFPA 72.

**907.2.1.2 Emergency power.** Emergency voice/alarm communications systems where required by Section 907.2.1.1 shall be provided with an approved emergency power source and shall be designed and installed in accordance with NFPA 72 and the *New York City Electrical Code*.

**907.2.2 Group B.** A manual and automatic fire alarm system shall be installed in Group B occupancies having an occupant load of 500 or more persons or more than 100 persons above or below the lowest level of exit discharge. Where such occupancies are not protected by an automatic sprinkler system, a manual fire alarm and partial coverage automatic smoke detection or automatic heat detection system shall be installed in accordance with NFPA 72.

**907.2.2.1 High-Rise and large area buildings.** In high-rise buildings constructed in accordance with Section 403, Group B occupied floors located more than 75 feet (22 860 mm) above the lowest level of fire department vehicle access or having a total gross area exceeding 100,000 square feet (9290 m<sup>2</sup>) shall comply with the requirements of Section 907.2.12.

**907.2.3 Group E.** A manual and automatic fire alarm system shall be installed in Group E occupancies. When automatic sprinkler systems or smoke detectors are installed, such systems or detectors shall be connected to the building fire alarm system.

**907.2.4 Group F.** A manual and automatic fire alarm system shall be installed in Group F occupancies that are two or more stories in height and have an occupant load of 100 or more, or when 25 persons or more are above or below the lowest level of exit discharge.

**907.2.5 Group H.** A manual and automatic fire alarm system shall be installed in Group H-5 occupancies and in occupancies used for the manufacture of organic coatings. In addition to the automatic fire alarm system requirements of Section 907.2, an automatic smoke detection system shall be installed for highly toxic gases, organic peroxides and oxidizers in accordance with the *New York City Fire Code*, and shall be connected to a central station.

**Exceptions:** A smoke detection system shall not be required in detached storage buildings equipped throughout with an approved automatic fire-extinguishing system and used only to store the following:

1. Organic peroxides.
2. Liquid or solid oxidizers.

**907.2.6 Group I.** A manual and automatic fire alarm system and an automatic fire

detection system shall be installed in Group I occupancies. An electrically supervised, automatic smoke detection system shall be provided in waiting areas that are open to corridors.

**907.2.6.1 Group I-2.** Corridors in nursing homes (both intermediate-care and skilled nursing facilities), detoxification facilities and spaces open to the corridors shall be equipped with an automatic fire detection system.

**907.2.6.2 Group I-3.** Group I-3 occupancies shall be equipped with a manual and automatic fire alarm system installed for alerting staff.

**907.2.6.2.1 System initiation.** Actuation of an automatic fire-extinguishing system, a manual fire alarm box or a fire detector shall initiate an approved alarm signal that automatically notifies staff. Presignal systems shall not be used.

**907.2.6.2.2 Manual fire alarm boxes.** Manual fire alarm boxes are not required to be located in accordance with Section 907.3 where the fire alarm boxes are provided at staff-attended locations having direct supervision over areas where manual fire alarm boxes have been omitted. Manual fire alarm boxes shall be permitted to be locked in areas occupied by detainees, provided that staff members are present within the subject area and have keys readily available to operate the manual fire alarm boxes.

**907.2.6.2.3 Smoke detectors.** An approved automatic smoke detection system shall be installed throughout resident housing areas, including sleeping areas and contiguous day rooms, group activity spaces and other common spaces normally accessible to residents.

**Exceptions:**

1. Other approved smoke detection arrangements providing equivalent protection including, but not limited to, placing detectors in exhaust ducts from cells or behind protective guards listed for the purpose are allowed when necessary to prevent damage or tampering.
2. Sleeping units in Use Conditions 2 and 3.
3. Smoke detectors are not required in sleeping units with four or fewer occupants in smoke compartments that are equipped throughout with an approved automatic sprinkler system.

**907.2.7 Group M.** A manual and automatic fire alarm system shall be installed in Group M occupancies where any one of the following conditions exists:

1. Where a Group M fire area exceeds 12,000 square feet (1115 m<sup>2</sup>);
2. Where a Group M fire area is located more than three stories above grade;
3. Where the combined area of all Group M fire areas on all floors, including mezzanines, exceeds 24,000 square feet (2230 m<sup>2</sup>); or
4. Where a Group M fire area in a below-grade story exceeds 1,500 square feet (139 m<sup>2</sup>).

Where such occupancies are not protected by an automatic sprinkler system, a manual fire alarm and partial coverage automatic smoke detection or automatic heat detection system shall be installed in accordance with NFPA 72.

**907.2.8 Group R-1.** Fire alarm systems shall be installed in Group R-1 occupancies as required in Sections 907.2.8.1 through 907.2.8.3.

**907.2.8.1 Manual fire alarm system.** A manual fire alarm system shall be installed in Group R-1 occupancies.

**Exception:** A manual fire alarm system is not required in buildings not over two stories in height where all individual dwelling units and contiguous attic and crawl spaces are separated from each other and public or common areas by at least 1-hour fire partitions and each individual dwelling unit has an exit directly to a public way, exit court or yard.

**907.2.8.2 Automatic fire alarm system.** An automatic fire alarm system shall be installed in Group R-1 occupancies. In addition to the automatic fire alarm system requirements of Section 907.2, smoke detectors shall be installed in all public corridors serving dwelling units and in accordance with Section 907.2.8.3.

**Exception:** An automatic fire detection system is not required in buildings that do not have public corridors serving dwelling units and each dwelling unit has a means of egress door opening directly to an exterior exit access that leads directly to an exit.

**907.2.8.3 Smoke detectors within dwelling units.** Smoke detectors and audible notification appliances shall be installed in dwelling units and shall be annunciated by dwelling unit at a constantly attended location from which the fire alarm system is capable of being manually activated. Smoke detectors are required in the following areas:

1. In sleeping areas.
2. In every room in the path of the means of egress from the sleeping area to the door leading from the dwelling unit.



3. In each story within the unit, including below-grade stories. For dwelling units with split levels and without an intervening door between the adjacent levels, a smoke alarm installed on the upper level shall suffice for the adjacent lower level.

**907.2.9 Group R-2.** An automatic fire alarm system without alarm notification appliances shall be provided in accordance with this section in Group R-2 occupancies, other than student apartments, where such occupancy satisfies any one of the following conditions:

1. Any dwelling unit is located three or more stories above the lowest level of exit discharge, including dwelling units in penthouses of any area;
2. Any dwelling unit is located more than one story below the highest level of exit discharge of exits serving the dwelling unit; or
3. The building contains more than 16 dwelling units.
4. The building contains a mechanical equipment, electrical, transformer telephone equipment or similar room greater than 75 square feet (6.97 m<sup>2</sup>) in area.

Actuation of smoke detectors shall not initiate a signal to alarm notification appliances. The activation of any detector required by this section shall initiate a signal at a central station or a constantly attended location. Smoke detectors shall be located as follows:

1. In each mechanical equipment, electrical, transformer, telephone equipment or similar room, in elevator machine rooms, and in elevator lobbies.
2. In air distribution systems in accordance with Section 606 of the *New York City Mechanical Code*.

**907.2.9.1 Group R-2 student apartments.** Where the main use or dominant occupancy of a building is classified as R-2 student apartments, as defined in Section 310.2, fire alarm systems shall be installed in accordance with Section 907.2.8. Where the main use or dominant occupancy of a building is not classified as R-2 student apartments and the building is occupied partially by Group R-2 student apartments, fire alarm systems shall be installed in accordance with Sections 907.2.9.1.1 through 907.2.9.1.3.

**907.2.9.1.1 Manual fire alarm system.** A manual fire alarm system shall be installed throughout all public corridors serving student apartments and student related uses. Student related uses shall include common spaces such as recreation rooms, lounges, dining rooms, laundry rooms, and storage

rooms.

**Exceptions:**

1. A manual fire alarm system is not required in buildings not over two stories in height where all individual dwelling units and contiguous attic and crawl spaces are separated from each other and public or common areas by at least 1-hour fire partitions and each individual dwelling unit has an exit directly to a public way, exit court or yard.
2. A manual fire alarm system is not required in buildings containing fewer than 15 student apartments.

**907.2.9.1.2 Automatic fire alarm system.** An automatic fire alarm system shall be installed in accordance with Section 907.2.12.1 and throughout all public corridors serving student apartments and student related uses. Student related uses shall include common spaces such as recreation rooms, lounges, dining rooms, laundry rooms, and storage rooms.

**Exceptions:**

1. An automatic fire alarm system is not required in buildings not over two stories in height where all individual dwelling units and contiguous attic and crawl spaces are separated from each other and public or common areas by at least 1-hour fire barriers and each individual dwelling unit has an exit directly to a public way, exit court or yard.
2. An automatic fire alarm system is not required in buildings containing fewer than 15 student apartments.

**907.2.9.1.3 Smoke alarms.** Smoke alarms shall be installed as required by Section 907.2.10.

**907.2.10 Single- and multiple-station smoke alarms.** Listed single- and multiple-station smoke alarms shall be installed in accordance with the provisions of this code and the household fire-warning equipment provisions of NFPA72.

**907.2.10.1 Where required.** Single- or multiple-station smoke alarms shall be installed in the locations described in Sections 907.2.10.1.1.

**907.2.10.1.1 Smoke alarms in Groups R-2, R-3, and I-1.** Single- or multiple-station smoke alarms shall be installed and maintained in Groups R-2, R-3, and I-1, regardless of occupant load at all of the following locations within a dwelling unit:

1. On the ceiling or wall outside of each room used for sleeping purposes within 15 feet (4572 mm) from the door to such room.
2. In each room used for sleeping purposes.
3. In each story within a dwelling unit, including below-grade stories and penthouses of any area, but not including crawl spaces and uninhabitable attics. In dwellings or dwelling units with split levels and without an intervening door between the adjacent levels, a smoke alarm installed on the upper level shall suffice for the adjacent lower level provided that the lower level is less than one full story below the upper level.

**907.2.10.2 Power source.** Required smoke alarms shall receive their primary power from a dedicated branch circuit or the unswitched portion of a branch circuit also used for power and lighting, and shall be equipped with a battery backup. Smoke alarms shall emit a signal when the batteries are low. Wiring shall be permanent and without a disconnecting switch other than as required for over-current protection.

**907.2.10.3 Interconnection.** Where more than one smoke alarm or detector is required to be installed within an individual dwelling unit in Group R-2, R-3, or within an individual dwelling unit or sleeping unit in Group R-1, the smoke alarms or detectors shall be interconnected in such a manner that the activation of one alarm or detector will activate all of the alarms or detectors in the individual unit. The alarm or detector shall be clearly audible in all bedrooms over background noise levels with all intervening doors closed.

**907.2.10.4 Acceptance testing.** When the installation of the alarm devices is complete, each detector and interconnecting wiring for multiple-station alarm devices shall be tested in accordance with the household fire warning equipment provisions of NFPA 72.

**907.2.11 Special amusement buildings.** An approved automatic smoke detection system shall be provided in special amusement buildings in accordance with this section.

**Exception:** In areas where ambient conditions will cause a smoke detection system to alarm, an approved alternative type of automatic detector shall be installed.

**907.2.11.1 Alarm.** Activation of any single smoke detector, the automatic sprinkler system or any other automatic fire detection device shall immediately sound an alarm at the building at a constantly attended location from which emergency action can be initiated, including the capability of manual initiation of

requirements in Section 907.2.11.2.

**907.2.11.2 System response.** The following minimum system actuations and responses shall be required upon approval by the department and the Fire Department. The activation of two or more smoke detectors, a single smoke detector with alarm verification, the automatic sprinkler system or other approved fire detection device shall automatically:

1. Cause illumination of the means of egress with light of not less than 1 foot-candle (11 lux) at the walking surface level;
2. Stop any conflicting or confusing sounds and visual distractions; and
3. Activate an approved directional exit marking that will become apparent in an emergency. Such system response shall also include activation of a prerecorded message, clearly audible throughout the special amusement building, instructing patrons to proceed to the nearest exit. Alarm signals used in conjunction with the prerecorded message shall produce a sound that is distinctive from other sounds used during normal operation. The wiring to the auxiliary devices and equipment used to accomplish the above fire safety functions shall be monitored for integrity in accordance with NFPA 72.

**907.2.11.3 Emergency voice/alarm communication system.** An emergency voice/alarm communication system, which is also allowed to serve as a public address system, shall be installed in accordance with NFPA 72, and shall be audible throughout the entire special amusement building.

**907.2.12 High-rise buildings.** Buildings constructed in accordance with Section 403 and having floors used for human occupancy located more than 75 feet (22 860 mm) above the lowest level of fire department vehicle access shall be provided with automatic fire detection connected to an automatic fire alarm system in accordance with Section 907.2.12.1 and an emergency voice/alarm communication system in accordance with Section 907.2.12.2.

**Exceptions:**

1. Open parking garages in accordance with Section 406.3.
2. Buildings with an occupancy in Group A-5.
3. Low-hazard special occupancies in accordance with Section 503.1.2.
4. Buildings with an occupancy in Group H-1, H-2 or H-3 in accordance with Section 415.

**907.2.12.1 Automatic fire detection.** In addition to smoke detection otherwise required by this code, smoke detectors shall be provided in accordance with this section. Smoke detectors shall be connected to an automatic fire alarm system. The activation of any detector required by this section shall operate the emergency voice/alarm communication system. Smoke detectors shall be located as follows:

1. In each mechanical equipment, electrical, transformer, telephone equipment or similar room, in elevator machine rooms and in elevator lobbies.
2. In air distribution systems in accordance with Section 606 of the *New York City Mechanical Code*.
3. In Group R-1 occupancies a listed smoke detector is allowed to be used in each return air riser carrying not more than 5,000 cfm (2.4m<sup>3</sup>/s) and serving not more than 10 air inlet openings.

**Exception for Group R-2 occupancies:** In R-2 occupancies, the activation of smoke detectors shall initiate a signal at a central station or a constantly attended location and shall not initiate a signal to an alarm notification appliance.

**907.2.12.2 Emergency voice/alarm communication system.** The operation of any automatic fire detector, sprinkler water-flow device or manual fire alarm box shall automatically sound an alarm tone followed by live voice instructions giving approved information and directions on a general or selective basis to the following areas on a minimum of the alarming floor, the floor above and the floor below in accordance with the *New York City Fire Code*.

1. Elevator lobbies.
2. Corridors.
3. Rooms and tenant spaces exceeding 1,000 square feet (93 m<sup>2</sup>) in area.
4. Sleeping units in Group R-1 occupancies.
5. Areas of rescue assistance as defined in Section 1002.

**Exceptions:**

1. Group I-1 and I-2 occupancies. In Group I-1 and I-2 occupancies, the alarm shall sound in a constantly attended area and a general occupant notification shall be broadcast over the overhead page.

2. Group R-2 occupancies 125 feet or less in height. Emergency voice/alarm communication systems shall not be required in Group R-2 occupancies in buildings 125 feet (33 100 mm) or less in height.
3. Group R-2 occupancies greater than 125 feet in height. In Group R-2 occupied buildings greater than 125 feet (33 100 mm) in height, activation of any smoke detector or sprinkler water flow device shall initiate a signal at a central station or constantly attended location and shall not initiate a signal to an alarm notification appliance. An emergency voice/alarm communication system shall not be required. However, a one-way voice communication shall be provided between the fire command center for use by Fire Department personnel and the following terminal areas:
  - 3.1. Within dwelling units. An intercom system may be utilized when provided with an override feature for use by Fire Department personnel.
  - 3.2. Within required exit stairs. Annunciation devices shall be located at least on every other story.

**907.2.12.2.1 Manual override.** A manual override for emergency voice communication shall be provided for all paging zones with all-call capability and feature.

**907.2.12.2.2 Live voice messages.** The emergency voice/alarm communication system shall have multi-channel capability to allow live voice messages via independent audio channels to the stairs, to all or selected floors without automatic interruption of the alarm tones on the floor of incidence, floor above or floor below.

**907.2.12.2.3 Standard.** The emergency voice/alarm communication system shall be designed and installed in accordance with NFPA 72 as modified in Appendix Q.

**907.2.12.3 Fire Department communication system.** An approved two-way, fire department communication system designed and installed in accordance with NFPA 72 shall be provided for Fire Department use. It shall operate between a fire command center complying with Section 911 and elevators, elevator lobbies, emergency power rooms, fire pump rooms, areas of refuge and inside enclosed exit stairways. The Fire Department communication device shall be provided at each floor level within each enclosed stairway.

**Exceptions:**

1. Fire Department radio systems where approved by the Fire

Department may be installed in lieu of a two-way fire department communication system.

## 2. Buildings in Group R-2

**907.2.13 Atriums connecting more than two stories.** A fire alarm system shall be installed in occupancies with an atrium that connects more than two stories. The system shall be activated in accordance with Section 907.7. Such occupancies in Group A, E or M shall be provided with an emergency voice/alarm communication system complying with the requirements of Section 907.2.12.2.

**907.2.14 High-piled combustible storage areas.** An automatic fire detection system shall be installed throughout high-piled combustible storage areas where required by the *New York City Fire Code*.

**907.2.15 Delayed egress locks.** Where delayed egress locks are installed on means of egress doors in accordance with Section 1008.1.8.6, an automatic smoke or heat detection system shall be installed as required by that section.

**907.2.16 Aerosol storage uses.** Aerosol storage rooms and general-purpose warehouses containing aerosols shall be provided with an approved manual fire alarm system where required by the *New York City Fire Code*.

**907.2.17 Lumber, plywood and veneer mills.** Lumber, plywood and veneer mills shall be provided with a manual fire alarm system.

**907.2.18 Underground buildings with smoke exhaust system.** Where a smoke exhaust system is installed in an underground building as required by Section 405, automatic fire detectors shall be provided in accordance with this section.

**907.2.18.1 Smoke detectors.** A minimum of one smoke detector listed for the intended purpose shall be installed in the following areas:

1. Mechanical equipment, electrical, transformer, telephone equipment, elevator machine or similar rooms.
2. Elevator lobbies.
3. The main supply and return and exhaust air plenum of each air-conditioning system serving more than one story and located in a serviceable area downstream from filters on supply ducts and in return/exhaust ducts downstream of the last duct inlet.
4. Each connection to a vertical duct or riser serving two or more floors from return air ducts or plenums of heating, ventilating and air-conditioning systems, except that in Group R occupancies, a listed smoke detector is

allowed to be used in each return air riser carrying not more than 5,000 cfm (2.4 m<sup>3</sup>/s) and serving not more than 10 air inlet openings.

**907.2.18.2 Alarm required.** Activation of the smoke exhaust system shall activate an audible alarm at a constantly attended location.

**907.2.19 Underground buildings.** In underground buildings complying with Section 405 where the lowest level of a structure is more than 30 feet (18 144 mm) below the lowest level of exit discharge, the structure shall be equipped throughout with a manual and automatic fire alarm system, including an emergency voice/alarm communication system installed in accordance with Section 907.2.12.2.

**907.2.19.1 Public address system.** In underground buildings complying with Section 405 where a fire alarm system is not required by Section 907.2, a public address system shall be provided that shall be capable of transmitting voice communications to the highest level of exit discharge serving the underground portions of the structure and all levels below.

**907.2.20 Covered mall buildings.** Covered mall buildings exceeding 50,000 square feet (4645 m<sup>2</sup>) in total floor area shall be provided with an emergency voice/alarm communication system. An emergency voice/alarm communication system serving a mall, required or otherwise, shall be accessible to the Fire Department. The system shall be provided in accordance with Section 907.2.12.2.

**907.2.20.1 Battery rooms.** An approved automatic smoke detection system shall be installed in areas containing stationary lead-acid battery systems having a liquid capacity of more than 50 gallons (189.3 L). The detection system shall be supervised by an approved central, proprietary or remote station service or a local alarm that will sound an audible signal at a constantly attended location.

**907.3 Manual fire alarm boxes.** Manual fire alarm boxes shall be installed in accordance with Sections 907.3.1 through 907.3.5.

**907.3.1 Location.** Manual fire alarm boxes shall be located not more than 5 feet (1524 mm) from the entrance to each exit. Additional manual fire alarm boxes shall be located so that travel distance to the nearest box does not exceed 200 feet (60 960 mm).

**907.3.2 Height.** The height of the manual fire alarm boxes shall be a minimum of 42 inches (1067 mm) and a maximum of 48 inches (1219 mm), measured vertically, from the floor level to the activating handle or lever of the box.

**907.3.3 Color.** Manual fire alarm boxes shall be red in color.

**907.3.4 Signs.** Where fire alarm systems are not monitored by a supervising station, an approved permanent sign that reads: WHEN ALARM SOUNDS—CALL FIRE



DEPARTMENT shall be installed adjacent to each manual fire alarm box.

**Exception:** Where the manufacturer has permanently provided this information on the manual fire alarm box.

**907.3.5 Protective covers.** The Fire Department is authorized to require the installation of listed manual fire alarm box protective covers to prevent malicious false alarms or provide the manual fire alarm box with protection from physical damage. The protective cover shall be transparent or red in color with a transparent face to permit visibility of the manual fire alarm box. Each cover shall include proper operating instructions. A protective cover that emits a local alarm signal shall not be installed unless approved.

**907.4 Power supply.** The primary and secondary power supplies for the fire alarm system shall be provided in accordance with NFPA 72.

**907.5 Wiring.** Wiring shall comply with the requirements of the *New York City Electrical Code* and NFPA 72. Wireless protection systems utilizing radio-frequency transmitting devices shall comply with the special requirements for supervision of low-power wireless systems in NFPA 72.

**907.6 Activation.** Where an alarm notification system is required by another section of this code, it shall be activated by:

1. A required automatic fire alarm system.
2. Sprinkler water-flow devices.
3. Required manual fire alarm boxes.
4. Other required types of automatic fire detection devices or suppression systems.

**907.7 Presignal system.** Presignal systems shall not be installed unless approved by the Fire Department. Where a presignal system is installed, 24-hour personnel supervision shall be provided at a location approved by the Fire Department. Where a connection to a supervising station is required, the transmission of the alarm signal to the supervising station shall activate upon the initial alarm signal.

**907.8 Zones.** Each floor shall be zoned separately and a zone shall not exceed 22,500 square feet (2090 m<sup>2</sup>). The length of any zone shall not exceed 300 feet (91 440 mm) in any direction.

**Exception:** Automatic sprinkler system zones shall not exceed the area permitted by NFPA 13.

**907.8.1 Zoning indicator panel.** A zoning indicator panel and the associated controls

shall be provided at the main building entrance accessible to responding Fire Department personnel and in other locations approved by the department and the Fire Department. The visual zone indication shall lock in until the system is reset and shall not be canceled by the operation of an audible alarm-silencing switch.

**907.8.2 High-rise buildings.** In high-rise buildings constructed in accordance with Section 403 and used for human occupancy that have occupied floors located more than 75 feet (22 860 mm) above the lowest level of fire department vehicle access, a separate zone by floor shall be provided for all of the following types of alarm-initiating devices where provided:

1. Smoke detectors.
2. Sprinkler water-flow devices.
3. Manual fire alarm boxes.
4. Other approved types of automatic fire detection devices or suppression systems.

**907.9 Alarm notification appliances.** Alarm notification appliances listed for their purpose shall be provided.

**907.9.1 Visible alarms.** Visible alarm notification appliances shall be provided in accordance with Sections 907.9.1.1 through 907.9.1.3.

**Exception:** Visible alarm notification appliances shall not be required in exits.

**907.9.1.1 Public and common areas.** Visible alarm notification appliances shall be provided in public areas and common areas.

**907.9.1.2 Employee work areas.** Where employee work areas have audible alarm coverage, the wiring systems shall be designed so that visible alarm notification appliances can be integrated into the alarm system.

**907.9.1.3 Groups I-1 and R-1.** Group I-1 and R-1 dwelling units in accordance with Table 907.9.1.3 shall be provided with a visible alarm notification appliance, activated by both the in-room smoke alarm and the building fire alarm system.

**TABLE 907.9.1.3**  
**VISIBLE AND AUDIBLE ALARMS**  
**(Table 907.9.1.3 attached to end of document)**

**907.9.2 Audible alarms.** Audible alarm notification appliances shall be provided and shall sound a distinctive sound that is not to be used for any purpose other than that of a fire alarm. The audible alarm notification appliances shall provide a sound pressure

level of 15 decibels (dBA) above the average ambient sound level or 5 dBA above the maximum sound level having a duration of at least 60 seconds, whichever is greater, in every occupied space within the building. The minimum sound pressure levels shall be: 70 dBA in occupancies in Groups R and I-1; 90 dBA in mechanical equipment rooms and 60 dBA in other occupancies. The maximum sound pressure level for audible alarm notification appliances shall be 120 dBA at the minimum hearing distance from the audible appliance. Where the average ambient noise is greater than 105 dBA, visible alarm notification appliances shall be provided in accordance with NFPA72 and audible alarm notification appliances shall not be required to provide a maximum sound pressure level above 120 dBA.

**Exception:** Visible alarm notification appliances shall be allowed in lieu of audible alarm notification appliances in critical-care areas of Group I-2 occupancies.

**907.10 Fire safety functions.** Where a fire alarm system is required by Section 907.2, automatic fire detectors utilized for the purpose of performing fire safety functions shall be connected to the building's fire alarm control panel.. Detectors shall, upon actuation, perform the intended function and activate the alarm notification appliances or a visible and audible supervisory signal at a constantly attended location. In buildings not required to be equipped with a fire alarm system, the automatic fire detector shall be powered by normal electrical service and, upon actuation, perform the intended function. The detectors shall be located in accordance with NFPA 72.

**907.11 Duct smoke detectors.** Where a fire alarm system is provided, duct smoke detectors shall be connected to the building's fire alarm control panel.. Activation of a duct smoke detector shall initiate a visible and audible supervisory signal at a constantly attended location. Duct smoke detectors shall not be used as a substitute for required open-area detection.

**Exceptions:**

1. The supervisory signal at a constantly attended location is not required where duct smoke detectors activate the building's alarm notification appliances.
2. In occupancies not required to be equipped with a fire alarm system, actuation of a smoke detector shall activate a visible and audible signal in an approved location. Smoke detector trouble conditions shall activate a visible or audible signal in an approved location and shall be identified as air duct detector trouble.

**907.12 Access.** Access shall be provided to each detector for periodic inspection, maintenance and testing.

**907.13 Fire-extinguishing systems.** Where a fire alarm system is required by another section of this code or is otherwise installed, automatic fire-extinguishing systems shall

be connected to the building fire alarm system.

**907.14 Monitoring.** Where required by this chapter or the *New York City Fire Code*, an approved supervising station in accordance with NFPA 72 shall monitor fire alarm systems.

**Exception:** Supervisory service is not required for:

1. Single- and multiple-station smoke alarms required by Section 907.2.10.
2. Smoke detectors in Group I-3 occupancies.
3. Automatic sprinkler systems in one- and two-family dwellings.

**907.15 Automatic telephone-dialing devices.** Automatic telephone-dialing devices used to transmit an emergency alarm shall not be connected to any Fire Department telephone number unless approved by the Fire Commissioner.

**907.16 Acceptance tests.** Upon completion of the installation of the fire alarm system, alarm notification appliances and circuits, alarm-initiating devices and circuits, supervisory-signal initiating devices and circuits, signaling line circuits, and primary and secondary power supplies shall be tested in accordance with NFPA 72.

**907.17 Record of completion.** A record of completion in accordance with NFPA 72 verifying that the system has been installed in accordance with the approved construction documents and specifications shall be provided.

**907.18 Instructions.** Operating, testing and maintenance instructions, and record drawings (“as built”) and equipment specifications shall be provided at an approved location.

**907.19 Inspection, testing and maintenance.** The maintenance and testing schedules and procedures for fire alarm and fire detection systems shall be in accordance with the *New York City Fire Code*.

## **SECTION BC 908** **EMERGENCY ALARM SYSTEMS**

**908.1 Group H occupancies.** Emergency alarms for the detection and notification of an emergency condition in Group H occupancies shall be provided in accordance with Section 414.7.

**908.2 Group H-5 occupancy.** Emergency alarms for notification of an emergency condition in an HPM facility shall be provided as required in Section 415.9.4.6. A continuous gas-detection system shall be provided for HPM gases in accordance with Section 415.9.7.

**908.3 Highly toxic and toxic materials.** A gas detection system shall be provided for indoor storage and use of highly toxic and toxic gases to detect the presence of gas at or below the permissible exposure limit (PEL) or ceiling limit of the gas for which detection is provided. The system shall be capable of monitoring the discharge from the treatment system at or below one-half the immediately dangerous to life and health (IDLH) limit.

**Exception:** A gas detection system is not required for toxic gases when the physiological warning properties are at a level below the accepted PEL for the gas.

**908.3.1 Alarms.** The gas detection system shall initiate a local alarm and transmit a signal to a constantly attended control station when a short-term hazard condition is detected. The alarm shall be both visible and audible and shall provide warning both inside and outside the area where gas is detected. The audible alarm shall be distinct from all other alarms.

**Exception:** Signal transmission to a constantly attended control station is not required when not more than one cylinder of highly toxic or toxic gas is stored.

**908.3.2 Shutoff of gas supply.** The gas detection system shall automatically close the shutoff valve at the source on gas supply piping and tubing related to the system being monitored for whichever gas is detected.

**Exception:** Automatic shutdown is not required for reactors utilized for the production of highly toxic or toxic compressed gases where such reactors are:

1. Operated at pressures less than 15 pounds per square inch gauge (psig) (103.4 kPa).
2. Constantly attended.
3. Provided with readily accessible emergency shutoff valves.

**908.3.3 Valve closure.** The automatic closure of shutoff valves shall be in accordance with the following:

1. When the gas-detection sampling point initiating the gas detection system alarm is within a gas cabinet or exhausted enclosure, the shutoff valve in the gas cabinet or exhausted enclosure for the specific gas detected shall automatically close.
2. Where the gas-detection sampling point initiating the gas detection system alarm is within a gas room and compressed gas containers are not in gas cabinets or exhausted enclosures, the shutoff valves on all gas lines for the specific gas detected shall automatically close.

3. Where the gas-detection sampling point initiating the gas detection system alarm is within a piping distribution manifold enclosure, the shutoff valve for the compressed container of specific gas detected supplying the manifold shall automatically close.

**Exception:** When the gas-detection sampling point initiating the gas-detection system alarm is at a use location or within a gas valve enclosure of a branch line downstream of a piping distribution manifold, the shutoff valve in the gas valve enclosure for the branch line located in the piping distribution manifold enclosure shall automatically close.

**908.4 Ozone gas-generator rooms.** Ozone gas-generator rooms shall be equipped with a continuous gas-detection system that will shut off the generator and sound a local alarm when concentrations above the PEL occur.

**908.5 Repair garages.** A flammable-gas detection system shall be provided in repair garages for vehicles fueled by enumerated gases in accordance with Section 406.6.6.

**908.6 Refrigerant detector.** Machinery rooms shall contain a refrigerant detector with an audible and visual alarm. The detector, or a sampling tube that draws air to the detector, shall be located in an area where refrigerant from a leak will concentrate. The alarm shall be actuated at a value not greater than the corresponding TLV-TWA values for the refrigerant classification indicated in the *New York City Mechanical Code*. Detectors and alarms shall be placed in approved locations. Refrigerant detectors shall initiate all functions as required by the *New York City Mechanical Code* and *New York City Fire Code*.

**Exception:** Detectors are not required in ammonia system machinery rooms equipped with a vapor detector in accordance with the *New York City Mechanical Code*.

**908.7 Carbon monoxide alarms and detectors.** Carbon monoxide alarms and detectors shall be provided and installed in accordance with Sections 908.7.1 through 908.7.4.

**908.7.1 Group I-1 and R occupancies.** Listed carbon monoxide alarms or detectors shall be installed as follows:

1. Group R-1. Carbon monoxide detectors and audible notification appliances shall be installed in affected dwelling units as per Section 908.7.1.1 and shall be annunciated by dwelling unit at a constantly attended location from which the fire alarm system is capable of being manually activated.
2. Groups I-1, R-2 and R-3. Carbon monoxide alarms shall be installed in affected dwelling units as per Section 908.7.1.1.

**908.7.1.1 Affected dwelling units.** Carbon monoxide alarms or detectors shall be required within the following dwelling units:

1. Units on the same story where carbon monoxide producing equipment or enclosed parking is located.
2. Units on the stories above and below the floor where carbon monoxide producing equipment or enclosed parking is located.
3. Units in a building containing a carbon monoxide producing furnace, boiler, or water heater as part of a central system.
4. Units in a building served by a carbon monoxide producing furnace, boiler, or water heater as part of a central system that is located in an adjoining or attached building.

**908.7.1.1.1 Required locations within dwelling units.** Carbon monoxide alarms or detectors shall be located within dwelling units as follows:

1. Outside of any room used for sleeping purposes, within 15 feet (4572 mm) of the entrance to such room.
2. In any room used for sleeping purposes.
3. On any story within a dwelling unit, including below-grade stories and penthouses of any area, but not including crawl spaces and uninhabitable attics.

**908.7.1.1.2 Installation requirements.** Carbon monoxide alarms or detectors shall comply with the power source, interconnection, and acceptance testing requirements as required for smoke alarms in accordance with Sections 907.2.10.2 through 907.2.10.4.

**908.7.2 Group E, I-2 and I-4 occupancies.** Listed carbon monoxide alarms or detectors shall be installed as follows:

1. Carbon monoxide alarms shall be installed within any occupied space containing carbon monoxide producing equipment and in all occupied spaces above and below the story where carbon monoxide producing equipment or enclosed parking is located.
2. Carbon monoxide detectors and audible notification appliances shall be installed within any unoccupied space containing carbon monoxide producing equipment. Such detector shall activate an audible alarm at a constantly attended location.

**908.7.3 Installation.** Carbon monoxide alarms and detectors shall be listed in accordance with UL 2034 and UL 2075.

**908.8 Medical gas.** Medical gas pressure monitoring and alarm systems shall be provided in accordance with NFPA 99 and NFPA 99C.

**908.9 Flammable gas.** Areas within buildings containing flammable gas distribution piping operating at levels above 15 pounds per square inch gauge (psig) (103.4 kPa) shall be provided with an approved flammable gas detection-alarm system.

## **SECTION BC 909** **SMOKE CONTROL SYSTEMS**

**909.1 Scope and purpose.** This section applies to mechanical or passive smoke control systems when they are required by other provisions of this code. The purpose of this section is to establish minimum requirements for the design, installation and acceptance testing of smoke control systems that are intended to provide a tenable environment for the evacuation or relocation of occupants. These provisions are not intended for the preservation of contents, the timely restoration of operations or for assistance in fire suppression. Smoke control systems regulated by this section serve a different purpose than the smoke- and heat-venting provisions found in Section 910. Mechanical smoke control systems shall not be considered exhaust systems under Chapter 5 of the *New York City Mechanical Code*.

**909.1.1 Definitions.** These definitions are added for the purposes of Section 909 only.

**POST-FIRE SMOKE PURGE SYSTEM.** A mechanical or natural ventilation system intended to move smoke from the smoke zone to the exterior of the building.

**PRESSURIZATION.** Creation and maintenance of pressure levels in zones of a building, including elevator shafts and stairwells, that are higher than the pressure level at the smoke source, such pressure levels being produced by positive pressures of a supply of uncontaminated air; by exhausting air and smoke at the smoke source; or by a combination of these methods.

**SMOKE.** Airborne solid and liquid particulates and gases evolved when a material undergoes pyrolysis or combustion, including the quality of air that is entrained or otherwise mixed into the mass.

**SMOKE BARRIER.** See Section 702.1

**SMOKE-CONTROL MODE.** A predefined operational configuration of a system or device for the purpose of smoke control.

**SMOKE-CONTROL SYSTEM, MECHANICAL.** An engineered system that uses mechanical fans to produce pressure differences across smoke barriers or that establishes air flows to limit and direct smoke movement.



**SMOKE-CONTROL SYSTEM, PASSIVE.** A system of smoke barriers arranged to limit the migration of smoke.

**SMOKE-CONTROL ZONE.** A space within a building enclosed by smoke barriers.

**SMOKE DAMPER.** See Section 702.1.

**STACK EFFECT.** Vertical air flow within buildings caused by temperature differences.

**TENABLE ENVIRONMENT.** An environment in which the quality and location of smoke is limited or otherwise restricted to allow for ready evacuation through the space.

**909.2 General design requirements.** Buildings, structures or parts thereof required by this code to have a smoke control system or systems shall have such systems designed in accordance with the applicable requirements of Section 909 and the generally accepted and well-established principles of engineering relevant to the design. The construction documents shall include sufficient information and detail to adequately describe the elements of the design necessary for the proper implementation of the smoke control systems. These documents shall be accompanied by sufficient information and analysis to demonstrate compliance with these provisions.

**909.3 Special inspection and test requirements.** In addition to the ordinary inspection and test requirements that buildings, structures and parts thereof are required to undergo, smoke control systems subject to the provisions of Section 909 shall undergo special inspections and tests sufficient to verify the proper commissioning of the smoke control design in its final installed condition. The design submission accompanying the construction documents shall clearly detail procedures and methods to be used and the items subject to such inspections and tests. Such commissioning shall be in accordance with generally accepted engineering practice and, where possible, based on published standards for the particular testing involved. The special inspections and tests required by this section shall be conducted under the same terms in Section 1704.

**909.3.1 Periodic testing.** Smoke control systems shall be periodically tested to ensure proper operation. A record of each inspection and test shall be maintained on the premises by the owner or lessee, and the records for at least the last two years of operation shall be made available for inspection by the department and the Fire Commissioner.

**909.4 Analysis.** A rational analysis supporting the types of smoke control systems to be employed, their methods of operation, the systems supporting them and the methods of construction to be utilized shall accompany the submitted construction documents and shall include, but not be limited to, the items indicated in Sections 909.4.1 through 909.4.6. The basis of design and design analysis of the smoke control system shall be submitted to the department.

**909.4.1 Stack effect.** The system shall be designed such that the maximum probable normal or reverse stack effect will not adversely interfere with the system's capabilities. In determining the maximum probable stack effect, altitude, elevation, weather history and interior temperatures shall be used.

**909.4.2 Temperature effect of fire.** Buoyancy and expansion caused by the design fire in accordance with Section 909.9 shall be analyzed. The system shall be designed such that these effects do not adversely interfere with the system's capabilities.

**909.4.3 Wind effect.** The design shall consider the adverse effects of wind. Such consideration shall be consistent with the wind-loading provisions of Chapter 16.

**909.4.4 HVAC systems.** The design shall consider the effects of the heating, ventilating and air-conditioning (HVAC) systems on both smoke and fire transport. The analysis shall include all permutations of systems status. The design shall consider the effects of the fire on the HVAC systems.

**909.4.5 Climate.** The design shall consider the effects of low temperatures on systems, property and occupants. Air inlets and exhausts shall be located so as to prevent snow or ice blockage.

**909.4.6 Duration of operation.** All portions of active or passive smoke control systems shall be capable of continued operation after detection of the fire event for not less than 20 minutes.

**909.5 Smoke barrier construction.** Smoke barriers shall comply with Section 709, and shall be constructed and sealed to limit leakage areas exclusive of protected openings. The maximum allowable leakage area shall be the aggregate area calculated using the following leakage area ratios:

1. Walls:  $A/A_w = 0.00100$
2. Exit enclosures:  $A/A_w = 0.00035$
3. All other shafts:  $A/A_w = 0.00150$
4. Floors and roofs:  $A/A_F = 0.00050$

where:

$A$  = Total leakage area, square feet ( $m^2$ ).

$A_F$  = Unit floor or roof area of barrier, square feet ( $m^2$ ).

$A_w$  = Unit wall area of barrier, square feet ( $m^2$ ).

The leakage area ratios shown do not include openings due to doors, operable windows or similar gaps. These shall be included in calculating the total leakage area.

**909.5.1 Leakage area.** The total leakage area of the barrier is the product of the smoke barrier gross area monitored by the allowable leakage area ratio, plus the area of other openings such as gaps and operable windows. Compliance shall be determined by achieving the minimum air pressure difference across the barrier with the system in the smoke control mode for mechanical smoke control systems. Passive smoke control systems tested using other approved means such as door fan testing shall be approved by the department and the Fire Commissioner.

**909.5.2 Opening protection.** Openings in smoke barriers shall be protected by automatic-closing devices actuated by the required controls for the mechanical smoke control system. Door openings shall be protected by door assemblies complying with Section 715.3.3.

**Exceptions:**

1. Passive smoke control systems with automatic-closing devices actuated by spot-type smoke detectors listed for releasing service installed in accordance with Section 907.10.
2. Fixed openings between smoke zones that are protected utilizing the airflow method.
3. In Group I-2, where such doors are installed across corridors, a pair of opposite-swinging doors without a center mullion shall be installed having vision panels with approved fire-rated glazing materials in approved fire-rated frames, the area of which shall not exceed that tested. The doors shall be close fitting within operational tolerances and shall not have undercuts, louvers or grilles. The doors shall have head and jamb stops, astragals or rabbets at meeting edges, and automatic-closing devices. Positive-latching devices are not required.
4. Group I-3.
5. Openings between smoke zones with clear ceiling heights of 14 feet (4267 mm) or greater and bank-down capacity of greater than 20 minutes as determined by the design fire size.

**909.5.2.1 Ducts and air transfer openings.** Ducts and air transfer openings are required to be protected with a minimum Class II, 250°F (121°C) smoke damper complying with Section 716.

**909.6 Pressurization method.** The primary mechanical means of controlling smoke shall

be by pressure differences across smoke barriers. Maintenance of a tenable environment is not required in the smoke control zone of fire origin.

**909.6.1 Minimum pressure difference.** The minimum pressure difference across a smoke barrier shall be 0.05-inch water gage (0.0124 kPa) in fully sprinklered buildings. In buildings permitted to be other than fully sprinklered, the smoke control system shall be designed to achieve pressure differences at least two times the maximum calculated pressure difference produced by the design fire, but in no case less than the values indicated in Table 909.6.1:

**Table 909.6.1**  
**MINIMUM PRESSURE DIFFERENCES ACROSS SMOKE BARRIERS**  
**(Table 909.6.1 attached to end of document)**

**909.6.2 Maximum pressure difference.** The maximum air pressure difference across a smoke barrier shall be determined by required door-opening or closing forces. The actual force required to open exit doors when the system is in the smoke control mode shall be in accordance with Section 1008.1.2. Opening and closing forces for other doors shall be determined by standard engineering methods for the resolution of forces and reactions. The calculated force to set a side-hinged, swinging door in motion shall be determined by:

**(Equation 9-1 attached to end of document)**

**909.7 Air flow design method.** When approved by the department, smoke migration through openings fixed in a permanently open position, which are located between smoke control zones by the use of the airflow method, shall be permitted. The design air flow shall be in accordance with this section. Air flow shall be directed to limit smoke migration from the fire zone. The geometry of openings shall be considered to prevent flow reversal from turbulent effects.

**909.7.1 Velocity.** The minimum average velocity through a fixed opening shall not be less than:

**(Equation 9-2 attached to end of document)**

**909.7.2 Prohibited conditions.** This method shall not be employed where either the quantity of air or the velocity of the airflow will adversely affect other portions of the smoke control system, unduly intensify the fire, disrupt plume dynamics or interfere with exiting. In no case shall airflow toward the fire exceed 200 feet per minute (1.02 m/s). Where the formula in Section 909.7.1 requires airflow to exceed this limit, the airflow method shall not be used.

**909.8 Exhaust method.** When approved by the department, mechanical smoke control for large enclosed volumes, such as in atriums or malls, shall be permitted to utilize the exhaust method. The design exhaust volumes shall be in accordance with this section.

**909.8.1 Exhaust rate.** The height of the lowest horizontal surface of the accumulating smoke layer shall be maintained at least 6 feet (1829 mm) above any walking surface that forms a portion of a required egress system within the smoke zone. The required exhaust rate for the zone shall be the largest of the calculated plume mass flow rates for the possible plume configurations. Provisions shall be made for natural or mechanical supply of air from outside or adjacent smoke zones to make up for the air exhausted. Makeup airflow rates, when measured at the potential fire location, shall not increase the smoke production rate beyond the capacity of the smoke control system. The temperature of the makeup air shall be such that it does not expose temperature-sensitive fire protection systems beyond their limits.

**909.8.2 Axisymmetric plumes.** The plume mass flow rate ( $m_p$ ), in pounds per second (kg/s), shall be determined by placing the design fire center on the axis of the space being analyzed. The limiting flame height shall be determined by:

**(Equation 9-3 attached to end of document)**

**(Equation 9-4 attached to end of document)**

**909.8.3 Balcony spill plumes.** The plume mass flow rate ( $m_p$ ) for spill plumes shall be determined using the geometrically probable width based on architectural elements and projections in the following equation:

**(Equation 9-5 attached to end of document)**

**909.8.4 Window plumes.** The plume mass flow rate ( $m_p$ ) shall be determined from:

**(Equation 9-6 attached to end of document)**

**909.8.5 Plume contact with walls.** When a plume contacts one or more of the surrounding walls, the mass flow rate shall be adjusted for the reduced entrainment resulting from the contact provided that the contact remains constant. Use of this provision requires calculation of the plume diameter, which shall be calculated by:

**(Equation 9-7 attached to end of document)**

**909.9 Design fire.** The design fire shall be based on a  $Q$  of not less than 5,000 Btu/s (5275 kW) unless a rational analysis is performed by the registered design professional and approved by the department. The design fire shall be based on the analysis in accordance with Section 909.4 and this section.

**909.9.1 Factors considered.** The engineering analysis shall include the characteristics of the fuel, fuel load, effects included by the fire and whether the fire is likely to be steady or unsteady.

**909.9.2 Separation distance.** Determination of the design fire shall include

consideration of the type of fuel, fuel spacing and configuration. The ratio of the separation distance to the fuel equivalent radius shall not be less than 4. The fuel equivalent radius shall be the radius of a circle of equal area to floor area of the fuel package. The design fire shall be increased if other combustibles are within the separation distance as determined by:

**(Equation 9-8 attached to end of document)**

**909.9.3 Heat-release assumptions.** The analysis shall make use of best available data from approved sources and shall not be based on excessively stringent limitations of combustible material.

**909.9.4 Sprinkler effectiveness assumptions.** A documented engineering analysis shall be provided for conditions that assume fire growth is halted at the time of sprinkler activation.

**909.10 Equipment.** Equipment such as, but not limited to, fans, ducts, automatic dampers and balance dampers, shall be suitable for its intended use, suitable for the probable exposure temperatures that the rational analysis indicates, and as approved by the department.

**909.10.1 Exhaust fans.** Components of exhaust fans shall be rated and certified by the manufacturer for the probable temperature rise to which the components will be exposed. This temperature rise shall be computed by:

**(Equation 9-9 attached to end of document)**

**Exception:** Reduced  $T_s$  as calculated based on the assurance of adequate dilution air.

**909.10.2 Ducts.** Duct materials and joints shall be capable of withstanding the probable temperatures and pressures to which they are exposed as determined in accordance with Section 909.10.1. Ducts shall be constructed and supported in accordance with the *New York City Mechanical Code*. Ducts shall be leak tested to 1.5 times the maximum design pressure in accordance with nationally accepted practices. Measured leakage shall not exceed 5 percent of design flow. Results of such testing shall be a part of the documentation procedure. Ducts shall be supported directly from fire-resistance-rated structural elements of the building by substantial, noncombustible supports.

**Exception:** Flexible connections (for the purpose of vibration isolation) complying with the *New York City Mechanical Code*, that are constructed of approved fire-resistance-rated materials.

**909.10.3 Equipment, inlets and outlets.** Equipment shall be located so as not to expose uninvolved portions of the building to an additional fire hazard. Outside air

inlets shall be located so as to minimize the potential for introducing smoke or flame into the building. Exhaust outlets shall be located so as to minimize reintroduction of smoke into the building and to limit exposure of the building or adjacent buildings to an additional fire hazard.

**909.10.4 Automatic dampers.** Automatic dampers, regardless of the purpose for which they are installed within the smoke control system, shall be listed for their use.

**909.10.5 Fans.** In addition to other requirements, belt-driven fans shall have 1.5 times the number of belts required for the design duty, but not less than two. Fans shall be selected for stable performance based on normal temperature and, where applicable, elevated temperature. Calculations and manufacturer's fan curves shall be part of the documentation procedures. Fans shall be supported and restrained by noncombustible devices in accordance with the requirements of Chapter 16. Motors driving fans shall not be operated beyond their nameplate horsepower (kilowatts), as determined from measurement of actual current draw, and shall have a minimum service factor of 1.15.

**909.11 Power systems.** The smoke control system shall be supplied with two sources of power. Primary power shall be the normal building power systems. Secondary power shall be from an emergency source complying with the *New York City Electrical Code*. The emergency power source and its transfer switches shall be in a separate room from the normal power transformers and switch gear and shall be enclosed in a room constructed of not less than 1-hour fire-resistance-rated fire barriers ventilated directly to and from the exterior. Power distribution from the two sources shall be by independent routes. Transfer to full emergency power shall be automatic and within 60 seconds of failure of the primary power. The systems shall comply with the *New York City Electrical Code*.

**909.11.1 Power sources and power surges.** Elements of the smoke management system relying on volatile memories or similar systems shall be supplied with uninterruptable power sources of sufficient duration to span a 15-minute primary power interruption. Elements of the smoke management system susceptible to power surges shall be suitably protected by conditioners, suppressors or other approved means.

**909.12 Detection and control systems.** Fire detection systems providing control input or output signals to mechanical smoke control systems or elements thereof shall comply with the requirements of Chapter 9 and NFPA 72. Such systems shall be equipped with a control unit complying with UL 864 and listed as smoke control equipment.

Control systems for mechanical smoke control systems shall include provisions for verification. Verification shall include positive confirmation of actuation, testing, manual override, the presence of power downstream of all disconnects and, through a preprogrammed weekly test sequence report, abnormal conditions audibly, visually and by printed report.

**909.12.1 Wiring.** In addition to meeting requirements of the *New York City Electrical Code*, all wiring, regardless of voltage, shall be fully enclosed within continuous raceways.

**909.12.2 Activation.** Smoke control systems shall be activated in accordance with this section.

**909.12.2.1 Pressurization, airflow or exhaust method.** Mechanical smoke control systems using the pressurization, airflow or exhaust method shall have completely automatic control.

**909.12.2.2 Passive method.** Passive smoke control systems actuated by spot-type detectors listed for releasing service shall be permitted.

**909.12.3 Automatic control.** Where completely automatic control is required or used, the automatic-control sequences shall be initiated from an appropriately zoned automatic sprinkler system complying with Section 903.3.1.1, manual controls that are readily accessible to the Fire Department and any smoke detectors required by engineering analysis. See Section 909.16 for manual control requirements.

**909.13 Control air tubing.** Control air tubing shall be of sufficient size to meet the required response times. Tubing shall be flushed clean and dry prior to final connections and shall be adequately supported and protected from damage. Tubing passing through concrete or masonry shall be sleeved and protected from abrasion and electrolytic action.

**909.13.1 Materials.** Control air tubing shall be hard drawn copper, Type L, ACR in accordance with ASTM B 42, ASTM B 43, ASTM B 68, ASTM B 88, ASTM B 251 and ASTM B 280. Fittings shall be wrought copper or brass, solder type, in accordance with ASME B 16.18 or ASME B 16.22. Changes in direction shall be made with appropriate tool bends. Brass compression-type fittings shall be used at final connection to devices; other joints shall be brazed using a BCuP5 brazing alloy with solidus above 1,100°F (593°C) and liquids below 1,500°F (816°C). Brazing flux shall be used on copper-to-brass joints only.

**Exception:** Nonmetallic tubing used within control panels and at the final connection to devices, providing all of the following conditions are met:

- 1. Tubing shall be listed by an approved agency for flame and smoke characteristics.**
- 2. Tubing and connected devices shall be completely enclosed within galvanized or paint-grade steel enclosure of not less than 0.030 inch (0.76 mm) (No. 22 galvanized sheet gage) thickness. Entry to the enclosure shall be by copper tubing with a protective grommet of neoprene or teflon or by suitable brass compression to male-barbed adapter.**



3. Tubing shall be identified by appropriately documented coding.
4. Tubing shall be neatly tied and supported within enclosure. Tubing bridging cabinet and door or moveable device shall be of sufficient length to avoid tension and excessive stress. Tubing shall be protected against abrasion. Tubing serving devices on doors shall be fastened along hinges.

**909.13.2 Isolation from other functions.** Control tubing serving other than smoke control functions shall be isolated by automatic isolation valves or shall be an independent system.

**909.13.3 Testing.** Control air tubing shall be tested at three times the operating pressure for not less than 30 minutes without any noticeable loss in gauge pressure prior to final connection to devices.

**909.14 Marking and identification.** The detection and control systems shall be clearly marked at all junctions, accesses and terminations.

**909.15 Control diagrams.** Identical control diagrams showing all devices in the system and identifying their location and function shall be maintained current and kept on file with the department, the Fire Department and in the fire command center in format and manner approved by the Fire Commissioner.

**909.16 Fire-fighter's smoke control panel.** A fire-fighter's smoke control panel for Fire Department emergency response purposes only shall be provided and shall include manual control or override of automatic control for mechanical smoke control systems. The panel shall be located in a fire command center complying with Section 911, and shall comply with Sections 909.16.1 through 909.16.3. Where required in Section 912, the post-fire smoke purge system shall be manually activated from the fire-fighter's control panel.

**909.16.1 Panel indicators.** Fans within the building shall be shown on the fire fighter's control panel. A clear indication of the direction of airflow and the relationship of components shall be displayed. Status indicators shall be provided for all smoke control equipment, annunciated by fan and zone, and by pilot-lamp-type indicators as follows:

1. Fans, dampers and other operating equipment in their normal status—WHITE.
2. Fans, dampers and other operating equipment in their off or closed status—RED.
3. Fans, dampers and other operating equipment in their on or open status—GREEN.
4. Fans, dampers and other operating equipment in a fault status—

YELLOW/AMBER.

**909.16.2 Panel controls.** The fire fighter's control panel shall provide control capability over the complete smoke-control system equipment within the building as follows:

1. ON-AUTO-OFF control over each individual piece of operating smoke control equipment that can also be controlled from other sources within the building. This includes stairway pressurization fans; smoke exhaust fans; supply, return and exhaust fans; elevator shaft fans and other operating equipment used or intended for smoke control purposes.
2. OPEN-AUTO-CLOSE control over individual dampers relating to smoke control and that are also controlled from other sources within the building.
3. ON-OFF or OPEN-CLOSE control over smoke control and other critical equipment associated with a fire or smoke emergency and that can only be controlled from the fire-fighter's control panel. The fire fighter's control panel shall be configured as described in Section 911.

**Exceptions:**

1. Complex systems, where approved, where the controls and indicators are combined to control and indicate all elements of a single smoke zone as a unit.
2. Complex systems, where approved, where the control is accomplished by computer interface using approved, plain English commands.

**909.16.3 Control action and priorities.** The fire-fighter's control panel actions shall be as follows:

1. ON-OFF, OPEN-CLOSE control actions shall have the highest priority of any control point within the building. Once issued from the fire-fighter's control panel, no automatic or manual control from any other control point within the building shall contradict the control action. Where automatic means are provided to interrupt normal, nonemergency equipment operation or produce a specific result to safeguard the building or equipment (i.e., duct freezestats, duct smoke detectors, high-temperature cutouts, temperature-actuated linkage and similar devices), such means shall be capable of being overridden by the fire-fighter's control panel. The last control action as indicated by each fire-fighter's control panel switch position shall prevail. In no case shall control actions require the smoke control system to assume more than one configuration at any one time.

**Exception:** Power disconnects required by the *New York City Electrical*

Code.

2. Only the AUTO position of each three-position fire-fighter's control panel switch shall allow automatic or manual control action from other control points within the building. The AUTO position shall be the NORMAL, nonemergency, building control position. Where a fire-fighter's control panel is in the AUTO position, the actual status of the device (on, off, open, closed) shall continue to be indicated by the status indicator described above. When directed by an automatic signal to assume an emergency condition, the NORMAL position shall become the emergency condition for that device or group of devices within the zone. In no case shall control actions require the smoke control system to assume more than one configuration at any one time.

**909.17 System response time.** Smoke-control system activation shall be initiated immediately after receipt of an appropriate automatic or manual activation command. Smoke control systems shall activate individual components (such as dampers and fans) in the sequence necessary to prevent physical damage to the fans, dampers, ducts and other equipment. For purposes of smoke control, the fire-fighter's control panel response time shall be the same for automatic or manual smoke control action initiated from any other building control point. The total response time, including that necessary for detection, shutdown of operating equipment and smoke control system startup, shall allow for full operational mode to be achieved before the conditions in the space exceed the design smoke condition. The system response time for each component and their sequential relationships shall be detailed in the required rational analysis and verification of their installed condition reported in the required final report.

**909.18 Acceptance testing.** Devices, equipment, components and sequences shall be individually tested. These tests, in addition to those required by other provisions of this code, shall consist of determination of function, sequence and, where applicable, capacity of their installed condition.

**909.18.1 Detection devices.** Smoke or fire detectors that are a part of a smoke control system shall be tested in accordance with Chapter 9 in their installed condition. When applicable, this testing shall include verification of airflow in both minimum and maximum conditions.

**909.18.2 Ducts.** Ducts that are part of a smoke control system shall be traversed using generally accepted practices to determine actual air quantities.

**909.18.3 Dampers.** Dampers shall be tested for function in their installed condition.

**909.18.4 Inlets and outlets.** Inlets and outlets shall be read using generally accepted practices to determine air quantities.

**909.18.5 Fans.** Fans shall be examined for correct rotation. Measurements of voltage, amperage, revolutions per minute (rpm) and belt tension shall be made.

**909.18.6 Smoke barriers.** Measurements using inclined manometers or other approved calibrated measuring devices shall be made of the pressure differences across smoke barriers. Such measurements shall be conducted for each possible smoke control condition.

**909.18.7 Controls.** Each smoke zone, equipped with an automatic-initiation device, shall be put into operation by the actuation of one such device. Each additional device within the zone shall be verified to cause the same sequence without requiring the operation of fan motors in order to prevent damage. Control sequences shall be verified throughout the system, including verification of override from the fire-fighter's control panel and simulation of emergency power conditions.

**909.18.8 Special inspections for smoke control.** Smoke control systems shall be tested by a special inspector in accordance with Chapter 17.

**909.18.8.1 Scope of testing.** Special inspections shall be conducted in accordance with the following:

1. During erection of ductwork and prior to concealment for the purposes of leakage testing and recording of device location.
2. Prior to occupancy and after sufficient completion for the purposes of pressure-difference testing, flow measurements, and detection and control verification.

**909.18.8.2 Qualifications.** Special inspectors for smoke control shall have a certification as air balancers and expertise in fire protection engineering or mechanical engineering.

**909.18.8.3 Reports.** A complete report of testing shall be prepared by the special inspector or approved agency. The report shall include identification of all devices by manufacturer, nameplate data, design values, measured values and identification tag or mark. The report shall be reviewed by the responsible engineer and, when satisfied that the design intent has been achieved, the engineer shall seal, sign and date the report.

**909.18.8.3.1 Report filing.** A copy of the final report and each inspection report shall be filed with the department and Fire Commissioner, and an identical copy shall be maintained in an approved location at the building.

**909.18.9 Identification and documentation.** Charts, drawings and other documents identifying and locating each component of the smoke control system, and describing its proper function and maintenance requirements, shall be maintained on file at the building as an attachment to the report required by Section 909.18.8.3. Devices shall have an approved identifying tag or mark on them consistent with the other required

documentation and shall be dated indicating the last time they were successfully tested and by whom.

**909.18.10 Re-acceptance testing.** The smoke control system shall require a re-acceptance test after any modifications to the system or physical changes to the building that may affect system performance.

**909.19 System acceptance.** Buildings, or portions thereof, required by this code to comply with this section shall not be issued a certificate of occupancy until such time that the department determines that the provisions of this section have been fully complied with, and that the Fire Department has received satisfactory instruction on the operation, both automatic and manual, of the system.

**Exception:** In buildings of phased construction, the department may issue a temporary certificate of occupancy provided that those portions of the building to be occupied meet the requirements of this section and that the remainder does not pose a significant hazard to the safety of the proposed occupants or adjacent buildings.

**909.20 Smokeproof enclosures.** Where required by Section 1019.1.8, a smoke proof enclosure shall be constructed in accordance with this section. Where access to the roof is required by the *New York City Fire Code*, such access shall be from the smoke proof enclosure where a smoke proof enclosure is required. Smokeproof enclosures shall consist of one of the following systems:

1. An enclosed interior exit stairway constructed in accordance with Section 1019.1 and accessed through an open exterior balcony.
2. An enclosed interior exit stairway constructed in accordance with Section 1019.1 and accessed through a naturally ventilated vestibule.
3. An enclosed interior exit stairway constructed in accordance with Section 1019.1 and accessed through a mechanically ventilated vestibule.
4. A pressurized interior exit stairway constructed in accordance with Section 1019.1

**909.20.1 Access.** Access to the interior exit stairway shall be by way of a vestibule or an open exterior balcony, unless such stairway is pressurized in accordance with Section 909.20.5. The minimum dimension of the vestibule or open exterior balcony shall not be less than the required width of the corridor leading to the vestibule or open exterior balcony but shall not have a width of less than 44 inches (1118 mm) and shall not have a length of less than 72 inches (1829 mm) in the direction of egress travel.

**909.20.2 Construction.** The smoke proof enclosure shall be separated from the remainder of the building by not less than a 2-hour fire-resistance-rated fire barrier

without openings other than the required means of egress doors. The vestibule shall be separated from the stairway by not less than a 2-hour fire-resistance-rated fire barrier. The open exterior balcony shall be constructed in accordance with the fire-resistance-rating requirements for floor construction.

**909.20.2.1 Door closers.** Doors in a smoke proof enclosure shall be self-closing or shall be automatic-closing by actuation of a smoke detector installed at the floor-side entrance to the smoke proof enclosure in accordance with Section 715.3.7. The actuation of the smoke detector on any door shall activate the closing devices on all doors in the smoke proof enclosure at all levels. Smoke detectors shall be installed in accordance with Section 907.10.

**909.20.3 Natural ventilation alternative.** The provisions of Sections 909.20.3.1 through 909.20.3.3 shall apply to ventilation of smoke proof enclosures by natural means.

**909.20.3.1 Balcony doors.** Where access to the stairway is by way of an open exterior balcony, the door assembly into the enclosure shall be a fire door in accordance with Section 715.3.

**909.20.3.2 Vestibule doors.** Where access to the stairway is by way of a vestibule, the door assembly into the vestibule shall be a fire door complying with Section 715.3. The door assembly from the vestibule to the stairway shall have not less than a 90-minute fire protection rating complying with Section 715.3.

**909.20.3.3 Vestibule ventilation.** Each vestibule shall have a minimum net area of 16 square feet (1.5 m<sup>2</sup>) of opening in a wall facing an outer court, yard or public way that is at least 20 feet (6096 mm) in width.

**909.20.4 Mechanical ventilation alternative.** The provisions of Sections 909.20.4.1 through 909.20.4.4 shall apply to ventilation of smoke proof enclosures by mechanical means.

**909.20.4.1 Vestibule doors.** The door assembly from the building into the vestibule shall be a fire door complying with Section 715.3. The door assembly from the vestibule to the stairway shall have not less than a 90-minute fire protection rating in accordance with Section 715.3. The door from the building into the vestibule shall be provided with gaskets or other provisions to minimize air leakage.

**909.20.4.2 Vestibule ventilation.** The vestibule shall be supplied with not less than one air change per minute and the exhaust shall not be less than 150 percent of supply. Supply air shall enter and exhaust air shall discharge from the vestibule through separate, tightly constructed ducts used only for that purpose. Supply air shall enter the vestibule within 6 inches (152 mm) of the floor level. The top of the exhaust register shall be located at the top of the smoke trap but not more than

6 inches (152 mm) down from the top of the trap, and shall be entirely within the smoke trap area. Doors in the open position shall not obstruct duct openings. Duct openings with controlling dampers are permitted where necessary to meet the design requirements, but dampers are not otherwise required.

**909.20.4.2.1 Engineered ventilation system.** Where a specially engineered system is used, the system shall exhaust a quantity of air equal to not less than 90 air changes per hour from any vestibule in the emergency operation mode and shall be sized to handle three vestibules simultaneously. Smoke detectors shall be located at the floor-side entrance to each vestibule and shall activate the system for the affected vestibule. Smoke detectors shall be installed in accordance with Section 907.10.

**909.20.4.3 Smoke trap.** The vestibule ceiling shall be at least 20 inches (508 mm) higher than the door opening into the vestibule to serve as a smoke and heat trap and to provide an upward-moving air column. The height shall not be decreased unless approved and justified by design and test.

**909.20.4.4 Stair shaft air movement system.** The stair shaft shall be provided with a dampered relief opening and supplied with sufficient air to maintain a minimum positive pressure of 0.10 inch of water (25 Pa) in the shaft relative to the vestibule with all doors closed. The system shall maintain a maximum of 0.35 inch of water (87 Pa) in the shaft relative to the building measured with all stairway doors closed under maximum anticipated stack pressures.

**909.20.4.5 Door Opening Force.** Door opening force shall not exceed limits in Section 1008.1.2.

**909.20.5 Stair pressurization alternative.** Where the building is equipped throughout with an automatic sprinkler system in accordance with Section 903.3.1.1, the vestibule is not required, provided that interior exit stairways are pressurized to a minimum of 0.15 inch of water (37 Pa) and a maximum of 0.35 inch of water (87 Pa) in the shaft relative to the building measured with all stairway doors closed under maximum anticipated stack pressures.

**909.20.6 Ventilating equipment.** The activation of ventilating equipment required by the alternatives in Sections 909.20.4 and 909.20.5 shall be by smoke detectors installed at each floor level at an approved location at the entrance to the smokeproof enclosure. When the closing device for the stair shaft and vestibule doors is activated by smoke detection or power failure, the mechanical equipment shall activate and operate at the required performance levels. Smoke detectors shall be installed in accordance with Section 907.10.

**909.20.6.1 Ventilation systems.** Smokeproof enclosure ventilation systems shall be independent of other building ventilation systems. The equipment and ductwork shall comply with one of the following:

1. Equipment and ductwork shall be located exterior to the building and directly connected to the smokeproof enclosure or connected to the smokeproof enclosure by ductwork enclosed by 2-hour fire-resistance-rated fire barriers.
2. Equipment and ductwork shall be located within the smokeproof enclosure with intake or exhaust directly from and to the outside or through ductwork enclosed by 2-hour fire-resistance-rated fire barriers.
3. Equipment and ductwork shall be located within the building if separated from the remainder of the building, including other mechanical equipment, by 2-hour fire-resistance-rated fire barriers.

**909.20.6.2 Emergency power.** Mechanical vestibule and stair shaft ventilation systems and automatic fire detection systems shall be powered by an emergency power system conforming to Section 403.11 and Chapter 27.

**909.20.6.3 Acceptance and testing.** Before the mechanical equipment is approved, the system shall be tested in the presence of the department or approved agency to confirm that the system is operating in compliance with these requirements.

**909.21 Underground building smoke exhaust system.** Where required in accordance with Section 405.5 for underground buildings, a smoke exhaust system shall be provided in accordance with this section.

**909.21.1 Exhaust capability.** Where compartmentation is required, each compartment shall have an independent, automatically activated smoke exhaust system capable of manual operation. The system shall have an air supply and smoke exhaust capability that will provide a minimum of six air changes per hour.

**909.21.2 Operation.** The smoke exhaust system shall be operated in the compartment of origin by the following, independently of each other:

1. Two cross-zoned smoke detectors within a single protected area of a single smoke detector monitored by an alarm verification zone or an approved equivalent method.
2. The automatic sprinkler system.
3. Manual controls that are readily accessible to the Fire Department.

**909.21.3 Alarm required.** Activation of the smoke exhaust system shall activate an audible alarm at a constantly attended location.



## **SECTION BC 910** **SMOKE AND HEAT VENTS**

**910.1 General.** Where required by this code or otherwise installed, smoke and heat vents or mechanical smoke exhaust systems and draft curtains shall conform to the requirements of this section.

**Exception:** Frozen-food warehouses used solely for storage of Class I and II commodities where protected by an automatic sprinkler system in accordance with Section 903.3.1.1.

**910.2 Where required.** Smoke and heat vents designed in accordance with Section 910.3 shall be installed in the roofs of buildings or portions thereof occupied for the uses set forth in Sections 910.2.1 through 910.2.3. Vents shall be installed at the top of a closed shaft in accordance with Section 910.5.

**910.2.1 Groups F-1 and S-1.** Buildings and portions thereof used as a Group F-1 or S-1 occupancy having more than 50,000 square feet (4645 m<sup>2</sup>) in undivided area.

**Exception:** Group S-1 aircraft repair hangars.

**910.2.2 Group H.** Buildings and portions thereof used as a Group H occupancy as shown:

1. In occupancies classified as Group H-2 or H-3, any of which are over 15,000 square feet (1394 m<sup>2</sup>) in undivided area or area greater in depth than 100 feet (30 480 mm) from Fire Department apparatus access.

**Exception:** Buildings of noncombustible construction containing only noncombustible materials.

2. In areas of buildings in Group H used for storing Class 2, 3, and 4 liquid and solid oxidizers, Class 1 and unclassified detonable organic peroxides, Class 3 and 4 unstable (reactive) materials, or Class 2 or 3 water-reactive materials as required for a high-hazard commodity classification.

**Exception:** Buildings of noncombustible construction containing only noncombustible materials.

**910.2.3 High-piled combustible storage.** Buildings and portions thereof containing high-piled combustible stock or rack storage in any occupancy group in accordance with Section 413 and the *New York City Fire Code*.

**910.3 Design and installation.** The design and installation of smoke and heat vents and draft curtains shall be as specified in this section and Table 910.3.

**TABLE 910.3**  
**REQUIREMENTS FOR DRAFT CURTAINS AND SMOKE AND HEAT**  
**VENTS<sup>a</sup>**

**(Table 910.3 attached to end of document)**

**910.3.1 Vent operation.** Smoke and heat vents shall be listed and labeled and shall be capable of being operated by approved automatic and manual means. Automatic operation of smoke and heat vents shall conform to the provisions of this section.

**910.3.1.1 Gravity-operated drop-out vents.** Automatic smoke and heat vents containing heat-sensitive glazing designed to shrink and drop out of the vent opening when exposed to fire shall fully open within 5 minutes after the vent cavity is exposed to a simulated fire, represented by a time-temperature gradient that reaches an air temperature of 500°F (260°C) within 5 minutes.

**910.3.1.2 Sprinklered buildings.** Where installed in buildings provided with an automatic sprinkler system in accordance with Section 903.3.1.1, smoke and heat vents shall be designed to operate automatically.

**910.3.1.3 Nonsprinklered buildings.** Where installed in buildings not provided with an automatic sprinkler system, smoke and heat vents shall operate automatically by actuation of a heat-responsive device rated at between 100°F (38°C) and 220°F (104°C) above ambient.

**Exception:** Gravity-operated drop-out vents complying with Section 910.3.1.1

**910.3.2 Vent dimensions.** The effective venting area shall not be less than 16 square feet (1.5 m<sup>2</sup>) with no dimension less than 4 feet (1219 mm), excluding ribs or gutters having a total width not exceeding 6 inches (152 mm).

**910.3.3 Vent locations.** Smoke and heat vents shall be located 20 feet (6096 mm) or more from adjacent lot lines and fire walls and 10 feet (3048 mm) or more from fire barrier walls. Vents shall be uniformly located within the roof area above high-piled storage areas, with consideration given to roof pitch, draft curtain location, sprinkler location and structural members.

**910.3.4 Draft curtains.** Where required, draft curtains shall be provided in accordance with this section.

**Exception:** Where areas of buildings are equipped with early suppression fast-response (ESFR) sprinklers, draft curtains need not be provided within these areas. Draft curtains shall only be provided at the separation between the ESFR sprinklers and the conventional sprinklers.

**910.3.4.1 Construction.** Draft curtains shall be constructed of sheet metal, lath and plaster, gypsum board or other approved materials that provide equivalent

performance to resist the passage of smoke. Joints and connections shall be smoke tight.

**910.3.4.2 Location and depth.** The location and minimum depth of draft curtains shall be in accordance with Table 910.3.

**910.4 Mechanical smoke exhaust.** Where approved by the department, engineered mechanical smoke exhaust shall be an acceptable alternate to smoke and heat vents.

**910.4.1 Location.** Exhaust fans shall be uniformly spaced within each draft-curtained area and the maximum distance between fans shall not be greater than 100 feet (30 480 mm).

**910.4.2 Size.** Fans shall have a maximum individual capacity of 30,000 cfm (14.2 m<sup>3</sup>/s). The aggregate capacity of smoke exhaust fans shall be determined by the equation:

**(Equation 9-10 attached to end of document)**

**910.4.3 Operation.** Mechanical smoke exhaust fans shall be automatically activated by the automatic sprinkler system or by heat detectors having operating characteristics equivalent to those described in Section 910.3.1. Individual manual controls of each fan unit shall also be provided.

**910.4.4 Wiring and control.** Wiring for operation and control of smoke exhaust fans shall be connected ahead of the main disconnect and protected against exposure to temperatures in excess of 1,000°F (538°C) for a period of not less than 15 minutes. Controls shall be located so as to be immediately accessible to the fire service from the exterior of the building and protected against interior fire exposure by fire barriers having a fire-resistance rating not less than one hour. The location of manual controls is subject to the approval of the Fire Commissioner.

**910.4.5 Supply air.** Supply air for exhaust fans shall be provided at or near the floor level and shall be sized to provide a minimum of 50 percent of required exhaust. Openings for supply air shall be uniformly distributed around the periphery of the area served.

**910.4.6 Interlocks.** In combination comfort air-handling/smoke removal systems or independent comfort air-handling systems, fans shall be controlled to shut down in accordance with the approved smoke control sequence.

**910.5 Smoke venting of closed shafts.** All closed shafts having a floor area exceeding four square feet (0.37 m<sup>2</sup>) shall be provided with a smoke vent in accordance with Section 910.5.1 through 910.5.3.

**Exception:** Elevator and dumbwaiter shafts in accordance with Chapter 30.

**910.5.1 Smoke vent construction.** Smoke vents may be constructed as windows, louvers, skylights, vent ducts, or similar devices. Where a vent duct is installed, such vent ducts shall be enclosed by construction having the same fire resistance rating as required for the shaft enclosure.

**910.5.2 Smoke vent dimensions.** The effective venting area shall not be less than 3-½ percent of the maximum shaft area at any floor, but in no event less than 72 square inches (0.05 m<sup>2</sup>). Of the total required vent area, at least one-third shall be clear opening to the exterior in the form of fixed louvers, ridge vents, or hooded or goosenecked openings. The remaining portion of the required vent area may be a window or skylight glazed with plain glass not more than ⅛-inch (3.2 mm) thick or with plastic glazing.

**Exception:** The clear opening to the exterior may be constructed as a skylight or trapdoor arranged to open automatically by fusible link or other mechanical device when subjected to a temperature of 160°F (71°C) or to a rapid rise in temperature at a rate of 15°F (-9.4°C) to 20°F (-6.7°C) per minute.

**910.5.3 Smoke vent location.** Smoke vents shall be located in accordance with 910.5.3.1 or 910.5.3.2 as applicable.

**910.5.3.1 Smoke vents located above the roof line.** Where a closed shaft or smoke vent duct penetrates through the roof of the building, the vent shall be located as follows:

1. The vent shall be located at least 8 inches (203 mm) above a noncombustible roof assembly or at least 36 inches (914 mm) above a combustible roof assembly.
2. The vent shall be located at least 10 feet (3048 mm) from any window, door, exterior stairway, or interior lot line. The vent may be located no less than 5 feet (1524 mm) from any window or door provided that the vent is located at a point higher than the top of such window or door.
3. Where the vent is constructed as a window or louver, the sill of the window or louver shall be located at least 36 inches (above the roof assembly).

**910.5.3.2 Smoke vents located in an exterior wall.** Where the exterior wall serves as part of a shaft enclosure or where a smoke vent duct penetrates the exterior wall of the building, the vent shall be located at least 30 feet above and 5 feet to the side of any other openings in the exterior wall.

**SECTION BC 911**  
**FIRE COMMAND CENTER**

**911.1 Features.** Where required by other sections of this code, a fire command center for Fire Department operations shall be provided. The fire command center shall be located in the lobby of the building on the entrance floor as part of the fire alarm control panel, elevator control panel or immediately adjacent thereto. The fire command center shall comply with NFPA 72 and shall contain the following features as applicable:

1. The emergency voice/alarm communication system unit.
2. The Fire Department communications unit.
3. Fire detection and alarm system annunciator unit.
4. Annunciator visually indicating the location of the elevators and whether they are operational.
5. Status indicators and controls for air-handling systems.
6. The fire-fighter's control panel required by Section 909.16 for smoke control systems installed in the building.
7. Controls for unlocking stairway doors simultaneously.
8. Sprinkler valve and water-flow detector display panels.
9. Emergency power status indicators.
10. A telephone for Fire Department use with controlled access to the public telephone system.
11. Fire pump status indicators.
12. Generator supervision devices, manual start and transfer features.
13. Public address system, where specifically required by other sections of this code.
14. Manual controls of Post-Fire Smoke Purge system in accordance with Section 912.2.3.

## **SECTION 912** **POST-FIRE SMOKE PURGE SYSTEMS**

**912.1 Scope and purpose.** The purpose of this section is to establish minimum requirements for the design and installation of post-fire smoke purge systems, which are intended for the timely restoration of operations and overhaul activities once a fire is extinguished. Post-fire smoke purge systems are not intended or designed as life safety

systems and are not required to meet the provisions of Section 909. Post-fire smoke purge systems shall be required in:

1. High-rise buildings subject to Section 403.
2. Buildings with any story exceeding 50,000 square feet (4645 m<sup>2</sup>) in floor area.
3. Building with spaces exceeding 100 feet (30 480 mm) from natural ventilation openings. Natural ventilation openings shall consist of operable windows and doors of at least five percent of the floor area or roof vents per Section 910.
4. High piled stock or rack storage in accordance with the *New York City Fire Code*.

**Exceptions:** A post-fire smoke purge system is not required in R-2 occupancies where either of the following conditions exists:

1. Openable windows. A post-fire smoke purge system is not required where every habitable room located in dwelling units is provided with windows complying with Chapter 12 and all of the following:

- 1.1. Minimum window area. Each required window shall provide at least 12 square feet (1.1 m<sup>2</sup>) of glazed area. The total area of all such windows shall not be less than 10 percent of the floor area of the room or space served.

- 1.2. Minimum openable area. Each required window shall provide a minimum of 6 square feet (0.56 m<sup>2</sup>) of openable area. The total area of all such openings shall not be less than five percent of the floor area of the room or space served. In addition, each required openable area shall be:

- 1.2.1. Located wholly at least 30 inches (762 mm) above the finished floor; and

- 1.2.2. Fully openable to the minimum 6 square feet (0.56 m<sup>2</sup>), at all times and without limiting stops or devices. Such openings may be achieved through the use of double-hung, sliding, or similar types of windows. However, in the event of the use of casement-, hopper-, pivot-, or awning-type windows, such windows shall satisfy the requirements of this section only when they open to at least 75 degrees.

2. Smokeproof enclosures. A post-fire smoke purge system is not required where all exits are constructed as smokeproof enclosures in accordance with Section 1019.1.8.

## **912.2 Post-fire smoke purge systems in occupancy groups other than R-2.**

**912.2.1 General design requirements.** Post-fire smoke purge systems are permitted to use dedicated equipment, the normal building HVAC system or other openings and shall have the capability to exhaust smoke from occupied spaces. Smoke removal may be by either mechanical or natural ventilation, but shall be capable of removing cold smoke. Smoke removed from a space must be discharged to a safe location outside the building and shall not be recirculated into the building in accordance with the *New York City Mechanical Code*.

**912.2.2 Exhaust capability.** The system shall have an air supply and smoke exhaust capability that will provide a minimum of 6 air changes per hour or 1 cubic foot per minute per square foot (cfm/ft<sup>2</sup>) [0.00508 <sup>3</sup>/(s · m<sup>2</sup>)], whichever is greater. The system need not exhaust from all areas at the same time, but is permitted to be zoned based on the largest fire area served. For the purpose of calculating system size, the height of a compartment shall be considered to run from slab to slab and include the volume above suspended ceilings. Provisions shall be made for sufficient make-up air. The provisions may include operable windows, doors, building leakage, or mechanical systems. In buildings having occupied floors located less than 75 feet (22 860 mm) above the lowest level of fire department vehicle access, breakable windows may be utilized.

**912.2.3 Operation.** The post-fire smoke purge system shall be operated by manual controls that are part of the fire command center, in accordance with Section 911, or fire alarm panel when a fire command center is not required. Such control center or panel shall display a graphic indicating the portions of the building served by each post-fire smoke purge system. When a system is zoned into areas of operation less than the entire building, each zone shall have an individual control. Fire Department manual controls of post-fire smoke purge systems shall not override the manual or automatic operation of the smoke control system. Such Fire Department manual controls shall override the fire shutdown signal from the fire alarm system.

**912.3 Post-fire smoke purge systems in occupancy Group R-2.** Post-fire smoke purge systems in R-2 occupancies shall comply with either Section 912.3.1 or 912.3.2. Smoke removed must be discharged to a safe location outside the building and shall not be recirculated into the building in accordance with the *New York City Mechanical Code*.

**912.3.1 Stair ventilation.** The top of all enclosed exit stairs shall be provided with a reversible fan system capable of introducing fresh air or exhausting air at a rate of 6 air changes per hour or 1 cubic foot per minute per square foot (cfm/ft<sup>2</sup>) [0.00508 m<sup>3</sup>/(s · m<sup>2</sup>)], whichever is greater, based on the area of the largest floor. Such system shall be operated by manual controls that are part of the fire command center, as per Section 911, or fire alarm panel when a fire command center is not required. Such control center or panel shall display a graphic indicating the portions of the building served by each post-fire smoke purge system. The operation of such system shall be

controlled by Fire Department personnel by manually opening stair doors at the appropriate story.

**912.3.2 Corridor ventilation.** The ducts and fans that provide fresh air supply to the public corridors in accordance with the *New York City Mechanical Code* shall be provided with reversible fans and duct sizes capable of introducing fresh air to or exhausting air from the corridor at a rate of 6 air changes per hour or 1 cubic foot per minute per square foot (cfm/ft<sup>2</sup>) [0.00508 m<sup>3</sup>/(s · m<sup>2</sup>)], whichever is greater, based on the area of the largest apartment plus the area of the public corridor. Such system shall be operated by manual controls that are part of the fire command center, as per Section 911, or fire alarm panel when a fire command center is not required. Each floor to be ventilated shall be by individual controls. Such control center or panel shall display a graphic indicating the portions of the building served by each post-fire smoke purge system.

**912.4 Maintenance.** The building owner shall maintain post-fire smoke exhaust systems in good operational condition. Records of testing shall be maintained on the premises for inspection by the department and Fire Department personnel.



$$F = F_{dc} + K(WA\Delta P)/2(W - d) \quad \text{(Equation 9-1)}$$

where:

$A$  = Door area, square feet ( $m^2$ ).

$d$  = Distance from door handle to latch edge of door, feet (m).

$F$  = Total door opening force, pounds (N).

$F_{dc}$  = Force required to overcome closing device, pounds (N).

$K$  = Coefficient 5.2 (1.0).

$W$  = Door width, feet (m).

$\Delta P$  = Design pressure difference, inches of water (Pa).

$$v = 217.2 [h(T_f - T_o)/(T_f + 460)]^{1/2} \quad (\text{Equation 9-2})$$

For SI:  $v = 119.9 [h(T_f - T_o)/T_f]^{1/2}$

where:

- $h$  = Height of opening, feet (m).
- $T_f$  = Temperature of smoke, °F (°K).
- $T_o$  = Temperature of ambient air, °F (°K).
- $v$  = Air velocity, feet per minute (m/minute).

$$z_l = 0.533Q_c^{2/5} \quad (\text{Equation 9-3})$$

For SI:  $z_l = 0.166Q_c^{2/5}$

where:

- $m_p$  = Plume mass flow rate, pounds per second (kg/s).
- $Q$  = Total heat output.
- $Q_c$  = Convective heat output, British thermal units per second (kW). (The value of  $Q_c$  shall not be taken as less than  $0.70Q$ ).
- $z$  = Height from top of fuel surface to bottom of smoke layer, feet (m).
- $z_l$  = Limiting flame height, feet (m). The  $z_l$  value must be greater than the fuel equivalent diameter (see Section 909.9).

for  $z > z_l$

$$m_p = 0.022Q_c^{1/3}z^{5/3} + 0.0042Q_c$$

For SI:  $m_p = 0.071 Q_c^{1/3}z^{5/3} + 0.0018Q_c$

for  $z = z_l$

$$m_p = 0.011 Q_c$$

For SI:  $m_p = 0.035Q_c$

for  $z < z_l$

$$m_p = 0.0208Q_c^{3/5}z$$

For SI:  $m_p = 0.032Q_c^{3/5}z$

To convert  $m_p$  from pounds per second of mass flow to a volumetric rate, the following equation shall be used:

$$V = 60 m_p / \rho \quad (\text{Equation 9-4})$$

where:

- $V$  = Volumetric flow rate, cubic feet per minute (m<sup>3</sup>/s).
- $\rho$  = Density of air at the temperature of the smoke layer, pounds per cubic feet ( $T$ : in °F) [kg/m<sup>3</sup> ( $T$ : in °C)].

$$m_p = 0.124(QW^2)^{1/3}(z_b + 0.25H) \quad (\text{Equation 9-5})$$

For SI:  $m_p = 0.36(QW^2)^{1/3}(z_b + 0.25H)$

where:

- $H$  = Height above fire to underside of balcony, feet (m).
- $m_p$  = Plume mass flow rate, pounds per second (kg/s).
- $Q$  = Total heat output.
- $W$  = Plume width at point of spill, feet (m).
- $z_b$  = Height from balcony, feet (m).

$$m_p = 0.077(A_w H_w^{1/2})^{1/3}(z_w + a)^{5/3} + 0.18A_w H_w^{1/2} \quad (\text{Equation 9-6})$$

For SI:  $m_p = 0.68(A_w H_w^{1/2})^{1/3}(z_w + a)^{5/3} + 1.5A_w H_w^{1/2}$

where:

- $A_w$  = Area of the opening, square feet (m<sup>2</sup>).
- $H_w$  = Height of the opening, feet (m).
- $m_p$  = plume mass flow rate, pounds per second (kg/s).
- $z_w$  = Height from the top of the window or opening to the bottom of the smoke layer, feet (m).
- $a$  =  $2.4A_w^{2/5}H_w^{1/5} - 2.1H_w$

$$d = 0.48 [(T_c + 460)/(T_a + 460)]^{1/2} z \quad (\text{Equation 9-7})$$

For SI:  $d = 0.48 (T_c/T_a)^{1/2} z$

where:

- $d$  = Plume diameter, feet (m).
- $T_a$  = Ambient air temperature, °F (°K).
- $T_c$  = Plume centerline temperature, °F (°K).  
=  $0.60 (T_a + 460) Q_c^{2/3} z^{-5/3} + T_a$
- $z$  = Height at which  $T_c$  is determined, feet (m).

For SI:  $T_c = 0.08 T_a Q_c^{2/3} z^{-5/3} + T_a$

$$R = [Q/(12\pi q'' )]^{1/2} \quad (\text{Equation 9-8})$$

where:

- $q''$  = Incident radiant heat flux required for nonpiloted ignition, Btu/ft<sup>2</sup> · s (W/m<sup>2</sup>).
- $Q$  = Heat release from fire, Btu/s (kW).
- $R$  = Separation distance from target to center of fuel package, feet (m).

$$T_s = (Q_c / mc) + (T_a) \quad \text{(Equation 9-9)}$$

where:

$c$  = Specific heat of smoke at smoke layer temperature, Btu/lb°F (kJ/kg · K).

$m$  = Exhaust rate, pounds per second (kg/s).

$Q_c$  = Convective heat output of fire, Btu/s (kW).

$T_a$  = Ambient temperature, °F (°K).

$T_s$  = Smoke temperature, °F (°K).

$$C = A \times 300 \quad \text{(Equation 9-10)}$$

where:

$C$  = Capacity of mechanical ventilation required, in cubic feet per minute (m<sup>3</sup>/s).

$A$  = Area of roof vents provided in square feet (m<sup>2</sup>) in accordance with Table 910.3.

**[F] TABLE 903.2.4.2  
GROUP H-5 SPRINKLER DESIGN CRITERIA**

LOCATION	OCCUPANCY HAZARD CLASSIFICATION
Fabrication areas	Ordinary Hazard Group 2
Service corridors	Ordinary Hazard Group 2
Storage rooms without dispensing	Ordinary Hazard Group 2
Storage rooms with dispensing	Extra Hazard Group 2
Corridors	Ordinary Hazard Group 2

**TABLE 903.2.13  
ADDITIONAL REQUIRED SUPPRESSION SYSTEMS**

SECTION	SUBJECT
402.8	Covered malls
403.2, 403.3	High-rise buildings
404.3	Atriums
405.3	Underground structures
407.5	Group I-2
410.6	Stages
411.4	Special amusement buildings
415.7.2.4	Group H-2
416.4	Flammable finishes
417.4	Drying rooms
507	Unlimited area buildings
NYCFC	NFPA-13 as modified for NYC

**[F] TABLE 907.9.1.3  
VISIBLE AND AUDIBLE ALARMS**

NUMBER OF SLEEPING UNITS	SLEEPING UNITS WITH VISIBLE AND AUDIBLE ALARMS
6 to 25	2
26 to 50	4
51 to 75	7
76 to 100	9
101 to 150	12
151 to 200	14
201 to 300	17
301 to 400	20
401 to 500	22
501 to 1,000	5% of total
1,001 and over	50 plus 3 for each 100 over 1,000

**TABLE 909.6.1**  
**MINIMUM PRESSURE DIFFERENCES ACROSS SMOKE BARRIERS**

<b><u>Ceiling Height</u></b>	<b><u>Minimum Design Pressure Difference</u></b>
Less than 15 feet (4572 mm)	0.10-inch water gage (0.0259 kPa)
Equal to or greater than 15 feet (4572 mm), but less than 21 feet (6401 mm)	0.14-inch water gage (0.0349 kPa)
Equal to or greater than 21 feet (6401mm)	0.18-inch water gage (0.0448 kPa)

**TABLE 910.3  
REQUIREMENTS FOR DRAFT CURTAINS AND SMOKE AND HEAT VENTS<sup>a</sup>**

<u>OCCUPANCY GROUP AND COMMODITY CLASSIFICATION</u>	<u>DESIGNATED STORAGE HEIGHT (feet)</u>	<u>MINIMUM DRAFT CURTAIN DEPTH (feet)</u>	<u>MAXIMUM AREA FORMED BY DRAFT CURTAINS (square feet)</u>	<u>VENT AREA TO FLOOR AREA RATIO</u>	<u>MAXIMUM SPACING OF VENT CENTERS (feet)</u>	<u>MAXIMUM DISTANCE TO VENTS FROM WALL OR DRAFT CURTAINS<sup>b</sup> (feet)</u>
Group F-1	=	$0.2 \times H$ but $\geq 4$	50,000	1:100	120	60
Group S-1 I-IV (Option 1)	$\leq 20$	6	10,000	1:100	100	60
	$\geq 20 < 40$	6	8,000	1:75	100	55
Group S-1 I-IV (Option 2)	$\leq 20$	4	3,000	1:75	100	55
	$> 20 < 40$	4	3,000	1:50	100	50
Group S-1 High hazard (Option 1)	$\leq 20$	6	6,000	1:50	100	50
	$\geq 20 < 30$	6	6,000	1:40	90	45
Group S-1 High hazard (Option 2)	$\leq 20$	4	4,000	1:50	100	50
	$> 20 \leq 30$	4	2,000	1:30	75	40

For SI: 1 foot = 304.8 mm, 1 square foot = 0.0929 m<sup>2</sup>.

- a. Requirements for rack storage heights in excess of those indicated shall be in accordance with the *New York City Fire Code*. For solid-piled storage heights in excess of those indicated, an approved engineered design shall be used.
- b. The distance specified is the maximum distance from any vent in a particular draft curtained area to walls or draft curtains which form the perimeter of the draft curtained area.

**CHAPTER 10**  
**MEANS OF EGRESS**

**SECTION BC 1001**  
**ADMINISTRATION**

**1001.1 General.** Buildings or portions thereof shall be provided with a means of egress system as required by this chapter. The provisions of this chapter shall control the design, construction and arrangement of means of egress components required to provide an approved means of egress from structures and portions thereof.

**1001.2 Minimum requirements.** It shall be unlawful to alter a building or structure in a manner that will reduce the number of exits or the capacity of the means of egress to less than required by this code.

**1001.3 Maintenance.** Means of egress shall be maintained in accordance with the *New York City Fire Code*.

**1001.4 Inadequate exits for existing structures.** Every existing structure which is not provided with means of egress as required by this chapter and, in which the means of egress are, in the opinion of the commissioner inadequate for the safety of the occupants, shall be provided with means of egress or fire protection as directed by the commissioner.

**SECTION BC 1002**  
**DEFINITIONS**

**1002.1 Definitions.** The following words and terms shall, for the purpose of this chapter and as used elsewhere in this code, have the meaning shown herein.

**ACCESSIBLE MEANS OF EGRESS.** A continuous and unobstructed way of egress travel from any accessible point in a building or facility to a public way. Such way of egress travel may include an assisted rescue path.

**AISLE ACCESSWAY.** That portion of an exit access that leads to an aisle.

**ALTERNATING TREAD DEVICE.** A device that has a series of steps between 50 and 70 degrees (0.87 and 1.22 rad) from horizontal, usually attached to a center support rail in an alternating manner so that the user does not have both feet on the same level at the same time.

**AREA OF REFUGE.** A floor area to which egress is made through a horizontal exit.

**AREA OF RESCUE ASSISTANCE.** An area where persons unable to use stairways can remain temporarily to await instructions or assistance during emergency evacuation.

**ASSISTED RESCUE PATH.** A portion of the accessible means of egress which begins at the area of rescue assistance and terminates at the public way.

**BLEACHERS.** Tiered seating facilities.

**COLLECTING SAFE AREA.** A safe area that receives occupants from the assembly space it serves, as well as from other safe areas.

**COMMON PATH OF EGRESS TRAVEL.** That portion of exit access which the occupants are required to traverse before two separate and distinct paths of egress travel to two exits are available. Paths that merge are common paths of travel. Common paths of egress travel shall be included within the permitted travel distance.

**CORRIDOR.** An enclosed exit access component that defines and provides a path of egress travel to an exit. Corridors shall be either interior or public.

**CORRIDOR, INTERIOR.** A corridor that serves only one tenant. In Group E occupancies, corridors serving only one institution shall be deemed as serving a single tenant.

**CORRIDOR, PUBLIC.** A corridor that serves more than one tenant.

**CROSS AISLE.** An aisle in a place of assembly usually parallel to rows of seats, connecting other aisles or connecting an aisle and an exit.

**DEAD END.** A portion of a corridor in which the travel to an exit is in one direction only.

**DOOR, BALANCED.** A door equipped with double-pivoted hardware so designed as to cause a semicounterbalanced swing action when opening.

**EGRESS COURT.** A court or yard which provides access to a public way for one or more exits.

**EMERGENCY ESCAPE AND RESCUE OPENING.** An operable window, door or other similar device that provides for a means of escape and access for rescue in the event of an emergency.

**EXIT.** That portion of a means of egress system, which is separated from other interior spaces of a building or structure by fire-resistance-rated construction and opening protective as required to provide a protected path of egress travel between the exit access and the exit discharge. Exits include vertical exits, exterior exit doors at ground level, exit enclosures, exit passageways, exterior exit stairs, exterior exit ramps and horizontal exits, but do not include access stairs, aisles, exit access doors opening to corridors or corridors.

**EXIT ACCESS.** That portion of a means of egress system that leads from any occupied portion of a building or structure to an exit.

**EXIT DISCHARGE.** That portion of a means of egress system between the termination of an exit and a public way.



**EXIT DISCHARGE, LEVEL OF.** The horizontal plane located at the point at which an exit terminates and an exit discharge begins.

**EXIT ENCLOSURE.** An exit component that is separated from other interior spaces of a building or structure by fire-resistance-rated construction and opening protective, and provides for a protected path of egress travel in a vertical or horizontal direction to the exit discharge or the public way.

**EXIT, HORIZONTAL.** An exit that provides a path of egress travel from one building to an area in another building on approximately the same level, or a path of egress travel through or around a wall or partition to an area on approximately the same level in the same building, or a bridge or tunnel between two buildings, which affords safety from fire and smoke from the area of incidence and areas communicating therewith.

**EXIT PASSAGEWAY.** An exit component that is separated from all other interior spaces of a building or structure by fire-resistance-rated construction and opening protective, and provides for a protected path of egress travel in a horizontal direction to the exit discharge or the public way.

**FIRE EXIT HARDWARE.** Panic hardware that is listed for use on fire door assemblies.

**FLOOR AREA, GROSS.** The floor area within the inside perimeter of the exterior walls of the building under consideration, exclusive of courts, without deduction for corridors, stairways, closets, the thickness of interior walls, columns or other features. The floor area of a building, or portion thereof, not provided with surrounding exterior walls shall be the usable area under the horizontal projection of the roof or floor above. The gross floor area shall not include interior courts.

**FLOOR AREA, NET.** The actual occupied area not including the thickness of walls, partitions, columns, furred-in spaces, fixed cabinets, equipment, and unoccupied accessory areas such as corridors, stairways, toilet rooms, mechanical rooms and closets.

**FOLDING AND TELESCOPIC SEATING.** Tiered seating facilities having an overall shape and size that are capable of being reduced for purposes of moving or storing.

**GRANDSTAND.** Tiered seating facilities.

**GUARD.** A building component or a system of building components located at or near the open sides of elevated walking surfaces that minimizes the possibility of a fall from the walking surface to a lower level.

**HANDRAIL.** A horizontal or sloping rail intended for grasping by the hand for guidance or support.

**MEANS OF EGRESS.** A continuous and unobstructed path of vertical and horizontal

egress travel from any occupied portion of a building or structure to a public way. A means of egress consists of three separate and distinct parts: the exit access, the exit and the exit discharge.

**NOSING.** The leading edge of treads of stairs and of landings at the top of stairway flights.

**OCCUPANT LOAD.** The number of persons for which the means of egress of a building or portion thereof is designed.

**OPEN EXTERIOR SPACE.** A street or other public space; or a yard, court, or plaza open on one or more sides and unroofed or open on all sides, which provides egress to a street or public space.

**PANIC HARDWARE.** A door-latching assembly incorporating a device that releases the latch upon the application of a force in the direction of egress travel.

**PUBLIC WAY.** A street, alley or other parcel of land open to the outside air leading to a street, that has been deeded, dedicated or otherwise permanently appropriated to the public for public use and which has a clear width and height of not less than 10 feet (3048 mm).

**RAMP.** A walking surface that has a running slope steeper than one unit vertical in 20 units horizontal (5-percent slope).

**SAFE AREA.** An interior or exterior space that serves as a means of egress by providing a transitional area from, and that also serves as a normal means of entry to, an assembly space.

**SCISSOR STAIR.** Two interlocking stairways providing two separate paths of egress located within one stairwell enclosure.

**SEATING SECTION.** An area of seating bounded on all sides by aisles, cross aisles, walls, or partitions.

**SMOKE-PROTECTED ASSEMBLY SEATING.** Seating served by means of egress that is not subject to smoke accumulation within or under a structure.

**STAIR.** A change in elevation, consisting of two or more risers.

**STAIRWAY.** One or more flights of stairs, either exterior or interior, with the necessary landings and platforms connecting them, to form a continuous and uninterrupted passage from one level to another.

**STAIRWAY, EXTERIOR.** A stairway that is open on at least one side, except for required structural columns, beams, handrails and guards. The adjoining open areas shall be either yards, courts or public ways. The other sides of the exterior stairway need not be

open.

**STAIRWAY, INTERIOR.** A stairway not meeting the definition of an exterior stairway.

**STAIRWAY, SPIRAL.** A stairway having a closed circular form in its plan view with uniform section-shaped treads attached to and radiating from a minimum-diameter-supporting column.

**WINDER.** A stair tread with nonparallel edges.

## **SECTION BC 1003** **GENERAL MEANS OF EGRESS**

**1003.1 Applicability.** The general requirements specified in Sections 1003 through 1012 shall apply to all three elements of the means of egress system, in addition to those specific requirements for the exit access, the exit and the exit discharge detailed elsewhere in this chapter.

**1003.2 Ceiling Height.** The means of egress shall have a ceiling height of not less than 7 feet, 6 inches (2286 mm).

### **Exceptions:**

1. Ceilings that are permitted to be less than 7 feet, 6 inches (2286 mm) in accordance with Section 1208.2.
2. Ceilings of dwelling units and sleeping units within residential occupancies in accordance with Section 1208.2.
3. Allowable projections in accordance with Section 1003.3.
4. Stair headroom in accordance with Section 1009.2.
5. Door height in accordance with Section 1008.1.1.3.

**1003.3 Protruding objects.** Protruding objects shall comply with the requirements of Sections 1003.3.1 through 1003.3.4.

**1003.3.1 Headroom.** Protruding objects are permitted to extend below the minimum ceiling height required by Section 1003.2 provided a minimum headroom of 84 inches (2134 mm) shall be provided for any walking surface, including walks, corridors, aisles and passageways. Not more than 50 percent of the ceiling area of a means of egress shall be reduced in height by protruding objects.

**Exception:** Door closers and stops shall not reduce headroom to less than 78

inches (1981 mm).

A barrier shall be provided where the vertical clearance is less than 80 inches (2032 mm) high. The leading edge of such a barrier shall be located 27 inches (686 mm) maximum above the floor.

**1003.3.2 Free-standing objects.** A free-standing object mounted on a post or pylon shall not overhang that post or pylon more than 12 inches (305 mm) where the lowest point of the leading edge is more than 27 inches (686 mm) and less than 80 inches (2032 mm) above the walking surface. Where a sign or other obstruction is mounted between posts or pylons and the clear distance between the posts or pylons is greater than 12 inches (305 mm), the lowest edge of such sign or obstruction shall be 27 inches (685 mm) maximum or 80 inches (2030 mm) minimum above the finish floor or ground. Free-standing objects shall not reduce the required width of the means of egress.

**Exception:** This requirement shall not apply to sloping portions of handrails serving stairs and ramps.

**1003.3.3 Horizontal projections.** Structural elements, fixtures or furnishings shall not project horizontally from either side more than 4 inches (102 mm) over any walking surface between the heights of 27 inches (686 mm) and 80 inches (2032 mm) above the walking surface.

**Exception:** Handrails serving stairs and ramps are permitted to protrude 4.5 inches (114 mm) from the wall.

**1003.3.4 Clear width.** Protruding objects shall not reduce the minimum clear width of accessible routes as required by Section 1104.

**1003.4 Floor surface.** Walking surfaces of the means of egress shall have a slip-resistant surface and be securely attached.

**1003.5 Elevation change.** Where changes in elevation of less than 12 inches (305 mm) exist in the means of egress, sloped surfaces shall be used. Where the slope is greater than one unit vertical in 20 units horizontal (5-percent slope), ramps complying with Section 1010 shall be used. Where the difference in elevation is 6 inches (152 mm) or less and the ramp is not equipped with handrails, the floor finish materials shall contrast with adjacent floor finish materials.

**Exceptions. At locations that are not required to be accessible by Chapter 11:**

1. A single step with a maximum riser height of 7 inches (178 mm) is permitted for buildings with occupancies in:

1.1. Groups F, H, R-2 and R-3, and

1.2. Groups S and U at exterior doors.

2. A step with a single riser or a stair with two risers and a tread is permitted provided that the risers and treads comply with Section 1009.3, the minimum depth of the tread is 13 inches (330 mm) and at least one handrail complying with Section 1009.11 is provided within 30 inches (762 mm) of the centerline of the normal path of egress travel on the stair.
3. An aisle serving seating that has a difference in elevation less than 12 inches (305 mm) is permitted provided that the risers and treads comply with Section 1024.11 and the aisle is provided with a handrail complying with Section 1024.13.

Any change in elevation in a corridor serving nonambulatory persons in a Group I-2 occupancy shall be by means of a ramp or sloped walkway.

**1003.6 Means of egress continuity.** The path of egress travel along a means of egress shall not be interrupted by any building element other than a means of egress component as specified in this chapter. Obstructions shall not be placed in the required width of a means of egress except projections permitted by this chapter. The required capacity of a means of egress system shall not be diminished along the path of egress travel.

**1003.7 Elevators, escalators and moving walks.** Elevators, escalators and moving walks shall not be used as a component of a required means of egress from any other part of the building.

**Exception:** Elevators used as a component of an accessible means of egress in accordance with Section 1007.4.

## **SECTION BC 1004** **OCCUPANT LOAD**

**1004.1 Design occupant load.** In determining means of egress requirements, the number of occupants for whom means of egress facilities shall be provided shall be established by the largest number computed in accordance with Sections 1004.1.1 through 1004.1.3.

**1004.1.1 Actual number.** The actual number of occupants for whom each occupied space, floor or building is designed.

**1004.1.2 Number by Table 1004.1.2.** The number of occupants computed at the rate of one occupant per unit of area as prescribed in Table 1004.1.2.

**1004.1.3 Number by combination.** Where occupants from accessory spaces egress through a primary area, the calculated occupant load for the primary space shall include the total occupant load of the primary space plus the number of occupants

egressing through it from the accessory space.

**1004.1.4 Modifications.** Where the actual number of occupants of any space will be significantly lower than listed in Table 1004.1.2, the commissioner may establish a lower basis for the determination of the number of occupants.

**1004.1.5 Unlisted occupancies.** Where data regarding the square feet area per person for an occupancy is not listed in Table 1004.1.2, the occupant load shall be established by a registered design professional, subject to the approval of the commissioner.

**TABLE 1004.1.2**  
**MAXIMUM FLOOR AREA ALLOWANCES PER OCCUPANT**  
**(Table 1004.1.2 attached to end of document)**

**1004.2 Increased occupant load.** The occupant load permitted in any building or portion thereof is permitted to be increased from that number established for the occupancies in Table 1004.1.2 provided that all other requirements of the code are also met based on such modified number and the occupant load shall not exceed one occupant per 5 square feet (0.47 m<sup>2</sup>) of occupiable floor space. Where required by the commissioner, an approved aisle, seating or fixed equipment diagram substantiating any increase in occupant load shall be submitted. Where required by the commissioner, such diagram shall be posted.

**1004.3 Posting of occupant load.** Every room or space that is an assembly occupancy shall have the occupant load of the room or space posted in a conspicuous place, near the main exit or exit access doorway from the room or space. Posted signs shall be of an approved legible permanent design and shall be maintained by the owner or authorized agent. Such sign shall also comply with Section 1024.1.2.

**1004.4 Exiting from multiple levels.** Where exits serve more than one floor, only the occupant load of each floor considered individually shall be used in computing the required capacity of the exits at that floor, provided that the exit capacity shall not decrease in the direction of egress travel.

**1004.5 Egress convergence.** Where means of egress from floors above and below converge at an intermediate level, the capacity of the means of egress from the point of convergence shall not be less than the sum of the two floors.

**1004.6 Mezzanine levels.** The occupant load of a mezzanine level with egress onto a room or area below shall be added to that room or area's occupant load, and the capacity of the exits shall be designed for the total occupant load thus established.

**1004.7 Fixed seating.** For areas having fixed seats and aisles, the occupant load shall be determined by the number of fixed seats installed therein. For areas having fixed seating without dividing arms, the occupant load shall not be less than the number of seats based on one person for each 18 inches (457 mm) of seating length. The occupant load of

seating booths shall be based on one person for each 24 inches (610 mm) of booth seat length measured at the backrest of the seating booth.

**1004.8 Outdoor areas.** Yards, patios, courts and similar outdoor areas accessible to and usable by the building occupants shall be provided with means of egress as required by this chapter. The occupant load of such outdoor areas shall be determined by the design professional subject to the approval of the commissioner. Where outdoor areas are to be used by persons in addition to the occupants of the building, and the path of egress travel from the outdoor areas passes through the building, means of egress requirements for the building shall be based on the sum of the occupant loads of the building plus the outdoor areas.

**Exceptions:**

1. Outdoor areas used exclusively for service of the building need only have one means of egress.
2. Both outdoor areas associated with Group R-3 and individual dwelling units of Group R-2.

**1004.9 Multiple occupancies.** Where a building contains two or more occupancies, the means of egress requirements shall apply to each portion of the building based on the occupancy of that space. Where two or more occupancies utilize portions of the same means of egress system, those egress components shall meet the more stringent requirements of all occupancies that are served.

**SECTION BC 1005**  
**EGRESS WIDTH**

**1005.1 Minimum required egress width.** The means of egress width shall not be less than that required by this section. The total width of means of egress in inches (mm) shall not be less than the total occupant load served by the means of egress multiplied by the factors in Table 1005.1 and not less than specified elsewhere in this code. Multiple means of egress shall be sized such that the loss of any one means of egress shall not reduce the available capacity to less than 50 percent of the required capacity. The maximum capacity required from any story of a building shall be maintained to the termination of the means of egress.

**Exception:** Means of egress complying with Section 1024.

**TABLE 1005.1**  
**EGRESS WIDTH PER OCCUPANT SERVED**  
**(Table 1005.1 attached to end of document)**

**1005.2 Door encroachment.** Doors opening into the path of egress travel shall not reduce the required width to less than one-half during the course of the swing. When fully open, the door shall not project more than 7 inches (178 mm) into the required width.

**Exception:** The restrictions on a door swing shall not apply to doors within individual dwelling units and sleeping units of Group R-2 and dwelling units of Group R-3.

## **SECTION BC 1006** **MEANS OF EGRESS ILLUMINATION**

**1006.1 Illumination Required.** Exits, exit discharges and public corridors shall be illuminated at all times. Exit access components shall be illuminated at all times during occupancy.

**Exceptions:**

1. Occupancies in Group U.
2. Aisle accessways in Group A.
3. Dwelling units and sleeping units in Groups I-1, R-1, R-2 and R-3.
4. Sleeping units of Group I occupancies.

**1006.2 Illumination level.** The means of egress illumination level shall not be less than 2 foot-candles (22 lux) at the floor level in exits, at exit discharges, and in public corridors, and shall not be less than 1 foot-candle (11 lux) at the floor level in exit access components other than public corridors.

**Exceptions:**

1. For auditoriums, theaters, concert or opera halls and similar assembly occupancies, the illumination at the floor level is permitted to be reduced during performances to not less than 0.5 foot-candle (5.38 lux) for aisles and cross aisles, and 0.2 foot-candle (2.15 lux) for other portions of the space, provided that the required illumination is automatically restored upon activation of a premise's fire alarm system where such system is provided. Step lights shall be provided in accordance with Section 1024.11.4.
2. Safe areas in assembly occupancies shall be illuminated in accordance with Section 1024.17.3.2.
3. Open exterior spaces used to receive occupants as Class 1 or Class 2 exits in assembly occupancies shall be illuminated in accordance with Section 1024.17.4.

**1006.3 Illumination emergency power.** The power supply for means of egress illumination shall normally be provided by the premise's electrical supply.



In the event of power supply failure, an emergency electrical system shall automatically illuminate the following areas:

1. Exit access corridors, passageways and aisles in rooms and spaces which require two or more means of egress.
2. Exit access corridors, exit passageways and exit stairways located in buildings required to have two or more exits.
3. Exterior egress components at other than the level of exit discharge until exit discharge is accomplished for buildings required to have two or more exits.
4. Interior exit discharge elements, as permitted in Section 1023.1, in buildings required to have two or more exits.
5. The portion of the exterior exit discharge immediately adjacent to exit discharge doorways in buildings required to have two or more exits.

**1006.3.1 Emergency power source.** The emergency power system shall provide power for a duration of not less than 90 minutes and shall consist of storage batteries, unit equipment or an on-site generator. The installation of the emergency power system shall be in accordance with Section 2702.

**1006.3.2 Performance of system.** Emergency lighting facilities shall be arranged to provide initial illumination that is at least an average of 2 foot-candle (22 lux) and a minimum at any point of 0.2 foot-candle (2.15 lux) measured along the path of egress at floor level. Illumination levels shall be permitted to decline to 0.6 foot-candle (6.46 lux) average and a minimum at any point of 0.06 foot-candle (0.646 lux) at the end of the emergency lighting time duration. A maximum-to-minimum illumination uniformity ratio of 40 to 1 shall not be exceeded.

**1006.4 Reserved.**

## **SECTION BC 1007** **ACCESSIBLE MEANS OF EGRESS**

**1007.1 Accessible means of egress required.** Accessible means of egress shall comply with this section. Accessible spaces shall be provided with not less than one accessible means of egress. Where more than one means of egress is required by Section 1014.1 or 1018.1 from any accessible space, at least two accessible means of egress shall be provided to each accessible portion of the space.

### **Exceptions:**

1. Accessible means of egress are not required in alterations to existing buildings where the level of alterations does not trigger full compliance of accessibility pursuant to Section 28-101.4 of this code.

2. One accessible means of egress is required from an accessible mezzanine level in accordance with Section 1007.3 or 1007.4.
3. In assembly spaces with sloped floors, one accessible means of egress is required from a space where the common path of travel of the accessible route for access to the wheelchair spaces meets the requirements in Section 1024.8.

**1007.2 Continuity and components.** Each required accessible means of egress shall be continuous to a public way and shall consist of one or more of the following components:

1. Interior accessible routes complying with Section 1104.
2. Area of rescue assistance complying with Section 1007.6.
3. Stairways within vertical exit enclosures complying with Sections 1007.3 and 1019.1.
4. Exterior exit stairways complying with Sections 1007.3 and 1022.
5. Elevators complying with Section 1007.4.
6. Platform lifts complying with Section 1007.5.
7. Horizontal exits complying with Section 1021.
8. Ramps complying with Section 1010.
9. Exit discharges complying with Section 1023.
10. Exterior accessible routes complying with Section 1104.
11. Exterior areas of assisted rescue complying with Section 1007.8.

**1007.2.1 High-rise buildings.** In high-rise buildings at least one required accessible means of egress shall be an elevator complying with Section 1007.4.

**Exceptions:**

1. In buildings equipped throughout with an automatic sprinkler system installed in accordance with Section 903.3.1.1 or 903.3.1.2, the elevator shall not be required on floors provided with a horizontal exit located at or above the level of exit discharge.
2. In buildings equipped throughout with an automatic sprinkler system installed in accordance with Section 903.3.1.1 or 903.3.1.2, the elevator shall not be required on floors provided with a ramp conforming to the

provisions of Section 1010.

3. In buildings of occupancy Group R-2 not subject to the requirements of emergency power in Section 403 of this code.

**1007.2.2 Exit discharge.** Where an exit discharge is not accessible, an exterior area for assisted rescue shall be provided in accordance with Section 1007.8. An exterior area for assisted rescue shall not be required where an exit discharge is on an assisted rescue path from a stairway or an elevator.

**1007.2.3 Exterior exit stairway.** Where an exit stairway is open to the exterior, the accessible means of egress shall include either an area of rescue assistance in accordance with Section 1007.6 or an exterior area for assisted rescue in accordance with Section 1007.8.

**1007.3 Exit stairways.** To be considered part of an accessible means of egress, an exit stairway shall have a clear width of 48 inches (1219 mm) minimum between handrails and shall either incorporate an area of rescue assistance within an enlarged floor-level landing or shall be accessed from either an area of rescue assistance complying with Section 1007.6 or a horizontal exit.

Unenclosed exit stairways as permitted by Section 1019.1 are permitted to be considered part of an accessible means of egress.

**Exceptions.** The following exceptions apply to the requirements of clear width and area of rescue assistance, and do not supersede the other requirements of the accessible means of egress:

1. The area of rescue assistance is not required at unenclosed stairways that are permitted by Section 1019.1 in buildings or facilities that are equipped throughout with an automatic sprinkler system installed in accordance with Section 903.3.1.1.
2. The clear width of 48 inches (1219 mm) between handrails and the area of rescue assistance is not required at exit stairways in buildings or facilities equipped throughout with an automatic sprinkler system installed in accordance with Section 903.3.1.1 or 903.3.1.2.
3. The clear width of 48 inches (1219 mm) between handrails is not required for enclosed exit stairways accessed from a horizontal exit.
4. Areas of rescue assistance are not required at exit stairways serving open parking garages

**1007.4 Elevators.** To be considered part of an accessible means of egress, an elevator shall comply with the emergency operation and signaling device requirements of Section 2.27 of ASME A17.1 and Section 1109.6. Emergency power shall be provided in

accordance with Sections 2702 and 3003. The elevator shall be accessed from either an area of rescue assistance complying with Section 1007.6 or a horizontal exit complying with Section 1021.

**Exceptions:**

1. Elevators are not required to be accessed from an area of rescue assistance or horizontal exit in open parking garages.
2. Elevators are not required to be accessed from an area of rescue assistance or horizontal exit in buildings and facilities equipped throughout with an automatic sprinkler system installed in accordance with Section 903.3.1.1 or 903.3.1.2.

**1007.5 Platform lifts.** Platform (wheelchair) lifts shall not serve as part of an accessible means of egress, except where allowed as part of a required accessible route in Section 1109.7. Platform lifts shall be installed in accordance with ASME A18.1. Emergency power shall be provided in accordance with Section 2702 for platform lifts permitted to serve as part of an accessible means of egress.

**1007.6 Areas of rescue assistance.** Every required area of rescue assistance shall be accessible from the space it serves by one or more accessible means of egress components as listed in Section 1007.2. The maximum travel distance from any accessible space to an area of rescue assistance shall not exceed the travel distance permitted for the occupancy in accordance with Section 1015.1. Every required area of rescue assistance shall have direct access to an enclosed stairway complying with Sections 1007.3 and 1019.1 or an elevator complying with Section 1007.4. Where an elevator lobby is used as an area of rescue assistance, the shaft and lobby shall comply with Section 1019.1.8 for smokeproof enclosures except where the elevators are in an area of rescue assistance, such lobby shall be part of a horizontal exit or protected by smoke barrier.

**1007.6.1 Size.** Each area of rescue assistance shall be sized to accommodate one wheelchair space of 30 inches by 48 inches (762 mm by 1219 mm) for each 200 occupants or portion thereof, based on the occupant load of the area of rescue assistance and areas served by the area of rescue assistance. Such wheelchair spaces shall not reduce the required means of egress width. Access to any of the required wheelchair spaces in an area of rescue assistance shall not be obstructed by more than one adjoining wheelchair space.

**1007.6.2 Separation.** Each area of rescue assistance shall be separated from the remainder of the story by a smoke barrier complying with Section 709. Each area of rescue assistance shall be designed to minimize the intrusion of smoke.

**Exceptions.** Areas of rescue assistance need not be protected with smoke barrier where:

1. Areas of rescue assistance is located within a stairway enclosure.
2. Sprinkler protection is provided in the areas of rescue assistance and all the areas it serves in accordance with Section 903.3.1.1 or 903.3.1.2.

**1007.6.3 Two-way communication.** Areas of rescue assistance shall be provided with a two-way communication system between the areas of rescue assistance and a central control point. If the central control point is not constantly attended, the area of rescue assistance shall also have controlled access to a public telephone system. Location of the central control point shall be approved by the Fire Department. The two-way communication system shall include both audible and visible signals.

**1007.6.4 Instructions.** In areas of rescue assistance that have a two-way emergency communications system, instructions on the use of the area under emergency conditions shall be posted adjoining the communications system. The instructions shall include all of the following:

1. Directions to find other means of egress.
2. Persons able to use the exit stairway do so as soon as possible, unless they are assisting others.
3. Information on planned availability of assistance in the use of stairs or supervised operation of elevators and how to summon such assistance.
4. Directions for use of the emergency communications system.

**1007.6.5 Identification.** Each door providing access to an area of rescue assistance from an adjacent floor area shall be identified by a sign complying with ICC A117.1, stating: AREA OF RESCUE ASSISTANCE, and including the International Symbol of Accessibility. The area of rescue assistance sign shall be illuminated in accordance with Section 1011.2. Additionally, tactile signage complying with ICC A117.1 shall be located at each door to an area of rescue assistance.

**1007.7 Signage.** Signage shall be installed indicating the location of an accessible means of egress at those exits and elevators serving required accessible spaces that are not accessible means of egress.

**1007.8 Exterior area for assisted rescue.** The exterior area for assisted rescue must be open to the outside air and meet the requirements of Section 1007.6.1. Separation walls shall comply with the requirements of Section 704 for exterior walls. All walls or openings within 10 feet (3048 mm) horizontally of the perimeter of the exterior area for assisted rescue shall be constructed as required for a minimum 1-hour fire-resistance rating with  $\frac{3}{4}$ -hour opening protectives. Such construction shall extend 10 feet (3048 mm) vertically above the floor level of the exterior area for assisted rescue or to the roof line, whichever is lower.

**1007.8.1 Openness.** The exterior area for assisted rescue shall be at least 50 percent open, and the open area above the guards shall be so distributed as to minimize the accumulation of smoke or toxic gases.

**1007.8.2 Exterior exit stairway.** Exterior exit stairways that are part of the accessible means of egress for the exterior area for assisted rescue shall provide a clear width of 48 inches (1219 mm) between handrails.

**1007.8.3 Identification.** Exterior areas for assisted rescue shall have identification as required for area of rescue assistance that complies with Section 1007.6.5.

## **SECTION BC 1008** **DOORS, GATES AND TURNSTILES**

**1008.1 Doors.** Means of egress doors shall meet the requirements of this section. Doors serving a means of egress system shall meet the requirements of this section and Section 1017.2. Doors provided for egress purposes in numbers greater than required by this code shall meet the requirements of this section.

Means of egress doors shall be readily distinguishable from the adjacent construction and finishes such that the doors are easily recognizable as doors. Mirrors or similar reflecting materials shall not be used on means of egress doors. Means of egress doors shall not be concealed by curtains, drapes, decorations or similar materials.

**1008.1.1 Size of doors.** The minimum width and height of each door opening shall be in accordance with this section.

**1008.1.1.1 Door width.** The minimum width of each door opening shall be sufficient for the occupant load thereof and shall provide a clear width of not less than 32 inches (813 mm). Clear openings of doorways with swinging doors shall be measured between the face of the door and the stop, with the door open 90 degrees (1.57 rad). Where this section requires a minimum clear width of 32 inches (813 mm) and a door opening includes two door leaves without a mullion, one leaf shall provide a clear opening width of 32 inches (813 mm). The maximum width of a swinging door leaf shall be 48 inches (1219 mm) nominal. Means of egress doors in an occupancy in Group I-2 used for the movement of beds shall provide a clear width not less than 41½ inches (1054 mm).

### **Exceptions:**

1. The minimum and maximum width shall not apply to door openings that are not part of the required means of egress in occupancies in Groups R-2 and R-3.
2. Door openings to resident sleeping units in occupancies in Group I-3 shall have a clear width of not less than 28 inches (711 mm).

3. Door openings to storage closets less than 10 square feet (0.93 m<sup>2</sup>) in area shall not be limited by the minimum width.
4. Width of door leafs in revolving doors that comply with Section 1008.1.3.1 shall not be limited.
5. Interior egress doors within a dwelling unit or sleeping unit which is not required to be adaptable or accessible.
6. In Group R-3 occupancies, door openings required to be accessible within Type B dwelling units subject to Section 1107.6.3 shall have a minimum clear width of 31¾ inches (806 mm).

**1008.1.1.2 Projections into clear width.** There shall not be projections into the required clear width lower than 34 inches (864 mm) above the floor or ground. Projections into the clear opening width between 34 inches (864 mm) and 80 inches (2032 mm) above the floor or ground shall not exceed 4 inches (102 mm).

**1008.1.1.3 Height.** The height of doors shall not be less than 80 inches (2032 mm).

**Exceptions:**

1. Door openings within a dwelling unit or sleeping unit shall not be less than 78 inches (1981 mm) in height.
2. Exterior door openings in dwelling units and sleeping units, other than the required exit door, shall not be less than 76 inches (1930 mm) in height.

**1008.1.2 Door swing.** Egress doors shall be installed in accordance with this section.

**1008.1.2.1 Mounting.** Egress doors shall be side-hinged swinging.

**Exceptions:**

1. Private garages, office areas, factory and storage areas with an occupant load of 10 or less.
2. Group I-3 occupancies used as a place of detention.
3. Doors within or serving a single dwelling unit in Groups R-2 and R-3.
4. In other than Group H occupancies, revolving doors complying with Section 1008.1.3.1.

5. In other than Group H occupancies, horizontal sliding doors complying with Section 1008.1.3.3 are permitted in a means of egress.

6. Power-operated doors in accordance with Section 1008.1.3.2.

**1008.1.2.2 Direction of swing.** Doors shall swing in the direction of egress travel where serving:

1. Group F or Group H occupancies.

2. Rooms or spaces with an occupant load of 50 or more persons.

3. Rooms or spaces requiring more than one exit door.

4. Automatic teller machines in accordance with *Administrative Code* section 10-160.

**Exception:** Doors need not swing in the direction of egress travel for exterior street floor exit doors from lobbies in buildings in Group R-2 or R-3 occupancies.

**1008.1.2.3 Opening force.** The opening force for interior side-swinging doors without closers shall not exceed a 5-pound (22 N) force. For other side-swinging, sliding and folding doors, the door latch shall release when subjected to a 15-pound (67 N) force. The door shall be set in motion when subjected to a 30-pound (133 N) force. The door shall swing to a full-open position when subjected to a 15-pound (67 N) force. Forces shall be applied to the latch side.

**1008.1.3 Special doors.** Special doors and security grilles shall comply with the requirements of Sections 1008.1.3.1 through 1008.1.3.5.

**1008.1.3.1 Revolving doors.** Revolving doors shall comply with the following:

1. Each revolving door shall be capable of collapsing into a book fold position with parallel egress paths providing an aggregate width of 36 inches (914 mm).

2. A revolving door shall not be located within 10 feet (3048 mm) of the foot of or top of stairs or escalators. A dispersal area shall be provided between the stairs or escalators and the revolving doors.

3. The revolutions per minute (rpm) for a revolving door shall not exceed those shown in Table 1008.1.3.1.

4. Each revolving door shall have a side-hinged swinging door which



complies with Section 1008.1 in the same wall and within 10 feet (3048 mm) of the revolving door.

**TABLE 1008.1.3.1**  
**REVOLVING DOOR SPEEDS**  
**(Table 1008.1.3.1 attached to end of document)**

**1008.1.3.1.1 Egress component.** A revolving door used as a component of a means of egress shall comply with Section 1008.1.3.1 and the following three conditions:

1. Revolving doors shall not be given credit for more than 50 percent of the required egress capacity.
2. Each revolving door shall be credited with no more than a 50-person capacity.
3. Each revolving door shall be capable of being collapsed when a force of not more than 130 pounds (578 N) is applied within 3 inches (76 mm) of the outer edge of a wing.

**1008.1.3.1.2 Other than egress component.** A revolving door used as other than a component of a means of egress shall comply with Section 1008.1.3.1. The collapsing force of a revolving door not used as a component of a means of egress shall not be more than 180 pounds (801 N).

**Exception:** A collapsing force in excess of 180 pounds (801 N) is permitted if the collapsing force is reduced to not more than 130 pounds (578 N) when at least one of the following conditions is satisfied:

1. There is a power failure or power is removed to the device holding the door wings in position.
2. There is an actuation of the automatic sprinkler system where such system is provided.
3. There is an actuation of a smoke detection system which is installed in accordance with Section 907 to provide coverage in areas within the building which are within 75 feet (22 860 mm) of the revolving doors.
4. There is an actuation of a manual control switch, in an approved location and clearly defined, which reduces the holding force to below the 130-pound (578 N) force level.

**1008.1.3.2 Power-operated doors.** Where means of egress doors are operated by

power, such as doors with a photoelectric-actuated mechanism to open the door upon the approach of a person, or doors with power-assisted manual operation, the design shall be such that in the event of power failure, the door is capable of being opened manually to permit means of egress travel or closed where necessary to safeguard means of egress. The forces required to open these doors manually shall not exceed those specified in Section 1008.1.2, except that the force to set the door in motion shall not exceed 50 pounds (220 N). The door shall be capable of swinging from any position to the full width of the opening in which such door is installed when a force is applied to the door on the side from which egress is made. Full-power-operated doors shall comply with BHMA A156.10. Power-assisted and low-energy doors shall comply with BHMA A156.19.

**Exceptions:**

1. Power operated doors are not required to be manually operable in occupancies in Group I-3 when egress complies with Section 408.
2. Section 1008.1.3.2 does not apply to horizontal sliding doors complying with Section 1008.1.3.3.
3. For a biparting door in the emergency breakout mode, a door leaf located within a multiple-leaf opening shall be exempt from the minimum 32-inch (813 mm) single-leaf requirement of Section 1008.1.1, provided a minimum 32-inch (813 mm) clear opening is provided when the two biparting leaves meeting in the center are broken out.

**1008.1.3.3 Horizontal sliding doors.** In other than Group H occupancies, horizontal sliding doors permitted to be a component of a means of egress in accordance with Exception 5 to Section 1008.1.2.1 shall comply with all of the following criteria:

1. The doors shall be power operated and shall be capable of being operated manually in the event of power failure.
2. The doors shall be operable by a simple method from both sides without special knowledge or effort.
3. The force required to operate the door shall not exceed 30 pounds (133 N) to set the door in motion and 15 pounds (67 N) to close the door or open it to the minimum required width.
4. The door shall be operable with a force not to exceed 15 pounds (67 N) when a force of 250 pounds (1100 N) is applied perpendicular to the door adjacent to the operating device.

5. The door assembly shall comply with the applicable fire protection rating and, where rated, shall be self-closing or automatic-closing by smoke detection, shall be installed in accordance with NFPA 80 and shall comply with Section 715.
6. The door assembly shall have an integrated emergency power supply.
7. The door assembly power supply shall be electrically supervised.
8. The door shall open to the minimum required width within 10 seconds after activation of the operating device.

**1008.1.3.4 Access-controlled entrance doors.** The exterior building entrance doors serving occupancies in Group A, B, E, M, R-1 or R-2 and entrance doors to tenant spaces in occupancies in Groups A, B, E, M, R-1 and R-2 are permitted to be equipped with an approved entrance and egress access control system which shall be installed in accordance with all of the following criteria:

1. A sensor shall be provided on the egress side arranged to detect an occupant approaching the doors. The doors shall be arranged to unlock by a signal from or loss of power to the sensor.
2. Loss of power to that part of the access control system which locks the doors shall automatically unlock the doors.
3. The doors shall be arranged to unlock from a manual unlocking device located 40 inches to 48 inches (1016 mm to 1219 mm) vertically above the floor and within 5 feet (1524 mm) of the secured doors. Ready access shall be provided to the manual unlocking device and the device shall be clearly identified by a sign that reads "PUSH TO EXIT." When operated, the manual unlocking device shall result in direct interruption of power to the lock—independent of the access control system electronics—and the doors shall remain unlocked for a minimum of 30 seconds.
4. Activation of the building fire alarm system, if provided, shall automatically unlock the doors, and the doors shall remain unlocked until the fire alarm system has been reset.
5. Activation of the building automatic sprinkler or fire detection system, if provided, shall automatically unlock the doors. The doors shall remain unlocked until the fire alarm system has been reset.
6. Entrance doors in buildings with an occupancy in Group A, B, E or M shall not be secured from the egress side during periods that the building is open to the general public.

**1008.1.3.5 Security grilles.** In Groups B, M and S, horizontal sliding or vertical security grilles are permitted at the main entrance where the opening of such grilles are essential to the operation of the establishments. Such grilles shall be openable from the inside without the use of a key or special knowledge or effort during periods that the space is occupied. The grilles shall remain secured in the full-open position during the period of occupancy by the general public.

**1008.1.4 Floor elevation.** There shall be a floor or landing on each side of a door. Such floor or landing shall be at the same elevation on each side of the door. Landings shall be level except for exterior landings, which are permitted to have a slope not to exceed 0.25 unit vertical in 12 units horizontal (2-percent slope).

**Exceptions:**

1. Doors serving individual dwelling units in Groups R-2 and R-3 where the following apply:
  - 1.1. A door is permitted to open at the top step of an interior flight of stairs within the dwelling unit, provided the door does not swing over the top step.
  - 1.2. Screen doors and storm doors are permitted to swing over stairs or landings.
2. Landings serving exterior doors as provided for in Section 1003.5, Exception 1, and Section 1017.2, which are not on an accessible route may be constructed a single 7-inch (178 mm) step below the elevation at the door threshold.
3. In Group R-3 occupancies, the landing at an exterior doorway shall not be more than 7¾ inches (197 mm) below the top of the threshold, provided the door, other than an exterior storm or screen door, does not swing over the landing.
4. Variations in elevation due to differences in finish materials, but not more than 0.5 inch (12.7 mm).
5. Exterior spaces of Type B units where permitted pursuant to Section 1107.4, Exceptions 1 and 2.

**1008.1.5 Landings at doors.** Landings shall have a width not less than the width of the stairway or the door, whichever is the greater. Doors in the fully open position shall not reduce a required dimension by more than 7 inches (178 mm). When a landing serves an occupant load of 50 or more, doors in any position shall not reduce the landing to less than 75 percent of its required width. Landings shall have a length

measured in the direction of travel of not less than 44 inches (1118 mm).

**Exception:** Landing length in the direction of travel in Group R-3 and Group U and within individual units of Group R-2 need not exceed 36 inches (914 mm).

**1008.1.6 Thresholds.** Thresholds at doorways shall not exceed 0.75 inch (19.1 mm) in height for sliding doors serving dwelling units or 0.5 inch (12.7 mm) for other doors. Raised thresholds and floor level changes greater than 0.25 inch (6.4 mm) at doorways shall be beveled with a slope not greater than one unit vertical in two units horizontal (50-percent slope).

**1008.1.7 Door arrangement.** Space between two doors in series shall be 48 inches (1219 mm) minimum plus the width of a door swinging into the space. Doors in series shall swing either in the same direction or away from the space between doors.

**Exceptions:**

1. The minimum distance between horizontal sliding power-operated doors in a series shall be 48 inches (1219 mm).
2. Storm and screen doors serving individual dwelling units in Groups R-2 and R-3 need not be spaced 48 inches (1219 mm) from the other door.
3. Doors within individual dwelling units in Group R-3.
4. Doors within individual dwelling units in Group R-2 that are not required to comply with Section 1107.
5. Exterior doors in vestibules in R-2 occupancies shall not be required to swing either in the same direction or away from the space between doors provided that the 48-inch (1219 mm) minimum space between door swings is maintained.

**1008.1.8 Door operations.** Except as specifically permitted by this section egress doors shall be readily openable from the egress side without the use of a key or special knowledge or effort.

**1008.1.8.1 Hardware.** Door handles, pulls, latches, locks and other operating devices on doors required to be accessible by Chapter 11 shall not require tight grasping, tight pinching or twisting of the wrist to operate.

**1008.1.8.2 Hardware height.** Door handles, pulls, latches, locks and other operating devices shall be installed 34 inches (864 mm) minimum and 48 inches (1219 mm) maximum above the finished floor. Locks used only for security purposes and not used for normal operation are permitted at any height.

**1008.1.8.3 Locks and latches.** Locks and latches shall be permitted to prevent operation of doors where any of the following exists:

1. Places of detention or restraint.
2. Places where extra safeguards are required such as banks, museums, and jewelry stores subject to the approval of the commissioner and provided the locks are equipped with electrical release devices for remote control in case of emergencies. However, museums shall be subject to further special review by the commissioner and Fire Commissioner.
3. Main entrances in occupancy Groups B, M, and S as permitted by Section 1008.1.3.5.
4. Doors from individual dwelling or sleeping units of Group R occupancies having an occupant load of 10 or less are permitted to be equipped with a night latch, dead bolt or security chain, provided such devices are openable from the inside without the use of a key or tool.
5. Stairways leading from the top floor to a roof may be provided with locked wire mesh gates openable by key in buildings classified in Group E. The use of a hook and eye closing device on the inside of all doors to roofs shall be permitted.

**1008.1.8.4 Bolt locks.** Manually operated flush bolts or surface bolts are not permitted.

**Exceptions:**

1. On doors not required for egress in individual dwelling units or sleeping units.
2. Where a pair of doors serves a storage or equipment room, manually operated edge- or surface-mounted bolts are permitted on the inactive leaf.

**1008.1.8.5 Unlatching.** The unlatching of any leaf shall not require more than one operation.

**Exception:** More than one operation is permitted for unlatching doors in the following locations:

1. Places of detention or restraint.
2. Where manually operated bolt locks are permitted by Section 1008.1.8.4.

3. Doors from individual dwelling units and guestrooms of Group R occupancies as permitted by Section 1008.1.8.3, Exception 4.

**1008.1.8.6 Delayed egress locks.** Subject to special review and approval by the commissioner, approved, listed, delayed egress locks may be permitted on doors serving spaces where extra safeguards are required in buildings that are equipped throughout with an automatic sprinkler system in accordance with Section 903.3.1.1 or an approved automatic smoke or heat detection system installed in accordance with Section 907, provided that the doors unlock in accordance with Items 1 through 6 below. A building occupant shall not be required to pass through more than one door equipped with a delayed egress lock before entering an exit.

1. The doors unlock upon actuation of the automatic sprinkler system or automatic fire detection system.
2. The doors unlock upon loss of power controlling the lock or lock mechanism.
3. The door locks shall have the capability of being unlocked by a signal from the fire command center.
4. The initiation of an irreversible process which will release the latch in not more than 15 seconds when a force of not more than 15 pounds (67 N) is applied for 1 second to the release device. Initiation of the irreversible process shall activate an audible signal in the vicinity of the door. Once the door lock has been released by the application of force to the releasing device, relocking shall be by manual means only.

**Exception:** Where approved, a delay of not more than 30 seconds is permitted.

5. A sign shall be provided on the door located above and within 12 inches (305 mm) of the release device reading: PUSH UNTIL ALARM SOUNDS. DOOR CAN BE OPENED IN 15 SECONDS.
6. Emergency lighting shall be provided at the door.

**Exceptions:**

1. Delayed egress locks shall not be permitted in buildings or spaces in Group A, E, F and H occupancies. However, in museums, delayed egress locks may be installed on exit doors subject to special review by the commissioner and Fire Commissioner.
2. Places of detention or restraints in Group I-3 are permitted to install delayed egress locks without the special review by the

commissioner, provided that the installation complies with all of the other requirements of this section.

**1008.1.8.7 Stairway doors.** Interior stairway means of egress doors shall be openable from both sides without the use of a key or special knowledge or effort.

**Exceptions:**

1. Stairway discharge doors shall be openable from the egress side and shall only be locked from the opposite side.
2. This section shall not apply to doors arranged in accordance with Section 403.12.
3. In stairways serving not more than four stories, doors are permitted to be locked from the stair side, provided they are openable from the egress side.

**1008.1.9 Panic and fire exit hardware.** Each door in a means of egress from an occupancy of Group A or E having an occupant load of 75 or more and any occupancy of Group H-1, H-2, H-3 or H-5 shall be provided with panic hardware or fire exit hardware. Where panic and fire exit hardware is installed, it shall comply with the following:

1. The actuating portion of the releasing device shall extend at least one-half of the door leaf width.
2. The maximum unlatching force shall not exceed 15 pounds (67 N).
3. If balanced doors are used and panic hardware is required, the panic hardware shall be the push-pad type and the pad shall not extend more than one-half the width of the door measured from the latch side.

**1008.2 Gates.** Gates serving the means of egress system shall comply with the requirements of this section. Gates used as a component in a means of egress shall conform to the applicable requirements for doors.

**Exception:** Horizontal sliding or swinging gates exceeding the 4-foot (1219 mm) maximum leaf width limitation are permitted in fences and walls surrounding a stadium.

**1008.2.1 Stadiums.** Panic hardware is not required on gates surrounding stadiums where such gates are under constant immediate supervision while the public is present, and further provided that safe dispersal areas based on 3 square feet (0.28 m<sup>2</sup>) per occupant are located between the fence and enclosed space. Such required safe dispersal areas shall not be located less than 50 feet (15 240 mm) from the enclosed



space. See Section 1023.6 for means of egress from safe dispersal areas.

**1008.3 Turnstiles.** Turnstiles or similar devices that restrict travel to one direction shall not be placed so as to obstruct any required means of egress. Where portable turnstiles are installed for ticketing purposes, such turnstiles shall be moved from the egress path for proper exiting. Turnstiles that turn freely in the direction of exit travel may be used in any occupancy where revolving doors are permitted. Each turnstile or similar device shall be credited with no more than a 50-person capacity where all of the following provisions are met:

1. Each device shall turn free in the direction of egress travel when primary power is lost, and upon the manual release by an employee in the area.
2. Such devices are not given credit for more than 50 percent of the required egress capacity.
3. Each device is not more than 39 inches (991 mm) high.
4. Each device has at least 16.5 inches (419 mm) clear width at and below a height of 39 inches (991 mm) and at least 22 inches (559 mm) clear width at heights above 39 inches (991 mm).
5. Where located as part of an accessible route, turnstiles shall have at least 36 inches (914 mm) clear at and below a height of 34 inches (864 mm), at least 32 inches (813 mm) clear width between 34 inches (864 mm) and 80 inches (2032mm) and shall consist of a mechanism other than a revolving device.

**Exception:** Where serving an occupant load greater than 300, turnstiles shall not be credited for any of the required egress capacity.

**1008.3.1 High turnstile.** Turnstiles more than 39 inches (991 mm) high shall meet the requirements for revolving doors.

**1008.3.2 Additional door.** Where serving an occupant load greater than 300, each turnstile that is not portable shall have a side-hinged swinging door which conforms to Section 1008.1 within 50 feet (15 240 mm).

**1008.4 Security requirements for doors and windows.** The following provisions shall apply to buildings in Group R-2.

**1008.4.1 Entrance doors.** Building entrance doors and other exterior exit doors shall be equipped with heavy duty lock sets with auxiliary latch bolts to prevent the latch from being manipulated by means other than a key. Latch sets shall have stop-work in the inside cylinder controlled by a master key only. Outside cylinders of main entrance door locks shall be operated by the tenants' key, which shall not be keyed to also open the tenants' apartment door. A light or lights shall be provided at or near the outside of the front entranceway of the building providing not less than 5 foot candles

(53.82 lux) intensity measured at the floor level for the full width of the entranceway.

**1008.4.2 Doors to dwelling units.** Doors to dwelling units shall be equipped with a heavy duty latch set and a heavy duty dead bolt operable by a key from the outside and a thumb-turn from the inside. Those doors shall also be equipped with a chain guard so as to permit partial opening of the door. Dwelling unit entrance doors shall also be equipped with a viewing device located so as to enable a person on the inside of the entrance door to view a person immediately outside.

**1008.4.3 Windows.** All openable windows shall be equipped with sash locks designed to be openable from the inside only. Grilles lockable from the inside only may be placed on the inside or outside of windows that are accessible from grade but that do not serve to provide access to exits.

**1008.4.4 Intercommunication system.** Buildings containing eight or more dwelling units shall be provided with an intercommunication system located at the door giving access to the main entrance lobby, consisting of a device or devices for voice communication between the occupant of each dwelling unit and a person outside the door to the main entrance lobby, and permitting such dwelling unit occupant to release the locking mechanism of said door from the dwelling unit. In buildings provided with a full-time lobby attendant, the intercommunication system may be between each dwelling unit and the attendant's station.

## **SECTION BC 1009** **STAIRWAYS AND HANDRAILS**

**1009.1 Stairway width.** The width of stairways shall be determined as specified in Section 1005.1, but such width shall not be less than 44 inches (1118 mm). See Section 1007.3 for accessible means of egress stairways.

### **Exceptions:**

1. A width of not less than 36 inches (914 mm) shall be permitted in:
  - 1.1. A stairway that serves an occupant load of 50 or less cumulative for all stories; or
  - 1.2. A stairway that provides egress to the exit discharge solely for the use of Group R-2 occupancies, provided the building it serves is 125 feet (38 100 mm) or less in height, and provided such a stairway serves not more than 30 occupants per floor.
2. Spiral stairways as provided for in Section 1009.9.
3. Aisle stairs complying with Section 1024.

4. Where a stairway lift is installed on stairways serving occupancies in Group R-3, or within dwelling units in occupancies in Group R-2 a clear passage width not less than 20 inches (508 mm) shall be provided. If the seat and platform can be folded when not in use, the distance shall be measured from the folded position.

**1009.2 Headroom.** Stairways shall have a minimum headroom clearance of 84 inches (2134 mm) measured vertically from a line connecting the edge of the nosings. Such headroom shall be continuous above the stairway to the point where the line intersects the landing below, one tread depth beyond the bottom riser. The minimum clearance shall be maintained the full width of the stairway and landing. Projections into the required width shall not be limited above the minimum headroom height.

**Exceptions:**

1. In Group R-2 and R-3 occupancies stairways shall have a minimum headroom clearance of 80 inches (2032 mm).
2. Spiral stairways complying with Section 1009.9 are permitted a 78-inch (1981 mm) headroom clearance.

**1009.3 Stair treads and risers.** Stair riser heights shall be 7 inches (178 mm) maximum and 4 inches (102 mm) minimum. Stair tread depths shall be 11 inches (279 mm) minimum. The riser height shall be measured vertically between the leading edges of adjacent treads. The greatest riser height within any flight of stairs shall not exceed the smallest by more than 0.375 inch (9.5 mm). The tread depth shall be measured horizontally between the vertical planes of the foremost projection of adjacent treads and at right angle to the tread's leading edge. The greatest tread depth within any flight of stairs shall not exceed the smallest by more than 0.375 inch (9.5 mm). Winder treads shall have a minimum tread depth of 11 inches (279 mm) measured at a right angle to the tread's leading edge at a point 12 inches (305 mm) from the side where the treads are narrower and a minimum tread depth of 10 inches (254 mm). The greatest winder tread depth at the 12-inch (305 mm) walk line within any flight of stairs shall not exceed the smallest by more than 0.375 inch (9.5 mm).

**Exceptions:**

1. Circular stairways in accordance with Section 1009.7.
2. Winders in accordance with Section 1009.8.
3. Spiral stairways in accordance with Section 1009.9.
4. Aisle stairs in assembly seating areas where the stair pitch or slope is set, for sightline reasons, by the slope of the adjacent seating area in accordance with Section 1024.11.2.

5. In Group R-2 occupancies:

5.1. Sum of treads and risers. The sum of two risers plus one tread exclusive of nosing shall be not less than 24 inches (610 mm) nor more than 25.5 inches (648 mm).

5.2. Dimensions of treads and risers. The maximum riser height shall be 7.75 inches (197 mm) and the minimum tread depth shall be 9.5 inches (241 mm) plus nosing. Treads may be undercut a distance equal to the nosing. A nosing not less than 0.75 inch (19 mm) but not more than 1.25 inches (32 mm) shall be provided on stairways with solid risers where the tread depth is less than 11 inches (279 mm).

5.3. Tolerances. The greatest riser height, tread depth, and nosing projection, within any flight of stairs shall not exceed the smallest by more than 0.375 (9.5 mm).

6. In Group R-3 occupancies; within dwelling units in Group R-2 occupancies not subject to accessibility provisions in Section 1107.2.5, Exception Item 2; and in Group U occupancies that are accessory to Group R-3 occupancy or accessory to individual dwelling units in Group R-2 occupancies:

6.1. Sum of treads and risers. The sum of two risers plus one tread exclusive of nosing shall be not less than 24 inches (610 mm) nor more than 25.5 inches (648 mm).

6.2. Dimensions of treads and risers. The maximum riser height shall be 8.25 inches (210 mm) and the minimum tread depth shall be 9.5 inches (241 mm) plus nosing. Treads may be undercut a distance equal to the nosing. A nosing not less than 0.75 inch (19 mm) but not more than 1.25 inches (32 mm) shall be provided on stairways with solid risers where the tread depth is less than 11 inches (279 mm).

6.3. Tolerances. The greatest riser height, tread depth, and nosing projection, within any flight of stairs shall not exceed the smallest by more than 0.375 (9.5 mm).

7. In Group R-3 occupancies; and within dwelling units in Group R-2 occupancies; winders shall have a minimum tread depth of 10 inches (254 mm) measured horizontally between the vertical planes of the foremost projection of adjacent treads and at a right angle to the tread's leading edge, when measured at a point 12 inches (305 mm) from the side where the treads are narrower. Winder treads shall have a minimum tread depth of 6 inches (152 mm) at any point. Within any flight of stairs, the greatest winder tread depth at the 12-inch (305 mm) walk line shall not exceed the smallest by more than 0.375 inch (9.5 mm).

**1009.3.1 Dimensional uniformity.** Stair treads and risers shall be of uniform size and shape. The tolerance between the largest and smallest riser or between the largest and smallest tread shall not exceed 0.375 inch (9.5 mm) in any flight of stairs.

**Exceptions:**

1. Nonuniform riser dimensions of aisle stairs complying with Section 1024.11.2.
2. Consistently shaped winders, complying with Section 1009.8, differing from rectangular treads in the same stairway flight.
3. Where the bottom or top riser adjoins a sloping public way, walkway or driveway having an established grade and serving as a landing, the bottom or top riser is permitted to be reduced along the slope to less than 4 inches (102 mm) in height with the variation in height of the bottom or top riser not to exceed one unit vertical in 12 units horizontal (8-percent slope) of stairway width. The nosings or leading edges of treads at such nonuniform height risers shall have a distinctive marking stripe, different from any other nosing marking provided on the stair flight. The distinctive marking stripe shall be visible in descent of the stair and shall have a slip-resistant surface. Marking stripes shall have a width of at least 1 inch (25 mm) but not more than 2 inches (51 mm).

**1009.3.2 Profile.** The radius of curvature at the leading edge of the tread shall be not greater than 0.5 inch (12.7 mm). Beveling of nosings shall not exceed 0.5 inch (12.7 mm). Risers shall be solid and vertical or sloped from the underside of the leading edge of the tread above at an angle not more than 30 degrees (0.52 rad) from the vertical. The leading edge (nosings) of treads shall project not more than 1.25 inches (32 mm) beyond the tread below and all projections of the leading edges shall be of uniform size, including the leading edge of the floor at the top of a flight. Perforated risers with openings not exceeding 0.25 inch (6.4 mm) shall be considered solid risers.

**Exceptions:**

1. Solid risers are not required for stairways that are not serving as means of egress or that are not required to comply with Section 1007.3, provided that the opening between treads does not permit the passage of a sphere with a diameter of 4 inches (102 mm).
2. Solid risers are not required for occupancies in Group I-3.
3. In Group R-3 occupancies, the following shall apply:
  - 3.1. The radius of curvature at the leading edge of the tread shall be no greater than 0.5625 inch (14.3 mm).

3.2. Solid risers are not required provided that the opening between treads does not permit the passage of a sphere with a diameter of 4 inches (102 mm). However, the opening between treads is not limited on stairways with a total rise of 30 inches (762 mm) or less.

**1009.4 Stairway landings.** There shall be a floor or landing at the top and bottom of each stairway. The width of landings shall not be less than the width of stairways they serve. Every landing shall have a minimum dimension measured in the direction of travel equal to the width of the stairway. Such dimension need not exceed 48 inches (1219 mm) where the stairway has a straight run.

**Exceptions:**

1. Aisle stairs complying with Section 1024.
2. Doors opening onto a landing shall not reduce the landing to less than 75 percent of the required width. When fully open, the door shall not project more than 7 inches (178 mm) into a landing.

**1009.5 Stairway construction.** All stairways shall be built of materials consistent with the type permitted for the type of construction of the building, except that wood handrails shall be permitted for all types of construction.

**1009.5.1 Stairway walking surface.** The walking surface of treads and landings of a stairway shall not be sloped steeper than one unit vertical in 48 units horizontal (2-percent slope) in any direction. Stairway treads and landings shall have a solid surface. Finish floor surfaces shall be securely attached.

**Exception:** In Group F, H and S occupancies, other than areas of parking structures accessible to the public, openings in treads and landings shall not be prohibited provided a sphere with a diameter of 1 $\frac{1}{8}$  inches (29 mm) cannot pass through the opening.

**1009.5.2 Outdoor conditions.** Outdoor stairways and outdoor approaches to stairways shall be designed so that water will not accumulate on walking surfaces. In other than occupancies in Group R-3, and occupancies in Group U that are accessory to an occupancy in Group R-3, treads, platforms and landings that are part of exterior stairways in climates subject to snow or ice shall be protected to prevent the accumulation of same.

**1009.6 Vertical rise.** A flight of stairs shall not have a vertical rise greater than 12 feet (3658 mm) between floor levels or landings, except that the vertical rise shall not be greater than 8 feet (2438 mm) in Group A and I occupancies.

**Exception:** Aisle stairs comply with Section 1024.

**1009.7 Circular stairways.** Circular stairways shall have a minimum tread depth and a maximum riser height in accordance with Section 1009.3 and the smaller radius shall not be less than twice the width of the stairway. The minimum tread depth measured 12 inches (305 mm) from the narrower end of the tread shall not be less than 11 inches (279 mm). The minimum tread depth at the narrow end shall not be less than 10 inches (254 mm).

**Exception:** For occupancies in Group R-3, and within individual dwelling units in occupancies in Group R-2.

**1009.8 Winders.** Winders are not permitted in means of egress stairways except in R-3 occupancies or within dwelling units in Group R-2 occupancies.

**1009.9 Spiral stairways.** Spiral stairways are permitted to be used as a component in the means of egress only within dwelling units or from a space not more than 250 square feet (23 m<sup>2</sup>) in area and serving not more than five occupants, or from galleries, catwalks and gridirons in accordance with Section 1014.6. A spiral stairway shall have a 7.5-inch (191 mm) minimum clear tread depth at a point 12 inches (305 mm) from the narrow edge. The risers shall be sufficient to provide a headroom of 78 inches (1981 mm) minimum, but riser height shall not be more than 9.5 inches (241 mm). The minimum stairway width shall be 26 inches (660 mm).

**1009.10 Alternating tread devices.** Alternating tread devices are limited to an element of a means of egress in buildings of Groups F, H and S from a mezzanine not more than 250 square feet (23 m<sup>2</sup>) in area and which serves not more than five occupants; in buildings of Group I-3 from a guard tower, observation station or control room not more than 250 square feet (23 m<sup>2</sup>) in area and for access to unoccupied roofs.

**1009.10.1 Handrails of alternating tread devices.** Handrails shall be provided on both sides of alternating tread devices and shall conform to Section 1009.11.

**1009.10.2 Treads of alternating tread devices.** Alternating tread devices shall have a minimum projected tread of 5 inches (127 mm), a minimum tread depth of 8.5 inches (216 mm), a minimum tread width of 7 inches (178 mm) and a maximum riser height of 9.5 inches (241 mm). The initial tread of the device shall begin at the same elevation as the platform, landing or floor surface.

**Exception:** Alternating tread devices used as an element of a means of egress in buildings from a mezzanine area not more than 250 square feet (23 m<sup>2</sup>) in an area which serves not more than five occupants shall have a minimum projected tread of 8.5 inches (216 mm) with a minimum tread depth of 10.5 inches (267 mm). The rise to the next alternating tread surface should not be more than 8 inches (203 mm).

**1009.11 Handrails.** Stairways shall have handrails on each side. Handrails shall be

adequate in strength and attachment in accordance with Section 1607.7. Handrails for ramps, where required by Section 1010.8, shall comply with this section.

**Exceptions:**

1. Aisle stairs complying with Section 1024 provided with a center handrail need not have additional handrails.
2. Stairways within dwelling units, spiral stairways and aisle stairs serving seating only on one side are permitted to have a handrail on one side only.
3. Decks, patios and walkways that have a single change in elevation where the landing depth on each side of the change of elevation is greater than what is required for a landing do not require handrails.
4. In Group R-3 occupancies, a change in elevation consisting of a single riser at an entrance or egress door does not require handrails.
5. Changes in room elevations of only one riser within dwelling units and sleeping units in Group R-2 and R-3 occupancies do not require handrails.
6. One handrail shall be allowed in enclosed exit stairs less than 44 inches (1118 mm) wide that do not serve as an accessible means of egress.

**1009.11.1 Height.** Handrail height, measured above stair tread nosings, or finish surface of ramp slope, shall be uniform, not less than 34 inches (864 mm) and not more than 38 inches (965 mm).

**1009.11.2 Intermediate handrails.** Intermediate handrails are required so that all portions of the stairway width required for egress capacity are within 30 inches (762 mm) of a handrail. On monumental stairs, handrails shall be located along the most direct path of egress travel.

**1009.11.3 Handrail graspability.** Handrails with a circular cross section shall have an outside diameter of at least 1.25 inches (32 mm) and not greater than 2 inches (51 mm) or shall provide equivalent graspability. If the handrail is not circular, it shall have a perimeter dimension of at least 4 inches (102 mm) and not greater than 6.25 inches (160 mm) with a maximum cross-section dimension of 2.25 inches (57 mm). Edges shall have a minimum radius of 0.01 inch (0.25mm).

**1009.11.4 Continuity.** Handrail-gripping surfaces shall be continuous, without interruption by newel posts or other obstructions.

**Exceptions:**

1. Handrails within dwelling units are permitted to be interrupted by a newel post at a stair landing.



2. Within a dwelling unit, the use of a volute, turnout or starting easing is allowed on the lowest tread.
3. Handrail brackets or balusters attached to the bottom surface of the handrail that do not project horizontally beyond the sides of the handrail within 1.5 inches (38 mm) of the bottom of the handrail shall not be considered to be obstructions and provided further that for each 0.5 inch (13 mm) of additional handrail perimeter dimension above 4 inches (102 mm), the vertical clearance dimension of 1.5 inches (38 mm) shall be permitted to be reduced by 0.125 inch (3 mm).

**1009.11.5 Handrail extensions.** Handrails shall return to a wall, guard or the walking surface or shall be continuous to the handrail of an adjacent stair flight. Where handrails are not continuous between flights, the handrails shall extend horizontally at least 12 inches (305 mm) beyond the top riser and continue to slope for the depth of one tread beyond the bottom riser.

**Exceptions:**

1. Handrails within a dwelling unit that is not required to be an Accessible unit, or Type B unit in Group R-2 occupancies, may extend only from the top riser to the bottom riser.
2. Aisle handrails in Group A occupancies in accordance with Section 1024.13.

**1009.11.6 Clearance.** Clear space between a handrail and a wall or other surface shall be a minimum of 1.5 inches (38 mm). A handrail and a wall or other surface adjacent to the handrail shall be free of any sharp or abrasive elements.

**1009.11.7 Stairway projections.** Projections into the required width at each handrail shall not exceed 4.5 inches (114 mm).

**1009.12 Stairway to roof and roof access.** In buildings four or more stories or more than 40 feet (12 192 mm) in height above grade, one stairway shall extend to the roof surface through a stairway bulkhead complying with Section 1509.2, unless the roof has a slope steeper than 20 degrees. Access to setback roof areas may be through a door or window opening to the roof. Stairs terminating at the level of a setback shall provide access to the setback roof areas, except where the setback is less than 4 feet (1219 mm) in width and 10 feet (3048 mm) in length, measured from the inside of the parapet wall.

**1009.12.1 Occupancy Groups R-1 and R-2.** In buildings in occupancy Groups R-1 and R-2 two stories or more in height, with roofs having a slope of 15 degrees or less, all interior stairs, except those terminating at the level of a setback roof, shall extend to the roof surface.

**Exception:** In buildings in occupancy Groups R-1 and R-2 two stories in height and in occupancy Group R-2 three stories in height with not more than one dwelling unit per story, access to the roof shall be permitted to be a non-combustible roof hatch or trap door not less than 21 inches (533 mm) in width and 28 inches (711 mm) in length. Such hatches shall be located within the stair enclosure and be provided with a stationary, noncombustible access ladder or alternating tread device.

## **SECTION BC 1010** **RAMPS**

**1010.1 Scope.** The provisions of this section shall apply to ramps used as a component of a means of egress.

### **Exceptions:**

1. Other than ramps that are part of the accessible routes providing access in accordance with Sections 1108.2.2 through 1108.2.4.1, ramped aisles within assembly rooms or spaces shall conform with the provisions in Section 1024.11.
2. Curb ramps shall comply with ICC A117.1.
3. Vehicle ramps in parking garages for pedestrian exit access shall not be required to comply with Sections 1010.3 through 1010.9 when they are not an accessible route serving accessible parking spaces, other required accessible elements or part of an accessible means of egress.

**1010.2 Slope.** Ramps used as part of a means of egress or part of an accessible route shall have a running slope not steeper than one unit vertical in 12 units horizontal (8-percent slope). The slope of other pedestrian ramps shall not be steeper than one unit vertical in eight units horizontal (12.5-percent slope).

### **Exceptions:**

1. Aisle ramp slope in occupancies of Group A shall comply with Section 1024.11.
2. In garages three stories or less in height and serving not more than one level below grade, ramps with a maximum slope of one unit vertical in seven units horizontal (14-percent slope) may serve as part of a non accessible means of egress.

**1010.3 Cross slope.** The slope measured perpendicular to the direction of travel of a ramp shall not be steeper than one unit vertical in 48 units horizontal (2-percent slope).

**1010.4 Vertical rise.** The rise for any ramp run shall be 30 inches (762 mm) maximum.

**1010.5 Minimum dimensions.** The minimum dimensions of means of egress ramps shall comply with Sections 1010.5.1 through 1010.5.3.

**1010.5.1 Width.** The minimum width of a means of egress ramp shall not be less than that required for corridors by Section 1016.2. The clear width of a ramp and the clear width between handrails, if provided, shall be 36 inches (914 mm) minimum.

**1010.5.2 Headroom.** The minimum headroom in all parts of the means of egress ramp shall not be less than 84 inches (2134 mm).

**1010.5.3 Restrictions.** Means of egress ramps shall not reduce the width in the direction of egress travel. Projections into the required ramp and landing width are prohibited. Doors opening onto landing shall not reduce the clear width to less than 42 inches (1067 mm). No door shall swing over the sloping portion of a ramp.

**1010.6 Landings.** Ramps shall have landings at the bottom and top of each ramp, points of turning, entrance, exits and at doors. Landings shall comply with Sections 1010.6.1 through 1010.6.5.

**1010.6.1 Slope.** Landings shall have a slope not steeper than one unit vertical in 48 units horizontal (2-percent slope) in any direction. Changes in level are not permitted.

**1010.6.2 Width.** The landing shall be at least as wide as the widest ramp run adjoining the landing.

**1010.6.3 Length.** The landing length shall be 60 inches (1525 mm) minimum.

**Exception:** Landings in individual dwelling units, that are not Accessible units, or that are not Type B units in Group R-2 occupancies, are permitted to be 36 inches (914mm) minimum.

**1010.6.4 Change in direction.** Where changes in direction of travel occur at landings provided between ramp runs, the landing shall be 60 inches by 60 inches (1524 mm by 1524 mm) minimum.

**Exception:** Landings in individual dwelling units, that are not Accessible units, or that are not Type B units in Group R-2 occupancies, are permitted to be 36 inches by 36 inches (914 mm by 914 mm) minimum.

**1010.6.5 Doorways.** Where doorways are located adjacent to a ramp landing, maneuvering clearances required by ICC A117.1 are permitted to overlap the required landing area.

**1010.7 Ramp construction.** All ramps shall be built of materials consistent with the types permitted for the type of construction of the building; except that wood handrails shall be permitted for all types of construction. Ramps used as an exit shall conform to

the applicable requirements of Sections 1019.1 and 1019.1.1 through 1019.1.3 for vertical exit enclosures.

**1010.7.1 Ramp surface.** The surface of ramps shall be of slip-resistant materials that are securely attached.

**1010.7.2 Outdoor conditions.** Outdoor ramps and outdoor approaches to ramps shall be designed so that water will not accumulate on walking surfaces. In other than occupancies in Group R-3, and occupancies in Group U that are accessory to an occupancy in Group R-3, surfaces and landings which are part of exterior ramps in climates subject to snow or ice shall be designed to minimize the accumulation of same.

**1010.8 Handrails.** Ramps with a rise greater than 6 inches (152 mm) shall have handrails on both sides complying with Section 1009.11.

**1010.9 Edge protection.** Edge protection complying with Section 1010.9.1 shall be provided on each side of ramp runs and at each side of ramp landings not adjoining another ramp run or stairway.

**Exceptions:**

1. Edge protection is not required on ramps not required to have handrails, provided they have flared sides that comply with the ICC A117.1 curb ramp provisions.
2. Edge protection is not required on the sides of ramp landings having a vertical dropoff of not more than 0.5 inch (13 mm) within 10 inches (254 mm) horizontally of the required landing area.
3. Edge protection is not required where the floor or ground surface of the ramp run or landing extends 12 inches (305 mm) minimum beyond the inside face of handrail complying with Section 1012.

**1010.9.1 Curb, rail, wall or barrier.** Edge protection shall be provided as follows:

1. Solid barriers. Solid barriers shall extend at least 4 inches (102 mm) from the floor or ground surface.
2. Other types of barriers. Other types of barriers shall prevent the passage of a 4-inch-diameter (102 mm) sphere, where any portion of the sphere is within 4 inches (102 mm) of the floor or ground surface.

**1010.10 Guards.** Guards shall be provided where required by Section 1012 and shall be constructed in accordance with Section 1012. Such guards may be used to satisfy the requirement of edge protection of Section 1010.9.

## **SECTION BC 1011** **EXIT SIGNS**

**1011.1 Where required.** Exits and exit access doors shall be marked by an approved exit sign readily visible from any direction of egress travel. Access to exits shall be marked by readily visible exit signs in cases where the exit or the path of egress travel is not immediately visible to the occupants. Exit sign placement shall be such that no point in an exit access corridor is more than 100 feet (30 480 mm) or the listed viewing distance for the sign, whichever is less, from the nearest visible exit sign.

### **Exceptions:**

1. Exit signs are not required in rooms or areas which require only one exit or exit access.
2. Exit signs are not required in occupancies in Group U and individual sleeping units or dwelling units in Group R-1, R-2 or R-3. In a dormitory unit where the occupancy of such unit exceeds four people, exit signs shall be provided.
3. Exit signs are not required in sleeping areas in occupancies in Group I-3.
4. In occupancies in Groups A-4 and A-5, exit signs are not required on the seating side of vomitories or openings into seating areas where exit signs provided in the concourse are readily apparent from the vomitories. Such vomitories shall be provided with emergency egress lighting to identify each vomitory or opening within the seating area.

**1011.1.1 Signs within exits.** In high-rise buildings subject to Section 403, exit signs shall be placed within exits at horizontal extensions to indicate the transition from vertical to horizontal direction and at turns along the horizontal path.

**1011.2 Illumination.** Exit signs shall be internally or externally illuminated.

**Exception:** Tactile signs required by Section 1011.3 need not be provided with illumination.

**1011.3 Tactile exit signs.** A tactile sign stating EXIT and complying with ICC A117.1 shall be provided adjacent to each door to an egress stairway, an exit passageway and the exit discharge.

**1011.4 Internally illuminated exit signs.** Internally illuminated exit signs shall be listed and labeled and shall be installed in accordance with the manufacturer's instructions and Section 2702. Exit signs shall be illuminated at all times.

**1011.4.1 Color:** The letters of exit signs shall be red.

**1011.4.2 Graphics:** The height of letters shall be not less than 6 inches (152 mm), except that in Group A and Group R-1 occupancies letters shall be not less than 8 inches (203 mm) high. Graphics shall have letter widths, strokes and spacing in proportion to their height.

**1011.5 Externally illuminated exit signs.** Externally illuminated exit signs shall comply with Sections 1011.5.1 through 1011.5.3.

**1011.5.1 Graphics.** Every exit sign and directional exit sign shall have plainly legible letters not less than 6 inches (152 mm) high with the principal strokes of the letters not less than 0.75 inch (19.1 mm ) wide. The word “EXIT” shall have letters having a width not less than 2 inches (51 mm) wide except the letter “I,” and the minimum spacing between letters shall not be less than 0.375 inch (9.5 mm). In Group A and Group R-1 occupancies letters shall be not less than 8 inches (203 mm) high. Signs larger than the minimum established in this section shall have letter widths, strokes and spacing in proportion to their height.

The word “EXIT” shall be in high contrast with the background and shall be clearly discernible when the exit sign illumination means is or is not energized. The letters of exit signs shall be red. If an arrow is provided as part of the exit sign, the construction shall be such that the arrow direction cannot be readily changed.

**1011.5.2 Exit sign illumination.** The face of an exit sign illuminated from an external source shall have an intensity of not less than 25 foot-candles (269.1 lux).

**1011.5.3 Power source.** Exit signs shall be illuminated at all times. To ensure continued illumination for a duration of not less than 90 minutes in case of primary power loss, the sign illumination means shall be connected to an emergency power system provided from storage batteries, unit equipment or an on-site generator. The installation of the emergency power system shall be in accordance with Section 2702.

## **SECTION BC 1012** **GUARDS**

**1012.1 Where required.** Guards shall be located along open-sided walking surfaces, mezzanines, industrial equipment platforms, stairways, ramps and landings which are located more than 30 inches (762 mm) above the floor or grade below. Guards shall be adequate in strength and attachment in accordance with Section 1607.7. Guards shall also be located along glazed sides of stairways, ramps and landings that are located more than 30 inches (762 mm) above the floor or grade below where the glazing provided does not meet the strength and attachment requirements in Section 1607.7.

**Exception:** Guards are not required for the following locations:

1. On the loading side of loading docks or piers.
2. On the audience side of stages and raised platforms, including steps leading

up to the stage and raised platforms.

3. On raised stage and platform floor areas such as runways, ramps and side stages used for entertainment or presentations.
4. At vertical openings in the performance area of stages and platforms.
5. At elevated walking surfaces appurtenant to stages and platforms for access to and utilization of special lighting or equipment.
6. Along vehicle service pits not accessible to the public.
7. In assembly seating where guards in accordance with Section 1024.14 are permitted and provided.

**1012.2 Height.** Guards shall form a protective barrier not less than 42 inches (1067 mm) high, measured vertically above the leading edge of the tread, adjacent walking surface or adjacent seatboard.

**Exceptions:**

1. For occupancies in Group R-3, and within individual dwelling units in occupancies in Group R-2, guards whose top rail also serves as a handrail shall have a height not less than 34 inches (864 mm) and not more than 38 inches (965 mm) measured vertically from the leading edge of the stair tread nosing.
2. The height in assembly seating areas shall be in accordance with Section 1024.14.

**1012.3 Opening limitations.** Open guards shall have balusters or ornamental patterns such that a 4-inch-diameter (102 mm) sphere cannot pass through any opening up to a height of 34 inches (864 mm). From a height of 34 inches (864 mm) to 42 inches (1067 mm) above the adjacent walking surfaces, a sphere 8 inches (203 mm) in diameter shall not pass.

**Exceptions:**

1. The triangular openings formed by the riser, tread and bottom rail at the open side of a stairway shall be of a maximum size such that a sphere of 6 inches (152 mm) in diameter cannot pass through the opening.
2. At elevated walking surfaces for access to and use of electrical, mechanical or plumbing systems or equipment, guards shall have balusters or be of solid materials such that a sphere with a diameter of 21 inches (533 mm) cannot pass through any opening.

3. In areas which are not open to the public within occupancies in Group I-3, F, H or S, balusters, horizontal intermediate rails or other construction shall not permit a sphere with a diameter of 21 inches (533 mm) to pass through any opening.
4. In assembly seating areas, guards at the end of aisles where they terminate at a fascia of boxes, balconies and galleries shall have balusters or ornamental patterns such that a 4-inch-diameter (102 mm) sphere cannot pass through any opening up to a height of 26 inches (660 mm). From a height of 26 inches (660 mm) to 42 inches (1067 mm) above the adjacent walking surfaces, a sphere 8 inches (203 mm) in diameter shall not pass.

**1012.4 Screen porches.** Porches and decks which are enclosed with insect screening shall be provided with guards where the walking surface is located more than 30 inches (762 mm) above the floor or grade below.

**1012.5 Mechanical equipment.** Guards shall be provided where appliances, equipment, fans or other components that require service are located within 10 feet (3048 mm) of a roof edge or open side of a walking surface and such edge or open side is located more than 30 inches (762 mm) above the floor, roof or grade below. The guard shall be constructed so as to prevent the passage of a 21-inch-diameter (533 mm) sphere.

## **SECTION BC 1013** **EXIT ACCESS**

**1013.1 General.** The exit access arrangement shall comply with Sections 1013 through 1016 and the applicable provisions of Sections 1003 through 1012.

**1013.2 Egress through intervening spaces.** Egress from a room or space shall not pass through adjoining or intervening rooms or areas, except where such adjoining rooms or areas are accessory to the area served; are not a high-hazard occupancy and provide a discernible path of egress travel to an exit. Egress shall not pass through kitchens, storage rooms, closets or spaces used for similar purposes. An exit access shall not pass through a room that can be locked to prevent egress. Means of egress from dwelling units or sleeping areas shall not lead through other sleeping areas, toilet rooms or bathrooms.

### **Exceptions:**

1. Means of egress are not prohibited through a kitchen area serving adjoining rooms constituting part of the same dwelling unit or sleeping unit.
2. Means of egress are not prohibited through adjoining or intervening rooms or spaces in a Group H occupancy when the adjoining or intervening rooms or spaces are the same or a lesser hazard occupancy group.

**1013.2.1 Multiple tenants.** Where more than one tenant occupies any one floor of a



building or structure, each tenant space, dwelling unit and sleeping unit shall be provided with access to the required exits without passing through adjacent tenant spaces, dwelling units and sleeping units.

**1013.2.2 Group I-2.** Patient sleeping rooms or suites in Group I-2 occupancies shall have an exit access door leading directly to an exit access corridor.

**Exceptions:**

1. Rooms with exit doors opening directly to the outside at ground level.
2. Patient sleeping rooms are permitted to have one intervening room if the intervening room is not used as an exit access for more than eight patient beds.
3. Special nursing suites are permitted to have one intervening room where the arrangement allows for direct and constant visual supervision by nursing personnel.
4. For rooms other than patient sleeping rooms, suites of rooms are permitted to have one intervening room if the travel distance within the suite to the exit access door is not greater than 100 feet (30 480 mm) and are permitted to have two intervening rooms where the travel distance within the suite to the exit access door is not greater than 50 feet (15 240 mm).

Suites of sleeping rooms shall not exceed 5,000 square feet (465 m<sup>2</sup>). Suites of rooms, other than patient sleeping rooms, shall not exceed 10,000 square feet (929 m<sup>2</sup>). Any patient sleeping room, or any suite that includes patient sleeping rooms, of more than 1,000 square feet (93 m<sup>2</sup>) shall have at least two exit access doors remotely located from each other. Any room or suite of rooms, other than patient sleeping rooms, of more than 2,500 square feet (232 m<sup>2</sup>) shall have at least two access doors remotely located from each other. The travel distance between any point in a Group I-2 occupancy and an exit access door in the room shall not exceed 50 feet (15 240 mm). The travel distance between any point in a suite of sleeping rooms and an exit access door of that suite shall not exceed 100 feet (30 480 mm).

**1013.3 Common path of egress travel.** In occupancies other than Groups H-1, H-2 and H-3, the common path of egress travel shall not exceed 75 feet (22 860 mm). In occupancies in Groups H-1, H-2, and H-3, the common path of egress travel shall not exceed 25 feet (7620 mm).

**Exceptions:**

1. The length of a common path of egress travel in an occupancy in Groups B, F and S shall not be more than 100 feet (30 480 mm), provided that the building is equipped throughout with an automatic sprinkler system installed in

accordance with Section 903.3.1.1.

2. Where a tenant space in an occupancy in Groups B, S and U has an occupant load of not more than 30, the length of a common path of egress travel shall not be more than 100 feet (30 480 mm).
3. The length of a common path of egress travel in occupancies in Group I-3 shall not be more than 100 feet (30 480 mm).

**1013.4 Aisles.** Aisles serving as a portion of the exit access in the means of egress system shall comply with the requirements of this section. Aisles shall be provided from all occupied portions of the exit access which contain seats, tables, furnishings, displays and similar fixtures or equipment. Aisles serving assembly areas, other than seating at tables, shall comply with Section 1024. Aisles serving reviewing stands, grandstands and bleachers shall also comply with Section 1024.

The required width of aisles shall be unobstructed.

**Exception:** Doors, when fully opened, and handrails shall not reduce the required width by more than 7 inches (178 mm). Doors in any position shall not reduce the required width by more than one-half. Other nonstructural projections such as trim and similar decorative features are permitted to project into the required width 1.5 inches (38 mm) from each side.

**1013.4.1 Groups B and M.** In Group B and M occupancies, the minimum clear aisle width shall be determined by Section 1005.1 for the occupant load served, but shall not be less than 36 inches (914 mm).

**Exception:** Nonpublic aisles serving less than 50 people, and not required to be accessible by Chapter 11 need not exceed 28 inches (711 mm) in width.

**1013.4.2 Seating at tables.** Where seating is located at a table or counter and is adjacent to an aisle or aisle accessway, the measurement of the minimum aisle width shall start at a line 19 inches (483 mm) away from the table side or edge for the purpose of providing space for the seat without obstructing the aisle or aisle accessway. In the case of other side boundaries for aisle or aisle accessways, the clear width shall be measured to walls, edges of seating and tread edges, except that handrail projections are permitted.

**Exception:** Where tables or counters are served by fixed seats, the width of the aisle accessway shall be measured from the back of the seat.

**1013.4.2.1 Aisle accessway for tables and seating.** Aisle accessways serving arrangements of seating at tables or counters shall have sufficient clear width to conform to the capacity requirements of Section 1005.1.

**1013.4.2.2 Table and seating accessway width.** Aisle accessways shall provide a minimum of 12 inches (305 mm) of width plus 0.5 inch (12.7 mm) of width for each additional 1 foot (305 mm), or fraction thereof, beyond 12 feet (3658 mm) of aisle accessway length measured from the center of the seat farthest from an aisle.

**Exception:** Portions of an aisle accessway having a length not exceeding 6 feet (1829 mm) and used by a total of not more than four persons.

**1013.4.2.3 Table and seating aisle accessway length.** The length of travel along the aisle accessway shall not exceed 30 feet (9144 mm) from any seat to the point where a person has a choice of two or more paths of egress travel to separate exits.

**1013.5 Egress balconies.** Balconies used for egress purposes shall conform to the same requirements as corridors for width, headroom, dead ends and projections. Exterior balconies shall be designed to minimize accumulation of snow or ice that impedes the means of egress.

**Exception:** Exterior balconies and concourses in outdoor stadiums shall be exempt from the design requirement to protect against the accumulation of snow or ice.

**1013.5.1 Wall separation.** Exterior egress balconies shall be separated from the interior of the building by walls and opening protectives as required for corridors.

**Exception:** Separation is not required where the exterior egress balcony is served by at least two stairs and where any dead-end portion of the balcony is separated.

**1013.5.2 Openness.** The long side of an egress balcony shall be at least 50 percent open, and the open area above the guards shall be so distributed as to minimize the accumulation of smoke or toxic gases.

**1013.6 Exit access in R-2 occupancies.** In buildings in occupancy Group R-2 exceeding three stories or more in height or occupied by more than two dwelling units on any story, a door from a dwelling unit shall open into an intervening public hall. Such public hall shall be constructed as a public corridor in accordance with Section 1016. Where two or more exits are required, such public hall shall provide access to at least two exits.

**Exception:** An intervening public hall shall not be required in buildings complying with Item 4 of Section 1018.2.

## **SECTION BC 1014** **EXIT AND EXIT ACCESS DOORWAYS**

**1014.1 Exit or exit access doorways required.** Two exits or exit access doorways from any space shall be provided where one of the following conditions exists:

1. The occupant load of the space exceeds the values in Table 1014.1.
2. The common path of egress travel exceeds the limitations of Section 1013.3.
3. Where required by Sections 1014.3, 1014.4 and 1014.5.

**Exception:** Group I-2 occupancies shall comply with Section 1013.2.2.

**1014.1.1 Three or more exits.** Access to three or more exits shall be provided from a floor area where required by Section 1018.1.

**TABLE 1014.1**  
**SPACES WITH ONE MEANS OF EGRESS**  
**(Table 1014.1 attached to end of document)**

**1014.2 Exit or exit access doorway arrangement.** Required exits shall be located in a manner that makes their availability obvious. Exits shall be unobstructed at all times. Exit and exit access doorways shall be arranged in accordance with Sections 1014.2.1 and 1014.2.2.

**1014.2.1 Two exits or exit access doorways.** Where two exits or exit access doorways are required from any portion of the exit access, the exit doors or exit access doorways shall be placed a distance apart equal to not less than one-half of the length of the maximum overall diagonal dimension of the building or area to be served measured in a straight line between exit doors or exit access doorways. Stairs sharing any common wall, floors, ceilings, scissor stair assemblies, or other enclosures shall be counted as one exit stairway.

**Exceptions:**

1. Corridor measurements. Where exit enclosures are provided as a portion of the required exit and are interconnected by a 1-hour fire-resistance-rated corridor conforming to the requirements of Section 1016, the required exit separation shall be measured along the shortest direct line of travel within the corridor.
2. Remote location in sprinklered buildings. Where a building is equipped throughout with an automatic sprinkler system in accordance with Section 903.3.1.1 or 903.3.1.2, the separation distance of the exit doors or exit access doorways shall not be less than one-third of the length of the maximum overall diagonal dimension of the area served.
3. R-2 occupancies. In R-2 occupancies, where stairs are enclosed in walls having at least a 2-hour fire-resistance rating and constructed of masonry or masonry equivalent in accordance with department rules:

- 3.1. The exit doors to such stairs shall be placed a distance apart equal to no less than 15 feet (4572 mm); and
  - 3.2. Such stairs shall be permitted to share common walls, floors, ceilings or scissor stairs assemblies or other enclosures provided that the construction separating the stairs is also of at least a 2-hour fire-resistance rating and constructed of masonry or masonry equivalent in accordance with department rules.
4. B occupancies. In Group B occupancies of construction Type I or II not exceeding 60 feet (18 288 mm) in height, not exceeding 2,000 square feet (186 m<sup>2</sup>) on any story and not exceeding a travel distance of 50 feet (15 240 mm) on any story, where stairs are enclosed in walls having at least a 2-hour fire-resistance rating and constructed of masonry or masonry equivalent in accordance with department rules:
- 4.1. The exit doors to such stairs shall be placed a distance apart equal to no less than 15 feet (4572 mm); and
  - 4.2. Such stairs shall be permitted to share common walls, floors, ceilings or scissor stairs assemblies.

**1014.2.2 Three or more exits or exit access doorways.** Where access to three or more exits is required, at least two exit doors or exit access doorways shall be placed a distance apart equal to not less than one-half of the length of the maximum overall diagonal dimension of the area served measured in a straight line between such exit doors or exit access doorways. Additional exits or exit access doorways shall be arranged a reasonable distance apart so that if one becomes blocked, the others will be available.

**Exception:** Where a building is equipped throughout with an automatic sprinkler system in accordance with Section 903.3.1.1 or 903.3.1.2, the separation distance of at least two of the exit doors or exit access doorways shall not be less than one-third of the length of the maximum overall diagonal dimension of the area served.

**1014.3 Boiler, incinerator and furnace rooms.** Two exit access doorways are required in boiler, incinerator and furnace rooms where the area is over 500 square feet (46 m<sup>2</sup>) and any fuel-fired equipment exceeds 400,000 British thermal units (Btu) (422 000 KJ) input capacity. Where two exit access doorways are required, one is permitted to be a fixed ladder or an alternating tread device. Exit access doorways shall be separated by a horizontal distance equal to one-half the maximum horizontal dimension of the room.

**1014.4 Refrigeration machinery rooms.** Machinery rooms larger than 1,000 square feet (93 m<sup>2</sup>) shall have not less than two exits or exit access doors. Where two exit access doorways are required, one such doorway is permitted to be served by a fixed ladder or an alternating tread device. Exit access doorways shall be separated by a horizontal

distance equal to one-half the maximum horizontal dimension of room. All portions of machinery rooms shall be within 150 feet (45 720 mm) of an exit or exit access doorway. An increase in travel distance is permitted in accordance with Section 1015.1. Doors shall swing in the direction of egress travel, regardless of the occupant load served. Doors shall be tight fitting and self-closing.

**1014.5 Refrigerated rooms or spaces.** Rooms or spaces having a floor area of 1,000 square feet (93 m<sup>2</sup>) or more, containing a refrigerant evaporator and maintained at a temperature below 68°F (20°C), shall have access to not less than two exits or exit access doors. Travel distance shall be determined as specified in Section 1015.1, but all portions of a refrigerated room or space shall be within 150 feet (45 720 mm) of an exit or exit access door where such rooms are not protected by an approved automatic sprinkler system. Egress is allowed through adjoining refrigerated rooms or spaces.

**Exception:** Where using refrigerants in quantities limited to the amounts based on the volume set forth in the *New York City Mechanical Code*.

**1014.6 Stage means of egress.** Where two means of egress are required based on the stage size or occupant load, one means of egress shall be provided on each side of the stage.

**1014.6.1 Gallery, gridiron and catwalk means of egress.** The means of egress from lighting and access catwalks, galleries and gridirons shall meet the requirements for occupancies in Group F-2.

**Exceptions:**

1. A minimum width of 22 inches (559 mm) is permitted for lighting and access catwalks.
2. Stairways required by this subsection need not be enclosed.
3. Stairways with a minimum width of 22 inches (559 mm), ladders, alternating tread devices or spiral stairs are permitted in the means of egress.
4. A second means of egress is not required from these areas where a means of escape to a floor or to a roof is provided.

**SECTION BC 1015**  
**EXIT ACCESS TRAVEL DISTANCE**

**1015.1 Travel distance limitations.** Exits shall be so located on each story such that the maximum length of exit access travel, measured from the most remote point within a story to the entrance to an exit along the natural and unobstructed path of egress travel, shall not exceed the distances given in Table 1015.1.

Where the path of exit access includes unenclosed stairways or ramps within the exit access or includes unenclosed exit ramps or stairways as permitted in Section 1019.1, the distance of travel on such means of egress components shall also be included in the travel distance measurement. The measurement along stairways shall be made on a plane parallel and tangent to the stair tread nosings in the center of the stairway.

**Exceptions:**

1. Travel distance in open parking garages is permitted to be measured to the closest riser of open stairs.
2. In outdoor facilities with open exit access components and open exterior stairs or ramps, travel distance is permitted to be measured to the closest riser of a stair or the closest slope of the ramp.
3. Where an exit stair is permitted to be unenclosed in accordance with Exception 8 or 9 of Section 1019.1, the travel distance shall be measured from the most remote point within a building to an exit discharge.

**TABLE 1015.1**  
**EXIT ACCESS TRAVEL DISTANCE**  
**(Table 1015.1 attached to end of document)**

**1015.2 Reserved.**

**1015.3 Exterior egress balcony increase.** Travel distances specified in Section 1015.1 shall be increased up to an additional 100 feet (30 480 mm) provided the last portion of the exit access leading to the exit occurs on an exterior egress balcony constructed in accordance with Section 1013.5. The length of such balcony shall not be less than the amount of the increase taken.

**SECTION BC 1016**  
**CORRIDORS**

**1016.1 Construction.** Corridors shall be constructed in accordance with this section. Interior corridor walls required to be fire-resistance rated shall comply with Section 708 for fire partitions. Public corridor walls shall comply with Section 706 for fire barriers.

**1016.1.1 Interior corridors.** Interior corridors shall be fire-resistance rated in accordance with Table 1016.1.1.

**Exceptions:**

1. A fire-resistance rating is not required for corridors in an occupancy in Group E where each room that is used for instruction has at least one

door directly to the exterior and rooms for assembly purposes have at least one-half of the required means of egress doors opening directly to the exterior. Exterior doors specified in this exception are required to be at ground level.

2. A fire-resistance rating is not required for corridors contained within a dwelling or sleeping unit in an occupancy in Group R.
3. A fire-resistance rating is not required for corridors in open parking garages.
4. A fire-resistance rating is not required for corridors in an occupancy in Group B which is a space requiring only a single means of egress complying with Section 1014.1.

**TABLE 1016.1.1**  
**INTERIOR CORRIDOR FIRE-RESISTANCE RATING**  
**(Table 1016.1.1 attached to end of document)**

**1016.1.2 Public corridors.** Public corridors shall be fire-resistance rated in accordance with Table 1016.1.2.

**TABLE 1016.1.2**  
**PUBLIC CORRIDOR FIRE-RESISTANCE RATING**  
**(Table 1016.1.2 attached to end of document)**

**1016.2 Corridor width.** The minimum corridor width shall be as determined in Section 1005.1, but not less than 44 inches (1118 mm).

**Exceptions:**

1. Twenty-four inches (610 mm)—For access to and utilization of electrical, mechanical or plumbing systems or equipment.
2. Thirty-six inches (914 mm)—With a required occupant capacity of 50 or less, except as otherwise required by Chapter 11.
3. Thirty-six inches (914 mm)—Within a dwelling unit in occupancy Groups I-1 and R-1, except as otherwise required by Section 1107.
4. Thirty inches (762 mm) —Within a dwelling unit in occupancy Groups R-2 and R-3, except as otherwise required by Section 1107.
5. Sixty-six inches (1676 mm)—In Group E serving classrooms.
6. Seventy-two inches (1829 mm)—In corridors serving surgical Group I, health



care centers for ambulatory patients receiving outpatient medical care, which causes the patient to be not capable of self-preservation.

7. Ninety-six inches (2438 mm)—In Group I-2 in areas where required for bed movement.

**1016.3 Dead ends.** Where more than one exit or exit access doorway is required, the exit access shall be arranged such that there are no dead ends in corridors more than 20 feet (6096 mm) in length.

**Exceptions:**

1. In occupancies in Group I-3 of Occupancy Condition 2, 3 or 4 (see Section 308.4), the dead end in a corridor shall not exceed 50 feet (15 240 mm).
2. In occupancies in Groups B and F where the building is equipped throughout with an automatic sprinkler system in accordance with Section 903.3.1.1, the length of dead-end corridors shall not exceed 50 feet (15 240 mm).
3. Dead-end length not exceeding 2.5 times the least width of the dead-end corridor.
4. In occupancies in Group R-2, the dead end in a corridor shall not exceed 40 feet (12 192 mm). However, where the corridors are completely enclosed in construction having a 2-hour fire-resistance rating with all doors opening into the corridor being self-closing and having a fire-resistance rating of 1½ hours, the length of dead-end corridor shall not exceed 80 feet (24 384 mm).

**1016.4 Air movement in corridors.** Use of corridors as part of direct supply, return, or exhaust air system shall be subject to the limitations of the *New York City Mechanical Code*.

**1016.4.1 Corridor ceiling.** Use of the space between the corridor ceiling and the floor or roof structure above as a return air plenum shall be in accordance with the *New York City Mechanical Code*.

**1016.5 Corridor continuity.** Fire-resistance-rated corridors shall be continuous from the point of entry to an exit, and shall not be interrupted by intervening rooms.

**Exception:** Foyers, lobbies or reception rooms constructed as required for corridors shall not be construed as intervening rooms.

**SECTION BC 1017**  
**EXITS**

**1017.1 General.** Exits shall comply with Sections 1017 through 1022 and the applicable requirements of Sections 1003 through 1012. An exit shall not be used for any purpose

that interferes with its function as a means of egress. Once a given level of exit protection is achieved, such level of protection shall not be reduced until arrival at the exit discharge.

**1017.2 Exterior exit doors.** Buildings or structures used for human occupancy shall have at least one exterior door that meets the requirements of Section 1008.1.1.

**1017.2.1 Detailed requirements.** Exterior exit doors shall comply with the applicable requirements of Section 1008.1.

**1017.2.2 Arrangement.** Exterior exit doors shall lead directly to the exit discharge or the public way.

## **SECTION BC 1018** **NUMBER OF EXITS AND CONTINUITY**

**1018.1 Minimum number of exits.** All rooms and spaces within each story shall be provided with and have access to the minimum number of approved independent exits as required by Table 1018.1 based on the occupant load of such story, except as modified in Section 1018.2. For the purposes of this chapter, occupied roofs shall be provided with exits as required for stories. The required number of exits from any story, basement or individual space shall be maintained until arrival at grade or the public way.

**Exception:** Unless otherwise required by other provisions of this chapter, the number of exits from ground floors discharging at grade directly to the exterior shall be determined in accordance with Table 1014.1.

### **TABLE 1018.1** **MINIMUM NUMBER OF EXITS FOR OCCUPANT LOAD** **(Table 1018.1 attached to end of document)**

**1018.1.1 Open parking garages.** Parking garages shall not have less than two exits from each parking tier. An unenclosed vehicle ramp constructed in accordance with Section 1010.2 may serve as one of the required exits when provided with pedestrian facilities along the ramp.

**Exception:** Where vehicles are mechanically parked, only one exit is required but such exit shall not be a vehicle ramp.

**1018.1.2 Open or enclosed parking garages.** In open or enclosed parking garages three stories or less in height and serving not more than one level below grade, ramps with a maximum slope of one unit vertical in seven units horizontal may serve as secondary exits.

**1018.2 Buildings with one exit.** Only one exit shall be required in buildings as described below:

1. Buildings described in Table 1018.2, provided that the building has not more than one level below the first story above grade plane.
2. Buildings of Group R-3 occupancy.
3. Single-level buildings with the occupied space at the level of exit discharge provided that the story or space complies with Section 1014.1 as a space with one means of egress.
4. Buildings of Group R-2 occupancy where all of the following conditions are met:
  - 4.1. The building does not exceed four stories;
  - 4.2. The building contains not more than three dwelling units per story;
  - 4.3. The building is of construction Type I or II;
  - 4.4. The building does not exceed 2,500 square feet (232 m<sup>2</sup>) per story;
  - 4.5. Each dwelling unit has at least one window facing the street, or facing a lawful yard with open, unobstructed, and direct access to the street;
  - 4.6. The stairway extends to the roof surface through a stairway bulkhead complying with Section 1509.2 provided the roof has a slope not steeper than 20 degrees. In lieu of the stairway bulkhead, the stair may be constructed against the street wall with one window facing the street at every landing and access to the roof is provided via a scuttle with a ladder;
  - 4.7. The stairway is enclosed in two-hour fire-rated walls with all exit doors leading into the stairway having at least 1 ½ hour fire-rating; and
  - 4.8 The building shall be equipped throughout with an automatic sprinkler system in accordance with Section 903.3.1.2.
5. Buildings of Group R-2 occupancy of construction Type I or II not exceeding six stories and not exceeding 2,000 square feet (186 m<sup>2</sup>) per story.

**TABLE 1018.2**  
**BUILDINGS WITH ONE EXIT**  
**(Table 1018.2 attached to end of document)**

**1018.3 Exit continuity.** Exits shall be continuous from the point of entry into the exit to the exit discharge.

**1018.4 Exit door arrangement.** Exit door arrangement shall meet the requirements of

Sections 1014.2 through 1014.2.2.

**SECTION BC 1019**  
**VERTICAL EXIT ENCLOSURES**

**1019.1 Enclosures required.** Interior exit stairways and interior exit ramps shall be enclosed with fire barriers. Exit enclosures shall have a fire-resistance rating of not less than 2 hours where connecting four stories or more and not less than 1 hour where connecting less than four stories. The number of stories connected by the shaft enclosure shall include any basements but not any mezzanines. An exit enclosure shall not be used for any purpose other than means of egress. Enclosures shall be constructed as fire barriers in accordance with Section 706.

**Exceptions:**

1. In other than Group H and I occupancies, a stairway serving an occupant load of less than 10 and not more than one story above the level of exit discharge is not required to be enclosed.
2. Exits in buildings of Group A-5 where all portions of the means of egress are essentially open to the outside need not be enclosed.
3. Stairways serving and contained within a single residential dwelling unit or sleeping unit in occupancies in Group R-1, R-2 or R-3 are not required to be enclosed.
4. Stairways that are not a required means of egress element are not required to be enclosed where such stairways comply with Section 707.2.
5. Stairways in open parking structures which serve only the parking structure are not required to be enclosed.
6. Stairways in occupancies in Group I-3 shall be permitted to have glazing installed in doors and interior walls as provided for in Section 408.3.6.
7. Means of egress stairways as required by Section 410.5.4 are not required to be enclosed.
8. In other than occupancy Groups H and I, a maximum of 50 percent of egress stairways serving one adjacent floor are not required to be enclosed, provided at least two means of egress are provided from both floors served by the unenclosed stairways. Any two such interconnected floors shall not be open to other floors.
9. In other than occupancy Groups H and I, interior egress stairways serving only the first and second stories of a building equipped throughout with an

automatic sprinkler system in accordance with Section 903.3.1.1 are not required to be enclosed, provided at least two means of egress are provided from both floors served by the unenclosed stairways. Such interconnected stories shall not be open to other stories.

10. In Group R-1 and R-2 occupancies, where exit enclosures are required to have a fire-resistance rating of 2 hours, such enclosures shall be constructed of masonry or masonry equivalent. Wall assemblies constituting masonry equivalent shall be constructed in accordance with department rules.

**1019.1.1 Openings.** Exit enclosure opening protectives shall be in accordance with the requirements of Section 715.

Except as permitted in Section 402.4.6, openings in exit enclosures other than unexposed exterior openings shall be limited to those necessary for exit access to the enclosure from normally occupied spaces and for egress from the enclosure.

Where interior exit enclosures are extended to the exterior of a building by an exit passageway, the door assembly from the exit enclosure to the exit passageway shall be protected by a fire door conforming to the requirements in Section 715.3. Fire door assemblies in exit enclosures shall comply with Section 715.3.4.

**1019.1.2 Penetrations.** Penetrations into and openings through an exit enclosure are prohibited except for required exit doors, equipment and ductwork necessary for independent pressurization, sprinkler piping, standpipes, electrical raceway for Fire Department communication and electrical raceway serving the exit enclosure and terminating at a steel box not exceeding 16 square inches (0.010m<sup>2</sup>). Such penetrations shall be protected in accordance with Section 712. There shall be no penetrations or communication openings, whether protected or not, between adjacent exit enclosures.

**1019.1.3 Ventilation.** Equipment and ductwork for exit enclosure ventilation necessary for independent pressurization shall comply with one of the following items:

1. Such equipment and ductwork shall be located exterior to the building and shall be directly connected to the exit enclosure by ductwork enclosed in construction as required for shafts.
2. Where such equipment and ductwork is located within the exit enclosure, the intake air shall be taken directly from the outdoors and the exhaust air shall be discharged directly to the outdoors, or such air shall be conveyed through ducts enclosed in construction as required for shafts.
3. Where located within the building, such equipment and ductwork shall be separated from the remainder of the building, including other mechanical

equipment, with construction as required for shafts. In each case, openings into the fire-resistance-rated construction shall be limited to those needed for maintenance and operation and shall be protected by self-closing fire-resistance-rated devices in accordance with Chapter 7 for enclosure wall opening protectives. Exit enclosure ventilation systems shall be independent of other building ventilation systems.

**1019.1.4 Vertical enclosure exterior walls.** Exterior walls of a vertical exit enclosure shall comply with the requirements of Section 704 for exterior walls. Where nonrated walls or unprotected openings enclose the exterior of the stairway and the walls or openings are exposed to other parts of the building at an angle of less than 180 degrees (3.14 rad), the building exterior walls within 10 feet (3048 mm) horizontally of a nonrated wall or unprotected opening shall be constructed as required for a minimum 1-hour fire-resistance rating with ¾-hour opening protectives. This construction shall extend vertically from the ground to a point 10 feet (3048 mm) above the topmost landing of the stairway or to the roof line, whichever is lower.

**1019.1.5 Enclosures under stairways.** The walls and soffits within enclosed usable spaces under enclosed and unenclosed stairways shall be protected by 1-hour fire-resistance-rated construction, or the fire-resistance rating of the stairway enclosure, whichever is greater. Access to the enclosed usable space shall not be directly from within the stair enclosure.

**Exception:** Spaces under stairways serving and contained within a single residential dwelling unit in Group R-2 or R-3.

There shall be no enclosed usable space under exterior exit stairways unless the space is completely enclosed in 1-hour fire-resistance-rated construction. The open space under exterior stairways shall not be used for any purpose.

**1019.1.6 Discharge identification.** A stairway in an exit enclosure shall not continue below the level of exit discharge unless an approved barrier is provided at the level of exit discharge to prevent persons from unintentionally continuing into levels below. Directional exit signs shall be provided as specified in Section 1011. An approved barrier shall consist of one-hour rated construction separating the portion of the vertical exit above grade from the portion below grade, with a three-quarter hour rated self-closing door, opening in the direction of exit travel from the floors below grade.

**Exception:** Such barrier separating the above grade portion of the vertical exit from the portion below grade shall not be required in Group E and R-3 occupancies.

**1019.1.7 Stairway floor number and identification signs.** A sign shall be provided at each floor landing in interior vertical exit enclosures connecting more than three stories designating the floor level, the terminus of the top and bottom of the stair

enclosure and the identification of the stair. The signage shall also state the story of, and the direction to the exit discharge and the availability of roof access from the stairway for the Fire Department. Each stair shall be identified by an alphabetic letter. Stairway identification signs shall be provided on both sides of each stair door. The signs shall be located 5 feet (1524 mm) above the floor landing in a position which is readily visible when the doors are in the open and closed positions.

**1019.1.8 Smokeproof enclosures.** In buildings required to comply with Section 403.13 or 405.8.2, each of the exits of a building that serves stories where the floor surface is located more than 75 feet (22 860 mm) above the lowest level of Fire Department vehicle access or more than 30 feet (9144 mm) below the level of exit discharge serving such floor levels shall be a smokeproof enclosure or pressurized stairway in accordance with Section 909.20.

**1019.1.8.1 Enclosure exit.** A smokeproof enclosure or pressurized stairway shall exit into a public way or into an exit passageway, yard or open space having direct access to a public way. The exit passageway shall be without other openings and shall be separated from the remainder of the building by 2-hour fire-resistance-rated construction.

**Exceptions:**

1. Openings in the exit passageway serving a smokeproof enclosure are permitted where the exit passageway is protected and pressurized in the same manner as the smokeproof enclosure, and openings are protected as required for access from other floors.
2. Openings in the exit passageway serving a pressurized stairway are permitted where the exit passageway is protected and pressurized in the same manner as the pressurized stairway.
3. A smokeproof enclosure or pressurized stairway shall be permitted to egress through areas on the level of discharge or vestibules as permitted by Section 1023.

**1019.1.8.2 Enclosure access.** Access to the stairway within a smokeproof enclosure shall be by way of a vestibule or an open exterior balcony.

**Exceptions:** Access is not required by way of a vestibule or exterior balcony for stairways using the pressurization alternative complying with Section 909.20.5.

**SECTION BC 1020**  
**EXIT PASSAGEWAYS**

**1020.1 Exit passageway.** Exit passageways serving as an exit component in a means of

egress system shall comply with the requirements of this section. An exit passageway shall not be used for any purpose other than as a means of egress.

**1020.2 Width.** The width of exit passageways shall be determined as specified in Section 1005.1 but such width shall not be less than 44 inches (1118 mm), except that exit passageways serving an occupant load of less than 50 shall not be less than 36 inches (914 mm) in width.

The required width of exit passageways shall be unobstructed.

**Exception:** Doors, when fully opened, and handrails, shall not reduce the required width by more than 7 inches (178 mm). Doors in any position shall not reduce the required width by more than one-half. Other nonstructural projections such as trim and similar decorative features are permitted to project into the required width 1.5 inches (38 mm) on each side.

**1020.3 Construction.** Exit passageway enclosures shall have walls, floors and ceilings of not less than 1-hour fire-resistance rating, and not less than that required for any connecting exit enclosure. Exit passageways shall be constructed as fire barriers in accordance with Section 706.

**1020.4 Openings and penetrations.** Exit passageway opening protectives shall be in accordance with the requirements of Section 715.

Except as permitted in Section 402.4.6, openings in exit passageways other than unexposed exterior openings shall be limited to those necessary for exit access to the exit passageway from normally occupied spaces and for egress from the exit passageway.

Where interior exit enclosures are extended to the exterior of a building by an exit passageway, the door assembly from the exit enclosure to the exit passageway shall be protected by a fire door conforming to the requirements in Section 715.3. Fire door assemblies in exit passageways shall comply with Section 715.3.4.

Elevators shall not open into an exit passageway.

**1020.5 Penetrations.** Penetrations into and openings through an exit passageway are prohibited except for required exit doors, equipment and ductwork necessary for independent pressurization, sprinkler piping, standpipes, electrical raceway for fire department communication and electrical raceway serving the exit passageway and terminating at a steel box not exceeding 16 square inches (0.010 m<sup>2</sup>). Such penetrations shall be protected in accordance with Section 712. There shall be no penetrations or communicating openings, whether protected or not, between adjacent exit passageways.

## **SECTION BC 1021** **HORIZONTAL EXITS**



**1021.1 Horizontal exits.** Horizontal exits serving as an exit in a means of egress system shall comply with the requirements of this section. A horizontal exit shall not serve as the only exit from a portion of a building, and where two or more exits are required, not more than one-half of the total number of exits or total exit width shall be horizontal exits.

**Exceptions:**

1. Horizontal exits are permitted to comprise two-thirds of the required exits from any building or floor area for occupancies in Group I-2.
2. Horizontal exits are permitted to comprise 100 percent of the exits required for occupancies in Group I-3. At least 6 square feet (0.6 m<sup>2</sup>) of accessible space per occupant shall be provided on each side of the horizontal exit for the total number of people in adjoining compartments. Every fire compartment for which credit is allowed in connection with a horizontal exit shall not be required to have a stairway or door leading directly outside, provided the adjoining fire compartments have stairways or doors leading directly outside and are so arranged that egress shall not require the occupants to return through the compartment from which egress originates. The area into which a horizontal exit leads shall be provided with exits adequate to meet the occupant requirements of this chapter, but not including the added occupant capacity imposed by persons entering it through horizontal exits from another area. At least one of its exits shall lead directly to the exterior or to an exit enclosure.

**1021.2 Separation.** The separation between buildings or areas of refuge connected by a horizontal exit shall be provided by a fire wall complying with Section 705 or a fire barrier complying with Section 706 and having a fire-resistance rating of not less than 2 hours. Opening protectives in horizontal exit walls shall also comply with Section 715. The horizontal exit separation shall extend vertically through all levels of the building unless floor assemblies are of 2-hour fire resistance with no unprotected openings.

**Exception:** A fire-resistance rating is not required at horizontal exits between a building area and an above-grade pedestrian walkway constructed in accordance with Section 3104, provided that the distance between connected buildings is more than 20 feet (6096 mm). Horizontal exit walls constructed as fire barriers shall be continuous from exterior wall to exterior wall so as to divide completely the floor served by the horizontal exit.

**1021.3 Opening protectives.** Fire doors in horizontal exits shall be self-closing or automatic-closing when activated by a smoke detector installed in accordance with Section 907.11. Opening protectives in horizontal exits shall be consistent with the fire-resistance rating of the wall. Such doors where located in a cross-corridor condition shall be automatic-closing by activation of a smoke detector installed in accordance with Section 907.11.

**1021.4 Capacity of area of refuge.** The area of refuge of a horizontal exit shall be spaces

occupied by the same tenant or public areas and each such area of refuge shall be adequate to house the original occupant load of the refuge space plus the occupant load anticipated from the adjoining compartment. The anticipated occupant load from the adjoining compartment shall be based on the capacity of the horizontal exit doors entering the area of refuge. The capacity of areas of refuge shall be computed on a net floor area allowance of 3 square feet (0.28 m<sup>2</sup>) for each occupant to be accommodated therein, not including areas of stairways, elevators and other shafts or courts.

**Exception:** The net floor area allowable per occupant shall be as follows for the indicated occupancies:

1. Six square feet (0.6 m<sup>2</sup>) per occupant for occupancies in Group I-3.
2. Fifteen square feet (1.4 m<sup>2</sup>) per occupant for ambulatory occupancies in Group I-2.
3. Thirty square feet (2.8 m<sup>2</sup>) per occupant for nonambulatory occupancies in Group I-2.

## **SECTION BC 1022** **EXTERIOR EXIT RAMPS AND STAIRWAYS**

**1022.1 Exterior exit ramps and stairways.** Exterior exit ramps and stairways serving as an element of a required means of egress shall comply with this section.

**Exception:** Exterior exit ramps and stairways for outdoor stadiums complying with Section 1019.1, Exception 2.

**1022.2 Use in a means of egress.** Exterior exit ramps and stairways shall not be used as an element of a required means of egress for occupancies in Group I-2. For occupancies in other than Group I-2, exterior exit ramps and stairways shall be permitted as an element of a required means of egress for buildings not exceeding six stories or 75 feet (22 860 mm) in height.

**1022.3 Open side.** Exterior exit ramps and stairways serving as an element of a required means of egress shall be open on at least one side. An open side shall have a minimum of 35 square feet (3.3 m<sup>2</sup>) of aggregate open area adjacent to each floor level and the level of each intermediate landing. The required open area shall be located not less than 42 inches (1067 mm) above the adjacent floor or landing level.

**1022.4 Adjoining open areas.** The open areas adjoining exterior exit ramps or stairways shall be either yards, courts or public ways; the remaining sides are permitted to be enclosed by the exterior walls of the building.

**1022.5 Location.** Exterior exit ramps and stairways shall be located in accordance with Section 1023.3.

**1022.6 Exterior ramps and stairway protection.** Exterior exit ramps and stairways shall be separated from the interior of the building as required in Section 1019.1. Openings shall be limited to those necessary for egress from normally occupied spaces.

**Exceptions:**

1. In other than Group R-1 or R-2 occupancies, separation from the interior of the building is not required in buildings that are no more than two stories above grade where the level of exit discharge is the first story above grade.
2. Separation from the interior of the building is not required where the exterior ramp or stairway is served by an exterior ramp and/or balcony that connects two remote exterior stairways or other approved exits, with a perimeter that is not less than 50 percent open. To be considered open, the opening shall be a minimum of 50 percent of the height of the enclosing wall, with the top of the openings no less than 7 feet (2134 mm) above the top of the balcony.
3. Separation from the interior of the building is not required for an exterior ramp or stairway located in a building or structure that is permitted to have unenclosed interior stairways in accordance with Section 1019.1.
4. Separation from the interior of the building is not required for exterior ramps or stairways connected to open-ended corridors, provided that Items 4.1 through 4.4 are met:
  - 4.1. The building, including corridors and ramps and/or stairs, shall be equipped throughout with an automatic sprinkler system in accordance with Section 903.3.1.1 or 903.3.1.2.
  - 4.2. The open-ended corridors comply with Section 1016.
  - 4.3. The open-ended corridors are connected on each end to an exterior exit ramp or stairway complying with Section 1022.
  - 4.4. At any location in an open-ended corridor where a change of direction exceeding 45 degrees (0.79 rad) occurs, a clear opening of not less than 35 square feet (3.3 m<sup>2</sup>) or an exterior ramp or stairway shall be provided. Where clear openings are provided, they shall be located so as to minimize the accumulation of smoke or toxic gases.

**1022.7 Fire towers.** Fire towers may be used as exits in lieu of interior stairs provided they comply with all of the requirements for stairways as per Section 1009, except as modified below.

**1022.7.1 Enclosure.** The enclosing walls of fire towers shall be of noncombustible materials or assemblies having a fire-resistance rating of at least 4 hours. Such walls shall be without openings, except for doors serving as means of egress.

**1022.7.2 Access.** At each story served by a fire tower, access to the stairways of such fire tower shall be provided through outside balconies or fireproof vestibules. Such balconies or vestibules shall be at least 44 inches (1118 mm) in width and shall have unpierced floors of noncombustible materials and shall be provided with substantial guard railings at least 4 feet (1219 mm) high, without any openings greater than 5 inches (127 mm) in width.

**1022.7.3 Balconies and vestibules.** Such balconies or vestibules of fire towers shall be level with the floors of the structure and the platforms of the stairs connected by such balconies. Such balconies or vestibules shall be separated from the structure and the stairs by self-closing swinging doors with a one and one-half hour fire protection rating, capable of being opened from both sides without the use of a key or other unlocking device.

Balconies or vestibules of fire towers shall open on a street or yard, or on a court open vertically to the sky for its full height, having a minimum net area of 105 square feet (9.7 m<sup>2</sup>) and a minimum dimension of 7 feet (2134 mm). The opening from the vestibule to the street, yard or court shall have a minimum area of 18 square feet (1.7 m<sup>2</sup>) and a minimum dimension of 30 inches (762 mm). It shall be unlawful to leave openings in the court walls surrounding an interior fire tower, other than the openings from the vestibules, within 15 feet (4572 mm) of the balcony, except that self-closing windows with a three-quarter hour fire protection rating may be used if such windows are at least 10 feet (3048 mm) from the balcony, provided that the area of the court is at least 12 feet (3658 mm) by 24 feet (7315 mm).

**1022.7.4 Termination.** Fire towers shall terminate at grade level and shall exit directly to the street independently of corridors serving other stairways, except when the fire tower terminates in the ground floor corridor outside of the inner vestibule and within 10 feet (3048 mm) of the building line.

## **SECTION BC 1023** **EXIT DISCHARGE**

**1023.1 General.** Exits shall discharge directly to the exterior of the building. The exit discharge shall be at grade or shall provide direct access to grade. The exit discharge shall not reenter a building.

### **Exceptions:**

1. A maximum of 50 percent of the number and capacity of the exit enclosures is permitted to egress through protected areas on the level of discharge provided all of the following are met:
  - 1.1. Such protected area shall provide a free and unobstructed way to the exterior of the building, which way is readily visible and identifiable from the point of termination of the exit enclosure.

- 1.2. The protected area shall be separated from areas below by construction conforming to the fire-resistance rating for the exit enclosure.
- 1.3. The protected area shall be provided with an approved automatic sprinkler system. All portions of the level of discharge with access to the egress path shall either be protected throughout with an automatic sprinkler system installed in accordance with Section 903.3.1.1 or 903.3.1.2, or separated from the egress path in accordance with the requirements for the enclosure exits.
- 1.4. All spaces and openings communicating with the protected area shall be separated by construction conforming to the fire-resistance rating for the exit enclosure or, if the entire level of discharge in the building is sprinklered in accordance with Section 903.3.1.1 or 903.3.1.2, the separation may comprise smoke barriers complying with Section 709.
- 1.5. The capacity of the protected area shall not be less than required by Section 1023.2 in addition to the occupant load of all exits serving communication spaces.
2. A maximum of 50 percent of the number and capacity of the exit enclosures is permitted to egress through a vestibule provided all of the following are met:
  - 2.1. The entire area of the vestibule is separated from areas below by construction conforming to the fire-resistance rating for the exit enclosure.
  - 2.2. The depth from the exterior of the building is not greater than 10 feet (3048 mm) and the length is not greater than 30 feet (9144mm).
  - 2.3. The area is separated from the remainder of the level of exit discharge by construction providing protection at least the equivalent of approved wired glass in steel frames.
  - 2.4. The area is used only for means of egress and exits directly to the outside.
3. Stairways in open parking garages complying with Section 1019.1, Exception 5, are permitted to egress through the open parking garage at the level of exit discharge.
4. In buildings in occupancy Group R-2, up to 100 percent of the number and capacity of the exit enclosures is permitted to egress through a protected area on the level of discharge, if all of the following conditions are met:

- 4.1. Egress is provided in two different directions from the discharge points of all exit enclosures to the exterior of the building that are remote from each other.
- 4.2. The exit discharges are arranged and constructed so as to minimize the possibility that all exit discharges would be compromised by smoke, fire or other emergency condition, and
- 4.3. Such protected areas shall comply with all requirements of Exception 1, above.

**1023.2 Exit discharge capacity.** The capacity of the exit discharge shall be not less than the required discharge capacity of the exits being served.

**1023.3 Exit discharge location.** Exterior balconies, stairways and ramps shall be located at least 10 feet (3048 mm) from adjacent lot lines and from other buildings on the same lot unless the adjacent building exterior walls and openings are protected in accordance with Section 704 based on fire separation distance.

**Exception:** Noncombustible stoops and ramps not exceeding one story above grade plane located at the street wall and terminating at the street are permitted to be located within 10 feet (3048 mm) of adjacent lot lines or buildings on the same lot in:

1. Buildings in Group R-2 occupancies of noncombustible construction not exceeding four stories in height and a total of four dwelling units.
2. Buildings in Group R-3 occupancies.

**1023.4 Exit discharge components.** Exit discharge components shall be sufficiently open to the exterior so as to minimize the accumulation of smoke and toxic gases.

**1023.5 Egress courts.** Egress courts serving as a portion of the exit discharge in the means of egress system shall comply with the requirements of Section 1023.

**1023.5.1 Width.** The width of egress courts shall be determined as specified in Section 1005.1, but such width shall not be less than 44 inches (1118 mm), except as specified herein. Egress courts serving occupancies in Group R-3 and Group U shall not be less than 36 inches (914 mm) in width. The required width of egress courts shall be unobstructed to a height of 7 feet 6 inches (2286 mm).

Where an egress court exceeds the minimum required width and the width of such egress court is then reduced along the path of exit travel, the reduction in width shall be gradual. The transition in width shall be affected by a guard not less than 36 inches (914 mm) in height and shall not create an angle of more than 30 degrees (0.52 rad) with respect to the axis of the egress court along the path of egress travel. In no case shall the width of the egress court be less than the required minimum.

**1023.5.1.1 Projections.** Doors, when fully opened, and handrails shall not reduce the required width by more than 7 inches (178 mm). Doors in any position shall not reduce the required width by more than one-half. Other nonstructural projections such as trim and similar decorative features are permitted to project into the required width 1.5 inches (38 mm) from each side.

**1023.5.2 Construction and openings.** Where an egress court serving a building or portion thereof is less than 10 feet (3048 mm) in width, the egress court walls shall be not less than 1-hour fire-resistance-rated exterior walls complying with Section 704 for a distance of 10 feet (3048 mm) above the floor of the court, and openings therein shall be equipped with fixed or self-closing, ¾-hour opening protective assemblies.

**Exceptions. Protection of exterior walls shall not be required where:**

1. Egress courts serving an occupant load of less than 10.
2. Egress courts serving Group R-3.

**1023.6 Access to a public way.** The exit discharge shall provide a direct and unobstructed access to a public way.

**Exception:** Where access to a public way cannot be provided, a safe dispersal area shall be provided where all of the following are met:

1. The area shall be of a size to accommodate at least 5 square feet (0.28 m<sup>2</sup>) for each person.
2. The area shall be located on the same property at least 50 feet (15 240 mm) away from the building requiring egress.
3. The area shall be permanently maintained and identified as a safe dispersal area.
4. The area shall be provided with a safe and unobstructed path of travel from the building.

## **SECTION BC 1024** **ASSEMBLY**

**1024.1 General.** Occupancies in Group A shall comply with this section. No place of assembly shall be located within 250 feet (76 200 mm) of any occupancy containing explosive contents.

**1024.1.1 Place of assembly certificate of operation.** It shall be unlawful to occupy any building or space as a place of assembly unless and until a certificate of operation

therefore has been issued by the department pursuant to the provisions of Chapter 1 of Title 28 of the *Administrative Code*.

**1024.1.2 Posted Capacity sign.** Signs shall be posted in all assembly spaces, indicating the number of persons who may legally occupy the space. Signs shall not be required where seating is fixed in place in accordance with an approved plan and no provision is made for standee spaces. Such signs, where required, shall read as follows:



OCCUPANCY BY MORE THAN.....PERSONS  
IS DANGEROUS AND UNLAWFUL

Certificate of Operation No.....Commissioner,  
(where applicable)

Dept. of Buildings, City of New York

**1024.1.2.1 Multiple occupant load sign.** When a space is occupied for multiple purposes involving different occupant loads the sign shall read as follows:

OCCUPANCY BY MORE THAN  
(number)..... PERSONS AS (type of occupancy).....  
OR BY  
(number)..... PERSONS AS (type of occupancy).....  
OR BY  
(number)..... PERSONS AS (type of occupancy).....  
IS DANGEROUS AND UNLAWFUL

Certificate of Operation No.....Commissioner,  
(where applicable)

Dept. of Buildings, City of New York

**1024.1.2.2 Design of capacity signs.** Signs shall be at least 12 inches (305 mm) wide and 16 inches (406 mm) high. The lettering shall be red on a white background. The letters shall be at least 1 inch (25 mm) high and the numerals at least 1¼ inches (32 mm) high. Signs shall be framed under a transparent protective cover, and permanently mounted in a location that is conspicuously visible to a person entering the space. Signs shall be lighted by artificial illumination at all times during occupancy to maintain at least 5 foot candles (54 lux) on the surface of the sign.

**1024.1.3 Approved plans.** In every place of assembly providing seating or other moveable furnishings, copies of approved plans and approved alternate plans shall be kept on the premises. The plans shall be readily available for inspection, and shall provide the following information:

1. For assembly spaces:

1.1. The location of each seat of each tier of seating, along with the number of occupants of each seating section.

- 1.2. The location and number of standees for each standee area.
- 1.3. The total number of occupants of each tier and of the assembly space.
- 1.4. The location and classification of all exits.
2. For safe areas:
  - 2.1. The furniture and equipment arrangement and location.
  - 2.2. The number of occupants to be accommodated.
3. For stage areas:
  - 3.1. The maximum number of occupants, including audience seating on the stage.
  - 3.2. Any conditions limiting the use of the stage area.
  - 3.3. The location of all exits.

These plans shall not be smaller in size than required for one-eighth inch scale plans.

**1024.2 Assembly with occupant load greater than 300.** Buildings or spaces classified in Group A that have an occupant load of greater than 300 shall be provided with a main exit. Such main exit shall be of sufficient width to accommodate not less than one-half of the occupant load, but such width shall not be less than the total required width of all means of egress leading to the exit. Where the main use or dominant occupancy of the building is classified as Group A, the main exit shall front on at least one street or an unoccupied space of not less than 10 feet (3048 mm) in width that adjoins a street or public way. Other additional exits shall provide an egress capacity for at least one-half of the total occupant load served by that level and comply with Section 1014.2.

**Exception:** In assembly occupancies where there is no well-defined main exit or where multiple main exits are provided, exits shall be permitted to be distributed around the perimeter of the building provided that the total width of egress is not less than 100 percent of the required width.

**1024.2.1 Exit classification.** Where the net floor area of an assembly space, exclusive of stage area, is less than 12 square feet (1.1 m<sup>2</sup>) per person, such spaces shall also comply with Section 1024.17.

**1024.3 Reserved.**

**1024.4 Foyers and lobbies.** In Group A-1 occupancies, where persons are admitted to the building at times when seats are not available and are allowed to wait in a lobby or

similar space, such use of lobby or similar space shall not encroach upon the required clear width of the means of egress. Such waiting areas shall be separated from the required means of egress by substantial permanent partitions or by fixed rigid railings not less than 42 inches (1067 mm) high. Such foyer, if not directly connected to a public street by all the main entrances or exits, shall have a straight and unobstructed corridor or path of travel to every such main entrance or exit.

**1024.5 Interior balcony and gallery means of egress.** For balconies or galleries having a seating capacity of over 50 located in Group A occupancies, at least two means of egress shall be provided, one from each side of every balcony or gallery, with at least one leading directly to an exit.

**1024.5.1 Enclosure of balcony openings.** Interior stairways and other vertical openings shall be enclosed in a vertical exit enclosure as provided in Section 1019.1, except that stairways are permitted to be open between the balcony and the main assembly floor in occupancies such as theaters, churches and auditoriums. At least one accessible means of egress is required from a balcony or gallery level containing accessible seating locations in accordance with Section 1007.3 or 1007.4.

**1024.6 Width of means of egress for assembly.** The clear width of aisles and other means of egress shall comply with this section. The clear width shall be measured to walls, edges of seating and tread edges except for permitted projections.

**1024.6.1 Without smoke protection.** The clear width of aisles and other means of egress shall provide sufficient capacity in accordance with all of the following, as applicable:

1. At least 0.3 inch (7.6 mm) of width for each occupant served shall be provided on stairs having riser heights 7 inches (178 mm) or less and tread depths 11 inches (279 mm) or greater, measured horizontally between tread nosing.
2. At least 0.005 inch (0.127 mm) of additional stair width for each occupant shall be provided for each 0.10 inch (2.5 mm) of riser height above 7 inches (178 mm).
3. Where egress requires stair descent, at least 0.075 inch (1.9 mm) of additional width for each occupant shall be provided on those portions of stair width having no handrail within a horizontal distance of 30 inches (762 mm).
4. Level or ramped means of egress, where slopes are not steeper than one unit vertical in 12 units horizontal (8-percent slope), shall have at least 0.20 inch (5.1 mm) of clear width for each occupant served. Ramped means of egress, where slopes are steeper than one unit vertical in 12 units horizontal (8-percent slope), shall have at least 0.22 inch (5.6 mm) of clear width for each occupant served.

**1024.6.2 Smoke-protected seating.** The clear width of aisles and other means of egress for smoke-protected assembly seating shall be not less than the occupant load served by the egress element multiplied by the appropriate factor in Table 1024.6.2. The total number of seats specified shall be those within a single assembly space and exposed to the same smoke-protected environment. Interpolation is permitted between the specific values shown. A life safety evaluation, complying with NFPA 101, shall be done for a facility utilizing the reduced width requirements of Table 1024.6.2 for smoke-protected assembly seating subject to the approval by the commissioner.

**TABLE 1024.6.2**  
**WIDTH OF AISLES FOR SMOKE-PROTECTED ASSEMBLY**  
**(Table 1024.6.2 attached to end of document)**

**Exception:** For an outdoor smoke-protected assembly with an occupant load not greater than 18,000, the clear width shall be determined using the factors in Section 1024.6.3.

**1024.6.2.1 Smoke control.** Means of egress serving a smoke-protected assembly seating area shall be provided with a smoke control system complying with Section 909 or natural ventilation designed to maintain the smoke level at least 6 feet (1829 mm) above the floor of the means of egress.

**1024.6.2.2 Roof height.** A smoke-protected assembly seating area with a roof shall have the lowest portion of the roof deck not less than 15 feet (4572 mm) above the highest aisle or aisle accessway.

**Exception:** A roof canopy in an outdoor stadium shall be permitted to be less than 15 feet (4572 mm) above the highest aisle or aisle accessway provided that there are no objects less than 80 inches (2032 mm) above the highest aisle or aisle accessway.

**1024.6.2.3 Automatic sprinklers.** Enclosed areas with walls and ceilings in buildings or structures containing smoke-protected assembly seating shall be protected with an approved automatic sprinkler system in accordance with Section 903.3.1.1.

**Exceptions:**

1. The floor area used for contests, performances or entertainment provided the roof construction is more than 50 feet (15 240 mm) above the floor level and the use is restricted to low fire hazard uses.
2. Press boxes and storage facilities less than 1,000 square feet (93 m<sup>2</sup>) in area.

3. Outdoor seating facilities where seating and the means of egress in the seating area are essentially open to the outside.

**1024.6.3 Width of means of egress for outdoor smoke-protected assembly.** The clear width in inches (mm) of aisles and other means of egress shall be not less than the total occupant load served by the egress element multiplied by 0.08 (2.0 mm) where egress is by aisles and stairs and multiplied by 0.06 (1.52 mm) where egress is by ramps, corridors, tunnels or vomitories.

**Exception:** The clear width in inches (mm) of aisles and other means of egress shall be permitted to comply with Section 1024.6.2 for the number of seats in the outdoor smoke-protected assembly where Section 1024.6.2 permits less width.

**1024.7 Travel distance.** Exits and aisles shall be so located such that the travel distance to an exit door shall be provided in accordance with Table 1024.7. At least one exit opening shall be available from every attached seat or standee space in an assembly space, or from the most remote point in the space when movable seats are provided or, when no seats are provided, within the primary travel distance limitation listed in Table 1024.7. In addition, an alternate exit opening shall be available from every attached seat or standee space, or from the most remote point when attached seats are not provided within the secondary travel distance limitation listed in Table 1024.7. Such alternate exit openings may serve to satisfy the requirements for primary travel distance for other seats or locations. Exit openings satisfying the primary and secondary travel distance requirements for any one seat or location shall be separated from each other by a distance of at least 25 feet (7620 mm). Where aisles are provided for seating, the distance shall be measured along the aisles and aisle accessway without travel over or on the seats.

**Exception:** Smoke-protected assembly seating: The travel distance from each seat to the nearest entrance to a vomitory or concourse shall not exceed 200 feet (60 960 mm). The travel distance from the entrance to the vomitory or concourse to a stair, ramp or walk on the exterior of the building shall not exceed 200 feet (60 960 mm).

**TABLE 1024.7**  
**TRAVEL DISTANCE**  
**(Table 1024.7 attached to end of document)**

**1024.8 Common path of travel.** The common path of travel shall not exceed 30 feet (9144 mm) from any seat to a point where a person has a choice of two paths of egress travel to two exits.

**Exceptions:**

1. For areas such as box seats, galleries or balconies serving not more than 50 occupants, the common path of travel shall not exceed 75 feet (22 860 mm).
2. For smoke-protected assembly seating, the common path of travel shall not exceed 50 feet (15 240 mm).

**1024.9 Assembly aisles are required.** Every occupied portion of any occupancy in Group A that contains seats, tables, displays, similar fixtures or equipment shall be provided with aisles leading to exits or exit access doorways in accordance with this section. Aisle accessways for tables and seating shall comply with Section 1013.4.2.

**1024.9.1 Minimum aisle width.** The minimum clear width of aisles shall be as shown:

1. Forty-eight inches (1219 mm) for aisle stairs having seating on each side.

**Exception:** Thirty-six inches (914 mm) where the aisle does not serve more than 50 seats.

2. Thirty-six inches (914 mm) for aisle stairs having seating on only one side.
3. Twenty-three inches (584 mm) between an aisle stair handrail or guard and seating where the aisle is subdivided by a handrail.
4. Forty-two inches (1067 mm) for level or ramped aisles having seating on both sides.

**Exception:** Thirty-six inches (914 mm) where the aisle does not serve more than 50 seats.

5. Thirty-six inches (914 mm) for level or ramped aisles having seating on only one side.

**1024.9.2 Aisle width.** The aisle width shall provide sufficient egress capacity for the number of persons accommodated by the catchment area served by the aisle. The catchment area served by an aisle is that portion of the total space that is served by that section of the aisle. In establishing catchment areas, the assumption shall be made that there is a balanced use of all means of egress, with the number of persons in proportion to egress capacity.

**1024.9.3 Converging aisles.** Where aisles converge to form a single path of egress travel, the required egress capacity of that path shall not be less than the combined required capacity of the converging aisles.

**1024.9.4 Uniform width.** Those portions of aisles, where egress is possible in either of two directions, shall be uniform in required width.

**1024.9.5 Assembly aisle termination.** Each end of an aisle shall terminate at cross aisle, foyer, doorway, vomitory or concourse having access to an exit.

**Exceptions:**

1. Dead-end aisles shall not be greater than 20 feet (6096 mm) in length.
2. For smoke-protected assembly seating, the dead-end aisle length of vertical aisles shall not exceed a distance of 50 feet (15 240 mm).

**1024.9.6 Assembly aisle obstructions.** There shall be no obstructions in the required width of aisles except for handrails as provided in Section 1024.13.

**1024.10 Clear width of aisle accessways serving seating.** Where seating rows have 14 or fewer seats, the minimum clear aisle accessway width shall not be less than 12 inches (305 mm) measured as the clear horizontal distance from the back of the row ahead and the nearest projection of the row behind. Where chairs have automatic or self-rising seats, the measurement shall be made with seats in the raised position. Where any chair in the row does not have an automatic or self-rising seat, the measurements shall be made with the seat in the down position. For seats with folding tablet arms, row spacing shall be determined with the tablet arm down.

**1024.10.1 Dual access.** For rows of seating served by aisles or doorways at both ends, there shall not be more than 100 seats per row. The minimum clear width of 12 inches (305 mm) between rows shall be increased by 0.3 inch (7.6 mm) for every additional seat beyond 14 seats, but the minimum clear width is not required to exceed 22 inches (559 mm).

**Exception:** For smoke-protected assembly seating, the row length limits for a 12-inch-wide (305 mm) aisle accessway, beyond which the aisle accessway minimum clear width shall be increased, are in Table 1024.10.1.

**TABLE 1024.10.1**  
**SMOKE-PROTECTED**  
**ASSEMBLY AISLE ACCESSWAYS**  
**(Table 1024.10.1 attached to end of document)**

**1024.10.2 Single access.** For rows of seating served by an aisle or doorway at only one end of the row, the minimum clear width of 12 inches (305 mm) between rows shall be provided. Not more than eight chairs shall be provided in such row of seating.

**1024.11 Assembly aisle walking surfaces.** Aisles with a slope not exceeding one unit vertical in eight units horizontal (12.5-percent slope) shall consist of a ramp having a slip-resistant walking surface. Aisles with a slope exceeding one unit vertical in eight units horizontal (12.5-percent slope) shall consist of a series of risers and treads that extends across the full width of aisles and complies with Sections 1024.11.1 through 1024.11.3.

**1024.11.1 Treads.** Tread depths shall be a minimum of 11 inches (279 mm) and shall

have dimensional uniformity.

**Exception:** The tolerance between adjacent treads shall not exceed 0.188 inch (4.8 mm).

**1024.11.2 Risers.** Where the gradient of aisle stairs is to be the same as the gradient of adjoining seating areas, the riser height shall not be less than 4 inches (102 mm) nor more than 8 inches (203 mm) and shall be uniform within each flight.

**Exception:** Riser height nonuniformity shall be limited to the extent necessitated by changes in the gradient of the adjoining seating area to maintain adequate sightlines. Where nonuniformities exceed 0.188 inch (4.8 mm) between adjacent risers, the exact location of such nonuniformities shall be indicated with a distinctive marking stripe on each tread at the nosing or leading edge adjacent to the nonuniform risers. Such stripe shall be a minimum of 1 inch (25 mm), and a maximum of 2 inches (51 mm), wide. The edge marking stripe shall be distinctively different from the contrasting marking stripe.

**1024.11.3 Tread contrasting marking stripe.** A contrasting marking stripe shall be provided on each tread at the nosing or leading edge such that the location of each tread is readily apparent when viewed in descent. Such stripe shall be a minimum of 1 inch (25 mm), and a maximum of 2 inches (51 mm), wide.

**Exception:** The contrasting marking stripe is permitted to be omitted where tread surfaces are such that the location of each tread is readily apparent when viewed in descent.

**1024.11.4 Step lighting.** Each step shall have a steplight.

**1024.11.5 Aisle illumination.** Aisles and cross aisles shall be illuminated in accordance with Section 1006.2.

**1024.12 Seat stability.** In places of assembly, the seats shall be securely fastened to the floor.

**Exceptions:**

1. In places of assembly or portions thereof without ramped or tiered floors for seating and with 200 or fewer seats, the seats shall not be required to be fastened to the floor, provided that the seating area has a minimum net floor area of 12 square feet (1.11 m<sup>2</sup>) per person.
2. In places of assembly or portions thereof with seating at tables and without ramped or tiered floors for seating, the seats shall not be required to be fastened to the floor.



3. In places of assembly or portions thereof without ramped or tiered floors for seating and with greater than 200 seats, the seats shall be securely fastened to the floor, or all seats in a row shall be fastened together with a maximum of 12 seats between aisles.
4. In places of assembly where flexibility of the seating arrangement is an integral part of the design and function of the space and seating is on tiered levels, a maximum of 200 seats shall not be required to be fastened to the floor, provided that the seating area has a minimum net floor area of 12 square feet (1.11 m<sup>2</sup>) per person.
5. Groups of seats within a place of assembly separated from other seating by railings, guards, partial height walls or similar barriers with level floors and having no more than 14 seats per group shall not be required to be fastened to the floor.
6. Seats intended for musicians or other performers and separated by railings, guards, partial height walls or similar barriers shall not be required to be fastened to the floor.

**1024.13 Handrails.** Ramped aisles having a slope exceeding one unit vertical in 15 units horizontal (6.7-percent slope) and aisle stairs shall be provided with handrails located either at the side or within the aisle width.

**Exceptions:**

1. Handrails are not required for ramped aisles having a gradient no greater than one unit vertical in eight units horizontal (12.5-percent slope) and seating on both sides.
2. Handrails are not required if, at the side of the aisle, there is a guard that complies with the graspability requirements of handrails.

**1024.13.1 Discontinuous handrails.** Where there is seating on both sides of the aisle, the handrails shall be discontinuous with gaps or breaks at intervals not exceeding five rows to facilitate access to seating and to permit crossing from one side of the aisle to the other. These gaps or breaks shall have a clear width of at least 22 inches (559 mm) and not greater than 36 inches (914 mm), measured horizontally, and the handrail shall have rounded terminations or bends.

**1024.13.2 Intermediate handrails.** Where handrails are provided in the middle of aisle stairs, there shall be an additional intermediate handrail located approximately 12 inches (305 mm) below the main handrail.

**1024.14 Assembly guards.** Assembly guards shall comply with Sections 1024.14.1 through 1024.14.3.

**1024.14.1 Cross aisles.** Cross aisles located more than 30 inches (762 mm) above the floor or grade below shall have guards in accordance with Section 1012. Where an elevation change of 30 inches (762 mm) or less occurs between a cross aisle and the adjacent floor or grade below, guards not less than 26 inches (660 mm) above the aisle floor shall be provided.

**Exception:** Where the backs of seats on the front of the cross aisle project 24 inches (610 mm) or more above the adjacent floor of the aisle, a guard need not be provided.

**1024.14.2 Sightline-constrained guard heights.** Unless subject to the requirements of Section 1024.14.3, a fascia or railing system in accordance with the guard requirements of Section 1012 and having a minimum height of 26 inches (660 mm) shall be provided where the floor or footboard elevation is more than 30 inches (762 mm) above the floor or grade below and the fascia or railing would otherwise interfere with the sightlines of immediately adjacent seating. At bleachers, a guard must be provided where the floor or footboard elevation is more than 24 inches (610 mm) above the floor or grade below and the fascia or railing would otherwise interfere with the sightlines of the immediately adjacent seating.

**1024.14.3 Guards at the end of aisles.** A fascia or railing system complying with the guard requirements of Section 1012 shall be provided for the full width of the aisle where the foot of the aisle is more than 30 inches (762 mm) above the floor or grade below. The fascia or railing shall be a minimum of 36 inches (914 mm) high and shall provide a minimum 42 inches (1067 mm) measured diagonally between the top of the rail and the nosing of the nearest tread.

**1024.14.4 Toe guard at balconies.** An unperforated curb or toe guard at least 12 inches (305 mm) high above the level of the floor shall be provided at the fascia of all balconies.

**1024.15 Bench seating.** Where bench seating is used, the number of persons shall be based on one person for each 18 inches (457 mm) of length of the bench.

**1024.16 Standee areas.** Standee areas may be permitted within assembly spaces provide each standee has a minimum width of 22 inches (559 mm) and a minimum depth of 21 inches (533 mm). Standee areas shall not encroach on the required exit facilities and shall be separated from the space to be left clear for passage by tape, ribbon or other easily broken material, supported by lightweight posts fixed in stationary sockets.

**1024.17 Places of assembly with an occupant load of less than 12 square feet per person.** Places of assembly in which the net floor area, exclusive of stage area, is less than 12 square feet (1.11 m<sup>2</sup>) per person shall have special egress provisions in accordance with this Section.

**1024.17.1 Classification of exit openings.** For the purposes of this Section 1024.17,

exit openings shall be classified as follows:

1. Class 1 - Exit openings that are used for normal entry to the assembly space, and that open directly to a safe area or to an open exterior space.
2. Class 2 - Exit openings that are not used for normal entry to the assembly space, and that open directly to a safe area or to an open exterior space.
3. Class 3 - Exit openings that open from the assembly space into corridors, exit passageways, or vertical exits.

**1024.17.2 Distribution of classes.** The required exit capacity from assembly spaces in which the net floor area, exclusive of stage area, is less than 12 square feet (1.11 m<sup>2</sup>) per person shall be distributed so that exit openings of each class are provided to comply with the following requirements:

1. For assembly spaces in which the mean floor level is not more than 15 feet (4572 mm) above or below the adjoining grade elevation, the exit capacity shall be distributed as follows:
  - 1.1. Class 1- not less than 40 percent.
  - 1.2. Class 2- not more than 60 percent.
  - 1.3. Class 3- not more than 40 percent.
2. For assembly spaces in which the mean floor level is more than 15 feet (4572 mm) above or below the adjoining grade elevation, the exit capacity shall be distributed as follows:
  - 2.1. Class 1 - not less than 60 percent.
  - 2.2. Class 3 - not more than 40 percent.

**1024.17.3 Safe areas.** The capacity of exits from safe areas shall be provided for all occupants of the safe area. Safe areas shall comply with the following requirements:

1. When provided to serve Class 1 or Class 2 exit openings, safe areas shall be separated from assembly spaces by noncombustible construction having a two hour fire-resistance rating, and shall serve as transition areas in the line and direction of exit travel. They shall serve for normal entry to the assembly space and may be used as corridors, lobbies, or lounges.
2. No room or space classified in occupancy Group H, S-1, F-1 or F-2 shall open upon a safe area.
3. Safe areas shall be at a level not more than 6 feet (1829 mm) above or below the level at which egress is made from the assembly space.

4. Ventilating systems for safe areas shall not be connected to systems serving any other spaces, unless separated from such systems by fire/smoke dampers actuated by smoke detectors.
5. Collecting safe areas. Places of assembly having more than one assembly space may have a collecting safe area that receives the occupant load discharged into it by other safe areas. Collecting safe areas shall be located within 6 feet (1829 mm) above or below the assembly space nearest to grade.
6. Occupant load. The occupant load of a safe area shall be the aggregate occupant load of all exit openings discharging directly into it. The occupant load of a collecting safe area shall be the aggregate occupant load of all exit openings discharging directly into it, plus 50 percent of the occupant load of other safe areas discharging into it.
7. Dimensions. The clear unobstructed floor area of each safe area shall be sufficient to accommodate the total occupant load of the safe area on the basis of 3 square feet (0.28 m<sup>2</sup>) per person, not including space occupied by furniture or equipment. The minimum dimension of such unobstructed space shall be 8 feet (2438 mm). The width of the unobstructed space shall be measured at right angles to the direction of travel to an exit and shall not be less than required for the occupant load. The height of safe areas shall be at least 8 feet (2438 mm) at all points.
8. Safe areas near grade. When a safe area provides egress to an open exterior space, either directly or through a vestibule, the safe area need not provide the floor area required by this section when the level of discharge from the safe area to the open exterior space is not more than 4 feet (1219 mm) above or below the grade of the open exterior space.

**1024.17.3.1 Unenclosed vertical exits.** Vertical exits leading directly from one safe area to another, or leading from a safe area directly to an open exterior space, need not be enclosed.

**1024.17.3.2 Safe area lighting.** In addition to requirements of Section 1006, safe areas shall be artificially lighted by electrical means at all times during occupancy of a place of assembly so as to provide illumination of at least 5 foot-candles (54 lux) at the level of the floor and on the surface of all stairs, steps, ramps, and escalators within the safe area.

**1024.17.4 Open exterior space.** The following provisions shall apply when an open exterior space is used as an exit discharge:

1. Capacity. Open exterior spaces shall be adequate in width and area to accommodate the accumulated occupant load of all exits discharging into them on the basis of 2 square feet (0.19 m<sup>2</sup>) per person.
2. Minimum dimensions. The minimum dimension of open exterior spaces shall

be 20 feet (6096 mm), except that when the principal entrance to the place of assembly is from an open exterior space, the minimum dimension of this space shall be 30 feet (9144 mm). No open exterior space shall have less than 400 square feet (37 m<sup>2</sup>) of floor area, and floor area shall be measured exclusive of the following:

- 2.1. The area immediately outside any exit door from the place of assembly for a distance perpendicular to the exit doors of 10 feet (3048 mm) for the full width of the exit opening.
- 2.2. The area of steps, platforms, stairs, or ramps within or leading to or from the space.
- 2.3. The area of obstructions such as shrubs, trees, fixed furniture, signs, sculptures, pools, and similar obstructions to occupancy or exit travel.
3. Above or below grade. When an open exterior space is more than 15 feet (4572 mm) above or below the grade of the street or public space to which it discharges, its required area shall be increased by one-third.
4. Egress from open exterior spaces. Exterior exit passageways, ramps, or steps leading from open exterior spaces shall be not less in width than required for the occupant load of all exits discharging into the open exterior space. The width of such exit passageways shall be based on the capacities listed in Table 1005.1, but in no case less than 10 feet (3048 mm).
5. Open exterior spaces. Yards or courts which serve as open exterior spaces shall be artificially lighted by electrical means at all times between sunset and sunrise during occupancy of a place of assembly so as to provide illumination of at least 5 foot-candles (54 lux) at the level of the floor over at least the required area.

## **SECTION BC 1025** **EMERGENCY ESCAPE AND RESCUE**

**1025.1 General.** In addition to the means of egress required by this chapter, provisions shall be made for emergency escape and rescue in Group R and Group I-1 occupancies. Sleeping rooms below the fourth story above grade plane and below grade stories shall have at least one exterior emergency escape and rescue opening in accordance with this section. Where below grade stories contain one or more sleeping rooms, emergency egress and rescue openings shall be required in each sleeping room, but shall not be required in adjoining areas of such below grade story. Such opening shall open directly into a public street, public alley, yard or court.

### **Exceptions:**

1. Buildings equipped throughout with an approved automatic sprinkler system

in accordance with Section 903.3.1.1 or 903.3.1.2.

2. Sleeping rooms provided with a door to a fire-resistance-rated corridor having access to two remote exits in opposite directions.
3. The emergency escape and rescue opening is permitted to open onto a balcony within an atrium in accordance with the requirements of Section 404, provided the balcony provides access to an exit and the dwelling unit or sleeping unit has a means of egress that is not open to the atrium.
4. High-rise buildings in accordance with Section 403.
5. Emergency escape and rescue openings are not required from below grade stories or sleeping rooms which have an exit door or exit access door that opens directly into a public street, public alley, yard, egress court or to an exterior exit balcony that opens to a public street, public alley, yard or egress court.
6. Below grade stories without habitable spaces and having no more than 200 square feet (19 m<sup>2</sup>) in floor area shall not be required to have emergency escape windows.

**1025.2 Minimum size.** Emergency escape and rescue openings shall have a minimum net clear opening of 6 square feet (0.56 m<sup>2</sup>).

**Exception:** The minimum net clear opening for emergency escape and rescue grade-floor openings shall be 5 square feet (0.46 m<sup>2</sup>) unless such opening is required for natural ventilation in accordance with Chapter 12.

**1025.2.1 Minimum dimensions.** The net clear opening height dimension shall not be less than 30 inches (762 mm). The net clear opening width dimension shall not be less than 24 inches (610 mm). The final dimensions shall result in a net clear opening area as required above. The net clear opening dimensions shall be the result of normal operation of the opening.

**1025.3 Maximum height from floor.** Emergency escape and rescue openings shall have the bottom of the clear opening not greater than 36 inches (914 mm) measured from the floor.

**1025.4 Operational constraints.** Emergency escape and rescue openings shall be operational from the inside of the room without the use of keys or tools in accordance with the provisions of Chapter 10 of the *New York City Fire Code*.

**1025.5 Window wells.** An emergency escape and rescue opening with a finished sill height below the adjacent ground level shall be provided with a window well in accordance with Sections 1025.5.1 and 1025.5.2.

**1025.5.1 Minimum size.** The minimum horizontal area of the window well shall be 9 square feet (0.84 m<sup>2</sup>), with a minimum dimension of 36 inches (914 mm). The area of the window well shall allow the emergency escape and rescue opening to be fully opened.

**1025.5.2 Ladders or steps.** Window wells with a vertical depth of more than 44 inches (1118 mm) shall be equipped with an approved permanently affixed ladder or steps. Ladders or rungs shall have an inside width of at least 12 inches (305 mm), shall project at least 3 inches (76 mm) from the wall and shall be spaced not more than 18 inches (457 mm) on center (o.c.) vertically for the full height of the window well. The ladder or steps shall not encroach into the required dimensions of the window well by more than 6 inches (152 mm). The ladder or steps shall not be obstructed by the emergency escape and rescue opening. Ladders or steps required by this section are exempt from the stairway requirements of Section 1009.

## **SECTION BC 1026** **SIGNAGE**

**1026.1 Signage.** Signage shall be provided in accordance with this section.

**1026.2 Exit signs.** Exits signs shall be provided in accordance with Section 1011.

**1026.3 Stairway and elevator identification signs.** Stairway floor number and stairway identification signs shall be provided in accordance with Section 1019.1.7. Elevator identification and emergency signs shall be provided in accordance with Section 3002.3.

**1026.4 Door signs.** For the following buildings, signs shall be posted and maintained on exit stair doors in accordance with this section:

- 1. Buildings or portions thereof classified in occupancy Group B occupied or arranged to be occupied by more than 100 persons above or below the street level or more than a total of 500 persons in the entire building.**
- 2. High-rise buildings subject to Section 403**
- 3. Buildings where any stair side door is locked pursuant to Section 1008.1.8.7.**

**Exception:** Signs shall not be required on exit stair doors opening directly to dwelling or sleeping units in occupancy Group R where permitted by Section 1013.6.

**1026.4.1 Occupied side.** Where re-entry is not provided from a stair to every floor, a sign that reads, “NO RE-ENTRY FROM THIS STAIR” shall be posted on the occupied side of the stair door at every floor.

**1026.4.2 Stair side.** On the stair side, signs shall be posted and maintained at all stair doors at every floor. Such signs shall be either:

1. Re-entry. Where re-entry is provided, a sign shall read, "RE-ENTRY ON THIS FLOOR".
2. No re-entry. Where re-entry is not provided on that floor, the sign shall read:
  - 2.1. "NO RE-ENTRY"; where re-entry is not provided on any floor;
  - 2.2. "NO RE-ENTRY, NEAREST RE-ENTRY ON THE..... AND..... FLOORS"; where re-entry is provided on other floors; and
  - 2.3. "NO RE-ENTRY. RE-ENTRY IS PROVIDED ONLY DURING FIRE EMERGENCIES. NEAREST TELEPHONE ON THE ..... AND..... FLOORS"; where stair side doors are locked in accordance with Section 403.12.

**1026.4.3 Graphics.** The lettering and numerals of the signs shall be at least ½ inch (12.7 mm) high of bold type. The lettering and background shall be contrasting colors and the signs shall be securely attached approximately 5 feet (1524 mm) above the floor. The signs may be either independent or combined with floor and stairway identification signs.

**1026.5 Wall signs, stair side.** In high-rise buildings subject to Section 403, signs shall be posted and maintained on the wall as follows:

1. Re-entry. Where a re-entry door is recessed, a supplementary sign complying with Section 1026.4.3, except that the lettering and numerals shall be at least 1 inch (25 mm) high, shall be securely attached on the wall of the landing and shall be readily visible to the evacuee on the stairs indicating the location of such recessed re-entry door.
2. No re-entry. Where there is no re-entry from the stair, an additional sign complying with Subdivision 2 of Section 1026.4.2 and 1026.4.3, except that the lettering and numerals shall be at least 1 inch (25 mm) high, shall be securely attached at the beginning of the descent into such portion of the stair on the wall of the landing and shall be readily visible to the evacuee on the stairs.

**1026.6 Accessible means of egress signs.** Accessible means of egress shall be provided with signs in accordance with Sections 1007.6.5 and 1007.7.

**1026.7 Capacity sign.** Occupant load signs shall be provided in accordance with Sections 1004.3.



**1026.8 Access-controlled doors.** Access-controlled doors shall be provided with signs in accordance with Sections 1008.1.3.4.

**1026.9 Delayed egress locks.** Doors equipped with delayed egress shall be provided with signs in accordance with Sections 1008.1.8.6.

**1026.10 Signs in sleeping rooms.** All buildings classified in Group R-1 shall post and maintain a sign on the inside of every door opening onto a corridor giving access to a sleeping room. The sign shall contain a diagram showing the location where it is posted and the location and letter identification of the exit stairs on the floor. The diagram shall indicate the number of doors opening onto the public corridor which must be passed to reach each exit stair. The sign shall be at least 8 inches by 10 inches (203 mm by 254 mm), located on the inside of the door and securely attached. The top of such sign shall not be more than 6 feet (1829 mm) from the floor level. Such sign shall contain such additional information as the New York City Fire Department may require.

**1026.11 Photoluminescent exit path marking.** Photoluminescent exit path markings in high-rise buildings subject to Section 403 shall be provided in accordance with this section. All exit path markings required herein shall be of an approved photoluminescent material. The markings shall be washable, non-toxic, non-radioactive, and if subjected to fire must be self extinguishing when the flame is removed. Exit path markings shall be located:

1. On all doors opening to exits, exit passageways, or horizontal exits and shall be marked with the word "EXIT".
2. Within exit stairs, horizontal extensions in exit stairs, horizontal exits, and exit passageways

**Exception:** Within street level lobbies where egress direction is immediately discernable.

Required markings for exit paths shall comply with the technical standards for installation and placement in accordance with rules promulgated by the commissioner.

**1026.12 Materials for signs.** Signs required by this section shall be of metal or other durable material.

**TABLE 1004.1.2**  
**MAXIMUM FLOOR AREA ALLOWANCES PER OCCUPANT**

<u>USE OF SPACE</u>	<u>FLOOR AREA IN SQ. FT. PER OCCUPANT</u>
<u>Agricultural building</u>	<u>300 gross</u>
<u>Aircraft hangars</u>	<u>500 gross</u>
<u>Assembly</u> <u>Gaming floors (keno, slots, etc.)</u>	<u>11 gross</u>
<u>Assembly with fixed seats</u>	<u>See Section 1004.7</u>
<u>Assembly without fixed seats</u>	
<u>Concentrated (chairs only—not fixed)</u>	<u>7 net</u>
<u>Dance floor</u>	<u>5 net</u>
<u>Dance floor (ballroom)</u>	<u>10 net</u>
<u>Standing space / Waiting area</u>	<u>5 net</u>
<u>Unconcentrated (tables and chairs)</u>	<u>15 net</u>
<u>Bowling centers, allow 5 persons for each lane including 15 feet of runway, and for additional areas</u>	<u>7 net</u>
<u>Business areas</u>	<u>100 gross</u>
<u>Courtrooms—other than fixed seating areas</u>	<u>40 net</u>
<u>Day Care</u>	
<u>age under 6 months</u>	<u>50 net</u>
<u>age 6 months – 2 years</u>	<u>40 net</u>
<u>age 2 years – 6 years</u>	<u>30 net</u>
<u>age above 6 years</u>	<u>50 net</u>
<u>Dormitories</u>	<u>50 gross</u>
<u>Educational</u>	
<u>Classroom area</u>	<u>20 net</u>
<u>Shops and other vocational room areas</u>	<u>50 net</u>
<u>Exercise rooms</u>	<u>50 gross</u>
<u>Gymnasiums</u>	<u>15 net</u>
<u>H-5 Fabrication and manufacturing areas</u>	<u>200 gross</u>
<u>Industrial areas</u>	<u>100 gross</u>
<u>Institutional areas</u>	
<u>Inpatient treatment areas</u>	<u>240 gross</u>
<u>Outpatient areas</u>	<u>100 gross</u>
<u>Sleeping areas</u>	<u>120 gross</u>
<u>Kitchens, commercial</u>	<u>200 gross</u>
<u>Library</u>	
<u>Reading rooms</u>	<u>50 net</u>
<u>Stack area</u>	<u>100 gross</u>
<u>Locker rooms</u>	<u>50 gross</u>
<u>Mercantile</u>	
<u>Areas on other floors</u>	<u>60 gross</u>
<u>Basement and grade floor areas</u>	<u>30 gross</u>
<u>Storage, stock, shipping areas</u>	<u>300 gross</u>
<u>Parking garages</u>	<u>200 gross</u>
<u>Passenger terminal</u>	
<u>Passenger terminal or platform</u>	<u>1.5 X C*</u>
<u>Baggage claim</u>	<u>20 gross</u>
<u>Baggage handling</u>	<u>300 gross</u>
<u>Concourse</u>	<u>100 gross</u>
<u>Waiting areas (Seated)</u>	<u>15 gross</u>
<u>Waiting area (Standing)</u>	<u>5 net</u>
<u>Residential</u>	<u>200 gross within dwelling units</u>
<u>Skating rinks, swimming pools</u>	
<u>Rink and pool</u>	<u>50 gross</u>
<u>Decks</u>	<u>15 gross</u>
<u>Stages and platforms</u>	<u>15 net for performing area and 50 net remaining area</u>
<u>Accessory storage areas, mechanical equipment room</u>	<u>300 gross</u>
<u>Warehouses</u>	<u>500 gross</u>

**TABLE 1005.1**  
**EGRESS WIDTH PER OCCUPANT SERVED**

<b><u>OCCUPANCY</u></b>	<b><u>Stairways</u> <u>(inches per occupant)</u></b>	<b><u>Other components</u> <u>(inches per occupant)</u></b>
<u>Occupancies</u> <u>other than</u> <u>those listed below</u>	<u>0.3</u>	<u>0.2</u>
<u>Hazardous: H-1,</u> <u>H-2, H-3 and H-4</u>	<u>0.7</u>	<u>0.4</u>

For SI: 1 inch = 25.4 mm

**TABLE 1008.1.3.1  
REVOLVING DOOR SPEEDS**

<b>INSIDE DIAMETER (feet-inches)</b>	<b>POWER-DRIVEN-TYPE SPEED CONTROL (rpm)</b>	<b>MANUAL-TYPE SPEED CONTROL (rpm)</b>
6-6	11	12
7-0	10	11
7-6	9	11
8-0	9	10
8-6	8	9
9-0	8	9
9-6	7	8
10-0	7	8

For SI: 1 inch = 25.4 mm, 1 foot = 304.8 mm.

**TABLE 1014.1**  
**SPACES WITH ONE MEANS OF EGRESS**

<u>OCCUPANCY</u>	<u>MAXIMUM OCCUPANT LOAD</u>
<u>A, B, E, M, U</u>	<u>74</u>
<u>F</u>	<u>50</u>
<u>H-1, H-2, H-3</u>	<u>3</u>
<u>H-4, H-5, I-1, I-3, I-4</u>	<u>10</u>
<u>I-2</u>	<u>See Section 1013.2.2</u>
<u>R</u>	<u>20</u>
<u>S</u>	<u>30</u>

**TABLE 1015.1**  
**EXIT ACCESS TRAVEL DISTANCE<sup>a</sup>**

<b><u>OCCUPANCY</u></b>	<b><u>WITHOUT SPRINKLER SYSTEM (feet)</u></b>	<b><u>WITH SPRINKLER SYSTEM (feet)</u></b>
<u>A</u>	<u>See Section 1024.7</u>	
<u>E, F-1, I-1, M, R, S-1</u>	<u>150</u>	<u>200<sup>b</sup></u>
<u>B</u>	<u>200</u>	<u>300<sup>c</sup></u>
<u>F-2, S-2, U</u>	<u>200</u>	<u>250<sup>b</sup></u>
<u>H-1</u>	<u>Not permitted</u>	<u>75<sup>c</sup></u>
<u>H-2</u>	<u>Not permitted</u>	<u>100<sup>c</sup></u>
<u>H-3</u>	<u>Not permitted</u>	<u>150<sup>c</sup></u>
<u>H-4</u>	<u>Not permitted</u>	<u>175<sup>c</sup></u>
<u>H-5</u>	<u>Not permitted</u>	<u>200<sup>c</sup></u>
<u>I-2, I-3, I-4</u>	<u>150</u>	<u>200<sup>c</sup></u>

For SI: 1 foot = 304.8 mm

- a. See the following sections for modifications to exit access travel distance requirements:
  - Section 402: For the distance limitation in malls.
  - Section 404: For the distance limitation through an atrium space.
  - Section 1018.2: For buildings with one exit.
  - Chapter 31: For the limitation in temporary structures.
- b. Buildings equipped throughout with an automatic sprinkler system in accordance with Section 903.3.1.1 or 903.3.1.2. See Section 903 for occupancies where sprinkler systems according to Section 903.3.1.2 are permitted.
- c. Buildings equipped throughout with an automatic sprinkler system in accordance with Section 903.3.1.1.

**TABLE 1016.1.1  
INTERIOR CORRIDOR FIRE-RESISTANCE RATING**

<u>OCCUPANCY</u>	<u>OCCUPANT LOAD SERVED BY INTERIOR CORRIDOR</u>	<u>REQUIRED FIRE RESISTANCE RATING (hours)</u>	
		<u>Without sprinkler system</u>	<u>With sprinkler system<sup>e</sup></u>
H-1, H-2, H-3	<u>All</u>	<u>Not permitted</u>	<u>1</u>
H-4, H-5	<u>Greater than 30</u>	<u>Not permitted</u>	<u>1</u>
A, B, E, F, M, S, U	<u>Greater than 30</u>	<u>1</u>	<u>0</u>
R	<u>Greater than 30</u>	<u>1<sup>d</sup></u>	<u>0</u>
I-2 <sup>a</sup> , I-4	<u>All</u>	<u>Not permitted</u>	<u>0</u>
I-1, I-3	<u>All</u>	<u>Not permitted</u>	<u>1<sup>b</sup></u>

- a. For requirements for occupancies in Group I-2, see Section 407.3.
- b. For a reduction in the fire-resistance rating for occupancies in Group I-3, see Section 408.7.
- c. Buildings equipped throughout with an automatic sprinkler system in accordance with Section 903.3.1.1 or 903.3.1.2 where allowed.
- d. Interior corridors within dwelling or sleeping units in Group R occupancies pursuant to Section 1016.1.1 Exception 2 shall not require fire-resistance rating.

**TABLE 1016.1.2  
PUBLIC CORRIDOR FIRE-RESISTANCE RATING**

<u>OCCUPANCY</u>	<u>REQUIRED FIRE RESISTANCE RATING (hours)</u>
<u>H-1, H-2, H-3</u>	<u>2</u>
<u>H-4, H-5</u>	<u>1</u>
<u>A, E, F, M, S, U</u>	<u>1</u>
<u>B</u>	<u>1<sup>a</sup></u>
<u>R (Noncombustible)</u>	<u>1</u>
<u>R (Combustible)</u>	<u>2<sup>b</sup></u>
<u>I-1, I-2, I-3, I-4</u>	<u>1</u>

- a. Public corridors need not be fire-rated in high-rise buildings in occupancy Group B equipped throughout with an automatic sprinkler system in accordance with Section 903.3.1.1, where such building is provided with smokeproof enclosures in stairways in accordance with Section 403.13.
- b. Public corridors in buildings not exceeding two stories in height, or that are three stories in height and occupied by not more than one family on each story, may be constructed with one hour fire-resistance rating.



**TABLE 1018.1**  
**MINIMUM NUMBER OF EXITS FOR OCCUPANT LOAD**

OCCUPANT LOAD	MINIMUM NUMBER OF EXITS
1-500	2
501-1,000	3
More than 1,000	4

**TABLE 1018.2**  
**BUILDINGS WITH ONE EXIT**

<u>OCCUPANCY</u>	<u>MAXIMUM HEIGHT OF BUILDING ABOVE GRADE PLANE</u>	<u>MAXIMUM OCCUPANTS (OR DWELLING UNITS) PER FLOOR AND TRAVEL DISTANCE</u>
<u>A, B<sup>c</sup>, E, F, M U</u>	<u>1 Story</u>	<u>50 occupants and 75 feet travel distance</u>
<u>H-2, H-3</u>	<u>1 Story</u>	<u>3 occupants and 25 feet travel distance</u>
<u>H-4, H-5, I, R</u>	<u>1 Story</u>	<u>10 occupants and 75 feet travel distance</u>
<u>S<sup>a</sup></u>	<u>1 Story</u>	<u>30 occupants and 100 feet travel distance</u>
<u>B, F, M, S<sup>a</sup></u>	<u>2 Stories</u>	<u>30 occupants and 75 feet travel distance</u>
<u>R-2<sup>d,e</sup></u>	<u>2 Stories<sup>b</sup></u>	<u>4 dwelling units and 50 feet travel distance</u>

For SI: 1 foot = 304.8 mm.

<sup>a</sup>. For the required number of exits for open parking structures, see Section 1018.1.1

<sup>b</sup>. Buildings classified as Group R-2 equipped throughout with an automatic sprinkler system in accordance with Section 903.3.1.1 or 903.3.1.2 and provided with emergency escape and rescue openings in accordance with Section 1025 shall have a maximum height of three stories above grade.

<sup>c</sup>. Buildings equipped throughout with an automatic sprinkler system in accordance with Section 903.3.1.1 with an occupancy in Group B shall have a maximum travel distance of 100 feet.

<sup>d</sup>. Buildings classified as Group R-2 subject to Section 1018.2, item 4.

<sup>e</sup>. Buildings classified as Group R-2 subject to Section 1018.2, item 5.

**TABLE 1024.6.2**  
**WIDTH OF AISLES FOR SMOKE-PROTECTED ASSEMBLY**

TOTAL NUMBER OF SEATS IN THE SMOKE-PROTECTED ASSEMBLY OCCUPANCY	INCHES OF CLEAR WIDTH PER SEAT SERVED			
	Stairs and aisle steps with handrails within 30 inches	Stairs and aisle steps without handrails within 30 inches	Passageways, doorways and ramps not steeper than 1 in 10 in slope	Ramps steeper than 1 in 10 in slope
Equal to or less than 5,000	0.200	0.250	0.150	0.165
10,000	0.130	0.163	0.100	0.110
15,000	0.096	0.120	0.070	0.077
20,000	0.076	0.095	0.056	0.062
Equal to or greater than 25,000	0.060	0.075	0.044	0.048

For SI: 1 inch = 25.4 mm.

**TABLE 1024.7**  
**TRAVEL DISTANCE**

<u>OCCUPANCY</u>	<u>NON-SPRINKLERED</u>		<u>SPRINKLERED</u>	
	<u>PRIMARY</u>	<u>SECONDARY</u>	<u>PRIMARY</u>	<u>SECONDARY</u>
<u>A-1, A-2,</u> <u>A-3, A-4</u>	<u>100</u>	<u>150</u>	<u>150</u>	<u>250</u>
<u>A-5</u>	<u>200</u>	<u>300</u>	<u>200</u>	<u>300</u>

**TABLE 1024.10.1**  
**SMOKE-PROTECTED**  
**ASSEMBLY AISLE ACCESSWAYS**

<u>TOTAL NUMBER OF SEATS IN THE</u> <u>SMOKE-PROTECTED ASSEMBLY</u> <u>OCCUPANCY</u>	<u>MAXIMUM NUMBER OF SEATS PER ROW</u> <u>PERMITTED TO HAVE A MINIMUM 12-</u> <u>INCH CLEAR WIDTH AISLE ACCESSWAY</u> <u>Aisle or doorway at both ends of row</u>
<u>Less than 4,000</u>	<u>14</u>
<u>4,000</u>	<u>15</u>
<u>7,000</u>	<u>16</u>
<u>10,000</u>	<u>17</u>
<u>13,000</u>	<u>18</u>
<u>16,000</u>	<u>19</u>
<u>19,000</u>	<u>20</u>
<u>22,000 and greater</u>	<u>21</u>

For SI: 1 inch = 25.4 mm

**CHAPTER 11**  
**ACCESSIBILITY**

**SECTION BC 1101**  
**GENERAL**

**1101.1 Scope.** The provisions of this chapter and appendices E, N and P shall control the design and construction of facilities for accessibility to persons with physical disabilities.

**1101.2 Design.** Buildings and facilities shall be designed and constructed to be accessible in accordance with this code and ICC A117.1 (Accessible and Usable Buildings and Facilities).

**SECTION BC 1102**  
**DEFINITIONS**

**1102.1 Definitions.** The following words and terms shall, for the purposes of this chapter, applicable appendices and as used elsewhere in this code, have the following meanings:

**ACCESSIBLE.** A site, building, facility or portion thereof that complies with this chapter.

**ACCESSIBLE ROUTE.** A continuous, unobstructed path that complies with this chapter.

**ACCESSIBLE UNIT.** A dwelling unit or sleeping unit that complies with this code and Chapter 1-Chapter 10 of ICC A117.1.

**CIRCULATION PATH.** An exterior or interior way of passage provided for pedestrian travel.

**COMMON USE.** Interior or exterior circulation paths, rooms, spaces or elements that are made available for the shared use of two or more people but are not for public use.

**DETECTABLE WARNING.** A standardized surface feature built in or applied to walking surfaces or other elements to warn visually impaired persons of hazards on a circulation path.

**DWELLING UNIT OR SLEEPING UNIT, MULTI-STORY.** A dwelling unit or sleeping unit with habitable space located on more than one story.

**DWELLING UNIT OR SLEEPING UNIT, TYPE B.** A dwelling unit or sleeping unit designed and constructed for accessibility in accordance with this code, Section 1004 (Type B Units) of ICC A117.1 where applicable, and Appendix P of this code where

applicable, consistent with or exceeding the design and construction requirements of the federal Fair Housing Act.

**EMPLOYEE WORK AREA.** All or any portion of a space used only by employees and only for work. Corridors, toilet rooms, kitchenettes and break rooms are not employee work areas.

**FACILITY.** All or any portion of buildings, structure, site improvements, elements and pedestrian or vehicular routes located on a site.

**INTENDED TO BE OCCUPIED AS A RESIDENCE.** This refers to a dwelling unit or sleeping unit that can or will be used all or part of the time as the occupant's place of abode.

**MULTILEVEL ASSEMBLY SEATING.** Seating that is arranged in distinct levels where each level is comprised of either multiple rows, or single row of box seats accessed from a separate level.

**PUBLIC ENTRANCE.** An entrance that is not a service entrance.

**PUBLIC-USE AREAS.** Interior or exterior rooms or spaces that are made available to the general public.

**RESTRICTED ENTRANCE.** An entrance that is made available for public use but on a controlled basis, and that is not a service entrance.

**SELF-SERVICE STORAGE FACILITY.** Real property designed and used for the purpose of renting or leasing individual storage spaces to customers for the purpose of storing and removing personal property on a self-service basis.

**SERVICES.** Includes but is not limited to toilet rooms, drinking fountains, public telephones, and food.

**SERVICE ENTRANCE.** An entrance solely for delivery of goods or services.

**SITE.** A parcel of land bounded by a property line or a designated portion of a public right-of-way.

**WHEELCHAIR SPACE.** A space for a single wheelchair and its occupant.

**SECTION BC 1103**  
**SCOPING REQUIREMENTS**

**1103.1 Where required.** Buildings and structures, temporary or permanent, including their associated sites and facilities, shall be accessible to persons with physical disabilities.

**1103.2 General exceptions.** Sites, buildings, facilities and elements shall be exempt from this chapter to the extent specified in this section.

**1103.2.1 Specific requirements.** Accessibility is not required in buildings and facilities, or portions thereof, to the extent permitted by Sections 1104 through 1110.

**1103.2.2 Existing buildings.** Existing buildings shall comply with Section 28-101.4.

**1103.2.3 Employee work areas.** All or any portion of a space used exclusively by employees and only for work shall be required to comply only with Section 1103.2.3. However, common use circulation paths, located within employee work areas shall also comply with Section 1104.3.1.

**1103.2.3.1 Employee work areas and work stations.** Spaces and elements within employee work areas shall comply with Sections 907.9.1.2, 1007 and 1104.3.1 and shall be designed and constructed so that individuals with disabilities can approach, enter and exit the work area. In addition, at least one and not less than five percent of seating, tables and/or work stations, if provided, within employee work areas shall comply with applicable sections of ICC A117.1.

**1103.2.3.2 Elevated employee work areas.** Where the elevation is critical to the proper work operations, work areas or portions of work areas that are less than 150 square feet (14 m<sup>2</sup>) in area and elevated 7 inches (178 mm) or more above the ground or finish floor shall be exempt from all requirements.

**1103.2.4 Detached dwellings.** Detached one and two-family dwellings and their accessory structures, and their associated sites and facilities are not required to be accessible.

**1103.2.5 Utility buildings.** Occupancies in Group U are exempt from the requirements of this chapter other than the following:

- 1. In agricultural buildings and live stock shelters, access is required to paved work areas and areas open to the general public.**
- 2. Green houses and stables open to the public.**
- 3. Private garages or carports that contain required accessible parking.**

**1103.2.6 Construction sites.** Structures, sites and equipment directly associated with the actual processes of construction including, but not limited to, scaffolding, bridging, materials hoists, materials storage or construction trailers are not required to be accessible.

**1103.2.7 Raised areas.** Raised areas used for purposes of security, life safety or fire safety including, but not limited to, observation galleries, prison guard towers, fire towers or lifeguard stands are not required to be accessible or to be on an accessible route.

**1103.2.8 Limited access spaces.** Nonoccupiable spaces accessed only by ladders, catwalks, crawl spaces, freight elevators that are not part of an accessible route, or very narrow passageways are not required to be accessible.

**1103.2.9 Equipment spaces.** Spaces frequented only by personnel for maintenance, repair or monitoring of equipment are not required to be accessible. Such spaces include, but are not limited to, elevator pits, elevator penthouses, mechanical, electrical or communications equipment rooms, piping or equipment catwalks, water or sewerage treatment pump rooms and stations, electrical substations and transformer vaults, and highway and tunnel utility facilities.

**1103.2.10 Non-grade single-occupant structures.** Single-occupant structures that are accessed only by passageways below grade or above grade including, but not limited to, toll booths that are accessed only by bridges or underground tunnels, are not required to be accessible.

**1103.2.11 Residential Group R-1.** Buildings in Group R-1 containing not more than five sleeping units for rent or hire that are also occupied as the residence of the proprietor are not required to be accessible.

**1103.2.12 Detention and correctional facilities.** In detention and correctional facilities, common use areas that are used only by inmates or detainees and security personnel, and that do not serve holding cells or housing cells required to be accessible pursuant to Section 1107.5.5, are not required to be accessible or to be on an accessible route.

**1103.2.13 Fuel-dispensing systems.** The operable parts on fuel-dispensing devices shall comply with Section 308.2.1 (Forward Reach Unobstructed) or 308.3.1 (Side Reach Unobstructed) of ICC A117.1.

**SECTION BC 1104**  
**ACCESSIBLE ROUTE**

**1104.1 Site arrival points.** Accessible routes within the site shall be provided from public transportation stops, accessible parking and accessible passenger loading zones, and public streets or sidewalks to the accessible building entrance served.

**1104.2 Within a site.** At least one accessible route shall connect accessible buildings, accessible facilities, accessible elements and accessible spaces that are on the same site and shall comply with Section 1104.5.

**1104.3 Connected spaces.** When a building, or portion of a building, is required to be accessible, an accessible route shall be provided to each portion of the building, to accessible building entrances connecting accessible pedestrian walkways and the public way. Where only one accessible route is provided, the accessible route shall not pass through kitchens, storage rooms, restrooms, closets or similar spaces.

**Exceptions:**

1. In assembly areas with seating required to be accessible, an accessible route shall not be required to serve seating where wheelchair spaces or designated aisle seats required to be on an accessible route are not provided.
2. Accessible routes shall not be required to mezzanines provided that the building or facility has no more than one story, or where multiple stories are not required to be connected by an accessible route as permitted by Section 1104.4.
3. A single accessible route is permitted to pass through a kitchen or storage room in an accessible dwelling unit.

**1104.3.1 Circulation paths within employee work areas.** Common use circulation paths within employee work areas shall be accessible routes.

**Exceptions:** The following exceptions apply only to the common use circulation paths within an employee work area and are not intended to remove the requirement of Section 1103.2.3 that employee work areas be designed and constructed so that individuals with disabilities can approach, enter and exit the employee work area.

1. Common use circulation paths, located within employee work areas less than 300 square feet (27.9 m<sup>2</sup>) in size, and defined by permanently installed partitions, counters, casework or furnishings not serving accessible employee work stations that are required in Section 1103.2.3.1, shall not be required to be accessible routes.
2. Common use circulation paths, located within employee work areas, that are an integral component of equipment, shall not be required to be accessible routes.



**1104.3.2 Press boxes.** Press boxes in assembly areas shall be on an accessible route.

**Exceptions:**

1. An accessible route shall not be required to press boxes in bleachers that have points of entry at only one level, provided that the aggregate area of all press boxes is 500 square feet (46.5 m<sup>2</sup>) maximum.
2. An accessible route shall not be required to free-standing press boxes that are elevated above grade 12 feet (3658 mm) minimum provided that the aggregate area of all press boxes is 500 square feet (46.5 m<sup>2</sup>) maximum.

**1104.4 Multilevel buildings and facilities.** At least one accessible route shall connect each accessible level, including mezzanines, in multilevel level buildings and facilities.

**Exceptions:**

1. An accessible route is not required to stories and mezzanines above and below accessible levels in non-residential buildings where the aggregate area of all such stories and mezzanines above and below accessible levels is not more than 2,500 square feet (232.3 m<sup>2</sup>). This exception shall not apply to:
  - 1.1. Multiple tenant facilities of Group M occupancies containing five or more tenant spaces;
  - 1.2. Levels containing offices of health care providers (Group B or I);
  - 1.3. Passenger transportation facilities and airports (Group A-3 or B); or
  - 1.4. Levels frequented by the public for assembly, government, public utility or health facility purposes.
2. In group A, I, R and S occupancies, levels that do not contain accessible elements or other spaces required by in Sections 1107 or 1108 are not required to be served by an accessible route from an accessible level.
3. Where a two-story building or facility has one story with an occupant load of five or fewer persons that does not contain public use space, that story shall not be required to be connected by an accessible route to the story above or below.

**1104.5 Location.** Accessible routes shall coincide with or be located in the same area as a general circulation path. Where the circulation path is interior, the accessible route shall also be interior.

**1104.6 Security barriers.** Security barriers including, but not limited to, security bollards and security check points shall not obstruct a required accessible route or accessible means of egress.

**Exception:** Where security barriers incorporate elements that cannot comply with these requirements, such as certain metal detectors, fluoroscopes or other similar devices, the accessible route shall be permitted to be provided adjacent to security screening devices. The accessible route shall permit persons with disabilities passing around security barriers to maintain visual contact with their personal items to the same extent provided others passing through the security barrier.

## **SECTION BC 1105** **ACCESSIBLE ENTRANCES**

**1105.1 Public entrances.** In addition to accessible entrances required by Sections 1105.1.1 through 1105.1.6, all public entrances shall be accessible.

### **Exceptions:**

1. An accessible entrance is not required to areas that are not required to be accessible by this chapter or Appendix E.
2. Loading and service entrances that are not the only entrance to a building or a tenant space.
3. Revolving doors, revolving gates, or turnstiles shall not be required to be accessible provided that an accessible entrance is available adjacent to such revolving doors, revolving gates or turnstiles.

**1105.1.1 Parking garage entrances.** Where provided, direct access for pedestrians from parking structures to buildings or facility entrances shall be accessible.

**1105.1.2 Entrances from tunnels or elevated walkways.** Where direct access is provided for pedestrians from a pedestrian tunnel or elevated walkway to a building or facility, entrances from such access to the building or facility shall be accessible.

**1105.1.3 Restricted entrances.** Where restricted entrances are provided to a building or facility, all such restricted entrances shall be accessible.

**1105.1.4 Entrances for inmates and detainees.** Where entrances used only by inmates or detainees and security personnel are provided at judicial facilities, detention facilities or correctional facilities, all such entrances shall be accessible.

**1105.1.5 Service entrances.** If a service entrance is the only entrance to a building or a tenant space in a facility, that entrance shall be accessible.

**1105.1.6 Tenant spaces.** All entrances to tenant spaces that are required to be accessible shall be accessible entrances.

**1105.1.6.1 Dwelling units and sleeping units.** Doors and doorways at entrance(s) to Accessible units, including hardware, shall comply with Section 404 (Doors and doorways) of ICC A117.1. Doors and doorways, including hardware, at entrance(s) to Type B units shall comply with Section 1003.5 (Doors and doorways) of ICC A117.1.

**Exceptions:**

1. An accessible entrance is not required to dwelling units and sleeping units that are not required to be Accessible units or Type B units.
2. Entrances to multi-story dwelling or sleeping units in R-2 occupancy as provided in Section 1107.2.5 that are not on the primary entry story to the unit and are not part of the accessible route required in exception 1 of Section 1107.2.5 shall not be required to be accessible.

**SECTION BC 1106**  
**PARKING AND PASSENGER LOADING FACILITIES**

**1106.1 Required.** Where parking is provided, five percent of the total number of parking spaces, but not less than one parking space, shall be accessible parking spaces except as otherwise required by Sections 1106.2 through 1106.4. Van-accessible parking spaces shall be provided in accordance with Section 1106.5. Accessible parking spaces shall be designed and constructed in accordance with Section 502 (Parking Spaces) of ICC A117.1. The number of accessible parking spaces shall be determined based on the total number of parking spaces provided for the facility. Where a determination of the minimum number of parking spaces results in a number containing a decimal of 0.5 or more, the next highest integer shall be used.

**Exception:** This section does not apply to parking spaces used exclusively for buses, trucks, other delivery vehicles, law enforcement vehicles or vehicular impound where lots accessed by the public are provided with an accessible passenger loading zone.

**1106.2 Groups R-2 and R-3.** Where parking is provided for occupancies in groups R-2 and R-3, which are required to have Accessible or Type B dwelling or sleeping units, the number of accessible parking spaces shall be in compliance with Section 1106.1 and such number of accessible parking spaces shall be dispersed in accordance with Section 1106.6. Where parking is provided within or beneath a building, accessible parking spaces shall also be provided within or beneath the building.

**1106.2.1 Lease, rental, or assignment of spaces.** In a parking facility accessory to Occupancy Group R-2 or R-3 serving only the residents or employees of the management of such occupancy, or provided in compliance with Section 25-412 of the New York City Zoning Resolution, the accessible parking spaces in such facility may be leased, rented or assigned to a person without physical disabilities on a no longer than month-to-month basis. Such leases, rentals, or assignments of the accessible parking spaces to persons without physical disabilities shall be on written condition that such spaces be relinquished immediately at the end of the term of such lease, rental, or assignment to a resident or employee of the management of such occupancy who is a person with physical disabilities.

**1106.3 Hospital outpatient facilities.** Ten percent, but not less than one, of patient and visitor parking spaces provided to serve hospital outpatient facilities shall be accessible.

**1106.4 Rehabilitation facilities and outpatient physical therapy facilities.** Twenty percent, but not less than one, of the portion of patient and visitor parking spaces serving rehabilitation facilities and outpatient physical therapy facilities shall be accessible.

**1106.5 Van spaces.** For every six or fraction of six accessible parking spaces, at least one space shall be a van-accessible parking space. Van-accessible parking spaces shall be designed and constructed in accordance with ICC A117.1 including Section 502 (Parking Spaces).

**1106.6 Location.** Accessible parking spaces shall be located on the shortest accessible route of travel from adjacent parking to an accessible building entrance. Accessible parking spaces shall be dispersed among the various types of parking facilities provided. In parking facilities that do not serve a particular building, accessible parking spaces shall be located on the shortest route to an accessible pedestrian entrance to the parking facility. Where buildings have multiple accessible entrances with adjacent parking, accessible parking spaces shall be dispersed and located near the accessible entrances. In occupancies group R-2 and R-3, at least one of each type of parking space shall be accessible.

**Exceptions:**

- 1. In multilevel parking structures, van-accessible parking spaces complying with Section 502 (Parking Spaces) of ICC A117.1 may be provided on one level.**
- 2. In an attended parking facility in which vehicles customarily are parked and later returned to their drivers by an attendant employed by the parking facility, accessible parking spaces need not be designated by a sign or lines if all of the following conditions are met:**

- 2.1. Van-accessible parking spaces complying with Section 502 (Parking Spaces) of ICC A117.1 are provided,
- 2.2. A passenger loading zone complying with Section 1106.7 is provided where an attendant shall take control of the vehicles. A vertical clearance of 98 inches (2489 mm) shall be permitted at such loading zone,
- 2.3. At least one accessible parking space shall remain available unless all accessible parking spaces are occupied,
- 2.4. The attendant shall park and retrieve all vehicles not equipped with special controls entering the facility in which a person with disabilities is either the driver or a passenger, provided accessible parking space is available,
- 2.5. The attendant shall direct the drivers of vehicles equipped with special controls to accessible parking spaces. The attendant shall accompany such drivers to and from such space along an accessible route when they enter and exit the facility. If necessary, the accessible route and accessible parking space shall be created by the repositioning of vehicles parked previously by the attendant, and
- 2.6. Each van-accessible parking space shall have two permanently and prominently posted signs. One shall include the International Symbol of Accessibility complying with Section 703.6.3.1 of ICC A117.1. The other sign shall note that vehicles parked in such spaces are subject to being moved by an attendant of the parking facility in order to accommodate a vehicle which cannot be accommodated in another accessible parking space. Such signs shall not be obstructed by a vehicle parked in the space.

**1106.7 Passenger loading zones.** Passenger loading zones shall be designed and constructed in accordance with ICC A117.1 including Section 503 (Passenger Loading Zones). Where there are curbs between the access aisle and the vehicle pull-up space, a curb ramp complying with ICC A117.1 including Section 406 (Curb Ramps) shall be provided.

**1106.7.1 Continuous loading zones.** Where passenger loading zones are provided, at least one accessible passenger loading zone shall be provided within each continuous 100 linear feet (30.4 m) of loading zone space, or fraction thereof, so that travel between accessible passenger loading zones will not exceed 100 linear feet (30.4 m).

**1106.7.2 Medical facilities.** A passenger loading zone shall be provided at an accessible entrance to licensed medical and long-term care facilities where people

receive physical or medical treatment or care and where the period of stay exceeds 24 hours.

1106.7.3 Valet parking. A passenger loading zone shall be provided at valet parking services.

## **SECTION BC 1107** **DWELLING UNITS AND SLEEPING UNITS**

**1107.1 General.** In addition to the other requirements of this chapter, occupancies having dwelling units or sleeping units shall be provided with accessible features in accordance with this section.

**1107.2 Design.** Dwelling units and sleeping units which are required to be Accessible units or Type B units shall comply with this code including Appendix P where applicable, and the applicable provisions of Chapter 10 of ICC A117.1. In addition, Type B units in R-2 occupancies shall comply with Sections 1107.2.1 through 1107.2.8. Units required to be Type B units are permitted to be designed and constructed as Accessible units.

**1107.2.1 Type B unit doors and doorways in R-2 occupancy.** Doors and doorways at the entrance(s) to the dwelling or sleeping unit shall comply with Section 1105.1.6. All other doors and doorways within the dwelling or sleeping unit meant for human passage shall comply with Section 1003.5 (Doors and Doorways) of ICC A117.1. In addition, doors and doorways serving toilet and bathing facilities that are required to comply with Appendix P shall also comply with Section P102.3.

### **Exceptions:**

1. Maneuvering clearance at doors. Where pull side, latch approach maneuvering clearance is required within the dwelling or sleeping unit for a door without a closer as per Fig. 404.2.3.1 (f) of ICC A117.1, the minimum maneuvering clearance perpendicular to the doorway shall be permitted to be reduced to 42 inches (1067 mm).
2. Door hardware. Door hardware on doors within the dwelling or sleeping unit, except on entrance doors, shall not be required to comply with Section 404.2.6 (Door Hardware) of ICC A117.1 provided such hardware is readily replaceable without the removal or replacement of the door.
3. Future reversibility for bedroom doors. Bedroom door and frames shall be permitted to be provided with mortised hinge and latch blanks to permit future reversal of the door on the same frame using common hand tools and without further alterations to the door and frame, provided such future

swing of the door will not obstruct the maneuvering clearances required at the door or doorway.

4. Flex-closet. Where front approach, pull side maneuvering clearance is required at a manual swinging door per Fig. 404.2.3.1(a) of ICC A117.1, such clearance space may be used for a readily removable storage closet provided that:

4.1 Such closet is so constructed that the front approach, pull side maneuvering clearance can be restored by removing the closet doors, floor tracks, and shelves using common hand tools and without alterations to the floor or flooring, walls or partitions; and

4.2. In any dwelling unit containing a flex-closet, the dwelling unit must contain the following additional closets:

4.2.1. An accessible non-flex-closet in each bedroom equivalent to at least one 4 feet (1219 mm) wide by 2 feet 6 inches (762 mm) deep and 5 feet (1524 mm) high or, in an efficiency apartment, at least one such closet; and

4.2.2. An accessible non-flex-closet equal in cubic footage to the flex closet that is located outside of bedrooms, kitchen or bathroom.

5. Supplemental toilet and bathing facilities. Where one Type A toilet and bathing facility is provided in a Type B unit in accordance with the exception in Section 1107.2.2, the doors and doorways to all other toilet and bathing facilities in that dwelling unit shall not be required to comply with maneuvering clearances, but shall comply with Section 1004.5.2 (User Passage Doorways) of ICC A117.1 and shall provide clear opening width of 32 inches (813 mm) minimum.

**1107.2.2 Type B unit toilet and bathing facilities in R-2 occupancy.** Where toilet and bathing facilities are provided in the dwelling unit or sleeping unit, all such toilet and bathing facilities shall comply with Appendix P.

**Exception for Type A toilet and bathing facility:** Where at least one toilet and bathing facility in the dwelling or sleeping unit is constructed in accordance with the Type A toilet and bathing facilities requirements of Section 1003.11 (Toilet and Bathing Facilities) of ICC A117.1 and is in compliance with the following:

1. At least one lavatory, one water closet and either a bathtub or shower within such toilet or bathing facility shall comply with Section 1003.11 of ICC A117.1. Such toilet and bathing fixtures shall be in a single toilet or

bathing area, such that travel between fixtures does not require travel beyond the area in which the fixtures of such toilet or bathing facility are located.

2. Toilet paper dispensers within such facilities shall comply with Section 604.10.7 (Dispensers) of ICC A117.1.
3. Medicine cabinets, if provided, must include a storage shelf no higher than 44 inches (1118 mm) above the floor.

Where at least one toilet and bathing facility complying with Section 1003.11 of ICC A117.1 is provided within the dwelling or sleeping unit, other toilet and bathing facilities shall be required to comply only with Sections 1004.3 (Accessible route), 1004.4 (Walking Surfaces), 1004.5.2 (User Passage Doorways), 1004.9 (Operable Parts) and 1004.11.2 (Reinforcement) of ICC A117.1.

**1107.2.3 Type B unit kitchen and kitchenette in R-2 occupancy.** Where kitchens and kitchenettes are provided in the dwelling unit or sleeping unit, the primary kitchen or kitchenette shall be constructed in accordance with the kitchen requirements of Section 1003.12 (Kitchen) of ICC A117.1 and Section 1107.2.3.1 through 1107.2.3.4. Secondary kitchens and kitchenettes within the same dwelling unit shall be required to comply only with Section 1004.12 (Kitchens) of ICC A117.1.

**1107.2.3.1 Kitchen counters.** A kitchen counter that is required to comply with Section 1003.12.3.2 or 1003.12.4.2 (Height) of ICC A117.1 shall be permitted to be adjustable or designed to be replaceable as a unit at variable heights between 29 inches and 36 inches in (737 mm and 914 mm), measured from the floor to the top of the work surface. The owner shall adjust or replace such countertop at the time a person with physical disabilities takes occupancy of the unit, or within 10 days of the date the request is made by a person with physical disabilities, whichever is later, at the owner's expense.

**1107.2.3.2 Appliances in kitchen and kitchenette.** Appliances shall comply with Section 1003.12.6 (Appliances) of ICC A117.1.

**Exception:** Where appliances' controls are not in compliance with Section 309.4 (Operation) of ICC A117.1, the owner shall replace such appliances with appliances in conformance with Section 309.4 of ICC A117.1 at the time a person with physical disabilities takes occupancy of the unit, or within 10 days of the date the request is made by a person with physical disabilities, whichever is later, at the owner's expense. However, the owner shall not be responsible to provide a particular model or type of appliances provided such appliances and controls complies with Sections 1003.12.6 and 309.4 of ICC A117.1.



**1107.2.3.3 Refrigerator/Freezers.** Combination refrigerators and freezers shall comply with Section 1003.12.6.6 (Refrigerator/Freezers) of ICC A117.1. In addition, where less than 100 percent of storage volume of the freezer is located within 54 inches (1372 mm) maximum above the floor, such freezer shall be a self-defrosting type.

**Exception:** Where refrigerators and freezers are not in compliance with this section, the owner shall replace such appliances with complying appliances at the time a person with physical disabilities takes occupancy of the unit, or within 10 days of the date the request is made by a person with physical disabilities, whichever is later, at the owner's expense. However, the owner shall not be responsible to provide a particular model or type of appliances provided such appliances comply with this section.

**1107.2.3.4 Kitchen and kitchenette storage.** Kitchen storage, kitchen cabinets, drawers, and shelf storage areas, within kitchen and kitchenette that are required to comply with Section 1003.12 of ICC A117.1 pursuant to Section 1107.2.3, except overhead cabinets, shall comply with Section 905 (Storage Facilities) of ICC A117.1. In addition, at least one storage shelf or cabinet, mounted above work counters at 48 inches (1219 mm) maximum above the floor, shall be provided.

**1107.2.4 Type B unit operable windows in R-2 occupancy.** All operable windows in rooms or spaces in the dwelling unit or sleeping unit shall have operable parts complying with Section 309 (Operable Parts) of ICC A117.1.

**Exception:** Compliance with Section 1107.2.4 is not required in kitchenettes less than 80 square feet (7.4 m<sup>2</sup>) in area and equipped with an accessible mechanical means of ventilation complying with the *New York City Mechanical Code*, and in bathrooms equipped with an accessible mechanical means of ventilation complying with the *New York City Mechanical Code*.

**1107.2.5 Type B multi-story units in R-2 occupancy.** Multi-story dwelling or sleeping units shall comply with the following:

1. One of the stories with an accessible entrance shall be designated as the primary entry story to the unit;
2. All rooms, spaces and doors on the primary entry story shall comply with Section 1107.2; and
3. Rooms, spaces or doors located on other than the primary entry story, and interior routes thereto, need not comply with Section 1107.2 where the primary entry story contains equivalent functional facilities.

**Exception:** Functional facilities in compliance with Section 1107.2 may be located on any story within the dwelling or sleeping unit, provided that all rooms, spaces and doors located on such story containing such functional facilities comply with Section 1107.2. In addition, a toilet facility complying with Section 1107.2.2 shall be provided on the primary entry story, and one of the following conditions shall be met:

1. An accessible external elevator is provided to connect all such stories of the multi-story dwelling or sleeping unit; or
2. A stairway complying with Section 504 (Stairways) of ICC A117.1 with a minimum clear width of 36 inches (914 mm) is provided within the multi-story dwelling or sleeping unit to connect all such stories of the unit; or
3. An accessible route complying with Section 402 (accessible routes) of ICC A117.1 is provided within the dwelling or sleeping unit to connect all such stories of the unit.

**1107.2.6 Type B unit raised or sunken floor area in R-2 occupancy.** Where a raised or sunken floor area in a portion of a living, dining, or sleeping room within a dwelling or sleeping unit that is permitted by Section 1004.3 (accessible route, Exception 1 and 2) of ICC A117.1 is provided, steps complying with Section 504 (Stairways) of ICC A117.1 with a minimum clear width of 36 inches (914 mm) shall connect such portion of raised or sunken floor area to an accessible route. In addition, a minimum area of 80 square feet (7.4 m<sup>2</sup>), and 8 feet (2438 mm) in one dimension, of each of such living, dining, or sleeping room shall be connected by an accessible route that is in compliance with Section 1004.3.2 (Components) of ICC A117.1.

**1107.2.7 Type B unit storage facilities in R-2 occupancy.** Where storage facilities are provided within the dwelling or sleeping unit, they shall comply with Section 905 (Storage Facilities) of ICC A117.1.

**1107.2.8 Type B unit laundry equipment in R-2 occupancy.** Where washing machines or clothes dryers are provided within the dwelling or sleeping unit, such equipment shall comply with Section 611 (Washing Machines and Clothes Dryers) of ICC A117.1 and shall be front loading. Laundry equipment in accessible common-use area as required in Section 1107.3 shall comply with Section E105.3.

**Exception:** At the option of the owner, laundry equipment conforming to this section within the dwelling or sleeping unit may be provided at the time a person with physical disabilities takes occupancy of the unit, or within ten 10 days of the date the request is made by a person with physical disabilities, whichever is later,

at the owner's expense. However, the owner shall not be responsible to provide a particular model or type of equipment provided such equipment complies with this section.

**1107.3 Accessible spaces.** Rooms and spaces available to the general public or available for use by residents of Accessible units or Type B units shall be accessible. Accessible spaces shall include, but not be limited to, spaces for residents' use, such as laundry rooms, refuse disposal and storage locations, mailbox areas, recreational facilities, assembly and tenants' meeting rooms, storage rooms, parking areas, toilet and bathing rooms, kitchen, living and dining areas, any exterior spaces, including patios, terraces and balconies, management offices, and stores.

**1107.4 Accessible route.** At least one accessible route shall connect accessible building or facility entrances with the required accessible entrance(s) of each Accessible unit and Type B unit within the building or facility and with those exterior and interior spaces and facilities that serve the units.

**Exceptions:**

1. Roof terraces of Type B units above residential occupancies. Roof terraces that are part of Type B units and that are not for public use or common use, located on the floor immediately above enclosed residential occupancies.
2. Other exterior spaces of Type B units. All other exterior spaces, including but not limited to roof terraces, exterior decks, patios or balconies that are part of Type B units, that are not for public use or common use, that have impervious surfaces, and that are not more than 4 inches (102 mm) below the finished floor level of the adjacent interior space of the unit. Such roof terraces, decks, patios or balconies shall be designed so that accessibility can be readily provided, without modifications to the guard rail heights and structural supports, by the installation of a non-combustible ramp in compliance with Section 405 (Ramps) of ICC A117.1, or a non-combustible level platform, with removable panel for access to floor drainage, that is permeable to weather and in compliance with Section 302 (Floor Surfaces) and Section 303 (Changes in Level) of ICC A117.1.

**1107.5 Group I.** Occupancies in Group I shall be provided with accessible features in accordance with Sections 1107.5.1 through 1107.5.5.

**1107.5.1 Group I-1.** Group I-1 occupancies shall be provided with accessible features in accordance with Section 1107.5.1.1.

**1107.5.1.1 Accessible units.** In Group I-1 occupancies, 100 percent of the dwelling units and sleeping units shall be Accessible units.

**1107.5.2 Group I-2 Nursing homes.** Nursing homes of Group I-2 shall be provided with accessible features in accordance with Section 1107.5.2.1.

**1107.5.2.1 Accessible units.** In Nursing homes, 100 percent of the dwelling units and sleeping units shall be Accessible units.

**1107.5.3 Group I-2 Hospitals.** General-purpose hospitals, psychiatric facilities, detoxification facilities and residential care/assisted living facilities of Group I-2 shall be provided with accessible features in accordance with Section 1107.5.3.1.

**1107.5.3.1 Accessible units.** In such Group I-2 facilities, 100 percent of the dwelling units and sleeping units shall be Accessible units.

**1107.5.4 Group I-2 Rehabilitation facilities.** In hospitals and rehabilitation facilities of Group I-2 which specialize in treating conditions that affect mobility, or units within either which specialize in treating conditions that affect mobility, 100 percent of the dwelling units and sleeping units shall be Accessible units.

**1107.5.5 Group I-3.** Buildings, facilities or portions thereof with Group I-3 occupancies shall comply with Sections 1107.5.5.1 through 1107.5.5.3.

**1107.5.5.1 Group I-3 sleeping units.** In occupancies in Group I-3, at least two percent, but not less than one, of the dwelling units and sleeping units shall be Accessible units.

**1107.5.5.2 Special holding cells and special housing cells or rooms.** In addition to the units required to be accessible by Section 1107.5.5.1, where special holding cells or special housing cells or rooms are provided, at least one serving each purpose shall be accessible. Cells or rooms subject to this requirement include, but are not limited to, those used for purposes of orientation, protective custody, administrative or disciplinary detention or segregation, detoxification and medical isolation.

**Exception:** Cells or rooms specially designed without protrusions and that are used solely for purposes of suicide prevention shall not be required to include grab bars.

**1107.5.5.3 Medical care facilities.** Patient sleeping units or cells required to be accessible in medical care facilities shall be provided in addition to any medical isolation cells required to comply with Section 1107.5.5.2.

**1107.6 Group R.** Occupancies in Group R shall be provided with accessible features in accordance with Sections 1107.6.1 through 1107.6.3.

**1107.6.1 Group R-1.** Group R-1 occupancies shall be provided with accessible features in accordance with Sections 1107.6.1.1 through 1107.6.1.3.

**Exception:** Boarding houses, dormitories, fraternity houses and sorority houses shall comply with Section 1107.6.1.4.

**1107.6.1.1 Accessible units.** In occupancies in Group R-1, accessible dwelling units and sleeping units shall be provided in accordance with Table 1107.6.1.1. All facilities on a site shall be considered to determine the total number of Accessible units. Accessible units shall be dispersed among the various classes of units. Roll-in showers provided in Accessible units shall include a permanently mounted folding shower seat. In addition, required Accessible units in occupancies in group R-1 shall comply with the following:

Where hard wiring of audible and visual smoke detectors and/or carbon monoxide detectors is not required to be provided by Chapter 9, portable smoke and/or carbon monoxide detectors with both audible and visual features shall be available for a minimum of three percent of the total number of dwelling and sleeping units, or fraction thereof, but not fewer than one. Such detectors shall have a flash frequency range of 60 to 120 flashes per minute. Where the average illumination level with motion present is more than 20 lumens per square foot, the visible signaling appliance shall have an effective intensity rating between 100 and 1000 candela. A sign with a minimum height of 3 inches (76 mm) shall be posted at the main desk or other equivalent locations indicating the availability of such detectors.

**TABLE 1107.6.1.1**  
**ACCESSIBLE DWELLING AND SLEEPING UNITS**  
**(Table 1107.6.1.1 attached to the end of the document)**

**1107.6.1.2 Type B units.** In structures with four or more dwelling or sleeping units intended to be occupied as a residence, every dwelling and sleeping unit intended to be occupied as a residence shall be a Type B unit.

**Exceptions:**

1. The number of Type B units is permitted to be reduced in accordance with Section 1107.7.
2. Compliance with Sections 1107.2.1 through 1107.2.8 is not required.

**1107.6.1.3 Doors and doorways.** Entrances, doors, and doorways providing user passage into and within units that are not required to comply with Accessible units' requirements shall comply with Section 404.2.2 (Clear Width) of ICC A117.1.

**1107.6.1.4 Boarding houses, dormitories, fraternity houses and sorority houses.** Accessible units and Type B dwelling units and sleeping units shall be provided in boarding houses, dormitories, fraternity houses and sorority houses in accordance with Sections 1107.6.1.4.1 and 1107.6.1.4.2.

**1107.6.1.4.1 Accessible units.** Accessible dwelling units and sleeping units shall be provided in accordance with Table 1107.6.1.1.

**1107.6.1.4.2 Type B units.** Every dwelling unit and every sleeping unit shall be a Type B unit.

**Exception:** The number of Type B units is permitted to be reduced in accordance with Section 1107.7.

**1107.6.2 Group R-2.** Accessible units and Type B units shall be provided in occupancies in Group R-2 in accordance with Section 1107.6.2.1.

**1107.6.2.1 Apartment houses, monasteries and convents.** Type B units shall be provided in apartment houses, monasteries and convents in accordance with Section 1107.6.2.1.1.

**1107.6.2.1.1 Type B units.** Every dwelling unit and sleeping unit, regardless of intent to occupy such unit as a residence, shall be a Type B unit and shall comply with Section 1107.2, and Sections 1107.2.1 through 1107.2.8.

**Exception:** The number of Type B units is permitted to be reduced in accordance with Section 1107.7.

**1107.6.3 Group R-3.** In occupancies in Group R-3 where there are four or more dwelling units or sleeping units intended to be occupied as a residence in a single structure, every dwelling and sleeping unit intended to be occupied as a residence shall be a Type B unit.

**Exceptions:**

- 1.** The number of Type B units is permitted to be reduced in accordance with Section 1107.7.
- 2.** Compliance with Sections 1107.2.1 through 1107.2.8 is not required.

**1107.7 General exceptions.** Where specifically permitted by Section 1107.6, the required number of Type B units is permitted to be reduced in accordance with Sections 1107.7.1 through 1107.7.3.

**1107.7.1 Buildings without elevator service.** Where no elevator service is provided in a building, only the dwelling and sleeping units that are located on stories indicated in Sections 1107.7.1.1 and 1107.7.1.2 are required to be Type B units.

**1107.7.1.1 One story with Type B units required.** For occupancies in other than Group R-2, at least one story containing dwelling units or sleeping units intended to be occupied as a residence shall be provided with an accessible entrance from the exterior of the building and all units intended to be occupied as a residence on that story shall be Type B units. Occupancies in Group R-2 shall comply with the following:

1. Cellar, basement, or first story. For occupancies in Group R-2, in buildings where the lowest story containing dwelling or sleeping units is the cellar, basement, or first floor, at least one such story containing dwelling or sleeping units, regardless of intent to occupy as a residence, shall be provided with an accessible entrance and all units on that story, regardless of intent to occupy as a residence, shall be Type B units.
2. Second story or higher. For occupancies in Group R-2, in structures where the lowest story containing dwelling or sleeping units is the second story or higher, at least one story containing dwelling or sleeping units intended to be occupied as a residence shall be provided with an accessible entrance from the exterior of the building and all units intended to be occupied as a residence on that story shall be Type B units. Notwithstanding the foregoing, Type B units shall not be required in such structures that contain only multi-story dwelling or sleeping units and shall not be required in such structures that contain fewer than four dwelling or sleeping units.

**1107.7.1.2 Other stories with Type B units required.** If other stories containing dwelling or sleeping units intended to be occupied as a residence are served by a building entrance that is in proximity to arrival points as indicated in Items 1 and 2, such building entrance shall be accessible and all dwelling units and sleeping units intended to be occupied as a residence served by that entrance on that story shall be Type B units.

1. Where the slopes of the undisturbed site measured between the planned entrance and all vehicular or pedestrian arrival points within 50 feet (15 240 mm) of the planned entrance are 10 percent or less, and
2. Where the slopes of the planned finished grade measured between the entrance and all vehicular or pedestrian arrival points within 50 feet (15 240 mm) of the planned entrance are 10 percent or less.

Where no such arrival points are within 50 feet (15 240 mm) of the entrance, the closest arrival point shall be used unless that arrival point serves the story required by Section 1107.7.1.1.

**1107.7.2 Multistory units in Occupancy Group R-3.** A multistory dwelling or sleeping unit which is not provided with elevator service is not required to be a Type B unit. Where a multistory unit is provided with external elevator service to only one floor, the floor provided with elevator service shall be the primary entry to the unit, shall comply with the requirements for a Type B unit and a toilet facility shall be provided on that floor.

**1107.7.3 Elevator service to the lowest story with units.** Where elevator service in the building is provided for the sole purpose of complying with the provisions of Section 1107.7.1.1 to serve as an accessible route only to the lowest story containing dwelling or sleeping units intended to be occupied as a residence, only the units intended to be occupied as a residence on the lowest story served by the elevator are required to be Type B units.

## **SECTION BC 1108** **SPECIAL OCCUPANCIES**

**1108.1 General.** In addition to the other requirements of this chapter and applicable provisions of Appendices E and N, the requirements of Sections 1108.2 through 1108.4 shall apply to specific occupancies.

**1108.2 Assembly area seating.** Assembly areas with seating shall comply with 1108.2.1 through 1108.2.8. Dining areas shall comply with 1108.2.9.

**1108.2.1 Services.** Services and facilities provided in areas not required to be accessible in Section 1108.2.9 shall be provided on an accessible level and shall be accessible.

**1108.2.2 Wheelchair spaces.** In theaters, bleachers, grandstands, stadiums, arenas and other assembly areas, accessible wheelchair spaces, companion seats, and designated aisle seats complying with ICC A117.1 including Section 802 (Assembly Areas) shall be provided in accordance with Sections 1108.2.2.1 through 1108.2.2.3. Required accessible wheelchair spaces and their companion seats as required in Section 1108.2.5 shall be delineated on the approved seating plans. Such spaces and seats which are unsold one day (24 hours) before the event shall be permitted to be released for sale to the public, including persons without physical disabilities.

**1108.2.2.1 General Seating.** Wheelchair spaces shall be provided in accordance with Table 1108.2.2.1.

### **TABLE 1108.2.2.1**



**ACCESSIBLE WHEELCHAIR SPACE**  
**(Table 1108.2.2.1 attached to end of document)**

**1108.2.2.2 Luxury boxes, club boxes and suites.** In each luxury box, club box, and suite within arenas, stadiums and grandstands, wheelchair spaces shall be provided in accordance with Table 1108.2.2.1.

**1108.2.2.3 Other boxes.** In boxes other than those required to comply with Section 1108.2.2.2, the total number of wheelchair spaces provided shall be determined in accordance with Table 1108.2.2.1. Wheelchair spaces shall be located in not less than 20 percent of all boxes provided.

**1108.2.3 Integration.** Wheelchair spaces shall be an integral part of the seating plan.

**1108.2.4 Dispersion of wheelchair spaces.** Dispersion of wheelchair spaces shall be based on the availability of accessible routes to various seating areas including seating at various levels in multilevel facilities.

**1108.2.4.1 Multilevel assembly seating areas.** In multilevel assembly seating areas, wheelchair spaces shall be provided on the main floor level and on each additional floor or mezzanine levels. Wheelchair spaces shall be provided in each luxury box, club box and suite within assembly facilities

**Exceptions:**

1. In multilevel assembly spaces utilized for worship services, where the second floor or mezzanine level contains 25 percent or less of the total seating capacity, all wheelchair space clusters shall be permitted to be located on the main level.
2. In multilevel assembly seating where the second floor or mezzanine level provides 25 percent or less of the total seating capacity and 300 or fewer seats, wheelchair space clusters shall be permitted to all be located on the main level.

**1108.2.5 Companion seating.** At least one companion seat complying with ICC A117.1 including Section 802.7 (Companion Seat) shall be provided for each wheelchair space required by Section 1108.2.2.

**1108.2.6 Designated aisle seats.** At least five percent, but not less than one, of the total number of aisle seats provided shall be designated aisle seats and shall comply with ICC A117.1 including Section 802.8 (Designated Aisle Seats).

**1108.2.7 Assistive listening systems.** Each assembly area where audible communications are integral to the use of the space shall have an assistive listening

system in compliance with ICC A117.1 including Section 706 (Assistive Listening System) and Appendix N of this code.

**Exception:** Other than in courtrooms, an assistive listening system is not required where there is no audio amplification system.

**1108.2.7.1 Receivers.** Receivers shall be provided for assistive listening system in accordance with Table 1108.2.7.1. All receivers shall be hearing aid compatible.

**TABLE 1108.2.7.1**  
**RECEIVERS FOR ASSISTIVE LISTENING SYSTEMS**  
**(Table 1108.2.7.1 attached to end of document)**

**1108.2.7.2 Public Address systems.** Where stadiums, arenas and grandstands provide audible public announcements, they shall also provide equivalent text information regarding events and facilities in compliance with Sections 1108.2.7.2.1 and 1108.2.7.2.2

**1108.2.7.2.1 Prerecorded text messages.** Where electronic signs are provided and have the capability to display prerecorded text messages containing information that is the same, or substantially equivalent, to information that is provided audibly, signs shall display text that is equivalent to audible announcements.

**Exception:** Announcements that cannot be prerecorded in advance of the event shall not be required to be displayed.

**1108.2.7.2.2 Real-time messages.** Where electronic signs are provided and have the capability to display real-time messages containing information that is the same, or substantially equivalent, to information that is provided audibly, signs shall display text that is equivalent to audible announcements.

**1108.2.8 Performance areas.** An accessible route shall directly connect the performance area to the assembly seating area where a circulation path directly connects a performance area to an assembly seating area. An accessible route shall be provided from performance areas to ancillary areas or facilities used by performers.

**1108.2.9 Dining Areas.** In dining areas, the total floor area allotted for seating and tables shall be accessible.

**Exceptions:**

1. In buildings or facilities not required to provide an accessible route between levels as described in Section 1104.4 Exception 1, an accessible route to a mezzanine seating area is not required, provided that the

mezzanine contains less than 33 percent of the total seating area and the same services are provided in the accessible area.

2. In sports facilities, tiered dining areas providing seating required to be accessible shall be required to have accessible routes serving at least 25 percent of the dining area, provided that accessible routes serve accessible seating and where each tier is provided with the same services and similar view

**1108.2.9.1 Dining surfaces.** Where dining surfaces for the consumption of food or drink are provided, at least five percent, but not less than one, of the seating and standing spaces at the dining surfaces shall be accessible and be distributed throughout the facility.

**Exception:** Where food or drink is served at counters exceeding 34 inches (864 mm) in height, such dining surfaces shall not be required to comply with Section 1108.2.9.1 provided equivalent service is available at accessible tables or counters that are in compliance with Section 902 (Dining Surfaces and Work Surfaces) of ICC A117.1 within the same dining area.

**1108.3 Self-service storage facilities.** Self-service storage facilities shall provide accessible individual self-storage spaces in compliance with Section 1104 of this code and ICC A117.1 including Section 905 (Storage Facilities). The number of required self-storage spaces shall be in accordance with Table 1108.3.

**TABLE 1108.3**  
**ACCESSIBLE SELF-SERVICE STORAGE FACILITIES**  
**(Table 1108.3 attached to end of document)**

**1108.3.1 Dispersion.** Accessible individual self-service storage spaces shall be dispersed throughout the various classes of spaces provided. Where more classes of spaces are provided than the number of required accessible spaces, the number of accessible spaces shall not be required to exceed that required by Table 1108.3. Accessible spaces are permitted to be dispersed in a single building of a multibuilding facility.

**1108.4 Judicial facilities.** Judicial facilities shall comply with Sections 1108.4.1 through 1108.4.3.

**1108.4.1 Courtrooms.** Each courtroom shall comply with ICC A117.1 including Section 807 (Courtrooms).

**1108.4.2 Holding cells.** Where provided, central holding cells and court-floor holding cells shall comply with Sections 1108.4.2.1 and 1108.4.2.2.

**1108.4.2.1 Central holding cells.** Where separate central holding cells are provided for adult males, juvenile males, adult females or juvenile females, one of each type shall be accessible. Where central holding cells are provided and are not separated by age or sex, at least one accessible cell shall be provided.

**1108.4.2.2 Court-floor holding cells.** Where separate court-floor holding cells are provided for males, juvenile males, adult females or juvenile females, each courtroom shall be served by one accessible cell of each type. Where court-floor holding cells are provided and are not separated by age or sex, courtrooms shall be served by at least one accessible cell. Accessible cells shall be permitted to serve more than one courtroom.

**1108.4.3 Visiting areas.** Visiting areas shall comply with Sections 1108.4.3.1 and 1108.4.3.2.

**1108.4.3.1 Cubicles and counters.** At least five percent, but not fewer than one, of cubicles shall be accessible on both the visitor and detainee sides. Where counters are provided, at least one shall be accessible on both the visitor and detainee sides.

**Exception:** This requirement shall not apply to the detainee side of cubicles or counters at noncontact visiting areas not serving holding cells.

**1108.4.3.2 Partitions.** Where solid partitions or security glazing separate visitors from detainees, at least one of each type of cubical or counter partition shall be accessible.

## **SECTION BC 1109** **OTHER FEATURES AND FACILITIES**

**1109.1 General.** Accessible building features and facilities shall be provided in accordance with 1109.2 through 1109.15.

**Exception:** Type B dwelling and sleeping units shall comply with Section 1107 and ICC A117.1.

**1109.2 Toilet and bathing facilities.** Toilet rooms and bathing facilities shall be accessible. Where a floor level is not required to be connected by an accessible route, the only toilet rooms or bathing facilities provided within the facility shall not be located on the in accessible floor. At least one of each type of fixture, element, control or dispenser in each accessible toilet room and bathing facility shall be accessible.

**Exceptions:**

1. In toilet rooms or bathing facilities accessed only through a private office, not for common or public use, and intended for use by a single occupant of such private office, any of the following alternatives are allowed:
  - 1.1. Doors are permitted to swing into the clear floor space provided the door swing can be reversed to meet the requirements in Section 603.2.3 (Door Swing) of ICC A117.1; and
  - 1.2. The height requirements for the water closet in Section 604.4 (Height) of ICC A117.1 are not applicable; and
  - 1.3. Grab bars are not required to be installed in a toilet room, provided that the reinforcement has been installed in the walls and located so as to permit the installation of such grab bars; and
  - 1.4. The requirement for height, knee and toe clearance shall not apply to a lavatory.
2. This section is not applicable to dwelling units, sleeping accommodations and patient toilet and bathing facilities that are not required to be accessible by Section 1107.
3. Where multiple single-user toilet rooms or bathing facilities are clustered to be within sight of, or adjacent to one another at a single location and contain fixtures in excess of the minimum required number of plumbing fixtures, at least five percent, but not less than one room for each use at each cluster, shall be accessible.
4. Where no more than one urinal is provided in a toilet room or bathing facility, the urinal is not required to be accessible.
5. Toilet rooms that are part of critical-care or intensive-care patient sleeping rooms are not required to be accessible.

**1109.2.1 Unisex toilet and bathing rooms.** In assembly and mercantile occupancies, an accessible unisex toilet room shall be provided where an aggregate of six or more male and female water closets is required. In buildings of mixed occupancy, only those water closets required for the assembly or mercantile occupancy shall be used to determine the unisex toilet room requirement. In recreational facilities where separate-sex bathing rooms are provided, an accessible unisex bathing room shall be provided. Fixtures located within unisex toilet and bathing rooms may be included in determining the number of fixtures provided in an occupancy.

**Exception:** Where each separate-sex bathing room has only one shower or bathtub fixture, a unisex bathing room is not required.

**1109.2.1.1 Standard.** Unisex toilet and bathing rooms shall comply with Sections 1109.2.1.2 through 1109.2.1.7 and ICC A117.1.

**1109.2.1.2 Unisex toilet rooms.** Unisex toilet rooms shall include only one water closet and only one lavatory. A unisex bathing room in accordance with 1109.2.1.3 shall be considered a unisex toilet room.

**Exception:** A urinal is permitted to be provided in addition to the water closet in a unisex toilet room.

**1109.2.1.3 Unisex bathing rooms.** Unisex bathing rooms shall include only one shower or bathtub fixture. Unisex bathing rooms shall also include one water closet and one lavatory. Where storage facilities are provided for separate-sex bathing rooms, accessible storage facilities complying with Section 1109.8 shall be provided for unisex bathing rooms.

**1109.2.1.4 Location.** Unisex toilet and bathing rooms shall be located on an accessible route. Unisex toilet rooms shall be located not more than one story above or below separate-sex toilet rooms. The accessible route from any separate-sex toilet room to a unisex toilet room shall not exceed 500 feet (152 m).

**1109.2.1.5 Prohibited location.** In passenger transportation facilities and airports, the accessible route from separate-sex toilet rooms to a unisex toilet room shall not pass through security checkpoints.

**1109.2.1.6 Clear floor space.** Where doors swing into a unisex toilet or bathing room, a clear floor space not less than 30 inches by 48 inches (762 mm by 1219 mm) shall be provided, within the room, beyond the area of the door swing.

**1109.2.1.7 Privacy.** Doors to unisex toilet and bathing rooms shall be securable from within the room.

**1109.2.2 Water closet compartment.** Where water closet compartments are provided in a toilet room or bathing facility, at least one wheelchair-accessible compartment shall be provided. Where the combined total water closet compartments and urinals provided in a toilet room or bathing facility is six or more, at least one ambulatory-accessible water closet compartment shall be provided in addition to the wheelchair-accessible compartment. Wheelchair-accessible and ambulatory-accessible compartments shall comply with ICC A117.1 including Section 604.8 (Wheelchair Accessible Compartments) and 604.9 (Ambulatory Accessible Compartments).

**1109.3 Sinks.** Where sinks are provided, at least five percent, but not less than one, provided in accessible spaces shall comply with ICC A117.1 including Section 606 (Lavatories and Sinks).

**Exception:** Mop or service sinks are not required to be accessible.

**1109.4 Kitchens, kitchenettes and wet bars.** Where kitchen, kitchenettes and wet bars not located within dwelling or sleeping units, are provided in accessible spaces or rooms, they shall be accessible in accordance with ICC A117.1 including Section 804 (Kitchens and Kitchenettes).

**1109.5 Drinking fountains.** On floors where drinking fountains are provided, at least 50 percent, but not less than one fountain, shall be accessible.

**1109.6 Elevators.** Passenger elevators on an accessible route shall be accessible and comply with 3001.3.

**1109.6.1 Limited-Use/Limited-Application (LULA) elevators.** LULA elevators shall comply with Section 408 (Limited-Use/Limited-Application Elevator) of ICC A117.1 and with Part XXV of ASME A17.1 and shall be limited to a maximum rise of not more than 25 feet (7620 mm). In new construction, such LULA elevators shall be permitted to be a part of the required accessible route:

1. Where the total floor area of the entire building is less than 10,000 square feet (929 m<sup>2</sup>) provided such LULA elevator serves not more than three contiguous floors and elevators are not otherwise required by Chapter 30; or
2. Where either a wheelchair lift complying with Section 1109.7 is permitted or a private residence elevator complying with Section 409 (Private Residence Elevators) of ICC A117.1 is permitted; or
3. In houses of worship.

**1109.7 Lifts.** Platform (wheelchair) lifts shall not be a part of a required accessible route in new construction except as indicated in Items 1 through 6. Platform (wheelchair) lifts shall be installed in accordance with Chapter 30 and ASME A18.1. Platform (wheelchair) lifts are permitted to be part of a required accessible route in new construction as follows:

1. An accessible route to a performing area in occupancies in Group A.
2. An accessible route to wheelchair spaces required to comply with the wheelchair space dispersion requirements of Section 1108.2.2 through 1108.2.4.
3. An accessible route to spaces that are not open to the general public with an occupant load of not more than five.

4. An accessible route as permitted in Section 1107.2.5 within a dwelling or sleeping unit.
5. An interior accessible route to raised judges' benches, clerks' stations, jury boxes, witness stands and other raised or depressed areas in a court.
6. An accessible route where existing exterior site constraints make use of a ramp or elevator infeasible as determined by the commissioner pursuant to the rules of the department.

**1109.8 Storage.** Where fixed or built-in storage elements such as cabinets, shelves, medicine cabinets, closets, and drawers are provided in required accessible spaces, at least one of each type shall contain storage space complying with ICC A117.1.

**1109.8.1 Lockers.** Where lockers are provided in accessible spaces, at least five percent, but not less than one, of each type shall be accessible.

**1109.8.2 Shelving and display units.** Self-service shelves and display units shall be located on an accessible route. Such shelving and display units shall not be required to comply with reach-range provisions.

**1109.8.3 Coat hooks and folding shelves.** Where coat hooks and folding shelves are provided in toilet rooms, toilet compartments, or in dressing, fitting or locker rooms, at least one of each type shall be provided in accessible toilet rooms without toilet compartment, accessible toilet compartments, and accessible dressing, fitting and locker rooms.

**1109.9 Detectable warnings.** Detectable warnings shall be provided where required in Sections 1109.9.1 through 1109.9.5.

**1109.9.1 Detectable warnings at passenger transit platforms.** Passenger transit platform edges bordering a drop-off and not protected by platform screens or guards shall have a detectable warning.

**Exception:** Detectable warnings are not required at bus stops.

**1109.9.2 Detectable warnings at hazardous vehicular areas.** If a walk crosses or adjoins a vehicular way, and the walking surfaces are not separated by curbs, railings, or other elements between the pedestrian areas and vehicular areas, the boundary between the areas shall be defined by a continuous detectable warning which is 36 inches (914 mm) wide.

**1109.9.3 Detectable warnings at pools.** The edges of pools shall be provided with detectable warnings.



**1109.9.4 Detectable warnings at curb ramps.** A curb ramp shall have a detectable warning. The detectable warning shall extend the full width and depth of the curb ramp.

**1109.9.5 Detectable warnings at other locations.** Detectable warnings shall be located at hazardous locations on floors, doors, and stairs. Doors that lead to areas that might prove hazardous to a person who is blind, including, but not limited to, doors to leading platforms, boiler rooms, and stages, shall be made identifiable to the touch by a textured surface on the door handle, knob, pull or other operating hardware. This textured surface may be made by knurling or roughening or by material applied to the contact surface. Such textured surfaces shall not be provided for emergency exit doors or any doors other than those too hazardous areas.

**1109.10 Assembly area seating.** Assembly areas in every occupancy shall comply with 1108.2 for accessible seating and assistive listening devices.

**1109.11 Seating at tables, counters and work surfaces.** Where seating at fixed or built-in tables, counters or work surfaces is provided in accessible spaces, at least five percent of the seating, but not less than one, shall be accessible. In Group I-3 occupancy visiting areas at least five percent, but not less than one, cubical or counter shall be accessible on both the visitor and detainee sides.

**Exceptions:**

1. Check-writing surfaces at check-out aisles not required to comply with Section 1109.12.2 are not required to be accessible.
2. In Group I-3 occupancies, the counter or cubicle on the detainee side is not required to be accessible at noncontact visiting areas or in areas not serving accessible holding cells or sleeping units.

**1109.11.1 Dispersion.** Accessible fixed or built-in seating at tables, counters or work surfaces shall be distributed throughout the space or facility containing such elements.

**1109.12 Service facilities.** Customer service facilities shall provide for accessible features in accordance with 1109.12.1 through 1109.12.5.

**1109.12.1 Dressing, fitting and locker rooms.** Where dressing rooms, fitting rooms, or locker rooms are provided, at least five percent, but not less than one, of each type of use in each cluster provided shall be accessible.

**1109.12.2 Check-out aisles.** Where check-out aisles are provided, accessible check-out aisles shall be provided in accordance with Table 1109.12.2. Where check-out aisles serve different functions, at least one accessible check-out aisle shall be

provided for each function. Where check-out aisles serve different functions, accessible check-out aisles shall be provided in accordance with Table 1109.12.2 for each function. Where check-out aisles are dispersed throughout the building or facility, accessible check-out aisles shall also be dispersed. Traffic control devices, security devices and turnstiles located in accessible check-out aisles or lanes shall be accessible.

**Exception:** Where the area of the selling space is less than 5,000 square feet (465 m<sup>2</sup>), only one check-out aisle is required to be accessible.

**TABLE 1109.12.2**  
**ACCESSIBLE CHECK-OUT AISLES**  
**(Table 1109.12.2 attached to end of document)**

**1109.12.3 Point of sales and service counters.** Where counters are provided for sales or distribution of goods or services, at least one of each type provided shall be accessible. Where such counters are dispersed throughout the building or facility, the accessible counters shall also be dispersed.

**1109.12.4 Food service lines.** Food service lines shall be accessible. Where self-service shelves are provided, at least 50 percent, but not less than one, of each type provided shall be accessible.

**1109.12.5 Queue and waiting lines.** Queue and waiting lines servicing accessible counters or check-out aisles shall be accessible.

**1109.13 Controls, operating mechanisms and hardware.** Controls, operating mechanisms and hardware intended for operation by the occupant, including switches that control lighting and ventilation, and electrical convenience outlets, in accessible spaces, along accessible routes or as parts of accessible elements shall be accessible.

**Exceptions:**

1. Operable parts that are intended for use only by service or maintenance personnel shall not be required to be accessible.
2. Electrical or communication receptacles serving a dedicated use shall not be required to be accessible.
3. Where two or more outlets are provided in a kitchen above a length of countertop that is uninterrupted by a sink or appliance, one outlet shall not be required to be accessible.
4. Floor electrical receptacles shall not be required to be accessible.

5. HVAC diffusers shall not be required to be accessible.
6. Except for light switches, where redundant controls are provided for a single element, one control in each space shall not be required to be accessible.

**1109.13.1 Operable windows.** Where operable windows are provided in rooms or spaces that are required to be accessible in accordance with 1107.5.1 through 1107.5.4 and 1107.6.1.1, at least one window in each room shall be accessible and each required operable window shall be accessible. Where operable windows are provided in Type B units in accordance with Section 1107.6.2, such windows shall comply with Section 1107.2.4.

**Exception:** Accessible windows are not required in bathrooms or kitchens unless otherwise required in Section 1107.2.4.

**1109.14 Recreational facilities.** Recreational facilities shall be accessible.

**1109.15 Stairways.** Stairways located alongside accessible routes connecting floor levels that are not connected by an elevator shall be designed and constructed to comply with ICC A117.1 and Chapter 10.

## **SECTION BC 1110** **SIGNAGE**

**1110.1 Signs.** Required accessible elements shall be identified by the International Symbol of Accessibility at the following locations:

1. Accessible parking spaces required by Section 1106.1 except where the total number of parking spaces provided is no more than one.
2. Accessible passenger loading zones.
3. Accessible areas of rescue assistance required by Section 1007.6.
4. Accessible rooms where multiple single-user toilet or bathing rooms are clustered at a single location.
5. Accessible entrances where not all entrances are accessible.
6. Accessible check-out aisles where not all aisles are accessible. The sign, where provided, shall be above the check-out aisle in the same location as the check-out aisle number or type of check-out identification.
7. Unisex toilet and bathing rooms.

8. Accessible dressing, fitting and locker rooms where not all such rooms are accessible.
9. Accessible seating.
10. Accessible portable toilets.
11. Public telephones.

**1110.2 Directional signage.** Directional signage indicating the route to the nearest like accessible element shall be provided at the following locations. These directional signs shall include the International Symbol of Accessibility:

1. In accessible building entrances.
2. In accessible public toilets and bathing facilities.
3. Elevators not serving an accessible route.
4. At each separate-sex toilet and bathing room indicating the location of the nearest accessible unisex toilet or bathing room where provided in accordance with Section 1109.2.1.
5. At exits and elevators serving an accessible space, but not providing an approved accessible means of egress, signage shall be provided in accordance with Section 1007.7.

**1110.3 Other signs.** Signage indicating special accessibility provisions shall be provided as follows:

1. Each assembly area required to comply with Section 1108.2.7 shall provide a sign notifying patrons of the availability of assistive listening systems.

**Exception:** Where ticket offices or windows are provided, signs are not required at each assembly area provided that signs are displayed at each ticket office or window informing patrons of the availability of assistive listening systems.

2. At each door to an egress stairway, exit passageway and exit discharge, signage shall be provided in accordance with Section 1011.3.
3. At areas of rescue assistance, signage shall be provided in accordance with Sections 1007.6.3 through 1007.6.5.
4. At exterior areas for assisted rescue, signage shall be provided in accordance with Section 1007.8.3.

**TABLE 1107.6.1.1**  
**ACCESSIBLE DWELLING AND SLEEPING UNITS**

<u>TOTAL NUMBER OF UNITS PROVIDED</u>	<u>MINIMUM REQUIRED NUMBER OF ACCESSIBLE UNITS ASSOCIATED WITH ROLL-IN SHOWERS</u>	<u>TOTAL NUMBER OF REQUIRED ACCESSIBLE UNITS</u>
<u>1 to 25</u>	<u>0</u>	<u>1</u>
<u>26 to 49</u>	<u>0</u>	<u>2</u>
<u>50 to 75</u>	<u>1</u>	<u>4</u>
<u>76 to 100</u>	<u>1</u>	<u>5</u>
<u>101 to 149</u>	<u>2</u>	<u>7</u>
<u>150 and over</u>	<u>1% of total*</u>	<u>5% of total*</u>

\* Where determination by percentage results in a number containing a decimal of 0.5 or more, the next higher number shall be used.

**TABLE 1108.2.2.1  
ACCESSIBLE WHEELCHAIR SPACES**

CAPACITY OF SEATING IN ASSEMBLY AREAS	MINIMUM REQUIRED NUMBER OF WHEELCHAIR SPACES
4 to 25	1
26 to 50	2
51 to 100	4
101 to 300	5
301 to 500	6
501 to 5,000	6, plus 1 for each 150, or fraction thereof, between 501 through 5,000
5,001 and over	36 plus 1 for each 200, or fraction thereof, over 5,000

**TABLE 1108.2.7.1  
RECEIVERS FOR ASSISTIVE LISTENING SYSTEMS**

CAPACITY OF SEATING IN ASSEMBLY AREAS	MINIMUM REQUIRED NUMBER OF RECEIVERS	MINIMUM NUMBER OF RECEIVERS TO BE HEARING-AID COMPATIBLE
50 or less	2	2
51 to 200	2, plus 1 per 25 seats over 50 seats*	2
201 to 500	2, plus 1 per 25 seats over 50 seats.*	1 per 4 receivers*
501 to 1,000	20, plus 1 per 33 seats over 500 seats*	1 per 4 receivers*
1,001 to 2,000	35, plus 1 per 50 seats over 1,000 seats*	1 per 4 receivers*
Over 2,000	55, plus 1 per 100 seats over 2,000 seats*	1 per 4 receivers*

NOTE: \* = or fraction thereof

**TABLE 1108.3  
ACCESSIBLE SELF-SERVICE STORAGE FACILITIES**

TOTAL SPACES IN FACILITY	MINIMUM NUMBER OF REQUIRED ACCESSIBLE SPACES
1 to 200	5%, but not less than 1
Over 200	10, plus 2% of total number of units over 200

**TABLE 1109.12.2  
ACCESSIBLE CHECK-OUT AISLES**

<b>TOTAL CHECK-OUT AISLES OF EACH FUNCTION</b>	<b>MINIMUM NUMBER OF ACCESSIBLE CHECK-OUT AISLES OF EACH FUNCTION</b>
1 to 4	1
5 to 8	2
9 to 15	3
Over 15	3, plus 20% of additional aisles

**CHAPTER 12**  
**INTERIOR ENVIRONMENT**

**SECTION BC 1201**  
**GENERAL**

**1201.1 Scope.** The provisions of this chapter shall govern ventilation, temperature control, lighting, yards and courts, sound transmission, room dimensions, surrounding materials and rodent proofing associated with the interior spaces of buildings.

**SECTION BC 1202**  
**DEFINITIONS**

**1202.1 General.** The following words and terms shall, for the purposes of this chapter and as used elsewhere in this code, have the meanings shown herein.

**HABITABLE SPACE.** All rooms and spaces within a dwelling unit in group R or I-1, including bedrooms, living rooms, studies, recreation rooms, kitchens, dining rooms, and other similar spaces.

**Exception:** The following spaces within a dwelling unit shall not be considered habitable spaces:

1. A dining space 55 square feet (5.1 m<sup>2</sup>) or less located off a living room, foyer, or kitchen;
2. A kitchenette;
3. A bathroom or toilet room;
4. A laundry room;
5. A corridor, passageway, or private hall; and a foyer used as an entrance hall in a dwelling unit: not exceeding 10 percent of the total floor area of the dwelling unit; or not exceeding 20 percent of the floor area of the dwelling unit where every habitable room is at least 20 percent larger than the required minimum room sizes established by the *New York City Housing Maintenance Code*.

**KITCHEN.** A room with 80 square feet (7.4 m<sup>2</sup>) or more of floor area which is intended, arranged, designed or used for cooking or warming of food.

**KITCHENETTE.** A space with less than 80 square feet (7.4 m<sup>2</sup>) of floor area which is intended, arranged, designed or used for cooking or warming of food.

**OCCUPIABLE SPACE.** A room or enclosed space, other than a habitable space, designed for human occupancy or use in which individuals may remain for a period of



time for rest, amusement, treatment, education, dining, shopping, employment, labor or other similar purposes.

**THERMALLY ISOLATED SUNROOM ADDITION.** A one-story addition added to an existing building with a glazed area in excess of 40 percent of the gross area of its exterior walls and roof, with a separation of conditioned spaces, between such addition and a dwelling unit, consisting of existing or new wall(s), doors and/or windows.

## **SECTION BC 1203** **VENTILATION**

**1203.1 General.** Buildings shall be provided with natural ventilation in accordance with Section 1203.4, and/or mechanical ventilation in accordance with the *New York City Mechanical Code*. All habitable spaces shall be provided with natural ventilation in accordance with Section 1203.4.

**1203.2 Attic spaces.** Enclosed attics and enclosed rafter spaces formed where ceilings are applied directly to the underside of roof framing members shall have cross ventilation for each separate space by ventilating openings protected against the entrance of rain and snow. Blocking and bridging shall be arranged so as not to interfere with the movement of air. A minimum of 1 inch (25 mm) of airspace shall be provided between the insulation and the roof sheathing. The net free ventilating area shall not be less than  $\frac{1}{150}$  of the area of the space ventilated, with 50 percent of the required ventilating area provided by ventilators located in the upper portion of the space to be ventilated at least 3 feet (914 mm) above eave or cornice vents with the balance of the required ventilation provided by eave or cornice vents.

**Exception:** The minimum required net free ventilating area shall be  $\frac{1}{300}$  of the area of the space ventilated, provided a vapor retarder having a transmission rate not exceeding 1 perm in accordance with ASTM E 96 is installed on the warm side of the attic insulation and provided 50 percent of the required ventilating area provided by ventilators located in the upper portion of the space to be ventilated at least 3 feet (914 mm) above eave or cornice vents, with the balance of the required ventilation provided by eave or cornice vents.

**1203.2.1 Openings into attic.** Exterior openings into the attic space of any building intended for human occupancy shall be covered with corrosion-resistant wire cloth screening, hardware cloth, perforated vinyl or similar material that will prevent the entry of birds, squirrels, rodents, snakes and other similar creatures. The openings therein shall be a minimum of  $\frac{1}{8}$  inch (3.2 mm) and shall not exceed  $\frac{1}{4}$  inch (6.4 mm). Where combustion air is obtained from an attic area, it shall be in accordance with Chapter 7 of the *New York City Mechanical Code*.

**1203.3 Under-floor ventilation.** The space between the bottom of the floor joists and the earth under any building except spaces occupied by a basement or cellar shall be

provided with ventilation openings through foundation walls or exterior walls. Such openings shall be placed so as to provide cross ventilation of the under-floor space.

**1203.3.1 Openings for under-floor ventilation.** The minimum net area of ventilation openings shall not be less than 1 square foot for each 150 square feet (0.09 m<sup>2</sup> for each 13.9m<sup>2</sup>) of crawl-space area. Ventilation openings shall be covered for their height and width with any of the following materials, provided that the least dimension of the covering shall not exceed ¼ inch (6.4 mm):

1. Perforated sheet metal plates not less than 0.070 inch (1.8 mm) thick.
2. Expanded sheet metal plates not less than 0.047 inch (1.2 mm) thick.
3. Cast-iron grills or gratings.
4. Extruded load-bearing vents.
5. Hardware cloth of 0.035 inch (0.89 mm) wire or heavier.
6. Corrosion-resistant wire mesh, with the least dimension not exceeding ⅛ inch (3.2 mm).

**1203.3.2 Exceptions.** The following are exceptions to Sections 1203.3 and 1203.3.1:

1. Where warranted by climatic conditions, ventilation openings to the outdoors are not required if ventilation openings to the interior are provided.
2. The total area of ventilation openings is permitted to be reduced to 1/1,500 of the under-floor area where the ground surface is treated with an approved vapor retarder material and the required openings are placed so as to provide cross ventilation of the space. The installation of operable louvers, in accordance with Section 1203.3.1, shall not be prohibited.
3. Ventilation openings are not required where continuously operated mechanical ventilation is provided at a rate of 1.0 cubic foot per minute (cfm) for each 50 square feet (1.02 L/s for each 10 m<sup>2</sup>) of crawl-space floor area and the ground surface is covered with an approved vapor retarder.
4. Ventilation openings are not required when the ground surface is covered with an approved vapor retarder, the perimeter walls are insulated and the space is conditioned in accordance with the *New York State Energy Conservation Construction Code*.
5. For buildings in areas of special flood hazard, the openings for under-floor ventilation shall comply with Appendix G.

**1203.4 Natural ventilation.** Natural ventilation of occupiable and habitable space shall be through openings to the outdoors. The openings shall be of a type permitted under Sections 1203.4.1.1, 1203.4.1.2, 1203.4.1.3 and 1203.4.1.4. The operating mechanism for such openings shall be provided with ready access so that the openings are readily controllable by the building occupants.

**1203.4.1 Ventilation area required.** Ventilation areas shall be as set forth in Sections 1203.4.1.1 through 1203.4.1.4.

**1203.4.1.1 Occupiable spaces.** Where occupiable spaces are not required to be provided with mechanical ventilation in accordance with the *New York City Mechanical Code*, natural ventilation shall be provided in accordance with Section 1203.4.1.1. Openings providing required natural ventilation to occupiable spaces shall be windows, doors, louvers, skylights, or other similar ventilating openings.

**Exceptions:**

1. Bathrooms and toilet rooms in R or I-1 occupancies shall comply with Section 1203.4.1.3.
2. Kitchenettes in R or I-1 occupancies shall comply with Section 1203.4.1.4.

**1203.4.1.1.1 Minimum opening.** The minimum openable area to the outdoors shall be 4 percent of the floor area of the occupiable space being ventilated.

**1203.4.1.1.2 Adjoining spaces.** Where occupiable rooms and spaces without openings to the outdoors are ventilated through an adjoining room, the opening to the adjoining room shall be unobstructed and shall have an area of not less than 8 percent of the floor area of the interior room or space, but not less than 25 square feet (2.3 m<sup>2</sup>). The minimum openable area to the outdoors shall be based on the total floor area being ventilated.

**Exception:** Exterior openings required for ventilation shall be permitted to open into a thermally isolated sunroom addition or covered patio provided that the openable area between such sunroom addition or covered patio and the interior room shall have an area of not less than 8 percent of the floor area of the interior room or space, but not less than 20 square feet (1.9 m<sup>2</sup>). The minimum openable area to the outdoors shall be based on the total floor area being ventilated.

**1203.4.1.1.3 Openings below grade.** Where openings below grade provide required natural ventilation, the outside horizontal clear space measured perpendicular to the opening shall be one and one-half times the depth of the opening. The depth of the opening shall be measured from the average adjoining ground level to the bottom of the opening.

**1203.4.1.1.4 Mezzanines.** Where an interior balcony or mezzanine opens to form part of another room or space, its area shall be added to the area of the room or space in which it is located to compute the ventilation required for both spaces.

**1203.4.1.2 Habitable spaces.** All habitable spaces shall be provided with natural ventilation in accordance with Section 1203.4.1.2. Openings providing required natural ventilation to habitable spaces shall be windows and/or glazed doors.

**Exception:** R-3 occupancies. Openable skylights, opening directly to the outer air, transparent or translucent panels, or other natural light-transmitting media may be substituted for window openings in R-3 occupancies provided that they meet the minimum dimensional requirements of Section 1203.4.1.2.1.

**1203.4.1.2.1 Minimum opening.** The minimum openable area to the outdoors shall be 5 percent of the floor area of the habitable space being ventilated. Every opening providing required natural ventilation shall be at least 12 square feet (1.1 m<sup>2</sup>) of glazed area, providing a minimum of 6 square feet (0.56 m<sup>2</sup>) of openable area.

**Exceptions:**

1. Where fresh air is furnished in any habitable room or space by mechanical means supplying a minimum of 40 cubic feet per minute (0.02 m<sup>3</sup>/s), the free openable area of the openings may be reduced to 2 ½ percent of the floor area but each such opening shall provide not less than 5 ½ square feet (0.51 m<sup>2</sup>) of openable area
2. The minimum free openable area of a mullioned casement window shall be 5 ½ square feet (0.51 m<sup>2</sup>), provided that the minimum ratio of floor area to openable area is met.

**1203.4.1.2.2 Adjoining spaces.** An alcove or room opening off another room or space shall be considered as a separate room in determining its requirements for ventilation.

**Exceptions:**

1. Alcoves within R-3 dwelling units. In R-3 occupancies, where an opening between the alcove and the room or space is at least 80 percent of the area of the common wall and the floor area of the alcove does not exceed twice the area of the opening, the alcove and the room opening into the alcove may be considered as a single space.

2. Balconies, partially enclosed. Exterior openings required for ventilation shall be permitted to open upon a partially enclosed balcony or space above a setback when:

2.1. Such balcony or space faces upon a public street, space, alley, park, highway, or right of way; or upon a yard, court, plaza, or space above a setback where such yard, court, plaza, or space above a setback complies with Section 1206;

2.2. The maximum depth of any habitable room is 30 feet (9144 mm) measured from the outer face of the exterior wall forming the partial or full enclosure of the balcony or space;

2.3. The enclosure of the balcony or space is not more than one story in height; and

2.4. The front of a partially enclosed balcony or space above a setback shall be open to the outer air with an open area equal to at least 75 percent of the floor surface area of such balcony or space.

3. Balconies, fully enclosed. Exterior openings required for ventilation shall be permitted to open upon a fully enclosed balcony or space above a setback, including thermally isolated sunroom additions and patio covers, when:

3.1. Such balcony or space faces upon a public street, space, alley, park, highway, or right of way; or upon a yard, court, plaza, or space above a setback where such yard, court, plaza, or space above a setback complies with Section 1206;

3.2. The maximum depth of any habitable room is 30 feet (9144 mm) measured from the outer face of the exterior wall forming the partial or full enclosure of the balcony or space;

3.3. The enclosure of the balcony or space is not more than one story in height;

3.4. The building is Type I or II construction;

3.5. The outer enclosing walls of the balcony or space are glazed with an area at least 50 percent of the area of the interior enclosing walls of such balcony or space; the glazing may be clear plate glass or slow burning plastic;

3.6. At least 50 percent of the glazed area required by Exception

3.5 of this section is openable; and

3.7. No window from any bathroom, toilet room, kitchen or kitchenette shall open on such balcony or space.

4. Mezzanines and split-level rooms. Where a habitable mezzanine or portion of a split-level room or space is not directly served by an opening providing natural ventilation in accordance with Section 1203.4.1.2, such mezzanine or space shall open for its full width with no obstruction, except for railings, to an adjoining habitable room which is provided with natural ventilation. The floor area of such mezzanine or portion of the split level room or space shall be added to the floor area of the adjoining room to compute the required ventilation in accordance with Section 1203.4.1.2.1. The combined space shall also comply with Sections 1203.4.1.2.4 and 1203.4.5.

**1203.4.1.2.3 Basements and cellars.** Where openings provide natural ventilation to habitable spaces located in basements or cellars, such opening shall also comply with the applicable provisions of Section 27-2081 through 27-2087 of the *New York City Housing Maintenance Code* and Sections 26(8) and 34 of the New York State Multiple Dwelling Law.

**1203.4.1.2.4 Maximum depth of room.** No part of any room shall be more than 30 feet (9144 mm) from a window opening onto a street or yard unless such room also opens onto a court complying with Section 1206.

**Exception:** In dwelling units containing more than 3 habitable rooms in group R1 or R2 occupancies in buildings of Type I or II construction, rooms may be greater than 30 feet (9144 mm) in depth provided that all other requirements of Section 1203.4.1.2 are met and that the required windows are so located as to properly light all portions of the room in accordance with Section 1205.

**1203.4.1.3 Bathrooms and toilet rooms in R and I-1 occupancies.** Bathrooms or toilet rooms in R or I-1 occupancies shall be provided with natural ventilation in accordance with Section 1203.4.1.3, unless provided with exhaust ventilation in accordance with the *New York City Mechanical Code*. Openings providing required natural ventilation shall be windows.

**Exception:** Openable skylights may be substituted for windows provided that the bathroom or toilet room is on the top story.

**1203.4.1.3.1 Minimum opening.** The minimum openable area to the outdoors shall be 5 percent of the floor area of the space being ventilated. Every window or skylight providing required natural ventilation shall be at least 3

square feet (0.28 m<sup>2</sup>) providing a minimum of 1 ½ square feet (0.14 m<sup>2</sup>) of openable area.

**1203.4.1.3.2 Adjoining spaces.** Natural ventilation for bathrooms and toilet rooms may not be through openings from another room or space.

**Exception:** a bathroom or toilet room may open onto a partially enclosed balcony or space above a setback conforming with Exception 2 of Section 1203.4.1.2.2.

**1203.4.1.3.3 Basements and cellars.** Where openings provide natural ventilation to bathrooms or toilet rooms located in basements or cellars, such opening shall also comply with the applicable provisions of Section 27-2081 through 27-2087 of the *New York City Housing Maintenance Code* and Sections 26(8) and 34 of the New York State Multiple Dwelling Law.

**1203.4.1.4. Kitchenettes in R and I-1 occupancies.** Kitchenettes in R or I-1 occupancies shall be provided with natural ventilation in accordance with Section 1203.4.1.4, unless provided with exhaust ventilation in accordance with the *New York City Mechanical Code*. Openings providing required natural ventilation shall be windows.

**Exception:** Openable skylights may be substituted for windows provided that:

1. The kitchenette is on the top story;
2. The skylight is 12 inches (305 mm) in its least dimensions;
3. The skylight is at least 4 square feet (0.37 m<sup>2</sup>) or ⅛ of the area of the kitchenette, whichever is greater; and
4. The skylight provides ventilating openings for at least ½ of its area.

**1203.4.1.4.1 Minimum opening.** The minimum openable area to the outdoors shall be 5 percent of the floor area of the space being ventilated. Every window or other opening providing required natural ventilation shall be at least 1 foot (305 mm) wide and at least 3 square feet (0.28 m<sup>2</sup>) in total area, providing a minimum of 1 ½ square feet (0.14 m<sup>2</sup>) of openable area.

**Exception:** Skylights shall comply with the Exception of Section 1203.4.1.4.

**1203.4.1.4.2 Adjoining spaces.** Natural ventilation for kitchenettes shall not be through openings off another room or space.

**Exception:** A kitchenette may open onto a partially enclosed balcony or space above a setback conforming with Exception 2 of Section 1203.4.1.2.2.

**1203.4.1.4.3 Basements and cellars.** Where openings provide natural ventilation to kitchenettes less than 80 square feet (7.4 m<sup>2</sup>) located in basements or cellars, such opening shall also comply with the applicable provisions of Sections 27-2081 through 27-2087 of the *New York City Housing Maintenance Code* and Sections 26(8) and 34 of the New York State Multiple Dwelling Law.

**1203.4.2 Contaminants exhausted.** Contaminant sources in naturally ventilated spaces shall be removed in accordance with the *New York City Mechanical Code*.

**1203.4.2.1 Bathrooms.** Rooms containing bathtubs, showers, spas and similar bathing fixtures in other than R and I-1 occupancies shall be mechanically ventilated in accordance with the *New York City Mechanical Code*, whether or not they are also provided with natural ventilation.

**1203.4.3 Openings on yards or courts.** Natural ventilation shall be provided by openings to a public street, space, alley, park, highway, or right of way; or upon a yard, court, plaza, or space above a setback where such yard, court, plaza, or space above a setback complies with Section 1206. No such opening shall be on a recess of less than 6 feet (1829 mm) in width.

**Exceptions:**

1. Openings providing natural ventilation to habitable spaces located in basements or cellars shall also comply with the applicable provisions of Sections 27-2081 through 27-2087 of the *New York City Housing Maintenance Code* and Sections 26(8) and 34 of the New York State Multiple Dwelling Law.
2. A kitchenette, a bathroom, or a water closet compartment may be located on a recess of less than 6 feet (1829 mm).

**1203.4.4 Measurement of openings.** Dimensions of windows and other openings shall always be taken between stop beads or, if there are no stop beads, between the sides, head, and sill of the sash opening.

**1203.4.5 Height of openings.** The top of at least one opening providing required natural ventilation to a habitable room or space shall be a minimum of 7 feet (2134 mm) above the floor of the room or space served by the window or opening.

**Exception: Mezzanines.** Where the required natural ventilation for a habitable mezzanine level is provided by a window(s) on the lower level in accordance with Section 1203.4.1.2.2 (Exception 4), and where compliance with Section 1203.4.5



is not feasible on the mezzanine floor, Section 1203.4.5 shall not apply to such mezzanine floor provided that either:

1. Such window(s) is on the opposite wall from the mezzanine, and the top of such window is at least 12 inches (305 mm) above the floor of the mezzanine; or
2. Mechanical ventilation is provided to the mezzanine level in accordance with the *New York City Mechanical Code* capable of providing 2 cubic feet per minute (0.00094 m<sup>3</sup>/s) of fresh air per square foot (0.09 m<sup>2</sup>) of floor area of mezzanine.

**1203.5 Other ventilation and exhaust systems.** Ventilation and exhaust systems for occupancies and operations involving flammable or combustible hazards or other contaminant sources as covered in the *New York City Mechanical Code* or the *New York City Fire Code* shall be provided as required by both codes.

## **SECTION BC 1204** **TEMPERATURE AND HUMIDITY CONTROL**

**1204.1 Equipment and Systems.** Interior spaces intended for human occupancy shall be provided with active or passive space-heating systems capable of maintaining a minimum indoor temperature as indicated in Table 1204.1 at a point 3 feet (914 mm) above the finished floor. The heating capacity of heat-producing devices and equipment which are contained in the room and in constant use during occupancy may be deducted from the capacity of the heating system. Portable heating systems shall not be considered as contributing to the capacity of the heating system.

**Exception:** Where specific rooms or spaces are not listed, the temperature shall be determined by the requirements of the listed space to which they most nearly conform or as determined by the registered design professional.

### **TABLE 1204.1** **MINIMUM SPACE TEMPERATURE REQUIREMENTS<sup>a</sup>** **(Table 1204.1 attached to end of document)**

**1204.2 Air Conditioning.** Interior spaces intended for human occupancy that are provided with air conditioning shall be provided with active or passive systems that are capable of maintaining 78°F (26°C) at 50 percent relative humidity when the outdoor air temperature is 89°F (32°C) and the coincident wet bulb temperature is 73°F (23°C). Interior spaces without air conditioning shall be provided with mechanical or natural ventilation in compliance with other subsections of this code.

**1204.3 Freeze Protection.** All interior spaces shall be provided with active or passive systems or with methods of construction capable of preventing wet piping systems and

vessels from freezing at all times, including permanently installed pipe heat tracing systems.

**1204.4 System Design.** The heating system and air conditioning system, as applicable, shall be designed to provide sufficient capacity to meet the temperature and humidity requirements of Section 1204 when considering the outdoor air ventilation requirements and all losses in the system and ancillary uses, such as domestic hot water, for which the system is used. The system shall be designed and installed to meet all other applicable provisions of this code.

## **SECTION BC 1205** **LIGHTING**

**1205.1 General.** Every room and space in every building shall be provided with artificial light in accordance with Section 1205.3. Every habitable room and space shall also be provided with natural light by means of exterior glazed openings in accordance with Section 1205.2.

**Exceptions.** Artificial light need not be provided in rooms or spaces:

1. Occupied exclusively during the daylight hours between one hour after sunrise and one hour before sunset, and which are provided with natural light meeting the requirements of 1205.2; or
2. With less than 40 square feet (3.7 m<sup>2</sup>) of floor area if they are used exclusively for storage purposes or for mechanical facilities containing no rotating or moving parts, no combustion equipment, or no other hazardous equipment.

**1205.2 Natural light.** Every opening providing required natural light shall be so located so as to properly light all portions of the room. Openings providing required natural light shall be windows and/or glazed doors.

**Exceptions:** R-3 occupancies. Skylights, opening directly to the outer air, transparent or translucent panels, or other light-transmitting media, may be substituted for window openings in R-3 occupancies provided that they meet the minimum dimensional requirements of Section 1205.2.2.

**1205.2.1 Minimum opening.** The minimum net glazed area shall not be less than 10 percent of the floor area of the room served. Every opening providing required natural light shall be at least 12 square feet (1.1 m<sup>2</sup>) of glazed area.

**1205.2.2 Adjoining spaces.** An alcove or room opening off another room or space shall be considered as a separate room in determining its requirements for natural lighting.

**Exceptions:**

1. Alcoves within R-3 dwelling units. In R-3 occupancies, where an opening between the alcove and the room or space is at least 80 percent of the area of the common wall and the floor area of the alcove does not exceed twice the area of the opening, the alcove and the room opening into the alcove may be considered as a single space.
  
2. Balconies, partially enclosed. Exterior openings required for natural light shall be permitted to open upon a partially enclosed balcony or space above a setback when:
  - 2.1. Such balcony or space faces upon a public street, space, alley, park, highway, or right of way; or upon a yard, court, plaza, or space above a setback where such yard, court, plaza, or space above a setback complies with Section 1206;
  
  - 2.2. The maximum depth of any habitable room is 30 feet (9144 mm) measured from the outer face of the exterior wall forming the partial or full enclosure of the balcony or space;
  
  - 2.3. The enclosure of the balcony or space is not more than one story in height; and
  
  - 2.4. The front of a partially enclosed balcony or space above a setback shall be open to the outer air with an open area equal to at least 75 percent of the floor surface area of such balcony or space.
  
3. Balconies, fully enclosed. Exterior openings required for natural lighting shall be permitted to open upon a fully enclosed balcony or space above a setback, including thermally isolated sunroom additions and covered patios, when:
  - 3.1. Such balcony or space faces upon a public street, space, alley, park, highway, or right of way; or upon a yard, court, plaza, or space above a setback where such yard, court, plaza, or space above a setback complies with Section 1206;
  
  - 3.2. The maximum depth of any habitable room is 30 feet (9144 mm) measured from the outer face of the wall forming the partial or full enclosure of the balcony or space;
  
  - 3.3. The enclosure of the balcony or space is not more than one story in height;
  
  - 3.4. The building is Type I or II construction;

- 3.5. The outer enclosing walls of the balcony or space are glazed with an area at least 50 percent of the area of the interior enclosing walls of such balcony or space; the glazing may be clear plate glass or slow burning plastic;
- 3.6. At least 50 percent of the glazed area required by Exception 3.5 of this section is openable; and
- 3.7. No window from any bathroom, toilet room, kitchen or kitchenette shall open on such balcony or space.
4. Mezzanines and split-level rooms. Where a habitable mezzanine or portion of a split-level room or space is not directly served by an opening providing natural lighting in accordance with Section 1205.2, such space shall be open for its full width with no obstruction, except for railings, to an adjoining habitable room which is provided with such window or other opening. The floor area of the such mezzanine or portion of the split level room or space shall be added to the floor area of the adjoining room to compute the required lighting in accordance with Section 1205.2.1. The combined space shall also comply with Sections 1205.2.4 and 1205.2.7.

### **1205.2.3 Basements and cellars.**

**1205.2.3.1 Adequate adjacent space for multiple dwellings.** Where rooms within a dwelling unit in a multiple dwelling are located in a cellar or a basement, such rooms shall have at least ½ of their height and all of their required window surfaces above every part of an "adequate adjacent space". Such "adequate adjacent space" shall be open to the sky and shall be a continuous surface area not less than 30 feet (9144 mm) in its least dimension abutting at same level or directly below the exterior walls of every part of the basement and cellar portions of such dwelling unit. Such "adequate adjacent space" shall be spaces that are located on the same tax lot or plot as the building or a public street, space, alley, park, highway or right of way and the level of such areas which abut or adjoin the habitable room shall be at least 6 inches (152 mm) below the window sills of any windows.

**1205.2.3.2 Other applicable laws.** Where openings provide natural lighting to habitable spaces located in basements or cellars, such opening shall comply with the applicable provisions of Sections 27-2081 through 27-2087 of the *New York City Housing Maintenance Code* and Sections 26(8) and 34 of the *New York State Multiple Dwelling Law*.

**1205.2.4 Maximum depth of room.** No part of any room shall be more than 30 feet (9144 mm) from a window opening on a street or yard unless such room also opens onto a legal court.

**Exception:** In dwelling units containing more than 3 habitable rooms in R-1 or R-2 occupancies in buildings of Type I or II construction, rooms may be greater than 30 feet (9144 mm) in depth provided that all other requirements of Section 1205.2 are met and that the required windows are located so as to properly light all portions of the room.

**1205.2.5 Openings on yards or courts.** Exterior glazed openings shall open directly onto a public street, space, alley, park, highway, or right of way; or upon a yard, court, plaza, or space above a setback where such yard, court, plaza, or space above a setback complies with Section 1206. No such opening shall be on a recess of less than 6 feet (1829 mm) in width.

**Exception:** Spaces located in basements or cellars shall also comply with Section 1205.2.3.

**1205.2.6 Measurement of glazed areas.** Window dimensions shall always be taken between stop beads or, if there are no stop beads, between the sides, head, and sill of the sash opening.

**1205.2.7 Height of glazed areas.**

**1205.2.7.1** Only that portion of glazed areas higher than 30 inches (9144 mm) above the floor shall be considered as providing the required natural lighting.

**1205.2.7.2** The top of at least one window or other opening providing required natural lighting to a habitable room shall be a minimum of 7 feet (2134 mm) above the floor of the room or space served by the window or opening.

**Exception: Mezzanines.** Where the required natural lighting for a habitable mezzanine level is provided by a window(s) on the lower level in accordance with Section 1205.2.2 Exception 4, and where compliance with Section 1205.2.7.2 is not feasible on the mezzanine floor, Section 1205.2.7.2 shall not apply to such mezzanine floor provided that either:

1. Such window(s) is on the opposite wall from the mezzanine, and the top of such window is at least 12 inches (305 mm) above the floor of the mezzanine; or
2. Mechanical ventilation is provided to the mezzanine level in accordance with the *New York City Mechanical Code* capable of providing 2 cubic feet per minute (0.00094 m<sup>3</sup>/s) of fresh air per square foot (0.09 m<sup>2</sup>) of floor area of mezzanine.

**1205.3 Artificial light.**

**1205.3.1 General.** Artificial light shall meet the minimum illumination standards set forth in Section 1205.3. Artificial light shall not exceed maximum energy consumption requirements, if applicable, as required by Section 1301.1.1.

**1205.3.2 Rooms and spaces.** Artificial light shall be adequate to provide an average illumination of 10 foot-candles (107 lux) over the area of the room at a height of 30 inches (762 mm) above the floor level.

**1205.3.3 Stairways.** Stairways within dwelling units and exterior stairways serving a dwelling unit shall have an illumination level on tread runs of not less than 1 foot-candle (11 lux). Stairs in other occupancies shall be governed by Chapter 10.

**1205.3.4 Means of egress.** The means of egress shall be illuminated in accordance with Section 1006.1. Exterior lights near entranceways to multiple dwellings shall also comply with Section 27-2040 of the *New York City Housing Maintenance Code*.

**1205.3.5 Places of assembly.** Places of assembly shall be illuminated in accordance with Chapter 10.

**1205.4** Reserved.

**1205.5** Reserved.

## **SECTION BC 1206** **YARDS AND COURTS**

**1206.1 General.** This section shall apply to yards and courts adjacent to exterior openings that provide required natural light or required natural ventilation. Such yards and courts shall be on the same zoning lot as the building. Where such yard or court is wholly or partially on a different tax lot from the exterior opening which the yard or court serves, a light and air easement or restrictive declaration acceptable to the commissioner shall be recorded against the tax lot or lots where such yard or court is located.

**1206.2 Yards.** Yards shall not be less than the dimensions prescribed by the Zoning Resolution of the City of New York and other applicable laws, rules, and regulations.

**1206.2.1 Rear yard access for multiple dwellings.** For multiple dwellings, there shall be direct access from the street to every rear yard through a noncombustible 2-hour fire-resistance-rated passage either in a direct line or through a court, except that the passage may be 1-hour fire-resistance-rated for dwellings not exceeding three stories in height and occupied by not more than 2 families on any story. Such passage shall be at least 36 inches (914 mm) in clear width and 7 feet (2134 mm) in height.

**Exceptions.** No such passage shall be required for:

1. Buildings of Type IA or IB construction.

2. Buildings not exceeding three stories in height, and occupied by not more than one family on any story nor more than three families in all.
3. Buildings not exceeding two stories in height, and occupied by not more than two families on any story nor more than four families in all.

**1206.3 Courts.** Courts shall not be less than the dimensions prescribed by the Zoning Resolution of the City of New York and other applicable laws, rules and regulations.

**1206.3.1 Court access.** Access shall be provided to the bottom of courts for cleaning purposes.

**1206.3.2 Air intake.** Courts more than two stories in height shall be provided with a horizontal air intake at the bottom not less than 10 square feet (0.93 m<sup>2</sup>) in area and leading to the exterior of the building unless abutting a yard or public way.

**Exception:** For multiple dwellings more than two stories in height, an air intake with a vertical cross-sectional area of 21 square feet (1.95 m<sup>2</sup>) and a least minimum dimension of 3 feet (914 mm) shall be provided at or near the lowest level of any court, in accordance with Section 26(7)(a) of the New York State Multiple Dwelling Law.

**1206.3.3 Court drainage.** The bottom of every court shall be properly graded and drained to a public sewer or other approved disposal system complying with the *New York City Plumbing Code*. For group R and I-1 occupancies, such grading and drainage shall also comply with Section 27-2027 of the *New York City Housing Maintenance Code*. For R-1, R-2 and I-1 occupancies, such grading and drainage shall also comply with Section 77 of the New York State Multiple Dwelling Law.

**1206.3.4 Court walls for multiple dwellings.** All walls enclosing courts of multiple dwellings shall be of light colored materials or shall be painted a light color.

**Exceptions:**

1. Outer courts that open to a street
2. Courts that exceed the minimum dimension set forth in the Zoning Resolution of the City of New York by at least 50 percent.

**1206.4 Lighting in courts and yards.** Where a building is classified in or contains space classified in Groups I-1, R-1 or R-2, all yards and courts shall be artificially illuminated with a minimum intensity of not less than 1-foot-candle (11 lux) measured 30 inches (762 mm) above the floor of the lowest level of such yards or courts.

**SECTION BC 1207**

## SOUND TRANSMISSION

**1207.1 Scope.** This section shall apply to common interior walls, partitions and floor/ceiling assemblies between adjacent dwelling units, between dwelling units and adjacent mechanical equipment spaces, or between dwelling units and adjacent public areas such as halls, corridors, stairs or service areas.

**1207.2 Air-borne sound.** Walls, partitions and floor/ceiling assemblies separating dwelling units from each other, from public or service areas, from stairs or from mechanical equipment spaces, including boiler rooms, or elevator or other shafts shall have a sound transmission class (STC) of not less than 50 (45 if field tested) for air-borne noise when tested in accordance with ASTM E 90. Dwelling unit entrance doors shall have an STC of not less than 35. Penetrations or openings in construction assemblies for piping; electrical devices; recessed cabinets; bathtubs; soffits; or heating, ventilating or exhaust ducts shall be sealed, lined, insulated or otherwise treated to maintain the required ratings.

**1207.2.1 Machine and equipment rooms.** Elevator machine rooms and machinery spaces containing equipment totaling more than 75 rated h.p. shall not be located vertically or horizontally adjacent to dwelling units unless the total sound power level output of all the equipment in the machine room or space is certified not to exceed the maximum sound power levels of table 1207.2.1 in any octave band.

**TABLE 1207.2.1**  
**MAXIMUM SOUND POWER LEVEL OUTPUTS FOR MACHINE ROOMS**  
**ADJACENT TO DWELLING UNITS**  
**(Table 1207.2.1 attached to end of the document)**

**1207.3 Structure-borne sound.** Floor/ceiling assemblies between dwelling units or between a dwelling unit and a public or service area stair, exterior mechanical equipment, or other mechanical equipment space, including boiler rooms, shall have an impact insulation class (IIC) rating of not less than 50 (45 if field tested) when tested in accordance with ASTM E 492. See Chapter 30 for additional sound control requirements for elevator machinery.

**1207.3.1 Refuse chutes.** Metal refuse chutes, metal chute supports, and/or metal chute bracing shall be free of direct contact with the shaft enclosure and the openings provided in the floor construction. Metal chutes shall be resiliently supported at each structural support location. Isolators shall provide a minimum static deflection of 0.3 inches (7.62 mm). All chutes shall be plumb.

## SECTION BC 1208 INTERIOR SPACE DIMENSIONS

**1208.1 Minimum room widths.** Habitable spaces, other than a kitchen, shall not be less than 8 feet (2438 mm) in any plan dimension. Kitchens and kitchenettes shall have a clear



passageway of not less than 3 feet (914 mm) between counter fronts and appliances or counter fronts and walls.

**Exceptions:**

1. A room that complies with the requirements for natural light and natural ventilation and in addition has an unobstructed opening of not less than 60 square feet (5.6 m<sup>2</sup>) into an immediately adjoining room shall not be less than 7 feet (2134 mm) in any plan dimension.
2. A habitable dining space that complies with the requirements for natural light and natural ventilation may be less than 8 feet (2438 mm) in any plan dimension.
3. One-half the number of bedrooms in a dwelling unit containing 3 or more bedrooms shall not be less than 7 feet (2134 mm) in any plan dimension.
4. A room in a group R-1 dwelling or sleeping unit shall not be less than 6 feet (1829 mm) in any plan dimension.

**1208.2 Minimum ceiling heights.** Habitable rooms and spaces shall have a ceiling height of not less than 8 feet (2438 mm). Occupiable spaces and corridors shall have a ceiling height of not less than 7 feet 6 inches (2286 mm). Bathrooms, toilet rooms, kitchens in other than I-1 and R occupancies, kitchenettes in I-1 or R occupancies, storage rooms and laundry rooms shall be permitted to have a ceiling height of not less than 7 feet (2134 mm). All measurements shall be taken from the finished floor to the finished underside of the ceiling or ceiling beams.

**Exceptions:**

1. In one- and two-family dwellings, beams or girders spaced not less than 4 feet (1219 mm) on center may project not more than 6 inches (152 mm) below the required ceiling height, provided that a clear height of 7 feet (2134 mm) is maintained.
2. Habitable rooms in basements of one-family dwellings, including any projecting beams, shall have a ceiling height of not less than 7 feet (2134 mm).
3. Habitable rooms in basements of multiple dwellings may have as many as four beams crossing the ceiling if none of the beams exceeds 12 inches (305 mm) in width or extends below the ceiling more than 6 inches (152 mm).
4. Spaces above and below a mezzanine, other than habitable spaces, shall have a ceiling height of not less than 7 feet (2134 mm).

**1208.2.1 Furred ceiling.** Any room with a furred ceiling shall be required to have the minimum ceiling height in two-thirds of the area thereof, but in no case shall the height of the furred ceiling be less than 7 feet (2134 mm).

**Exception:** Minimum ceiling heights of habitable rooms and spaces shall not be less than established in Section 1208.2.

**1208.3 Room area.** Minimum net floor areas of rooms shall be in accordance with Sections 1208.3.1 and 1208.3.2

**1208.3.1 Habitable rooms and spaces.** Every habitable room or space shall have not less than 80 square feet (7.4 m<sup>2</sup>) in net floor area.

**Exceptions:**

1. A room that complies with the requirements for natural light and natural ventilation and in addition has an unobstructed opening of not less than 60 square feet (5.6 m<sup>2</sup>) into an immediately adjoining room shall have not less than 70 square feet (6.5 m<sup>2</sup>) of net floor area.
2. A habitable dining space, as defined by the *New York City Housing Maintenance Code*, that complies with the requirements for natural light and natural ventilation may have less than 80 square feet (7.4 m<sup>2</sup>) of net floor area.
3. A room in a group R-1 dwelling unit shall have not less than 60 square feet (5.6 m<sup>2</sup>) of net floor area.

**1208.3.2 Dwelling units.** In a dwelling unit, at least one habitable room shall have not less than 150 square feet (13.9 m<sup>2</sup>) of net floor area.

**Exception:** Group R-1 dwelling or sleeping units.

**1208.3.2.1 Single room occupancy of a single room.** Where a single room within a dwelling unit is used for single room occupancy, as such term is used in Section 27-2074(e) of the *New York City Housing Maintenance Code*, such room shall have not less than 150 square feet (13.9 m<sup>2</sup>) of net floor area.

**1208.3.2.2 Single room occupancy of a suite of rooms.** Where two or more rooms, joined together and separated from all other rooms within a dwelling unit, are used for single room occupancy, as such term is used in Section 27-2074(e) of the *New York City Housing Maintenance Code*, at least one of such separated rooms shall have not less than 150 square feet (13.9 m<sup>2</sup>) of net floor area.

**1208.4 Reserved.**

**SECTION BC 1209**  
**ACCESS TO UNOCCUPIED SPACES**

**1209.1 Crawl spaces.** Crawl spaces shall be provided with a minimum of one access opening not less than 18 inches by 24 inches (457 mm by 610 mm). All crawl spaces shall have a minimum clear height of 18 inches (457 mm).

**1209.2 Attic spaces.** An opening not less than 20 inches by 30 inches (508 mm by 762 mm) shall be provided to any attic area having a clear height of over 30 inches (762 mm). A 30-inch (762 mm) minimum clear headroom in the attic space shall be provided at or above the access opening.

**1209.3 Mechanical appliances.** Access to mechanical appliances installed in under-floor areas, in attic spaces and on roofs or elevated structures shall be in accordance with the *New York City Mechanical Code*.

**SECTION BC 1210**  
**SURROUNDING MATERIALS**

**1210.1 Floors.** Toilet and bathing room floors shall have a smooth, hard, nonabsorbent surface that extends upward onto the walls at least 6 inches (152 mm).

**1210.2 Walls.** Walls within 2 feet (610 mm) of urinals and water closets shall have a smooth, hard, nonabsorbent surface, to a height of 4 feet (1219 mm) above the floor, and except for structural elements, the materials used in such walls shall be of a type that is not adversely affected by moisture.

**Exceptions:**

1. Dwelling units.
2. Toilet rooms that are not accessible to the public and which have not more than one water closet.

Accessories such as grab bars, towel bars, paper dispensers and soap dishes, provided on or within walls, shall be installed and sealed to protect structural elements from moisture.

**1210.3 Showers.** Shower compartments and walls above bathtubs with installed shower heads shall be finished with a smooth, nonabsorbent surface to a height not less than 70 inches (1778 mm) above the drain inlet.

**1210.4 Waterproof joints.** Built-in tubs with showers shall have waterproof joints between the tub and adjacent wall.

**1210.5 Toilet rooms.** Toilet rooms shall not open directly into a room used for the preparation of food for service to the public. In multiple dwellings no toilet room or bathroom shall open onto any kitchen or kitchenette.

**SECTION BC 1211**  
**KITCHENS AND KITCHENETTES**

**1211.1 Sleeping.** No kitchen or kitchenette shall be occupied for sleeping purposes.

**1211.2 Kitchenettes in multiple dwellings.** Except at entrances thereto, every kitchenette in a multiple dwelling shall be surrounded by partitions extending from floor to ceiling, and/or by a soffit dropped 1 foot (305 mm) from the ceiling.

**SECTION BC 1212**  
**RODENT PROOFING**

**Section 1212.1 General.** Rodent proofing shall be in accordance with Appendix F.

**SECTION BC 1213**  
**REFUSE AND RECYCLABLE STORAGE**

**1213.1 General.** Multiple dwellings shall comply with Section 81 of the New York State Multiple Dwelling Law and Section 27-2021 of the *New York City Housing Maintenance Code*. Where a room is provided for the storage of refuse and recyclables in a building, such room shall be completely enclosed by construction that has a fire-resistance rating of not less than 2 hours, with self-closing opening protectives having a fire protection rating of not less than 1 ½ hour. The location of such refuse storage room shall be identified on the construction documents.

**1213.2 Compactor.** A refuse compacting system shall be provided in multiple dwellings in Groups I-1 or R-2 occupancy that are four or more stories in height and contain 12 or more dwelling units, and in buildings of any size occupied as a Group R-1 multiple dwelling. Such system shall be located within a refuse storage room constructed in accordance with Section 1213.1 or in a in refuse chute termination room constructed in accordance with Section 707.13.4.

**1213.3 Refuse chute.** A multiple dwelling that is five or more stories in height and that contains more than 12 dwelling units shall be provided with a refuse chute, refuse chute access rooms, and refuse chute termination room constructed in accordance with Section 707.13.

**TABLE 1204.1**  
**MINIMUM SPACE TEMPERATURE REQUIREMENTS<sup>a</sup>**

<u>Rooms or Spaces</u>	<u>Minimum Temperature (degree F)</u>
<u>Habitable rooms in all buildings</u>	<u>68</u>
<u>Building equipment and machinery rooms</u>	<u>50</u>
<u>Patients' rooms, bathrooms and toilet rooms, stairs and corridors in hospitals and nursing homes</u>	<u>As per the <i>New York State Health Code</i></u>
<u>Bathrooms and toilet rooms except patients bathrooms and toilet rooms in hospitals and nursing homes</u>	<u>68</u>
<u>Offices, waiting rooms, art galleries, museums, libraries, meeting rooms, churches, classrooms, auditoriums, lecture halls, night clubs, restaurants, theatres, locker rooms, dressing rooms, and spaces where persons are engaged in sedentary activities</u>	<u>68</u>
<u>Laboratories, light machine work, product inspections, loft buildings, shops, stores, display rooms, show rooms, sales rooms, and spaces where persons are engaged in moderate physical activities</u>	<u>65</u>
<u>Gymnasia, dance halls, skating rinks, bowling alleys, heavy assembly workrooms or shops, and spaces where persons are engaged in vigorous physical activities</u> .....	<u>60</u>
<u>Automotive repair shops</u>	<u>50</u>
<u>Storage areas, garages, space where work or process requires a low temperature</u>	<u>None</u>
<u>Hospital operating rooms, and recovery, labor, delivery, and nursery rooms</u>	<u>As per the <i>New York State Health Code</i></u>
<u>Swimming pools, bath houses, and shower rooms</u>	<u>75</u>

a. Temperatures listed here are the minimum requirements of the department. However, other jurisdictional authorities may have more stringent requirements.

**Exceptions:**

1. Heating systems are not required when occupancy is seasonal and the rooms or buildings are not occupied between November 1<sup>st</sup> and May 1<sup>st</sup> of the following year.

2. Heating systems are not required when the processes or activities normally conducted in the space will generate sufficient heat to maintain the prescribed temperatures during the time of occupancy.
3. Spaces where strict process requirements mandate temperatures other than those cited above shall be exempt from the minimum requirements listed in Table 1204.1.

**TABLE 1207.2.1**  
**MAXIMUM SOUND POWER LEVEL OUTPUTS FOR MACHINE ROOMS**  
**ADJACENT TO DWELLING UNITS**

<b><u>Octave Bands, c.p.s.</u></b> <b><u>Mid-Frequency</u></b>	<b><u>Max. Sound Power Level db<sup>a</sup></u></b>	
	<b><u>db re</u></b> <b><u>10<sup>-13</sup> Watts</u></b>	<b><u>db re</u></b> <b><u>10<sup>-12</sup> Watts</u></b>
<u>63</u>	<u>98</u>	<u>88</u>
<u>125</u>	<u>97</u>	<u>87</u>
<u>250</u>	<u>100</u>	<u>90</u>
<u>1000</u>	<u>97</u>	<u>87</u>
<u>2000</u>	<u>96</u>	<u>86</u>
<u>4000</u>	<u>93</u>	<u>83</u>
<u>8000</u>	<u>91</u>	<u>81</u>

- a. The maximum sound power levels shall be reduced five db in any octave band where the equipment data indicate pure tone generation. The presence of pure tones may be determined by means of one-third octave band analysis. The criterion for a significant pure tone component shall be an audible pure-tone sound together with an increase of the sound pressure level in the corresponding one-third octave band above the mean of the two adjacent one-third of at least:

<b><u>Center frequency of one-third octave band:</u></b>	<u>40/125</u>	<u>160/250</u>	<u>215/500</u>	<u>630/1,000</u>	<u>1,000/10,000</u>
<b><u>Increase in sound pressure level (db):</u></b>	<u>6</u>	<u>4</u>	<u>3</u>	<u>2</u>	<u>1½</u>

**CHAPTER 13**  
**ENERGY EFFICIENCY**

**SECTION BC 1301**  
**GENERAL**

**1301.1 Scope.** This chapter governs the design and construction of buildings for energy efficiency.

**1301.1.1 Criteria.** Buildings shall be designed and constructed in accordance with the *Energy Conservation Construction Code of New York State*.



**CHAPTER 14**  
**EXTERIOR WALLS**

**SECTION BC 1401**  
**GENERAL**

**1401.1 Scope.** The provisions of this chapter shall establish the minimum requirements for exterior walls, exterior wall coverings, exterior wall openings, exterior windows and doors, architectural trim, exterior balconies, bay windows, and other exterior appendages subject to this chapter.

**SECTION BC 1402**  
**DEFINITIONS**

**1402.1 General.** The following words and terms shall, for the purposes of this chapter and as used elsewhere in this code, have the meanings shown herein.

**ADHERED MASONRY VENEER.** Veneer secured and supported through the adhesion of an approved bonding material applied to an approved backing.

**ANCHORED MASONRY VENEER.** Veneer secured with approved mechanical fasteners to an approved backing.

**BACKING.** The wall or surface to which the veneer is secured.

**CURTAIN WALL.** A curtain wall or panel wall system is a non-load bearing building wall, in skeleton frame construction attached and supported to the structure at every floor or other periodic locations. Assemblies may include glass, metal, precast concrete or masonry elements arranged so as not to exert common action underload and to move independently of each other and the supporting structure.

**EXTERIOR INSULATION FINISH SYSTEM (EIFS).** Non-load bearing, barrier wall, exterior cladding systems, generally consisting of the following components:

1. Insulation board.
2. Adhesive and/or mechanical fasteners that attach the insulation board to the substrate.
3. Fiberglass reinforcing mesh.
4. Base coat on the face of the insulation board.
5. A textured protective finish coat.
6. Joint and seam treatments.

**EXTERIOR WALL.** A wall, bearing or nonbearing, that is used as an enclosing wall for a building, other than a fire wall, and that has a slope of 60 degrees (1.05 rad) or greater with the horizontal plane.

**EXTERIOR WALL COVERING.** A material or assembly of materials applied on the exterior side of exterior walls for the purpose of providing a weather-resisting barrier, insulation or for aesthetics, including but not limited to, veneers, siding exterior insulation and finish systems, architectural trim and embellishments such as cornices, soffits, fascias, gutters and leaders.

**EXTERIOR WALL ENVELOPE.** A system or assembly of exterior wall components, including exterior wall finish materials, that provides protection of the building structural members, including framing and sheathing materials, and conditioned interior space, from the detrimental effects of the exterior environment.

**FIBER CEMENT SIDING.** A manufactured, fiber-reinforcing product made with an inorganic hydraulic or calcium silicate binder formed by chemical reaction and reinforced with organic or inorganic nonasbestos fibers, or both. Additives that enhance manufacturing or product performance are permitted. Fiber cement siding products have either smooth or textured faces and are intended for exterior wall and related applications.

**METAL COMPOSITE MATERIAL (MCM).** A factory-manufactured panel consisting of metal skins bonded to both faces of a plastic core.

**METAL COMPOSITE MATERIAL (MCM) SYSTEM.** An exterior wall finish system fabricated using MCM in a specific assembly including joints, seams, attachments, substrate, framing and other details as appropriate to a particular design.

**VENEER.** A facing attached to a wall for the purpose of providing ornamentation, protection or insulation, but not counted as adding strength to the wall. Veneers are nonstructural in that they do not carry any load other than their own weight.

## **SECTION BC 1403** **PERFORMANCE REQUIREMENTS**

**1403.1 General.** The provisions of this section shall apply to exterior walls, exterior wall coverings and components thereof.

**1403.2 Weather protection.** Exterior walls shall provide the building with a weather-resistant exterior wall envelope. The exterior wall envelope shall include flashing, as described in Section 1405.3. The exterior wall envelope and its drainage system shall be designed and constructed in such a manner as to prevent the accumulation of water within the wall assembly by providing a water-resistive barrier behind the exterior veneer, as described in Section 1404.2 and a means for draining water that enters the assembly to the exterior of the veneer, unless it is determined that penetration of water behind the veneer shall not be detrimental to the building performance. Protection against condensation in the exterior wall assembly shall be provided in accordance with the *New York State Energy Conservation Construction Code*.

**Exceptions:**

1. A weather-resistant exterior wall envelope shall not be required over concrete and masonry walls, designed to resist water penetration and detrimental effects from freeze/thaw cycling and in accordance with Chapters 19 and 21, as applicable.
2. Compliance with the requirements for a means of drainage, and the requirements of Sections 1405.2 and 1405.3, shall not be required for an exterior wall envelope that has been demonstrated through testing to resist wind-driven rain, including joints, penetrations and intersections with dissimilar materials, in accordance with ASTM E 331 under the following conditions:
  - 2.1. Exterior wall envelope test assemblies shall include at least one opening, one control joint, and where required one wall/eave interface and one wall sill. All tested openings and penetrations shall be representative of the intended end-use configuration.
  - 2.2. Exterior wall envelope test assemblies shall be at least 4 feet by 8 feet (1219 mm by 2438 mm) in size.
  - 2.3. Exterior wall envelope assemblies shall be tested at a minimum differential pressure of 6.24 pounds per square foot (psf) (0.297 kN/m<sup>2</sup>).
  - 2.4. Exterior wall envelope assemblies shall be subjected to a minimum test exposure duration of 2 hours. The exterior wall envelope design shall be considered to resist wind-driven rain where the results of testing indicate that water did not penetrate control joints in the exterior wall envelope, joints at the perimeter of openings, or intersections of terminations with dissimilar materials.

**1403.3 Vapor retarder.** An approved vapor retarder shall be provided.

**Exceptions:**

1. Where other approved means to avoid condensation and leakage of moisture are provided.
2. Plain and reinforced concrete or masonry exterior walls designed and constructed in accordance with Chapter 19 or 21, as applicable.

**1403.4 Structural.** Exterior walls, and the associated openings, shall be designed and constructed to resist safely the superimposed loads required by Chapter 16.

**1403.5 Fire resistance.** Exterior walls shall be fire-resistance rated as required by other sections of this code with opening protection as required by Chapter 7.

**1403.6 Flood resistance.** For buildings in areas of special flood hazard, exterior walls extending below the design flood elevation shall be resistant to water damage and shall comply with Appendix G.

**1403.7 Reserved.**

## **SECTION BC 1404** **MATERIALS**

**1404.1 General.** Materials used for the construction of exterior walls shall comply with the provisions of this section. Materials not prescribed herein shall be permitted, provided that any such alternative has been approved.

**1404.2 Water-resistive barrier.** Where required by Section 1403.2, an approved continuous water-resistive barrier shall be provided behind the exterior wall covering, or a secondary drainage system shall be provided to divert water out of the wall system to the building exterior. Where asphaltic felt is used, it shall be a minimum of one layer of No. 15 asphalt felt, complying with ASTM D 226 for Type 1 felt, and shall be attached to the sheathing, with flashing as described in Section 1405.3, in such a manner as to provide a continuous water-resistive barrier behind the exterior wall veneer.

**1404.3 Wood.** Exterior walls of wood construction shall be designed and constructed in accordance with Chapter 23.

**1404.3.1 Basic hardboard.** Basic hardboard shall conform to the requirements of AHA A135.4.

**1404.3.2 Hardboard siding.** Hardboard siding shall conform to the requirements of AHA A135.6 and, where used structurally, shall be so identified by the label of an approved agency.

**1404.4 Masonry.** Exterior walls of masonry construction shall be designed and constructed in accordance with this chapter and Chapter 21. Masonry units, mortar and metal accessories used in anchored and adhered veneer shall meet the physical requirements of Chapter 21. The backing of anchored and adhered veneer shall be of concrete, masonry, steel framing or wood framing.

**1404.5 Metal.** Exterior walls of formed steel construction, structural steel or lightweight metal alloys shall be designed in accordance with Chapters 22 and 20, as applicable.

**1404.5.1 Aluminum siding.** Aluminum siding shall conform to the requirements of AAMA 1402.

**1404.6 Concrete.** Exterior walls of concrete construction shall be designed and constructed in accordance with Chapter 19.

**1404.7 Glass-unit masonry.** Exterior walls of glass-unit masonry shall be designed and constructed in accordance with Chapter 21.

**1404.8 Plastics.** Plastic panel, apron or spandrel walls as defined in this code shall not be limited in thickness, provided that such plastics and their assemblies conform to the requirements of Chapter 26 and are constructed of approved weather-resistant materials of adequate strength to resist the wind loads for cladding specified in Chapter 16.

**1404.9 Vinyl siding.** Vinyl siding shall conform to the requirements of ASTM D 3679.

**1404.10 Fiber cement siding.** Fiber cement siding shall conform to the requirements of ASTM C 1186 and shall be so identified on labeling listing an approved quality control agency.

**1404.11 Exterior Insulation Finish System (EIFS).** EIFS shall be designed and constructed in accordance with Chapter 25, Section 1405.8 and Section 2603. EIFS shall conform to the requirements of ANSI/EIMA 99A and shall be so labeled. Such label shall indicate the approved quality control agency.

## **SECTION BC 1405** **INSTALLATION OF WALL COVERINGS**

**1405.1 General.** Exterior wall coverings shall be designed and constructed in accordance with the applicable provisions of this section. Installations of exterior wall coverings shall comply with the special inspection requirements of Chapter 17.

**1405.2 Weather protection.** Exterior walls shall provide weather protection for the building. The materials of the minimum nominal thickness specified in Table 1405.2 shall be acceptable as approved weather coverings.

### **TABLE 1405.2** **MINIMUM THICKNESS OF WEATHER COVERINGS** **(Table 1405.2 attached to end of document)**

**1405.3 Flashing.** Flashing shall be installed in such a manner so as to prevent moisture from entering the wall or to redirect it to the exterior. Flashing shall be installed at the perimeters of exterior door and window assemblies, penetrations and terminations of exterior wall assemblies, exterior wall intersections with roofs, chimneys, porches, decks, balconies and similar projections and at built-in gutters and similar locations where moisture could enter the wall. Flashing with projecting flanges shall be installed on both sides and the ends of copings, under sills and continuously above projecting trim.

**1405.3.1 Exterior wall pockets.** In exterior walls of buildings or structures, wall pockets or crevices in which moisture can accumulate shall be avoided or protected with caps or drips, or other approved means shall be provided to prevent water damage.

**1405.3.2 Masonry.** Flashing and weepholes shall be located in the first course of masonry above finished ground level above the foundation wall or slab, and other points of support, including structural floors, shelf angles and lintels where anchored veneers are designed in accordance with Section 1405.5.

**1405.4 Wood veneers.** Wood veneers on exterior walls of buildings of Type I, II, III and IV construction shall be not less than 1-inch (25 mm) nominal thickness, 0.438-inch (11.1 mm) exterior hardboard siding or 0.375-inch (9.5 mm) exterior-type wood structural panels or particleboard and shall conform to the following:

1. The veneer does not exceed three stories in height, measured from grade, except where fire-retardant-treated wood is used, the height shall not exceed four stories.
2. The veneer is attached to or furred from a noncombustible backing that is fire-resistance rated as required by other provisions of this code.
3. Where open or spaced wood veneers (without concealed spaces) are used, they shall not project more than 24 inches (610 mm) from the building wall.

**1405.5 Anchored masonry veneer.** Anchored masonry veneer shall comply with the provisions of Sections 1405.5, 1405.6, 1405.7 and 1405.8 and Sections 6.1 and 6.2 of ACI 530/ASCE 5/TMS 402.

**1405.5.1 Tolerances.** Anchored masonry veneers in accordance with Chapter 14 are not required to meet the tolerances in Article 3.3 G1 of ACI 530.1/ASCE 6/TMS 602.

**1405.5.2 Seismic requirements.** Anchored masonry veneer located in Seismic Design Category C, D, E or F shall conform to the requirements of Section 6.2.2.10 of ACI 530/ASCE 5/TMS 402.

**1405.6 Stone veneer.** Stone veneer units not exceeding 10 inches (254 mm) in thickness shall be anchored directly to masonry, concrete or to stud construction by one of the following methods:

1. With concrete or masonry backing, anchor ties shall be not less than 0.1055-inch (2.55 mm) corrosion-resistant wire, or approved equal, formed beyond the base of the backing. The legs of the loops shall be not less than 6 inches (152 mm) in length bent at right angles and laid in the mortar joint, and spaced so that the eyes or loops are 12 inches (305 mm) maximum on center (o.c.) in both directions. There shall be provided not less than a 0.1055-inch (2.55 mm) corrosion-resistant wire tie, or approved equal, threaded through the exposed loops for every 2 square feet (0.2 m<sup>2</sup>) of stone veneer. This tie shall be a loop having legs not less than 15 inches (381 mm) in length bent so that it will lie in the stone veneer mortar joint. The last 2 inches (51 mm) of each wire leg shall have a right-angle bend. One-inch (25 mm) minimum thickness of cement grout shall be placed between the backing and the stone veneer.
2. With stud backing, a 2-inch by 2-inch (51 by 51 mm) 0.0625-inch (1.59 mm) corrosion-resistant wire mesh with two layers of waterproofed paper backing in accordance with Section 1403.3 shall be applied directly to wood studs spaced a maximum of 16 inches (406 mm) o.c. On studs, the mesh shall be attached with 2-inch-long (51 mm) corrosion-resistant steel wire furring nails at 4 inches (102 mm) o.c. providing a minimum 1.125-

inch (29 mm) penetration into each stud and with 8d common nails at 8 inches (203 mm) o.c. into top and bottom plates or with equivalent wire ties. There shall be not less than a 0.1055-inch (2.68 mm) corrosion-resistant wire, or approved equal, looped through the mesh for every 2 square feet (0.2 m<sup>2</sup>) of stone veneer. This tie shall be a loop having legs not less than 15 inches (381 mm) in length, so bent that it will lie in the stone veneer mortar joint. The last 2 inches (51 mm) of each wire leg shall have a right-angle bend. One-inch (25 mm) minimum thickness of cement grout shall be placed between the backing and the stone veneer.

**1405.7 Slab-type veneer.** Slab-type veneer units not exceeding 2 inches (51 mm) in thickness shall be anchored directly to masonry, concrete or stud construction. For veneer units of marble, travertine, granite or other stone units of slab form ties of corrosion-resistant dowels in drilled holes located in the middle third of the edge of the units spaced a maximum of 24 inches (610 mm) apart around the periphery of each unit with not less than four ties per veneer unit. Units shall not exceed 20 square feet (1.9 m<sup>2</sup>) in area. If the dowels are not tight fitting, the holes shall be drilled not more than 0.063 inch (1.6 mm) larger in diameter than the dowel, with the hole countersunk to a diameter and depth equal to twice the diameter of the dowel in order to provide a tight-fitting key of cement mortar at the dowel locations when the mortar in the joint has set. Veneer ties shall be corrosion-resistant metal capable of resisting, in tension or compression, a force equal to two times the weight of the attached veneer. If made of sheet metal, veneer ties shall be not smaller in area than 0.0336 by 1 inch (0.853 by 25 mm) or, if made of wire, not smaller in diameter than 0.1483-inch (3.76 mm) wire.

**1405.8 Terra cotta.** Anchored terra cotta or ceramic units not less than 1.625 inches (41 mm) thick shall be anchored directly to masonry, concrete or stud construction. Tied terra cotta or ceramic veneer units shall be not less than 1.625 inches (41 mm) thick with projecting dovetail webs on the back surface spaced approximately 8 inches (203 mm) o.c. The facing shall be tied to the backing wall with corrosion-resistant metal anchors of not less than No. 8 gage wire installed at the top of each piece in horizontal bed joints not less than 12 inches (305 mm) nor more than 18 inches (457 mm) o.c.; these anchors shall be secured to 0.25-inch (6.4 mm) corrosion-resistant pencil rods that pass through the vertical aligned loop anchors in the backing wall. The veneer ties shall have sufficient strength to support the full weight of the veneer in tension. The facing shall be set with not less than a 2-inch (51 mm) space from the backing wall and the space shall be filled solidly with portland cement grout and pea gravel. Immediately prior to setting, the backing wall and the facing shall be drenched with clean water and shall be distinctly damp when the grout is poured.

**1405.9 Adhered masonry veneer.** Adhered masonry veneer shall comply with the applicable requirements in Section 1405.9.1 and Sections 6.1 and 6.3 of ACI 530/ASCE 5/TMS 402.

**1405.9.1 Interior adhered masonry veneers.** Interior adhered masonry veneers shall have a maximum weight of 20 psf (0.958 kg/m<sup>2</sup>) and shall be installed in accordance with Section 1405.9. Where the interior adhered masonry veneer is supported by wood construction, the supporting members shall be designed to limit deflection to  $\frac{1}{600}$  of the span of the supporting members.

**1405.10 Metal veneers.** Veneers of metal shall be fabricated from approved corrosion-resistant materials or shall be protected front and back with porcelain enamel, or otherwise be treated to render the metal resistant to corrosion. Such veneers shall not be less than 0.0149-inch (0.378 mm) nominal thickness sheet steel mounted on wood or metal furring strips or approved sheathing on the wood construction.

**1405.10.1 Attachment.** Exterior metal veneer shall be securely attached to the supporting masonry or framing members with corrosion-resistant fastenings, metal ties or by other approved devices or methods. The spacing of the fastenings or ties shall not exceed 24 inches (610 mm) either vertically or horizontally, but where units exceed 4 square feet (0.4 m<sup>2</sup>) in area there shall be not less than four attachments per unit. The metal attachments shall have a cross-sectional area not less than provided by W 1.7 wire. Such attachments and their supports shall be capable of resisting a horizontal force in accordance with the wind loads specified in Section 1609, but in no case less than 20 psf (0.958 kg/m<sup>2</sup>).

**1405.10.2 Weather protection.** Metal supports for exterior metal veneer shall be protected by painting, galvanizing or by other equivalent coating or treatment. Wood studs, furring strips or other wood supports for exterior metal veneer shall be approved pressure-treated wood or protected as required in Section 1403.2. Joints and edges exposed to the weather shall be caulked with approved durable waterproofing material or by other approved means to prevent penetration of moisture.

**1405.10.3 Backup.** Masonry backup shall not be required for metal veneer except as is necessary to meet the fire-resistance requirements of this code.

**1405.10.4 Grounding.** Grounding of metal veneers on buildings shall comply with the requirements of Chapter 27 and the *New York City Electrical Code*.

**1405.11 Glass veneer.** The area of a single section of thin exterior structural glass veneer shall not exceed 10 square feet (0.93 m<sup>2</sup>) where it is not more than 15 feet (4572 mm) above the level of the sidewalk or grade level directly below, and shall not exceed 6 square feet (0.56 m<sup>2</sup>) where it is more than 15 feet (4572 mm) above that level. In no event shall thin exterior structural glass veneer be installed more than 35 feet (10 668 mm) above the level of the sidewalk or grade level directly below.

**1405.11.1 Length and height.** The length or height of any section of thin exterior structural glass veneer shall not exceed 48 inches (1219 mm).

**1405.11.2 Thickness.** The thickness of thin exterior structural glass veneer shall be not less than 0.344 inch (8.7 mm).

**1405.11.3 Application.** Thin exterior structural glass veneer shall be set only after backing is thoroughly dry and after application of an approved bond coat uniformly over the entire surface of the backing so as to effectively seal the surface. Glass shall be set in place with an approved mastic cement in sufficient quantity so that at least 50 percent of the area of each glass unit is directly bonded to the backing by mastic not less than 0.25 inch (6.4 mm) thick



and not more than 0.625 inch (15.9 mm) thick. The bond coat and mastic shall be evaluated for compatibility and shall bond firmly together.

**1405.11.4 Installation at sidewalk level.** Where glass extends to a sidewalk surface, each section shall rest in an approved metal molding, and be set at least 0.25 inch (6.4 mm) above the highest point of the sidewalk. The space between the molding and the sidewalk shall be thoroughly caulked and made water tight.

**1405.11.4.1 Installation above sidewalk level.** Where thin exterior structural glass veneer is installed above the level of the top of a bulkhead facing, or at a level more than 36 inches (914 mm) above the sidewalk level, the mastic cement binding shall be supplemented with approved nonferrous metal shelf angles located in the horizontal joints in every course. Such shelf angles shall be not less than 0.0478-inch (1.21 mm) thick and not less than 2 inches (51 mm) long and shall be spaced at approved intervals, with not less than two angles for each glass unit. Shelf angles shall be secured to the wall or backing with expansion bolts, toggle bolts or by other approved methods.

**1405.11.5 Joints.** Unless otherwise specifically approved by the commissioner, abutting edges of thin exterior structural glass veneer shall be ground square. Mitered joints shall not be used except where specifically approved for wide angles. Joints shall be uniformly buttered with an approved jointing compound and horizontal joints shall be held to not less than 0.063 inch (1.6 mm) by an approved nonrigid substance or device. Where thin exterior structural glass veneer abuts nonresilient material at sides or top, expansion joints not less than 0.25 inch (6.4 mm) wide shall be provided.

**1405.11.6 Mechanical fastenings.** Thin exterior structural glass veneer installed above the level of the heads of show windows and veneer installed more than 12 feet (3658 mm) above sidewalk level shall, in addition to the mastic cement and shelf angles, be held in place by the use of fastenings at each vertical or horizontal edge, or at the four corners of each glass unit. Fastenings shall be secured to the wall or backing with expansion bolts, toggle bolts or by other methods. Fastenings shall be so designed as to hold the glass veneer in a vertical plane independent of the mastic cement. Shelf angles providing both support and fastenings shall be permitted.

**1405.11.7 Flashing.** Exposed edges of thin exterior structural glass veneer shall be flashed with overlapping corrosion-resistant metal flashing or equivalent and caulked with a waterproof compound in a manner to effectively prevent the entrance of moisture between the glass veneer and the backing.

**1405.12 Exterior windows and doors.** Windows and doors installed in exterior walls shall conform to the testing and performance requirements of Section 1714.5.

**1405.12.1 Installation.** Windows and doors shall be installed in accordance with approved manufacturer's instructions. Fastener size and spacing shall be provided in such instructions and shall be calculated based on maximum loads and spacing used in the tests.

**1405.13 Vinyl siding.** Vinyl siding conforming to the requirements of this section and complying with ASTM D 3679 shall be permitted on exterior walls of buildings of Type V construction located in areas where the basic wind speed specified in Chapter 16 does not exceed 100 miles per hour (161 km/h) and the building height is less than 40 feet (12 192 mm) in Exposure C. Where construction is located in areas where the basic wind speed exceeds 100 miles per hour (161 km/h), or building heights are in excess of 40 feet (12 192 mm), tests or calculations indicating compliance with Chapter 16 shall be submitted. Vinyl siding shall be secured to the building so as to provide weather protection for the exterior walls of the building.

**1405.13.1 Application.** The siding shall be applied over sheathing or materials listed in Section 2304.6. Siding shall be applied to conform with the weather-resistant barrier requirements in Section 1403. Siding and accessories shall be installed in accordance with approved manufacturer's instructions. Unless otherwise specified in the approved manufacturer's instructions, nails used to fasten the siding and accessories shall have a minimum 0.313-inch (7.9 mm) head diameter and 0.125-inch (3.18 mm) shank diameter. The nails shall be corrosion resistant and shall be long enough to penetrate the studs or nailing strip at least 0.75 inch (19 mm). Where the siding is installed horizontally, the fastener spacing shall not exceed 16 inches (406 mm) horizontally and 12 inches (305 mm) vertically. Where the siding is installed vertically, the fastener spacing shall not exceed 12 inches (305 mm) horizontally and 12 inches (305 mm) vertically.

**1405.14 Cement plaster.** Cement plaster applied to exterior walls shall conform to the requirements specified in Chapter 25.

**1405.15 Fiber cement siding.** Fiber cement siding complying with Section 1404.10 shall be permitted on exterior walls of Type I, II, III, IV and V construction for wind pressure resistance or wind speed exposures as indicated in the manufacturer's compliance report and approved installation instructions. Where specified, the siding shall be installed over sheathing or materials listed in Section 2304.6 and shall be installed to conform to the weather-resistant barrier requirements in Section 1403. Siding and accessories shall be installed in accordance with approved manufacturer's instructions. Unless otherwise specified in the approved manufacturer's instructions, nails used to fasten the siding to wood studs shall be corrosion-resistant round head smooth shank and shall be long enough to penetrate the studs at least 1 inch (25 mm). For metal framing, all-weather screws shall be used and shall penetrate the metal framing at least three full threads.

**1405.15.1 Panel siding.** Panels shall be installed with the long dimension parallel to framing. Vertical joints shall occur over framing members and shall be sealed with caulking or covered with battens. Horizontal joints shall be flashed with Z-flashing and blocked with solid wood framing.

**1405.15.2 Horizontal lap siding.** Lap siding shall be lapped a minimum of 1¼ inches (32 mm) and shall have the ends sealed with caulking, covered with an H-section joint cover or located over a strip of flashing. Lap siding courses shall be permitted to be installed with the fastener heads exposed or concealed, according to approved manufacturers' instructions.

**1405.16 Fastening.** Weather boarding and wall coverings shall be securely fastened with aluminum, copper, zinc, zinc-coated or other approved corrosion-resistant fasteners in accordance with the nailing schedule in Table 2304.9.1 or the approved manufacturer's installation instructions. Shingles and other weather covering shall be attached with appropriate standard shingle nails to furring strips securely nailed to studs, or with approved mechanically bonding nails, except where sheathing is of wood not less than 1-inch (25 mm) nominal thickness or of wood structural panels as specified in Table 2308.9.3(3).

**1405.17 Reserved.**

**1405.18 Exterior Insulation Finish System (EIFS).** EIFS cladding conforming to the requirements of this section and tested in accordance with ASTM E 330 shall be permitted on exterior walls of buildings provided that the foam plastic insulation meets the requirements of Chapter 26, the substrate assembly is constructed of approved weather-resistant materials of adequate strength to resist the wind loads for cladding specified in Chapter 16, and the building height is 40 feet (12 192 mm) or less. EIFS may be permitted on the exterior walls of heights in excess of 40 feet (12 192 mm), provided that tests or calculations indicating compliance with Chapter 16 are submitted to the commissioner. EIFS installations on buildings of any height shall comply with the special inspection requirements of Chapter 17.

**1405.18.1 Application.** The EIFS cladding shall be applied over a substrate that is constructed in accordance with the appropriate section of this code depending on its type of construction. EIFS cladding shall be applied in accordance with ANSI/EIMA 99 A.

**1405.18.2 Installation at grade level.** Where EIFS cladding is within 10 feet (3048 mm) of grade the installation must conform to the requirements of ANSI/EIMA 99 A impact resistance LEVEL 4.

**1405.18.3 Installation on Type I, II, III, or IV construction.** EIFS cladding on the exterior walls of buildings of Type I, II, III and IV construction shall comply with the appropriate provisions of Chapter 26 and Sections 1405.18.3.1 through 1405.18.3.8.

**1405.18.3.1 Separation from lot lines.** EIFS shall not be permitted on exterior walls of multistory buildings where the walls are located within 12 feet (3658 mm) of an adjoining property line or an interior lot line.

**1405.18.3.2 Expansion joints.** Expansion joints shall be provided in EIFS in the following locations:

1. Where EIFS adjoin dissimilar construction.
2. Where building expansion joints occur.
3. Where prefabricated panels abut one another.
4. Where the substrate changes.

5. Where significant structural movement occurs, as determined by the design professional.

**1405.18.3.3 EIFS approval.** EIFS systems shall be approved based on test data.

**1405.18.3.4 Fire-rated assembly.** The inclusion of an EIFS over a listed fire-rated assembly shall not be deemed to reduce the tested or listed rating.

**1405.18.3.5 Flame spread.** The EIFS insulation board shall comply with the requirements of Chapter 26 and the assembly of fiberglass reinforcing mesh, base coat on the face of the insulation board and textured protective finish coat shall be tested in accordance with ASTM E 84, and shall have a flame spread rating of 25 or less and a smoke-developed rating of 50 or less. Materials shall be tested in the thickness intended to be used.

**1405.18.3.6 Labeling.** Foam insulation shall be listed by an approved testing laboratory and shall be labeled with all of the following information:

1. Inspection agency name.
2. Specific manufacturer's product for which the insulation is listed.
3. Identification of the insulation manufacturer.
4. Flame spread and smoke-developed classifications.

**1405.18.3.7 Contractor.** The installing contractor shall have a certificate of instruction from the respective EIFS manufacturer's applicator training program.

**1405.18.3.8 Fastening for multistory buildings.** The system materials shall be fastened to each other and the overall assembly shall be attached to the building frame so as to prevent failure due to elevated temperatures that occur in a building fire, wind loads, wetting or other environmental conditions. Installations over two stories shall be secured with either full bed of adhesive or corrosion-resistant mechanical fasteners.

## **SECTION BC 1406**

### **COMBUSTIBLE MATERIALS ON THE EXTERIOR SIDE OF EXTERIOR WALLS**

**1406.1 General.** This section shall apply to exterior wall coverings, exterior balconies and similar appendages, bay and oriel windows, decks, porches, porticos, entranceways, and storm enclosures constructed of combustible materials.

**1406.2 Combustible exterior wall coverings.** Combustible exterior wall coverings, including architectural trim, shall comply with this section.

**Exceptions:**

1. Plastics complying with Chapter 26.
2. EIFS complying with Section 1405.18.

**1406.2.1 Ignition resistance.** Combustible exterior wall coverings shall be tested in accordance with NFPA 268.

**Exceptions:** The following materials are not required to be tested in accordance with NFPA 268. However, such materials shall comply with all other provisions of Section 1406.

1. Wood or wood-based products.
2. Other combustible materials covered with an exterior covering other than vinyl sidings listed in Table 1405.2.
3. Aluminum having a minimum thickness of 0.019 inch (0.48 mm).
4. Exterior wall coverings on exterior walls of Type V construction.

**1406.2.1.1 Fire separation 5 feet or less.** Where installed on exterior walls having a fire separation distance of 5 feet (1524 mm) or less, combustible exterior wall coverings shall not exhibit sustained flaming as defined in NFPA 268.

**1406.2.1.2 Fire separation greater than 5 feet.** For fire separation distances greater than 5 feet (1524 mm), an assembly shall be permitted that has been exposed to a reduced level of incident radiant heat flux in accordance with the NFPA 268 test method without exhibiting sustained flaming. The minimum fire separation distance required for the assembly shall be determined from Table 1406.2.1.2 based on the maximum tolerable level of incident radiant heat flux that does not cause sustained flaming of the assembly.

**TABLE 1406.2.1.2**  
**MINIMUM FIRE SEPARATION FOR COMBUSTIBLE VENEERS**  
**(Table 1406.2.1.2 attached to end of document)**

**1406.2.2 Area limitations.** In buildings of Type I, II, III and IV construction, exterior wall coverings shall be permitted to be constructed of combustible materials in accordance with Section 1406.2.1. Combustible exterior wall coverings shall not exceed 10 percent of an exterior wall surface area on any given story nor exceed 40 feet (12 192 mm) in height above grade plane. Such combustible exterior wall coverings shall not be permitted on exterior walls where the fire separation distance is 5 feet (1524 mm) or less. Exterior wall coverings that exceed 40 feet (12 192 mm) in height above grade plane shall be constructed of approved noncombustible materials and shall be secured to the wall with metal or other approved noncombustible brackets.

**1406.2.3 Location.** Where combustible exterior wall covering is located along the top of exterior walls, such trim shall be completely backed up by the exterior wall and shall not extend over or above the top of exterior walls.

**1406.2.4 Fireblocking.** Where the combustible exterior wall covering is furred from the wall and forms a solid surface, the distance between the back of the covering and the wall shall not exceed 1.625 inches (41 mm) and the space thereby created shall be fireblocked in accordance with Section 717 so that there will be no open space exceeding 100 square feet (9.3 m<sup>2</sup>). Where wood furring strips are used, they shall be of approved wood of natural decay resistance or preservative-treated wood.

**Exceptions:**

1. Fireblocking of cornices is not required in single-family dwellings.
2. Fireblocking shall not be required where installed on noncombustible framing and the face of the exterior wall finish exposed to the concealed space is covered by one of the following materials:
  - 2.1. Aluminum having a minimum thickness of 0.019 inch (0.5 mm);
  - 2.2. Corrosion-resistant steel having a base metal thickness not less than 0.016 inch (0.4 mm) at any point; or
  - 2.3. Other approved noncombustible materials.

**1406.3 Exterior balconies and similar projections.** Exterior balconies and similar projections shall be permitted to be constructed of combustible materials provided that the exterior balcony or similar projection affords the fire-resistance rating required by Table 601 for floor construction.

**Exceptions:**

1. Balconies or similar projections serving as a required exit shall not be constructed of combustible materials.
2. Balconies or similar projections on the exterior of buildings of Type I or II construction shall not be constructed of combustible materials.

**1406.4 Bay and oriel windows, decks, porches, porticos, entranceways, and storm enclosures.** Bay and oriel windows, decks, porches, porticos, entranceways, and storm enclosures shall conform to the type of construction required for the building to which they are attached, including required fire-rating, unless otherwise modified by the requirements of this Section. For the purposes of this Section, such structures shall be referred to as, “appendages”.

Exception: Plastic complying with Chapter 26.

**1406.4.1 Appendages on Type I and II construction.** Appendages on buildings of Type I or II construction shall be constructed of non-combustible materials. However, on buildings not more than three stories or 40 feet (12 192 mm) in height, whichever is less, fire-retardant-treated wood shall be permitted.

**1406.4.2 Appendages on Type III, IV and VA construction.** Appendages on buildings of Type III, IV, and VA construction may be constructed of combustible materials, provided that all the following conditions are met:

1. Such building does not exceed 3 stories or 40 feet (12 192 mm) in height, whichever is less.
2. Such building is classified in Occupancy Groups R-2 or R-3.
3. The appendage has an exterior separation on all exposed sides of at least 15 feet (4572 mm), measured from the outermost surface of the appendage, except that appendages with exposed sides protected by minimum 1-hour fire-rated construction extending at least 36 inches (914 mm) above the highest combustible horizontal surface may be located up to a minimum distance of 36 inches (914 mm) from any property line.
4. The appendage is so constructed that its removal or destruction will not reduce the structural stability or fire resistive integrity of the building.
5. The appendage has a superficial area not exceeding 150 square feet (13.9 m<sup>2</sup>) when viewed from directly above and is included in the area limitations of Table 503 for the entire building.
6. The appendage is not higher than the sills of the second story windows.
7. The vertical surface area of the combustible portions of the appendage does not exceed 10 percent of the total wall area (windows excluded) of the building.
8. For enclosed appendages, the roof of the appendage has a class A roof covering, and the soffit or ceiling covering the combustible roof framing shall have a minimum 1-hour fire-resistance rating.

**Exception:** Appendages constructed of fire-retardant-treated wood, on buildings not exceeding 3 stories or 40 feet (12 192 mm) in height, whichever is less, need not comply with Items 2 through 8.

**1406.4.3 Appendages on Type VB construction.** Appendages may be constructed of combustible materials on buildings of construction Type VB.

**SECTION BC 1407**  
**METAL COMPOSITE MATERIALS (MCM)**

**1407.1 General.** The provisions of this section shall govern the materials, construction and quality of metal composite materials (MCM) for use as exterior wall coverings in addition to other applicable requirements of Chapters 14 and 16.

**1407.2 Exterior wall finish.** MCM used as exterior wall finish or as elements of balconies and similar appendages and bay and oriel windows to provide cladding or weather resistance shall comply with Sections 1407.4 through 1407.13.

**1407.3 Architectural trim and embellishments.** MCM used as architectural trim or embellishments shall comply with Sections 1407.7 through 1407.13.

**1407.4 Structural design.** MCM systems shall be designed and constructed to resist wind loads as required by Chapter 16 for components and cladding.

**1407.5 Approval.** Results of approved tests or an engineering analysis shall be submitted to the commissioner to verify compliance with the requirements of Chapter 16 for wind loads.

**1407.6 Weather resistance.** MCM systems shall comply with Section 1403 and shall be designed and constructed to resist wind and rain in accordance with this section and the manufacturer's installation instructions.

**1407.7 Durability.** MCM systems shall be constructed of approved materials that maintain the performance characteristics required in Section 1407 for the duration of use.

**1407.8 Fire-resistance rating.** Where MCM systems are used on exterior walls required to have a fire-resistance rating in accordance with Section 704, evidence shall be submitted to the commissioner that the required fire-resistance rating is maintained.

**1407.9 Surface-burning characteristics.** Unless otherwise specified, MCM shall have a flame spread index of 75 or less and a smoke-developed index of 450 or less when tested as an assembly in the maximum thickness intended for use in accordance with ASTM E 84.

**1407.10 Type I, II, III and IV construction.** Where installed on buildings of Type I, II, III and IV construction, MCM systems shall comply with Sections 1407.10.1 through 1407.10.4, or 1407.11.

**1407.10.1 Surface-burning characteristics.** MCM shall have a flame spread index of not more than 25 and a smoke-developed index of not more than 450 when tested as an assembly in the maximum thickness intended for use in accordance with ASTM E 84.

**1407.10.2 Thermal barriers.** MCM shall be separated from the interior of a building by an approved thermal barrier consisting of 0.5-inch (12.7 mm) gypsum wallboard or equivalent thermal barrier material that will limit the average temperature rise of the unexposed surface



to not more than 250°F (121°C) after 15 minutes of fire exposure in accordance with the standard time-temperature curve of ASTM E 119. The thermal barrier shall be installed in such a manner that it will remain in place for not less than 15 minutes based on a test conducted in accordance with UL 1715.

**Exceptions:**

1. The thermal barrier is not required where the MCM system is specifically approved based on tests conducted in accordance with UL 1040 or UL 1715. Such testing shall be performed with the MCM in the maximum thickness intended for use. The MCM system shall include seams, joints and other typical details used in the installation and shall be tested in the manner intended for use.
2. The thermal barrier is not required where the MCM is used as elements of balconies and similar appendages, architectural trim or embellishments.

**1407.10.3 Full-scale tests.** The MCM exterior wall assembly shall be tested in accordance with, and comply with, the acceptance criteria of NFPA 285. Such testing shall be performed on the MCM system with the MCM in the maximum thickness intended for use.

**1407.11 Alternate conditions.** MCM and MCM systems shall not be required to comply with Sections 1407.10.1 through 1407.10.4 provided such systems comply with Section 1407.11.1 or 1407.11.2.

**1407.11.1 Installations up to 40 feet in height.** MCM shall not be installed more than 40 feet (12 190 mm) in height above the grade plane where installed in accordance with Sections 1407.11.1.1 and 1407.11.1.2.

**1407.11.1.1 Fire separation distance of 5 feet or less.** Where the fire separation distance is 5 feet (1524 mm) or less, the area of MCM shall not exceed 10 percent of the exterior wall surface.

**1407.11.1.2 Fire separation distance greater than 5 feet.** Where the fire separation distance is greater than 5 feet (1524 mm), there shall be no limit on the area of exterior wall surface coverage using MCM.

**1407.11.2 Installations up to 50 feet in height.** MCM shall not be installed more than 50 feet (15 240 mm) in height above the grade plane where installed in accordance with Sections 1407.11.2.1 and 1407.11.2.2.

**1407.11.2.1 Self ignition temperature.** MCM shall have a self-ignition temperature of 650°F (343°C) or greater when tested in accordance with ASTM D 1929.

**1407.11.2.2 Limitations.** Sections of MCM shall not exceed 300 square feet (27.9 m<sup>2</sup>) in area and shall be separated by a minimum of 4 feet (1219 mm) vertically.

**1407.12 Type V construction.** MCM shall be permitted to be installed on buildings of Type V construction.

**1407.13 Labeling.** MCM shall be labeled in accordance with Chapter 17.

**TABLE 1405.2**  
**MINIMUM THICKNESS OF WEATHER COVERINGS**

<u>COVERING TYPE</u>	<u>MINIMUM THICKNESS</u> <u>(inches)</u>
<u>Adhered masonry veneer*</u>	<u>0.25</u>
<u>Anchored masonry veneer</u>	<u>2.625</u>
<u>Aluminum siding</u>	<u>0.019</u>
<u>Cold-rolled copper<sup>d</sup></u>	<u>0.0216 nominal</u>
<u>Copper shingles<sup>d</sup></u>	<u>0.0162 nominal</u>
<u>Exterior plywood (with sheathing)</u>	<u>0.313</u>
<u>Exterior plywood (without sheathing)</u>	<u>See Section 2304.6</u>
<u>Fiberboard siding</u>	<u>0.5</u>
<u>Fiber cement lap siding</u>	<u>0.25<sup>e</sup></u>
<u>Fiber cement panel siding</u>	<u>0.25<sup>e</sup></u>
<u>Glass-fiber reinforced concrete panels</u>	<u>0.375</u>
<u>Hardboard siding<sup>c</sup></u>	<u>0.25</u>
<u>High-yield copper<sup>d</sup></u>	<u>0.0162 nominal</u>
<u>Lead-coated copper<sup>d</sup></u>	<u>0.0216 nominal</u>
<u>Lead-coated high-yield copper</u>	<u>0.0162 nominal</u>
<u>Marble slabs</u>	<u>1</u>
<u>Particleboard (with sheathing)</u>	<u>See Section 2304.6</u>
<u>Particleboard (without sheathing)</u>	<u>See Section 2304.6</u>
<u>Precast stone facing</u>	<u>0.625</u>
<u>Steel (approved corrosion resistant)</u>	<u>0.0149</u>
<u>Stone (cast artificial)</u>	<u>1.5</u>
<u>Stone (natural)</u>	<u>2</u>
<u>Structural glass</u>	<u>0.344</u>
<u>Stucco or exterior portland cement plaster</u>	
<u>Three-coat work over:</u>	
<u>  Metal plaster base</u>	<u>0.875<sup>b</sup></u>
<u>  Unit masonry</u>	<u>0.625<sup>b</sup></u>
<u>  Cast-in-place or precast concrete</u>	<u>0.625<sup>b</sup></u>
<u>Two-coat work over:</u>	
<u>  Unit masonry</u>	<u>0.5<sup>b</sup></u>
<u>  Cast-in-place or precast concrete</u>	<u>0.375<sup>b</sup></u>
<u>Terra cotta (anchored)</u>	<u>1</u>
<u>Terra cotta (adhered)</u>	<u>0.25</u>
<u>Vinyl siding</u>	<u>0.035</u>
<u>Wood shingles</u>	<u>0.375</u>
<u>Wood siding (without sheathing)<sup>a</sup></u>	<u>0.5</u>

For SI: 1 inch = 25.4 mm.

a. Wood siding of thicknesses less than 0.5 inch shall be placed over sheathing that conforms to Section 2304.6.

b. Exclusive of texture.

c. As measured at the bottom of decorative grooves.

d. 16 ounces per square foot for cold-rolled copper and lead-coated copper, 12 ounces per square foot for copper shingles, high-yield copper and lead-coated high-yield copper.

\*Veneer units in this group shall be approved type and not be greater than 2 inches in thickness.

**TABLE 1406.2.1.2  
MINIMUM FIRE SEPARATION FOR COMBUSTIBLE VENEERS**

FIRE SEPARATION DISTANCE (feet)	TOLERABLE LEVEL INCIDENT RADIANT HEAT ENERGY(kW/m <sup>2</sup> )	FIRE SEPARATION DISTANCE (feet)	TOLERABLE LEVEL INCIDENT RADIANT HEAT ENERGY(kW/m <sup>2</sup> )
5	12.5	16	5.9
6	11.8	17	5.5
7	11.0	18	5.2
8	10.3	19	4.9
9	9.6	20	4.6
10	8.9	21	4.4
11	8.3	22	4.1
12	7.7	23	3.9
13	7.2	24	3.7
14	6.7	25	3.5
15	6.3		

For SI: 1 foot = 304.8 mm, 1 Btu/H<sup>2</sup> × °F = .0057 kW/m<sup>2</sup> × K.

**CHAPTER 15**  
**ROOF ASSEMBLIES AND ROOFTOP STRUCTURES**

**SECTION BC 1501**  
**GENERAL**

**1501.1 Scope.** The provisions of this chapter shall govern the design, materials, construction and quality of roof assemblies, and rooftop structures.

**SECTION BC 1502**  
**DEFINITIONS**

**1502.1 General.** The following terms shall, for the purposes of this chapter and as used elsewhere in this code, have the meanings shown herein.

**BULKHEAD.** An enclosed rooftop structure enclosing a shaft, stairway, tank or service equipment, or other space not designed or used for human occupancy.

**BUILT-UP ROOF COVERING.** Two or more layers of felt cemented together and surfaced with a cap sheet, mineral aggregate, smooth coating or similar surfacing material.

**GREEN ROOF.** A roofing assembly consisting of a roof covering and additional landscape material components, including growing media, filter fabric, drainage, and roof surface.

**INTERLAYMENT.** A layer of felt or nonbituminous saturated felt not less than 18 inches (457 mm) wide, shingled between each course of a wood-shake roof covering.

**MECHANICAL EQUIPMENT SCREEN.** A partially enclosed rooftop structure used to aesthetically conceal heating, ventilating and air conditioning (HVAC) electrical or mechanical equipment from view.

**METAL ROOF PANEL.** An interlocking metal sheet having a minimum installed weather exposure of 3 square feet (.279 m<sup>2</sup>) per sheet.

**METAL ROOF SHINGLE.** An interlocking metal sheet having an installed weather exposure less than 3 square feet (.279 m<sup>2</sup>) per sheet.

**MODIFIED BITUMEN ROOF COVERING.** One or more layers of polymer-modified asphalt sheets. The sheet materials shall be fully adhered or mechanically attached to the substrate or held in place with an approved ballast layer.

**PENTHOUSE.** An enclosed rooftop structure which is designed or used for human occupancy.

**POSITIVE ROOF DRAINAGE.** The drainage condition in which consideration has been made for all loading deflections of the roof deck, including ponding instability, and additional slope has been provided to ensure drainage of the roof within 48 hours of precipitation.

**REROOFING.** The process of recovering or replacing an existing roof covering. See “Roof recover” and “Roof replacement.”

**ROOF ASSEMBLY.** A system designed to provide weather protection and resistance to design loads. The system consists of a roof covering and roof deck or a single component serving as both the roof covering and the roof deck. A roof assembly includes the roof deck, vapor retarder, substrate or thermal barrier, insulation, vapor retarder and roof covering.

**ROOF COVERING.** The covering applied to the roof deck for weather resistance, fire classification or appearance.

**ROOF COVERING SYSTEM.** See “Roof assembly.”

**ROOF DECK.** The flat or sloped surface not including its supporting members or vertical supports.

**ROOF RECOVER.** The process of installing an additional roof covering over a prepared existing roof covering without removing the existing roof covering.

**ROOF REPLACEMENT.** The process of removing the existing roof covering, repairing any damaged substrate and installing a new roof covering.

**ROOF VENTILATION.** The natural or mechanical process of supplying conditioned or unconditioned air to, or removing such air from, attics, cathedral ceilings or other enclosed spaces over which a roof assembly is installed.

**ROOFTOP STRUCTURE.** An enclosed or unenclosed structure on or above the roof of any part of a building.

**SINGLE-PLY MEMBRANE.** A roofing membrane that is field applied using one layer of membrane material (either homogeneous or composite) rather than multiple layers.

**UNDERLAYMENT.** One or more layers of felt, sheathing paper, nonbituminous saturated felt or other approved material over which a steep-slope roof covering is applied.

## **SECTION BC 1503** **WEATHER PROTECTION**

**1503.1 General.** Roof decks shall be covered with approved roof coverings secured to

the building or structure in accordance with the provisions of this chapter. Roof coverings shall be designed, installed and maintained in accordance with this code and the approved manufacturer's instructions such that the roof covering shall serve to protect the building or structure.

**1503.2 Flashing.** Flashing shall be installed in such a manner so as to prevent moisture entering the wall and roof through joints in copings, through moisture-permeable materials and at intersections with parapet walls and other penetrations through the roof plane.

**1503.2.1 Locations.** Flashing shall be installed at wall and roof intersections, at gutters, wherever there is a change in roof slope or direction and around roof openings. Where flashing is of metal, the metal shall be corrosion resistant with a thickness of not less than 0.019 inch (.483 mm) (No. 26 galvanized sheet).

**1503.3 Coping.** Parapet walls shall be properly coped with noncombustible, weatherproof materials of a width no less than the thickness of the parapet wall.

**1503.4 Roof drainage.** Design and installation of roof drainage systems shall comply with the *New York City Plumbing Code*.

**1503.4.1 Gutters.** Gutters and leaders placed on the outside of buildings shall be of noncombustible, corrosion-resistant material, or a minimum of Schedule 40 plastic pipe.

**1503.4.1.1 Height limitations.** Vertical sections of exterior leaders made from galvanized steel, galvanized wrought iron, cast iron, brass, or similar heavy material shall be permitted only for the first 15 feet (4572 mm) of leader extending up from grade, provided that the leader is securely anchored with offset clamps to the face of the building at no fewer than 2 points along the vertical section of the leader. Horizontal sections of exterior gutter made from such heavy materials shall not be permitted higher than 15 feet (4572 mm) above grade.

**1503.5 Roof ventilation.** Intake and exhaust vents shall be provided in accordance with Section 1203.2 and the manufacturer's installation instructions.

## **SECTION BC 1504** **PERFORMANCE REQUIREMENTS**

**1504.1 Wind resistance of roofs.** Roof decks and roof coverings shall be designed for wind loads in accordance with Chapter 16 and Sections 1504.2, 1504.3 and 1504.4.

**1504.1.1 Wind resistance of asphalt shingles.** Asphalt shingles shall be designed for wind speeds in accordance with Section 1507.2.7.

**1504.2 Wind resistance of clay and concrete tile.** Clay and concrete tile roof coverings

shall be connected to the roof deck in accordance with Chapter 16.

**1504.3 Wind resistance of nonballasted roofs.** Roof coverings installed on roofs in accordance with Section 1507 that are mechanically attached or adhered to the roof deck shall be designed to resist the design wind load pressures for cladding in Chapter 16.

**1504.3.1 Other roof systems.** Roof systems with built-up, modified bitumen, fully adhered or mechanically attached single-ply through fastened metal panel roof systems, and other types of membrane roof coverings shall also be tested in accordance with FM 4450, FM 4470, UL 580 or UL 1897.

**1504.3.2 Metal panel roof systems.** Metal panel roof systems through fastened or standing seam shall be tested in accordance with UL 580 or ASTM E 1592.

**1504.4 Ballasted low-slope roof systems.** Ballasted low-slope (roof slope < 2:12) single-ply roof system coverings installed in accordance with Section 1507 shall be designed in accordance with ANSI/SPRI RP-4.

**1504.5 Edge securement for low-slope roofs.** Low-slope membrane roof systems metal edge securement, except gutters, installed in accordance with Section 1507, shall be designed in accordance with ANSI/SPRI ES-1, except the basic wind speed shall be determined in accordance with Chapter 16.

**1504.6 Physical properties.** Roof coverings installed on low-slope roofs (roof slope < 2:12) in accordance with Section 1507 shall demonstrate physical integrity over the working life of the roof based upon 2,000 hours of exposure to accelerated weathering tests conducted in accordance with ASTM G 152, ASTM G 155 or ASTM G 154. Those roof coverings that are subject to cyclical flexural response due to wind loads shall not demonstrate any significant loss of tensile strength for unreinforced membranes or breaking strength for reinforced membranes when tested as herein required.

**1504.7 Impact resistance.** Roof coverings installed on low-slope roofs (roof slope < 2:12) in accordance with Section 1507 shall resist impact damage based on the results of tests conducted in accordance with ASTM D 3746, ASTM D 4272, CGSB 37-GP-52M or FM 4470.

**1504.8 Reflectance.** Roof coverings on roofs or setbacks with slope less than three units vertical in 12 units horizontal (25 percent) shall be white in color or EnergyStar rated as highly reflective for at least 75 percent of the area of the roof or setback surface.

**Exceptions:**

1. Terraces on setbacks comprising less than 25 percent of the area of the largest floor plate in the building.



2. Green roofs in compliance with Section 1507.16 shall be permitted to comprise part or all of the 75 percent required area coverage.
3. Roofs used as outdoor recreation space by the occupants of the building shall be permitted to be either landscaped or covered with a walking surface or other protective surface with an albedo of 30 percent or greater.

## **SECTION BC 1505** **FIRE CLASSIFICATION**

**1505.1 General.** Roof assemblies shall be divided into the classes defined below. Class A, B and C roof assemblies and roof coverings required to be listed by this section shall be tested in accordance with ASTM E 108 or UL 790. In addition, fire-retardant-treated wood roof coverings shall be tested in accordance with ASTM D 2898. The minimum roof coverings installed on buildings shall comply with Table 1505.1 based on the type of construction of the building.

### **TABLE 1505.1<sup>a,b</sup>** **MINIMUM ROOF COVERING CLASSIFICATION FOR TYPES OF** **CONSTRUCTION** **(Table 1505.1<sup>a,b</sup> attached to end of document)**

**1505.2 Class A roof assemblies.** Class A roof assemblies are those that are effective against severe fire test exposure. Class A roof assemblies and roof coverings shall be listed and identified as Class A by an approved testing agency. Class A roof assemblies shall be permitted for use in buildings or structures of all types of construction.

**Exception:** Class A roof assemblies include those with coverings of brick, masonry, slate, clay or concrete roof tile, exposed concrete roof deck, ferrous or copper shingles or sheets.

**1505.3 Class B roof assemblies.** Class B roof assemblies are those that are effective against moderate fire-test exposure. Class B roof assemblies and roof coverings shall be listed and identified as Class B by an approved testing agency.

**Exception:** Class B roof assemblies include those with coverings of metal sheets and shingles.

**1505.4 Class C roof assemblies.** Class C roof assemblies are those that are effective against light fire-test exposure. Class C roof assemblies and roof coverings shall be listed and identified as Class C by an approved testing agency.

**1505.5 Construction of sloping roofs.** Roofs having a slope of more than 60 degrees (1.05 rad) to the horizontal shall be constructed of material having the same fire-resistance-rating as required for an exterior non-bearing wall of the building of which it is a part. When the slope is 60 degrees (1.05 rad) or less to the horizontal, the sloping roof

shall be constructed as required for the roof of the building. Where the back of a false mansard is exposed to the outdoors, the back shall be covered with noncombustible material or with roof covering as required for the roof of the building.

**1505.6 Fire-retardant-treated wood shingles and shakes.** Fire-retardant-treated wood shakes and shingles shall be treated by impregnation with chemicals by the full-cell vacuum-pressure process, in accordance with AWWA C1. Each bundle shall be marked to identify the manufactured unit and the manufacturer, and shall also be labeled to identify the classification of the material in accordance with the testing required in Section 1505.1, the treating company and the quality control agency.

**1505.7 Special purpose roofs.** Special purpose wood shingle or wood shake roofing shall conform with the grading and application requirements of Section 1507.8 or Section 1507.9. In addition, an underlayment of 0.625 inch (15.9 mm) Type X water-resistant gypsum backing board or gypsum sheathing shall be placed under minimum nominal 0.5-inch-thick (12.7 mm) wood structural panel solid sheathing or 1-inch (25 mm) nominal spaced sheathing.

## **SECTION BC 1506** **MATERIALS**

**1506.1 Scope.** The requirements set forth in this section shall apply to the application of roof-covering materials specified herein. Roof coverings shall be applied in accordance with this chapter and the manufacturer's installation instructions. Installation of roof coverings shall comply with the applicable provisions of Section 1507.

**1506.2 Compatibility of materials.** Roofs and roof coverings shall be of materials that are compatible with each other and with the building or structure to which the materials are applied.

**1506.3 Material specifications and physical characteristics.** Roof-covering materials shall conform to the applicable standards listed in this chapter. In the absence of applicable standards or where materials are of questionable suitability, testing by an approved agency shall be required by the commissioner to determine the character, quality and limitations of application of the materials.

**1506.4 Product identification.** Roof-covering materials shall be delivered in packages bearing the manufacturer's identifying marks and approved testing agency labels required in accordance with Section 1505. Bulk shipments of materials shall be accompanied with the same information issued in the form of a certificate or on a bill of lading by the manufacturer.

## **SECTION BC 1507** **REQUIREMENTS FOR ROOF COVERINGS**

**1507.1 Scope.** Roof coverings shall be applied in accordance with the applicable

provisions of this section and the manufacturer's installation instructions.

**1507.2 Asphalt shingles.** The installation of asphalt shingles shall comply with the provisions of this section and Table 1507.2.

**1507.2.1 Deck requirements.** Asphalt shingles shall be fastened to solidly sheathed decks.

**1507.2.2 Slope.** Asphalt shingles shall only be used on roof slopes of two units vertical in 12 units horizontal (17-percent slope) or greater. For roof slopes from two units vertical in 12 units horizontal (17-percent slope) up to four units vertical in 12 units horizontal (33-percent slope), double underlayment application is required in accordance with Section 1507.2.8.

**1507.2.3 Underlayment.** Unless otherwise noted, required underlayment shall conform to ASTM D 226, Type I, or ASTM D 4869, Type I.

**1507.2.4 Self-adhering polymer modified bitumen sheet.** Self-adhering polymer modified bitumen sheet shall comply with ASTM D 1970.

**1507.2.5 Asphalt shingles.** Asphalt shingles shall have self-seal strips or be interlocking, and comply with ASTM D 225 or ASTM D 3462.

**1507.2.6 Fasteners.** Fasteners for asphalt shingles shall be galvanized, stainless steel, aluminum or copper roofing nails, minimum 12 gage shank with a minimum 0.375 inch-diameter (9.5 mm) head, of a length to penetrate through the roofing materials and a minimum of 0.75 inch (19.1 mm) into the roof sheathing. Where the roof sheathing is less than 0.75 inch (19.1 mm) thick, the nails shall penetrate through the sheathing. Fasteners shall comply with ASTM F 1667.

**1507.2.7 Attachment.** Asphalt shingles shall have the minimum number of fasteners required by the manufacturer and Section 1504.1. Asphalt shingles shall be secured to the roof with not less than four fasteners per strip shingle or two fasteners per individual shingle. Where the roof slope exceeds 20 units vertical in 12 units horizontal (166 percent slope), special methods of fastening are required. For roofs located where the basic wind speed in accordance with Figure 1609 is 110 mph or greater, special methods of fastening are required. Special fastening methods shall be tested in accordance with ASTM D 3161, modified to use a wind speed of 110 mph.

**1507.2.8 Underlayment application.** For roof slopes from two units vertical in 12 units horizontal (17-percent slope), up to four units vertical in 12 units horizontal (33-percent slope), underlayment shall be two layers applied in the following manner. Apply a minimum 19-inch-wide (483 mm) strip of underlayment felt parallel with and starting at the eaves, fastened sufficiently to hold in place. Starting at the eave, apply 36-inch-wide (914 mm) sheets of underlayment overlapping successive sheets 19 inches (483 mm) and fastened sufficiently to hold in place. For roof slopes of four

units vertical in 12 units horizontal (33-percent slope) or greater, underlayment shall be one layer applied in the following manner. Underlayment shall be applied shingle fashion, parallel to and starting from the eave and lapped 2 inches (51 mm), fastened only as necessary to hold in place.

**1507.2.8.1 Ice dam membrane.** Where there is a possibility of ice forming along the eaves causing a backup of water, a membrane that consists of at least two layers of underlayment cemented together or of a self-adhering polymer modified bitumen sheet shall be used in lieu of normal underlayment and extend from the eave's edge to a point at least 24 inches (610 mm) inside the exterior wall line of the building.

**Exception:** Detached accessory structures that contain no conditioned floor area.

**1507.2.9 Flashings.** Flashing for asphalt shingles shall comply with this section. Flashing shall be applied in accordance with this section and the asphalt shingle manufacturer's printed instructions.

**1507.2.9.1 Base and cap flashing.** Base and cap flashing shall be installed in accordance with the manufacturer's instructions. Base flashing shall be of either corrosion-resistant metal of minimum nominal 0.019-inch (0.483 mm) thickness or mineral-surfaced roll roofing weighing a minimum of 77 pounds per 100 square feet (3.76 kg/m<sup>2</sup>). Cap flashing shall be corrosion-resistant metal of minimum nominal 0.019-inch (0.483 mm) thickness.

**1507.2.9.2 Valleys.** Valley linings shall be installed in accordance with the manufacturer's instructions before applying shingles. Valley linings of the following types shall be permitted:

1. For open valleys (valley lining exposed) lined with metal, the valley lining shall be at least 16 inches (406 mm) wide and of any of the corrosion-resistant metals in Table 1507.2.9.2.
2. For open valleys, valley lining of two plies of mineral-surfaced roll roofing shall be permitted. The bottom layer shall be 18 inches (457 mm) and the top layer a minimum of 36 inches (914 mm) wide.
3. For closed valleys (valleys covered with shingles), valley lining of one ply of smooth roll roofing complying with ASTM D 224 and at least 36 inches (914 mm) wide or types as described in Items 1 and 2 above shall be permitted. Specialty underlayment shall comply with ASTM D 1970.

**TABLE 1507.2**  
**ASPHALT SHINGLE APPLICATION**  
**(Table 1507.2 attached to end of document)**

**TABLE 1507.2.9.2**  
**VALLEY LINING MATERIAL**  
**(Table 1507.2.9.2 attached to end of document)**

**1507.2.9.3 Drip edge.** Provide drip edge at eaves and gables of shingle roofs. Overlap to be a minimum of 2 inches (51 mm). Eave drip edges shall extend 0.25 inch (6.4 mm) below sheathing and extend back on the roof a minimum of 2 inches (51 mm). Drip edge shall be mechanically fastened a maximum of 12 inches (305 mm) o.c. A cricket or saddle shall be installed on the ridge side of any chimney greater than 30 inches (762 mm) wide. Cricket or saddle coverings shall be sheet metal or of the same material as the roof covering.

**1507.3 Clay and concrete tile.** The installation of clay and concrete tile shall comply with the provisions of this section.

**1507.3.1 Deck requirements.** Concrete and clay tile shall be installed only over solid sheathing or spaced structural sheathing boards.

**1507.3.2 Deck slope.** Clay and concrete roof tile shall be installed on roof slopes of 2½ units vertical in 12 units horizontal (21-percent slope) or greater. For roof slopes from 2½ units vertical in 12 units horizontal (21-percent slope) to four units vertical in 12 units horizontal (33-percent slope), double underlayment application is required in accordance with Section 1507.3.3.

**1507.3.3 Underlayment.** Unless otherwise noted, required underlayment shall conform to: ASTM D 226, Type II; ASTM D 2626 or ASTM D 249 Type I mineral-surfaced roll roofing.

**1507.3.3.1 Low-slope roofs.** For roof slopes from 2½ units vertical in 12 units horizontal (21-percent slope), up to four units vertical in 12 units horizontal (33-percent slope), underlayment shall be a minimum of two layers applied as follows:

- 1. Starting at the eave, a 19-inch (483 mm) strip of underlayment shall be applied parallel with the eave and fastened sufficiently in place.**
- 2. Starting at the eave, 36-inch-wide (914 mm) strips of underlayment felt shall be applied overlapping successive sheets 19 inches (483 mm) and fastened sufficiently in place.**

**1507.3.3.2 High-slope roofs.** For roof slopes of four units vertical in 12 units horizontal (33-percent slope) or greater, underlayment shall be a minimum of one layer of underlayment felt applied shingle fashion, parallel to, and starting from the eaves and lapped 2 inches (51 mm), fastened only as necessary to hold in place.

**1507.3.4 Clay tile.** Clay roof tile shall comply with ASTM C 1167.

**1507.3.5 Concrete tile.** Concrete roof tiles shall be in accordance with the physical test requirements as follows:

1. The transverse strength of tiles shall be determined according to Section 6.3 of ASTM C 1167 and in accordance with Table 1507.3.5.
2. The absorption of concrete roof tiles shall be according to Section 8 of ASTM C 140. Roof tiles shall absorb not more than 15 percent of the dry weight of the tile during a 24-hour immersion test.
3. Roof tiles shall be tested for freeze/thaw resistance according to Section 8 of ASTM C67. Roof tiles shall show no breakage and not have more than 1 percent loss in dry weight of any individual concrete roof tile.

**TABLE 1507.3.5**  
**TRANSVERSE BREAKING STRENGTH OF CONCRETE ROOF TILE (lbs.)**  
**(Table 1507.3.5 attached to end of document)**

**1507.3.6 Fasteners.** Tile fasteners shall be corrosion resistant and not less than 11 gage,  $\frac{5}{16}$ -inch (8.0 mm) head, and of sufficient length to penetrate the deck a minimum of 0.75 inch (19.1 mm) or through the thickness of the deck, whichever is less. Attaching wire for clay or concrete tile shall not be smaller than 0.083 inch (2.1 mm). Perimeter fastening areas include three tile courses but not less than 36 inches (914 mm) from either side of hips or ridges and edges of eaves and gable rakes.

**1507.3.7 Attachment.** Clay and concrete roof tiles shall be fastened in accordance with Table 1507.3.7.

**TABLE 1507.3.7**  
**CLAY AND CONCRETE TILE ATTACHMENT<sup>a, b, c</sup>**  
**(Table 1507.3.7 attached to end of document)**

**1507.3.8 Application.** Tile shall be applied according to the manufacturer's installation instructions, based on the following:

1. Climatic conditions.
2. Roof slope.
3. Underlayment system.
4. Type of tile being installed.

**1507.3.9 Flashing.** At the juncture of the roof vertical surfaces, flashing and counterflashing shall be provided in accordance with the manufacturer's installation instructions, and where of metal, shall not be less than 0.019-inch (0.48 mm) (No. 26 galvanized sheet gage) corrosion-resistant. The valley flashing shall extend at least 11 inches (279 mm) from the centerline each way and have a splash diverter rib not less than 1 inch (25 mm) high at the flow line formed as part of the flashing. Sections of flashing shall have an end lap of not less than 4 inches (102 mm). For roof slopes of three units vertical in 12 units horizontal (25-percent slope) and over, the valley flashing shall have a 36-inch-wide (914 mm) underlayment of one layer of Type I underlayment running the full length of the valley, in addition to other required underlayment. Where there is a possibility of ice forming along the eaves causing a backup of water, the metal valley flashing underlayment shall be solid cemented to the roofing underlayment for slopes under seven units vertical in 12 units horizontal (58-percent slope) or of self-adhering polymer modified bitumen sheet.

**1507.4 Metal roof panels.** The installation of metal roof panels shall comply with the provisions of this section.

**1507.4.1 Deck requirements.** Metal roof panel roof coverings shall be applied to a solid or closely fitted deck, except where the roof covering is specifically designed to be applied to spaced supports.

**1507.4.2 Deck slope.** The minimum slope for lapped, nonsoldered seam metal roofs without applied lap sealant shall be three units vertical in 12 units horizontal (25-percent slope). The minimum slope for lapped, nonsoldered seam metal roofs with applied lap sealant shall be one-half vertical unit in 12 units horizontal (4-percent slope). The minimum slope for standing seam of roof systems shall be one-quarter unit vertical in 12 units horizontal (2-percent slope).

**1507.4.3 Material standards.** Metal-sheet roof covering systems that incorporate supporting structural members shall be designed in accordance with Chapter 22. Metal-sheet roof coverings installed over structural decking shall comply with Table 1507.4.3.

**1507.4.4 Attachment.** Metal roofing fastened directly to steel framing shall be attached by approved manufacturers' fasteners. In the absence of manufacturer recommendations, all of the following fasteners shall be used:

1. Galvanized fasteners shall be used for galvanized roofs.
2. 300 series stainless-steel fasteners shall be used for copper roofs.
3. Stainless-steel fasteners are acceptable for all types of metal roofs.

**TABLE 1507.4.3**  
**METAL ROOF COVERINGS**  
**(Table 1507.4.3 attached to end of document)**

**1507.5 Metal roof shingles.** The installation of metal roof shingles shall comply with the provisions of this section.

**1507.5.1 Deck requirements.** Metal roof shingles shall be applied to a solid or closely fitted deck, except where the roof covering is specifically designed to be applied to spaced sheathing.

**1507.5.2 Deck slope.** Metal roof shingles shall not be installed on roof slopes below three units vertical in 12 units horizontal (25-percent slope).

**1507.5.3 Underlayment.** Underlayment shall conform to ASTM D 226, Type I. Where there is a possibility of ice forming along the eaves causing a backup of water, an ice barrier that consists of at least two layers of underlayment cemented together or of a self-adhering polymer-modified bitumen sheet, shall be used in lieu of normal underlayment and extend from the eave's edge to a point at least 24 inches (610 mm) inside the exterior wall line of the building.

**Exception:** Detached accessory structures that contain no conditioned floor area.

**1507.5.4 Material standards.** Metal roof shingle roof coverings shall comply with Table 1507.4.3.

**1507.5.5 Attachment.** Metal roof shingles shall be secured to the roof in accordance with the approved manufacturer's installation instructions.

**1507.5.6 Flashing.** Roof valley flashing shall be of corrosion-resistant metal of the same material as the roof covering or shall comply with the standards in Table 1507.4.3. The valley flashing shall extend at least 8 inches (203 mm) from the centerline each way and shall have a splash diverter rib not less than 0.75 inch (19.1 mm) high at the flow line formed as part of the flashing. Sections of flashing shall have an end lap of not less than 4 inches (102 mm). Where there is a possibility of ice forming along the eaves causing a backup of water, the metal valley flashing shall have a 36-inch-wide (914 mm) underlayment directly under it consisting of one layer of underlayment running the full length of the valley, in addition to underlayment required for metal roof shingles. The metal valley flashing underlayment shall be solid cemented to the roofing underlayment for roof slopes under seven units vertical in 12 units horizontal (58-percent slope) or of self-adhering polymer-modified bitumen sheet.

**1507.6 Mineral-surfaced roll roofing.** The installation of mineral-surfaced roll roofing shall comply with this section.



**1507.6.1 Deck requirements.** Mineral-surfaced roll roofing shall be fastened to solidly sheathed roofs.

**1507.6.2 Deck slope.** Mineral-surfaced roll roofing shall not be applied on roof slopes below one unit vertical in 12 units horizontal (8-percent slope).

**1507.6.3 Underlayment.** Underlayment shall conform to ASTM D 226, Type I. Where there is a possibility of ice forming along the eaves causing a backup of water, an ice barrier that consists of at least two layers of underlayment cemented together or of a self-adhering polymer-modified bitumen sheet, shall extend from the eave's edge to a point at least 24 inches (610 mm) inside the exterior wall line of the building.

**Exception:** Detached accessory structures that contain no conditioned floor area.

**1507.6.4 Material standards.** Mineral-surfaced roll roofing shall conform to ASTM D 224, ASTM D 249, ASTM D 371 or ASTM D 3909.

**1507.7 Slate shingles.** The installation of slate shingles shall comply with the provisions of this section.

**1507.7.1 Deck requirements.** Slate shingles shall be fastened to solidly sheathed roofs.

**1507.7.2 Deck slope.** Slate shingles shall only be used on slopes of four units vertical in 12 units horizontal (4:12) or greater.

**1507.7.3 Underlayment.** Underlayment shall comply with ASTM D 226, Type II. Where there is a possibility of ice forming along the eaves causing a backup of water, an ice barrier that consists of at least two layers of underlayment cemented together or of a self-adhering polymer-modified bitumen sheet, shall extend from the eave's edge to a point at least 24 inches (610 mm) inside the exterior wall line of the building.

**Exception:** Detached accessory structures that contain no conditioned floor area.

**1507.7.4 Material standards.** Slate shingles shall comply with ASTM C 406.

**1507.7.5 Application.** Minimum headlap for slate shingles shall be in accordance with Table 1507.7.5. Slate shingles shall be secured to the roof with two fasteners per slate.

**TABLE 1507.7.5**  
**SLATE SHINGLE HEADLAP**  
**(Table 1507.7.5 attached to end of document)**

**1507.7.6 Flashing.** Flashing and counterflashing shall be made with sheet metal. Valley flashing shall be a minimum of 15 inches (381 mm) wide. Valley and flashing

metal shall be a minimum uncoated thickness of 0.0179-inch (0.455 mm) zinc-coated G90. Chimneys, stucco or brick walls shall have a minimum of two plies of felt for a cap flashing consisting of a 4-inch-wide (102 mm) strip of felt set in plastic cement and extending 1 inch (25 mm) above the first felt and a top coating of plastic cement. The felt shall extend over the base flashing 2 inches (51 mm).

**1507.8 Wood shingles.** The installation of wood shingles shall comply with the provisions of this section and Table 1507.8.

**1507.8.1 Deck requirements.** Wood shingles shall be installed on solid or spaced sheathing. Where spaced sheathing is used, sheathing boards shall not be less than 1-inch by 4-inch (25 mm by 102 mm) nominal dimensions and shall be spaced on centers equal to the weather exposure to coincide with the placement of fasteners.

**1507.8.1.1 Solid sheathing required.** Solid sheathing is required where there is a possibility of ice forming along the eaves causing a backup of water.

**1507.8.2 Deck slope.** Wood shingles shall be installed on slopes of three units vertical in 12 units horizontal (25-percent slope) or greater.

**1507.8.3 Underlayment.** Underlayment shall comply with ASTM D 226, Type I. Where there is a possibility of ice forming along the eaves causing a backup of water, an ice barrier that consists of at least two layers of underlayment cemented together or of a self-adhering polymer-modified bitumen sheet shall extend from the eave's edge to a point at least 24 inches (610 mm) inside the exterior wall line of the building.

**Exception:** Detached accessory structures that contain no conditioned floor area.

**TABLE 1507.8**  
**WOOD SHINGLE AND SHAKE INSTALLATION**  
**(Table 1507.8 attached to end of document)**

**1507.8.4 Material standards.** Wood shingles shall be of naturally durable wood and comply with the requirements of Table 1507.8.4.

**TABLE 1507.8.4**  
**WOOD SHINGLE MATERIAL REQUIREMENTS**  
**(Table 1507.8.4 attached to end of document)**

**1507.8.5 Attachment.** Fasteners for wood shingles shall be corrosion resistant with a minimum penetration of 0.75 inch (19.1 mm) into the sheathing. For sheathing less than 0.5 inch (12.7 mm) in thickness, the fasteners shall extend through the sheathing. Each shingle shall be attached with a minimum of two fasteners.

**1507.8.6 Application.** Wood shingles shall be laid with a side lap not less than 1.5 inches (38 mm) between joints in adjacent courses, and not be in direct alignment in

alternate courses. Spacing between shingles shall be 0.25 to 0.375 inches (6.4 to 9.5 mm). Weather exposure for wood shingles shall not exceed that set in Table 1507.8.6.

**TABLE 1507.8.6**  
**WOOD SHINGLE WEATHER EXPOSURE AND ROOF SLOPE**  
**(Table 1507.8.6 attached to end of document)**

**1507.8.7 Flashing.** At the juncture of the roof and vertical surfaces, flashing and counterflashing shall be provided in accordance with the manufacturer's installation instructions, and where of metal, shall not be less than 0.019-inch (0.48 mm) (No. 26 galvanized sheet gage) corrosion-resistant metal. The valley flashing shall extend at least 11 inches (279 mm) from the centerline each way and have a splash diverter rib not less than 1 inch (25 mm) high at the flow line formed as part of the flashing. Sections of flashing shall have an end lap of not less than 4 inches (102 mm). For roof slopes of three units vertical in 12 units horizontal (25-percent slope) and over, the valley flashing shall have a 36-inch-wide (914 mm) underlayment of one layer of Type I underlayment running the full length of the valley, in addition to other required underlayment. Where there is a possibility of ice forming along the eaves causing a backup of water, the metal valley flashing underlayment shall be solid cemented to the roofing underlayment for slopes under seven units vertical in 12 units horizontal (58-percent slope).

**1507.9 Wood shakes.** The installation of wood shakes shall comply with the provisions of this section and Table 1507.8.

**1507.9.1 Deck requirements.** Wood shakes shall only be used on solid or spaced sheathing. Where spaced sheathing is used, sheathing boards shall not be less than 1-inch by 4-inch (25 mm by 102 mm) nominal dimensions and shall be spaced on centers equal to the weather exposure to coincide with the placement of fasteners. Where 1-inch by 4-inch (25 mm by 102 mm) spaced sheathing is installed at 10 inches (254 mm) o.c., additional 1-inch by 4-inch (25 mm by 102 mm) boards shall be installed between the sheathing boards.

**1507.9.1.1 Solid sheathing required.** Solid sheathing is required in areas where the average daily temperature in January is 25°F (-4°C) or less or where there is a possibility of ice forming along the eaves causing a backup of water.

**1507.9.2 Deck slope.** Wood shakes shall only be used on slopes of four units vertical in 12 units horizontal (33-percent slope) or greater.

**1507.9.3 Underlayment.** Underlayment shall comply with ASTM D 226, Type I. Where there is a possibility of ice forming along the eaves causing a backup of water, an ice barrier that consists of at least two layers of underlayment cemented together or a self-adhering polymer-modified bitumen sheet shall extend from the edge of the eave to a point at least 24 inches (610 mm) inside the exterior wall line of the building.

**Exception:** Detached accessory structures that contain no conditioned floor area.

**1507.9.4 Interlayment.** Interlayment shall comply with ASTM D 226, Type I.

**1507.9.5 Material standards.** Wood shakes shall comply with the requirements of Table 1507.9.5.

**TABLE 1507.9.5**  
**WOOD SHAKE MATERIAL REQUIREMENTS**  
**(Table 1507.9.5 attached to end of document)**

**1507.9.6 Attachment.** Fasteners for wood shakes shall be corrosion resistant with a minimum penetration of 0.75 inch (19.1 mm) into the sheathing. For sheathing less than 0.5 inch (12.7 mm) in thickness, the fasteners shall extend through the sheathing. Each shake shall be attached with a minimum of two fasteners.

**1507.9.7 Application.** Wood shakes shall be laid with a side lap not less than 1.5 inches (38 mm) between joints in adjacent courses. Spacing between shakes in the same course shall be 0.375 to 0.625 inches (9.5 to 15.9 mm) for shakes and taper sawn shakes of naturally durable wood and shall be 0.25 to 0.375 inch (6.4 to 9.5 mm) for preservative taper sawn shakes. Weather exposure for wood shakes shall not exceed those set in Table 1507.9.7.

**TABLE 1507.9.7**  
**WOOD SHAKE WEATHER EXPOSURE AND ROOF SLOPE**  
**(Table 1507.9.7 attached to end of document)**

**1507.9.8 Flashing.** At the juncture of the roof and vertical surfaces, flashing and counter-flashing shall be provided in accordance with the manufacturer's installation instructions, and where of metal, shall not be less than 0.019-inch (0.48 mm) (No. 26 galvanized sheet gage) corrosion-resistant metal. The valley flashing shall extend at least 11 inches (279 mm) from the centerline each way and have a splash diverter rib not less than 1 inch (25 mm) high at the flow line formed as part of the flashing. Sections of flashing shall have an end lap of not less than 4 inches (102 mm). For roof slopes of 3 units vertical in 12 units horizontal (25-percent slope) and over, the valley flashing shall have a 36-inch-wide (914 mm) underlayment of one layer of Type I underlayment running the full length of the valley, in addition to other required underlayment. Where there is a possibility of ice forming along the eaves causing a backup of water, the metal valley flashing underlayment shall be solid cemented to the roofing underlayment for slopes under seven units vertical in 12 units horizontal (58-percent slope).

**1507.10 Built-up roofs.** The installation of built-up roofs shall comply with the provisions of this section.

**1507.10.1 Slope.** Built-up roofs shall have a slope designed and built to provide positive roof drainage.

**1507.10.2 Material standards.** Built-up roof covering materials shall comply with the standards in Table 1507.10.2.

**TABLE 1507.10.2**  
**BUILT-UP ROOFING MATERIAL STANDARDS**  
**(Table 1507.10.2 attached to end of document)**

**1507.11 Modified bitumen roofing.** The installation of modified bitumen roofing shall comply with the provisions of this section.

**1507.11.1 Slope.** Modified bitumen membrane roofs shall have a slope designed and built to provide positive roof drainage.

**1507.11.2 Material standards.** Modified bitumen roof coverings shall comply with CGSB 37-GP-56M, ASTM D 6162, ASTM D 6163, ASTM D 6164, ASTM D 6222, ASTM D 6223 and ASTM D 6298.

**1507.12 Thermoset single-ply roofing.** The installation of thermoset single-ply roofing shall comply with the provisions of this section.

**1507.12.1 Slope.** Thermoset single-ply membrane roofs shall have a slope designed and built to provide positive roof drainage.

**1507.12.2 Material standards.** Thermoset single-ply roof coverings shall comply with RMA RP-1, RP-2 or RP-3, or ASTM D 4637, ASTM D 5019 or CGSB 37-GP-52M.

**1507.13 Thermoplastic single-ply roofing.** The installation of thermoplastic single-ply roofing shall comply with the provisions of this section.

**1507.13.1 Slope.** Thermoplastic single-ply membrane roofs shall have a slope designed and built to provide positive roof drainage.

**1507.13.2 Material standards.** Thermoplastic single-ply roof coverings shall comply with ASTM D 4434 or CGSB 37-GP-54M.

**1507.14 Sprayed polyurethane foam roofing.** The installation of sprayed polyurethane foam roofing shall comply with the provisions of this section.

**1507.14.1 Slope.** Sprayed polyurethane foam roofs shall have a slope designed and built to provide positive roof drainage.

**1507.14.2 Material standards.** Spray-applied polyurethane foam insulation shall

comply with ASTM C 1029.

**1507.14.3 Application.** Foamed-in-place roof insulation shall be installed in accordance with the manufacturer's instructions. A liquid-applied protective coating that complies with Section 1507.15 shall be applied no less than 2 hours nor more than 72 hours following the application of the foam.

**1507.14.4 Foamplastics.** Foam plastic materials and installation shall comply with Chapter 26.

**1507.15 Liquid-applied coatings.** The installation of liquid-applied coatings shall comply with the provisions of this section.

**1507.15.1 Slope.** Liquid-applied roofs shall have a slope designed and built to provide positive roof drainage.

**1507.15.2 Material standards.** Liquid-applied roof coatings shall comply with ASTM C 836, ASTM C 957, ASTM D 6083, ASTM D 1227 or ASTM D 3468.

**1507.16 Green roof System.** The installation of a green roof system shall comply with this section.

**1507.16.1 Roof covering.** Roof covering shall conform with Sections 1507.10, 1507.11, 1507.12, 1507.13, or 1507.15.

**1507.16.2 Slope.** Green roof systems shall have a design slope in accordance with the roof covering utilized.

**1507.16.3 Material Standards.** Green roof systems shall comply with required standards for the roof covering and good practice standards for the landscape material components. Either an affidavit from the roof covering manufacturer, stating review and acceptance of the final work, shall be provided prior to sign-off of construction or a controlled inspection by the professional architect or engineer shall be performed.

## **SECTION BC 1508** **ROOF INSULATION**

**1508.1 General.** The use of above-deck thermal insulation shall be permitted provided such insulation is covered with an approved roof covering and passes the tests of FM 4450 or UL 1256 when tested as an assembly.

**Exception:** Foam plastic roof insulation shall conform to the material and installation requirements of Chapter 26.

**1508.1.1 Cellulosic fiberboard.** Cellulosic fiberboard roof insulation shall conform to the material and installation requirements of Chapter 23.

**SECTION BC 1509**  
**ROOFTOP STRUCTURES**

**1509.1 General.** The provisions of this section shall govern the construction of rooftop structures. All rooftop structures shall be subject to the roof area coverage limitations and building height requirements of Chapter 5. Rooftop structures shall be constructed with materials as required for the building, except as provided for in this section.

**1509.2 Bulkheads and Penthouses.** Bulkheads and penthouses shall comply with the construction requirements of Section 1509.2.

**1509.2.1 Type of construction.** Bulkheads and penthouses shall be constructed with walls, floors and roof as required for the building.

**Exceptions:** Where the total aggregate area of all rooftop structures does not exceed 33 ⅓ percent of the area of the roof of the building upon which they are erected; the following shall apply:

1. Bulkheads on buildings of Type I and II construction. The exterior walls and roofs of such bulkheads with a fire separation distance of more than 5 feet (1524 mm) and less than 20 feet (6096 mm) shall be of at least 1-hour fire-resistance-rated noncombustible construction. Walls and roofs with a fire separation distance of 20 feet (6096 mm) or greater shall be of noncombustible construction. Interior framing and walls shall be of noncombustible construction.
2. Bulkheads on buildings of Type III, IV and V construction. The exterior walls of such bulkheads with a fire separation distance of more than 5 feet (1524 mm) and less than 20 feet (6096 mm) shall be at least 1-hour fire-resistance-rated construction. Walls with a fire separation distance of 20 feet (6096 mm) or greater from a common property line shall be of Type IV or noncombustible construction. Roofs shall be constructed of materials and fire-resistance rated as required in Table 601. Interior framing and walls shall be Type IV or noncombustible construction.
3. Unprotected noncombustible enclosures housing only mechanical equipment and located with a minimum fire separation distance of 20 feet (6096 mm) shall be permitted.
4. On one-story buildings, combustible unroofed mechanical equipment screens, fences or similar enclosures are permitted where located with a fire separation distance of at least 20 feet (6096 mm) from adjacent property lines and where not exceeding 4 feet (1219 mm) in height above the roof surface.

**1509.2.2 Penthouses.** Enclosed walls of penthouses shall comply with the

requirements for exterior walls as per Table 601 and 602 for the construction class of the building on which they are erected. Roofs of penthouses shall comply with the requirements for roof construction of Table 601 and Chapter 15 of this code.

**1509.2.3 Bulkheads.** An enclosed rooftop structure not intended for human occupancy shall not be used for purposes other than shelter of mechanical equipment or shelter of vertical shaft openings in the roof. Provisions such as louvers, louver blades or flashing shall be made to protect the mechanical equipment and the building interior from the elements.

**1509.3 Tank supports.** Tanks having a capacity of more than 500 gallons (2 m<sup>3</sup>) placed in or on a building shall be supported on masonry, reinforced concrete, steel or Type IV construction provided that, where such supports are located in the building above the lowest story, the support shall be fire-resistance rated as required for Type IA construction.

**1509.3.1 Valve.** Such tanks shall have in the bottom or on the side near the bottom, a pipe or outlet, fitted with a suitable quick opening valve for discharging the contents in an emergency through an adequate drain.

**1509.3.2 Location.** Such tanks shall not be placed over or near a line of stairs or an elevator shaft, unless there is a solid roof or floor underneath the tank.

**1509.3.3 Tank cover.** Unenclosed roof tanks shall have covers sloping toward the outer edges.

**1509.4 Cooling towers.** Cooling towers in excess of 250 square feet (23.2 m<sup>2</sup>) in base area or in excess of 15 feet (4572 mm) high where located on buildings more than 50 feet (15 240 mm) high shall be of noncombustible construction.

**Exceptions:**

1. Drip boards and the enclosing construction of wood not less than 1 inch (25 mm) nominal thickness, provided the wood is covered on the exterior of the tower with noncombustible material.
2. Filling and drift eliminators may be of combustible material if the towers are provided with automatic sprinkler protection complying with Section 903 of this code.

**1509.5 Steeples, minarets, spires, domes and cupolas.** Any steeple, minaret, spire, dome or cupola shall be of a type of construction not less in fire-resistance rating than required for the building to which it is attached except that any such steeple, minaret, spire, dome or cupola that exceeds 85 feet (25 908 mm) in height above grade, or exceeds 200 square feet (18.6 m<sup>2</sup>) in horizontal area or is used for any purpose other than a belfry or an architectural embellishment shall be constructed of and supported on Type I or II



construction.

**1509.5.1 Noncombustible construction required.** Any steeple, minaret, spire, dome or cupola that exceeds 60 feet (18 288 mm) in height above the highest point at which it comes in contact with the roof, or that exceeds 200 square feet (18.6 m<sup>2</sup>) in area at any horizontal section, or which is intended to be used for any purpose other than a belfry or architectural embellishment, shall be entirely constructed of and supported by noncombustible materials. Such structures shall be separated from the building below by construction having a fire-resistance rating of not less than 1.5 hours with openings protected with a minimum 1.5-hour fire-protection rating. Such structures placed above the roof of any building more than 50 feet (15 240 mm) in height, shall be of noncombustible material and shall be supported by construction of noncombustible material.

**1509.5.2 Steeples, minarets and spires.** Steeples, minarets, and spires where enclosed shall have exterior walls as required for the building to which they are attached. The roof covering of spires shall be of a class of roof covering as required for the main roof of the rest of the structure.

**1509.6 Dormers.** Dormers shall have exterior walls as required for the building to which they are attached. The roof covering of dormers shall be of a class of roof covering as required for the main roof of the rest of the structure.

**1509.7 Greenhouses.** Greenhouses used for the cultivation of plants, on the roofs of buildings other than buildings of Type V construction, shall be constructed of noncombustible framework and shall be glazed with plain or wire glass, or light transmitting plastic glazing complying with the requirements of Section 2606. The floors of greenhouses shall be constructed to be at least equal to the requirements for roof construction on Table 601 for the construction class of the building on which it is located.

**1509.8 Protective guards.** Buildings greater than 22 feet (6706 mm) in height with roof slopes less than 2.4 units vertical in 12 units horizontal (20 percent slope) shall be provided with a parapet, railing, fence, or combination thereof, not less than 42 inches (1067 mm) in height. Railings or fences may be located inward from the face of the exterior wall a distance not exceeding 6 feet (1829 mm). Railings or fences shall be of noncombustible material, except on buildings of Type V construction. Railings shall be constructed to comply with the requirements of Sections 1012 and 1607.7.

**1509.8.1 Fences on roofs used for recreational purposes.** Rooftops used for recreational purposes shall be provided with wire fencing at least 10 feet (3048 mm) in height. Openings in the fence shall not permit the passage of a 4-inch diameter (102 mm) sphere. Where ball games are played on rooftops the wire fencing shall be extended to provide an overhead closure.

**1509.9 Miscellaneous combustible roof structures.** The following roof structures may be constructed of combustible material if less than 12 feet (1658 mm) high above the

roof: antenna supports; flagpoles; clothes drying frames; duckboarding, decking or platforms that do not cover more than 20 percent of the contiguous roof area at that level.

## **SECTION BC 1510** **REROOFING**

**1510.1 General.** Materials and methods of application used for recovering or replacing an existing roof covering shall comply with the requirements of Chapter 15.

**1510.2 Structural and construction loads.** Structural roof components shall be capable of supporting the roof-covering system and the material and equipment loads that will be encountered during installation of the system.

**1510.3 Recovering versus replacement.** New roof coverings shall not be installed without first removing all existing layers of roof coverings where any of the following conditions occur:

1. Where the existing roof or roof covering is water soaked or has deteriorated to the point that the existing roof or roof covering is not adequate as a base for additional roofing.
2. Where the existing roof covering is wood shake, slate, clay, cement or asbestos-cement tile.
3. Where the existing roof has two or more applications of any type of roof covering.

### **Exceptions:**

1. Complete and separate roofing systems, such as standing-seam metal roof systems, that are designed to transmit the roof loads directly to the building's structural system and that do not rely on existing roofs and roof coverings for support, shall not require the removal of existing roof coverings.
2. Metal panel, metal shingle, and concrete and clay tile roof coverings shall be permitted to be installed over existing wood shake roofs when applied in accordance with Section 1510.4.

**1510.4 Roof recovering.** Where the application of a new roof covering over wood shingle or shake roofs creates a combustible concealed space, the entire existing surface shall be covered with gypsum board, mineral fiber, glass fiber or other approved materials securely fastened in place.

**1510.5 Reinstallation of materials.** Existing slate, clay or cement tile shall be permitted for reinstallation, except that damaged, cracked or broken slate or tile shall not be

reinstalled. Existing vent flashing, metal edgings, drain outlets, collars and metal counterflashings shall not be reinstalled where rusted, damaged or deteriorated. Aggregate surfacing materials shall not be reinstalled.

**1510.6 Flashings.** Flashings shall be reconstructed in accordance with approved manufacturer's installation instructions. Metal flashing to which bituminous materials are to be adhered shall be primed prior to installation.

**TABLE 1505.1<sup>a,b</sup>**  
**MINIMUM ROOF COVERING CLASSIFICATION FOR TYPES OF**  
**CONSTRUCTION**

<b><u>IA</u></b>	<b><u>IB</u></b>	<b><u>IIA</u></b>	<b><u>IIB</u></b>	<b><u>IIIA</u></b>	<b><u>IIIB</u></b>	<b><u>IV</u></b>	<b><u>VA</u></b>	<b><u>VB</u></b>
<b><u>B</u></b>	<b><u>B</u></b>	<b><u>B</u></b>	<b><u>B</u></b>	<b><u>B</u></b>	<b><u>B</u></b>	<b><u>B</u></b>	<b><u>B</u></b>	<b><u>C<sup>b</sup></u></b>

For SI: 1 foot = 304.8 mm, 1 square foot = 0.0929 m<sup>2</sup>

- a. Unless otherwise required in accordance with the *International Urban Wildland Interface Code* or due to the location of the building within a fire district in accordance with Appendix D.
- b. Buildings that are not more than two stories in height and having not more than 6,000 square feet of projected roof area and where there is a minimum 10-foot fire-separation distance from the leading edge of the roof to a lot line on all sides of the building, except for street fronts or public ways, shall be permitted to have roofs of No. 1 cedar or redwood shakes and No. 1 shingles in accordance with Section 1505.6.

**TABLE 1507.2  
ASPHALT SHINGLE APPLICATION**

COMPONENT	INSTALLATION REQUIREMENT
1. Roof slope	Asphalt shingles shall only be used on roof slopes of two units vertical in 12 units horizontal (2:12) or greater. For roof slopes from two units vertical in 12 units horizontal (2:12) up to four units vertical in 12 units horizontal (4:12), double underlayment application is required in accordance with Section 1507.2.8.
2. Deck requirement	Asphalt shingles shall be fastened to solidly sheathed roofs.
3. Underlayment	Underlayment shall conform with ASTM D 226, Type 1, or ASTM D 4869, Type 1.
For roof slopes from two units vertical in 12 units horizontal (2:12), up to four units vertical in 12 units horizontal (4:12)	Underlayment shall be two layers applied in the following manner. Apply a minimum 19-inch strip or underlayment felt parallel to and starting at the eaves, fastened sufficiently to hold in place. Starting at the eave, apply 35-inch-wide sheets of underlayment overlapping successive sheets 19 inches and fastened sufficiently to hold in place.
For roof slopes from four units vertical in 12 units horizontal (4:12) or greater	Underlayment shall be one layer applied in the following manner. Underlayment shall be applied shingle fashion, parallel to and starting from the eave and lapped 2 inches, fastened only as necessary to hold in place.
In areas where the average daily temperature in January is 25°F or less or where there is a possibility of ice forming along the eaves causing a backup of water	A membrane that consists of at least two layers of underlayment cemented together or of a self-adhering polymer-modified bitumen sheet shall be used in lieu of normal underlayment and extend from the eave's edge to a point at least 24 inches inside the exterior wall line of the building.
4. Application	—
Attachment	Asphalt shingles shall have the minimum number of fasteners required by the manufacturer and Section 1504.1. Asphalt shingles shall be secured to the roof with not less than four fasteners per strip shingle or two fasteners per individual shingle. Where the roof slope exceeds 20 units vertical in 12 units horizontal (20:12), special methods of fastening are required.
Fasteners	Galvanized, stainless steel, aluminum or copper roofing nails, minimum 12-gage (0.015 inch) shank with a minimum 3/8-inch diameter head. Fasteners shall be long enough to penetrate into the sheathing 3/4 inch or through the thickness of the sheathing.
Flashings	In accordance with Section 1507.2.9.

For SI: 1 inch = 25.4 mm, 1 foot = 304.8 mm, °C = [(°F) - 32]/1.8, 1 mile per hour = 1.609 km/h.

**TABLE 1507.2.9.2  
VALLEY LINING MATERIAL**

MATERIAL	MINIMUM THICKNESS	GAGE	WEIGHT
Copper	—	—	16 oz
Aluminum	0.024 in.	—	—
Stainless steel	—	28	—
Galvanized steel	0.0179 in.	26 (zinc-coated G90)	—
Zinc alloy	0.027 in.	—	—
Lead	—	—	2.5 pounds
Painted terne	—	—	20 pounds

For SI: 1 inch = 25.4 mm, 1 pound = 0.454 kg, 1 ounce = 28.35 g.

**TABLE 1507.3.5  
TRANSVERSE BREAKING STRENGTH  
OF CONCRETE ROOF TILE (lbs.)**

TILE PROFILE	DRY	
	Average of five tiles	Individual tile
High profile	400	350
Medium profile	300	250
Flat profile	300	250

For SI: 1 pound = 4.45 N.

**TABLE 1507.3.7  
CLAY AND CONCRETE TILE ATTACHMENT<sup>a, b, c</sup>**

<b>GENERAL — CLAY OR CONCRETE ROOF TILE</b>				
<b>Maximum basic wind speed (mph)</b>	<b>Mean roof height (feet)</b>	<b>Roof slope up to &lt; 3:12</b>	<b>Roof slope 3:12 and over</b>	
85	0-60	One fastener per tile. Flat tile without vertical laps, two fasteners per tile.	Two fasteners per tile. Only one fastener on slopes of 7:12 and less for tiles with installed weight exceeding 7.5 lbs./sq. ft. having a width no greater than 16 inches.	
100	0-40			
100	> 40-60	The head of all tiles shall be nailed. The nose of all eave tiles shall be fastened with approved clips. All rake tiles shall be nailed with two nails. The nose of all ridge, hip and rake tiles shall be set in a bead of roofer's mastic.		
110	0-60	The fastening system shall resist the wind forces in Section 1609.7.2.		
120	0-60	The fastening system shall resist the wind forces in Section 1609.7.2.		
130	0-60	The fastening system shall resist the wind forces in Section 1609.7.2.		
All	> 60	The fastening system shall resist the wind forces in Section 1609.7.2.		
<b>INTERLOCKING CLAY OR CONCRETE ROOF TILE WITH PROJECTING ANCHOR LUGS<sup>d, e</sup> (Installations on spaced/solid sheathing with battens or spaced sheathing)</b>				
<b>Maximum basic wind speed (mph)</b>	<b>Mean roof height (feet)</b>	<b>Roof slope up to &lt; 5:12</b>	<b>Roof slope 5:12 &lt; 12:12</b>	<b>Roof slope 12:12 and over</b>
85	0-60	Fasteners are not required. Tiles with installed weight less than 9 lbs./sq. ft. require a minimum of one fastener per tile.	One fastener per tile every other row. All perimeter tiles require one fastener. Tiles with installed weight less than 9 lbs./sq. ft. require a minimum of one fastener per tile.	One fastener required for every tile. Tiles with installed weight less than 9 lbs./sq. ft. require a minimum of one fastener per tile.
100	0-40			
100	> 40-60	The head of all tiles shall be nailed. The nose of all eave tiles shall be fastened with approved clips. All rake tiles shall be nailed with two nails The nose of all ridge, hip and rake tiles shall be set in a bead of roofers's mastic.		
110	0-60	The fastening system shall resist the wind forces in Section 1609.7.2.		
120	0-60	The fastening system shall resist the wind forces in Section 1609.7.2.		
130	0-60	The fastening system shall resist the wind forces in Section 1609.7.2.		
All	> 60	The fastening system shall resist the wind forces in Section 1609.7.2.		
<b>INTERLOCKING CLAY OR CONCRETE ROOF TILE WITH PROJECTING ANCHOR LUGS (Installations on solid sheathing without battens)</b>				
<b>Maximum basic wind speed (mph)</b>	<b>Mean roof height (feet)</b>	<b>All roof slopes</b>		
85	0-60	One fastener per tile.		
100	0-40	One fastener per tile.		
100	> 40-60	The head of all tiles shall be nailed. The nose of all eave tiles shall be fastened with approved clips. All rake tiles shall be nailed with two nails The nose of all ridge, hip and rake tiles shall be set in a bead of roofers's mastic.		
110	0-60	The fastening system shall resist the wind forces in Section 1609.7.2.		
120	0-60	The fastening system shall resist the wind forces in Section 1609.7.2.		
130	0-60	The fastening system shall resist the wind forces in Section 1609.7.2.		
All	> 60	The fastening system shall resist the wind forces in Section 1609.7.2.		

For SI: 1 inch = 25.4 mm, 1 foot = 304.8 mm, 1 mile per hour = 1.609 km/h, 1 pound per square foot = 0.0478 kN/m<sup>2</sup>.

- a. Minimum fastener size. Corrosion-resistant nails not less than No. 11 gage with <sup>3</sup>/<sub>16</sub>-inch head. Fasteners shall be long enough to penetrate into the sheathing 0.75 inch or through the thickness of the sheathing, whichever is less. Attaching wire for clay and concrete tile shall not be smaller than 0.083 inch.
- b. Snow areas. A minimum of two fasteners per tile are required or battens and one fastener.
- c. Roof slopes greater than 24:12. The nose of all tiles shall be securely fastened.
- d. Horizontal battens. Battens shall be not less than 1 inch by 2 inch nominal. Provisions shall be made for drainage by a minimum of <sup>1</sup>/<sub>4</sub>-inch riser at each nail or by 4-foot-long battens with at least a 0.5-inch separation between battens. Horizontal battens are required for slopes over 7:12.
- e. Perimeter fastening areas include three tile courses but not less than 36 inches from either side of hips or ridges and edges of eaves and gable rakes.

**TABLE 1507.4.3  
METAL ROOF COVERINGS**

ROOF COVERING TYPE	STANDARD APPLICATION RATE/THICKNESS
Aluminum	ASTM B 209, 0.024 inch minimum thickness for roll-formed panels and 0.019 inch minimum thickness for press-formed shingles.
Aluminum-zinc alloy coated steel	ASTM A 792 AZ 50
Copper	16 oz./sq. ft. for metal-sheet roof-covering systems; 12 oz./sq. ft. for preformed metal shingle systems.
Galvanized steel	ASTM A 653 G-90 zinc-coated, 0.013-inch-thick minimum
Lead-coated copper	ASTM B 101
Hard lead	2 lbs./sq. ft.
Soft lead	3 lbs./sq. ft.
Prepainted steel	ASTM A 755
Terne (tin) and terne-coated stainless	Terne coating of 40 lbs. per double base box, field painted where applicable in accordance with manufacturer's installation instructions.

For SI: 1 ounce per square foot = 0.0026 kg/m<sup>2</sup>,  
 1 pound per square foot = 4.882 kg/m<sup>2</sup>,  
 1 inch = 25.4 mm, 1 pound = 0.454 kg.

**TABLE 1507.7.5  
SLATE SHINGLE HEADLAP**

SLOPE	HEADLAP (inches)
4:12 < slope < 8:12	4
8:12 < slope < 20:12	3
slope ≥ 20:12	2

For SI: 1 inch = 25.4 mm.

**TABLE 1507.8  
WOOD SHINGLE AND SHAKE INSTALLATION**

ROOF ITEM	WOOD SHINGLES	WOOD SHAKES
1. Roof slope	Wood shingles shall be installed on slopes of three units vertical in 12 units horizontal (3:12) or greater.	Wood shakes shall be installed on slopes of four units vertical in 12 units horizontal (4:12) or greater.
2. Deck requirement	—	—
Temperate climate	Shingles shall be applied to roofs with solid or spaced sheathing. Where spaced sheathing is used, sheathing boards shall not be 4 less than 1" x 4" nominal dimensions and shall be spaced on center equal to the weather exposure to coincide with the placement of fasteners.	Shakes shall be applied to roofs with solid or spaced sheathing. Where spaced sheathing is used, sheathing boards shall not be less than 1" x 4" nominal dimensions and shall be spaced on center equal to the weather exposure to coincide with the placement of fasteners. When 1" x 4" spaced sheathing is installed at 10 inches, boards must be installed between the sheathing boards.
In areas where the average daily temperature in January is 25°F or less or where there is a possibility of ice forming along the eaves causing a backup of water.	Solid sheathing required.	Solid sheathing is required.
3. Interlayment	No requirements.	Interlayment shall comply with ASTM D 226, Type 1.
4. Underlayment	—	—
Temperate climate	Underlayment shall comply with ASTM D 226, Type 1.	Underlayment shall comply with ASTM D 226, Type 1.
In areas where the average daily temperature in January is 25°F or less or where there is a possibility of ice forming along the eaves causing a backup of water.	An ice shield that consists of at least two layers of underlayment cemented together or of a self-adhering polymer-modified bitumen sheet shall extend from the eave's edge to a point at least 24 inches inside the exterior wall line of the building.	An ice shield that consists of at least two layers of underlayment cemented together or of a self-adhering polymer-modified bitumen sheet shall extend from the eave's edge to a point at least 24 inches inside the exterior wall line of the building.
5. Application	—	—
Attachment	Fasteners for wood shingles shall be corrosion resistant with a minimum penetration of 0.75 inch into the sheathing. For sheathing less than 0.5 inch thick, the fasteners shall extend through the sheathing.	Fasteners for wood shakes shall be corrosion resistant with a minimum penetration of 0.75 inch into the sheathing. For sheathing less than 0.5 inch thick, the fasteners shall extend through the sheathing.
No. of fasteners	Two per shingle.	Two per shake.
Exposure	Weather exposures shall not exceed those set forth in Table 1507.8.6	Weather exposures shall not exceed those set forth in Table 1507.9.7
Method	Shingles shall be laid with a side lap of not less than 1.5 inches between joints in courses, and no two joints in any three adjacent courses shall be in direct alignment. Spacing between shingles shall be 0.25 to 0.375 inch.	Shakes shall be laid with a side lap of not less than 1.5 inches between joints in adjacent courses. Spacing between shakes shall not be less than 0.375 inch or more than 0.625 inch for shakes and tapersawn shakes of naturally durable wood and shall be 0.25 to 0.375 inch for preservative taper sawn shakes.
Flashing	In accordance with Section 1507.8.7.	In accordance with Section 1507.9.8.

For SI: 1 inch = 25.4 mm, °C = [(°F) - 32]/1.8.

**TABLE 1507.8.4  
WOOD SHINGLE MATERIAL REQUIREMENTS**

MATERIAL	APPLICABLE MINIMUM GRADES	GRADING RULES
Wood shingles of naturally durable wood	1, 2 or 3	CSSB

CSSB = Cedar Shake and Shingle Bureau



**TABLE 1507.8.6  
WOOD SHINGLE WEATHER EXPOSURE AND ROOF SLOPE**

ROOFING MATERIAL	LENGTH(inches)	GRADE	EXPOSURE (inches)	
			3:12 pitch to < 4:12	4:12 pitch or steeper
Shingles of naturally durable wood	16	No. 1	3.75	5
		No. 2	3.5	4
		No. 3	3	3.5
	18	No. 1	4.25	5.5
		No. 2	4	4.5
		No. 3	3.5	4
	24	No. 1	5.75	7.5
		No. 2	5.5	6.5
		No. 3	5	5.5

For SI: 1 inch = 25.4 mm.

**TABLE 1507.9.5  
WOOD SHAKE MATERIAL REQUIREMENTS**

MATERIAL	MINIMUM GRADES	APPLICABLE GRADING RULES
Wood shakes of naturally durable wood	1	CSSB
Taper sawn shakes of naturally durable wood	1 or 2	CSSB
Preservative-treated shakes and shingles of naturally durable wood	1	CSSB
Fire-retardant-treated shakes and shingles of naturally durable wood	1	CSSB
Preservative-treated taper sawn shakes of Southern yellow pine treated in accordance with AWPA Standard C2	1 or 2	TFS

CSSB = Cedar Shake and Shingle Bureau.

TFS = Forest Products Laboratory of the Texas Forest Services.

**TABLE 1507.9.7  
WOOD SHAKE WEATHER EXPOSURE  
AND ROOF SLOPE**

ROOFING MATERIAL	LENGTH (inches)	GRADE	EXPOSURE (inches) 4:12 PITCH OR STEEPER
Shakes of naturally durable wood	18	No. 1	7.5
	24	No. 1	10a
Preservative-treated taper sawn shakes of Southern yellow pine	18	No. 1	7.5
	24	No. 1	10
	18	No. 2	5.5
	24	No. 2	7.5
Taper sawn shakes of naturally durable wood	18	No. 1	7.5
	24	No. 1	10
	18	No. 2	5.5
	24	No. 2	7.5

For SI: 1 inch = 25.4 mm.

a. For 24-inch by 0.375-inch handsplit shakes, the maximum exposure is 7.5 inches.

**TABLE 1507.10.2  
BUILT-UP ROOFING MATERIAL STANDARDS**

<b>MATERIAL STANDARD</b>	<b>STANDARD</b>
Acrylic coatings used in roofing	ASTM D 6083
Aggregate surfacing	ASTM D 1863
Asphalt adhesive used in roofing	ASTM D 3747
Asphalt cements used in roofing	ASTM D 3019; D 2822; D 4586
Asphalt-coated glass fiber base sheet	ASTM D 4601
Asphalt coatings used in roofing	ASTM D1227; D 2823; D 4479
Asphalt glass felt	ASTM D 2178
Asphalt primer used in roofing	ASTM D 41
Asphalt-saturated and asphalt-coated organic felt base sheet	ASTM D 2626
Asphalt-saturated organic felt (perforated)	ASTM D 226
Asphalt used in roofing	ASTM D 312
Coal-tar cements used in roofing	ASTM D 4022; D 5643
Coal-tar saturated organic felt	ASTM D 227
Coal-tar pitch used in roofing	ASTM D 450; Type I or II
Coal-tar primer used in roofing, damproofing and waterproofing	ASTM D 43
Glass mat, coal tar	ASTM D 4990
Glass mat, venting type	ASTM D 4897
Mineral-surfaced inorganic cap sheet	ASTM D 3909
Thermoplastic fabrics used in roofing	ASTM D 5665, D 5726

**CHAPTER 16**  
**STRUCTURAL DESIGN**

**SECTION BC 1601**  
**GENERAL**

**1601.1 Scope.** The provisions of this chapter shall govern the structural design of buildings, structures and portions thereof regulated by this code.

**SECTION BC 1602**  
**DEFINITIONS**

**1602.1 Definitions.** The following words and terms shall, for the purposes of this code, have the meanings shown herein.

**ALLOWABLE STRESS DESIGN.** A method of proportioning structural members, such that elastically computed stresses produced in the members by nominal loads do not exceed specified allowable stresses (also called “working stress design”).

**BALCONY, EXTERIOR.** An exterior floor projecting from and supported by a structure without additional independent supports.

**BASE SHEAR.** Total design lateral force or shear at the base.

**BASIC SEISMIC-FORCE-RESISTING SYSTEMS.**

**Bearing wall system.** A structural system without a complete vertical load-carrying space frame. Bearing walls or bracing elements provide support for substantial vertical loads. Seismic lateral force resistance is provided by shear walls or braced frames.

**Building frame system.** A structural system with an essentially complete space frame providing support for vertical loads. Seismic lateral force resistance is provided by shear walls or braced frames.

**Dual system.** A structural system with an essentially complete space frame providing support for vertical loads. Seismic lateral force resistance is provided by a moment frame and shear walls or braced frames.

**Inverted pendulum system.** A structure with a large portion of its mass concentrated at the top; therefore, having essentially one degree of freedom in horizontal translation. Seismic lateral force resistance is provided by the columns acting as cantilevers.

**Moment-resisting frame system.** A structural system with an essentially complete space frame providing support for vertical loads. Seismic lateral force resistance is provided by moment frames.

**Shear wall-frame interactive system.** A structural system which uses combinations of shear walls and frames designed to resist seismic lateral forces in proportion to their rigidities, considering interaction between shear walls and frames on all levels. Support of vertical loads is provided by the same shear walls and frames.

**BOUNDARY MEMBERS.** Strengthened portions along shear wall and diaphragm edges (also called “boundary elements”).

**Boundary element.** In light-frame construction, diaphragms and shear wall boundary members to which sheathing transfers forces. Boundary elements include chords and drag struts at diaphragm and shear wall perimeters, interior openings, discontinuities and reentrant corners.

**CANTILEVERED COLUMN SYSTEM.** A structural system relying on column elements that cantilever from a fixed base and have minimal rotational resistance capacity at the top with lateral forces applied essentially at the top and are used for lateral resistance.

**COLLECTOR ELEMENTS.** Members that serve to transfer forces between floor diaphragms and members of the lateral-force-resisting system.

**CONFINED REGION.** The portion of a reinforced concrete component in which the concrete is confined by closely spaced special transverse reinforcement restraining the concrete in directions perpendicular to the applied stress.

**DEAD LOADS.** The weight of materials of construction incorporated into the building, including but not limited to walls, floors, roofs, ceilings, stairways, built-in partitions, finishes, cladding and other similarly incorporated architectural and structural items, and fixed service equipment, including the weight of cranes. All dead loads are considered permanent loads.

**DECK.** An exterior floor supported on at least two opposing sides by an adjacent structure, and/or posts, piers or other independent supports.

**DEFORMABILITY.** The ratio of the ultimate deformation to the limit deformation.

**High deformability element.** An element whose deformability is not less than 3.5 when subjected to four fully reversed cycles at the limit deformation.

**Limited deformability element.** An element that is neither a low deformability or a high deformability element.

**Low deformability element.** An element whose deformability is 1.5 or less.

**DEFORMATION.**

**Limited deformation.** Two times the initial deformation that occurs at a load equal to 40 percent of the maximum strength.

**Ultimate deformation.** The deformation at which failure occurs and which shall be deemed to occur if the sustainable load reduces to 80 percent or less of the maximum strength.

**DESIGN STRENGTH.** The product of the nominal strength and a resistance factor (or strength reduction factor).

**DIAPHRAGM.** A horizontal or sloped system acting to transmit lateral forces to the vertical-resisting elements. When the term “diaphragm” is used, it shall include horizontal bracing systems.

**Diaphragm, blocked.** In light-frame construction, a diaphragm in which all sheathing edges not occurring on a framing member are supported on and fastened to blocking.

**Diaphragm boundary.** In light-frame construction, a location where shear is transferred into or out of the diaphragm sheathing. Transfer is either to a boundary element or to another force-resisting element.

**Diaphragm chord.** A diaphragm boundary element perpendicular to the applied load that is assumed to take axial stresses due to the diaphragm moment.

**Diaphragm, flexible.** A diaphragm is flexible for the purpose of distribution of story shear and torsional moment when the computed maximum in-plane deflection of the diaphragm itself under lateral load is more than two times the average drift of adjoining vertical elements of the lateral-force-resisting system of the associated story under equivalent tributary lateral load (see Section 1617.5.3).

**Diaphragm, rigid.** A diaphragm is rigid for the purpose of distribution of story shear and torsional moment when the lateral deformation of the diaphragm is less than or equal to two times the average story drift.

**DURATION OF LOAD.** The period of continuous application of a given load, or the aggregate of periods of intermittent applications of the same load.

## **ELEMENT.**

**Ductile element.** An element capable of sustaining large cyclic deformations beyond the attainment of its nominal strength without any significant loss of strength.

**Limited ductile element.** An element that is capable of sustaining moderate cyclic deformations beyond the attainment of nominal strength without significant loss of strength.

**Nonductile element.** An element having a mode of failure that results in an abrupt loss of resistance when the element is deformed beyond the deformation corresponding to the development of its nominal strength. Nonductile elements cannot reliably sustain significant deformation beyond that attained at their nominal strength.

**EQUIPMENT SUPPORT.** Those structural members or assemblies of members or manufactured elements, including braces, frames, lugs, snuggers, hangers or saddles, that transmit gravity load and operating load between the equipment and the structure.

**ESSENTIAL FACILITIES.** Buildings and other structures that are intended to remain operational in the event of extreme environmental loading from flood, wind, snow or earthquakes.

**FACTORED LOAD.** The product of a nominal load and a load factor.

**FLEXIBLE EQUIPMENT CONNECTIONS.** Those connections between equipment components that permit rotational and/or translational movement without degradation of performance.

**FRAME.**

**Braced frame.** An essentially vertical truss, or its equivalent, of the concentric or eccentric type that is provided in a building frame system or dual system to resist lateral forces.

**Centrically braced frame (CBF).** A braced frame in which the members are subjected primarily to axial forces.

**Eccentrically braced frame (EBF).** A diagonally braced frame in which at least one end of each brace frames into a beam a short distance from a beam-column or from another diagonal brace.

**Ordinary concentrically braced frame (OCBF).** A steel concentrically braced frame in which members and connections are designed in accordance with the provisions of AISC Seismic without modification.

**Special concentrically braced frame (SCBF).** A steel or composite steel and concrete concentrically braced frame in which members and connections are designed for ductile behavior.

**Moment frame.** A frame in which members and joints resist lateral forces by flexure as well as along the axis of the members. Moment frames are categorized as “intermediate moment frames” (IMF), “ordinary moment frames” (OMF), and “special moment frames” (SMF).

**GUARD.** See Section 1002.1.

**IMPACT LOAD.** The load resulting from moving machinery, elevators, craneways, vehicles and other similar forces and kinetic loads, pressure and possible surcharge from fixed or moving loads.

**JOINT.** A portion of a column bounded by the highest and lowest surfaces of the other members

framing into it.

**LIMIT STATE.** A condition beyond which a structure or member becomes unfit for service and is judged to be no longer useful for its intended function (serviceability limit state) or to be unsafe (strength limit state).

**LIVE LOADS.** Those loads produced by the use and occupancy of the building or other structure and do not include construction or environmental loads such as wind load, snow load, rain load, earthquake load, flood load or dead load.

**LIVE LOADS (ROOF).** Those loads produced (1) during maintenance by workers, equipment and materials; and (2) during the life of the structure by movable objects such as planters and by people.

**LOAD AND RESISTANCE FACTOR DESIGN (LRFD).** A method of proportioning structural members and their connections using load and resistance factors such that no applicable limit state is reached when the structure is subjected to appropriate load combinations. The term “LRFD” is used in the design of steel and wood structures.

**LOAD FACTOR.** A factor that accounts for deviations of the actual load from the nominal load, for uncertainties in the analysis that transforms the load into a load effect, and for the probability that more than one extreme load will occur simultaneously.

**LOADS.** Forces or other actions that result from the weight of building materials, occupants and their possessions, environmental effects, differential movement and restrained dimensional changes. Permanent loads are those loads in which variations over time are rare or of small magnitude, such as dead loads. All other loads are variable loads (see also “Nominal loads”).

**LOADS EFFECTS.** Forces and deformations produced in structural members by the applied loads.

**NOMINAL LOADS.** The magnitudes of the loads specified in this chapter (dead, live, soil, wind, snow, rain, flood and earthquake).

## **NOTATIONS.**

$D$  = Dead load.

$E$  = Combined effect of horizontal and vertical earthquake-induced forces as defined in Sections 1616.4.1 and 1617.1.

$E_m$  = Maximum seismic load effect of horizontal and vertical seismic forces as set forth in Sections 1616.4.1 and 1617.1.

$F$  = Load due to fluids.

$F_a$  = Flood load.

$H$  = Load due to lateral pressure of soil and water in soil.

$L$  = Live load, except roof live load, including any permitted live load reduction.

$L_r$  = Roof live load including any permitted live load reduction.

$P$  = Ponding load.

$R$  = Rain load.

$S$  = Snow load.

$T$  = Self-straining force arising from contraction or expansion resulting from temperature change, shrinkage, moisture change, creep in component materials, movement due to differential settlement or combinations thereof.

$W$  = Load due to wind pressure.

**OTHER STRUCTURES.** Structures, other than buildings, for which loads are specified in this chapter.

**P-DELTA EFFECT.** The second order effect on shears, axial forces and moments of frame members induced by axial loads on a laterally displaced building frame.

**PANEL (PART OF A STRUCTURE).** The section of a floor, wall or roof comprised between the supporting frame of two adjacent rows of columns and girders or column bands of floor or roof construction.

**RESISTANCE FACTOR.** A factor that accounts for deviations of the actual strength from the nominal strength and the manner and consequences of failure (also called “strength reduction factor”).

**SHEAR PANEL.** A floor, roof or wall component sheathed to act as a shear wall or diaphragm.

**SHEAR WALL.** A wall designed to resist lateral forces parallel to the plane of the wall.

**SPACE FRAME.** A structure composed of interconnected members, other than bearing walls, that is capable of supporting vertical loads and that also may provide resistance to seismic lateral forces.

**SPECIAL TRANSVERSE REINFORCEMENT.** Reinforcement composed of spirals, closed stirrups or hoops and supplementary cross ties provided to restrain the concrete and qualify the portion of the component, where used, as a confined region.



**STRENGTH, NOMINAL.** The capacity of a structure or member to resist the effects of loads, as determined by computations using specified material strengths and dimensions and equations derived from accepted principles of structural mechanics or by field tests or laboratory tests of scaled models, allowing for modeling effects and differences between laboratory and field conditions.

**STRENGTH, REQUIRED.** Strength of a member, cross section or connection required to resist factored loads or related internal moments and forces in such combinations as stipulated by these provisions.

**STRENGTH DESIGN.** A method of proportioning structural members such that the computed forces produced in the members by factored loads do not exceed the member design strength. The term “strength design” is used in the design of concrete and masonry structural elements.

**WALL, LOAD BEARING.** Any wall meeting either of the following classifications:

1. Any metal or wood stud wall that supports more than 100 pounds per linear foot (plf) (1459 N/m) of vertical load in addition to its own weight.
2. Any masonry or concrete wall that supports more than 200 plf (2919 N/m) of vertical load in addition to its own weight.

**WALL, NONLOAD BEARING.** Any wall that is not a load-bearing wall.

### **SECTION BC 1603** **CONSTRUCTION DOCUMENTS**

**1603.1 General.** Construction documents shall show the size, section and relative locations of structural members with floor levels, column centers and offsets fully dimensioned. The design loads and other information pertinent to the structural design required by Sections 1603.1.1 through 1603.1.7 shall be clearly indicated on the construction documents for parts of the building or structure.

**Exception:** Construction documents for buildings constructed in accordance with the conventional light-frame construction provisions of Section 2308 shall indicate the following structural design information:

1. Floor and roof live loads.
2. Ground snow load,  $P_g$ .
3. Basic wind speed (3-second gust), miles per hour (mph) (km/hr) and wind exposure.
4. Seismic design category and site class.

**1603.1.1 Floor live load.** The uniformly distributed, concentrated and impact floor live load used in the design shall be indicated for floor areas. Live load reduction of the uniformly distributed floor live loads, if used in the design, shall be indicated.

**1603.1.2 Roof live load.** The roof live load used in the design shall be indicated for roof areas (Section 1607.11).

**1603.1.3 Roof snow load.** The ground snow load,  $P_g$ , shall be indicated. The following additional information shall also be provided, regardless of whether snow loads govern the design of the roof:

1. Flat-roof snow load,  $P_f$ .
2. Snow exposure factor,  $C_e$ .
3. Snow load importance factor,  $I_s$ .
4. Thermal factor,  $C_t$ .

**1603.1.4 Wind design data.** The following information related to wind loads shall be shown, regardless of whether wind loads govern the design of the lateral-force-resisting system of the building:

1. Basic wind speed (3-second gust), miles per hour (km/hr).
2. Wind importance factor,  $I_W$ , and building category.
3. Wind exposure, if more than one wind exposure is utilized, the wind exposure and applicable wind direction shall be indicated.
4. The applicable internal pressure coefficient.
5. Components and cladding. The design wind pressures in terms of psf ( $\text{kN}/\text{m}^2$ ) to be used for the design of exterior component and cladding materials not specifically designed by the registered design professional.

**1603.1.5 Earthquake design data.** The following information related to seismic loads shall be shown, regardless of whether seismic loads govern the design of the lateral-force-resisting system of the building:

1. Seismic importance factor,  $I_E$ , and seismic use group.
2. Mapped spectral response accelerations  $S_S$  and  $S_I$ .
3. Site class.

4. Spectral response coefficients  $S_{DS}$  and  $S_{D1}$ .
5. Seismic design category.
6. Basic seismic-force-resisting system(s).
7. Design base shear.
8. Seismic response coefficient(s),  $C_S$ .
9. Response modification factor(s),  $R$ .
10. Analysis procedure used.

**1603.1.6 Flood load.** For buildings located in areas of special flood hazard, construction documents shall comply with Appendix G.

**1603.1.7 Special loads.** Special loads that are applicable to the design of the building, structure or portions thereof shall be indicated along with the specified section of this code that addresses the special loading condition.

**1603.2 Restrictions on loading.** It shall be unlawful to place, or cause or permit to be placed, on any floor or roof of a building, structure or portion thereof, a load greater than is permitted by these requirements.

**1603.3 Live loads posted.** Where the live loads for which each floor or portion thereof of a building are or have been designed to exceed 50 psf (2.40 kN/m<sup>2</sup>), such design live loads shall be conspicuously posted by the owner in that part of each story in which they apply, using durable signs. It shall be unlawful to remove or deface such notices.

**Exceptions:** Residential occupancies.

**1603.3.1 Data required.** The following floor load data shall be shown on drawings:

1. The uniform distributed design live load for each floor or part thereof.
2. The weight of any piece of machinery or equipment weighing more than 1,000 pounds (4,400 N), and its identifying description and location. When this equipment includes oscillating or rotating components the description shall indicate the frequency of such movement.
3. The maximum design wheel load and total maximum weight of any vehicle that may be brought into the building.
4. The equivalent uniform partition loads or, in lieu of these, a statement to the effect that the design was predicated on actual partition loads.

**1603.4 Occupancy permits for changed loads.** Construction documents for other than residential buildings filed with the commissioner with applications for permits shall show on each drawing the live loads per square foot ( $m^2$ ) of area covered for which the building is designed. Occupancy permits for buildings hereafter erected shall not be issued until the floor load signs, required by Section 1603.3, have been installed.

## **SECTION 1604** **GENERAL DESIGN REQUIREMENTS**

**1604.1 General.** Building, structures and parts thereof shall be designed and constructed in accordance with strength design, load and resistance factor design, allowable stress design, empirical design or conventional construction methods, as permitted by the applicable material chapters.

**1604.2 Strength.** Buildings and other structures, and parts thereof, shall be designed and constructed to support safely the factored loads in load combinations defined in this code without exceeding the appropriate strength limit states for the materials of construction. Alternatively, buildings and other structures, and parts thereof, shall be designed and constructed to support safely the nominal loads in load combinations defined in this code without exceeding the appropriate specified allowable stresses for the materials of construction. Loads and forces for occupancies or uses not covered in this chapter shall be subject to the approval of the commissioner.

**1604.3 Serviceability.** Structural systems and members thereof shall be designed to have adequate stiffness to limit deflections and lateral drift. See Section 1617.3 for drift limits applicable to earthquake loading.

**1604.3.1 Deflections.** The deflections of structural members shall not exceed the more restrictive of the limitations of Sections 1604.3.2 through 1604.3.5 or that permitted by Table 1604.3.

**1604.3.2 Reinforced concrete.** The deflection of reinforced concrete structural members shall not exceed that permitted by ACI 318.

**1604.3.3 Steel.** The deflection of steel structural members shall not exceed that permitted by AISC LRFD, AISC HSS, AISC 335, AISI-NASPEC, AISI-General, AISI-Truss, ASCE 3, ASCE 8-SSD-LRFD/ASD, and the standard specifications of SJI Standard Specifications, Load Tables and Weight Tables for Steel Joists and Joist Girders as applicable.

**1604.3.4 Masonry.** The deflection of masonry structural members shall not exceed that permitted by ACI 530/ASCE 5/TMS 402.

**1604.3.5 Aluminum.** The deflection of aluminum structural members shall not exceed that permitted by AA-94.

**1604.3.6 Limits.** For limits on the deflection of structural members, refer to the relevant material design standards. Should a design standard not provide for deflection limits, deflection of structural members over span,  $l$ , shall not exceed that permitted by Table 1604.3.

**TABLE 1604.3**  
**DEFLECTION LIMITS<sup>a,b,c,h,i</sup>**  
**(Table 1604.3 attached to end of document)**

**1604.4 Analysis.** Load effects on structural members and their connections shall be determined by methods of structural analysis that take into account equilibrium, general stability, geometric compatibility and both short- and long-term material properties.

Members that tend to accumulate residual deformations under repeated service loads shall have included in their analysis the added eccentricities expected to occur during their service life. Secondary stresses in trusses shall be considered and, where of significant magnitude, their effects shall be provided for in the design.

Any system or method of construction to be used shall be based on a rational analysis in accordance with well-established principles of mechanics. Such analysis shall result in a system that provides a complete load path capable of transferring loads from their point of origin to the load-resisting elements.

The total lateral force shall be distributed to the various vertical elements of the lateral-force-resisting system in proportion to their rigidities considering the rigidity of the horizontal bracing system or diaphragm. Rigid elements that are assumed not to be a part of the lateral-force-resisting system shall be permitted to be incorporated into buildings provided that their effect on the action of the system is considered and provided for in design. Provisions shall be made for the increased forces induced on resisting elements of the structural system resulting from torsion due to eccentricity between the center of application of the lateral forces and the center of rigidity of the lateral-force-resisting system.

Every structure shall be designed to resist the overturning effects caused by the lateral forces specified in this chapter. See Section 1609 for wind, Section 1610 for lateral soil loads and Sections 1613 through 1623 for earthquake.

**1604.5 Importance factors.** The value for snow load, wind load and seismic load importance factors shall be determined in accordance with Table 1604.5.

**TABLE 1604.5**  
**CLASSIFICATION OF BUILDINGS AND OTHER STRUCTURES FOR IMPORTANCE**  
**FACTORS**  
**(Table 1604.5 attached to end of document)**

**1604.6 In-situ load tests.** The commissioner is authorized to require an engineering analysis or a load test, or both, of any construction whenever there is reason to question the safety of the

construction for the intended occupancy. Engineering analysis and load tests shall be conducted in accordance with Section 1713.

**1604.7 Preconstruction load tests.** Materials and methods of construction that are not capable of being designed by recognized engineering analysis or that do not comply with the applicable material design standards listed in Chapter 35, or alternative test procedures in accordance with Section 1711, shall be load tested in accordance with Section 1714.3.

### **1604.8 Anchorage.**

**1604.8.1 General.** Anchorage of the roof to walls and columns, and of walls and columns to foundations, shall be provided to resist the uplift and sliding forces that result from the application of the prescribed loads.

**1604.8.2 Concrete and masonry walls.** Concrete and masonry walls shall be anchored to floors, roofs and other structural elements that provide lateral support for the wall. Such anchorage shall provide a positive direct connection capable of resisting the horizontal forces specified in this chapter but not less than a minimum strength design horizontal force of 280 plf (4.10 kN/m) of wall, substituted for “E” in the load combinations of Section 1605.2 or 1605.3. Walls shall be designed to resist bending between anchors where the anchor spacing exceeds 4 feet (1219 mm). Required anchors in masonry walls of hollow units or cavity walls shall be embedded in a reinforced grouted structural element of the wall. See Sections 1609.6.2.2 and 1620 for wind and earthquake design requirements.

**1604.8.3 Decks.** Where supported by attachment to an exterior wall, decks shall be positively anchored to the primary structure and designed for both vertical and lateral loads as applicable. Such attachment shall not be accomplished by the use of toenails or nails subject to withdrawal. Where positive connection to the primary building structure cannot be verified during inspection, decks shall be self-supporting. For decks with cantilevered framing members, connections to exterior walls or other framing members shall be designed and constructed to resist uplift resulting from the full live load specified in Table 1607.1 acting on the cantilevered portion of the deck.

## **SECTION BC 1605** **LOAD COMBINATIONS**

**1605.1 General.** Buildings and other structures and portions thereof shall be designed to resist the load combinations specified in Section 1605.2 or 1605.3 and Chapters 18 through 23, and the special seismic load combinations of Section 1605.4. Applicable loads shall be considered, including both earthquake and wind, in accordance with the specified load combinations. Each load combination shall also be investigated with one or more of the variable loads set to zero.

### **1605.2 Load combinations using strength design or load and resistance factor design.**

**1605.2.1 Basic load combinations.** Where strength design or load and resistance factor design is used, structures and portions thereof shall resist the most critical effects from the

following combinations of factored loads:

**(Equation 16-1 attached to end of document)**

**(Equation 16-2 attached to end of document)**

**(Equation 16-3 attached to end of document)**

**Equation 16-4 attached to end of document)**

**(Equation 16-5 attached to end of document)**

**(Equation 16-6 attached to end of document)**

where:

$f_1 = 1.0$  for floors in places of public assembly, for live loads in excess of 100 pounds per square foot (4.79 kN/m<sup>2</sup>), and for parking garage live load.

$f_1 = 0.5$  for other live loads.

$f_2 = 0.7$  for roof configurations (such as saw tooth) that do not shed snow off the structure.

$f_2 = 0.2$  for other roof configurations.

**Exception:** Where other factored load combinations are specifically required by the provisions of this code, such combinations shall take precedence.

**1605.2.2 Other loads.** Where  $F$ ,  $H$ ,  $P$  or  $T$  is to be considered in design, each applicable load shall be added to the above combinations in accordance with Section 2.3.2 of ASCE 7. Where  $F_a$  is to be considered in design, the load combinations of Section 2.3.3 of ASCE 7 shall be used. Where ice loads are to be considered in design, the load combinations of Section 2.3.4 of ASCE 7 shall be used. Refer to the following sections for other loads:

<u>Soil lateral loads</u>	<u>Section 1610</u>
<u>Rain loads</u>	<u>Section 1611</u>
<u>Flood loads</u>	<u>Appendix G</u>
<u>Snow and Thermal loads</u>	<u>Section 1608</u>

### **1605.3 Load combinations using allowable stress design.**

**1605.3.1 Basic load combinations.** Where allowable stress design (working stress design), as permitted by this code, is used, structures and portions thereof shall resist the most critical effects resulting from the following combinations of loads:

**(Equations 16-7 through 16-12 attached to end of document)**

**Exceptions:**

1. Crane hook loads need not be combined with roof live load or with more than three-fourths of the snow load or one-half of the wind load.
2. Flat roof snow loads of 30 psf (1.44 kN/m<sup>2</sup>) or less need not be combined with seismic loads. Where flat roof snow loads exceed 30 psf (1.44 kN/m<sup>2</sup>), 20 percent shall be combined with seismic loads.
3. Where allowable stress design is used to design foundations, refer to Chapter 18 of this code for combinations of load effects.

**1605.3.1.1 Load reduction.** It is permitted to multiply the combined effect of two or more variable loads by 0.75 and add to the effect of dead load. The combined load used in design shall not be less than the sum of the effects of dead load and any one of the variable loads. The 0.7 factor on  $E$  does not apply for this provision. Increases in allowable stresses specified in the appropriate materials section of this code or referenced standard shall not be used with the load combinations of Section 1605.3.1 except that a duration of load increase shall be permitted in accordance with Chapter 23.

**1605.3.1.2 Other loads.** Where  $F$ ,  $H$ ,  $P$  or  $T$  are to be considered in design, the load combinations of Section 2.4.1 of ASCE 7 shall be used. Where  $F_a$  is to be considered in design, the load combinations of Section 2.4.2 of ASCE 7 shall be used. Where ice loads are to be considered in design, the load combinations of Section 2.4.3-of ASCE 7 shall be used. Refer to the following sections for other loads:

<u>Soil lateral loads</u>	<u>Section 1610</u>
<u>Rain loads</u>	<u>Section 1611</u>
<u>Flood loads</u>	<u>Appendix G</u>
<u>Snow and Thermal loads</u>	<u>Section 1608</u>

**1605.4 Special seismic load combinations.** For both allowable stress design and strength design methods, where specifically required by Sections 1613 through 1622 or by Chapters 18 through 23, elements and components shall be designed to resist the forces calculated using Equation 16-19 when the effects of the seismic ground motion are additive to gravity forces and those calculated using Equation 16-20 when the effects of the seismic ground motion counteract gravity forces.

**(Equation 16-19 attached to end of document)**

**(Equation 16-20 attached to end of document)**

where:

$E_m$  = The maximum effect of horizontal and vertical forces as set forth in Section 1617.1.

$f_l$  = 1.0 for floors in places of public assembly, for live loads in excess of 100 psf (4.79 kN/m<sup>2</sup>) and for parking garage live load.



$f_l$  = 0.5 for other live loads.

**1605.5 Heliports and helistops.** Heliport and helistop landing or touchdown areas shall be designed for the following loads, combined in accordance with Section 1605:

1. Dead load,  $D$ , plus the gross weight of the helicopter,  $D_h$ , plus snow load,  $S$ .
2. Dead load,  $D$ , plus two single concentrated impact loads,  $L$ , approximately 8 feet (2438 mm) apart applied anywhere on the touchdown pad (representing each of the helicopter's two main landing gear, whether skid type or wheeled type), having a magnitude of 0.75 times the gross weight of the helicopter. Both loads acting together total 1.5 times the gross weight of the helicopter.
3. Dead load,  $D$ , plus a uniform live load,  $L$ , of 100 psf (4.79 kN/ m<sup>2</sup>).

**1605.6 Structural integrity load combinations – alternate load path method.** Where specifically required by Sections 1624 through 1629, elements and components shall be designed to resist the forces calculated using the following combination of factored loads:

**(Equation 16-65 attached to end of document)**

**1605.7 Structural integrity load combinations – vehicular impact and gas explosions.** Where specifically required by Sections 1625.5 and 1625.6, elements and components shall be designed to resist the forces calculated using the following combination of factored loads:

**(Equation 16-66 attached to end of document)**

**(Equation 16-67 attached to end of document)**

**1605.8 Structural integrity load combinations – specific local resistance method.** Where the specific local resistance method is used in a key element analysis, the specified local loads shall be used as specified in Section 1626.7.

## **SECTION BC 1606** **DEAD LOADS**

**1606.1 Weights of materials and construction.** In determining dead loads for purposes of design, the actual weights of materials and construction shall be used. In the absence of definite information, values used shall be subject to the approval of the commissioner.

**1606.2 Weights of fixed service equipment.** In determining dead loads for purposes of design, the weight of fixed service equipment, such as plumbing stacks and risers, electrical feeders, heating, ventilating and air-conditioning systems (HVAC) and fire sprinkler systems, shall be included.

## **SECTION BC 1607**

## LIVE LOADS

1607.1 General. Live loads are those defined in Section 1602.1

TABLE 1607.1  
MINIMUM UNIFORMLY DISTRIBUTED LIVE LOADS AND MINIMUM  
CONCENTRATED LIVE LOADS<sup>g</sup>  
(Table 1607.1 attached to end of document)

1607.2 Loads not specified. For occupancies or uses not designated in Table 1607.1, the live load shall be determined in accordance with a method approved by the commissioner.

1607.2.1 Stage areas using scenery or scenic elements. Scenery battens and suspension systems shall be designed for a load of thirty pounds per linear foot of batten length. Loft block and head block beams shall be designed to support vertical and horizontal loads corresponding to a 4 inch (102 mm) spacing of battens for the entire depth of the gridiron. Direction and magnitude of total forces shall be determined from the geometry of the rigging system including load concentrations from spot line rigging. Locking rails shall be designed for a uniform uplift of 500 psf (3447 kN/m<sup>2</sup>) with a 1,000 pound (454 kg) concentration. Impact factor for batten design shall be 75 percent and for loft and head block beams shall be 25 percent. A plan drawn to a scale not less than ¼ inch (6.4 mm) equals one foot (305 mm) shall be displayed in the stage area indicating the framing plan of the rigging loft and the design loads for all members used to support scenery or rigging. Gridirons over stages shall be designed to support a uniformly distributed live load of 50 psf (2.40 kN/m<sup>2</sup>) in addition to the rigging loads indicated.

1607.3 Uniform live loads. The live loads used in the design of buildings and other structures shall be the maximum loads expected by the intended use or occupancy but shall in no case be less than the minimum uniformly distributed unit loads required by Table 1607.1.

1607.4 Concentrated loads. Floors and other similar surfaces shall be designed to support the uniformly distributed live loads prescribed in Section 1607.3 or the concentrated load, in pounds (kilonewtons), given in Table 1607.1, whichever produces the greater load effects. Unless otherwise specified, the indicated concentration shall be assumed to be uniformly distributed over an area 2.5 feet by 2.5 feet [6.25 ft<sup>2</sup> (0.58 m<sup>2</sup>)] and shall be located so as to produce the maximum load effects in the structural members.

TABLE 1607.5  
EQUIVALENT UNIFORM PARTITION LOADS  
(Table 1607.5 attached to end of document)

1607.5 Partition loads. Weights of all partitions shall be considered, using either actual weights at locations shown on the plans or the equivalent uniform load given in Section 1607.5.2. Partition loads shall be taken as superimposed dead loads.

**1607.5.1 Actual loads.** Where actual partition weights are used, the uniform design live load may be omitted from the strip of floor area under each partition.

**1607.5.2 Equivalent uniform load.** The equivalent uniform partition loads in Table 1607.5 may be used in lieu of actual partition weights except for bearing partitions or partitions in toilet room areas (other than in one- and two-family dwellings), at stairs and elevators, and similar areas where partitions are concentrated. In such cases, actual partition weights shall be used in design. Except as otherwise exempted, equivalent uniform partition loads shall be used in areas where partitions are not definitely located on the plans, or in areas where partitions are subject to rearrangement or relocation

**TABLE 1607.5**  
**EQUIVALENT UNIFORM PARTITION LOADS**  
**(Table 1607.5 attached to end of document)**

**1607.6 Garages.**

**1607.6.1 Passenger vehicle garages.** Areas used for, and restricted by physical limitations of clearance to, the transit or parking of passenger vehicles shall be designed for the uniformly distributed and concentrated loads for parking areas for such vehicles as provided in Table 1607.1 applied without impact. An exception is made for members or constructions which, because of physical limitations, cannot be subjected to direct load from the vehicle or from a jack or hoist used to raise or suspend the vehicle. Such members or constructions shall be designed for the loads corresponding to the actual usage.

**1607.6.2 Truck and bus garages.** Minimum live loads for garages having trucks or buses shall be as specified in Table 1607.6, but shall not be less than 50 psf (2.40 kN/m<sup>2</sup>), unless other loads are specifically justified and approved by the commissioner. Actual loads shall be used where they are greater than the loads specified in the table.

**TABLE 1607.6**  
**UNIFORM AND CONCENTRATED LOADS**  
**(Table 1607.6 attached to end of document)**

**1607.6.2.1 Truck and bus garage live load application.** The concentrated load and uniform load shall be uniformly distributed over a 10 foot (3048 mm) width on a line normal to the centerline of the lane placed within a 12-foot-wide (3658 mm) lane. The loads shall be placed within their individual lanes so as to produce the maximum stress in each structural member. Vertical impact shall be taken as 10 percent of the vertical load. Single spans shall be designed for the uniform load in Table 1607.6 and one simultaneous concentrated load positioned to produce the maximum effect. Multiple spans shall be designed for the uniform load in Table 1607.6 on the spans and two simultaneous concentrated loads in two spans positioned to produce the maximum negative moment effect. Multiple span design loads, for other effects, shall be the same as for single spans.

**1607.7 Loads on handrails, guards, grab bars and vehicle barriers.** Handrails, guards, grab

bars designed in accordance with Chapter 11, and vehicle barriers shall be designed and constructed to the structural loading conditions set forth in this section.

**1607.7.1 Handrails and guards.** Handrail assemblies and guards shall be designed to resist a load of 50 plf (0.73 kN/m) applied in any direction at the top and to transfer this load through the supports to the structure.

**Exceptions:**

1. For one- and two-family dwellings, only the single, concentrated load required by Section 1607.7.1.1 shall be applied.
2. In Group I-3, F, H, and S occupancies, for areas that are not accessible to the general public and that have an occupant load no greater than 50, the minimum load shall be 20 pounds per foot (0.29 kN/m).

**1607.7.1.1 Concentrated load.** Handrail assemblies and guards shall be able to resist a single concentrated load of 200 pounds (0.89 kN), applied in any direction at any point along the top, and have attachment devices and supporting structure to transfer this loading to appropriate structural elements of the building. This load need not be assumed to act concurrently with the loads specified in the preceding paragraph.

**1607.7.1.2 Components.** Intermediate rails (all those except the handrail), balusters and panel fillers shall be designed to withstand a horizontally applied normal load of 50 pounds (0.22 kN) on an area equal to 1 square foot (0.09 m<sup>2</sup>), including openings and space between rails. Reactions due to this loading are not required to be superimposed with those of Section 1607.7.1 or 1607.7.1.1.

**1607.7.1.3 Stress increase.** Where handrails and guards are designed in accordance with the provisions for allowable stress design (working stress design) exclusively for the loads specified in Section 1607.7.1, the allowable stress for the members and their attachments are permitted to be increased by one-third.

**1607.7.2 Grab bars, shower seats and dressing room bench seats.** Grab bars, shower seats and dressing room bench seat systems shall be designed to resist a single concentrated load of 250 pounds (1.11 kN) applied in any direction at any point.

**1607.7.3 Vehicle barriers.** Vehicle barrier systems for passenger cars shall be designed to resist a single load of 6,000 pounds (26.70 kN) applied horizontally in any direction to the barrier system and shall have anchorage or attachment capable of transmitting this load to the structure. For design of the system, the load shall be assumed to act at a minimum height of 1 foot, 6 inches (457 mm) above the floor or ramp surface on an area not to exceed 1 square foot (0.09 m<sup>2</sup>), and is not required to be assumed to act concurrently with any handrail or guard loadings specified in the preceding paragraphs of Section 1607.7.1. Garages accommodating trucks and buses shall be designed in accordance with a recognized method acceptable to the commissioner that contains provision for traffic railings.

**1607.7.3.1 Columns in parking areas.** Unless specially protected, columns in parking areas subject to impact of moving vehicles shall be designed to resist the lateral load due to impact and this load shall be considered a variable load. For passenger vehicles, this lateral load shall be taken as a minimum of 6,000 pounds (26.70 kN) applied at least 1 foot 6 inches (457 mm); above the roadway, and acting simultaneously with other design loads.

**1607.8 Impact loads.** The live loads specified in Section 1607.2 include allowance for impact conditions. Provisions shall be made in the structural design for uses and loads that involve unusual vibration and impact forces.

**1607.8.1 Elevators.** Elevator loads shall be increased by 100 percent for impact and the structural supports shall be designed within the limits of stress and deflection prescribed by ASME A17.1.

**1607.8.2 Machinery.** For the purpose of design, the weight of machinery and moving loads shall be increased as follows to allow for impact: (1) elevator machinery, 100 percent; (2) light machinery, shaft- or motor-driven, 20 percent; (3) reciprocating machinery or power-driven units, 50 percent; (4) hangers for floors or balconies, 33 percent. Percentages shall be increased where specified by the manufacturer.

**1607.8.3 Railroad equipment.** Minimum loads (including vertical, lateral, longitudinal, and impact) and the distribution thereof shall meet the applicable requirements of the AREMA Manual for Railway Engineering Chapter 15, Steel Structures.

**1607.8.4 Assembly structures.** Seating areas in grandstands, stadiums, and similar assembly structures shall be designed to resist the simultaneous application of a horizontal swaying load of at least 24 plf (36 kg/m) of seats applied in a direction parallel to the row of the seats, and of at least 10 plf (15 kg/m) of seats in a direction perpendicular to the row of the seats. When this load is used in combination with wind for outdoor structures, the wind load shall be one-half of the design wind load.

**1607.9 Reduction in live loads.** The minimum uniformly distributed live loads,  $L_o$ , in Table 1607.1 are permitted to be reduced according to the following provisions.

**1607.9.1 General.** Subject to the limitations of Sections 1607.9.1.1 through 1607.9.1.4, members for which a value of  $K_{LL} A_T$  is 400 square feet (37.16 m<sup>2</sup>) or more are permitted to be designed for a reduced live load in accordance with the following equation:

**(Equation 16-21 attached to end of document)**

where:

$L$  = Reduced design live load per square foot (meter) of area supported by the member.

$L_o$  = Unreduced design live load per square foot (meter) of area supported by the member (see Table 1607.1).

$K_{LL}$  = Live load element factor (see Table 1607.9.1).

$A_T$  = Tributary area, in square feet (square meters).  $L$  shall not be less than  $0.50L_o$  for members supporting one floor and  $L$  shall not be less than  $0.40L_o$  for members supporting two or more floors.

**TABLE 1607.9.1**  
**LIVE LOAD ELEMENT FACTOR,  $K_{LL}$**   
**(Table 1607.9.1 attached to end of document)**

**1607.9.1.1 Heavy live loads.** Live loads that exceed 100 psf (4.79 kN/m<sup>2</sup>) shall not be reduced except the live loads for members supporting two or more floors are permitted to be reduced by a maximum of 20 percent, but the live load shall not be less than  $L$  as calculated in Section 1607.9.1.

**1607.9.1.2 Passenger vehicle garages.** The live loads shall not be reduced in passenger vehicle garages except the live loads for members supporting two or more floors are permitted to be reduced by a maximum of 20 percent, but the live load shall not be less than  $L$  as calculated in Section 1607.9.1.

**1607.9.1.3 Special occupancies.** Live loads of 100 psf (4.79 kN/m<sup>2</sup>) or less shall not be reduced in public assembly occupancies or in areas used for retail or wholesale sales.

**1607.9.1.4 Special structural elements.** Live loads shall not be reduced for one-way slabs except as permitted in Section 1607.9.1.1. Live loads shall not be reduced for calculating shear stresses at the heads of columns in flat slab or flat plate construction. Live loads of 100 psf (4.79 kN/m<sup>2</sup>) or less shall not be reduced for roof members except as specified in Section 1607.11.2.

**1607.9.2 Alternate floor live load reduction.** As an alternative to Section 1607.9.1, floor live loads are permitted to be reduced in accordance with the following provisions. Such reductions shall apply to slab systems, beams, girders, columns, piers, walls and foundations.

1. A reduction shall not be permitted in Group A occupancies.
2. A reduction shall not be permitted when the live load exceeds 100 psf (4.79 kN/m<sup>2</sup>) except that the design live load for columns may be reduced by 20 percent.
3. For live loads not exceeding 100 psf (4.79 kN/m<sup>2</sup>), the design live load for any structural member supporting 150 square feet (13.94 m<sup>2</sup>) or more is permitted to be reduced in accordance with the following equation:

**(Equation 16-22 attached to end of document)**

Such reduction shall not exceed 40 percent for horizontal members, 60 percent for vertical members, nor  $R$  as determined by the following equation:

**(Equation 16-23 attached to end of document)**

**1607.10 Distribution of floor loads.** Where uniform floor live loads are involved in the design of structural members arranged so as to create continuity, the minimum applied loads shall be the full dead loads on all spans in combination with the floor live loads on spans selected to produce the greatest effect at each location under consideration. It shall be permitted to reduce floor live loads in accordance with Section 1607.9.

**1607.11 Roof loads.** The structural supports of roofs and marquees shall be designed to resist wind and, where applicable, snow and earthquake loads, in addition to the dead load of construction and the appropriate live loads as prescribed in this section, or as set forth in Table 1607.1. The live loads acting on a sloping surface shall be assumed to act vertically on the horizontal projection of that surface.

**1607.11.1 Distribution of roof loads.** Where uniform roof live loads are involved in the design of structural members arranged so as to create continuity, the minimum applied loads shall be the full dead loads on all spans in combination with the roof live loads on adjacent spans or on alternate spans, whichever produces the greatest effect. See Section 1607.11.2 for minimum roof live loads and Section 1608.5 for partial snow loading.

**1607.11.1.1 Arches and gabled frames.** The following simplification is permissible:

1. Live load placed on  $\frac{1}{2}$  of the span adjacent to one support.
2. Live load placed on the center  $\frac{1}{4}$  of the span.
3. Live load placed on  $\frac{3}{8}$  of the span adjacent to each support.

**1607.11.2 Minimum roof live loads.** Minimum roof loads shall be determined for the specific conditions in accordance with Sections 1607.11.2.1 through 1607.11.2.4.

**1607.11.2.1 Flat, pitched and curved roofs.** Ordinary flat, pitched and curved roofs shall be designed for the live loads specified in the following equation or other controlling combinations of loads in Section 1605, whichever produces the greater load. In structures where special scaffolding is used as a work surface for workers and materials during maintenance and repair operations, a lower roof load than specified in the following equation shall not be used unless approved by the commissioner. Greenhouses shall be designed for a minimum roof live load of 10 psf (0.479 kN/m<sup>2</sup>).

**(Equations 16-24 attached to end of document)**

where:  $12 \leq L_r \leq 20$

For SI:  $L_r = 0.96 R_1 R_2$

where:  $0.58 \leq L_r \leq 0.96$

$L_r$  = Roof live load per square foot ( $m^2$ ) of horizontal projection in pounds per square foot ( $kN/m^2$ ).

**(Equations 16-25 through 16-27 attached to end of document)**

where:

$A_t$  = Tributary area (span length multiplied by effective width) in square feet ( $m^2$ ) supported by any structural member, and

$F$  = for a sloped roof, the number of inches of rise per foot (for SI:  $F = 0.12 \times$  slope, with slope expressed in percentage points), and

$F$  = for an arch or dome, rise-to-span ratio multiplied by 32, and

**(Equations 16-28 through 16-30 attached to end of document)**

**1607.11.2.2 Special-purpose roofs.** Roofs used for promenade purposes shall be designed for a minimum live load of 60 psf ( $2.87 kN/m^2$ ). Roofs used for roof gardens or assembly purposes shall be designed for a minimum live load of 100 psf ( $4.79 kN/m^2$ ). Roofs used for other special purposes shall be designed for appropriate loads, as directed or approved by the commissioner.

**1607.11.2.3 Green roofs.** Where roofs utilize a green roof system and are not intended for human occupancy, the uniform design live load in the area covered by the green roof shall be 20 psf ( $0.958 kN/m^2$ ). The weight of the landscaping materials shall be considered as dead load and shall be computed on the basis of saturation of the soil. Where roofs utilize a green roof system and are used for human occupancy, the minimum live load shall be as specified in Table 1607.1 or Section 1607.11.2.2, whichever is greater.

**1607.11.2.4 Awnings and canopies.** Awnings and canopies shall be designed for a uniform live load of 5 psf ( $0.240 kN/m^2$ ) as well as for snow loads and wind loads as specified in Sections 1608 and 1609.

**1607.11.2.5 Hanging loads.** Girders and roof trusses (other than joists) over garage areas regularly utilized for the repair of vehicles and over manufacturing floors or storage floors used for commercial purposes shall be capable of supporting, in addition to the specified live and wind loads, a concentrated live load of 2,000 pounds (908 kg) applied



at any lower chord panel point for trusses, and at any point of the lower flange for girders.

**1607.12 Crane loads.** The crane live load shall be the rated capacity of the crane. Design loads for the runway beams, including connections and support brackets, of moving bridge cranes and monorail cranes shall include the maximum wheel loads of the crane and the vertical impact, lateral and longitudinal forces induced by the moving crane.

**1607.12.1 Maximum wheel load.** The maximum wheel loads shall be the wheel loads produced by the weight of the bridge, as applicable, plus the sum of the rated capacity and the weight of the trolley with the trolley positioned on its runway at the location where the resulting load effect is maximum.

**1607.12.2 Vertical impact force.** The maximum wheel loads of the crane shall be increased by the percentages shown below to determine the induced vertical impact or vibration force:

Monorail cranes (powered).....25 percent

Cab-operated or remotely operated bridge cranes (powered).....25 percent

Pendant-operated bridge cranes (powered).....10 percent

Bridge cranes or monorail cranes with hand-gear bridge, trolley and hoist percent.....0 percent

**1607.12.3 Lateral force.** The lateral force on crane runway beams with electrically powered trolleys shall be calculated as 20 percent of the sum of the rated capacity of the crane and the weight of the hoist and trolley. The lateral force shall be assumed to act horizontally at the traction surface of a runway beam, in either direction perpendicular to the beam, and shall be distributed according to the lateral stiffness of the runway beam and supporting structure.

**1607.12.4 Longitudinal force.** The longitudinal force on crane runway beams, except for bridge cranes with hand-gear bridges, shall be calculated as 10 percent of the maximum wheel loads of the crane. The longitudinal force shall be assumed to act horizontally at the traction surface of a runway beam, in either direction parallel to the beam.

**1607.13 Interior walls and partitions.** Interior walls and partitions that exceed 6 feet (1829 mm) in height, including their finish materials, shall have adequate strength to resist the loads to which they are subjected but not less than a horizontal load of 5 psf (0.240 kN/ m<sup>2</sup>).

**SECTION BC 1608**  
**SNOW LOADS AND THERMAL LOADS**

**1608.1 General.** Design snow loads shall be determined in accordance with Section 7 of ASCE 7, but the design roof load shall not be less than that determined by Section 1607.

**1608.2 Ground snow loads.** The ground snow load,  $P_g$ , to be used in determining the design snow loads for roofs is 25 psf (1.2 kN/m<sup>2</sup>).

**1608.3 Flat roof snow loads.** The flat roof snow load,  $\rho_f$ , on a roof with a slope equal to or less than 5 degrees (0.09 rad) (1 inch per foot = 4.76 degrees) shall be calculated in accordance with Section 7.3 of ASCE 7.

**1608.3.1 Exposure factor.** The value for the snow exposure factor,  $C_e$ , used in the calculation of  $\rho_f$  shall be determined from Table 1608.3.1.

**TABLE 1608.3.1**  
**SNOW EXPOSURE FACTOR  $C_e$**   
**(Table 1608.3.1 attached to end of document)**

**1608.3.2 Thermal factor.** The value for the thermal factor,  $C_t$ , used in the calculation of  $\rho_f$  shall be determined from Table 1608.3.2.

**TABLE 1608.3.2**  
**THERMAL FACTOR,  $C_t$**   
**(Table 1608.3.2 attached to end of document)**

**1608.3.3 Snow load importance factor.** The value for the snow load importance factor,  $I_s$ , used in the calculation of  $\rho_f$  shall be determined in accordance with Table 1604.5. Greenhouses that are occupied for growing plants on production or research basis, without public access, shall be included in Importance Category I.

**1608.3.4 Rain-on-snow surcharge load.** Roofs with a slope less than ½ inch per foot (2.38 degrees) shall be designed for a rain-on-snow surcharge load determined in accordance with Section 7.10 of ASCE 7.

**1608.3.5 Ponding instability.** For roofs with a slope less than ¼ inch per foot (1.19 degrees), the design calculations shall include verification of the prevention of ponding instability in accordance with Section 7.11 of ASCE 7.

**1608.3.6 Ice.** For ice loads to be used in the design of ice sensitive structures such as open framed or guyed towers refer to ASCE 7.

**1608.4 Sloped roof snow loads.** The snow load,  $p_s$ , on a roof with a slope greater than 5 degrees (0.09 rad) (1 inch per foot = 4.76 degrees) shall be calculated in accordance with Section 7.4 of ASCE 7.

**1608.5 Partial loading.** The effect of not having the balanced snow load over the entire loaded roof area shall be analyzed in accordance with Section 7.5 of ASCE 7.

**1608.6 Unbalanced snow loads.** Unbalanced roof snow loads shall be determined in accordance with Section 7.6 of ASCE 7. Winds from all directions shall be accounted for when establishing

unbalanced snow loads.

**1608.7 Drifts on lower roofs.** In areas where the ground snow load,  $p_g$ , as determined by Section 1608.2, is equal to or greater than 5 psf (0.240 kN/ m<sup>2</sup>), roofs shall be designed to sustain localized loads from snowdrifts in accordance with Section 7.7 of ASCE 7.

**1608.8 Roof projections.** Drift loads due to mechanical equipment, penthouses, parapets and other projections above the roof shall be determined in accordance with Section 7.8 of ASCE 7.

**1608.9 Sliding snow.** The extra load caused by snow sliding off a sloped roof onto a lower roof shall be determined in accordance with Section 7.9 of ASCE 7.

**1608.10 Thermal forces.** The design of enclosed buildings more than 250 feet (76 200 mm) in plan dimension shall provide for the forces and/or movements resulting from an assumed expansion corresponding to a change in temperature of 40°F (4.44°C). For exterior exposed frames, arches, or shells regardless of plan dimensions, the design shall provide for the forces and/or movements resulting from an assumed expansion and contraction corresponding to an increase or decrease in temperature of 40°F (4.44°C) for concrete or masonry construction and 60°F (15.55°C) for metal construction. For determination of the required anchorage for piping, the forces shall be determined on the basis of temperature variations for the specific service conditions. Friction forces in expansion bearings shall be considered.

## **SECTION BC 1609** **WIND LOADS**

**1609.1 Applications.** Buildings, structures and parts thereof shall be designed to withstand the minimum wind loads prescribed herein. Decreases in wind loads shall not be made for the effect of shielding by other structures.

**1609.1.1 Determination of wind loads.** Wind loads on every building or structure shall be determined in accordance with Section 6 of ASCE 7. Wind shall be assumed to come from any horizontal direction and wind pressures shall be assumed to act normal to the surface considered. Exposure-A as defined in section 1609.4 can be considered using ASCE 7 where applicable.

### **Exceptions:**

1. Wind loads determined by the provisions of Section 1609.6.
2. Subject to the limitations of Section 1609.1.1.1, the provisions of *SBCCI SSTD 10 Standard for Hurricane Resistant Residential Construction* shall be permitted for applicable Group R2 and R3 buildings.
3. Subject to the limitations of Section 1609.1.1.1, residential structures using the provisions of the *AF&PA Wood Frame Construction Manual for One-and Two-Family Dwellings*.

4. Designs using NAAMM FP 1001 Guide Specification for Design of Metal Flagpoles.

5. Designs using TIA/EIA-222 for antenna-supporting structures and antennas.

**1609.1.1.1 Applicability.** The provisions of SSTD10 are applicable only to buildings located within Exposure, B or C as defined in Section 1609.4. The provisions of SSTD 10 and the AF&PA Wood Frame construction Manual for One- and Two-Family Dwellings shall not apply to buildings sited on the upper half of an isolated hill, ridge or escarpment meeting the following conditions:

1. The hill, ridge or escarpment is 60 feet (18 288 mm) or higher if located in Exposure B or 30 feet (9144 mm) or higher if located in Exposure C;
2. The maximum average slope of the hill exceeds 10 percent; and
3. The hill, ridge or escarpment is unobstructed upwind by other such topographic features for a distance from the high point of 50 times the height of the hill or 1 mile (1.61 km), whichever is greater.

**1609.1.2 Minimum wind loads.** The wind loads used in the design of the main wind-force-resisting system shall not be less than 20 psf (0.958 kN/m<sup>2</sup>) multiplied by the area of the building or structure projected on a vertical plane normal to the wind direction. In the calculation of design wind loads for components and cladding for buildings, the algebraic sum of the pressures acting on opposite faces shall be taken into account. The design pressure for components and cladding of buildings shall not be less than 20 psf (0.958 kN/m<sup>2</sup>) acting in either direction normal to the surface. The design force for open buildings and other structures shall not be less than 10 psf (0.479 kN/ m<sup>2</sup>) multiplied by the area  $A_f$ .

**1609.1.3 Anchorage against overturning, uplift and sliding.** Structural members and systems and components and cladding in a building or structure shall be anchored to resist wind-induced overturning, uplift and sliding and to provide continuous load paths for these forces to the foundation. Where a portion of the resistance to these forces is provided by dead load, the dead load, including the weight of soils and foundations, shall be taken as the minimum dead load likely to be in place during a design wind event. Where the alternate basic load combinations of Section 1605.3.2 are used, only two-thirds of the minimum dead load likely to be in place during a design wind event shall be used.

**1609.1.4 Wind and seismic detailing.** Lateral-force-resisting systems shall meet seismic detailing requirements and limitations prescribed in this code, even when wind code prescribed load effects are greater than seismic load effects.

**1609.2 Definitions.** The following words and terms shall, for the purposes of Section 1609.6, have the meanings shown herein.

**BUILDINGS AND OTHER STRUCTURES, FLEXIBLE.** Buildings and other structures that have a fundamental natural frequency less than 1 Hz.

**BUILDING, ENCLOSED.** A building that does not comply with the requirements for open or partially enclosed buildings.

**BUILDING, LOW-RISE.** Enclosed or partially enclosed buildings that comply with the following conditions:

1. Mean roof height,  $h$ , less than or equal to 60 feet (18 288 mm).
2. Mean roof height,  $h$ , does not exceed least horizontal dimension.

**BUILDING, OPEN.** A building having each wall at least 80 percent open. This condition is expressed for each wall by the equation:

**(Equation 16-31 attached to end of document)**

**BUILDING, PARTIALLY ENCLOSED.** A building that complies with both of the following conditions:

1. The total area of openings in a wall that receives positive external pressure exceeds the sum of the areas of openings in the balance of the building envelope (walls and roof) by more than 10 percent; and
2. The total area of openings in a wall that receives positive external pressure exceeds 4 square feet (0.37 m<sup>2</sup>) or 1 percent of the area of that wall, whichever is smaller, and the percentage of openings in the balance of the building envelope does not exceed 20 percent. These conditions are expressed by the following equations:

**(Equation 16-32 attached to end of document)**

**(Equation 16-33 attached to end of document)**

where:

$A_o$ ,  $A_g$  are as defined for an open building.

$A_{oi}$  = The sum of the areas of openings in the building envelope (walls and roof) not including  $A_o$ , in square feet (m<sup>2</sup>).

$A_{gi}$  = The sum of the gross surface areas of the building envelope (walls and roof) not including  $A_g$ , in square feet (m<sup>2</sup>).

**BUILDING, SIMPLE DIAPHRAGM.** A building in which wind loads are transmitted through floor and roof diaphragms to the vertical lateral-force-resisting systems.

**COMPONENTS AND CLADDING.** Elements of the building envelope that do not qualify as part of the main wind force-resisting system.

**EFFECTIVE WIND AREA.** The area used to determine  $GC_p$ . For component and cladding elements, the effective wind area in Tables 1609.6.2.1(2) and 1609.6.2.1(3) is the span length multiplied by an effective width that need not be less than one-third the span length. For cladding fasteners, the effective wind area shall not be greater than the area that is tributary to an individual fastener.

**HURRICANE-PRONE REGIONS.** New York City is within the hurricane prone region.

**IMPORTANCE FACTOR,  $I$ .** A factor that accounts for the degree of hazard to human life and damage to property.

**MAIN WIND FORCE-RESISTING SYSTEM.** An assemblage of structural elements assigned to provide support and stability for the overall structure. The system generally receives wind loading from more than one surface.

**MEAN ROOF HEIGHT.** The average of the roof eave height and the height to the highest point on the roof surface, except that eave height shall be used for roof angle of less than or equal to 10 degrees (0.1745 rad).

**WIND-BORNE DEBRIS REGION.** New York City is not in the Wind-Borne Debris Region.

**1609.3 Basic wind speed.** The basic wind speed for New York City which is measured at 33 feet (10 058 mm) above ground as 3-second gust speed is 98 mph (43.8 m/s). This wind speed is based on local wind climate with annual probability of 0.02 (50-year mean recurrence interval).

**1609.3.1 Wind speed conversion.** When required, the 3-second gust wind velocity of 98 mph (43.12 m/s) can be converted to 79 mph (35.2 m/s) fastest mile wind velocity.

**1609.4 Exposure category.** For each wind direction considered, an exposure category that adequately reflects the characteristics of ground surface irregularities shall be determined for the site at which the building or structure is to be constructed. For a site located in the transition zone between categories, the category resulting in the largest wind forces shall apply. Account shall be taken of variations in ground surface roughness that arise from natural topography and vegetation as well as from constructed features. For any given wind direction, the exposure in which a specific building or other structure is sited shall be assessed as being one of the following categories. When applying the simplified wind load method of Section 1609.6, a single exposure category shall be used based upon the most restrictive for any given wind direction.

1. Exposure A. Large city centers with at least 50 percent of the buildings having a height in excess of 70 feet (21 366 mm). Use of this exposure category shall be limited to those areas for which terrain representative of Exposure A prevails in the upwind direction for a distance of at least 2,500 feet (762 m) or 10 times the height of the building or structure,

whichever is greater. Possible channeling effects or increased velocity pressures due to the building or structure being located in the wake of adjacent buildings shall be taken into account. See Table 1609.4.1-a and Table 1609.4.1-b for terrain and pressure coefficients related to Exposure-A.

**TABLE 1609.4.1 –a**  
**TERRAIN EXPOSURE CONSTANTS**  
**(Table 1609.4.1-a attached to end of document)**

**TABLE 1609.4.1-b**  
**VELOCITY PRESSURE EXPOSURE COEFFICIENTS,  $K_h$  AND  $K$**   
**(Table 1609.4.1-b attached to end of document)**

2. Exposure B. Urban and suburban areas, wooded areas or other terrain with numerous closely spaced obstructions having the size of single-family dwellings or larger. Exposure B shall be assumed unless the site meets the definition of another type of exposure.
3. Exposure C. Open terrain with scattered obstructions, including surface undulations or other irregularities, having heights generally less than 30 feet (9144 mm) extending more than 1,500 feet (457.2 m) from the building site in any quadrant. This exposure shall also apply to any building located within Exposure B-type terrain where the building is directly adjacent to open areas of Exposure C-type terrain in any quadrant for a distance of more than 600 feet (182.9 m). This category includes flat open country, grasslands and shorelines in hurricane-prone regions.
4. Exposure D. Not applicable in New York City.

**1609.5 Importance factor.** Buildings and other structures shall be assigned a wind load importance factor,  $I_w$ , in accordance with Table 1604.5.

**1609.6 Simplified wind load methods.**

**1609.6.1 Scope.** The procedures in Section 1609.6 shall be permitted to be used for determining and applying wind pressures in the design of enclosed buildings as listed below:

1. For buildings with flat, gabled or hipped roofs having a mean roof height not exceeding the least horizontal dimension or 60 feet (18 288 mm), whichever is less, the use of Section 1609.6.2, Simplified Procedure-I, is permitted.
2. For buildings with a mean roof height of not more than 200 feet (60 960 mm) and located not closer than 2,000 feet (609.6 m) to the river, bay, or ocean shore line in any Borough other than Manhattan, the use of Section 1609.6.3, Simplified Procedure-II, is permitted.
3. For buildings with a mean roof height of not more than 300 feet (91 440 mm) within the Borough of Manhattan and located not closer than 2,000 feet (609.6 m) to the

river, bay or ocean shore line, the use of Section 1609.6.3, Simplified Procedure-II, is permitted.

**1609.6.1.1 Reduction of loads.** The design wind pressures determined in accordance with Sections 1609.6.2 and 1609.6.3 may be reduced by one of the following methods:

1. Application of the directionality factor ( $K_d$ ) as specified in Table 6-4 of ASCE 7 to the design wind pressures.
2. Reduction of the load factor for the wind load (W) from 1.6 to 1.3 for the load combinations specified in Section 1605.2.

**1609.6.2 Simplified design procedure-I (for low-rise buildings).**

1. The wind shall be assumed to come from any horizontal direction.
2. An importance factor  $I_w$  shall be determined in accordance with Section 1609.5.
3. An exposure category shall be determined in accordance with Section 1609.4.
4. A height and exposure adjustment coefficient,  $\lambda$ , shall be determined from Table 1609.6.2.1(4).

**1609.6.2.1 Main wind force-resisting system.** Simplified design wind pressures,  $p_s$ , for the main wind force-resisting systems represent the net pressures (sum of internal and external) to be applied to the horizontal and vertical projections of building surfaces as shown in Figure 1609.6.2.1. For the horizontal pressures (Zones A, B, C, D),  $p_s$  is the combination of the windward and leeward net pressures.  $p_s$  shall be determined from Equation 16-34).

**(Equation 16-34 attached to end of document)**

where:

$\lambda$  = Adjustments factor for building height and exposure from Table 1609.6.2.1(4).

$I_w$  = Importance factor as defined in Section 1609.5.

$P_{s30}$  = Simplified design wind pressure for Exposure B, at  $h= 30$  feet (9144mm), and for  $I_w =1.0$ , from Table 1609.6.2.1(1).

**FIGURE 1609.6.2.1**  
**MAIN WINDFORCE LOADING DIAGRAM**  
**(Figure 1609.6.2.1 attached to end of document)**

**TABLE 1609.6.2.1(1)**



**SIMPLIFIED DESIGN WIND PRESSURE (MAIN WINDFORCE-RESISTING SYSTEM),  $p_{s30}$**

**(Exposure B at  $h = 30$  feet with  $I_w = 1.0$ ) (psf)**  
**(Table 1609.6.2.1(1) attached to end of document)**

**TABLE 1609.6.2.1(2)**

**NET DESIGN WIND PRESSURE (COMPONENT AND CLADDING),  $p_{s30}$  (Exposure B at  $h = 30$  feet with  $I_w = 1.0$ )**

**(Table 1609.6.2.1(2) attached to end of document)**

**TABLE 1609.6.2.1(3)**

**ROOF OVERHANG NET DESIGN WIND PRESSURE (COMPONENT AND CLADDING),  $p_{s30}$**

**(Exposure B at  $h = 30$  feet with  $I_w = 1.0$ ) (psf)**  
**(Table 1609.6.2.1(3) attached to end of document)**

**TABLE 1609.6.2.1(4)**

**ADJUSTMENT FACTOR FOR BUILDING HEIGHT AND EXPOSURE, ( $\lambda$ )**

**(Table 1609.6.2.1(4) attached to end of document)**

**1609.6.2.1.1 Minimum pressures.** The load effects of the design wind pressures from Section 1609.6.2.1 shall not be less than assuming the pressures,  $p_s$ , for Zones A, B, C and D all equal to + 20 psf (0.96 kN/m<sup>2</sup>), while assuming Zones E, F, G, and H all equal to 0 psf.

**1609.6.2.2 Components and cladding.** Net design wind pressures,  $p_{net}$ , for the components and cladding of buildings represent the net pressures (sum of internal and external) to be applied normal to each building surface as shown in Figure 1609.6.2.2. The net design wind pressure,  $p_{net}$ , shall be determined from Equation 16-35:

**(Equation 16-35 attached to end of document)**

where:

$\lambda$  \_\_\_\_\_ = Adjustments factor for building height and exposure from Table 1609.6.2.1(4).

$I_w$  \_\_\_\_\_ = Importance factor as defined in Section 1609.5.

$P_{newt30}$  \_\_\_\_\_ = Net design wind pressure for Exposure B, at  $h = 30$  feet (9144 mm), and for  $I_w = 1.0$ , from Tables 1609.6.2.1(2) and 1609.6.2.1(3).

**FIGURE 1609.6.2.2**

**COMPONENT AND CLADDING PRESSURE**

**(Figure 1609.6.2.2 attached to end of document)**

**1609.6.2.2.1 Minimum pressures.** The positive design wind pressures,  $p_{net}$ , from Section 1609.6.2.2 shall not be less than + 30 psf (1.44 kN/m<sup>2</sup>), and the negative design wind pressures,  $p_{net}$ , from Section 1609.6.2.2 shall not be less than – 30 psf (-1.44 kN/m<sup>2</sup>).

**1609.6.2.3 Load case.** Members that act as both part of the main wind force-resisting system and as components and cladding shall be designed for each separate load case.

### **1609.6.3 Simplified design procedure-II.**

**1609.6.3.1 Main wind force-resisting system.** Main wind force-resisting systems shall comply with the following:

1. The building shall be designed for the following net lateral wind pressure to be applied to the horizontal projection of the building surfaces:
  - 1.1. From 0 to 100 feet elevation 20 psf (0.96 kN/m<sup>2</sup>).
  - 1.2. From 100 to 300 feet elevation 25 psf (1.2 kN/m<sup>2</sup>).
2. An importance factor  $I_w$  shall be determined in accordance with Section 1609.5. and shall be applied to the pressures indicated above.

**1609.6.3.2 Design wind load cases.** The main wind force-resisting system of buildings of all heights, whose wind loads have been determined pursuant to Section 1609.6.3, shall be designed for wind load cases as defined below:

**Case-1.** Full design wind pressure acting on the projected area perpendicular to each principal axis of the structure, considered separately along each principal axis.

**Case-2.** 75 percent of the design wind pressure acting on the projected area perpendicular to each principal axis of the structure to be applied eccentric to the center of the exposure with eccentricity equal to 15 percent of the exposure width, considered separately for each principal direction.

**Case-3.** Wind loading as defined in case-1, but considered to act simultaneously at 75 percent of the specified value.

**1609.6.3.3 Components and cladding.** Net design wind positive and negative pressures, (pressure and suction) for the components and cladding of buildings represent the net pressures (sum of internal and external) to be applied normal to each building surface. The net design wind pressure and suction shall be 30 psf (1.44 kN/m<sup>2</sup>).

**1609.6.3.4 Roof.** The design pressure and suction acting over the entire roof including purlins, roofing, and other roof elements (including their fastenings) shall be per values given in Section 1609.6.3.1.

**1609.6.3.5 Other building elements.** The following building elements of buildings whose wind loads have been determined under the provisions of Section 1609.6.3 shall be designed for wind pressures shown in Section 1609.6.3.1 multiplied by the following shape factors given in Table 1609.6.3.5.

**TABLE 1609.6.3.5**  
**OTHER BUILDING ELEMENTS**  
**(Table 1609.6.3.5 attached to end of document)**

**1609.6.3.5.1 Eaves and cornices.** Eaves, cornices, and overhanging elements of the buildings shall be designed for upward pressures twice the values given in Section 1609.6.3.1.

**1609.7 Roof systems.**

**1609.7.1 Roof deck.** The roof deck shall be designed to withstand the wind pressures determined under either the provisions of Section 1609.6 for buildings satisfying the height and other requirements of the simplified methods or Section 1609.1.1 for buildings of any height.

**1609.8 Runback structures.** Runback structures shall be designed in compliance with the rules of the department.

**SECTION BC 1610**  
**SOIL LATERAL LOAD**

**1610.1 General.** Basement, foundation and retaining walls shall be designed to resist lateral soil loads. Soil loads specified in Table 1610.1 shall be used as the minimum design lateral soil loads unless specified otherwise in a soil investigation report approved by the commissioner. Basement walls and other walls in which horizontal movement is restricted at the top shall be designed for at-rest pressure. Retaining walls free to move and rotate at the top are permitted to be designed for active pressure. Design lateral pressure from surcharge loads shall be added to the lateral earth pressure load. Design lateral pressure shall be increased if soils with expansion potential are present at the site.

**Exception:** Basement walls extending not more than 8 feet (2438 mm) below grade and supporting flexible floor systems shall be permitted to be designed for active pressure.

**TABLE 1610.1**  
**SOIL LATERAL LOAD**  
**(Table 1610.1 attached at the end of the document)**

**SECTION BC 1611**  
**RAIN LOADS**

**1611.1 Design rain loads.** Each portion of a roof shall be designed to sustain the load of rainwater that will accumulate on it if the primary drainage system for that portion is blocked plus the uniform load caused by water that rises above the inlet of the secondary drainage system at its design flow.

**(Equation 16-37 attached to end of document)**

For SI:  $R = 0.0098 (d_s = d_h)$

where:

$d_h$  = Additional depth of water on the undeflected roof above the inlet of secondary drainage system at its design flow (i.e., the hydraulic head), in inches (mm).

$d_s$  = Depth of water on the undeflected roof up to the inlet of secondary drainage system when the primary drainage system is blocked (i.e., the static head), in inches (mm).

$R$  = Rain load on the undeflected roof, in psf (kN/m<sup>2</sup>). When the phrase “undeflected roof” is used, deflections from loads (including dead loads) shall not be considered when determining the amount of rain on the roof.

**1611.2 Ponding instability.** Ponding refers to the retention of water due solely to the deflection of relatively flat roofs. Roofs with a slope less than one-fourth unit vertical in 12 units horizontal (2-percent slope) shall be investigated by structural analysis to ensure that they possess adequate stiffness to preclude progressive deflection (i.e., instability) as rain falls on them or melt water is created from snow on them. The larger of snow load or rain load shall be used in this analysis. The primary drainage system within an area subjected to ponding shall be considered to be blocked in this analysis.

**1611.3 Controlled drainage.** Roofs equipped with hardware to control the rate of drainage shall be equipped with a secondary drainage system at a higher elevation that limits accumulation of water on the roof above that elevation. Such roofs shall be designed to sustain the load of rainwater that will accumulate on them to the elevation of the secondary drainage system plus the uniform load caused by water that rises above the inlet of the secondary drainage system at its design flow determined from Section 1611.1. Such roofs shall also be checked for ponding instability in accordance with Section 1611.2.

## **SECTION BC 1612** **FLOOD LOADS**

**1612.1 General.** The requirements for flood loads shall be as specified in Appendix G of this code.

**1612.2 Reserved.**

**1612.3 Reserved.**

1612.4 Reserved.

1612.5 Reserved.

**SECTION BC 1613**  
**EARTHQUAKE LOADS DEFINITIONS**

**1613.1 Definitions.** The following words and terms shall, for the purposes of this section, have the meanings shown herein.

**ACTIVE FAULT/ACTIVE FAULT TRACE.** A fault for which there is an average historic slip rate of 1 mm per year or more and geologic evidence of seismic activity within Holocene (past 11,000 years) times. Active fault traces are designated by the appropriate regulatory agency and/or registered design professional subject to identification by a geologic report.

**ATTACHMENTS, SEISMIC.** Means by which components and their supports are secured or connected to the seismic-force-resisting system of the structure. Such attachments include anchor bolts, welded connections and mechanical fasteners.

**BASE.** The level at which the horizontal seismic ground motions are considered to be imparted to the structure.

**BOUNDARY ELEMENTS.** Chords and collectors at diaphragm and shearwall edges, interior openings, discontinuities and reentrant corners.

**BRITTLE.** Systems, members, materials and connections that do not exhibit significant energy dissipation capacity in the inelastic range.

**COLLECTOR.** A diaphragm or shear wall element parallel to the applied load that collects and transfers shear forces to the vertical-force-resisting elements or distributes forces within a diaphragm or shear wall.

**COMPONENT.** A part or element of an architectural, electrical, mechanical or structural system.

**Component, equipment.** A mechanical or electrical component or element that is part of a mechanical and/or electrical system within or without a building system.

**Component, flexible.** Component, including its attachments, having a fundamental period greater than 0.06 second.

**Component, rigid.** Component, including its attachments, having a fundamental period less than or equal to 0.06 second.

**DESIGN EARTHQUAKE.** The earthquake effects that buildings and structures are specifically

proportioned to resist in Sections 1613 through 1622.

## **DISPLACEMENT.**

**Design displacement.** The design earthquake lateral displacement, excluding additional displacement due to actual and accidental torsion, required for design of the isolation system.

**Total design displacement.** The design earthquake lateral displacement, including additional displacement due to actual and accidental torsion, required for design of the isolation system.

**Total maximum displacement.** The maximum considered earthquake lateral displacement, including additional displacement due to actual and accidental torsion, required for verification of the stability of the isolation system or elements thereof, design of building separations and vertical load testing of isolator unit prototype.

**DISPLACEMENT RESTRAINT SYSTEM.** A collection of structural elements that limits lateral displacement of seismically isolated structures due to the maximum considered earthquake.

**EFFECTIVE DAMPING.** The value of equivalent viscous damping corresponding to energy dissipated during cyclic response of the isolation system.

**EFFECTIVE STIFFNESS.** The value of the lateral force in the isolation system, or an element thereof, divided by the corresponding lateral displacement.

**HAZARDOUS CONTENTS.** A material that is highly toxic or potentially explosive and in sufficient quantity to pose a significant life-safety threat to the general public if an uncontrolled release were to occur.

**INVERTED PENDULUM-TYPE STRUCTURES.** Structures that have a large portion of their mass concentrated near the top, and thus have essentially one degree of freedom in horizontal translation. The structures are usually T-shaped with a single column supporting the beams or framing at the top.

**ISOLATION INTERFACE.** The boundary between the upper portion of the structure, which is isolated, and the lower portion of the structure, which moves rigidly with the ground.

**ISOLATION SYSTEM.** The collection of structural elements that includes individual isolator units, structural elements that transfer force between elements of the isolation system and connections to other structural elements.

**ISOLATOR UNIT.** A horizontally flexible and vertically stiff structural element of the isolation system that permits large lateral deformations under design seismic load. An isolator unit is permitted to be used either as part of or in addition to the weight-supporting system of the building.

**LOAD.**

**Gravity load (W).** The total dead load and applicable portions of other loads as defined in Sections 1613 through 1622.

**MAXIMUM CONSIDERED EARTHQUAKE.** The most severe earthquake effects considered by this code.

**NONBUILDING STRUCTURE.** A structure, other than a building, constructed of a type included in Section 1622.

**OCCUPANCY IMPORTANCE FACTOR.** A factor assigned to each structure according to its seismic use group as prescribed in Table 1604.5.

**SEISMIC DESIGN CATEGORY.** A classification assigned to a structure based on its seismic use group and the severity of the design earthquake ground motion at the site.

**SEISMIC-FORCE-RESISTING SYSTEM.** The part of the structural system that has been considered in the design to provide the required resistance to the seismic forces prescribed herein.

**SEISMIC FORCES.** The assumed forces prescribed herein, related to the response of the structure to earthquake motions, to be used in the design of the structure and its components.

**SEISMIC USE GROUP.** A classification assigned to a building based on its use as defined in Section 1616.2.

**SHEAR WALL.** A wall designed to resist lateral forces parallel to the plane of the wall.

**SHEAR WALL-FRAME INTERACTIVE SYSTEM.** A structural system that uses combinations of shear walls and frames designed to resist lateral forces in proportion to their rigidities, considering interaction between shear walls and frames on all levels.

**SITE CLASS.** A classification assigned to a site based on the types of soils present and their engineering properties as defined in Section 1615.1.5.

**SITE COEFFICIENTS.** The values of,  $F_a$ , and,  $F_v$ , indicated in Tables 1615.1.2(1) and 1615.1.2(2), respectively.

**STORY DRIFT RATIO.** The story drift divided by the story height.

**TORSIONAL FORCE DISTRIBUTION.** The distribution of horizontal seismic forces through a rigid diaphragm when the center of mass of the structure at the level under consideration does not coincide with the center of rigidity (sometimes referred to as a “diaphragm rotation”).

**TOUGHNESS.** The ability of a material to absorb energy without losing significant strength.

**WIND-RESTRAINT SEISMIC SYSTEM.** The collection of structural elements that provides restraint of the seismic-isolated structure for wind loads. The wind-restraint system may be either an integral part of isolator units or a separate device.

## **SECTION BC 1614** **EARTHQUAKE LOADS—GENERAL**

**1614.1 Scope.** Every structure, and portion thereof, shall at a minimum, be designed and constructed to resist the effects of earthquake motions and assigned a seismic design category as set forth in Section 1616.3.

### **Exceptions:**

1. Structures designed in accordance with the provisions of Sections 9.1 through 9.6, 9.13 and 9.14 of ASCE 7 shall be permitted.
2. One- and two-family dwellings not more than three stories in height are exempt from the requirements of Sections 1613 through 1622.
3. The seismic-force-resisting system of wood frame buildings that conform to the provisions of Section 2308 are not required to be analyzed as specified in Section 1616.1.
4. Agricultural storage structures intended only for incidental human occupancy are exempt from the requirements of Sections 1613 through 1623.

**1614.1.1 Reserved.**

**1614.2 Reserved.**

**1614.3 Reserved.**

**1614.4 Quality assurance.** A quality assurance plan shall be provided where required by Chapter 17.

**1614.5 Seismic and wind.** When the code-prescribed wind design produces greater effects, the wind design shall govern, but detailing requirements and limitations prescribed in this and referenced sections shall be followed.

## **SECTION BC 1615** **EARTHQUAKE LOADS—SITE GROUND MOTION**

**1615.1 General procedure for determining maximum considered earthquake and design spectral response accelerations.** Ground motion accelerations, represented by response spectra and coefficients derived from these spectra, shall be determined in accordance with the general



procedure of Section 1615.1, or the site-specific procedure of Section 1615.2. The site-specific procedure of Section 1615.2 shall be used for structures on sites classified as Site Class F, in accordance with Section 1615.1.1.

The mapped maximum considered earthquake spectral response acceleration at short periods ( $S_s$ ) shall be 0.365g and at 1-second period ( $S_l$ ) shall be 0.071g.

The site class shall be determined in accordance with Section 1615.1.1. The maximum considered earthquake spectral response accelerations at short period and 1-second period adjusted for site class effects,  $S_{MS}$  and  $S_{Ml}$ , shall be determined in accordance with Section 1615.1.2. The design spectral response accelerations at short period,  $S_{DS}$ , and at 1-second period,  $S_{Dl}$ , shall be determined in accordance with Section 1615.1.3. The general response spectrum shall be determined in accordance with Section 1615.1.4.

**1615.1.1 Site class definitions.** The site shall be classified as one of the site classes defined in Table 1615.1.1. Where the soil shear wave velocity,  $v_s$ , is not known, site class shall be determined, as permitted in Table 1615.1.1, from standard penetration resistance, N, or from soil undrained shear strength,  $s_u$ , calculated in accordance with Section 1615.1.5. Where site-specific data are not available to a depth of 100 feet (30 480 mm), appropriate soil properties are permitted to be estimated by the registered design professional preparing the soils report based on known geologic conditions. When the soil properties are not known in sufficient detail to determine the site class, Site Class D shall be used unless the commissioner determines that Site Class E or F soil is likely to be present at the site.

**TABLE 1615.1.1**  
**SITE CLASS DEFINITIONS**  
**(Table 1615.1.1 attached to end of document)**

**1615.1.2 Site coefficients and adjusted maximum considered earthquake spectral response acceleration parameters.** The maximum considered earthquake spectral response acceleration for short periods,  $S_{MS}$ , and at 1-second period,  $S_{Ml}$ , adjusted for site class effects, shall be determined by Equations 16-38 and 16-39, respectively:

**(Equation 16-38 attached to end of document)**

**(Equation 16-39 attached to end of document)**

where:

$F_a$  = Site coefficient defined in Table 1615.1.2(1).

$F_v$  = Site coefficient defined in Table 1615.1.2(2).

$S_s$  = The mapped spectral accelerations for short periods as determined in Section 1615.1.

$S_l$  = The mapped spectral accelerations for a 1-second period as determined in Section

1615.1.

**TABLE 1615.1.2(1) VALUES OF SITE COEFFICIENT  $F_a$  AS A FUNCTION OF SITE CLASS AND MAPPED SPECTRAL RESPONSE ACCELERATION AT SHORT PERIODS ( $S_S$ )<sup>a</sup>**

**(Table 1615.1.2(1) attached to end of document)**

**TABLE 1615.1.2(2) VALUES OF SITE COEFFICIENT  $F_V$  AS A FUNCTION OF SITE CLASS AND MAPPED SPECTRAL RESPONSE ACCELERATION AT 1-SECOND PERIOD ( $S_I$ )<sup>a</sup>**

**(Table 1615.1.2(2) attached to end of document)**

**1615.1.3 Design spectral response acceleration parameters.** Five-percent damped design spectral response acceleration at short periods,  $S_{DS}$ , and at 1-second period,  $S_{D1}$ , shall be determined from Equations 16-40 and 16-41, respectively:

**(Equation 16-40 to end of document)**

**(Equation 16-41 to end of document)**

where:

$S_{MS}$  = The maximum considered earthquake spectral response accelerations for short period as determined in Section 1615.1.2.

$S_{M1}$  = The maximum considered earthquake spectral response accelerations for 1 second period as determined in Section 1615.1.2.

**1615.1.4 General procedure response spectrum.** The general design response spectrum curve shall be developed as indicated in Figure 1615.1.4 and as follows:

1. For periods less than or equal to  $T_O$ , the design spectral response acceleration,  $S_a$ , shall be determined by Equation 16-42.
2. For periods greater than or equal to  $T_O$  and less than or equal to  $T_S$ , the design spectral response acceleration,  $S_a$ , shall be taken equal to  $S_{DS}$ .
3. For periods greater than  $T_S$ , the design spectral response acceleration,  $S_a$ , shall be determined by Equation 16-43.

**(Equation 16-42 attached to end of document)**

**(Equation 16-43 attached to end of document)**

where:

$S_{DS}$  = The design spectral response acceleration at short periods as determined in Section

1615.1.3.

$S_{D1}$  = The design spectral response acceleration at 1-second period as determined in Section 1615.1.3.

$T$  = Fundamental period (in seconds) of the structure (see Section 9.5.5.3 of ASCE 7).

$T_o = 0.2 SD1/SDS$

$T_y = SD1/SDS$

**FIGURE 1615.1.4**  
**DESIGN RESPONSE SPECTRUM**  
**(Figure 1615.1.4 attached to end of document)**

**1615.1.5 Site classification for seismic design.** Site classification for Site Class C, D or E shall be determined from Table 1615.1.5.

The notations presented below apply to the upper 100 feet (30 480 mm) of the site profile. Profiles containing distinctly different soil layers shall be subdivided into those layers designated by a number that ranges from 1 to  $n$  at the bottom where there is a total of  $n$  distinct layers in the upper 100 feet (30 480 mm). The symbol,  $i$ , then refers to any one of the layers between 1 and  $n$ .

where:

$v_{si}$  = The shear wave velocity in feet per second (m/s).

$d_i$  = The thickness of any layer between 0 and 100 feet (30 480 mm).

**(Equation 16-44 attached to end of document)**

$N_i$  is the Standard Penetration Resistance (ASTM D1586) not to exceed 100 blow/foot (mm) as directly measured in the field without corrections.

**(Equation 16-45 attached to end of document)**

**(Equation 16-46 attached to end of document)**

where:

$$\sum_{i=1}^m d_i = d_s$$

Use only  $d_i$  and  $N_i$  for cohesionless soils.

$d_s$  = The total thickness of cohesionless soil layers in the top 100 feet (30 480 mm).

$S_{ui}$  = The undrained shear strength in psg (kPa), not to exceed 5,000 psf (240 kPa),  
ASTM D 2166 or D 2850.

**(Equation 16-47 attached to end of document)**

where:

$$\frac{k}{\sum_{i=1} d_i} = d_c$$

$d_c$  = The total thickness (100- $d_s$ ) (For SI:30480- $d_s$ ) of cohesive soil layers in the top 100 feet (30480 mm).

$PI$  = The plasticity index, ASTM D 4318.

$W$  = The moisture content in percent, ASTM D 2216.

The shear wave velocity for rock, Site Class B, shall be either measured on site or estimated by a geotechnical engineer or engineering geologist/seismologist for competent rock with moderate fracturing and weathering. Softer and more highly fractured and weathered rock shall either be measured on site for shear wave velocity or classified as Site Class C.

The hard rock, Site Class A, category shall be supported by shear wave velocity measurements either on site or on profiles of the same rock type in the same formation with an equal or greater degree of weathering and fracturing. Where hard rock conditions are known to be continuous to a depth of 100 feet (30 480 mm), surficial shear wave velocity measurements are permitted to be extrapolated to assess  $v_s$ .

The rock categories, Site Classes A and B, shall not be used if there is more than 10 feet (3048 mm) of soil between the rock surface and the bottom of the spread footing or mat foundation.

**TABLE 1615.1.5**  
**SITE CLASSIFICATION<sup>a</sup>**

**(Table 1615.1.5 attached to end of document)**

**1615.1.5.1 Steps for classifying a site.**

1. Check for the four categories of Site Class F requiring site-specific evaluation. If the site corresponds to any of these categories, classify the site as Site Class F and conduct a site-specific evaluation.

2. Check for the existence of a total thickness of soft clay > 10 feet (3048 mm) where a soft clay layer is defined by:  $s_u < 500$  psf (25 kPa),  $w \geq 40$  percent, and  $PI > 20$ . If these criteria are satisfied, classify the site as Site Class E.
3. Categorize the site using one of the following three methods with  $v_s$ ,  $N$ , and  $s_u$  computed in all cases as specified.
  - 3.1.  $v_s$  for the top 100 feet (30 480 mm) ( $v_s$  method).
  - 3.2.  $N$  for the top 100 feet (30 480 mm) ( $N$  method).
  - 3.3.  $N_{ch}$  for cohesionless soil layers ( $PI < 20$ ) in the top 100 feet (30 480 mm) and average,  $s_{us}$ , for cohesive soil layers ( $PI > 20$ ) in the top 100 feet (30 480 mm) ( $s_u$  method).

**1615.2 Site-specific procedure for determining ground motion accelerations.** A site-specific study shall account for the regional seismicity and geology; the expected recurrence rates and maximum magnitudes of events on known faults and source zones; the location of the site with respect to these; near source effects if any and the characteristics of subsurface site conditions.

**1615.2.1 Probabilistic maximum considered earthquake.** Where site-specific procedures are used as required or permitted by Section 1615, the maximum considered earthquake ground motion shall be taken as that motion represented by an acceleration response spectrum having a 2-percent probability of exceedance within a 50-year period. The maximum considered earthquake spectral response acceleration at any period,  $S_{aM}$ , shall be taken from the 2-percent probability of exceedance within a 50-year period spectrum.

**Exception:** Where the spectral response ordinates at 0.2 second or 1 second for a 5-percent damped spectrum having a 2-percent probability of exceedance within a 50-year period exceed the corresponding ordinates of the deterministic limit of Section 1615.2.2, the maximum considered earthquake ground motion spectrum shall be taken as the lesser of the probabilistic maximum considered earthquake ground motion or the deterministic maximum considered earthquake ground motion spectrum of Section 1615.2.3, but shall not be taken as less than the deterministic limit ground motion of Section 1615.2.2.

**1615.2.2 Deterministic limit on maximum considered earthquake ground motion.** The deterministic limit for the maximum considered earthquake ground motion shall be the response spectrum determined in accordance with Figure 1615.2.2, where site coefficients,  $F_a$  and  $F_v$ , are determined in accordance with Section 1615.1.2, with the value of the mapped short-period spectral response acceleration,  $S_S$ , taken as 1.5g and the value of the mapped spectral response acceleration at 1 second,  $S_1$ , taken as 0.6g.

**FIGURE 1615.2.2**  
**DETERMINISTIC LIMIT ON MAXIMUM CONSIDERED EARTHQUAKE RESPONSE**  
**SPECTRUM**  
**(Figure 1615.2.2 attached to end of document)**

**1615.2.3 Deterministic maximum considered earthquake ground motion.** The deterministic maximum considered earthquake ground motion response spectrum shall be calculated as 150 percent of the median spectral response accelerations,  $S_{aM}$ , at all periods resulting from a characteristic earthquake on any known active fault within the region.

**1615.2.4 Site-specific design ground motion.** Where site-specific procedures are used to determine the maximum considered earthquake ground motion response spectrum, the design spectral response acceleration,  $S_{a_s}$ , at any period shall be determined from Equation 16-48:

**(Equation 16-48 attached to end of document)**

and shall be greater than or equal to 80 percent of the design spectral response acceleration,  $S_{a_s}$ , determined by the general response spectrum in Section 1615.1.4.

**1615.2.5 Design spectral response coefficients.** Where the site-specific procedure is used to determine the design ground motion in accordance with Section 1615.2.4, the parameter  $S_{DS}$  shall be taken as the spectral acceleration,  $S_{a_s}$ , obtained from the site-specific spectra at a period of 0.2 second, except that it shall not be taken as less than 90 percent of the peak spectral acceleration,  $S_{a_s}$ , at any period. The parameter  $S_{DI}$  shall be taken as the greater of the spectral acceleration,  $S_{a_s}$ , at a period of 1 second or two times the spectral acceleration,  $S_{a_s}$ , at a period of 2 seconds. The parameters  $S_{MS}$  and  $S_{MI}$  shall be taken as 1.5 times  $S_{DS}$  and  $S_{DI}$ , respectively. The values so obtained shall not be taken as less than 80 percent of the values obtained from the general procedures of Section 1615.1.

## **SECTION BC 1616** **EARTHQUAKE LOADS—CRITERIA SELECTION**

**1616.1 Structural design criteria.** Each structure shall be assigned to a seismic design category in accordance with Section 1616.3. Seismic design categories are used in this code to determine permissible structural systems, limitations on height and irregularity, those components of the structure that must be designed for seismic resistance and the types of lateral force analysis that must be performed. Each structure shall be provided with complete lateral- and vertical-force-resisting systems capable of providing adequate strength, stiffness and energy dissipation capacity to withstand the design earthquake ground motions determined in accordance with Section 1615 within the prescribed deformation limits of Section 1617.3. The design ground motions shall be assumed to occur along any horizontal direction of a structure. A continuous load path, or paths, with adequate strength and stiffness to transfer forces induced by the design earthquake ground motions from the points of application to the final point of resistance shall be provided.

Allowable stress design is permitted to be used to evaluate sliding, overturning and soil bearing at the soil-structure interface regardless of the approach used in the design of the structure, provided load combinations of Section 1605.3 are utilized. When using allowable stress design for proportioning foundations, the value of  $0.2 S_{DS}D$  in Equations 16-50, 16-51, 16-52 and 16-53 or Equations 9.5.2.7-1, 9.5.2.7-2, 9.5.2.7.1-1 and 9.5.2.7.1-2 of ASCE 7 is

permitted to be taken equal to zero. When the load combinations of Section 1605.3.2 are utilized, a one-third increase in soil allowable stresses is permitted for all load combinations that include  $W$  or  $E$ .

**1616.2 Seismic use groups and occupancy importance factors.** Each structure shall be assigned a seismic use group and a corresponding occupancy importance factor ( $IE$ ) as indicated in Table 1604.5.

**1616.2.1 Seismic Use Group I.** Seismic Use Group I structures are those not assigned to either Seismic Use Group II or III.

**1616.2.2 Seismic Use Group II.** Seismic Use Group II structures are those, the failure of which would result in a substantial public hazard due to occupancy or use as indicated by Table 1604.5, or as designated by the commissioner.

**1616.2.3 Seismic Use Group III.** Seismic Use Group III structures are those having essential facilities that are required for post earthquake recovery and those containing substantial quantities of hazardous substances, as indicated in Table 1604.5, or as designated by the commissioner. Where operational access to a Seismic Use Group III structure is required through an adjacent structure, the adjacent structure shall conform to the requirements for Seismic Use Group III structures. Where operational access is less than 10 feet (3048 mm) from an interior lot line or less than 10 feet (3048 mm) from another structure, access protection from potential falling debris shall be provided by the owner of the Seismic Use Group III structure.

**1616.2.4 Multiple occupancies.** Where a structure is occupied for two or more occupancies not included in the same seismic use group, the structure shall be assigned the classification of the highest seismic use group corresponding to the various occupancies. Where structures have two or more portions that are structurally separated in accordance with Section 1620, each portion shall be separately classified. Where a structurally separated portion of a structure provides required access to, required egress from or shares life safety components with another portion having a higher seismic use group, both portions shall be assigned the higher seismic use group.

**1616.3 Determination of seismic design category.** All structures shall be assigned to a seismic design category based on their seismic use group and the design spectral response acceleration coefficients,  $S_{DS}$  and  $S_{DI}$ , determined in accordance with Section 1615.1.3 or 1615.2.5. Each building and structure shall be assigned to the most severe seismic design category in accordance with Table 1616.3(1) or 1616.3(2), irrespective of the fundamental period of vibration of the structure,  $T$ . Seismic Design Category B is the minimum design category allowed.

**Exception:** The seismic design category is permitted to be determined from Table 1616.3(1) alone when all of the following apply:

1. The approximate fundamental period of the structure,  $T_a$ , in each of the two orthogonal directions determined in accordance with Section 9.5.5.3.2 of ASCE 7, is

- less than  $0.8 T_s$  determined in accordance with Section 1615.1.4,
2. Equation 9.5.5.2.1-1 of ASCE 7 is used to determine the seismic response coefficient,  $C_s$ , and
  3. The diaphragms are rigid as defined in Section 1602.

**TABLE 1616.3(1)**  
**SEISMIC DESIGN CATEGORY BASED ON SHORT-PERIOD RESPONSE**  
**ACCELERATIONS**  
**(Table 1616.3(1) attached to end of document)**

**TABLE 1616.3(2)**  
**SEISMIC DESIGN CATEGORY BASED ON 1-SECOND PERIOD RESPONSE**  
**ACCELERATION**  
**(Table 1616.3(2) attached to end of document)**

**1616.3.1 Seismic Design Category A, E or F.** Requirements for Seismic Design Categories A, E and F have been eliminated from the *New York City Building Code* as such categories do not apply in New York City. References to these categories can be found in ASCE 7.

**1616.4** Reserved.

**1616.5 Building configuration.** Buildings shall be classified as regular or irregular based on the criteria in Section 9.5.2.3 of ASCE 7.

**Exception:** Buildings designed using the simplified analysis procedure in Section 1617.5 shall be classified in accordance with Section 1616.5.1.

**1616.5.1 Building configuration (for use in the simplified analysis procedure of Section 1617.5).** Buildings designed using the simplified analysis procedure in Section 1617.5 shall be classified as regular or irregular based on the criteria in this section. Such classification shall be based on the plan and vertical configuration. Buildings shall not exceed the limitations of Section 1616.6.1.

**1616.5.1.1 Plan irregularity.** Buildings having one or more of the features listed in Table 1616.5.1.1 shall be designated as having plan structural irregularity and shall comply with the requirements in the sections referenced in that table.

**Table 1616.5.1.1**  
**PLAN STRUCTURAL IRREGULARITIES**  
**(Table 1615.5.1.1 attached to end of document)**

**1616.5.1.2 Vertical irregularity.** Buildings having one or more of the features listed in Table 1616.5.1.2 shall be designated as having vertical irregularity and shall comply with the requirements in the sections referenced in that table.



**Exceptions:**

1. Structural irregularities of Type 1a, 1b or 2 in Table 1616.5.1.2 do not apply where no story drift ratio under design lateral load is greater than 130 percent of the story drift ratio of the next story above. Torsional effects need not be considered in the calculation of story drifts for the purpose of this determination. The story drift ratio relationship for the top two stories of the building is not required to be evaluated.
2. Irregularities of Types 1a, 1b and 2 of Table 1616.5.1.2 are not required to be considered for one-story buildings in any seismic design category or for two-story buildings in Seismic Design Category B, C or D.

**TABLE 1616.5.1.2**  
**VERTICAL STRUCTURAL IRREGULARITIES**  
**(Table 1616.5.1.2 attached to end of document)**

**1616.6 Analysis procedures.** A structural analysis conforming to one of the types permitted in Section 9.5.2.5.1 of ASCE7 or to the simplified procedure in Section 1617.5 shall be made for all structures. The analysis shall form the basis for determining the seismic forces,  $E$  and  $E_m$ , to be applied in the load combinations of Section 1605 and shall form the basis for determining the design drift as required by Section 9.5.2.8 of ASCE 7 or Section 1617.3.

**Exception:** Design drift need not be evaluated in accordance with Section 1617.3 when the simplified analysis method of Section 1617.5 is used.

**1616.6.1 Simplified analysis.** A simplified analysis, in accordance with Section 1617.5, shall be permitted to be used for any structure in Seismic Use Group I, subject to the following limitations, or a more rigorous analysis shall be made:

1. Buildings of light-framed construction not exceeding three stories in height, excluding basements.
2. Buildings of any construction other than light-framed construction, not exceeding two stories in height, excluding basements, with flexible diaphragms at every level as defined in Section 1602.

**SECTION BC 1617**  
**EARTHQUAKE LOADS—MINIMUM DESIGN LATERAL FORCE AND RELATED**  
**EFFECTS**

**1617.1 Seismic load effect  $E$  and  $E_m$ .** The seismic load effect,  $E$ , for use in the basic load combinations of Sections 1605.2 and 1605.3 shall be determined from Section 9.5.2.7 of ASCE 7. The maximum seismic load effect,  $E_m$ , for use in the special seismic load combination of Section 1605.4 shall be the special seismic load determined from Section 9.5.2.7.1 of ASCE 7.

**Exception:** For structures designed using the simplified analysis procedure in Section 1617.5, the seismic load effects,  $E$  and  $E_m$ , shall be determined from Section 1617.1.1.

**1617.1.1 Seismic load effects,  $E$  and  $E_m$  (for use in the simplified analysis procedure of Section 1617.5).** Seismic load effects,  $E$  and  $E_m$ , for use in the load combinations of Section 1605 for structures designed using the simplified analysis procedure in Section 1617.5 shall be determined as follows.

**1617.1.1.1 Seismic load effect,  $E$ .** Where the effects of gravity and the seismic ground motion are additive, seismic load,  $E$ , for use in Equations 16-5, 16-10 and 16-17, shall be defined by Equation 16-50:

**(Equation 16-50 attached to end of document)**

where:

$D$  = The effect of dead load.

$E$  = The combined effect of horizontal and vertical earthquake-induced forces.

$\rho$  = A redundancy coefficient obtained in accordance with Section 1617.2.

$Q_E$  = The effect of horizontal seismic forces.

$S_{DS}$  = The design spectral response acceleration at short periods obtained from Section 1615.1.3 or 1615.2.5.

Where the effects of gravity and seismic ground motion counteract, the seismic load,  $E$ , for use in Equations 16-6, 16-12 and 16-18 shall be defined by Equation 16-51.

**(Equation 16-51 attached to end of document)**

Design shall use the load combinations prescribed in Section 1605.2 for strength or load and resistance factor design methodologies or Section 1605.3 for allowable stress design methods.

**1617.1.1.2 Maximum seismic load effect,  $E_m$ .** The maximum seismic load effect,  $E_m$ , shall be used in the special seismic load combinations in Section 1605.4.

Where the effects of the seismic ground motion and gravity loads are additive, seismic load,  $E_m$ , for use in Equation 16-19, shall be defined by Equation 16-52.

**(Equation 16-52 attached to end of document)**

Where the effects of the seismic ground and gravity loads counteract, seismic load,  $E_m$ , for use in Equation 16-20, shall be defined by Equation 16-53.

**(Equation 16-53 attached to end of document)**

Where  $E$ ,  $Q_E$ ,  $S_{DS}$  are as defined above and  $\Omega_0$  is the system overstrength factor as given in Table 1617.6.2.

The term  $\Omega_0 Q_E$  need not exceed the maximum force that can be transferred to the element by the other elements of the lateral-force-resisting system.

Where allowable stress design methodologies are used with the special load combinations of Section 1605.4, design strengths are permitted to be determined using an allowable stress increase of 1.7 and a resistance factor,  $\phi$ , of 1.0. This increase shall not be combined with increases in allowable stresses or load combination reductions otherwise permitted by this code or the material reference standard except that combination with the duration of load increases in Chapter 23 is permitted.

**1617.2 Redundancy.** The provisions given in Section 9.5.2.4 of ASCE 7 shall be used.

**Exception:** Structures designed using the simplified analysis procedure in Section 1617.5 shall use the redundancy provisions in Sections 1617.2.2.

**1617.2.1 ASCE7, Section 9.5.2.4.2.** Modify Section 9.5.2.4.2 as follows:

9.5.2.4.2 Seismic Design Category D: For structures in Seismic Design Category D,  $\rho$  shall be taken as the largest of the values of  $\rho_x$  calculated at each story “ $x$ ” of the structure in accordance with Equation 9.5.2.4.2-1 as follows:

$$\rho_x = 2 - \frac{20}{r_{maxx} \sqrt{A_x}}$$

where:

$r_{maxx}$  = The ratio of the design story shear resisted by the single element carrying the most shear force in the story to the total story shear, for a given direction of loading. For braced frames, the value of  $r_{maxx}$  is equal to the lateral force component in the most heavily loaded brace element divided by the story shear. For moment frames,  $r_{maxx}$  shall be taken as the maximum of the sum of the shears in any two adjacent columns in the plane of a moment frame divided by the story shear. For columns common to two bays with moment-resisting connections on opposite sides at the level under consideration, 70 percent of the shear in that column is permitted to be used in the column shear summation. For shear walls,  $r_{maxx}$  shall be taken equal to shear in the most heavily loaded wall or wall pier multiplied by 10/ $l_w$  (the metric coefficient is 3.3/ $l_w$ ), divided by the story shear, where  $l_w$  is the wall or wall pier length in feet (m). The value of the ratio of 10/ $l_w$  need not to be greater than 1.0 for buildings of light-framed construction. For dual systems,  $r_{maxx}$  shall be taken as the maximum value defined above, considering all lateral-load-resisting elements in the story. The lateral

loads shall be distributed to elements based on relative rigidities considering the interaction of the dual system. For dual systems, the value of  $\tilde{n}$  need not exceed 80 percent of the value calculated above.

$A_x$  = The floor area in square feet of the diaphragm level immediately above the story.

Calculation of  $r_{maxx}$  need not consider the effects of accidental torsion and any dynamic amplification of torsion required by Section 9.5.5.5.2.

For a story with a flexible diaphragm immediately above,  $r_{maxx}$  shall be permitted to be calculated from an analysis that assumes rigid diaphragm behavior and  $\rho_x$  need not exceed 1.25.

The value of  $\rho$  need not exceed 1.5, which is permitted to be used for any structure. The value of  $\rho$  shall not be taken as less than 1.0.

**Exception:** For structures with seismic-force-resisting systems in any direction comprised solely of special moment frames, the seismic-force-resisting system shall be configured such that the value of  $\rho$  calculated in accordance with this section does not exceed 1.25. The calculated value of  $\rho$  is permitted to exceed this limit when the design story drift,  $\Delta$ , as determined in Section 9.5.5.7, does not exceed  $\Delta_a / \rho$  for any story where  $a$  is the allowable story drift from Table 9.5.2.8.

The metric equivalent of Equation 9.5.2.4.2-1 is:

$$\rho_x = 2 - \frac{6.1}{r_{maxx} \sqrt{A_x}}$$

Where:  $A_x$  is in square meters.

The value  $\rho$  shall be permitted to be taken equal to 1.0 in the following circumstances:

1. When calculating displacements for dynamic amplification of torsion in Section 9.5.5.5.2.
2. When calculating deflections, drifts and seismic shear forces related to Sections 9.5.5.7.1 and 9.5.5.7.2.
3. For design calculations required by Section 9.5.2.6, 9.6 or 9.14.

For structures with vertical combinations of seismic-force-resisting systems, the value of  $\tilde{n}$  shall be determined independently for each seismic-force-resisting system. The redundancy coefficient of the lower portion shall not be less than the following:

$$\rho_L = \frac{R_L \rho_u}{\quad}$$

$$\frac{\quad}{R_u}$$

where:

$\rho_L = \rho$  of lower portion.

$R_L = R$  of lower portion.

$\rho_u = \rho$  of upper portion.

$R_u = R$  of upper portion.

**1617.2.2 Redundancy (for use in the simplified analysis procedure of Section 1617.5).** A redundancy coefficient,  $\rho$ , shall be assigned to each structure designed using the simplified analysis procedure in Section 1617.5 in accordance with this section. Buildings shall not exceed the limitations of Section 1616.6.1.

**1617.2.2.1 Seismic Design Category B or C.** For structures assigned to Seismic Design Category B or C (see Section 1616), the value of the redundancy coefficient  $\rho$  is 1.0.

**1617.2.2.2 Seismic Design Category D.** For structures in Seismic Design Category D (see Section 1616), the redundancy coefficient,  $\rho$ , shall be taken as the largest of the values of,  $\rho_i$ , calculated at each story “i” of the structure in accordance with Equation 16-54, as follows:

**(Equation 16-54 attached to end of document)**

where:

$r_{maxi} =$  The ratio of the design story shear resisted by the most heavily loaded single element in the story to the total story shear, for a given direction of loading.

$r_{maxi} =$  For braced frames, the value  $r_{maxi}$  is equal to the horizontal force component in the most heavily loaded brace element divided by the story shear.

$r_{maxi} =$  For moment frames,  $r_{maxi}$  shall be taken as the maximum of the sum of the shears in any two adjacent columns in a moment frame divided by the story shear. For columns common to two bays with moment-resisting connections on opposite sides at the level under consideration, it is permitted to use 70 percent of the shear in that column in the column shear summation.

$r_{maxi} =$  For shear walls,  $r_{maxi}$  shall be taken as the maximum value of the product of the shear in the wall or wall pier and  $10/lw$  ( $3.3/lw$  for SI), divided by the story shear, where  $lw$  is the length of the wall or wall pier in feet (m). In light-framed construction, the value of the ratio of  $10/lw$  need not be greater than 1.0.

$r_{maxi}$  = For dual systems,  $r_{maxi}$ , shall be taken as the maximum value defined above, considering all lateral-load-resisting elements in the story. The lateral loads shall be distributed to elements based on relative rigidities considering the interaction of the dual system. For dual systems, the value of  $\rho$  need not exceed 80 percent of the value calculated above.

$A_j$  = The floor area in square feet of the diaphragm level immediately above the story.

For a story with a flexible diaphragm immediately above,  $r_{maxi}$  shall be permitted to be calculated from an analysis that assumes rigid diaphragm behavior and  $\rho$  need not exceed 1.25.

The value,  $\rho$ , shall not be less than 1.0, and need not exceed 1.5.

Calculation of  $r_{maxi}$  need not consider the effects of accidental torsion and any dynamic amplification of torsion required by Section 9.5.5.5.2 of ASCE 7.

For structures with seismic-force-resisting systems in any direction comprised solely of special moment frames, the seismic-force-resisting system shall be configured such that the value of  $\rho$  calculated in accordance with this section does not exceed 1.25 for structures assigned to Seismic Design Category D, and does not exceed 1.1 for structures assigned to Seismic Design Category E or F.

**Exception:** The calculated value of  $\rho$  is permitted to exceed these limits when the design story drift,  $\Delta$ , as determined in Section 1617.5.4, does not exceed  $\Delta_a/\rho$  for any story where  $a$  is the allowable story drift from Table 1617.3.1.

The value  $\rho$  shall be permitted to be taken equal to 1.0 in the following circumstances:

1. When calculating displacements for dynamic amplification of torsion in Section 9.5.5.5.2 of ASCE 7.
2. When calculating deflections, drifts and seismic shear forces related to Sections 9.5.5.7.1 and 9.5.5.7.2 of ASCE 7.
3. For design calculations required by Section 1620, 1621 or 1622.

For structures with vertical combinations of seismic-force-resisting systems, the value,  $\rho$ , shall be determined independently for each seismic-force-resisting system. The redundancy coefficient of the lower portion shall not be less than the following:

**(Equation 16-55 attached to end of document)**

where:

$\rho_L = \rho$  of lower portion.

$R_L = R$  of lower portion.

$\rho_U = \rho$  of upper portion.

$R_U = R$  of upper portion.

**1617.3 Deflection and drift limits.** The provisions given in Section 9.5.2.8 of ASCE 7 shall be used.

**Exception:** Structures designed using the simplified analysis procedure in Section 1617.5 shall meet the provisions in Section 1617.3.1.

**1617.3.1 Deflection and drift limits (for use in the simplified analysis procedure of Section 1617.5).** The design story drift  $\Delta$ , as determined in Section 1617.5.4, shall not exceed the allowable story drift  $\Delta_a$ , as obtained from Table 1617.3.1 for any story. All portions of the building shall be designed to act as an integral unit in resisting seismic forces unless separated structurally by a distance sufficient to avoid damaging contact under total deflection as determined in Section 1617.5.4. Buildings shall not exceed the limitations of Section 1616.6.1.

**TABLE 1617.3.1**  
**ALLOWABLE STORY DRIFT,  $\Delta_a$  (INCHES)<sup>a</sup>**  
**(Table 1617.3.1 attached to end of document)**

**1617.3.2 Structural separations.** All structures shall be separated from adjacent structures. When a structure adjoins a property line not common to a public way (typically side or rear lot lines), that structure shall also be set back from the property line by at least 1 inch (25 mm) for each 50 feet (15 240) of height. For structures in Seismic Design Category D, refer to Section 1620.4.5 for additional requirements.

**Exception:** Smaller separations or property line setbacks shall be permitted when justified by rational analysis based on maximum expected ground motions.

**1617.4 Equivalent lateral force procedure for seismic design of buildings.** The provisions given in Section 9.5.5 of ASCE 7 shall be used with modifications. Modify Table 9.5.5.3.2 "Values of Approximate Period Parameters  $C_T$  and  $x$ " to include the following:

<u>Structure Type</u>	<u><math>C_T</math></u>	<u><math>x</math></u>
<u>Dual systems where the building height exceeds 400 feet (122 m)</u>	<u><math>0.03 (0.07)^a</math></u>	<u>0.75</u>
<u>Dual systems where the building height (h) exceeds 160 feet (48 768 mm) but is</u>	<u><math>0.02 + 0.01 \times [h-160]/240</math> <u><math>(0.055 + 0.015 \times [h-48.8]/73.2)^a</math></u></u>	<u>0.75</u>

less than 400 feet (122 m)		
----------------------------	--	--

<sup>a</sup>**Metric equivalents are shown in parenthesis.**

**1617.5 Simplified analysis procedure for seismic design of buildings.** See Section 1616.6.1 for limitations on the use of this procedure. For purposes of this analytical procedure, a building is considered to be fixed at the base.

**1617.5.1 Seismic base shear.** The seismic base shear,  $V$ , in a given direction shall be determined in accordance with the following equation:

**(Equation 16-56 attached to end of document)**

where:

$S_{DS}$  = The design elastic response acceleration at short period as determined in accordance with Section 1615.1.3.

$R$  = The response modification factor from Table 1617.6.2.

$W$  = The effective seismic weight of the structure, including the total dead load and other loads listed below:

1. In areas used for storage, a minimum of 25 percent of the reduced floor live load (floor live load in public garages and open parking structures need not be included).
2. Where an allowance for partition load is included in the floor load design, the actual partition weight or a minimum weight of 10 psf of floor area, whichever is greater (0.48 kN/m<sup>2</sup>).
3. Total weight of permanent operating equipment.
4. 20 percent of flat roof snow load where flat snow load exceeds 30 psf (1.44 kN/m<sup>2</sup>).

**1617.5.2 Vertical distribution.** The forces at each level shall be calculated using the following equation:

**(Equation 16-57 attached to end of document)**

where:

$w_x$  = The portion of the effective seismic weight of the structure,  $W$ , at Level  $x$ .

**1617.5.3 Horizontal distribution.** Diaphragms constructed of untopped steel decking or wood structural panels or similar light-framed construction are permitted to be considered as flexible.



**1617.5.4 Design drift.** For the purposes of Sections 1617.3.1 and 1620.4.6, the design story drift,  $\Delta$ , shall be taken as 1 percent of the story height unless a more exact analysis is provided.

**1617.6 Seismic-force-resisting systems.** The provisions given in Section 9.5.2.2 of ASCE 7 shall be used except as modified in Section 1617.6.1.

**Exception:** For structures designed using the simplified analysis procedure in Section 1617.5, the provisions of Section 1617.6.2 shall be used.

**1617.6.1 Modifications to ASCE 7, Section 9.5.2.2.**

**1617.6.1.1 ASCE 7, Table 9.5.2.2.** Modify Table 9.5.2.2 as follows:

1. Bearing wall systems: Ordinary reinforced masonry shear walls shall use a response modification coefficient of 2½. Light-framed walls sheathed with wood structural panels rated for shear resistance or steel sheets shall use a response modification coefficient of 6½. Table 1617.6.2 entries for ordinary plain prestressed masonry shear walls, intermediate prestressed masonry shear walls and special prestressed masonry shear walls shall apply.
2. Building frame systems: Ordinary reinforced masonry shear walls shall use a response modification coefficient of 3. Light-framed walls sheathed with wood structural panels rated for shear resistance or steel sheets shall use a response modification coefficient of 7. Table 1617.6.2 entries for ordinary plain prestressed masonry shear walls, intermediate prestressed masonry shear walls and special prestressed masonry shear walls shall apply.
3. Dual systems with intermediate moment frames capable of resisting at least 25 percent of prescribed seismic forces. Special steel concentrically braced frames shall use a deflection amplification factor of 4.
4. The table column titled Detailing Reference Section in Table 1617.6.2 shall apply.

**1617.6.1.2 ASCE 7, Section 9.5.2.2.2.1.** Modify Section 9.5.2.2.2.1 by adding Exception 3 as follows:

3. The following two-stage static analysis procedure is permitted to be used for structures having a flexible upper portion supported on a rigid lower portion where both portions of the structure considered separately can be classified as being regular, the average story stiffness of the lower portion is at least 10 times the average story stiffness of the upper portion and the period of the entire structure is not greater than 1.1 times the period of the upper portion considered as a separate structure fixed at the base:

- 3.1. The flexible upper portion shall be designed as a separate structure using the appropriate values of  $R$  and  $\rho$ .
- 3.2. The rigid lower portion shall be designed as a separate structure using the appropriate values of  $R$  and  $\rho$ . The reactions from the upper portion shall be those determined from the analysis of the upper portion amplified by the ratio of the  $R/\rho$  of the upper portion over  $R/\rho$  of the lower portion. This ratio shall no be less than 1.0.

**1617.6.1.3 ASCE 7, Section 9.5.2.2.4.3.** Modify Section 9.5.2.2.4.3 by changing exception to read as follows:

**Exception:** Reinforced concrete frame members not designed as part of the seismic-force-resisting system and slabs shall comply with Section 21.11 of Ref. 9.9-1.

**1617.6.2 Seismic-force-resisting systems (for use in the Simplified analysis procedure of Section 1617.5).** The basic lateral and vertical seismic-force-resisting systems shall conform to one of the types indicated in Table 1617.6.2 subject to the limitations on height indicated in the table based on seismic design category as determined in Section 1616. The appropriate response modification coefficient,  $R$ , system over-strength factor,  $\Omega_0$ , and deflection amplification factor,  $C_d$ , indicated in Table 1617.6.2 shall be used in determining the base shear, element design forces and design story drift. For seismic-force-resisting systems not listed in Table 1617.6.2, analytical and test data shall be submitted that establish the dynamic characteristics and demonstrate the lateral-force resistance and energy dissipation capacity to be equivalent to the structural systems listed in Table 1617.6.2 for equivalent response modification coefficient,  $R$ , system over-strength coefficient,  $\Omega_0$ , and deflection amplification factor,  $C_d$ , values. Buildings shall not exceed the limitations of Section 1616.6.1.

**TABLE 1617.6.2**  
**DESIGN COEFFICIENT AND FACTORS FOR BASIC SEISMIC-FORCE-RESISTING**  
**SYSTEMS**  
**(Table 1617.6.2 attached to end of document)**

**1617.6.2.1 Dual systems.** For a dual system, the moment frame shall be capable of resisting at least 25 percent of the design forces. The total seismic force resistance is to be provided by the combination of the moment frame and the shear walls or braced frames in proportion to their stiffness.

**1617.6.2.2 Combination along the same axis.** For other than dual systems and shear wall-frame interactive systems, where a combination of different structural systems is utilized to resist lateral forces in the same direction, the value,  $R$ , used for design in that direction shall not be greater than the least value for any of the systems utilized in that same direction.

**Exception:** For light-framed, flexible diaphragm buildings, of Seismic Use Group I and two stories or less in height: Resisting elements are permitted to be designed

using the least value of  $R$  for the different structural systems found on each independent line of resistance. The value of  $R$  used for design of diaphragms in such structures shall not be greater than the least value for any of the systems utilized in that same direction.

**1617.6.2.3 Combinations of framing systems.** Where different seismic-force-resisting systems are used along the two orthogonal axes of the structure, the appropriate response modification coefficient,  $R$ , system over-strength factor,  $\Omega_0$ , and deflection amplification factor,  $C_d$ , indicated in Table 1617.6.2 for each system shall be used.

**1617.6.2.3.1 Combination framing factor.** The response modification coefficient,  $R$ , in the direction under consideration at any story shall not exceed the lowest response modification coefficient,  $R$ , for the seismic-force-resisting system in the same direction considered above that story, excluding penthouses. The system over-strength factor,  $\Omega_0$ , in the direction under consideration at any story, shall not be less than the largest value of this factor for the seismic-force-resisting system in the same direction considered above that story. In structures assigned to Seismic Design Category D, if a system with a response modification coefficient,  $R$ , with a value less than five is used as part of the seismic-force-resisting system in any direction of the structure, the lowest such value shall be used for the entire structure.

**Exceptions:**

1. Detached one- and two-family dwellings constructed of light framing.
2. The response modification coefficient,  $R$ , and system over-strength factor,  $\Omega_0$ , for supported structural systems with a weight equal to or less than 10 percent of the weight of the structure are permitted to be determined independent of the values of these parameters for the structure as a whole.
3. The following two-stage static analysis procedure is permitted to be used for structures having a flexible upper portion supported on a rigid lower portion where both portions of the structure considered separately can be classified as being regular, the average story stiffness of the lower portion is at least 10 times the average story stiffness of the upper portion and the period of the entire structure is not greater than 1.1 times the period of the upper portion considered as a separate structure fixed at the base:
  - 3.1. The flexible upper portion shall be designed as a separate structure using the appropriate values of  $R$  and  $\rho$ .
  - 3.2. The rigid lower portion shall be designed as a separate structure using the appropriate values of  $R$  and  $\rho$ . The reactions from the upper portion shall be those determined from the analysis of the upper portion amplified by the ratio of,  $R/\rho$ , of the upper portion over,  $R/\rho$ , of the lower portion. This ratio shall not be less than 1.0.

**1617.6.2.3.2 Combination framing detailing requirements.** The detailing requirements of Section 1620 required by the higher response modification coefficient,  $R$ , shall be used for structural components common to systems having different response modification coefficients.

**1617.6.2.4 System limitations for Seismic Design Category D.** In addition to the system limitation indicated in Table 1617.6.2, structures assigned to Seismic Design Category D shall be subject to the following.

**1617.6.2.4.1 Interaction effects.** Moment-resisting frames that are enclosed or adjoined by stiffer elements not considered to be part of the seismic-force-resisting system shall be designed so that the action or failure of those elements will not impair the vertical load and seismic-force-resisting capability of the frame. The design shall consider and provide for the effect of these rigid elements on the structural system at deformations corresponding to the design story drift,  $\Delta$ , as determined in Section 1617.5.4. In addition, the effects of these elements shall be considered when determining whether a structure has one or more of the irregularities defined in Section 1616.5.1.

**1617.6.2.4.2 Deformational compatibility.** Every structural component not included in the seismic-force-resisting system in the direction under consideration shall be designed to be adequate for vertical load-carrying capacity and the induced moments and shears resulting from the design story drift,  $\Delta$ , as determined in accordance with Section 1617.5.4. Where allowable stress design is used,  $\Delta$  shall be computed without dividing the earthquake force by 1.4. The moments and shears induced in components that are not included in the seismic-force-resisting system in the direction under consideration shall be calculated including the stiffening effects of adjoining rigid structural and nonstructural elements.

**Exception:** Reinforced concrete frame members not designed as part of the seismic-force-resisting system shall comply with Section 21.11 of ACI 318.

**1617.6.2.4.3 Special moment frames.** A special moment frame that is used but not required by Table 1617.6.2 is permitted to be discontinued and supported by a stiffer system with a lower response modification coefficient,  $R$ , provided the requirements of Sections 1620.2.3 and 1620.4.1 are met. Where a special moment frame is required by Table 1617.6.2, the frame shall be continuous to the foundation.

## **SECTION BC 1618**

### **DYNAMIC ANALYSIS PROCEDURE FOR THE SEISMIC DESIGN OF BUILDINGS**

**1618.1 Dynamic analysis procedures.** The following dynamic analysis procedures are permitted to be used in lieu of the equivalent lateral force procedure of Section 1617.4:

1. Modal Response Spectral Analysis.

2. Linear Time-history Analysis.
3. Nonlinear Time-history Analysis. The dynamic analysis procedures listed above shall be performed in accordance with the requirements of Sections 9.5.6, 9.5.7 and 9.5.8, respectively, of ASCE 7.

**SECTION BC 1619**  
**EARTHQUAKE LOADS SOIL-STRUCTURE INTERACTION EFFECTS**

**1619.1 Analysis procedure.** If soil-structure interaction is considered in the determination of seismic design forces and corresponding displacements in the structure, the procedure given in Section 9.5.9 of ASCE 7 shall be used.

**SECTION BC 1620**  
**EARTHQUAKE LOADS—DESIGN, DETAILING REQUIREMENTS AND**  
**STRUCTURAL COMPONENT LOAD EFFECTS**

**1620.1 Structural component design and detailing.** The design and detailing of the components of the seismic-force-resisting system shall comply with the requirements of Section 9.5.2.6 of ASCE 7 in addition to the nonseismic requirements of this code except as modified in Sections 1620.1.1, 1620.1.2 and 1620.1.3.

**Exception:** For structures designed using the simplified analysis procedure in Section 1617.5, the provisions of Sections 1620.2 through 1620.5 shall be used.

**1620.1.1 ASCE 7, Section 9.5.2.6.2.5.** Section 9.5.2.6.2.5 of ASCE 7 shall not apply.

**1620.1.2 ASCE 7, Section 9.5.2.6.2.11.** Modify ASCE 7, Section 9.5.2.6.2.11, to read as follows:

9.5.2.6.2.11 Elements supporting discontinuous walls or frames. Columns, beams, trusses or slabs supporting discontinuous walls or frames of structures and the connections of the discontinuous element to the supporting member having plan irregularity Type 4 of Table 9.5.2.3.2 or vertical irregularity Type 4 of Table 9.5.2.3.3 shall have the design strength to resist the maximum axial force that can develop in accordance with the special seismic loads of Section 9.5.2.7.1.

**Exceptions:**

1. The quantity  $E$  in Section 9.5.2.7.1 need not exceed the maximum force that can be transmitted to the element by the lateral-force-resisting system at yield.
2. Concrete slabs supporting light-framed walls.

**1620.1.3 ASCE 7, Section 9.5.2.6.3.** Modify ASCE 7, Section 9.5.2.6.3, to read as follows:

9.5.2.6.3 Seismic Design Category C. Structures assigned to Category C shall conform to the requirements of Section 9.5.2.6.2 for Category B and to the requirements of this section. Structures that have plan structural irregularity Type 1a or 1b of Table 9.5.2.3.2 along both principal plan axes, or plan structural irregularity Type 5 of Table 9.5.2.3.2, shall be analyzed for seismic forces in compliance with Section 9.5.2.5.2.2. When the square root of the sum of the squares method of combining directional effects is used, each term computed shall be assigned the sign that will yield the most conservative result.

The orthogonal combination procedure of Section 9.5.2.5.2.2, Item a, shall be required for any column or wall that forms part of two or more intersecting seismic-force-resisting systems and is subjected to axial load due to seismic forces acting along either principal plan axis equaling or exceeding 20 percent of the axial load design strength of the column or wall.

**1620.2 Structural component design and detailing (for use in the simplified analysis procedure of Section 1617.5).** The design and detailing of the components of the seismic-force-resisting system for structures designed using the simplified analysis procedure in Section 1617.5 shall comply with the requirements of this section in addition to the nonseismic requirements of this code. Buildings shall not exceed the limitations of Section 1616.6.1.

**Exception:** Structures assigned to Seismic Design Category B (see Section 1616) shall conform to Sections 1620.2.1 through 1620.2.10.

**1620.2.1 Second-order load effects.** Where  $\theta$  exceeds 0.10 as determined in Section 9.5.5.7.2 in ASCE 7, second-order load effects shall be included in the evaluation of component and connection strengths.

**1620.2.2 Openings.** Where openings occur in shear walls, diaphragms or other plate-type elements, reinforcement at the edges of the openings shall be designed to transfer the stresses into the structure. The edge reinforcement shall extend into the body of the wall or diaphragm a distance sufficient to develop the force in the reinforcement.

**1620.2.3 Discontinuities in vertical system.** Structures with a discontinuity in lateral capacity, vertical irregularity Type 5, as defined in Table 1616.5.1.2, shall not be over two stories or 30 feet (9144 mm) in height where the “weak” story has a calculated strength of less than 65 percent of the story above.

**Exception:** Where the “weak” story is capable of resisting a total seismic force equal to the over-strength factor,  $\Omega_o$ , as given in Table 1617.6.2, multiplied by the design force prescribed in Section 1617.5, the height limitation does not apply.

**1620.2.4 Connections.** All parts of the structure, except at separation joints, shall be interconnected and the connections shall be designed to resist the seismic force,  $F_p$ , induced by the parts being connected. Any smaller portion of the structure shall be tied to the remainder of the structure for the greater of:

**(Equation 16-58 attached to end of table)**

or  
**(Equation 16-59 attached to end of table)**

$S_{DS}$  = The design, 5-percent damped, spectral response acceleration at short periods as defined in Section 1615.

$w_p$  = The weight of the smaller portion.

A positive connection for resisting a horizontal force acting parallel to the member shall be provided for each beam, girder or truss to its support for a force not less than 5 percent of the dead plus live load reaction.

**1620.2.5 Diaphragms.** Permissible deflection shall be that deflection up to which the diaphragm and any attached distributing or resisting element will maintain its structural integrity under design load conditions, such that the resisting element will continue to support design loads without danger to occupants of the structure.

Floor and roof diaphragms shall be designed to resist  $F_p$  as follows:

**(Equation 16-60 attached to end of table)**

where:

$F_p$  = The seismic force induced by the parts.

$I_E$  = Occupancy importance factor (Table 1604.5).

$S_{DS}$  = The short-period site design spectral response acceleration coefficient (Section 1615).

$w_p$  = The weight of the diaphragm and other elements of the structure attached to the diaphragm.

$V_{px}$  = The portion of the seismic shear force at the level of the diaphragm, required to be transferred to the components of the vertical seismic-force-resisting system because of the offsets or changes in stiffness of the vertical components above or below the diaphragm.

Diaphragms shall provide for both shear and bending stresses resulting from these forces. Diaphragms shall have ties or struts to distribute the wall anchorage forces into the diaphragm. Diaphragm connections shall be positive, mechanical or welded-type connections.

**1620.2.6 Collector elements.** Collector elements shall be provided that are capable of transferring the seismic forces originating in other portions of the structure to the element providing the resistance to those forces. Collector elements, splices and their connections to resisting elements shall have the design strength to resist the special load combinations of Section 1605.4.

**Exception:** In structures or portions thereof braced entirely by light-framed shear walls, collector elements, splices and connections to resisting elements need only have the strength to resist the load combinations of Section 1605.2 or 1605.3.

**1620.2.7 Bearing walls and shear walls.** Bearing walls and shear walls and their anchorage shall be designed for an out-of-plane force,  $F_p$ , that is the greater of 10 percent of the weight of the wall, or the quantity given by Equation 16-61:

**(Equation 16-61 attached to end of document)**

where:

$I_E$  = Occupancy importance factor (Table 1604.5).

$S_{DS}$  = The short-period site design spectral response acceleration coefficient (Section 1615.1.3 or 1615.2.5).

$w_w$  = The weight of the wall.

In addition, concrete and masonry walls shall be anchored to the roof and floors and members that provide lateral support for the wall or that are supported by the wall. The anchorage shall provide a direct connection between the wall and the supporting construction capable of resisting the greater of the force,  $F_p$ , as given by Equation 16-61 or  $(400 S_{DS} I_E)$  pounds per linear foot of wall. For SI:  $5838 S_{DS} I_E$  N/m. Walls shall be designed to resist bending between anchors where the anchor spacing exceeds 4 feet (1219 mm). Parapets shall conform to the requirements of Section 9.6.2.2 of ASCE 7.

**1620.2.8 Inverted pendulum-type structures.** Supporting columns or piers of inverted pendulum-type structures shall be designed for the bending moment calculated at the base determined using the procedures given in Section 1617.4 and varying uniformly to a moment at the top equal to one-half the calculated bending moment at the base.

**1620.2.9 Elements supporting discontinuous walls or frames.** Columns or other elements subject to vertical reactions from discontinuous walls or frames of structures having plan irregularity Type 4 of Table 1616.5.1.1 or vertical irregularity Type 4 of Table 1616.5.1.2 shall have the design strength to resist special seismic load combinations of Section 1605.4. The connections from the discontinuous walls or frames to the supporting elements need not have the design strength to resist the special seismic load combinations of Section 1605.4.

**Exceptions:**

1. The quantity,  $E_m$ , in Section 1617.1.1.2 need not exceed the maximum force that can be transmitted to the element by the lateral-force-resisting system at yield.
2. Concrete slabs supporting light-framed walls.

**1620.2.10 Direction of seismic load.** The direction of application of seismic forces used in



design shall be that which will produce the most critical load effect in each component. The requirement will be deemed satisfied if the design seismic forces are applied separately and independently in each of the two orthogonal directions.

**1620.3 Seismic Design Category C.** Structures assigned to Seismic Design Category C (see Section 1616) shall conform to the requirements of Section 1620.2 for Seismic Design Category B and to Sections 1620.3.1 through 1620.3.2.

**1620.3.1 Anchorage of concrete or masonry walls.** Concrete or masonry walls shall be anchored to floors and roofs and members that provide out-of-plane lateral support for the wall or that are supported by the all. The anchorage shall provide a positive direct connection between the wall and floor or roof capable of resisting the horizontal forces specified in Equation 16-62 for structures with flexible diaphragms or in Section 9.6.1.3 of ASCE 7 (using  $a_p$  of 1.0 and  $R_p$  of 2.5) for structures with diaphragms that are not flexible.

**(Equation 16-62 attached to end of document)**

where:

$F_p$  = The design force in the individual anchors.

$I_E$  = Occupancy importance factor in accordance with Section 1616.2.

$S_{DS}$  = The design earthquake spectral response acceleration at short period in accordance with Section 1615.1.3.

$w_w$  = The weight of the wall tributary to the anchor.

Diaphragms shall be provided with continuous ties or struts between diaphragm chords to distribute these anchorage forces into the diaphragms. Where added chords are used to form subdiaphragms, such chords shall transmit the anchorage forces to the main cross ties. The maximum length-to-width ratio of the structural subdiaphragm shall be 2½ to 1. Connections and anchorages capable of resisting the prescribed forces shall be provided between the diaphragm and the attached components. Connections shall extend into the diaphragms a sufficient distance to develop the force transferred into the diaphragm.

The strength design forces for steel elements of the wall anchorage system shall be 1.4 times the force otherwise required by this section.

In wood diaphragms, the continuous ties shall be in addition to the diaphragm sheathing. Anchorage shall not be accomplished by use of toenails or nails subject to withdrawal, nor shall wood ledgers or framing be used in cross-grain bending or cross-grain tension. The diaphragm sheathing shall not be considered effective as providing the ties or struts required by this section.

In metal deck diaphragms, the metal deck shall not be used as the continuous ties

required by this section in the direction perpendicular to the deck span.

Diaphragm-to-wall anchorage using embedded straps shall be attached to or hooked around the reinforcing steel or otherwise terminated so as to directly transfer force to the reinforcing steel.

**1620.3.2 Direction of seismic load.** For structures that have plan structural irregularity Type 1a or 1b of Table 1616.5.1.1 along both principal plan axes, or plan structural irregularity Type 5 in Table 1616.5.1.1, the critical direction requirement of Section 1620.2.10 shall be deemed satisfied if components and their foundations are designed for the following orthogonal combination of prescribed loads.

One hundred percent of the forces for one direction plus 30 percent of the forces for the perpendicular direction. The combination requiring the maximum component strength shall be used. Alternatively, the effects of the two orthogonal directions are permitted to be combined on a square root of the sum of the squares (SRSS) basis. When the SRSS method of combining directional effects is used, each term computed shall be assigned the sign that will result in the most conservative result.

The orthogonal combination procedure above shall be required for any column or wall that forms part of two or more intersecting seismic-force-resisting systems and is subjected to axial load due to seismic forces acting along either principal plan axis equaling or exceeding 20 percent of the axial load design strength of the column or wall.

**1620.4 Seismic Design Category D.** Structures assigned to Seismic Design Category D shall conform to the requirements of Section 1620.3 for Seismic Design Category C and to Sections 1620.4.1 through 1620.4.6.

**1620.4.1 Plan or vertical irregularities.** For buildings having a plan structural irregularity of Type 1a, 1b, 2, 3 or 4 in Table 1616.5.1.1 or a vertical structural irregularity of Type 4 in Table 1616.5.1.2, the design forces determined from Section 1617.5 shall be increased 25 percent for connections of diaphragms to vertical elements and to collectors, and for connections of collectors to the vertical elements.

**Exception:** When connection design forces are determined using the special seismic load combinations of Section 1605.4

**1620.4.2 Vertical seismic forces.** In addition to the applicable load combinations of Section 1605, horizontal cantilever and horizontal prestressed components shall be designed to resist a minimum net upward force of 0.2 times the dead load.

**1620.4.3 Diaphragms.** Floor and roof diaphragms shall be designed to resist design seismic forces determined in accordance with Equation 16-63 as follows:

**(Equation 16-63 attached to end of document )**

where:

$F_i$  = The design force applied to Level  $i$ .

$F_{px}$  = The diaphragm design force.

$w_i$  = The weight tributary to Level  $i$ .

$w_{px}$  = The weight tributary to the diaphragm at Level  $x$ .

The force determined from Equation 16-63 need not exceed  $0.4S_{DS}I_Ew_{px}$  but shall not be less than  $0.2S_{DS}I_Ew_{px}$  where  $S_{DS}$  is the design spectral response acceleration at short period determined in Section 1615.1.3 and  $I_E$  is the occupancy importance factor determined in Section 1616.2. When the diaphragm is required to transfer design seismic force from the vertical-resisting elements above the diaphragm to other vertical-resisting elements below the diaphragm due to offsets in the placement of the elements or to changes in relative lateral stiffness in the vertical elements, these forces shall be added to those determined from Equation 16-63 and to the upper and lower limits on that equation.

**1620.4.4 Collector elements.** Collector elements shall be provided that are capable of transferring the seismic forces originating in other portions of the structure to the element providing resistance to those forces.

Collector elements, splices and their connections to resisting elements shall resist the forces determined in accordance with Equation 16-63. In addition, collector elements, splices and their connections to resisting elements shall have the design strength to resist the earthquake loads as defined in the special load combinations of Section 1605.4.

**Exception:** In structures, or portions thereof, braced entirely by light-framed shear walls, collector elements, splices and their connections to resisting elements need only be designed to resist forces in accordance with Equation 16-63.

**1620.4.5 Building separations.** All structures shall be separated from adjoining structures. Separations shall allow for the displacement  $\delta_M$ . Adjacent buildings on the same property shall be separated by at least  $\delta_{MT}$  where

**(Equation 16-64 attached to end of document)**

and  $\delta_{M1}$  and  $\delta_{M2}$  are the displacements of the adjacent buildings.

When a structure adjoins a property line not common to a public way, that structure shall also be set back from the property line by at least the displacement,  $\delta_M$ , of that structure.

**Exception:** Smaller separations or property line setbacks shall be permitted when justified by rational analyses based on maximum expected ground motions.

**1620.4.6 Anchorage of concrete or masonry walls to flexible diaphragms.** In addition to the requirements of Section 1620.3.1, concrete and masonry walls shall be anchored to flexible diaphragms based on the following:

1. When elements of the wall anchorage system are not loaded concentrically or are not perpendicular to the wall, the system shall be designed to resist all components of the forces induced by the eccentricity.
2. When pilasters are present in the wall, the anchorage force at the pilasters shall be calculated considering the additional load transferred from the wall panels to the pilasters. The minimum anchorage at a floor or roof shall not be less than that specified in Item 1.

**1620.5 Reserved.**

**SECTION BC 1621**  
**ARCHITECTURAL, MECHANICAL AND ELECTRICAL COMPONENT SEISMIC**  
**DESIGN REQUIREMENTS**

**1621.1 Component design.** Architectural, mechanical, electrical and nonstructural systems, components and elements permanently attached to structures, including supporting structures and attachments (hereinafter referred to as “components”), and nonbuilding structures that are supported by other structures, shall meet the requirements of Section 9.6 of ASCE 7 except as modified in Sections 1621.1.1, 1621.1.2 and 1621.1.3, excluding Section 9.6.3.11.2, of ASCE 7, as amended in this section.

**1621.1.1 ASCE 7, Section 9.6.3.11.2:** Section 9.6.3.11.2 of ASCE 7 shall not apply.

**1621.1.2 ASCE 7, Section 9.6.2.8.1.** Modify ASCE 7, Section 9.6.2.8.1, to read as follows:

9.6.2.8.1 General. Partitions that are tied to the ceiling and all partitions greater than 6 feet (1829 mm) in height shall be laterally braced to the building structure. Such bracing shall be independent of any ceiling splay bracing. Bracing shall be spaced to limit horizontal deflection at the partition head to be compatible with ceiling deflection requirements as determined in Section 9.6.2.6 for suspended ceilings and Section 9.6.2.6 for other systems.

**Exception:** Partitions not taller than 9 feet (2743 mm) when the horizontal seismic load does not exceed 5 psf (0.240 KN/m<sup>2</sup>) required in Section 1607.13.

**1621.1.3 ASCE 7, Section 9.6.3.13.** Modify ASCE 7, Section 9.6.3.13, to read as follows:

9.6.3.13 Mechanical equipment, attachments and supports. Attachments and supports for mechanical equipment not covered in Sections 9.6.3.8 through 9.6.3.12 or Section 9.6.3.16 shall be designed to meet the force and displacement provisions of Section 9.6.1.3 and 9.6.1.4 and the additional provisions of this section. In addition to their

attachments and supports, such mechanical equipment designated as having an  $I_p = 1.5$ , which contains hazardous or flammable materials in quantities that exceed the maximum allowable quantities for an open system listed in Section 307, shall, itself, be designed to meet the force and displacement provisions of Sections 9.6.1.3 and 9.6.1.4 and the additional provisions of this section. The seismic design of mechanical equipment, attachments and their supports shall include analysis of the following: the dynamic effects of the equipment, its contents and, when appropriate, its supports. The interaction between the equipment and the supporting structures, including other mechanical and electrical equipment, shall also be considered.

## **SECTION BC 1622** **NONBUILDING STRUCTURES SEISMIC DESIGN REQUIREMENTS**

**1622.1 Nonbuilding structures.** The requirements of Section 9.14 of ASCE 7 shall apply to nonbuilding structures except as modified by Sections 1622.1.1, 1622.1.2 and 1622.1.3.

**1622.1.1 ASCE 7, Section 9.14.5.1.** Modify Section 9.14.5.1, Item 9, to read as follows:

9. Where an approved national standard provides a basis for the earthquake-resistant design of a particular type of nonbuilding structure covered by Section 9.14, such a standard shall not be used unless the following limitations are met:

1. The seismic force shall not be taken as less than 80 percent of that given by the remainder of Section 9.14.5.1.
2. The seismic ground acceleration, and seismic coefficient, shall be in conformance with the requirements of Sections 9.4.1 and 9.4.1.2.5, respectively.
3. The values for total lateral force and total base overturning moment used in design shall not be less than 80 percent of the base shear value and overturning moment, each adjusted for the effects of soil structure interaction that is obtained by using this standard.

**1622.1.2 ASCE 7, Section 9.14.7.2.1.** Modify Section 9.14.7.2.1 to read as follows:

9.14.7.2.1 General. This section applies to all earth-retaining walls. The applied seismic forces shall be determined in accordance with Section 9.7.5.1 with a geotechnical analysis prepared by a registered design professional.

The seismic use group shall be determined by the proximity of the retaining wall to other nonbuilding structures or buildings. If failure of the retaining wall would affect an adjacent structure, the seismic use group shall not be less than that of the adjacent structure, as determined in Section 9.1.3. Earth-retaining walls are permitted to be designed for seismic loads as either yielding or nonyielding walls. Cantilevered reinforced concrete retaining walls shall be assumed to be yielding walls and shall be designed as simple flexural wall elements.

**1622.1.3 ASCE 7, Section 9.14.7.9.** Add a new Section 9.14.7.9 to read as follows:

9.14.7.9 Buried structures. As used in this section, the term “buried structures” means subgrade structures such as tanks, tunnels and pipes. Buried structures that are designated as Seismic Use Group II or III, as determined in Section 9.1.3, or are of such a size or length as to warrant special seismic design as determined by the registered design professional, shall be identified in the geotechnical report. Buried structures shall be designed to resist seismic lateral forces determined from a substantiated analysis using standards approved by the commissioner. Flexible couplings shall be provided for buried structures where changes in the support system, configurations or soil condition occur.

### **SECTION BC 1623** **SEISMICALLY ISOLATED STRUCTURES**

**1623.1 Design requirements.** Every seismically isolated structure and every portion thereof shall be designed and constructed in accordance with the requirements of Section 9.13 of ASCE 7, except as modified in Section 1623.1.1.

**1623.1.1 ASCE 7, Section 9.13.6.2.3.** Modify ASCE 7, Section 9.13.6.2.3, to read as follows:

9.13.6.2.3 Fire resistance. Fire-resistance ratings for the isolation system shall comply with Section 714.7 of the *New York City Building Code*.

### **SECTION BC 1624** **STRUCTURAL INTEGRITY DEFINITIONS**

**1624.1 Definitions.** The following words and terms shall, for the purposes of this section, have the meanings shown herein.

**ALTERNATE LOAD PATH.** A secondary or redundant load path capable of transferring the load from one structural element to other structural elements.

**ALTERNATE LOAD PATH METHOD.** A design approach that accounts for an extreme event by providing alternate load paths for elements that are no longer able to carry load. In an alternate load path design, key elements are considered notionally removed, one at a time, and the structure is designed to transfer the loads from the removed element to other structural elements, as required by Section 1626.

**ASPECT RATIO.** The height of any portion of a building divided by its least dimension at the elevation from which the height is being measured.

**COLLAPSE.** Failure of a structural element to the extent that it can no longer support any load.

**ELEMENT.** A structural member or structural assembly.

**KEY ELEMENT.** An element of the structural system, including its connections, that meets one or more of the following criteria:

1. An element which when lost, results in more than local collapse.
2. An element that braces a key element, the failure of which results in failure of the key element (further secondary elements need not be considered key elements).

**LOCAL COLLAPSE.** Failure of a structural element that results in the collapse of areas being directly supported by that element and not extending vertically more than three stories.

**RESPONSE RATIO.** The ratio of an ultimate response quantity (e.g., deflection) to its value at yield.

**ROTATION.** The angle, measured at the ends of a member, whose tangent is equal to the deflection of the member at mid-span divided by half the length of the member.

**SPECIFIC LOCAL LOAD.** A load applied to a structural element or structural system as specified in Section 1626.7.

**SPECIFIC LOCAL RESISTANCE METHOD.** A design approach that accounts for extreme event loads by providing sufficient strength for elements that may fail. In a specific local resistance design, key elements are designed for specific local loads as required by Section 1626.

## **SECTION BC 1625** **STRUCTURAL INTEGRITY—PRESCRIPTIVE REQUIREMENTS**

**1625.1 Scope.** The intent of these provisions is to enhance structural performance under extreme event scenarios by providing additional overall system redundancy and local robustness. All structures shall be designed to satisfy the prescriptive requirements of this Section.

**Exception:** Structures in Category I of Table 1604.5 and structures in occupancy group R-3 are exempt from the requirements of Sections 1624 through 1626.

**1625.2 Continuity and ties.** All structural elements shall have a minimum degree of continuity and shall be tied together horizontally and vertically as specified in Chapters 19, 21, and 22 for concrete, masonry and steel, respectively.

**1625.3 Lateral bracing.** Floor and roof diaphragms or other horizontal elements shall be tied to the lateral load resisting system.

**1625.4 Reserved.**

**1625.5 Vehicular impact.** Structural columns that are directly exposed to vehicular traffic shall be designed for vehicular impact. Structural columns that are adequately protected by bollards,

guard walls, vehicle arrest devices or other elements need not be designed for vehicular impact. The load combinations for vehicular impact shall be as specified in Section 1605.7.

Specific loads for vehicular impact shall be as follows:

1. Exterior corner columns shall be designed for a concentrated load of 40 kips applied horizontally in any direction from which a vehicle can approach at a height of either 18 inches (457 mm) or 36 inches (914 mm) above the finished driving surface, whichever creates the worst effect.
2. All other exterior columns exposed to vehicular traffic, and columns within loading docks, and columns in parking garages along the driving lane shall be designed for a concentrated load of 20 kips applied horizontally in any direction from which a vehicle can approach at a height of either 18 inches (457 mm) or 36 inches (914 mm) above the finished driving surface, whichever creates the worst effect.

**1625.6 Gas explosions.** In buildings with gas piping operating at pressures in excess of 15 psig (103 kPa gauge), all key elements and their connections within 15 feet (4572 mm) of such piping shall be designed to resist a potential gas explosion. The structure shall be designed to account for the potential loss of the affected key elements one at a time by the Alternate Load Path Method. Load combinations for the Alternate Load Path shall be as specified in Section 1605.6. In lieu of the Alternate Load Path Method, the affected key elements shall be designed to withstand a load of 430 psf (20.6 kPa) applied using the load combinations specified in Section 1605.7. The load shall be applied along the entire length of the element, and shall be applied in the manner and direction that produces the most damaging effect.

**Exceptions:**

1. If a structural enclosure designed to resist the specified pressure is provided around the high-pressure gas piping, only the key elements within the structural enclosure need to comply with this section.
2. A reduced pressure for gas explosions can be used based on an engineering analysis approved by the commissioner.

**1625.7 Design criteria.** Alternate load path design and/or specific local resistance design shall conform to the appropriate design criteria as determined from Sections 1626.9, 1626.10 and 1626.11. Load combinations for the alternate load path shall be as specified in Section 1605.6.

**SECTION BC 1626**  
**STRUCTURAL INTEGRITY — KEY ELEMENT ANALYSIS**

**1626.1 Scope.** A Key Element Analysis shall be performed for the following buildings:

1. Buildings with Importance Factor Category of IV as defined in this chapter and more than 50,000 square feet (4645 m<sup>2</sup>) of framed area.



2. Buildings with the aspect ratios of seven or greater.
3. Buildings greater than 600 feet (183 m) in height or more than 1,000,000 square feet (92 903 m<sup>2</sup>) in gross floor area.
4. In Buildings taller than seven stories for any element which supports in aggregate more than 15 percent of the building area a Key Element Analysis shall be performed.
5. Buildings designed using non-linear time history analysis or with special seismic energy dissipation systems.
6. Buildings where a structural peer review is requested by the commissioner.

**1626.2 Load combination.** Where specifically required by Sections 1626.1, elements and components shall be designed to resist the forces calculated using the combination specified in Section 1605.6.

**1626.3 Multiple occupancies.** Where a structure is used for two or more occupancies not included in the same category of Table 1604.5, the structure shall be assigned the classification of the highest category corresponding to the various occupancies.

**1626.4 Seismic and wind.** When the code-prescribed seismic or wind design produces greater effects, the seismic or wind design shall govern, but the detailing requirements and limitations prescribed in this and referenced sections shall also be followed

**1626.5 Joints.** Where a structure is divided by joints that allow for movement, each portion of the structure between joints shall be considered as a separate structure.

**1626.6 Key Element Analysis.** Where key elements are present in a structure, the structure shall be designed to account for their potential loss one at a time by the Alternate Load Path Method or by the Specific Local Resistance Method as specified in Section 1626.7.

**1626.7 The Specific Local Resistance Method.** Where the specific local resistance method is used key elements shall be designed using specific local loads as follows:

1. Each compression element shall be designed for a concentrated load equal to 2 percent of its axial load but not less than 15 kips, applied at mid-span in any direction, perpendicular to its longitudinal axis. This load shall be applied in combination with the full dead load and 50 percent of the live load in the compression element.
2. Each bending element shall be designed for the combination of the principal acting moments plus an additional moment, equal to 10 percent of the principal acting moment applied in the perpendicular plane.

3. Connections of each tension element shall be designed to develop the smaller of the ultimate tension capacity of the member or 3 times the force in the member.
4. All structural elements shall be designed for a reversal of load. The reversed load shall be equal to 10 percent of the design load used in sizing the member.

**1626.8 Design criteria.** Alternate load path method and/or specific local resistance method for key elements shall conform to the appropriate design criteria as determined from Sections 1626.9, 1626.10 and 1626.11. Load combinations shall be as specified in Section 1605.6.

**1626.9 Analysis procedures.** All structural analysis for specific local loads and/or key elements shall be made by one of the following methods:

**1626.9.1 Static elastic analysis.** For analysis of this type, dynamic effects of member loss or dynamic effects of specific local loads need not be considered. The structure shall be assumed to remain elastic; however, structural elements may reach yield across their entire cross-section. The response ratio of structural elements so designed shall be limited to one.

**1626.9.2 Dynamic inelastic analysis.** For analysis of this type, dynamic effects of member loss or specific local loads shall be considered. The structure need not remain elastic; however, the response ratio and rotation limits obtained from Table 1626.9.3 shall not be exceeded.

**1626.9.3 Energy methods.** Static inelastic analysis using energy equilibrium may also be used. The structure need not remain elastic; however, the response ratio and rotation limits obtained from Table 1626.9.3 shall not be exceeded.

**TABLE 1626.9.3**  
**RESPONSE RATIO AND ROTATION LIMITS**  
**(Table 1626.9.3 attached to end of document)**

**1626.10 Minimum response.** Structural response of elements determined using a dynamic inelastic analysis shall not be less than 80 percent of the structural response determined using a static elastic analysis.

**1626.11 Strength reduction factors.** For structural design for specific local loads and/or key elements, all strength reduction factors may be taken as one.

**SECTION BC 1627**  
**STRUCTURAL PEER REVIEW**

**1627.1 General.** The provisions of this section specify where structural peer review is required, how and by whom it is to be performed.

**1627.2 Where required.** A structural peer review of the primary structure shall be performed and a report provided for the following buildings:

1. Buildings with Importance Factor Category of IV as defined in this chapter and more than 50,000 square feet (4645 m<sup>2</sup>) of framed area.
2. Buildings with aspect ratios of seven or greater.
3. Buildings greater than 600 feet (183 m) in height or more than 1,000,000 square feet (92 903 m<sup>2</sup>) in gross floor area.
4. Buildings taller than seven stories where any element supports in aggregate more than 15 percent of the building area.
5. Buildings designed using non-linear time history analysis or with special seismic energy dissipation systems.
6. Buildings where a structural peer review is requested by the commissioner.

**1627.3 Structural design review.** It shall be verified that the structural design of the primary structure is in general conformance with the requirements of this code.

**1627.4 Structural peer reviewer.** The structural peer review shall be performed by a qualified independent structural engineer who has been retained by or on behalf of the owner. A structural peer reviewer shall meet the requirements of the rules of the department.

**1627.5 Definitions.** The following words and terms shall, for the purposes of this chapter and as used elsewhere in this code, have the meanings shown herein.

**PRIMARY STRUCTURE.** The structural frame and the load supporting parts of floors, roofs, and walls, and the foundations. Cladding, cladding framing, stairs, equipment supports, ceiling supports, non-load bearing partitions, and railings and other secondary structural items are excluded from this definition of primary structure.

**1627.6 Extent of the structural peer review.**

**1627.6.1 Scope.** The reviewing engineer shall review the plans and specifications submitted with the permit application for general compliance with the structural and foundation design provisions of this code. The reviewing engineer shall perform the following tasks at a minimum:

1. Confirm that the design loads conform to this code.
2. Confirm that other structural design criteria, and design assumptions, conform to this code and are in accordance with generally accepted engineering practice.

3. Review geotechnical and other engineering investigations that are related to the foundation and structural design and confirm that the design properly incorporates the results and recommendations of the investigations.
4. Confirm that the structure has a complete load path.
5. Perform independent calculations for a representative fraction of systems, members, and details to check their adequacy. The number of representative systems, members, and details verified shall be sufficient to form a basis for the reviewer's conclusions.
6. Verify that performance-specified structural components (such as certain precast concrete elements) have been appropriately specified and coordinated with the primary building structure.
7. Confirm that the structural integrity provisions of the code are being followed.
8. Review the structural and architectural plans for the building. Confirm that the structural plans are in general conformance with the architectural plans regarding loads and other conditions that may affect the structural design.
9. Confirm that major mechanical items are accommodated in the structural plans.
10. Attest to the general completeness of the structural plans and specifications.

**1627.6.2 Structural calculations.** The structural calculations prepared by the structural engineer of record shall be submitted to the reviewing engineer, upon the reviewing engineer's request, for reference only. The reviewing engineer shall not be obliged to review or check these calculations. If the design criteria and design assumptions are not shown on the drawings or in the computations, the structural engineer of record shall provide a statement of these criteria and assumptions for the reviewer.

### **1627.7 Structural peer review report.**

**1627.7.1 General.** The reviewing engineer shall submit a report to the department stating whether or not the structural design shown on the plans and specifications generally conforms to the structural and foundation requirements of this code.

**1627.7.2 Contents.** The report shall demonstrate at a minimum compliance with items 1 through 10 of section 1630.6.1. In addition, the report shall also include the following:

1. The codes and standards used in the structural design of the project.
2. The structural design criteria, including loads and performance requirements.
3. The basis for design criteria that are not specified directly in applicable codes and standards. This should include reports by specialty consultants such as wind tunnel

study reports and geotechnical reports. Generally, the report should confirm that existing conditions at the site have been investigated as appropriate and that the design of the proposed structure is in general conformance with these conditions.

**1627.7.3 Phased submission.** If an application is submitted for a permit for the construction of foundations or any other part of a building before the construction documents for the whole building have been submitted, then the structural peer review and report shall be phased. The structural peer reviewer shall be provided with sufficient information on which to make a structural peer review of the phased submission.

## **1627.8 Responsibility.**

**1627.8.1 Structural engineer of record.** The structural engineer of record shall retain sole responsibility for the structural design. The activities and reports of the structural peer reviewer shall not relieve the structural engineer of record of this responsibility.

**1627.8.2 Structural peer reviewer.** The structural peer reviewer's report states his or her opinion regarding the design by the engineer of record. The standard of care to which the structural peer reviewer shall be held in the performance of the structural peer review and report is that level of skill and care consistent with structural peer review services performed by professional engineers licensed in the State of New York for similar types of projects.

$$1.4D \quad \text{(Equation 16-1)}$$

$$1.2D + 1.6L + 0.5(L_r \text{ or } S \text{ or } R) \quad \text{(Equation 16-2)}$$

$$1.2D + 1.6W + f_1 L + 0.5(L_r \text{ or } S \text{ or } R) \quad \text{(Equation 16-4)}$$

$$1.2D + 1.0E + f_1 L + f_2 S \quad \text{(Equation 16-5)}$$

$$0.9D + (1.0E \text{ or } 1.6W) \quad \text{(Equation 16-6)}$$

where:

$f_1$  = 1.0 for floors in places of public assembly, for live loads in excess of 100 pounds per square foot (4.79 kN/m<sup>2</sup>), and for parking garage live load.

$f_1$  = 0.5 for other live loads.

$f_2$  = 0.7 for roof configurations (such as saw tooth) that do not shed snow off the structure.

$f_2$  = 0.2 for other roof configurations.

**Exception:** Where other factored load combinations are specifically required by the provisions of this code, such combinations shall take precedence.

$$D \quad \text{(Equation 16-7)}$$

$$D+L \quad \text{(Equation 16-8)}$$

$$D+L+(L_r \text{ or } S \text{ or } R) \quad \text{(Equation 16-9)}$$

$$D+(W \text{ or } 0.7E)+L+(L_r \text{ or } S \text{ or } R) \quad \text{(Equation 16-10)}$$

$$0.6D+W \quad \text{(Equation 16-11)}$$

$$0.6D+0.7E \quad \text{(Equation 16-12)}$$

$$L = L_o \left( 0.25 + \frac{15}{\sqrt{K_{LL} A_T}} \right) \quad \text{(Equation 16-21)}$$

$$\text{For SI: } L = L_o \left( 0.25 + \frac{4.57}{\sqrt{K_{LL} A_T}} \right)$$

where:

$L$  = Reduced design live load per square foot (meter) of area supported by the member.

$L_o$  = Unreduced design live load per square foot (meter) of area supported by the member (see Table 1607.1).

$K_{LL}$  = Live load element factor (see Table 1607.9.1).

$A_T$  = Tributary area, in square feet (square meters).  $L$  shall not be less than  $0.50L_o$  for members supporting one floor and  $L$  shall not be less than  $0.40L_o$  for members supporting two or more floors.

$$R = r(A - 150) \quad \text{(Equation 16-22)}$$

$$\text{For SI: } R = r(A - 13.94)$$

Such reduction shall not exceed 40 percent for horizontal members, 60 percent for vertical members, nor  $R$  as determined by the following equation:

$$R = 23.1(1 + D/L_o) \quad \text{(Equation 16-23)}$$

where:

$A$  = Area of floor or roof supported by the member, square feet ( $\text{m}^2$ ).

$D$  = Dead load per square foot ( $\text{m}^2$ ) of area supported.

$L_o$  = Unreduced live load per square foot ( $\text{m}^2$ ) of area supported.

$R$  = Reduction in percent.

$r$  = Rate of reduction equal to 0.08 percent for floors.

$$D+L+(L_r \text{ or } S \text{ or } R) \quad \text{(Equation 16-13)}$$

$$D+L+(\omega W) \quad \text{(Equation 16-14)}$$

$$D+L+\omega W+S/2 \quad \text{(Equation 16-15)}$$

$$D+L+S+\omega W/2 \quad \text{(Equation 16-16)}$$

$$D+L+S+E/1.4 \quad \text{(Equation 16-17)}$$

$$0.9D+E/1.4 \quad \text{(Equation 16-18)}$$

$$L_r = 20R_1R_2 \quad \text{(Equation 16-24)}$$

where:  $12 \leq L_r \leq 20$

$$\text{For SI: } L_r = 0.96 R_1R_2$$

where:  $0.58 \leq L_r \leq 0.96$

$L_r$  = Roof live load per square foot ( $\text{m}^2$ ) of horizontal projection in pounds per square foot ( $\text{kN/m}^2$ ).

The reduction factors  $R_1$  and  $R_2$  shall be determined as follows:

$$R_1 = 1 \quad \text{for } A_t \leq 200 \text{ square feet} \\ \text{(18.58 m}^2\text{)} \quad \text{(Equation 16-25)}$$

$$R_1 = 1.2 - 0.001A_t \quad \text{for } 200 \text{ square feet} < A_t < \\ 600 \text{ square feet} \quad \text{(Equation 16-26)}$$

$$\text{For SI: } 1.2 - 0.011A_t \quad \text{for } 18.58 \text{ square meters} < A_t < \\ 55.74 \text{ square meters}$$

$$R_1 = 0.6 \quad \text{for } A_t \geq 600 \text{ square feet} \\ \text{(55.74 m}^2\text{)} \quad \text{(Equation 16-27)}$$

where:

$A_t$  = Tributary area (span length multiplied by effective width) in square feet ( $\text{m}^2$ ) supported by any structural member, and

$F$  = for a sloped roof, the number of inches of rise per foot (for SI:  $F = 0.12 \times$  slope, with slope expressed in percentage points), and

$F$  = for an arch or dome, rise-to-span ratio multiplied by 32, and

$$R_2 = 1 \quad \text{for } F \leq 4 \quad \text{(Equation 16-28)}$$

$$R_2 = 1.2 - 0.05 F \quad \text{for } 4 < F < 12 \quad \text{(Equation 16-29)}$$

$$R_2 = 0.6 \quad \text{for } F \geq 12 \quad \text{(Equation 16-30)}$$

$$1.2D + f_1L + E_m \quad (\text{Equation 16-19})$$

$$0.9D + E_m \quad (\text{Equation 16-20})$$

$$L = L_o \left( 0.25 + \frac{15}{\sqrt{K_{LL} A_T}} \right) \quad (\text{Equation 16-21})$$

$$\text{For SI: } L = L_o \left( 0.25 + \frac{4.57}{\sqrt{K_{LL} A_T}} \right)$$

$$R = r(A - 150) \quad (\text{Equation 16-22})$$

$$\text{For SI: } R = r(A - 13.94)$$

$$R = 23.1(1 + D/L_o) \quad (\text{Equation 16-23})$$

$$L_r = 20R_1R_2 \quad (\text{Equation 16-24})$$

$$R_1 = 1 \quad \text{for } A_t \leq 200 \text{ square feet} \\ \text{(18.58 m}^2\text{)} \quad (\text{Equation 16-25})$$

$$R_1 = 1.2 - 0.001A_t \quad \text{for } 200 \text{ square feet} < A_t < \\ 600 \text{ square feet} \quad (\text{Equation 16-26})$$

$$\text{For SI: } 1.2 - 0.011A_t \quad \text{for } 18.58 \text{ square meters} < A_t < \\ 55.74 \text{ square meters}$$

$$R_1 = 0.6 \quad \text{for } A_t \geq 600 \text{ square feet} \\ \text{(55.74 m}^2\text{)} \quad (\text{Equation 16-27})$$

$$R_2 = 1 \quad \text{for } F \leq 4 \quad (\text{Equation 16-28})$$

$$R_2 = 1.2 - 0.05 F \quad \text{for } 4 < F < 12 \quad (\text{Equation 16-29})$$

$$R_2 = 0.6 \quad \text{for } F \geq 12 \quad (\text{Equation 16-30})$$



$$A_o \geq 0.8A_g \quad \text{(Equation 16-31)}$$

where:

$A_o$  = Total area of openings in a wall that receives positive external pressure, in square feet (m<sup>2</sup>).

$A_g$  = The gross area of that wall in which  $A_o$  is identified, in square feet (m<sup>2</sup>).

$$A_o > 1.10A_{oi} \quad \text{(Equation 16-32)}$$

$$A_o > 4 \text{ square feet (0.37 m}^2\text{) or } > 0.01A_g, \text{ whichever is smaller, and } A_{oi}/A_{gi} \leq 0.20 \quad \text{(Equation 16-33)}$$

where:

$A_o, A_g$  are as defined for an open building.

$A_{oi}$  = The sum of the areas of openings in the building envelope (walls and roof) not including  $A_o$ , in square feet (m<sup>2</sup>).

$A_{gi}$  = The sum of the gross surface areas of the building envelope (walls and roof) not including  $A_g$ , in square feet (m<sup>2</sup>).

$$p_s = \lambda I_w p_{s30} \quad \text{(Equation 16-34)}$$

where:

$\lambda$  = Adjustment factor for building height and exposure from Table 1609.6.2.1(4).

$I_w$  = Importance factor as defined in Section 1609.5

$p_{s30}$  = Simplified design wind pressure for Exposure B, at  $h = 30$  feet (9144 mm), and for  $I_w = 1.0$ , from Table 1609.6.2.1(1).

$$P_{net} = \lambda I_w P_{netB0} \quad (\text{Equation 16-35})$$

where:

- $\lambda$  = Adjustment factor for building height and exposure from Table 1609.6.2.1(4).
- $I_w$  = Importance factor as defined in Section 1609.5.
- $P_{netB0}$  = Net design wind pressure for Exposure B, at  $h = 30$  feet (9144 mm), and for  $I_w = 1.0$ , from Tables 1609.6.2.1(2) and 1609.6.2.1(3).

$$M_a = q_h C_L b L L_a [1.0 - G C_p] \quad (\text{Equation 16-36})$$

$$\text{For SI: } M_a = \frac{q_h C_L b L L_a [1.0 - G C_p]}{1,000}$$

where:

- $b$  = Exposed width, feet (mm) of the roof tile.
- $C_L$  = Lift coefficient. The lift coefficient for concrete and clay tile shall be 0.2 or shall be determined by test in accordance with Section 1715.2.
- $G C_p$  = Roof pressure coefficient for each applicable roof zone determined from Section 6 of ASCE 7. Roof coefficients shall not be adjusted for internal pressure.
- $L$  = Length, feet (mm) of the roof tile.
- $L_a$  = Moment arm, feet (mm) from the axis of rotation to the point of uplift on the roof tile. The point of uplift shall be taken at  $0.76L$  from the head of the tile and the middle of the exposed width. For roof tiles with nails or screws (with or without a tail clip), the axis of rotation shall be taken as the head of the tile for direct deck application or as the top edge of the batten for battened applications. For roof tiles fastened only by a nail or screw along the side of the tile, the axis of rotation shall be determined by testing. For roof tiles installed with battens and fastened only by a clip near the tail of the tile, the moment arm shall be determined about the top edge of the batten with consideration given for the point of rotation of the tiles based on straight bond or broken bond and the tile profile.
- $M_a$  = Aerodynamic uplift moment, feet-pounds (N-mm) acting to raise the tail of the tile.
- $q_h$  = Wind velocity pressure, psf (kN/m<sup>2</sup>) determined from Section 6.5.10 of ASCE 7.

$$R = 5.2 (d_s + d_h) \quad \text{(Equation 16-37)}$$

For SI:  $R = 0.0098 (d_s + d_h)$

where:

- $d_h$  = Additional depth of water on the undeflected roof above the inlet of secondary drainage system at its design flow (i.e., the hydraulic head), in inches (mm).
- $d_s$  = Depth of water on the undeflected roof up to the inlet of secondary drainage system when the primary drainage system is blocked (i.e., the static head), in inches (mm).
- $R$  = Rain load on the undeflected roof, in psf (kN/m<sup>2</sup>). When the phrase “undeflected roof” is used, deflections from loads (including dead loads) shall not be considered when determining the amount of rain on the roof.

**{ NOTE: Modify Equation 16-43 below as follows: replace “(Section 1617.4.2).” with “(see Section 9.5.5.3 of ASCE 7).” }**

$$S_{MS} = F_a S_s \quad (\text{Equation 16-38})$$

$$S_{M1} = F_v S_1 \quad (\text{Equation 16-39})$$

where:

$F_a$  = Site coefficient defined in Table 1615.1.2(1).

$F_v$  = Site coefficient defined in Table 1615.1.2(2).

$S_s$  = The mapped spectral accelerations for short periods as determined in Section 1615.1.

$S_1$  = The mapped spectral accelerations for a 1-second period as determined in Section 1615.1.

$$S_{DS} = \frac{2}{3} S_{MS} \quad (\text{Equation 16-40})$$

$$S_{DI} = \frac{2}{3} S_{M1} \quad (\text{Equation 16-41})$$

where:

$S_{MS}$  = The maximum considered earthquake spectral response accelerations for short period as determined in Section 1615.1.2.

$S_{M1}$  = The maximum considered earthquake spectral response accelerations for 1-second period as determined in Section 1615.1.2.

$$S_a = 0.6 \frac{S_{DS}}{T_O} T + 0.4 S_{DS} \quad (\text{Equation 16-42})$$

$$S_a = \frac{S_{DI}}{T} \quad (\text{Equation 16-43})$$

where:

$S_{DS}$  = The design spectral response acceleration at short periods as determined in Section 1615.1.3.

$S_{DI}$  = The design spectral response acceleration at 1-second period as determined in Section 1615.1.3.

$T$  = Fundamental period (in seconds) of the structure (Section 1617.4.2).

$T_O$  =  $0.2 S_{DI}/S_{DS}$

$T_S$  =  $S_{DI}/S_{DS}$

$$\bar{v}_s = \frac{\sum_{i=1}^n d_i}{\sum_{i=1}^n v_n} \quad (\text{Equation 16-44})$$

$$\sum_{i=1}^n d_i = 100 \text{ feet (30 480 mm)}$$

$N_i$  is the Standard Penetration Resistance (ASTM D 1586-84) not to exceed 100 blows/foot (mm) as directly measured in the field without corrections.

$$\bar{N} = \frac{\sum_{i=1}^n d_i}{\sum_{i=1}^n \frac{d_i}{N_i}} \quad (\text{Equation 16-45})$$

$$\bar{N}_{ch} = \frac{d_s}{\sum_{i=1}^m \frac{d_i}{N_i}} \quad (\text{Equation 16-46})$$

where:

$$\sum_{i=1}^m d_i = d_s$$

Use only  $d_i$  and  $N_i$  for cohesionless soils.

$d_s$  = The total thickness of cohesionless soil layers in the top 100 feet (30 480 mm).

$s_{ui}$  = The undrained shear strength in psf (kPa), not to exceed 5,000 psf (240 kPa), ASTM D 2166-91 or D 2850-87.

$$\bar{s}_u = \frac{d_c}{\sum_{i=1}^k \frac{d_i}{s_{ui}}} \quad (\text{Equation 16-47})$$

where:

$$\sum_{i=1}^k d_i = d_c$$

$d_c$  = The total thickness ( $100 - d_s$ ) (For SI:  $30\,480 - d_s$ ) of cohesive soil layers in the top 100 feet (30 480 mm).

$PI$  = The plasticity index, ASTM D 4318.

$w$  = The moisture content in percent, ASTM D 2216.

$$S_a = \frac{2}{3} S_{aM} \quad (\text{Equation 16-48})$$

**{NOTE: DELETE EQUATION 16-49 BELOW}**

$$F_x = 0.01 w_x \quad (\text{Equation 16-49})$$

where:

- $F_x$  = The design lateral force applied at Level  $x$ .
- $w_x$  = The portion of the total gravity load of the structure,  $W$ , located or assigned to Level  $x$ .
- $W$  = The total dead load and other loads listed below:
  1. In areas used for storage, a minimum of 25 percent of the reduced floor live load (floor live load in public garages and open parking structures need not be included).
  2. Where an allowance for partition load is included in the floor load design, the actual partition weight or a minimum weight of 10 psf (0.479 kN/m<sup>2</sup>) of floor area, whichever is greater.
  3. Total operating weight of permanent equipment.
  4. Twenty percent of flat roof snow load where flat roof snow load exceeds 30 psf (1.44 kN/m<sup>2</sup>).

$$E = \rho Q_E + 0.2 S_{DS} D \quad (\text{Equation 16-50})$$

where:

- $D$  = The effect of dead load.
- $E$  = The combined effect of horizontal and vertical earthquake-induced forces.
- $\rho$  = A redundancy coefficient obtained in accordance with Section 1617.2.
- $Q_E$  = The effect of horizontal seismic forces.
- $S_{DS}$  = The design spectral response acceleration at short periods obtained from Section 1615.1.3 or 1615.2.5.

$$E = \rho Q_E - 0.2 S_{DS} D \quad (\text{Equation 16-51})$$

$$E_m = \Omega_0 Q_E + 0.2 S_{DS} D \quad (\text{Equation 16-52})$$

$$E_m = \Omega_0 Q_E - 0.2 S_{DS} D \quad (\text{Equation 16-53})$$

where  $E$ ,  $Q_E$ ,  $S_{DS}$  are as defined above and  $\Omega_0$  is the system overstrength factor as given in Table 1617.6.2.

The term  $\Omega_0 Q_E$  need not exceed the maximum force that can be transferred to the element by the other elements of the lateral-force-resisting system.

Where allowable stress design methodologies are used with the special load combinations of Section 1605.4, design strengths are permitted to be determined using an allowable stress increase of 1.7 and a resistance factor,  $\phi$ , of 1.0. This increase shall not be combined with increases in allowable stresses or load combination reductions otherwise permitted by this code or the material reference standard except that combination with the duration of load increases in Chapter 23 is permitted.

$$\rho_i = 2 - \frac{20}{r_{max,i} \sqrt{A_i}} \quad (\text{Equation 16-54})$$

For SI:

$$\rho_i = 2 - \frac{6.1}{r_{max,i} \sqrt{A_i}}$$

where:

$r_{max,i}$  = The ratio of the design story shear resisted by the most heavily loaded single element in the story to the total story shear, for a given direction of loading.

$r_{max,i}$  = For braced frames, the value  $r_{max,i}$ , is equal to the horizontal force component in the most heavily loaded brace element divided by the story shear.

$r_{max,i}$  = For moment frames,  $r_{max,i}$ , shall be taken as the maximum of the sum of the shears in any two adjacent columns in a moment frame divided by the story shear. For columns common to two bays with moment-resisting connections on opposite sides at the level under consideration, it is permitted to use 70 percent of the shear in that column in the column shear summation.

$r_{max,i}$  = For shear walls,  $r_{max,i}$ , shall be taken as the maximum value of the product of the shear in the wall or wall pier and  $10/l_w$  ( $3.3/l_w$  for SI), divided by the story shear, where  $l_w$  is the length of the wall or wall pier in feet (m). In light-framed construction, the value of the ratio of  $10/l_w$  need not be greater than 1.0.

$r_{max,i}$  = For dual systems,  $r_{max,i}$ , shall be taken as the maximum value defined above, considering all lateral-load-resisting elements in the story. The lateral loads shall be distributed to elements based on relative rigidities considering the interaction of the dual system. For dual systems, the value of  $r$  need not exceed 80 percent of the value calculated above.

$A_i$  = The floor area in square feet of the diaphragm level immediately above the story.

For a story with a flexible diaphragm immediately above,  $r_{max,i}$  shall be permitted to be calculated from an analysis that assumes rigid diaphragm behavior and  $\rho$  need not exceed 1.25.

The value,  $\rho$ , shall not be less than 1.0, and need not exceed 1.5.

Calculation of  $r_{max,i}$  need not consider the effects of accidental torsion and any dynamic amplification of torsion required by Section 9.5.5.5.2 of ASCE 7.

For structures with seismic-force-resisting systems in any direction comprised solely of special moment frames, the seismic-force-resisting system shall be configured such that the value of  $\rho$  calculated in accordance with this section does not exceed 1.25 for structures assigned to Seismic Design Category D, and does not exceed 1.1 for structures assigned to Seismic Design Category E or F.

**Exception:** The calculated value of  $\rho$  is permitted to exceed these limits when the design story drift,  $\Delta$ , as determined in Section 1617.5.4, does not exceed  $\Delta_d/\rho$  for any story where  $\Delta_d$  is the allowable story drift from Table 1617.3.1.

The value  $\rho$  shall be permitted to be taken equal to 1.0 in the following circumstances:

1. When calculating displacements for dynamic amplification of torsion in Section 9.5.5.5.2 of ASCE 7.
2. When calculating deflections, drifts and seismic shear forces related to Sections 9.5.5.7.1 and 9.5.5.7.2 of ASCE 7.
3. For design calculations required by Section 1620, 1621 or 1622.

For structures with vertical combinations of seismic-force-resisting systems, the value,  $\rho$ , shall be determined independently for each seismic-force-resisting system. The redundancy coefficient of the lower portion shall not be less than the following:

$$\rho_L = \frac{R_L \rho_u}{R_u} \quad (\text{Equation 16-55})$$

where:

$\rho_L$  =  $\rho$  of lower portion.

$R_L$  =  $R$  of lower portion.

$\rho_u$  =  $\rho$  of upper portion.

$R_u$  =  $R$  of upper portion.

$$V = \frac{1.2S_{DS}}{R}W \quad (\text{Equation 16-56})$$

where:

$S_{DS}$  = The design elastic response acceleration at short period as determined in accordance with Section 1615.1.3.

$R$  = The response modification factor from Table 1617.6.2.

$W$  = The effective seismic weight of the structure, including the total dead load and other loads listed below:

1. In areas used for storage, a minimum of 25 percent of the reduced floor live load (floor live load in public garages and open parking structures need not be included).
2. Where an allowance for partition load is included in the floor load design, the actual partition weight or a minimum weight of 10 psf of floor area, whichever is greater (0.48 kN/m<sup>2</sup>).
3. Total weight of permanent operating equipment.
4. 20 percent of flat roof snow load where flat snow load exceeds 30 psf (1.44 kN/m<sup>2</sup>).

$$F_x = \frac{1.2S_{DS}}{R}w_x \quad (\text{Equation 16-57})$$

where:

$w_x$  = The portion of the effective seismic weight of the structure,  $W$ , at Level  $x$ .

$$F_p = 0.133S_{DS}w_p \quad (\text{Equation 16-58})$$

or

$$F_p = 0.05w_p \quad (\text{Equation 16-59})$$

where:

$S_{DS}$  = The design, 5-percent damped, spectral response acceleration at short periods as defined in Section 1615.

$w_p$  = The weight of the smaller portion.

$$F_p = 0.2I_E S_{DS}w_p + V_{px} \quad (\text{Equation 16-60})$$

where:

$F_p$  = The seismic force induced by the parts.

$I_E$  = Occupancy importance factor (Table 1604.5).

$S_{DS}$  = The short-period site design spectral response acceleration coefficient (Section 1615).

$w_p$  = The weight of the diaphragm and other elements of the structure attached to the diaphragm.

$V_{px}$  = The portion of the seismic shear force at the level of the diaphragm, required to be transferred to the components of the vertical seismic-force-resisting system because of the offsets or changes in stiffness of the vertical components above or below the diaphragm.

$$F_p = 0.40I_E S_{DS}w_w \quad (\text{Equation 16-61})$$

where:

$I_E$  = Occupancy importance factor (Table 1604.5).

$S_{DS}$  = The short-period site design spectral response acceleration coefficient (Section 1615.1.3 or 1615.2.5).

$w_w$  = The weight of the wall.

$$F_p = 0.8S_{DS}I_E w_w \quad (\text{Equation 16-62})$$

where:

$F_p$  = The design force in the individual anchors.

$I_E$  = Occupancy importance factor in accordance with Section 1616.2.

$S_{DS}$  = The design earthquake spectral response acceleration at short period in accordance with Section 1615.1.3.

$w_w$  = The weight of the wall tributary to the anchor.

$$F_{px} = \frac{\sum_{i=x}^n F_i}{\sum_{i=x}^n w_i} w_{px} \quad (\text{Equation 16-63})$$

where:

$F_i$  = The design force applied to Level  $i$ .

$F_{px}$  = The diaphragm design force.

$w_i$  = The weight tributary to Level  $i$ .

$w_{px}$  = The weight tributary to the diaphragm at Level  $x$ .

$$\delta_{MT} = \sqrt{(\delta_{M1})^2 + (\delta_{M2})^2} \quad (\text{Equation 16-64})$$

and  $\delta_{M1}$  and  $\delta_{M2}$  are the displacements of the adjacent buildings.

$$\underline{D + f_1L + f_2W} \quad \text{(Equation 16-65)}$$

Where:

$$\underline{f_1 = 0.25 \text{ for buildings in Category II.}}$$

$$\underline{f_1 = 0.5 \text{ for buildings in Category III or IV.}}$$

$$\underline{f_2 = 0 \text{ for buildings in Category II.}}$$

$$\underline{f_2 = 0.33 \text{ for buildings in Category III or IV.}}$$

The live load component  $f_1L$  need not be greater than the reduced live load.

$$\underline{1.2D + A_k + (0.5L \text{ or } 0.2S)} \quad \text{(Equation 16-66)}$$

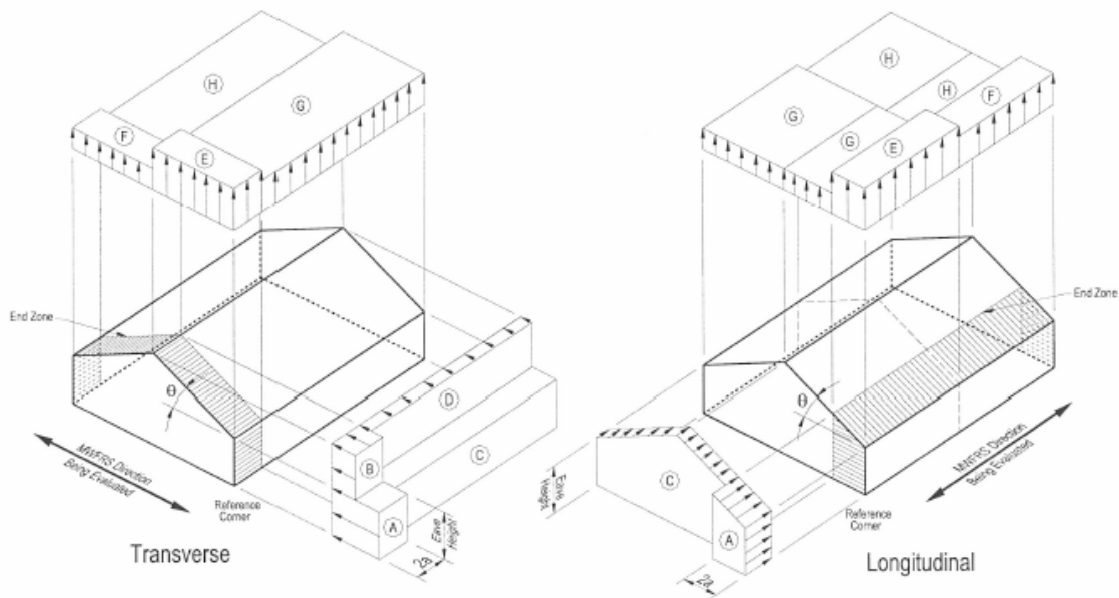
$$\underline{0.9D + A_k + 0.2W} \quad \text{(Equation 16-67)}$$

Where  $A_k$  is the load effect of the vehicular impact or gas explosion.





FIGURE 1608.2  
GROUND SNOW LOADS,  $p_g$ , FOR THE UNITED STATES (psf)



**FIGURE 1609.6.2.1  
MAIN WINDFORCE LOADING DIAGRAM**

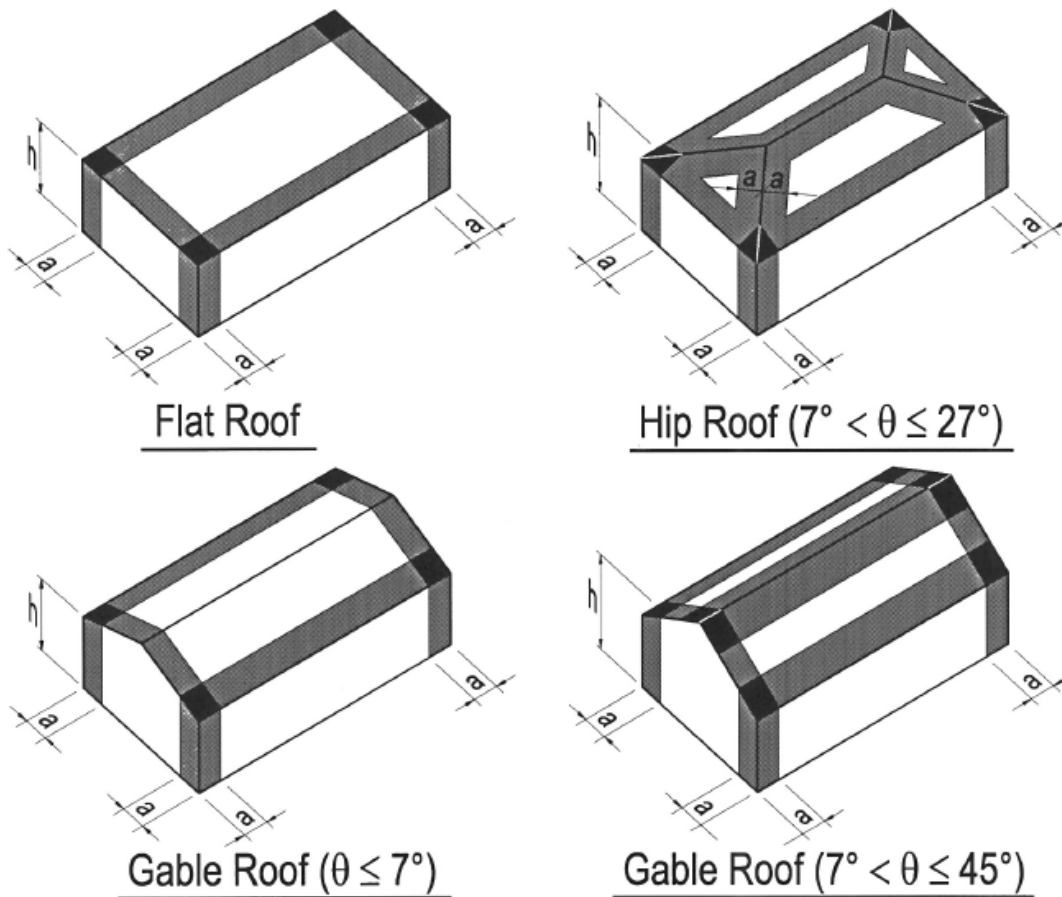
For SI: 1 foot = 304.8 mm, 1 degree = 0.0174 rad.

**Notes:**

1. Pressures are applied to the horizontal and vertical projections for Exposure B, at  $h = 30$  feet, for  $I_w = 1.0$ . Adjust to other exposures and heights with adjustment factor  $\lambda$ .
2. The load patterns shown shall be applied to each corner of the building in turn as the reference corner.
3. For the design of the longitudinal MWFRS, use  $\theta = 0^\circ$ , and locate the Zone E/F, G/H boundary at the mid-length of the building.
4. Load Cases 1 and 2 must be checked for  $25^\circ < \theta \leq 45^\circ$ . Load Case 2 at  $25^\circ$  is provided only for interpolation between  $25^\circ$  to  $30^\circ$ .
5. Plus and minus signs signify pressures acting toward and away from the projected surfaces, respectively.
6. For roof slopes other than those shown, linear interpolation is permitted.
7. The total horizontal load shall not be less than that determined by assuming  $p_s = 0$  in Zones B and D.
8. The zone pressures represent the following:
  - Horizontal pressure zones — Sum of the windward and leeward net (sum of internal and external) pressures on vertical projection of:
 

A — End zone of wall	C — Interior zone of wall
B — End zone of roof	D — Interior zone of roof
  - Vertical pressure zones — Net (sum of internal and external) pressures on horizontal projection of:
 

E — End zone of windward roof	G — Interior zone of windward roof
F — End zone of leeward roof	H — Interior zone of leeward roof
9. Where Zone E or G falls on a roof overhang on the windward side of the building, use  $E_{OH}$  and  $G_{OH}$  for the pressure on the horizontal projection of the overhang. Overhangs on the leeward and side edges shall have the basic zone pressure applied.
10. Notation:
  - $a$ : 10 percent of least horizontal dimension or 0.4h, whichever is smaller, but not less than either 4 percent of least horizontal dimension or 3 feet.
  - $h$ : Mean roof height, in feet (meters), except that eave height shall be used for roof angles  $< 10^\circ$ .
  - $\theta$ : Angle of plane of roof from horizontal, in degrees.



**FIGURE 1609.6.2.2  
COMPONENT AND CLADDING PRESSURE**

For SI: 1 foot = 304.8 mm, 1 degree = 0.0174 rad.

**Notes:**

1. Pressures are applied normal to the surface for Exposure B, at  $h = 30$  feet, for  $I_w = 1.0$ . Adjust to other exposures and heights with adjustment factor  $\lambda$ .
2. Plus and minus signs signify pressures acting toward and away from the surfaces, respectively.
3. For hip roofs with  $\theta \leq 25^\circ$ , Zone 3 shall be treated as Zone 2.
4. For effective areas between those given, the value is permitted to be interpolated, otherwise use the value associated with the lower effective area.
5. Notation:
  - $a$ : 10 percent of least horizontal dimension or  $0.4h$ , whichever is smaller, but not less than either 4 percent of least horizontal dimension or 3 feet.
  - $h$ : Mean roof height, in feet (meters), except that eave height shall be used for roof angles  $< 10^\circ$ .
  - $\theta$ : Angle of plane of roof from horizontal, in degrees.



### Interior Zones

Roofs - Zone 1 / Walls - Zone 4



### End Zones

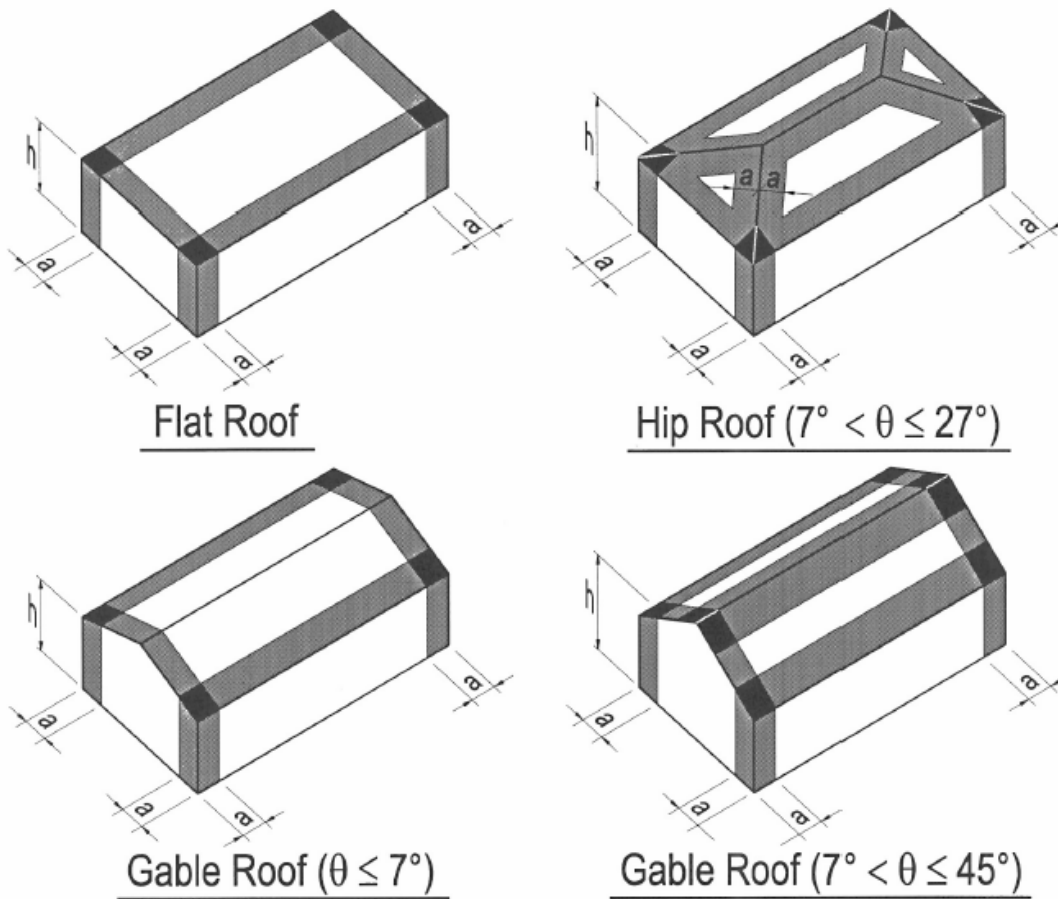
Roofs - Zone 2 / Walls - Zone 5



### Corner Zones

Roofs - Zone 3

---



**FIGURE 1609.6.2.2**  
**COMPONENT AND CLADDING PRESSURE**

For SI: 1 foot = 304.8 mm, 1 degree = 0.0174 rad.

**Notes:**

1. Pressures are applied normal to the surface for Exposure B, at  $h = 30$  feet, for  $I_w = 1.0$ . Adjust to other exposures and heights with adjustment factor  $\lambda$ .
2. Plus and minus signs signify pressures acting toward and away from the surfaces, respectively.
3. For hip roofs with  $\theta \leq 25^\circ$ , Zone 3 shall be treated as Zone 2.
4. For effective areas between those given, the value is permitted to be interpolated, otherwise use the value associated with the lower effective area.
5. Notation:
  - $a$ : 10 percent of least horizontal dimension or  $0.4h$ , whichever is smaller, but not less than either 4 percent of least horizontal dimension or 3 feet.
  - $h$ : Mean roof height, in feet (meters), except that eave height shall be used for roof angles  $< 10^\circ$ .
  - $\theta$ : Angle of plane of roof from horizontal, in degrees.

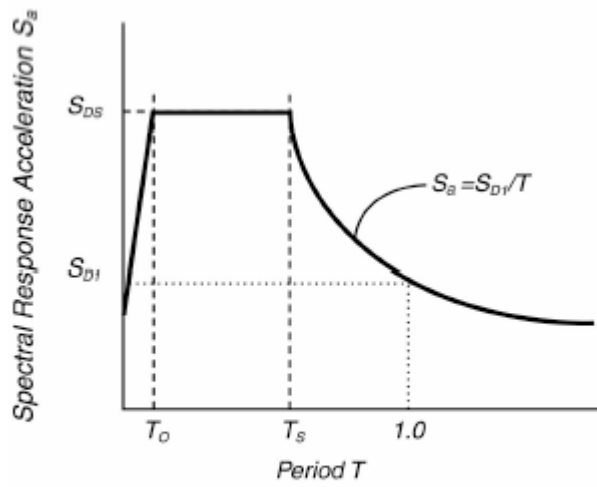


FIGURE 1615.1.4  
DESIGN RESPONSE SPECTRUM

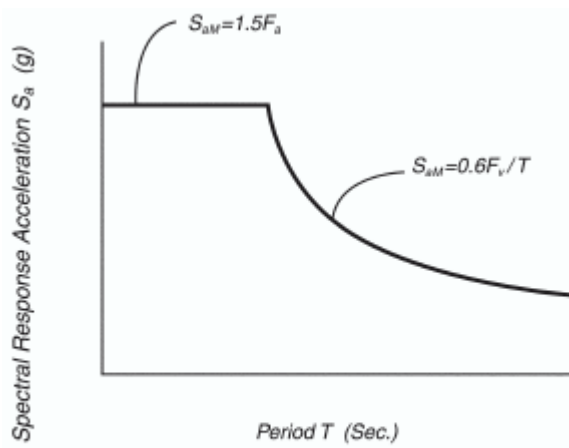


FIGURE 1615.2.2  
DETERMINISTIC LIMIT ON MAXIMUM CONSIDERED  
EARTHQUAKE RESPONSE SPECTRUM

**TABLE 1604.3**  
**DEFLECTION LIMITS<sup>a, b, c, h, i</sup>**

CONSTRUCTION	<i>L</i>	<i>S</i> or <i>W</i> <sup>f</sup>	<i>D</i> + <i>L</i> <sup>d, g</sup>
Roof members: <sup>e</sup>			
Supporting plaster ceiling	<i>l</i> /360	<i>l</i> /360	<i>l</i> /240
Supporting nonplaster ceiling	<i>l</i> /240	<i>l</i> /240	<i>l</i> /180
Not supporting ceiling	<i>l</i> /180	<i>l</i> /180	<i>l</i> /120
Floor members	<i>l</i> /360	—	<i>l</i> /240
Exterior walls and interior partitions:			
With brittle finishes	—	<i>l</i> /240	—
With flexible finishes	—	<i>l</i> /120	—
Farm buildings	—	—	<i>l</i> /180
Greenhouses	—	—	<i>l</i> /120

For SI: 1 foot = 304.8 mm.

- a. For structural roofing and siding made of formed metal sheets, the total load deflection shall not exceed *l*/60. For secondary roof structural members supporting formed metal roofing, the live load deflection shall not exceed *l*/150. For secondary wall members supporting formed metal siding, the design wind load deflection shall not exceed *l*/90. For roofs, this exception only applies when the metal sheets have no roof covering.
- b. Interior partitions not exceeding 6 feet in height and flexible, folding and portable partitions are not governed by the provisions of this section. The deflection criterion for interior partitions is based on the horizontal load defined in Section 1607.13.
- c. See Section 2403 for glass supports.
- d. For wood structural members having a moisture content of less than 16 percent at time of installation and used under dry conditions, the deflection resulting from *L* + 0.5*D* is permitted to be substituted for the deflection resulting from *L* + *D*.
- e. The above deflections do not ensure against ponding. Roofs that do not have sufficient slope or camber to assure adequate drainage shall be investigated for ponding. See Section 1611 for rain and ponding requirements and Section 1503.4 for roof drainage requirements.
- f. The wind load is permitted to be taken as 0.7 times the "component and cladding" loads for the purpose of determining deflection limits herein.
- g. For steel structural members, the dead load shall be taken as zero.
- h. For aluminum structural members or aluminum panels used in roofs or walls of sunroom additions or patio covers, not supporting edge of glass or aluminum sandwich panels, the total load deflection shall not exceed *l*/60. For aluminum sandwich panels used in roofs or walls of sunroom additions or patio covers, the total load deflection shall not exceed *l*/120.
- i. For cantilever members, *l* shall be taken as twice the length of the cantilever.

**TABLE 1604.5  
CLASSIFICATION OF BUILDINGS AND OTHER STRUCTURES FOR IMPORTANCE FACTORS**

<b>CATEGORY<sup>a</sup></b>	<b>NATURE OF OCCUPANCY</b>	<b>SEISMIC FACTOR I<sub>E</sub></b>	<b>SNOW FACTOR I<sub>S</sub></b>	<b>WIND FACTOR I<sub>W</sub></b>
<b>I</b>	<p><u>Buildings and other structures that represent a low hazard to human life in the event of failure including, but not limited to:</u></p> <ul style="list-style-type: none"> <li>• <u>Agricultural facilities</u></li> <li>• <u>Certain temporary facilities</u></li> <li>• <u>Minor storage facilities</u></li> </ul>	<u>1.00</u>	<u>0.8</u>	<u>0.87</u>
<b>II</b>	<p><u>Buildings and other structures except those listed in Categories I, III and IV</u></p>	<u>1.00</u>	<u>1.0</u>	<u>1.00</u>
<b>III</b>	<p><u>Buildings and other structures that represent a substantial hazard to human life in the event of failure including, but not limited to:</u></p> <ul style="list-style-type: none"> <li>• <u>Buildings and other structures where more than 300 people congregate in one area</u></li> <li>• <u>Buildings and other structures with elementary school, secondary school or day care facilities with an occupant load greater than 250</u></li> <li>• <u>Buildings and other structures with an occupant load greater than 500 for colleges or adult education facilities</u></li> <li>• <u>Health care facilities with an occupant load of 50 or more resident patients but not having surgery or emergency treatment facilities</u></li> <li>• <u>Jails and detention facilities</u></li> <li>• <u>Power-generating stations, water treatment for potable water, waste water treatment facilities and other public utility facilities not included in Category IV</u></li> <li>• <u>Buildings and other structures not included in Category IV containing sufficient quantities of toxic or explosive substances to be dangerous to the public if released</u></li> </ul>	<u>1.25</u>	<u>1.1</u>	<u>1.15</u>
<b>IV</b>	<p><u>Buildings and other structures designed as essential facilities including, but not limited to:</u></p> <ul style="list-style-type: none"> <li>• <u>Hospitals and other health care facilities having surgery or emergency treatment facilities</u></li> <li>• <u>Fire, rescue and police stations and emergency vehicle garages</u></li> <li>• <u>Designated earthquake, hurricane or other emergency shelters</u></li> <li>• <u>Designated emergency preparedness, communication, and operation centers and other facilities required for emergency response</u></li> <li>• <u>Power-generating stations and other public utility facilities required as emergency backup facilities for Category IV structures</u></li> <li>• <u>Structures containing highly toxic materials as defined by Section 307 where the quantity of the material exceeds the maximum allowable quantities of Table 307.7(2)</u></li> <li>• <u>Aviation control towers, air traffic control centers and</u></li> </ul>	<u>1.50</u>	<u>1.2</u>	<u>1.15</u>



	<u>emergency aircraft hangars</u> <ul style="list-style-type: none"><li>• <u>Buildings and other structures having critical national defense functions</u></li><li>• <u>Water treatment facilities required to maintain water pressure for fire suppression</u></li></ul>			
--	---	--	--	--

a. For the purpose of Section 1616.2, Categories I and II are considered Seismic Use Group I, Category III is considered Seismic Use Group II and Category IV is equivalent to Seismic Use Group III.

**TABLE 1607.1**  
**MINIMUM UNIFORMLY DISTRIBUTED LIVE LOADS AND MINIMUM**  
**CONCENTRATED LIVE LOADS – g.i**

<u>OCCUPANCY OR USE</u>	<u>UNIFORM (psf)</u>	<u>CONCENTRATED (lbs.)</u>
1. Apartments (see residential)	=	=
2. Access floor systems		
Office use	50	2,000
Computer use	100	2,000
3. Armories and drill rooms	150	=
4. Assembly areas and theaters		
Fixed seats (fastened to floor)	60	
Lobbies	100	
Movable seats	100	
Private assembly spaces, including conference rooms and card rooms	50	=
Stages and platforms	125	
Follow spot, projections and control rooms	50	
Catwalks	40	
Other assembly spaces	Note i	
5. Balconies (exterior)	100	=
On one- and two-family residences only, and not exceeding 100 ft. <sup>2</sup>	60	
6. Decks	Same as occupancy served <sup>h</sup>	=
7. Bowling alleys	75	=
8. Cornices	60	=
9. Corridors, except as otherwise indicated	100	=
10. Dance halls and ballrooms	100	=
11. Dining rooms and restaurants	100	=
12. Dwellings (see residential)	=	=
13. Elevator machine room grating (on area of 4 in. <sup>2</sup> )	=	300

<u>OCCUPANCY OR USE</u>	<u>UNIFORM (psf)</u>	<u>CONCENTRATED (lbs.)</u>
Equipment rooms, including pump rooms, generator rooms, transformer vaults, and areas for switch gear, ventilating, air conditioning, and similar electrical and mechanical equipment	75	=
14. Finish light floor plate construction (on area of 1 in. <sup>2</sup> )	=	200
15. Fire escapes (Exterior)		
Single -and multiple family dwellings	100 40	=
16. Garages (passenger vehicles only)	40	Note a
Trucks and buses		See Section 1607.6
17. Grandstands (see stadium and arena bleachers)	=	=
18. Gymnasiums, main floors and balconies	100	=
19. Handrails, guards and grab bars		See Section 1607.7
20. Hospitals		
Operating rooms, laboratories	60	1,000
Private rooms	40	1,000
Wards	40	1,000
Corridors above first floor	80	1,000
21. Hotels (see residential)	=	=
22. Libraries		
Reading rooms	60	1,000
Stack rooms	150 <sup>b</sup>	1,000
Corridors above first floor	80	1,000
23. Manufacturing		
Light	125	2,000
Heavy	250	3,000
24. Marquees	75	=
25. Office buildings		
File and computer rooms shall be designed for heavier loads based on anticipated occupancy		
Lobbies and first-floor corridors	100	2,000
Offices	50	2,000

<u>OCCUPANCY OR USE</u>	<u>UNIFORM (psf)</u>	<u>CONCENTRATED (lbs.)</u>
<u>Corridors above first floor</u>	<u>80</u>	<u>2,000</u>
<b>26. Penal Institutions</b>		
<u>Cell blocks</u>	<u>40</u>	<u>=</u>
<u>Corridors</u>	<u>100</u>	
<b>27. Residential</b>		<u>=</u>
<u>One- and two-family dwellings</u>		
<u>Uninhabitable attics without storage</u>	<u>10</u>	
<u>Uninhabitable attics with storage</u>	<u>20</u>	
<u>Habitable attics and sleeping areas</u>	<u>30</u>	
<u>All other areas except balconies and decks</u>	<u>40</u>	
<u>Hotels and multifamily dwellings</u>		
<u>Private rooms and corridors serving them</u>	<u>40</u>	
<u>Public rooms and corridors serving them</u>	<u>100</u>	
<b>28. Reviewing stands, grandstands and bleachers</b>	<u>Note c</u>	<u>=</u>
<b>29. Roofs</b>	<u>See Section 1607.11</u>	
<b>30. Schools</b>		
<u>Classrooms</u>	<u>40</u>	<u>1,000</u>
<u>Corridors above first floor</u>	<u>80</u>	<u>1,000</u>
<u>First-floor corridors</u>	<u>100</u>	<u>1,000</u>
<b>31. Scuttles, skylight ribs and accessible ceilings</b>	<u>=</u>	<u>200</u>
<b>32. Sidewalks, vehicular driveways and</b>	<u>600<sup>d</sup></u>	<u>~<sup>e</sup></u>

<u>OCCUPANCY OR USE</u>	<u>UNIFORM (psf)</u>	<u>CONCENTRATED (lbs.)</u>
<u>yards, subject to trucking</u>		
<u>Plaza areas (open) accessible to the public (including landscaped portions)</u>	<u>100</u>	
<b>33. Skating rinks</b>	<u>100</u>	<u>=</u>
<b>34. Stadiums and arenas</b>		
<u>Bleachers</u>	<u>100<sup>e</sup></u>	<u>=</u>
<u>Fixed seats (fastened to floor)</u>	<u>60<sup>c</sup></u>	
<b>35. Stairs and exits</b>	<u>100</u>	<u>Note f</u>
<u>One- and two-family dwellings</u>	<u>40</u>	
<u>All other</u>	<u>100</u>	
<b>36. Storage</b>		
<u>warehouses (shall be designed for heavier loads if required for anticipated storage)</u>		<u>=</u>
<u>Light</u>	<u>125</u>	
<u>Heavy</u>	<u>250</u>	
<b>37. Stores</b>		
<u>Retail</u>		
<u>Basement and First floor</u>	<u>100</u>	<u>1,000</u>
<u>Upper floors</u>	<u>75</u>	<u>1,000</u>
<u>Wholesale, all floors</u>	<u>100</u>	<u>1,000</u>
<b>38. Vehicle barriers</b>	<u>See Section 1607.7</u>	
<b>39. Walkways and elevated platforms (other than exitways)</b>	<u>60</u>	<u>=</u>
<b>40. Yards and terraces, pedestrians</b>	<u>100</u>	<u>=</u>

For SI: 1 inch = 25.4 mm, 1 square inch = 645.16 mm<sup>2</sup>, 1 pound per square foot = 0.0479 kN/m<sup>2</sup>, 1 pound = 0.004448 kN.

1 pound per cubic foot = 16 kg/m<sup>3</sup>

a. Floors in garages or portions of buildings used for the storage of motor vehicles shall be designed for the uniformly distributed live loads of Table 1607.1 or the following concentrated loads: (1) for garages restricted to vehicles accommodating not more than nine passengers, 3,000 pounds acting on an area of 4.5 inches by 4.5 inches; (2) for mechanical parking structures without slab or deck which are used for storing passenger vehicles only, 2,250 pounds per wheel.

b. The loading applies to stack room floors that support nonmobile, double-faced library bookstacks, subject to the following limitations:

1. The nominal bookstack unit height shall not exceed 90 inches;

2. The nominal shelf depth shall not exceed 12 inches for each face; and

3. Parallel rows of double-faced bookstacks shall be separated by aisles not less than 36 inches wide.

c. Design in accordance with the ICC *Standard on Bleachers, Folding and Telescopic Seating and Grandstands*.

d. Other uniform loads in accordance with a recognized method acceptable to the commissioner which contains

provisions for truck loadings shall also be considered where appropriate.

e. The concentrated wheel load shall be applied on an area of 20 square inches.

f. Minimum concentrated load on stair treads (on area of 4 square inches) is 300 pounds.

g. Where snow loads occur that are in excess of the design conditions, the structure shall be designed to support the loads due to the increased loads caused by drift buildup or a greater snow design determined by the commissioner (see Section 1608). For special-purpose roofs, see Section 1607.11.2.2.

h. See Section 1604.8.3 for decks attached to exterior walls.

i. Live loads for assembly spaces other than those described in this table shall be determined from the occupant load requirements as established by Section 1004 of this code using the formula 1000/(net floor area per occupant) but shall not be less than 50 psf nor more than 100 psf.

j. For establishing live loads for occupancies not specifically listed herein, refer to Reference Standard ASCE 7 for guidance.

**Table 1607.5**  
**EQUIVALENT UNIFORM PARTITION LOADS**

<b><u>Partition Weight (plf)</u></b>	<b><u>Equivalent Uniform Load (psf)</u></b> <b><u>(To be added to floor dead and live loads)</u></b>
50 or less	<u>0</u>
51 to 100	<u>6</u>
101 to 200	<u>12</u>
201 to 350	<u>20</u>
Greater than 350	<u>20 plus a concentrated live load of the weight in excess of 350 pfl.</u>

**TABLE 1607.6**  
**UNIFORM AND CONCENTRATED LOADS**

LOADING CLASS <sup>a</sup>	UNIFORM LOAD (pounds/linear foot of lane)	CONCENTRATED LOAD (pounds) <sup>b</sup>	
		For moment design	For shear design
H20-44 and HS20-44	640	18,000	26,000
H15-44 and HS15-44	480	13,500	19,500

For SI: 1 pound per linear foot = 0.01459 kN/m, 1 pound = 0.004448 kN, 1 ton = 8.90 kN.

- a. An H loading class designates a two-axle truck with a semitrailer. An HS loading class designates a tractor truck with a semitrailer. The numbers following the letter classification indicate the gross weight in tons of the standard truck and the year the loadings were instituted.
- b. See Section 1607.6.1 for the loading of multiple spans.

**TABLE 1607.9.1**  
**LIVE LOAD ELEMENT FACTOR,  $K_{LL}$**

ELEMENT	$K_{LL}$
Interior columns	4
Exterior columns without cantilever slabs	4
Edge columns with cantilever slabs	3
Corner columns with cantilever slabs	2
Edge beams without cantilever slabs	2
Interior beams	2
All other members not identified above including: Edge beams with cantilever slabs Cantilever beams Two-way slabs Members without provisions for continuous shear transfer normal to their span	1

**TABLE 1608.3.1**  
**SNOW EXPOSURE FACTOR  $C_e$**

<b><u>TERRAIN CATEGORY<sup>a</sup></u></b>	<b><u>EXPOSURE OF ROOF<sup>a,b</sup></u></b>		
	<b><u>Fully exposed<sup>c</sup></u></b>	<b><u>Partially exposed</u></b>	<b><u>Sheltered</u></b>
A (see Section 1609.4)	<u>N/A</u>	<u>1.1</u>	<u>1.3</u>
B (see Section 1609.4)	<u>0.9</u>	<u>1.0</u>	<u>1.2</u>
C (see Section 1609.4)	<u>0.9</u>	<u>1.0</u>	<u>1.1</u>

For SI: 1 mile=1609m.

- a. The terrain category and roof exposure condition chosen shall be representative of the anticipated conditions during the life of the structure. An exposure factor shall be determined for each roof of a structure.
- b. Definitions of roof exposure are as follows:
  1. Fully exposed shall mean roofs exposed on all sides with no shelter afforded by terrain, higher structures or trees. Roofs that contain several large pieces of mechanical equipment, parapets which extend above the height of the balanced snow load,  $h_b$ , or other obstructions are not in this category.
  2. Partially exposed shall include all roofs except those designated as “fully exposed” or “sheltered”
  3. Sheltered roofs shall mean those roofs located tight in among conifers that qualify as ‘obstructions’
- c. Obstructions within a distance of  $10 h_o$  provide “shelter”, where  $h_o$  is the height of the obstruction above the roof level. If the only obstructions are a few deciduous trees that are leafless in winter, the “fully exposed” category shall be used except for terrain category “A.” Note that these are heights above the roof. Heights used to establish the terrain category in Section 1609.4 are heights above the ground.

**TABLE 1609.1.4**  
**WIND-BORNE DEBRIS PROTECTION FASTENING**  
**SCHEDULE FOR WOOD STRUCTURAL PANELS<sup>a,b,c</sup>**

FASTENER TYPE	FASTENER SPACING (inches)			
	Panel span ≤ 2 feet	2 feet < Panel span ≤ 4 feet	4 feet < Panel span ≤ 6 feet	6 feet < Panel span ≤ 8 feet
2½ No. 6 Wood screws	16	16	12	9
2½ No. 8 Wood screws	16	16	16	12

For SI: 1 inch = 25.4 mm, 1 foot = 304.8 mm, 1 pound = 4.4 N,  
1 mile per hour = 0.44 m/s.

- a. This table is based on a maximum wind speed (3-second gust) of 130 mph and mean roof height of 33 feet or less.
- b. Fasteners shall be installed at opposing ends of the wood structural panel.
- c. Where screws are attached to masonry or masonry/stucco, they shall be attached utilizing vibration-resistant anchors having a minimum withdrawal capacity of 490 pounds.

**TABLE 1609.3.1**  
**EQUIVALENT BASIC WIND SPEEDS<sup>a,b,c</sup>**

$V_{3S}$	85	90	100	105	110	120	125	130	140	145	150	160	170
$V_{fm}$	70	75	80	85	90	100	105	110	120	125	130	140	150

For SI: 1 mile per hour = 0.44 m/s.

- a. Linear interpolation is permitted.
- b.  $V_{3S}$  is the 3-second gust wind speed (mph).
- c.  $V_{fm}$  is the fastest mile wind speed (mph).



**Table- 1609.6.4.1-a**  
**Terrain Exposure Constants**

Exposure	$\alpha$	$z_g$ (ft)	$\hat{a}$	$\hat{b}$	$\bar{\alpha}$	$\bar{b}$	c	$\ell$ (ft)	$\bar{\epsilon}$	$z_{min}$ (ft)*
A	5.0	1500	1/5	0.64	1/3.0	0.30	0.45	180	1/2.0	60

\* $z_{min}$  = minimum height used to ensure that the equivalent height  $\bar{z}$  is greater of  $0.6h$  or  $z_{min}$ .  
For buildings with  $h \leq z_{min}$ ,  $\bar{z}$  shall be taken as  $z_{min}$ .

**Table- 1609.6.4.1-b****Velocity Pressure Exposure Coefficients,  $K_h$  and  $K_z$** 

Height above ground level, $z$		Exposure	
		A	
ft	(m)	Case 1	Case 2
0-15	(0-4.6)	0.68	0.32
20	(6.1)	0.68	0.36
25	(7.6)	0.68	0.39
30	(9.1)	0.68	0.42
40	(12.2)	0.68	0.47
50	(15.2)	0.68	0.52
60	(18)	0.68	0.55
70	(21.3)	0.68	0.59
80	(24.4)	0.68	0.62
90	(27.4)	0.68	0.65
100	(30.5)	0.68	0.68
120	(36.6)	0.73	0.73
140	(42.7)	0.78	0.78
160	(48.8)	0.82	0.82
180	(54.9)	0.86	0.86
200	(61.0)	0.90	0.90
250	(76.2)	0.98	0.98
300	(91.4)	1.05	1.05
350	(106.7)	1.12	1.12
400	(121.9)	1.18	1.18
450	(137.2)	1.24	1.24
500	(152.4)	1.29	1.29

1. The velocity pressure exposure coefficient  $K_z$  may be determined from the following formula:

For  $15 \text{ ft.} \leq z \leq z_g$

$$K_z = 2.01 (z/z_g)^{2/\alpha}$$

For  $z < 15 \text{ ft.}$

$$K_z = 2.01 (15/z_g)^{2/\alpha}$$

2. Linear interpolation for intermediate values of height  $z$  is acceptable.

**TABLE 1609.6.2.1(1)**  
**SIMPLIFIED DESIGN WIND PRESURE (MAIN WINDFORCE-RESISTING SYSTEM),  $\rho_{s30}$  (Exposure B at h = 30 feet with  $I_w = 1.0$ ) (psf)**

ROOF ANGLE (degrees)	ROOF RISE IN 12"	LOAD CASE	ZONES									
			Horizontal Pressures				Vertical Pressures				Overhangs	
			A	B	C	D	E	F	G	H	$E_{OH}$	$G_{OH}$
0 to 5°	Flat	1	11.5	-5.9	7.6	-3.5	-13.8	-7.8	-9.6	-6.1	-19.3	-15.1
10°	2	1	21.6	-9.0	14.4	-5.2	-23.1	-14.1	-16.0	-10.8	-32.3	-25.3
15°	3	1	24.1	-8.0	16.0	-4.6	-23.1	-15.1	-16.0	-11.5	-32.3	-25.3
20°	4	1	26.6	-7.0	17.7	-3.9	-23.1	-16.0	-16.0	-12.2	-32.3	-25.3
25°	6	1	24.1	3.9	17.4	4.0	-10.7	-14.6	-7.7	-11.7	-19.9	-17.0
		2	—	—	—	—	-4.1	-7.9	-1.1	-5.1	—	—
30° to 45°	7 to 12	1	21.6	14.8	17.2	11.8	1.7	-13.1	0.6	-11.3	-7.6	-8.7
		2	21.6	14.8	17.2	11.8	8.3	-6.5	7.2	-4.6	-7.6	-8.7

For SI: 1 inch = 25.4 mm, 1 foot = 304.8 mm, 1 degree = 0.0174 rad, 1 mile per hour = 0.44 m/s, 1 pound per square foot = 47.9 N/m<sup>2</sup>.

**TABLE 1609.6.2.(2)**  
**NET DESIGN WIND PRESURE (COMPONENT AND CLADDING),  $p_{net30}$**   
**(Exposure B at h = 30 feet with  $I_w = 1.0$ ) (psf)**

	ZONE	EFFECTIVE WIND AREA	
Roof 0 to 7 degrees	1	10	-21.8
	1	20	-21.2
	1	50	-20.5
	1	100	-19.9
	2	10	-36.5
	2	20	-32.6
	2	50	-27.5
	2	100	-23.6
	3	10	-55.0
	3	20	-45.5
	3	50	-33.1
	3	100	-23.6
Roof > 7 to 27 degrees	1	10	-19.9
	1	20	-19.4
	1	50	-18.6
	1	100	-18.1
	2	10	-34.7
	2	20	-31.9
	2	50	-28.2
	2	100	-25.5
	3	10	-51.3
	3	20	-47.9
	3	50	-43.5
	3	100	-40.2
Roof > 27 to 45 degrees	1	10	19.9
	1	20	19.4
	1	50	18.6
	1	100	18.1
	2	10	19.9
	2	20	19.4
	2	50	18.6
	2	100	18.1
	3	10	19.9
	3	20	19.4
	3	50	18.6
	3	100	18.1
Wall	4	10	21.8
	4	20	20.8
	4	50	19.5
	4	100	18.5
	4	500	16.2
	5	10	21.8
	5	20	20.8
	5	50	19.5
	5	100	18.5
	5	500	16.2

For SI: 1 foot = 304.8 mm, 1 degree = 0.0174 rad, 1 mile per hour = 0.44 m/s, 1 pound per square foot = 47.9 N/m<sup>2</sup>.  
 Note: For effective areas between those given above, the load is permitted to be interpolated, otherwise use the load associated with the lower effective area.

**TABLE 1609.6.2.1(3)**  
**ROOF OVERHANG NET DESIGN WIND PRESSURE (COMPONENT AND CLADDING),  $p_{net30}$  (Exposure B at  $h=30$  feet with  $I_w = 1.0$ ) (psf)**

	ZONE	EFFECTIVE WIND AREA (sq. ft.)	
Roof 0 to 7 degrees	2	10	-31.4
	2	20	-30.8
	2	50	-30.1
	2	100	-29.5
	3	10	-51.6
	3	20	-40.5
	3	50	-25.9
	3	100	-14.8
Roof > 7 to 27 degrees	2	10	-40.6
	2	20	-40.6
	2	50	-40.6
	2	100	-40.6
	3	10	-68.3
	3	20	-61.6
	3	50	-52.8
	3	100	-46.1
Roof > 27 to 45 degrees	2	10	-36.9
	2	20	-35.8
	2	50	-34.3
	2	100	-33.2
	3	10	-36.9
	3	20	-35.8
	3	50	-34.3
	3	100	-33.2

For SI: 1 foot = 304.8 mm, 1 degree = 0.0174 rad, 1 mile per hour = 0.45 m/s, 1 pound per square foot = 47.9 N/m<sup>2</sup>.

Note: For effective areas between those given above, the load is permitted to be interpolated, otherwise use the load associated with the lower effective area.

**TABLE 1609.6.2.1(4)**  
**ADJUSTMENT FACTOR FOR BUILDING HEIGHT AND EXPOSURE, ( $\lambda$ )**

MEAN ROOF HEIGHT (feet)	EXPOSURE		A
	B	C	
15	1.00	1.21	.7
20	1.00	1.29	.7
25	1.00	1.35	.7
30	1.00	1.40	.7
35	1.05	1.45	.7
40	1.09	1.49	.8
45	1.12	1.53	.8
50	1.16	1.56	.8
55	1.19	1.59	.8
60	1.22	1.62	.8

For SI: 1 foot = 304.8 mm.

a. All table values shall be adjusted for other exposures and heights by multiplying by the above coefficients.

**TABLE 1609.6.3.5**  
**OTHER BUILDING ELEMENTS**

**Construction Shape Factor**

Signs (and their supports), or portions thereof, having 70 percent or more of solid surface	1.5
Signs (and their supports), or portions thereof, having less than 70 percent of solid surface	2.0
Tanks, cooling towers, and similar constructions	1.5
Square and rectangular chimneys	1.5

**TABLE 1609.8**  
**DESIGN STORM WIND (25 yr. Mean Recurrence) WIND PRESURE LOADING**  
**(psf) ON GROSS CROSS SECTIONAL AREA OF THE BACK**  
**STRUCTURE**

<u>Zone/Elevation</u>	<u>0-50feet</u>	<u>50-150feet</u>	<u>150-400feet</u>	<u>400-700feet</u>	<u>&gt;700 feet</u>
<u>Inland</u>	15	21	26	34	40
<u>Coastal</u>	15	26	43	66	70

**TABLE 1610.1  
SOIL LATERAL LOAD**

DESCRIPTION OF BACKFILL MATERIAL <sup>c</sup>	UNIFIED SOIL CLASSIFICATION	DESIGN LATERAL SOIL LOAD <sup>a</sup> (pound per square foot per foot of depth)	
		Active pressure	At-rest pressure
Well-graded, clean gravels; gravel-sand mixes	GW	30	60
Poorly graded clean gravels; gravel-sand mixes	GP	30	60
Silty gravels, poorly graded gravel-sand mixes	GM	40	60
Clayey gravels, poorly graded gravel-and-clay mixes	GC	45	60
Well-graded, clean sands; gravelly sand mixes	SW	30	60
Poorly graded clean sands; sand-gravel mixes	SP	30	60
Silty sands, poorly graded sand-silt mixes	SM	45	60
Sand-silt clay mix with plastic fines	SM-SC	45	100
Clayey sands, poorly graded sand-clay mixes	SC	60	100
Inorganic silts and clayey silts	ML	45	100
Mixture of inorganic silt and clay	ML-CL	60	100
Inorganic clays of low to medium plasticity	CL	60	100
Organic silts and silt clays, low plasticity	OL	Note b	Note b
Inorganic clayey silts, elastic silts	MH	Note b	Note b
Inorganic clays of high plasticity	CH	Note b	Note b
Organic clays and silty clays	OH	Note b	Note b

For SI: 1 pound per square foot per foot of depth = 0.157 kPa/m, 1 foot = 304.8 mm.

a. Design lateral soil loads are given for moist conditions for the specified soils at their optimum densities. Actual field conditions shall govern. Submerged or saturated soil pressures shall include the weight of the buoyant soil plus the hydrostatic loads.

b. Unsuited as backfill material.

c. The definition and classification of soil materials shall be in accordance with ASTM D 2487.



**TABLE 1615.1.1  
SITE CLASS DEFINITIONS**

SITE CLASS	SOIL PROFILE NAME	AVERAGE PROPERTIES IN TOP 100 feet, AS PER SECTION 1615.1.5		
		Soil shear wave velocity, $\bar{v}_s$ , (ft/s)	Standard penetration resistance, $\bar{N}$	Soil undrained shear strength, $\bar{s}_u$ , (psf)
A	Hard rock	$\bar{v}_s > 5,000$	N/A	N/A
B	Rock	$2,500 < \bar{v}_s \leq 5,000$	N/A	N/A
C	Very dense soil and soft rock	$1,200 < \bar{v}_s \leq 2,500$	$\bar{N} > 50$	$\bar{s}_u \geq 2,000$
D	Stiff soil profile	$600 \leq \bar{v}_s \leq 1,200$	$15 \leq \bar{N} \leq 50$	$1,000 \leq \bar{s}_u \leq 2,000$
E	Soft soil profile	$\bar{v}_s < 600$	$\bar{N} < 15$	$\bar{s}_u < 1,000$
E	—	Any profile with more than 10 feet of soil having the following characteristics: 1. Plasticity index $PI > 20$ , 2. Moisture content $w \geq 40\%$ , and 3. Undrained shear strength $\bar{s}_u < 500$ psf		
F	—	Any profile containing soils having one or more of the following characteristics: 1. Soils vulnerable to potential failure or collapse under seismic loading such as liquefiable soils, quick and highly sensitive clays, collapsible weakly cemented soils. 2. Peats and/or highly organic clays ( $H > 10$ feet of peat and/or highly organic clay where $H$ = thickness of soil) 3. Very high plasticity clays ( $H > 25$ feet with plasticity index $PI > 75$ ) 4. Very thick soft/medium stiff clays ( $H > 120$ feet)		

For SI: 1 foot = 304.8 mm, 1 square foot = 0.0929 m<sup>2</sup>, 1 pound per square foot = 0.0479 kPa. N/A = Not applicable

**TABLE 1615.1.2 (1)**  
**VALUES OF SITE COEFFICIENT  $F_a$  AS A FUNCTION OF SITE CLASS AND**  
**MAPPED SPECTRAL RESPONSE ACCELERATION AT SHORT PERIODS**  
 **$(S_s)^a$**

<b><u>SITE CLASS</u></b>	<b><u><math>F_a</math></u></b>
<b><u>A</u></b>	<b><u>0.80</u></b>
<b><u>B</u></b>	<b><u>1.00</u></b>
<b><u>C</u></b>	<b><u>1.20</u></b>
<b><u>D</u></b>	<b><u>1.51</u></b>
<b><u>E</u></b>	<b><u>2.13</u></b>
<b><u>F</u></b>	<b><u>Note a</u></b>

- a. Site-specific geotechnical investigation and dynamic site response analyses shall be performed to determine appropriate values, except that for structures with periods of vibration equal or less than 0.5 second, values of  $F_a$  for liquefiable soils are permitted to be taken equal to the values for the site class determined without regard to liquefaction in Section 1615.1.5.1.

**TABLE 1615.1.2 (2)**  
**VALUES OF SITE COEFFICIENT  $F_v$  AS A FUNCTION OF SITE CLASS AND**  
**MAPPED SPECTRAL RESPONSE ACCELERATION AT 1-SECOND PERIOD**  
 **$(S_1)^a$**

<b><u>SITE CLASS</u></b>	<b><u><math>F_v</math></u></b>
<b><u>A</u></b>	<b><u>0.80</u></b>
<b><u>B</u></b>	<b><u>1.00</u></b>
<b><u>C</u></b>	<b><u>1.70</u></b>
<b><u>D</u></b>	<b><u>2.4</u></b>
<b><u>E</u></b>	<b><u>3.5</u></b>
<b><u>F</u></b>	<b><u>Note a</u></b>

- a. Site-specific geotechnical investigation and dynamic site response analyses shall be performed to determine appropriate values, except that for structures with periods of vibration equal or less than 0.5 second, values of  $F_v$  for liquefiable soils are permitted to be taken equal to the values for the site class determined without regard to liquefaction in Section 1615.1.5.1.

**TABLE 1615.1.5  
SITE CLASSIFICATION<sup>a</sup>**

SITE CLASS	$\bar{v}_s$	$\bar{N}$ or $\bar{N}_{60}$	$\bar{s}_v$
E	< 600 ft/s	< 15	< 1,000 psf
D	600 to 1,200 ft/s	15 to 50	1,000 to 2,000 psf
C	1,200 to 2,500 ft/s	> 50	> 2,000

For SI: 1 foot per second = 304.8 mm per second, 1 pound per square foot = 0.0479 kN/m<sup>2</sup>.

a. If the  $\bar{s}_v$  method is used and the  $\bar{N}_{60}$  and  $\bar{v}_s$  criteria differ, select the category with the softer soils (for example, use Site Class E instead of D).

**TABLE 1616.3 (1)**  
**SEISMIC DESIGN CATEGORY BASED ON**  
**SHORT-PERIOD RESPONSE ACCELERATIONS**

<u>VALUE OF <math>S_{DS}</math></u>	<u>SEISMIC USE GROUP</u>		
	<u>I</u>	<u>II</u>	<u>III</u>
$S_{DS} < 0.167g$	<u>A</u>	<u>A</u>	<u>A</u>
$0.167g < S_{DS} < 0.33g$	<u>B</u>	<u>B</u>	<u>C</u>
$0.33g < S_{DS} < 0.50g$	<u>C</u>	<u>C</u>	<u>D</u>
$0.50g < S_{DS}$	<u>D<sup>a</sup></u>	<u>D<sup>a</sup></u>	<u>D</u>

- a. Building structures in Seismic Use Groups I or II and on Site Class E may be designed in Seismic Design Category C if their Fundamental Period of Vibration is not between 1 and 2 seconds or a dynamic structural analysis based on a site specific spectrum is performed.

**TABLE 1616.3 (2)**  
**SEISMIC DESIGN CATEGORY BASED ON**  
**1-SECOND PERIOD RESPONSE ACCELERATIONS**

<u>VALUE OF <math>S_{D1}</math></u>	<u>SEISMIC USE GROUP</u>		
	<u>I</u>	<u>II</u>	<u>III</u>
$S_{D1} < 0.067g$	<u>A</u>	<u>A</u>	<u>A</u>
$0.067g < S_{D1} < 0.133g$	<u>B</u>	<u>B</u>	<u>C</u>
$0.133g < S_{D1} < 0.20g$	<u>C</u>	<u>C</u>	<u>D</u>
$0.20g < S_{D1}$	<u>D</u>	<u>D</u>	<u>D</u>

**TABLE 1616.5.1.1**  
**PLAN STRUCTURAL IRREGULARITIES**

	<b><u>IRREGULARITY TYPE AND DESCRIPTION</u></b>	<b><u>REFERENCE SECTION</u></b>	<b><u>SEISMIC DESIGN CATEGORY<sup>a</sup> APPLICATION</u></b>
1a	<p><u>Torsional Irregularity - to be considered when diaphragms are not flexible as determined in Section 1602.1.1</u></p> <p><u>Torsional irregularity shall be considered to exist when the maximum story drift, computed including accidental torsion, at one end of the structure transverse to an axis is more than 1.2 times the average of the story drifts at the two ends of the structure.</u></p>	<p><u>9.5.5.5.2 of ASCE 7 1620.4.1</u></p> <p><u>9.5.2.1 of ASCE 7 9.5.5.7.1 of ASCE 7</u></p>	<p><u>C and D,</u></p> <p><u>D,</u></p> <p><u>D,</u></p> <p><u>C and D</u></p>
1b	<p><u>Extreme Torsional Irregularity - to be considered when diaphragms are not flexible as determined in Section 1602.1.</u></p> <p><u>Extreme Torsional irregularity shall be considered to exist when the maximum story drift</u></p>	<p><u>9.5.5.5.2 of ASCE 7 1620.4.1</u></p> <p><u>9.5.2.5.1 of ASCE 7 9.5.5.7.1 of ASCE 7</u></p>	<p><u>C and D,</u></p> <p><u>D</u></p> <p><u>D,</u></p> <p><u>C and D</u></p>
2	<p><u>Reentrant Corners</u></p> <p><u>Plan configurations of a structure and its lateral-force-resisting system contain reentrant corners where both projections of the structure beyond a reentrant corner are greater than 15 percent of the plan dimension of the structure in the given direction.</u></p>	<p><u>1620.4.1</u></p>	<p><u>D</u></p>
3	<p><u>Diaphragm Discontinuity</u></p> <p><u>Diaphragms with abrupt discontinuities or variations in stiffness, including those having cutout or open areas greater than 50 percent of the gross enclosed diaphragm area, or changes in effective diaphragm stiffness of more than 50 percent from one story to the next.</u></p>	<p><u>1620.4.1</u></p>	<p><u>D</u></p>
4	<p><u>Out-of Plane Offsets</u></p> <p><u>Discontinuities in a lateral-force-resistance path, such as out of plane offset of the vertical elements.</u></p>	<p><u>1620.4.1</u></p> <p><u>9.5.2.5.1 of ASCE 7 1620.2.9</u></p>	<p><u>D,</u></p> <p><u>D,</u></p> <p><u>B, C and D</u></p>
5	<p><u>Nonparallel Systems</u></p>	<p><u>1620.3.2</u></p>	<p><u>C and D</u></p>

	<u>The vertical lateral-force-resisting elements are not parallel to or symmetric about the major orthogonal axes of the lateral-force-resisting system.</u>		
--	--	--	--

- a. Seismic Design Category is determined in accordance with Section 1616.

**TABLE 1616.5.1.2**  
**VERTICAL STRUCTURAL IRREGULARITIES**

	<b><u>IRREGULARITY TYPE AND DESCRIPTION</u></b>	<b><u>REFERENCE SECTION</u></b>	<b><u>SEISMIC DESIGN CATEGORY<sup>a</sup> APPLICATION</u></b>
1a	<u>Stiffness Irregularity - Soft Story</u> <u>A soft story is one in which lateral stiffness is less than 70 percent of that in the story above or less than 80 percent for the average stiffness of the three stories above.</u>	<u>9.5.2.5.1 of ASCE 7</u>	<u>D</u>
1b	<u>Stiffness Irregularity - Extreme Soft Story</u> <u>An extreme soft story is one in which the lateral stiffness is less than 60 percent of that in the story above or less than 70 percent of the average stiffness of the three stories above.</u>	<u>9.5.2.5.1 of ASCE 7</u>	<u>D̄</u>
2	<u>Weight (Mass) Irregularity</u> <u>Mass irregularity shall be considered to exist where the effective mass of any story is more than 150 percent of the effective mass of an adjacent story. A roof that is lighter than the floor below need not be considered.</u>	<u>9.5.2.5.1 of ASCE 7</u>	<u>D</u>
3	<u>Vertical Geometric Irregularity</u> <u>Vertical geometric irregularity shall be considered to exist where the horizontal dimension of the lateral-force resisting system in any story is more than 130 percent of that in an adjacent story.</u>	<u>9.5.2.5.1 of ASCE 7</u>	<u>D</u>
4	<u>In-Plane Discontinuity in Vertical Lateral-Force-Resisting Elements</u> <u>An in-plane offset of the lateral-force-resisting elements greater than the length of those elements or a reduction in stiffness of the resisting element in the story below.</u>	<u>1620.4.1</u> <u>9.5.2.5.1 of ASCE 7</u> <u>1620.2.9</u>	<u>D,</u> <u>D,</u> <u>B, C and D</u>
5	<u>Discontinuity in Capacity - Weak Story</u> <u>A weak story is one in which the story lateral strength is less than 80 percent of that in the story above. The story strength is the total</u>	<u>1620.2.3</u> <u>9.5.2.5.1 of ASCE 7</u>	<u>B, C and D,</u> <u>D</u>

	<u>strength of seismic-resisting elements sharing the story shear for the direction under consideration.</u>		
--	--	--	--

- a. Seismic Design Category is determined in accordance with Section 1616.

**TABLE 1617.3.1  
ALLOWABLE STORY DRIFT,  $\Delta_x$  (Inches)<sup>a</sup>**

BUILDING	SEISMIC USE GROUP		
	I	II	III
Buildings, other than masonry shear wall or masonry wall frame buildings, four stories or less in height with interior walls, partitions, ceilings and exterior wall systems that have been designed to accommodate the story drifts	0.025 $h_{sx}$ <sup>b</sup>	0.020 $h_{sx}$	0.015 $h_{sx}$
Masonry cantilever shear wall buildings <sup>c</sup>	0.010 $h_{sx}$	0.010 $h_{sx}$	0.010 $h_{sx}$
Other masonry shear wall buildings	0.007 $h_{sx}$	0.007 $h_{sx}$	0.007 $h_{sx}$
Masonry wall frame buildings	0.013 $h_{sx}$	0.013 $h_{sx}$	0.010 $h_{sx}$
All other buildings	0.020 $h_{sx}$	0.015 $h_{sx}$	0.010 $h_{sx}$

For SI: 1 inch = 25.4 mm.

- a. There shall be no drift limit for single-story buildings with interior walls, partitions, ceilings and exterior wall systems that have been designed to accommodate the story drifts.
- b.  $h_{sx}$  is the story height below Level  $x$ .
- c. Buildings in which the basic structural system consists of masonry shear walls designed as vertical elements cantilevered from their base or foundation support which are so constructed that moment transfer between shear walls (coupling) is negligible.



TABLE 1617.6.2  
DESIGN COEFFICIENTS AND FACTORS FOR BASIC SEISMIC-FORCE-RESISTING SYSTEMS

BASIC SEISMIC-FORCE-RESISTING SYSTEM	DETAILING REFERENCE SECTION	RESPONSE MODIFICATION COEFFICIENT, $R$	SYSTEM OVERSTRENGTH FACTOR, $\Omega_s$	DEFLECTION AMPLIFICATION FACTOR, $C_d$	SYSTEM LIMITATIONS AND BUILDING HEIGHT LIMITATIONS (FEET) BY SEISMIC DESIGN CATEGORY AS DETERMINED IN SECTION 1616.3 <sup>a</sup>			
					A or B	C	D <sup>b</sup>	E <sup>c</sup>
<b>1. Bearing Wall Systems</b>								
A. Ordinary steel braced frames in light-frame construction	2211	4	2	3 1/2	NL	NL	65	65
B. Special reinforced concrete shear walls	1910.2.4	5 1/2	2 1/2	5	NL	NL	160 ML	160
C. Ordinary reinforced concrete shear walls	1910.2.3	4 1/2	2 1/2	4	NL	NL	NP	NP
D. Detailed plain concrete shear walls	1910.2.2	2 1/2	2 1/2	2	NL	NP	NP	NP
E. Ordinary plain concrete shear walls	1910.2.1	1 1/2	2 1/2	1 1/2	NL	NP	NP	NP
F. Special reinforced masonry shear walls	1.13.2.2.5 <sup>e</sup>	5	2 1/2	3 1/2	NL	NL	160 ML	160
G. Intermediate reinforced masonry shear walls	1.13.2.2.4 <sup>e</sup>	3 1/2	2 1/2	2 1/4	NL	NL	NP	NP
H. Ordinary reinforced masonry shear walls	1.13.2.2.3 <sup>e</sup>	2 1/2	2 1/2	1 3/4	NL	160 ML	NP	NP
I. Detailed plain masonry shear walls	1.13.2.2.2 <sup>e</sup>	2	2 1/2	1 3/4	NL	NP	NP	NP
J. Ordinary plain masonry shear walls	1.13.2.2.1 <sup>e</sup>	1 1/2	2 1/2	1 1/4	NL	NP	NP	NP
K. Light frame walls with shear panels—wood structural panels/sheet steel panels	2306.4.1/ 2211	6 1/2	3	4	NL	NL	65	65
L. Light framed walls with shear panels—all other materials	2306.4.5/ 2211	2	2 1/2	2	NL	NL	35	NP
M. Ordinary plain prestressed masonry shear walls	2106.1.1.1	1 1/2	2 1/2	1 1/4	NL	NP	NP	NP
N. Intermediate prestressed masonry shear walls	2106.1.1.2, 1.13.2.2.4 <sup>e</sup>	2 1/2	2 1/2	2 1/2	NL	35	NP	NP
O. Special prestressed masonry shear walls	2106.1.1.3, 1.13.2.2.5 <sup>e</sup>	4 1/2	2 1/2	3 1/2	NL	35	35	35
<b>2. Building Frame Systems</b>								
A. Steel eccentrically braced frames, moment-resisting, connections at columns away from links	(15) <sup>f</sup>	8	2	4	NL	NL	160 ML	160
B. Steel eccentrically braced frames, nonmoment-resisting, connections at columns away from links	(15) <sup>f</sup>	7	2	4	NL	NL	160 ML	160
C. Special steel concentrically braced frames	(13) <sup>f</sup>	6	2	5	NL	NL	160 ML	160
D. Ordinary steel concentrically braced frames	(14) <sup>f</sup>	5	2	4 1/2	NL	NL	35 <sup>g</sup>	35 <sup>g</sup>
E. Special reinforced concrete shear walls	1910.2.4	6	2 1/2	5	NL	NL	160 ML	160
F. Ordinary reinforced concrete shear walls	1910.2.3	5	2 1/2	4 1/2	NL	NL	NP	NP
G. Detailed plain concrete shear walls	1910.2.2	3	2 1/2	2 1/2	NL	NP	NP	NP

TABLE 1617.6.2—continued  
 DESIGN COEFFICIENTS AND FACTORS FOR BASIC SEISMIC-FORCE-RESISTING SYSTEMS

BASIC SEISMIC-FORCE-RESISTING SYSTEM	DETAILING REFERENCE SECTION	RESPONSE MODIFICATION COEFFICIENT, R <sup>a</sup>	SYSTEM OVERSTRENGTH FACTOR, Ω <sub>s</sub> <sup>b</sup>	DEFLECTION AMPLIFICATION FACTOR, C <sub>d</sub> <sup>c</sup>	SYSTEM LIMITATIONS AND BUILDING HEIGHT LIMITATIONS (FEET) BY SEISMIC DESIGN CATEGORY <sup>d</sup> AS DETERMINED IN SECTION 1616.3 <sup>e</sup>					
					A or B	C	D <sup>f</sup>	E <sup>g</sup>	F <sup>h</sup>	
H. Ordinary plain concrete shear walls	1910.2.1	2	2 1/2	2	NL	NP	NP	NP	NP	
I. Composite eccentrically braced frames	(14) <sup>k</sup>	8	2	4	NL	NL	160 NL	160	100	
J. Composite concentrically braced frames	(13) <sup>k</sup>	5	2	4 1/2	NL	NL	160 NL	160	100	
K. Ordinary composite braced frames	(12) <sup>k</sup>	3	2	3	NL	NL	NP	NP	NP	
L. Composite steel plate shear walls	(17) <sup>k</sup>	6 1/2	2 1/2	5 1/2	NL	NL	160 NL	160	100	
M. Special composite reinforced concrete shear walls with steel elements	(16) <sup>k</sup>	6	2 1/2	5	NL	NL	160	160	100	
N. Ordinary composite reinforced concrete shear walls with steel elements	(15) <sup>k</sup>	5	2 1/2	4 1/2	NL	NL	NP	NP	NP	
O. Special reinforced masonry shear walls	1.13.2.2.5 <sup>o</sup>	5 1/2	2 1/2	4	NL	NL	160 NL	160	100	
P. Intermediate reinforced masonry shear walls	1.13.2.2.4 <sup>o</sup>	4	2 1/2	2 1/2	NL	NL	NP	NP	NP	
Q. Ordinary reinforced masonry shear walls	1.13.2.2.3 <sup>o</sup>	3	2 1/2	2 1/4	NL	160 NL	NP	NP	NP	
R. Detailed plain masonry shear walls	1.13.2.2.2 <sup>o</sup>	2 1/2	2 1/2	2 1/4	NL	NP	NP	NP	NP	
S. Ordinary plain masonry shear walls	1.13.2.2.1 <sup>o</sup>	1 1/2	2 1/2	1 1/4	NL	NP	NP	NP	NP	
T. Light frame walls with shear panels—wood structural panels/sheet steel panels	2306.4.1/2211	7	2 1/2	4 1/2	NL	NL	65	65	65	
U. Light framed walls with shear panels—all other materials	2306.4.5/2211	2 1/2	2 1/2	2 1/2	NL	NL	35	NP	NP	
V. Ordinary plain prestressed masonry shear walls	2106.1.1.1	1 1/2	2 1/2	1 1/4	NL	NP	NP	NP	NP	
W. Intermediate prestressed masonry shear walls	2106.1.1.2, 1.13.2.2.4 <sup>o</sup>	3	2 1/2	2 1/2	NL	35	NP	NP	NP	
X. Special prestressed masonry shear walls	2106.1.1.3, 1.13.2.2.5 <sup>o</sup>	4 1/2	2 1/2	4	NL	35	35	35	35	
<b>3. Moment-resisting Frame Systems</b>										
A. Special steel moment frames	(9) <sup>j</sup>	8	3	5 1/2	NL	NL	NL	NL	NL	
B. Special steel truss moment frames	(12) <sup>j</sup>	7	3	5 1/2	NL	NL	160 NL	100	NP	
C. Intermediate steel moment frames	(10) <sup>j</sup>	4 1/2	3	4	NL	NL	35 <sup>h</sup>	NP <sup>hi</sup>	NP <sup>hi</sup>	
D. Ordinary steel moment frames	(11) <sup>j</sup>	3 1/2	3	3	NL	NL	NP <sup>hi</sup>	NP <sup>hi</sup>	NP <sup>hi</sup>	
E. Special reinforced concrete moment frames	(21.1) <sup>j</sup>	8	3	5 1/2	NL	NL	NL	NL	NL	

TABLE 1617.B.2—continued  
 DESIGN COEFFICIENTS AND FACTORS FOR BASIC SEISMIC-FORCE-RESISTING SYSTEMS

BASIC SEISMIC-FORCE-RESISTING SYSTEM	DETAILING REFERENCE SECTION	RESPONSE MODIFICATION COEFFICIENT, $R_f$	SYSTEM OVERSTRENGTH FACTOR, $\Omega_s$	DEFLECTION AMPLIFICATION FACTOR, $C_d$	SYSTEM LIMITATIONS AND BUILDING HEIGHT LIMITATIONS (FEET) BY SEISMIC DESIGN CATEGORY AS DETERMINED IN SECTION 1616.3 <sup>3</sup>				
					A or B	C	D <sup>4</sup>	E <sup>5</sup>	F <sup>6</sup>
F. Intermediate reinforced concrete moment frames	(21.1) <sup>1</sup>	5	3	4 1/2	NL	NL	NP	NP	NP
G. Ordinary reinforced concrete moment frames	(21.1) <sup>1</sup>	3	3	2 1/2	NL	NP	NP	NP	NP
H. Special composite moment frames	(9) <sup>2</sup>	8	3	5 1/2	NL	NL	NL	NL	NL
I. Intermediate composite moment frames	(10) <sup>2</sup>	5	3	4 1/2	NL	NL	NP	NP	NP
J. Composite partially restrained moment frames	(8) <sup>3</sup>	6	3	5 1/2	160 NL	100	NP	NP	NP
K. Ordinary composite moment frames	(11) <sup>4</sup>	3	3	2 1/2	NL	NP	NP	NP	NP
L. Masonry wall frames	2106	5 1/2	3	5	NL	160 NL	160 NL	160 NL	100
<b>4. Dual Systems with Special Moment Frames</b>									
A. Steel eccentrically braced frames, moment-resisting connections, at columns away from links	(15) <sup>1</sup>	8	2 1/2	4	NL	NL	NL	NL	NL
B. Steel eccentrically braced frames, nonmoment-resisting connections, at columns away from links	(15) <sup>1</sup>	7	2 1/2	4	NL	NL	NL	NL	NL
C. Special steel concentrically braced frames	(13) <sup>1</sup>	8	2 1/2	6 1/2	NL	NL	NL	NL	NL
D. Special reinforced concrete shear walls	1910.2.4	8	2 1/2	6 1/2	NL	NL	NL	NL	NL
E. Ordinary reinforced concrete shear walls	1910.2.3	7	2 1/2	6	NL	NL	NP	NP	NP
F. Composite eccentrically braced frames	(14) <sup>2</sup>	8	2 1/2	4	NL	NL	NL	NL	NL
G. Composite concentrically braced frames	(13) <sup>2</sup>	6	2 1/2	5	NL	NL	NL	NL	NL
H. Composite steel plate shear walls	(17) <sup>2</sup>	8	2 1/2	6 1/2	NL	NL	NL	NL	NL
I. Special composite reinforced concrete shear walls with steel elements	(16) <sup>2</sup>	8	2 1/2	6 1/2	NL	NL	NL	NL	NL
J. Ordinary composite reinforced concrete shear walls with steel elements	(15) <sup>2</sup>	7	2 1/2	6	NL	NL	NP	NP	NP
K. Special reinforced masonry shear walls	1.13.2.2.5 <sup>5</sup>	7	3	6 1/2	NL	NL	NL	NL	NL
L. Intermediate reinforced masonry shear walls	1.13.2.2.4 <sup>6</sup>	6 1/2	3	5 1/2	NL	NL	NP	NP	NP
<b>5. Dual Systems with Intermediate Moment Frames<sup>4a</sup></b>									
A. Special steel concentrically braced frames <sup>1</sup>	(13) <sup>1</sup>	4 1/2	2 1/2	4	NL	NL	35 <sup>h</sup>	NP <sup>h,i</sup>	NP
B. Special reinforced concrete shear walls	1910.2.4	6	2 1/2	5	NL	NL	160 NL	100	100
C. Ordinary reinforced concrete shear walls	1910.2.3	5 1/2	2 1/2	4 1/2	NL	NL	NP	NP	NP

TABLE 1617.6.2—continued  
DESIGN COEFFICIENTS AND FACTORS FOR BASIC SEISMIC-FORCE-RESISTING SYSTEMS

BASIC SEISMIC-FORCE-RESISTING SYSTEM	DETAILING REFERENCE SECTION	RESPONSE MODIFICATION COEFFICIENT, $R$ <sup>a</sup>	SYSTEM OVERSTRENGTH FACTOR, $\Omega_o$ <sup>b</sup>	DEFLECTION AMPLIFICATION FACTOR, $C_d$ <sup>c</sup>	SYSTEM LIMITATIONS AND BUILDING HEIGHT LIMITATIONS (FEET) BY SEISMIC DESIGN CATEGORY AS DETERMINED IN SECTION 1616.3 <sup>d</sup>				
					A or B	C	D <sup>e</sup>	E <sup>f</sup>	F <sup>g</sup>
D. Ordinary reinforced masonry shear walls	1.13.2.2.3 <sup>h</sup>	3	3	2 1/2	NL	160 NL	NP	NP	NP
E. Intermediate reinforced masonry shear walls	1.13.2.2.4 <sup>h</sup>	5	3	4 1/2	NL	NL	NP	NP	NP
F. Composite concentrically braced frames	(13) <sup>k</sup>	5	2 1/2	4 1/2	NL	NL	160 NL	100	NP
G. Ordinary composite braced frames	(12) <sup>k</sup>	4	2 1/2	3	NL	NL	NP	NP	NP
H. Ordinary composite reinforced concrete shear walls with steel elements	(15) <sup>k</sup>	5 1/2	2 1/2	4 1/2	NL	NL	NP	NP	NP
6. Shear Wall-frame Interactive System with Ordinary Reinforced Concrete Moment Frames and Ordinary Reinforced Concrete Shear Walls	21.1 <sup>l</sup> 1910.2.3	5 1/2	2 1/2	5	NL	NP	NP	NP	NP
7. Inverted Pendulum Systems									
A. Cantilevered column systems		2 1/2	2	2 1/2	NL	NL	35	35	35
B. Special steel moment frames	(9) <sup>j</sup>	2 1/2	2	2 1/2	NL	NL	NL	NL	NL
C. Ordinary steel moment frames	(11) <sup>j</sup>	1 1/4	2	2 1/2	NL	NL	NP	NP	NP
D. Special reinforced concrete moment frames	21.1 <sup>l</sup>	2 1/2	2	1 1/4	NL	NL	NL	NL	NL
8. Structural Steel Systems Not Specifically Detailed for Seismic Resistance	AISC—335 AISC—LRFD AISI AISC—HSS	3	3	3	NL	NL	NP	NP	NP

For SI: 1 foot = 304.8 mm, 1 pound per square foot = 0.0479 kN/m<sup>2</sup>.

- Response modification coefficient,  $R$ , for use throughout.
- Deflection amplification factor,  $C_d$ .
- NL = Not limited and NP = Not permitted.
- See Section 1617.6.2.4.1 for a description of building systems limited to buildings with a height of 240 feet or less.
- See Section 1617.6.2.4.1 for building systems limited to buildings with a height of 160 feet or less.
- Ordinary moment frame is permitted to be used in lieu of intermediate moment frame in Seismic Design Categories B and C.
- The tabulated value of the overstrength factor,  $\Omega_o$ , is permitted to be reduced by subtracting  $1/2$  for structures with flexible diaphragms but shall not be taken as less than 2.0 for any structure.
- Steel ordinary moment frames and intermediate moment frames are permitted in single-story buildings up to a height of 60 feet, when the moment joints of field connections are constructed of bolted end plates and the dead load of the roof does not exceed 15 pounds per square foot. The dead weight of the portion of walls more than 35 feet above the base shall not exceed 15 pounds per square foot.
- Steel ordinary moment frames are permitted in buildings up to a height of 35 feet, where the dead load of the walls, floors and roof does not exceed 15 pounds per square foot.
- AISC 341 Part I or Part III section number.
- ACI 318, Section number.
- AISC 341 Part II section number.
- Steel intermediate moment resisting frames as part of a dual system are not permitted in Seismic Design Categories D, E, and F.
- Steel ordinary concentrically braced frames are permitted in penthouse structures and in single-story buildings up to a height of 60 feet when the dead load of the roof does not exceed 15 pounds per square foot.
- ACI 530/ASCE 5/TMS 402 section number.

**TABLE 1626.9.3**  
**RESPONSE RATIO AND ROTATION LIMITS**

<b><u>ELEMENT</u></b>	<b><u>RESPONSE</u></b>	
	<b><u>RATIO</u></b>	<b><u>ROTATION</u></b>
<u>Concrete Slabs</u>	$\mu < 10$	$\theta < 4^\circ$
<u>Post-Tensioned Beams</u>	$\mu < 2$	$\theta < 1.5^\circ$
<u>Concrete Beams</u>	$\mu < 20$	$\theta < 6^\circ$
<u>Concrete Columns</u>	$\mu < 2$	$\theta < 6^\circ$
<u>Long Span Acoustical Deck</u>	$\mu < 2$	$\theta < 3^\circ$
<u>Open Web Steel Joists</u>	$\mu < 2$	$\theta < 6^\circ$
<u>Steel Beams</u>	$\mu < 20$	$\theta < 10^\circ$
<u>Steel Columns</u>	$\mu < 5$	$\theta < 6^\circ$

**CHAPTER 17**  
**STRUCTURAL TESTS AND SPECIAL INSPECTIONS**

**SECTION BC 1701**  
**GENERAL**

**1701.1 Scope.** The provisions of this chapter shall govern the inspection of quality, workmanship and requirements for construction. Materials, inspection and testing shall conform to the applicable standards listed in this code or in the rules of the department. See Chapter 1 of Title 28 of the *Administrative Code* for additional provisions relating to materials, testing and inspections.

**1701.2 New materials.** See Chapter 1 of Title 28 of the *Administrative Code* for additional provisions.

**1701.3 Used materials.** See Chapter 1 of Title 28 of the *Administrative Code*.

**SECTION BC 1702**  
**DEFINITIONS**

**1702.1 General.** The following words and terms shall, for the purposes of this chapter and as used elsewhere in this code, have the meanings shown herein.

**APPROVED AGENCY.** See Chapter 1 of Title 28 of the *Administrative Code*.

**APPROVED FABRICATOR.** An established and qualified person, firm or corporation approved by the commissioner.

**CERTIFICATE OF COMPLIANCE.** A certificate stating that materials meet specified standards or that work was done in compliance with approved construction documents and other applicable provisions of law and with respect to specified service equipment, a certificate issued by the department authorizing the operation of such equipment.

**FABRICATED ITEM.** Products and assemblies regulated by this code that are custom manufactured, or built prior to their incorporation into the work at the job site. Fabricated items shall not include listed, labeled or approved products or assemblies.

**INSPECTION CERTIFICATE.** An identification applied on a product by an approved agency containing the name of the manufacturer, the function and performance characteristics, and the name and identification of the approved agency that indicates that the product or material has been inspected and evaluated by such approved agency. An inspection certificate shall also mean a certificate issued by the department upon satisfactory completion of an inspection or test.

**LABEL.** An identification applied on a product by the manufacturer that contains the

name of the manufacturer, the function and performance characteristics of the product or material, and the name and identification of an approved agency and that indicates that a representative sample of the product or material has been tested and evaluated by an approved agency for compliance with nationally recognized standards or tests to determine suitable usage in a specified manner.

**MANUFACTURER'S DESIGNATION.** An identification applied on a product by the manufacturer indicating that a product or material complies with a specified standard or set of rules.

**MARK.** An identification applied on a product by the manufacturer indicating the name of the manufacturer and the function of a product or material.

**SPECIAL INSPECTION.** Inspection of selected materials, equipment, installation, fabrication, erection or placement of components and connections, to ensure compliance with approved construction documents and referenced standards as required by this chapter or elsewhere in this code or its referenced standards.

**SPECIAL INSPECTION, CONTINUOUS.** The full-time observation of work requiring special inspection by a special inspector who is continuously present in the area where the work is being performed.

**SPECIAL INSPECTION, PERIODIC.** The intermittent observation of work requiring special inspection by a special inspector who is present in the area where the work has been or is being performed and at the completion of the work. All work requiring special inspection shall remain accessible and exposed until approved by the special inspector.

**SPECIAL INSPECTOR.** See Chapter 1 of title 28 of the *Administrative Code*.

**SPRAYED FIRE-RESISTANT MATERIALS.** Cementitious or fibrous materials that are spray applied to provide fire-resistant protection of the substrates.

**SUPERINTENDENT OF CONSTRUCTION.** See Chapter 1 of Title 28 of the *Administrative Code*.

### **SECTION BC 1703**

#### **APPROVALS**

See Chapter 1 of Title 28 of the *Administrative Code*.

### **SECTION BC 1704**

#### **SPECIAL INSPECTIONS**

**1704.1 General.** Where application is made for construction as described in this section, one or more special inspectors shall be employed by the owner to provide inspections during construction on the types of work listed under Section 1704 and elsewhere in this

code. The special inspector shall be acceptable to the registered design professional of record.

**Exception:** Special inspections are not required for building components unless the design involves the practice of professional engineering or architecture as defined by the Education Law of the State of New York and applicable regulations governing the professional registration and certification of engineers or architects.

**1704.1.1 Building permit requirement.** The permit applicant shall submit a statement of special inspections as a condition for permit issuance on forms supplied by the department. This statement shall include a complete list of materials and work requiring special inspections by this section, the inspections to be performed and a list of the individuals or approved agencies to be retained for conducting the special inspections listed on the approved plans. Within each category of work, multiple special inspectors may be employed.

**1704.1.1.1 Identification of design professionals providing design documents for certain construction operations.** The registered design professionals responsible for the production of design, sequence of construction operations or shop drawings for projects that require design as defined in Chapter 33, shall file documentation of their intent to perform those duties on forms supplied by the department.

**1704.1.2 Report requirement.** Special inspectors shall keep records of inspections for the period of six years from the date of project sign-off. Such records shall be supplied to the commissioner upon request. The commissioner may require that special inspection reports be filed with the department and/or that such reports be otherwise made accessible for review. Reports shall indicate that work inspected was done in conformance with approved construction documents. Discrepancies shall be brought to the immediate attention of the contractor and, when applicable, to the superintendent of construction, for correction. If the discrepancies are not corrected, the discrepancies shall be brought to the attention of the owner, and the registered design professional of record prior to the completion of that phase of the work. Special inspection reports and records of special inspections shall be in the form and format supplied by the commissioner.

**1704.1.2.1 Hazardous conditions.** The special inspector shall report conditions noted as hazardous to life, safety or health, to the immediate attention of the commissioner.

**1704.1.2.2 Approval of partially completed work.** Reports of partially completed work shall be accepted when such reports indicate the code compliant status of completed work and the condition of the remaining work.

**1704.2 Inspection of fabricators.** Where fabrication of structural members, and other



regulated products is performed on the premises of a fabricator's shop, special inspection of the fabricated items shall be required as provided in Sections 1704.2.1 through 1704.2.2 and in Chapter 1 of Title 28 of the *Administrative Code*.

**1704.2.1 Fabrication and implementation procedures.** The special inspector shall verify that the fabricator maintains detailed fabrication and quality control procedures that provide a basis for inspection control of the workmanship and the fabricator's ability to conform to approved construction documents and referenced standards. The special inspector shall review the procedures for completeness and adequacy relative to the code requirements for the fabricator's scope of work.

**Exception:** Special inspections as required by Section 1704.2 shall not be required where the fabricator is approved in accordance with Section 1704.2.2 and with Chapter 1 of Title 28 of the *Administrative Code*.

**1704.2.2 Fabricator approval.** Special inspections required by this code are not required where the work is done on the premises of a fabricator registered and approved to perform such work without special inspection. Approval of fabricators shall be based upon review of the fabricator's written procedural and quality control manuals and periodic auditing of fabrication practices by an approved agency.

**1704.2.2.1 Fabricator's certificate of compliance.** For all fabricated items, the approved fabricator shall submit a certificate of compliance to the department stating that the work was performed in accordance with the approved construction documents, referenced standards and applicable provisions of law.

**1704.3 Steel construction.** The special inspections for steel elements of buildings and structures shall be as required by Section 1704.3 and Table 1704.3. Where required, special inspection of steel shall also comply with Section 1715.

**Exceptions:**

1. Special inspection of the steel fabrication process shall not be required where the fabricator does not perform any welding, thermal cutting or heating operation of any kind as part of the fabrication process. In such cases, the fabricator shall be required to submit a detailed procedure for material control that demonstrates the fabricator's ability to maintain suitable records and procedures such that, at any time during the fabrication process, the material specification, grade and mill test reports for the main stress-carrying elements are capable of being determined.
2. The special inspector need not be continuously present during welding of the following items, provided the materials, welding procedures and qualifications of welders are verified prior to the start of the work; periodic inspections are made of the work in progress and a visual inspection of all welds is made

prior to completion or prior to shipment of shop welding.

- 2.1. Single-pass fillet welds not exceeding  $\frac{5}{16}$  inch (7.9 mm) in size.
- 2.2. Floor and roof deck welding.
- 2.3. Welded studs when used for structural diaphragm.
- 2.4. Welded sheet steel for cold-formed steel framing members such as studs and joists.
- 2.5. Welding of stairs and railing systems.

### **TABLE 1704.3**

### **REQUIRED VERIFICATION AND INSPECTION OF STEEL CONSTRUCTION** **(Table 1704.3 attached to end of document)**

**1704.3.1 Welding.** Welding inspection shall be in compliance with AWS D1.1.

**1704.3.2 Details.** The special inspector shall perform an inspection of the steel frame to verify compliance with the details shown on the approved construction documents, such as bracing, stiffening, member locations and proper application of joint details at each connection, including connections designed for seismic effects.

**1704.3.3 High-strength bolts.** Installation of high-strength bolts shall be inspected in accordance with this section.

**1704.3.3.1 General.** While the work is in progress, the special inspector shall determine that the requirements for bolts, nuts, washers and paint; bolted parts and installation and tightening in such standards are met. For bolts requiring pretensioning, the special inspector shall observe the preinstallation testing and calibration procedures when such procedures are required by the installation method or by project plans or specifications; determine that all plies of connected materials have been drawn together and properly snugged and monitor the installation of bolts to verify that the selected procedure for installation is properly used to tighten bolts. For joints required to be tightened only to the snug-tight condition, the special inspector need only verify that the connected materials have been drawn together and properly snugged.

**1704.3.3.2 Periodic monitoring.** Monitoring of bolt installation for pretensioning is permitted to be performed on a periodic basis when using the turn-of-nut method with matchmarking techniques, the direct tension indicator method or the alternate design fastener (twist-off bolt) method. Joints designated as snug tight need be inspected only on a periodic basis.

**1704.3.3.3 Continuous monitoring.** Monitoring of bolt installation for pretensioning using the calibrated wrench method or the turn-of-nut method without matchmarking shall be performed on a continuous basis.

**1704.4 Concrete construction.** The special inspections and verifications for concrete construction shall be as required by this section and Table 1704.4.

**Exception:** Special inspections shall not be required for the following when specifically exempted on the approved construction documents:

1. Concrete placement of less than 50 cubic yards provided that the concrete is non-structural and is not subject to the durability requirements of Section 1904. In such case, testing may be waived by the registered design professional who prepared the structural construction documents.
2. Nonstructural concrete slabs supported directly on the ground, including prestressed slabs on grade, where the effective prestress in the concrete is less than 150 psi (1.03 Mpa).
3. Concrete foundation(s) for lightweight fences and recreational equipment.
4. Concrete patios, site furnishings, garden walls, driveways, sidewalks, and similar construction.

**TABLE 1704.4**  
**REQUIRED VERIFICATION AND INSPECTION OF CONCRETE**  
**CONSTRUCTION**

**(Table 1704.4 attached to end of document)**

**1704.4.1 Materials.** In the absence of sufficient data or documentation providing evidence of conformance to quality standards for materials in Chapter 3 of ACI 318, the commissioner shall require testing of materials in accordance with the appropriate standards and criteria for the material in Chapter 3 of ACI 318. Weldability of reinforcement, except that which conforms to ASTM A 706, shall be determined in accordance with the requirements of Section 1903.5.2.

**1704.4.2 Concrete construction.** When the specified compressive strength of concrete in a column is greater than 1.4 times that specified for a floor system, the special inspections for concrete construction shall also comply with the requirements of section 1908.2.1.

**1704.5 Masonry construction.** Masonry construction shall be inspected and evaluated in accordance with the requirements of this section, depending on the classification of the building or structure or nature of occupancy, as defined by this code (see Table 1604.5 and Section 1616.2).

**Exception:** Special inspections shall not be required for:

1. Empirically designed masonry, glass unit masonry or masonry veneer designed by Section 2109, 2110 or ACI 530/ASCE 5/TMS 402, Chapters 5, 6 or 7, when they are part of nonessential buildings (see Table 1604.5 and Section 1616.2).
2. Masonry foundation walls constructed in accordance with Table 1805.5(1), 1805.5(2), 1805.5(3) or 1805.5(4).

**1704.5.1 Empirically designed masonry, glass unit masonry and masonry veneer in essential facilities.** The minimum inspection program for masonry designed by Chapter 14, Section 2109 or 2110, or by Chapter 5, 6 or 7 of ACI 530/ASCE 5/TMS 402, in essential facilities listed in Table 1604.5 and Section 1616.2, shall comply with Table 1704.5.1.

**TABLE 1704.5.1**  
**LEVEL 1 SPECIAL INSPECTION**  
**(Table 1704.5.1 attached to end of document)**

**1704.5.2 Masonry facilities less than three stories in height and engineered masonry in nonessential facilities.** The minimum special inspection program for masonry designed by Section 2106, 2107 or 2108, or by chapters other than Chapters 5, 6 or 7 of ACI 530/ASCE 5/TMS 402, in nonessential facilities (see Table 1604.5 and Section 1616.2), shall comply with Table 1704.5.1.

**1704.5.3 Structural and veneer masonry in facilities three stories or more in height and) engineered masonry in essential facilities.** The minimum special inspection program for masonry designed by Section 2106, 2107 or 2108, or by chapters other than Chapters 5, 6 or 7 of ACI 530/ASCE 5/TMS 402, in essential facilities (see Table 1604.5 and Section 1616.2), shall comply with Table 1704.5.3.

**TABLE 1704.5.3**  
**LEVEL 2 SPECIAL INSPECTION**  
**(Table 1704.5.3 attached to end of document)**

**1704.6 Wood construction.** Special inspections of the fabrication process of prefabricated wood structural elements and assemblies shall be in accordance with Section 1704.2. Special inspections of site-built assemblies shall be in accordance with Section 1704.1.

**1704.6.1 Fabrication of high-load diaphragms.** High-load diaphragms using values from Table 2306.3.2 shall be installed with special inspections as indicated in Section 1704.1. The special inspector shall inspect the wood structural panel sheathing to

ascertain whether it is of the grade and thickness shown on the approved construction documents. Additionally, the special inspector must verify the nominal size of framing members at adjoining panel edges, the nail or staple diameter and length, the number of fastener lines and that spacing between fasteners in each line and at edge margins agrees with the approved construction documents.

**1704.6.2 Other structural wood construction.** Special inspection of structural wood construction shall be performed in accordance with Chapter 1.

**1704.7 Soils.** The special inspections for existing site soil conditions, fill placement and load-bearing requirements shall be performed in accordance with Sections 1704.7.1 through 1704.7.3. The approved soils report, required by Section 1802.2, shall be used to determine compliance.

**1704.7.1 Site preparation.** Immediately prior to placement of the footings, foundations, fill or other supporting materials the special inspector shall determine that the site has been prepared in accordance with the approved soils report.

**1704.7.2 During fill placement.** During placement and compaction of the fill material, the special inspector shall determine that the material being used and the maximum lift thickness comply with the approved report, as specified in Section 1803.5.

**1704.7.3 Evaluation of in-place density.** The special inspector shall determine, at the approved frequency, that the in-place dry density of the compacted fill complies with the approved report.

**1704.7.4 Special inspection of soils investigations, borings and test pits.** Boring operations shall be subject to continuous special inspection to verify compliance with Section 1802. Soil sample recovery operations for test pits shall be subject to continuous special inspection to verify compliance with Section 1802.

**Exception:** Existing boring, test pit and soil investigation records that have been deemed acceptable to the commissioner in accordance with Section 1802.4.2 are not subject to special inspection.

**1704.7.4.1 Boring and /or test pit report.** The special inspector's report shall include statements attesting to the following: that borings were performed in accordance with the procedures established in Section 1802.5, that 50 percent or more of the borings were witnessed directly by the registered design professional designated for this special inspection, the identification of those borings, the name and address of the individual(s) that witnessed any other borings, the borings and/or test pits so inspected were made and carried to the depths indicated; that to the best of the special inspector's knowledge and belief, the description and classification of the soils are a true description of the samples recovered from the

respective borings and/or test pits: that such samples were recovered at the levels indicated; and that the boring and/or test pit work progressed in such manner that the samples recovered are reasonably representative of the subsurface conditions.

**1704.8 Pile foundations.** A special inspector shall be present when pile foundations are being installed and during tests. The special inspector shall make and submit to the commissioner records of the installation of each pile and results of load tests. Records shall include the cutoff and tip elevation of each pile relative to a permanent reference. A special inspector shall verify that pile installation procedures are in accordance with Section 1808.

**1704.9 Pier foundations.** Special inspection is required for all pier foundations designed in accordance with Section 1802.2.4.

**Exception:** Piers for support of lightweight fences, recreational equipment, site furnishings and similar construction, unless special inspection is specifically noted as required on the approved construction documents.

**1704.9.1 Underpinning operations.** Special inspection is required for underpinning operations in accordance with Section 3301.3. See Section 1704.21.

**1704.10 Wall panels, curtain walls and veneers.** Special inspection is required for exterior architectural wall panels and the anchoring of veneers designed for installation on buildings above a height of 40 feet (12 192 mm). Special inspection of masonry veneer on such structures shall be in accordance with Section 1704.5.

**1704.10.1 Special Inspection for wall panels, curtain walls and veneers.** The special inspector shall become familiar with and retain a copy of the construction documents, shop drawings, instructions for the sequence of component installation, samples and/or mock-ups, if supplied. The special inspector shall field check the site conditions at the time the structure is prepared for component installation to verify: that the supporting structure is properly aligned and within design tolerances, that required inserts are properly installed, that framing components are properly sized, aligned, and without structural defects or weakness, that anchors are properly placed, welded, bolted and finished as applicable, that weeps, flashings and tubes are in place and properly drained, that joinery and end dams are properly sealed per plans, that sealing materials with sufficient elongation capability are provided, that gaskets meet specifications, that materials are installed to compensate for horizontal and vertical movement in accordance with the design and the manufacturers guidelines and that any other observations pertinent to safety of performance of the wall system have been performed.

**1704.10.2 Unsafe wall conditions.** The special inspector shall report any immediate hazards to the department.

**1704.11 Sprayed fire-resistant materials.** Special inspections for sprayed fire-resistant materials applied to structural elements and decks shall be in accordance with Sections 1704.11.1 through 1704.11.5. Special inspections shall be based on the fire-resistance design as designated in the approved construction documents.

**1704.11.1 Structural member surface conditions.** The surfaces shall be prepared in accordance with the approved fire-resistance design and the approved manufacturer's written instructions. The prepared surface of structural members to be sprayed shall be inspected before the application of the sprayed fire-resistant material.

**1704.11.2 Application.** The substrate shall have a minimum ambient temperature before and after application as specified in the approved manufacturer's written instructions. The area for application shall be ventilated during and after application as required by the manufacturer's written instructions.

**1704.11.3 Thickness.** The average thickness of the sprayed fire-resistant materials applied to structural elements shall not be less than the thickness required by the approved fire-resistant design. Individual measured thickness, which exceeds the thickness specified in a design by ¼ inch (6.4mm) or more, shall be recorded as the thickness specified in the design plus ¼ inch (6.4 mm). For design thicknesses 1 inch (25 mm) or greater, the minimum allowable individual thickness shall be the design thickness minus ¼ inch (6.4 mm). For design thicknesses less than 1 inch (25 mm), the minimum allowable individual thickness shall be the design thickness minus 25 percent. Thickness shall be determined in accordance with ASTM E 605. Samples of the sprayed fire-resistant materials shall be selected in accordance with Sections 1704.11.3.1 and 1704.11.3.2.

**1704.11.3.1 Floor, roof and wall assemblies.** The thickness of the sprayed fire-resistant material applied to floor, roof and wall assemblies shall be determined in accordance with ASTM E 605, taking the average of not less than four measurements for each 1,000 square feet (93 m<sup>2</sup>) of the sprayed area on each floor or part thereof.

**1704.11.3.2 Structural framing members.** The thickness of the sprayed fire-resistant material applied to structural members shall be determined in accordance with ASTM E 605. Thickness testing shall be performed on not less than 25 percent of the structural members on each floor.

**1704.11.4 Density.** The density of the sprayed fire-resistant material shall not be less than the density specified in the approved fire-resistant design. Density of the sprayed fire-resistant material shall be determined in accordance with ASTM E 605.

**1704.11.5 Bond strength.** The cohesive/adhesive bond strength of the cured sprayed fire-resistant material applied to structural elements shall not be less than 150 pounds per square foot (psf) (7.18 kN/m<sup>2</sup>). The cohesive/adhesive bond strength shall be

determined in accordance with the field test specified in ASTM E 736 by testing in-place samples of the sprayed fire-resistant material selected in accordance with Sections 1704.11.5.1 and 1704.11.5.2.

**1704.11.5.1 Floor, roof and wall assemblies.** The test samples for determining the cohesive/adhesive bond strength of the sprayed fire-resistant materials shall be selected from each floor, roof and wall assembly at the rate of not less than one sample for every 10,000 square feet (929 m<sup>2</sup>) or part thereof of the sprayed area in each story.

**1704.11.5.2 Structural framing members.** The test samples for determining the cohesive/adhesive bond strength of the sprayed fire-resistant materials shall be selected from beams, girders, joists, trusses and columns at the rate of not less than one sample for each type of structural framing member for each 10,000 square feet (929 m<sup>2</sup>) of floor area or part thereof in each story.

**1704.12 Exterior insulation and finish systems (EIFS).** Special inspections shall be required for all EIFS applications installed more than fifteen feet above adjacent finished grades.

**1704.12.1** The special inspection shall include verification of: compliance with approved construction documents for attachment to structure, installation of waterproofing membranes, weeps, drains, mold prevention features and conformance with the manufacturers installation guidelines.

**1704.13 Special cases.** Special inspections shall be required for proposed work that is, in the opinion of the commissioner, unusual in its nature, such as, but not limited to, the following examples:

1. Construction materials and systems that are alternatives to materials and systems prescribed by this code.
2. Unusual design applications of materials described in this code.
3. Materials and systems required to be installed in accordance with additional manufacturer's instructions that prescribe requirements not contained in this code or in standards referenced by this code.

**1704.14 Special inspection for smoke control.** Smoke control systems shall be tested by a special inspector in accordance with Section 1704.14.1 and 909.

**1704.14.1 Testing scope.** The test scope shall be as follows:

1. During erection of ductwork and prior to concealment for the purposes of leakage testing and recording of device location.



2. Prior to occupancy and after sufficient completion for the purposes of pressure difference testing, flow measurements and detection and control verification.

**1704.15 Special inspection for mechanical systems.** Mechanical systems regulated by the *New York City Mechanical Code* Sections 107 and 507 and Chapters 10, 11, and 12 shall be inspected for conformance with the approved construction documents.

**1704.15.1 Tests for mechanical systems.** Tests of mechanical systems shall be performed in accordance with *New York City Mechanical Code* Sections 507.16, 1011, 1108 and 1208.

**Exception:** Listed and labeled self contained factory built equipment and appliances deemed to meet the design, manufacture and factory test requirements of this code shall be field tested in accordance with their manufacturers installation and operational test standards.

**1704.15.2 Special Inspection of Mechanical Systems.** Inspections of mechanical systems shall include the following as applicable to the system:

1. Visual certification that required components of such systems are complete in accordance with the manufacturers installation guidelines and the approved construction documents,
2. Supports, hangers, seismic bracing, and vibration isolation equipment are properly spaced and anchored to supporting structure,
3. Installation of required signage and safety instructions,
4. Electrical components are installed and electrical sign-off issued,
5. Ventilation balancing report is complete and in accordance with design documents,
6. Required labeling, operational instructions and safety signage properly posted,
7. All related special inspections for such systems are complete,
8. Noise producing mechanical equipment located within 100 feet (30 480 mm) of habitable room windows shall be tested at the equipment for compliance with the design STC rating of the equipment.

**Exception:** Systems and equipment exempt from service equipment certificate of compliance in accordance with Section 109.3.8.2.1.

**1704.16 Special inspection for fuel storage and fuel piping systems.** Fuel oil storage equipment including tanks, pumps, valves, including transfer, return, fill and vent piping, hangers and bracing, fill and vent terminals, and related systems regulated by the *New York City Mechanical Code* Sections 1308, shall be inspected for conformance with the approved construction documents and the manufacturer's installation standards. Testing of fuel storage tanks and piping shall be performed in accordance with *New York City Mechanical Code* Section 1308.1.

**Exceptions:**

1. Testing for listed fuel oil storage tanks 660 gallons (2498 L) or less in capacity, supplied with a label or manufacturer's certification attesting that the tank was factory tested to a testing standard indicated in *New York City Mechanical Code* Section 1308.1.
2. Systems and equipment exempt from service equipment certificate of compliance in accordance with Section 109.3.8.2.3.

**1704.17 High pressure steam piping.** High pressure steam piping regulated by *New York City Mechanical Code* Section 1210, shall be subject to special inspection in accordance with this section.

**1704.17.1 Welding.** The special inspector shall verify the qualifications of the welder and the quality of the welding materials and equipment prior to welding operations. The special inspector shall review the proposed welding procedures for compliance with applicable standards listed in the *New York City Mechanical Code* Section 1210.4.

**1704.17.2 Welding operations.** The special inspector shall perform periodic inspection of the pipe joining and welding operations in accordance with the above. Radiographic testing shall be applied to connections as indicated in *New York City Mechanical Code* Section 1210.4.9. Unacceptable connections and installations shall be rejected.

**1704.17.3 Testing of high pressure steam piping.** Hydrostatic testing shall be performed on the completed installation of new and altered systems in accordance with *New York City Mechanical Code* Section 1210.4.10.

**Exception:** Testing requirements shall not apply to alteration or repairs to existing high pressure steam piping systems in which the integrity of the piping is not affected. Such alterations shall be visually inspected for compliance with the approved construction documents.

**1704.18 High pressure gas piping.** High pressure gas piping regulated in *New York City*

Fuel Gas Code Section 406 shall be subject to periodic special inspection in accordance with this section.

**1704.18.1 Welding.** The special inspector shall verify the qualifications of the welder, the quality of the welding materials and equipment prior to welding operations. The special inspector shall review the proposed welding procedures for compliance with applicable standards listed in New York City Fuel Gas Code Section 406.

**1704.18.2 Welding operations.** The special inspector shall perform periodic special inspection for the pipe joining and welding operations in accordance with the above. Radiographic testing shall be performed to the connections as indicated in *New York City Fuel Gas Code* Section 406.4.

**1704.18.3 Testing of high pressure gas piping.** Pressure testing shall be performed on the completed installation of new and altered systems in accordance with *New York City Fuel Gas Code* Section 406.4.

**1704.19 Structural safety during construction operations.** Construction work consisting of structural alterations, excavation, underpinning, and demolition work that requires “design” as defined in Chapter 33, including: earth shoring, underpinning, protection of adjacent structures and buildings, shall be subject to special inspection in accordance with this section. All alterations to existing structures in which loads are transferred from one structural system of structural elements to another, such as installation of columns or girders, replacement of existing bearing walls, the creation of openings or slots in existing walls, girders or floors, alteration of arches, rigid frames, trusses in frame buildings, or where the stability or integrity of a structural system is to be temporarily diminished shall be subject to special inspections in accordance with this section.

**Exception:** Construction operations not requiring “design” as defined in Chapter 33.

**1704.19.1 General.** Prior to commencement of work, the special inspector shall review the contractor’s proposed sequence of operations and determine the areas of work that require design. A written statement shall be prepared, mutually acceptable to the contractor and the special inspector, indicating:

1. The portions of work requiring design as defined in Chapter 33.
2. The names and addresses of the licensed professionals that have been engaged to supply design documents for applicable work.
3. The approximate dates for delivery of design documents.
4. A schedule of periodic special inspections, at agreed intervals, including

adequate frequency to assure the contractor's continued compliance with the proposed designs and sequence of construction operations.

**1704.19.2 Site structural safety design documents.** Design documents including: shop drawings, sketches and written descriptions of proposed work regarding site structural safety in construction operations shall be prepared by a registered design professional in the employ of the owner or the contractor. Such designs may be revised at any time by the registered design professional. Copies of the special inspection log book, the design documents and revisions thereof, shall be maintained at the jobsite, and at the office of the special inspector, available for use and review at all reasonable times, until the structural work is complete. In the case of alteration to existing structures, the design documents shall be reviewed by the registered design professional of record.

**1704.19.3 Inspection for structural safety in construction operations.** The special inspector shall visit the jobsite at agreed intervals, assess the ongoing work and verify that operations conform with the design documents. Deficiencies shall be reported as required by Section 1704.2. In the event unsafe conditions are discovered, the commissioner and the registered design professional employed by the contractor shall be immediately notified.

**1704.19.4 Records of structural safety inspections in construction operations.** The special inspection logbook shall be maintained at the special inspector's office and shall contain the following information:

1. Project identification, application number and address.
2. Date and time of each inspection.
3. Names of personnel who performed each inspection.
4. Dates of off-site meetings, names of the participants and a summary of the conversations.
5. Any significant observations or instructions given related to any of the following:
  - 5.1. Deviations from the design documents.
  - 5.2. Anticipated field conditions.
  - 5.3. Proper execution of the work.
  - 5.4. Safe jobsite conditions.

5.5. Precautions taken to maintain safe conditions, if work is stopped for any reason.

**1704.19.5 Special requirements for work in occupied multiple dwellings.** When alteration or construction operations are performed at occupied multiple dwellings, the special inspector shall periodically verify compliance with a Tenant Protection Plan as provided for in Chapter 1 of Title 28 of the *Administrative Code*.

**1704.20 Site storm drainage disposal and detention facilities.** Storm water detention facilities, roof retention facilities and dry-well systems shall be inspected for conformance with the approved construction documents. Minor variations, based on actual site conditions shall be acceptable at the discretion of the registered design professional of record. Verification shall include:

1. Materials of construction.
2. Bedding of pipe and facilities.
3. Placement and installation of fill materials.
4. Volume of drywell and detention facilities.
5. Installation of volume flow control devices.
6. Workmanship and quality of installation.
7. Overall conformance with the approved construction documents. Hydrostatic testing of the detention system shall be required when the system is designed as watertight.

**1704.20.1 Soil percolation tests.** Soil percolation tests shall be performed at the site of a proposed individual on-site private sewage disposal system installation to determine the suitability of the soil and site. Such test shall be performed under the supervision of a special inspector. The results of the percolation tests shall be filed on forms provided by the department, stating the suitability of the site and the capacity of the subsoil for the proposed use. The registered design professional of record for the dry-well system shall be notified immediately if the results of the percolation test demonstrate that the approved system may not function as designed.

**1704.21 Sprinkler system special inspection.** New and altered sprinkler system shall be inspected in accordance with Section 903. The permit holder responsible for the sprinkler work shall perform all required acceptance tests, complete and sign the appropriate contractor's material and test certifications. The special inspector shall witness all required tests, and shall verify that all installations of all materials, fittings, hangers, assemblies and signage are in accordance with the approved construction documents and

that the contractor has transmitted required maintenance literature and instruction to the owner. The special inspector shall verify that the material and test certification forms have been transmitted to the Fire Department and the department.

**Exception:** Special inspection of the hydrostatic test shall not be required when such test is witnessed by the department.

**1704.22 Standpipe system special inspection.** New and altered standpipe systems shall be inspected in accordance with Section 905 The permit holder responsible for the standpipe work shall perform all required acceptance tests, complete and sign the appropriate contractor's material and test certifications. The special inspector shall witness all required tests, verify that installation of all materials, fittings, hangers, assemblies and signage are in accordance with the approved construction documents and that the contractor has transmitted required maintenance literature and instruction to the owner. The special inspector shall verify that the material and test certification forms have been transmitted to the Fire Department and the department.

**Exception:** Special inspection of the hydrostatic test shall not be required when such test is witnessed by the department.

**1704.23 Heating systems.** Special Inspection shall be required for new and altered boilers and heating systems. All boilers and heating systems, including chimney connectors, shall be inspected for compliance with the approved construction documents. New heating systems shall be tested in accordance with *New York City Mechanical Code* Section 1011. Alterations to heating systems shall be subjected to applicable tests for the altered portions of the system and to verification of its satisfactory operation within the existing system.

**Exception:** Tests and inspections need not duplicate any tests or inspections previously certified by the commissioner or a duly authorized insurance company.

**1704.24 Chimneys.** New and altered chimneys shall be subject to special inspection. The chimney shall be inspected to verify compliance with the approved construction documents, and proper clearance or isolation from adjacent combustible construction. Testing of the chimney shall be performed in accordance with Section 810 of the *New York City Mechanical Code*.

**Exception:** A pressurized smoke test need not be performed on an existing negative pressure chimney if the lining of such chimney is not affected by alterations and the registered design professional specifies on the approved construction documents that such test need not be performed on such chimney.

**1704.25 Through-penetration firestop systems, concealed draftstop and fireblock systems.** All through-penetration firestopping, draftstopping and fireblocking shall be subject to periodic special inspection prior to concealment to determine compliance with

the approved construction documents. Listed systems shall be inspected for compliance with their listing.

**Exception:** Through-penetration firestop systems may be inspected in accordance with ASTM E2174-04 when authorized by the registered design professional of record and when the contractor applies the procedures established in that standard.

**1704.26 Aluminum Construction.** The special inspections for structural aluminum elements of buildings and structures shall be as required by section 1704.28.1.

**1704.26.1 Welding Operations.** All welding operations of aluminum elements shall be subject to special inspection for compliance with this code, AA ASM-35, Parts 1A and 1B of the Aluminum Design Manual, and AWS D1.2.

**Exception:** Welding operations in connections where the calculated stresses in the welds are less than fifty percent of the basic allowable values.

**SECTION BC 1705**  
**RESERVED**

**SECTION BC 1706**  
**RESERVED**

**SECTION BC 1707**  
**SPECIAL INSPECTIONS FOR SEISMIC RESISTANCE**

1707.1 Reserved.

1707.2 Reserved.

1707.3 Reserved.

1707.4 Reserved.

1707.5 Reserved.

1707.6 Reserved.

**1707.7 Mechanical and electrical components.** Periodic special inspection is required during the anchorage of electrical equipment for emergency power systems in structures assigned to Seismic Design Category C, or D. Periodic special inspection is required during the installation of piping systems intended to carry flammable, combustible or highly toxic contents and their associated mechanical units in structures assigned to Seismic Design Category C, or D. Periodic special inspection is required during the installation of HVAC ductwork that will contain hazardous materials in structures

assigned to Seismic Design Category C, or D.

**1707.8 Seismic isolation system.** There shall be periodic special inspection during the fabrication and installation of isolator units and energy dissipation devices if used as part of the seismic isolation system.

**SECTION BC 1708**  
**RESERVED**

**SECTION BC 1709**  
**RESERVED**

**SECTION BC 1710**  
**DESIGN STRENGTHS OF MATERIALS**

**1710.1 Conformance to standards.** The design strengths and permissible stresses of any structural material that are identified by a manufacturer's designation as to manufacture and grade by mill tests, or the strength and stress grade is otherwise confirmed to the satisfaction of the commissioner shall conform to the specifications and methods of design of accepted engineering practice or the rules of the department in the absence of applicable standards.

**1710.2 New materials.** For materials that are not specifically provided for in this code, the design strengths and permissible stresses shall be established by tests as provided for in Section 1711.

**SECTION BC 1711**  
**ALTERNATIVE TEST PROCEDURE**

**1711.1 General.** In the absence of rules or other approved standards, and upon special application by a registered design professional the commissioner shall make, or cause to be made, the necessary tests and investigations; or the commissioner shall accept duly authenticated reports from approved agencies in respect to the quality and manner of use of new materials or assemblies as provided for in Section 113. The cost of all tests and other investigations required under the provisions of this code shall be borne by the permit applicant.

**SECTION BC 1712**  
**TEST SAFE LOAD**

**1712.1 Where required.** Where proposed construction is not capable of being designed by approved engineering analysis, or where proposed construction design method does not comply with the applicable material design standard, the system of construction or the structural unit and the connections shall be subjected to the tests prescribed in Section 1714. The commissioner shall accept certified reports of such tests conducted by an



approved testing agency, provided that such tests meet the requirements of this code and approved procedures.

## **SECTION BC 1713** **IN-SITU LOAD TESTS**

**1713.1 General.** Whenever there is a reasonable doubt as to the stability or load-bearing capacity of a completed building, structure or portion thereof for the expected loads, an engineering assessment shall be required. The engineering assessment shall involve either a structural analysis or an in-situ load test, or both. The structural analysis shall be based on actual material properties and other as-built conditions that affect stability or load-bearing capacity, and shall be conducted in accordance with the applicable design standard. If the structural assessment determines that the load-bearing capacity is less than that required by the code, load tests shall be conducted in accordance with Section 1713.2. If the building, structure or portion thereof is found to have inadequate stability or load-bearing capacity for the expected loads, modifications to ensure structural adequacy or the removal of the inadequate construction shall be required.

**1713.2 Test standards.** Structural components and assemblies shall be tested in accordance with the appropriate material standards listed in Chapter 35. In the absence of a standard that contains an applicable load test procedure, the test procedure shall be developed by a registered design professional and approved. The test procedure shall simulate loads and conditions of application that the completed structure or portion thereof will be subjected to in normal use.

**1713.3 In-situ load tests.** In-situ load tests shall be conducted in accordance with Section 1713.3.1 or 1713.3.2 and shall be supervised by a registered design professional. The test shall simulate the applicable loading conditions specified in Chapter 16 as necessary to address the concerns regarding structural stability of the building, structure or portion thereof.

**1713.3.1 Load test procedure specified.** Where a standard listed in Chapter 35 contains an applicable load test procedure and acceptance criteria, the test procedure and acceptance criteria in the standard shall apply. In the absence of specific load factors or acceptance criteria, the load factors and acceptance criteria in Section 1713.3.2 shall apply.

**1713.3.2 Load test procedure not specified.** In the absence of applicable load test procedures contained within a standard referenced by this code or acceptance criteria for a specific material or method of construction, such existing structure shall be subjected to a test procedure developed by a registered design professional that simulates applicable loading and deformation conditions. For components that are not a part of the seismic-load-resisting system, the test load shall be equal to two times the unfactored design loads. The test load shall be left in place for a period of 24 hours. The structure shall be considered to have successfully met the test

requirements where the following criteria are satisfied:

1. Under the design load, the deflection shall not exceed the limitations specified in Section 1604.3.
2. Within 24 hours after removal of the test load, the structure shall have recovered not less than 75 percent of the maximum deflection.
3. During and immediately after the test, the structure shall not show evidence of failure.

### **SECTION BC 1714** **PRECONSTRUCTION LOAD TESTS**

**1714.1 General.** In evaluating the physical properties of materials and methods of construction that are not capable of being designed by approved engineering analysis or do not comply with applicable material design standards listed in Chapter 35, the structural adequacy shall be predetermined based on the load test criteria established in this section.

**1714.2 Load test procedures specified.** Where specific load test procedures, load factors and acceptance criteria are included in the applicable design standards listed in Chapter 35, such test procedures, load factors and acceptance criteria shall apply. In the absence of specific test procedures, load factors or acceptance criteria, the corresponding provisions in Section 1714.3 shall apply.

**1714.3 Load test procedures not specified.** Where load test procedures are not specified in the applicable design standards listed in Chapter 35, the load-bearing and deformation capacity of structural components and assemblies shall be determined on the basis of a test procedure developed by a registered design professional that simulates applicable loading and deformation conditions. For components and assemblies that are not a part of the seismic-load-resisting system, the test shall be as specified in Section 1714.3.1. Load tests shall simulate the applicable loading conditions specified in Chapter 16.

**1714.3.1 Test procedure.** The test assembly shall be subjected to an increasing superimposed load equal to not less than two times the superimposed design load. The test load shall be left in place for a period of 24 hours. The tested assembly shall be considered to have successfully met the test requirements if the assembly recovers not less than 75 percent of the maximum deflection within 24 hours after the removal of the test load. The test assembly shall then be reloaded and subjected to an increasing superimposed load until either structural failure occurs or the superimposed load is equal to two and one-half times the load at which the deflection limitations specified in Section 1714.3.2 were reached, or the load is equal to two and one-half times the superimposed design load. In the case of structural components and assemblies for which deflection limitations are not specified in Section 1714.3.2,

the test specimen shall be subjected to an increasing superimposed load until structural failure occurs or the load is equal to two and one-half times the desired superimposed design load. The allowable superimposed design load shall be taken as the lesser of:

1. The load at the deflection limitation given in Section 1714.3.2.
2. The failure load divided by 2.5.
3. The maximum load applied divided by 2.5.

**1714.3.2 Deflection.** The deflection of structural members under the design load shall not exceed the limitations in Section 1604.3.

**1714.4 Wall and partition assemblies.** Load-bearing wall and partition assemblies shall sustain the test load both with and without window framing. The test load shall include all design load components. Wall and partition assemblies shall be tested both with and without door and window framing.

**1714.5 Exterior window and door assemblies.** The design pressure rating of exterior windows and doors in buildings shall be determined in accordance with Section 1714.5.1 or 1714.5.2.

**Exception:** Structural wind load design pressures for window units smaller than the size tested in accordance with Section 1714.5.1 or 1714.5.2 shall be permitted to be higher than the design value of the tested unit provided such higher pressures are determined by accepted engineering analysis. All components of the small unit shall be the same as the tested unit. Where such calculated design pressures are used, they shall be validated by an additional test of the window unit having the highest allowable design pressure.

**1714.5.1 Aluminum, vinyl and wood exterior windows and glass doors.** Aluminum, vinyl and wood exterior windows and glass doors shall be labeled as conforming to AAMA/NWWDA 101/I.S.2 or 101/I.S.2/NAFS. The label shall state the name of the manufacturer, the approved labeling agency and the product designation as specified in AAMA/NWWDA 101/I.S.2 or 101/I.S.2/NAFS. Products tested and labeled as conforming to AAMA/NWWDA 101/I.S.2 or 101/I.S.2/NAFS shall not be subject to the requirements of Sections 2403.2 and 2403.3.

**1714.5.2 Exterior windows and door assemblies not provided for in Section 1714.5.1.** Exterior window and door assemblies shall be tested in accordance with ASTM E 330. Exterior window and door assemblies containing glass shall comply with Section 2403. The design pressure for testing shall be calculated in accordance with Chapter 16. Each assembly shall be tested for 10 seconds at a load equal to 1.5 times the design pressure.

**1714.6 Test specimens.** Test specimens and construction shall be representative of the materials, workmanship and details normally used in practice. The properties of the materials used to construct the test assembly shall be determined on the basis of tests on samples taken from the load assembly or on representative samples of the materials used to construct the load test assembly. Required tests shall be conducted or witnessed by an approved agency.

## **SECTION BC 1715** **MATERIAL AND TEST STANDARDS**

### **1715.1 Test standards for joist hangers and connectors.**

**1715.1.1 Test standards for joist hangers.** The vertical load-bearing capacity, torsional moment capacity and deflection characteristics of joist hangers shall be determined in accordance with ASTM D 1761, using lumber having a specific gravity of 0.49 or greater, but not greater than 0.55, as determined in accordance with AFPA NDS for the joist and hangers.

**1715.1.2 Vertical load capacity for joist hangers.** The vertical load capacity for the joist hanger shall be determined by testing three joist hanger assemblies as specified in ASTM D 1761. If the ultimate vertical load for any one of the tests varies more than 20 percent from the average ultimate vertical load, at least three additional tests shall be conducted. The allowable vertical load for a normal duration of loading of the joist hanger shall be the lowest value determined from the following:

1. The lowest ultimate vertical load from any test divided by three (where three tests are conducted and each ultimate vertical load does not vary more than 20 percent from the average ultimate vertical load).
2. The average ultimate vertical load for all tests divided by six (where six or more tests are conducted).
3. The vertical load at which the vertical movement of the joist with respect to the header is 0.125 inch (3.2 mm) in any test.
4. The allowable design load for nails or other fasteners utilized to secure the joist hanger to the wood members.
5. The allowable design load for the wood members forming the connection.

**1715.1.3 Torsional moment capacity for joist hangers.** The torsional moment capacity for the joist hanger shall be determined by testing at least three joist hanger assemblies as specified in ASTM D 1761. The allowable torsional moment for normal duration of loading of the joist hanger shall be the average torsional moment

at which the lateral movement of the top or bottom of the joist with respect to the original position of the joist is 0.125 inch (3.2 mm).

**1715.1.4 Design value modifications for joist hangers.** Allowable design values for joist hangers that are determined by Item 4 or 5 in Section 1715.1.2 shall be permitted to be modified by the appropriate duration of loading factors as specified in AFPA NDS but shall not exceed the direct loads as determined by Item 1, 2 or 3 in Section 1715.1.2. Allowable design values determined by Item 1, 2 or 3 in Sections 1715.1.2 and 2305.1 shall not be modified by duration of loading factors.

## **1715.2 Concrete and clay roof tiles.**

**1715.2.1 Overturning resistance.** Concrete and clay roof tiles shall be tested to determine their resistance to overturning due to wind in accordance with SBCCI SSTD 11 and Chapter 15.

**1715.2.2 Wind tunnel testing.** When roof tiles do not satisfy the limitations in Chapter 16 for rigid tile, a wind tunnel test shall be used to determine the wind characteristics of the concrete or clay tile roof covering in accordance with SBCCI SSTD 11 and Chapter 15.

**TABLE 1704.3**  
**REQUIRED VERIFICATION AND INSPECTION OF STEEL CONSTRUCTION**

<u>Verification and Inspection</u>	<u>Continuous</u>	<u>Periodic</u>	<u>Referenced Standard</u>	<u>BC Reference</u>
<u>1. Material verification of high-strength bolts, nuts and washers:</u>				
A. <u>Identification markings to conform to ASTM standards specified in the approved construction documents.</u>	—	<u>X</u>	<u>Applicable ASTM material specification; AISC 335, Section A3.4; AISC LRFD Section A3.3</u>	—
B. <u>Manufacturer's certificate of compliance required.</u>	—	<u>X</u>	—	—
<u>2. Inspection of high-strength bolting:</u>				
A. <u>Bearing-type connections</u>	—	<u>X</u> Note b	<u>AISC LRFD Section M2.5</u>	<u>1704.3.3</u>
B. <u>Slip-critical connections.</u>	<u>X</u>	<u>X</u>		
<u>3. Material verification of structural steel:</u>				
A. <u>Identification markings to conform to ASTM standards specified in the approved construction documents.</u>	—	—	<u>ASTM A 6 or ASTM A 568</u>	<u>1708.4</u>
B. <u>Manufacturers' certified mill test reports.</u>	—	—	<u>ASTM A 6 or ASTM A 568</u>	
<u>4. Material Verification of weld filler materials</u>				
A. <u>Identification markings to conform to AWS specification in the approved construction documents.</u>	—	—	<u>AISC, ASD, Section A3.6; AISC LRFD, Section A3.5</u>	—
B. <u>Manufacturer's certificate of compliance required.</u>	—	—	—	—
<u>5. Inspection of welding:</u>				
<u>A. Structural Steel:</u>				
1) <u>Complete and partial penetration groove welds.</u>	<u>X</u>	—	<u>AWS D1.1</u>	<u>1704.3.1</u>
2) <u>Multipass fillet welds</u>	<u>X</u>	—		

3)	<u>Single-pass fillet welds &gt; 5/16"</u>	<u>X</u>	—		
4)	<u>Single-pass fillet welds ≤ 5/16"</u>	—	<u>X</u>		
5)	<u>Floor and deck welds</u>	—	<u>X</u>	<u>AWS D1.3</u>	—
<u>B. Reinforcing Steel:</u>		—	—		
1)	<u>Verification of weldability of reinforcing steel other than ASTM A 706.</u>	—	<u>X</u>		
2)	<u>Reinforcing steel-resisting flexural and axial forces in intermediate and special moment frames, and boundary elements of special reinforced concrete shear walls and shear reinforcement.</u>	<u>X</u>	—	<u>AWS d1.4</u> <u>ACI 318: 3.5.2</u>	<u>1903.5.2</u>
3)	<u>Shear reinforcement</u>	<u>X</u> <u>Note a</u>	—		
4)	<u>Other reinforcing steel.</u>	—	<u>X</u>		
<u>6. Inspection of steel frame joint details for compliance with approved construction documents:</u>			<u>X</u>		
	<u>a) Details such as bracing and stiffening.</u>	—	—	—	<u>1704.3.2</u>
	<u>b) member locations.</u>	—	—		
	<u>c) Application of joint details at each connection.</u>	—	—		

a) A minimum of 10% of shear studs shall be verified for strength of welded connection. If failure is evident on one or more then the strength of all shear studs shall be verified.

b) Turn of the nut bolting shall be continuously inspected. Exception: Periodic inspection shall be acceptable when the contractor's procedures have been established and verified for compliance by the special inspector.

**TABLE 1704.4**  
**REQUIRED VERIFICATION AND INSPECTION OF CONCRETE CONSTRUCTION**

<b><u>Verification and Inspection</u></b>	<b><u>Continuous</u></b>	<b><u>Periodic</u></b>	<b><u>Referenced Standard</u></b>	<b><u>BC Reference</u></b>
<u>1. Inspection of reinforcing steel, including prestressing tendons, and placement.</u>	—	X	<u>ACI 318:3.5, 7.1 – 7.7</u>	<u>1903.5, 1907.1, 1907.7, 1914.4</u>
<u>2. Inspection of reinforcing steel welding in accordance with table 1704.3, Item 5B.</u>	—	—	<u>AWS D1.4</u> <u>ACI 318:3.5.2</u>	<u>1903.5.2</u>
<u>3. Inspect bolts to be installed in concrete prior to and during placement of concrete where allowable loads have been increased.</u>	X	—	—	<u>1912.5</u>
<u>4. Verifying use of required design mix.</u>	—	X	<u>ACI 318: Ch. 4, 5.2-5.4</u>	<u>1904, 1905.2-1905.4, 1914.2,1914.3</u>
<u>5. At the time fresh concrete is sampled to fabricate specimens for strength tests, perform slump and air content tests, and determine the temperature of the concrete.</u>	X	—	<u>ASTM C 172</u> <u>ASTM C 31</u> <u>ACI 318: 5.6,5.8</u> <u>(Note a,b,c)</u>	<u>1905.6, 1914.10</u>
<u>6. Inspection of concrete and shotcrete placement for proper application techniques.</u>	X	—	<u>ACI 318: 5.9, 5.10</u>	<u>1905.9, 1905.10, 1914.6, 1914.7, 1914.8</u>
<u>7. Inspection for maintenance of specified curing temperature and techniques.</u>	—	X	<u>ACI 318: 5.11-5.13</u>	<u>1905.11, 1905.13, 1914.9</u>
<u>8. Inspection of prestressed concrete:</u> <u>A. Application of prestressing forces</u> <u>B. Grouting of bonded prestressing tendons in the seismic-force-resisting system.</u>	X X	—	<u>ACI 318: 18.20</u> <u>ACI 318:18.18.4</u>	—
<u>9. Erection of precast concrete members.</u>	—	X	<u>ACI 318: Ch. 16</u>	—
<u>10. Verification of in-situ concrete strength, prior to stressing of tendons in posttensioned concrete and prior to removal of shores and forms from beams and structural slabs.</u>	—	X	<u>ACI 318: 6.2</u>	<u>1906.2</u>

a) Standard sampling rate shall be in accordance with Section 1905.6.2.

b) 4"x8" cylinders may be accepted in lieu of 6"x12" cylinders at the option of the engineer of record.



**{NOTE: Modify Table 1704.5.1 below by changing the 4<sup>th</sup> column titled “IBC section” to read “BC section”}**

TABLE 1704.5.1  
LEVEL 1 SPECIAL INSPECTION

INSPECTION TASK	FREQUENCY OF INSPECTION		REFERENCE FOR CRITERIA		
	Continuous during task listed	Periodically during task listed	IBC section	ACI 530/ASCE 5/TMS 402 <sup>a</sup>	ACI 530.1/ASCE 6/TMS 602 <sup>a</sup>
1. As masonry construction begins, the following shall be verified to ensure compliance:					
a. Proportions of site-prepared mortar.		X			Art. 2.6A
b. Construction of mortar joints.	—	X	—	—	Art. 3.3B
c. Location of reinforcement and connectors.		X			Art. 3.4, 3.6A
d. Prestressing technique.	—	X	—	—	Art. 3.6B
e. Grade and size of prestressing tendons and anchorages.	—	X	—	—	Art. 2.4B, 2.4H
2. The inspection program shall verify:					
a. Size and location of structural elements.	—	X	—	—	Art. 3.3G
b. Type, size and location of anchors, including other details of anchorage of masonry to structural members, frames or other construction.	—	X	—	Sec. 1.2.2(e), 2.1.4, 3.1.6	—
c. Specified size, grade and type of reinforcement.	—	X	—	Sec. 1.12	Art. 2.4, 3.4
d. Welding of reinforcing bars.	X	—	—	Sec. 2.1.10.6.2, 3.2.3.4(b)	—
e. Protection of masonry during cold weather (temperature below 40°F) or hot weather (temperature above 90°F).	—	X	Sec. 2104.3, 2104.4	—	Art. 1.8C, 1.8D
f. Application and measurement of prestressing force.	—	X	—	—	Art. 3.6B
3. Prior to grouting, the following shall be verified to ensure compliance:					
a. Grout space is clean.		X		—	Art. 3.2D
b. Placement of reinforcement and connectors and prestressing tendons and anchorages.		X		Sec. 1.12	Art. 3.4
c. Proportions of site-prepared grout and prestressing grout for bonded tendons.	—	X	—	—	Art. 2.6B
d. Construction of mortar joints.		X		—	Art. 3.3B
4. Grout placement shall be verified to ensure compliance with code and construction document provisions.	X	—	—	—	Art. 3.5
a. Grouting of prestressing bonded tendons.	X	—	—	—	Art. 3.6C
5. Preparation of any required grout specimens, mortar specimens and/or prisms shall be observed.	X	—	Sec. 2105.2.2, 2105.3	—	Art. 1.4
6. Compliance with required inspection provisions of the construction documents and the approved submittals shall be verified.	—	X	—	—	Art. 1.5

For SI: °C = (°F - 32)/1.8.

a. The specific standards referenced are those listed in Chapter 35.

**TABLE 1704.5.3  
LEVEL 2 SPECIAL INSPECTION**

	<b>Frequency of Inspection</b>		<b>Reference for Criteria</b>		
	<b><u>Continuous during task listed</u></b>	<b><u>Periodically during task listed</u></b>	<b><u>BC Section</u></b>	<b><u>ACI 530/ASC 5/TMS 402<sup>a</sup></u></b>	<b><u>ACI 530.1/ASCE 6/TMS 602<sup>a</sup></u></b>
1. From the beginning of masonry construction, the following shall be verified to ensure compliance:					
a. Proportions of site-prepared mortar, grout and prestressing grout for bonded tendons.	—	X	—	—	Art. 2.6A
b. Placement of masonry units and construction of mortar joints.	—	X	—	—	Art. 3.3B
c. Placement of reinforcement, connectors, and prestressing tendons and anchorages.	—	X	—	Sec. 1.12	Art. 3.4, 3.6A
d. Grout space prior to grouting	X	—	—	—	Art. 3.2D
e. Placement of grout.	X	—	—	—	Art. 3.5
f. Placement of prestressing grout.	X	—	—	—	Art. 3.6C
2. The inspection program shall verify:					
a. Size and location of structural elements.	—	X	—	—	Art. 3.3G
b. Type, size, and location of anchors, including other details of anchorage of masonry to structural members, frames or other construction.	X	—	—	Sec. 1.2.2(e), 2.1.4, 3.1.6	—
c. Specified size, grade and type of reinforcement.	—	X	—	Sec.1.12	Art. 2.4, 3.4
d. welding reinforcement.	X	—	—	Sec. 2.1.10.6.2 3.2.3.4(b)	—
e. Protection of masonry during cold weather (temp. below 40°F) or hot weather (temp. above 90°F).	—	X	Sec. 2104.3, 2104.4	—	Art. 1.8C, 1.8D
f. Application and measurement of prestressing force.	X	—	—	—	Art. 3.6B
3. Preparation of any required grout specimens, mortar specimens and/or prisms shall be observed.	X	—	Sec. 2105.2.2, 2105.3	—	Art. 1.4

4. <u>Compliance with required inspection provisions of the construction documents and the approved submittals shall be verified.</u>	—	<u>X</u>	—	—	<u>Art. 1.5</u>
---	---	----------	---	---	-----------------

**CHAPTER 18**  
**SOILS AND FOUNDATIONS**

**SECTION BC 1801**  
**GENERAL**

**1801.1 Scope.** The provisions of this chapter shall apply to building and foundation systems in those areas not subject to scour or water pressure by wind and wave action. Buildings and foundations subject to such scour or water pressure loads shall be designed in accordance with Chapter 16 and Appendix G of this code.

**1801.2 Design.** Allowable bearing pressures, allowable stresses and design formulas provided in this chapter shall be used with the allowable stress design load combinations specified in Section 1605.3.

The quality and design of materials used structurally in excavations, footings and foundations shall conform to the requirements specified in Chapters 16, 19, 21, 22 and 23 of this code. Excavations and fills shall also comply with Chapter 33.

Members shall have adequate capacity to resist all applicable combinations of the loads listed in Chapter 16, in accordance with the following:

Where the structural design of soil or foundation members is based on allowable working stresses, the load reductions as described in Section 1605.3.1.1 shall be modified to use the following factors and the design shall be based on the resulting load values:

1. For the design of temporary structures (defined for this chapter as a structure, that will be in place 180 days or less) load combinations in Equations 16-8, 16-9 can be multiplied by a factor of 0.75.
2. For the design of temporary structures the Equations 16-10, 16-11, 16-12 can be multiplied by a factor of 0.67.
3. For any combination of dead loads with three or more variable loads, these variable loads can be multiplied by a factor of 0.67.
4. For the combinations of loads to be used in the design of permanent structures, the load due to lateral earth and ground water pressure shall be multiplied by a factor of 1.

**1801.2.1 Foundation design for seismic overturning.** Where the foundation is proportioned using the strength design load combinations of Section 1605.2, the seismic overturning moment need not exceed 75 percent of the value computed from Section 9.5.5.6 of ASCE7 for the equivalent lateral force method, or Section 1618 for the modal analysis method.

**SECTION BC 1802**

## **FOUNDATION AND SOILS INVESTIGATIONS**

**1802.1 General.** Foundation and soils investigations shall be subject to special inspections in accordance with Sections 1704.7, 1704.8 and 1704.9 and be conducted in conformance with Sections 1802.2 through 1802.6. An Engineer shall scope, supervise and approve the classification and subsurface investigation of soil.

**1802.2 Where required.** The owner or applicant shall submit a foundation and soils investigation to the commissioner where required in Sections 1802.2.1 through 1802.2.3.

**1802.2.1 Questionable soil.** Where the safe load-bearing capacity of the soil is in doubt, or where a load-bearing value superior to that specified in this code is claimed, the commissioner shall require that the necessary investigation be made. Such investigation shall comply with the provisions of Sections 1802.4 through 1802.6.

**1802.2.2 Seismic design category C.** Where a structure is determined to be in Seismic Design Category C in accordance with Section 1616, an investigation shall be conducted, and shall include an evaluation of the following potential hazards resulting from earthquake motions: slope instability, liquefaction and surface rupture due to faulting or lateral spreading.

**1802.2.3 Seismic design category D.** Where the structure is determined to be in Seismic Design Category D in accordance with Section 1616, the soils investigation requirements for Seismic Design Category C, given in Section 1802.2.6, shall be met, in addition to the following:

1. A site-specific analysis in accordance with Sections 1813.2, 1813.3, and 1813.4. Site specific response shall be evaluated for site peak ground acceleration magnitudes and source characteristics consistent with the design earthquake ground motions.
2. A determination of lateral pressures on basement, cellar, and retaining walls due to earthquake motions.
3. An assessment of potential consequences of any liquefaction and soil strength loss, including estimation of differential settlement, lateral movement or reduction in foundation soil-bearing capacity, and shall address mitigation measures. Such measures shall be given consideration in the design of the structure and shall include, but are not limited to, ground stabilization, selection of appropriate foundation type and depths, selection of appropriate structural systems to accommodate anticipated displacements or any combination of these measures. Peak ground acceleration shall be determined from a site-specific study taking into account soil amplification effects, as specified in Section 1615.2.

**Exception:** A site-specific study need not be performed provided that peak

ground acceleration equal to  $S_{DS}/2.5$  is used, where  $S_{DS}$  is determined in accordance with Section 1615.

**1802.3 Material classification.** Soil and rock classification shall be based on materials disclosed by borings, test pits or other subsurface exploration methods and shall be determined in accordance with Tables 1804.1 and 1804.2 and Section 1804.2. Additional laboratory tests shall be conducted to ascertain these classifications where deemed necessary by the engineer responsible for the investigation or the commissioner.

**1802.3.1 General.** For the purposes of this chapter, the definition and classification of soil materials for use in Table 1804.2 and Section 1804.2 shall be in accordance with ASTM D 2487.

**1802.4 Investigation.** Soil classification shall be based on observation and any necessary tests of the materials disclosed by borings, test pits or other subsurface exploration made in appropriate locations. Additional studies shall be made as necessary to evaluate stratigraphy, slope stability, soil strength, adequacy of load-bearing soils, the effect of moisture variation on soil-bearing capacity, compressibility, liquefaction and expansiveness.

**1802.4.1 Scope of investigation.** The scope of the soil investigation, including the number, types and depths of borings or test pits; the equipment used to drill and sample; the in-situ testing; and the laboratory testing program shall be determined by the engineer responsible for the investigation. Borings shall be uniformly distributed under the structure or distributed in accordance with load patterns imposed by the structure. As a minimum, investigations shall include two exploratory borings for built-over areas up to 5,000 square feet ( $465 \text{ m}^2$ ), and at least one additional boring for each additional 2,500 square feet ( $233 \text{ m}^2$ ), or part thereof, of built-over areas up to 20,000 square feet ( $1860 \text{ m}^2$ ). For built-over areas in excess of 20,000 square feet ( $1860 \text{ m}^2$ ), there shall be at least one boring for each additional 5,000 square feet ( $465 \text{ m}^2$ ), or part thereof. Borings shall be taken into bedrock, or to an adequate depth below the top of the load bearing strata to demonstrate that the foundation loads have been sufficiently dissipated. For structures having an average area load (dead plus live) of 1,000 pounds per square foot ( $47.9 \text{ kN/m}^2$ ) or more, at least one boring for every 10,000 square feet ( $930 \text{ m}^2$ ) of footprint area shall penetrate at least 100 feet (30 480 mm) below the curb grade or 5 feet (1524 mm) into bedrock of Class 1c or better, whichever is less. At least one-half of the borings satisfying this requirement shall be located within the limits of the built-up area and the remainder shall be within 25 feet (7620 mm) of the built-up area limits. For structures to be supported on pile foundations the required number of borings shall be increased by 30 percent.

The engineer responsible for the investigation shall have a qualified representative on the site inspecting all boring, sampling, and in-situ testing operations.

**Exception:** Test pits may be substituted for borings for one- and two-story structures, and may be used to establish the top of rock, where practical, for taller

structures. In such case, there shall be prepared a test pit observation report that shall be submitted to the commissioner.

**1802.4.2 Existing data.** Suitable borings, test pits, probings, and the logs and records that were obtained as part of earlier exploration programs and that meet the requirements of this section may be used as partial fulfillment of the requirements of this section, subject to the approval of the commissioner. Additional borings shall be made at the direction of the engineer responsible for the investigation when uncertainty exists as to the accuracy of the available information or specific new project or loading conditions indicate the need for additional information.

**1802.4.3 Ground-water table.** The subsurface soil investigation shall determine the existing ground-water table.

**1802.4.4 Compressible soils.** In areas that have compressible soils, the investigation shall determine the extent of these soils in the plan area of the building and shall determine the pre-consolidation pressure and consolidation parameters of the deposit using appropriate laboratory tests. The information shall be used in the building's foundation design.

**1802.5 Soil and rock sampling.** The soil boring and sampling procedures and apparatus shall be in accordance with ASTM D 1586 and D 1587 and generally accepted engineering practice. Where liquefaction assessment is performed, the investigation shall be in accordance with ASTM D 6066. The rock coring, sampling procedure and apparatus shall be in accordance with ASTM D 2113 and generally accepted engineering practice. Rock cores shall be obtained with a double-tube core barrel with a minimum outside diameter of 2 <sup>7</sup>/<sub>8</sub> inches (73 mm). With the approval of the engineer responsible for the investigation, smaller diameter double-tube core barrels may be used under special circumstances such as telescoping casing to penetrate boulders, or space limitations requiring the use of drill rigs incapable of obtaining large diameter cores.

**1802.5.1 Bedrock support.** Where the foundation design relies on rock to support footings, piles or caisson sockets, a sufficient number of rock corings shall extend at least 10 feet (3 048 mm) below the lowest level of bearing to provide assurance of the rock soundness. Where foundations are to rest on bedrock and such rock is exposed over a part or all of the area of the building, borings are not required in those areas where rock is exposed, provided the following requirements are met:

1. The presence of defects or the inclination of bedding planes in the rock are of such size and location so as not to affect stability of the foundation.
2. The foundation is not designed for bearing pressures exceeding those permitted in Table 1804.2.

**1802.5.2 Alternative investigative methods.** The engineer responsible for the investigation may engage specialized technicians to conduct alternative investigative methods such as cone penetrometer probing. Data from these investigations may be

used to: 1) supplement soil boring and rock coring information, provided there is a demonstrated correlation between the findings, and 2) determine material properties for static and seismic or liquefaction analyses. Subject to the approval of the commissioner, alternate exploration methods may replace borings on a two for one basis, but in no case shall there be less than two standard borings for every 10,000 square feet (930 m<sup>2</sup>) of footprint area. All the borings shall penetrate at least 100 feet (30 480 mm) below the curb grade or 5 feet (1524 mm) into rock when the average area load equals or exceeds one thousand pounds per square foot (48 kPa).

Other in-situ testing methods, such as geophysical, vane shear, and pressure meter may be used to determine engineering design parameters, but may not be used as a substitute for the required number of borings.

**1802.5.3 Material disposition.** Soil and rock samples shall be maintained in an accessible location, by the permit holder or owner and made available to the engineer responsible for the investigation and to the department, until the foundation work has been completed and accepted, or until one year after the investigation is complete, whichever is longer.

**1802.6 Reports.** The soil classification and design load-bearing capacity shall be shown on the construction documents. Where required by the commissioner, the engineer responsible for the investigation shall sign, seal and submit a written report of the investigation that includes, but need not be limited to, the following information:

1. A description of the planned structure
2. A plot showing the location of test borings and/or excavations.
3. A complete record of the soil sample descriptions.
4. A record of the soil profile.
5. Elevation of the water table, if encountered.
6. Results of in-situ or geophysical testing
7. Results of laboratory testing.
8. Recommendations for foundation type and design criteria, including but not limited to: bearing capacity of natural or compacted soil, mitigation of the effects of liquefaction (if applicable), differential settlement and varying soil strength; and the effects of adjacent loads.
9. Expected total and differential settlement.
10. Pile and pier foundation recommendations and installed capacities



11. Special design and construction provisions for footings or foundations founded on expansive soils, as necessary.

12. Compacted fill material properties and testing in accordance with Section 1803.5.

For pile or pier foundations, the report shall also include:

1. Special installation procedures.
2. Pier and pile load test requirements.

### **SECTION BC 1803** **EXCAVATION, GRADING AND FILL**

**1803.1 Excavations near footings or foundations.** Excavations for any purpose shall not remove lateral support from any footing or foundation without first underpinning or protecting the footing or foundation against settlement or lateral translation.

**1803.2 Placement of backfill.** The excavation outside the foundation shall be backfilled with soil that is free of organic material, construction debris, cobbles and boulders or a controlled low-strength material (CLSM). The backfill shall be placed in lifts and compacted, in a manner that does not damage the foundation or the waterproofing or damp proofing material.

**Exception:** Controlled low-strength material need not be compacted.

**1803.3 Site grading.** The ground immediately adjacent to the foundation shall be sloped away from the building as needed, or an approved alternate method of diverting water away from the foundation shall be used, where surface water would detrimentally affect the foundation bearing soils.

**1803.3.1 Seepage.** In an excavation where soil and ground water conditions are such that an inward or upward seepage might be produced in materials intended to provide vertical or lateral support for foundation elements or for adjacent foundations, excavating methods shall control or prevent the inflow of ground water to prevent disturbance of the soil material in the excavation or beneath existing buildings. No foundation shall be placed on soil that has been disturbed by seepage unless remedial measures have been taken.

**1803.4 Grading and fill in floodways.** Any floodway encroachment in areas of special flood hazard shall comply with Appendix G.

**1803.5 Compacted fill material.** Where footings will bear on compacted fill material, the compacted fill shall comply with the provisions of a geotechnical report, prepared by, signed and sealed by the engineer, which shall contain the following:

1. Specifications for the preparation of the site prior to placement of compacted fill

material.

2. Specifications for material to be used as compacted fill.
3. Test method to be used to determine the maximum dry density and optimum moisture content of the material to be used as compacted fill.
4. Maximum allowable thickness of each lift of compacted fill material.
5. Field test method for determining the in-place dry density of the compacted fill.
6. Minimum acceptable in-place dry density expressed as a percentage of the maximum dry density determined in accordance with Item 3.
7. Number and frequency of field tests required to determine compliance with Item 6.
8. Acceptable types of compaction equipment for the specified fill materials.

**1803.6 Controlled low-strength material (CLSM).** Where footings will bear on controlled low-strength material (CLSM), the CLSM shall comply with the provisions of a geotechnical report prepared by, signed and sealed by the engineer, which shall contain the following:

1. Specifications for the preparation of the site prior to placement of the CLSM.
2. Specifications for the CLSM.
3. Laboratory or field test method(s) to be used to determine the compressive strength or bearing capacity of the CLSM.
4. Test methods for determining the acceptance of the CLSM in the field.
5. Number and frequency of field tests required to determine compliance with Item 4.

**1803.7 Artificially treated soils.** After the treatment procedure, a minimum of one boring shall be made for every 1,600 square feet (149 m<sup>2</sup>) of that portion of the building that is supported on treated soil, and a sufficient number of samples shall be recovered from the treated soil to demonstrate the efficacy of the treatment.

## **SECTION BC 1804** **ALLOWABLE LOAD-BEARING VALUES OF SOILS**

**1804.1 Design.** The presumptive load-bearing values provided in Table 1804.1 shall be used with the allowable stress design load combinations specified in Section 1605.3 and Section 1801.2.

### **TABLE 1804.1**

**ALLOWABLE BEARING PRESSURES**  
**(Table attached to end of document)**

**1804.2 Allowable foundation pressure.** The allowable foundation pressure for supporting soils at or near the surface shall not exceed the values specified in Table 1804.1, unless data to substantiate the use of a higher value are developed and contained in the engineer's geotechnical report and subject to the commissioner's approval. Allowable bearing pressure shall be considered to be the pressure at the base of a foundation in excess of the stabilized overburden pressure existing at the same level prior to construction operations.

**TABLE 1804.2**  
**UNIFIED SOIL CLASSIFICATION SYSTEM**  
**(Table attached to end of document)**

**1804.2.1 Classification of materials.** Soil materials shall be classified and identified in accordance with Table 1804.2. In addition, refer to Sections 1804.2.1 through 1804.2.4 for supplementary definitions.

**BEDROCK.**

**Hard sound rock (Class 1a).** Includes crystalline rocks such as gneiss, granite, diabase, and schist. Characteristics are: the rock{:} rings when struck with pick or bar; {the rock} do not disintegrate after exposure to air or water; {the rock} break with sharp fresh fracture; cracks are unweathered and less than 1/8-inch (3.2 mm) wide, generally no closer than 3 feet (914 mm) apart; the RQD (Rock Quality Designation) with a double tube, NX-size diamond core barrel is generally 85 percent or greater for each 5 foot (1524 mm) run, or core recovery with BX-size core is generally 85 percent or greater for each 5 foot (1524 mm) run.

**Medium hard rock (Class 1b).** Includes crystalline rocks of paragraph (a) of this subdivision, plus marble and serpentinite. Characteristics are: all those listed in paragraph (a) of this subdivision, except that cracks may be 1/4-inch (6.4 mm) wide and slightly weathered, generally spaced no closer than 2 feet (610 mm) apart; the RQD with a double tube, NX-size diamond core barrel is generally between 50 and 85 percent for each 5 foot (1524 mm) run, or core recovery with BX-size core is generally fifty to eighty-five percent for each 5 foot (1524 mm) run.

**Intermediate rock (Class 1c).** Includes rocks described in paragraphs (a) and (b) of this subdivision, plus cemented shales and sandstone. Characteristics are: the rock gives dull sound when struck with pick or bar; does not disintegrate after exposure to air or water; broken pieces may show weathered surfaces; may contain fracture and weathered zones up to 1 inch (25 mm) wide spaced as close as 1 foot (305 mm); the RQD with a double tube, NX size diamond core barrel is

generally 35 to 50 percent for each 5 foot (1524 mm) run, or a core recovery with BX-size core of generally 35 to 50 percent for each 5 foot (1524 mm) run.

**Soft rock (Class 1d).** Includes rocks described in paragraphs (a), (b) and (c) of this subdivision in partially weathered condition, plus poorly cemented shales and sandstones. Characteristics are: rock may soften on exposure to air or water; may contain thoroughly weathered zones up to 3 inches (76 mm) wide but filled with stiff soil; the RQD with a double tube, NX-size diamond core barrel is less than 35 percent for each 5 foot (1524 mm) run, or core recovery with BX-size core of generally less than thirty-five percent for each 5 foot (1524 mm) run and a standard penetration resistance more than 50 blows per foot (0.3 meters).

**SANDY GRAVEL AND GRAVELS.** Consists of coarse-grained material with more than half of the coarse fraction larger than the # 4 size sieve and containing little or no fines (GW and GP). The density of these materials shall be determined in accordance with the following:

**Dense (Class 2a).** Those materials having a Standard Penetration Test N-value greater than 30 blows per one foot (0.3 meter).

**Medium (Class 2b).** Those materials having a Standard Penetration Test N-value between 10 and 30 blows per one foot (0.3 meter).

**Loose (Class 6).** Those materials having a Standard Penetration Test N-value less than 10 blows per one foot (0.3 meter).

**GRANULAR SOILS.** These materials are coarse-grained soils consisting of gravel and/or sand with appreciable amounts of fines, and gravel (GM, GC, SW, SP, SM, and SC). The density of granular materials shall be determined in accordance with the following:

**Dense (Class 3a).** Those materials having a Standard Penetration Test N-value greater than 30 blows per one foot (0.3 meter).

**Medium (Class 3b).** Those materials having a Standard Penetration Test N-value between 10 and 30 blows per one foot (0.3 meter).

**Loose (Class 6).** Those materials having Standard Penetration Test N-value less than 10 blows per one foot (0.3 meter).

**CLAYS.** In the absence of sufficient laboratory data, the consistency of clay materials (SC, CL, and CH) shall be determined in accordance with the following:

**Hard (Class 4a).** Clay requiring picking for removal, a fresh sample of which cannot be molded by pressure of the fingers, or having an unconfined

compressive strength in excess of 4 TSF (383 kPa), or Standard Penetration Test N-values greater than 30 blows per one foot (0.3 meter).

**Stiff (Class 4b).** Clay that can be removed by spading, a fresh sample of which requires substantial pressure of the fingers to create an indentation, or having an unconfined compressive strength between 1 TSF (96 kPa) and 4TSF (383 kPa), or Standard Penetration Test N-values between 8 and 30 blows per one foot (0.3 meter).

**Medium (Class 4c).** Clay that can be removed by spading, a fresh sample of which can be molded by substantial pressure of the fingers, or having an unconfined compressive strength between 0.5 TSF (48 kPa) and 1 TSF (96 kPa), or Standard Penetration Test N-values between 4 and 8 blows per one foot (0.3 meter).

**Soft (Class 6).** Clay, a fresh sample of which can be molded with slight pressure of the fingers, or having an unconfined compressive strength less than 0.5 TSF (48 kPa), or Standard Penetration Test N-values less than 4 blows per one foot (0.3 meter).

**SILTS AND CLAYEY SILTS.** In the absence of sufficient laboratory data, the consistency of silt materials (ML and MH) shall be determined in accordance with the following:

**Dense (Class 5a).** Silt with a Standard Penetration Test N-values greater than 30 blows per one foot (0.3 meter).

**Medium (Class 5b).** Silt with a Standard Penetration Test N-values between 10 and 30 blows per one foot (0.3 meter).

**Loose (Class 6).** Silt with a Standard Penetration Test N-values less than 10 blows per one foot (0.3 meters).

**Organic silts, organic clays, peats, soft clays, loose granular soils and varved silts.** The allowable bearing pressure shall be determined independently of Table 1804.1 subject to the following:

1. For varved silts, the soil bearing pressure produced by the proposed building shall not exceed two tons per square foot (192 kPa), except that for desiccated or over consolidated soils, higher bearing pressures are allowed subject to approval by the commissioner.
2. For organic silts or clays, soft clays, or for loose granular soils, the engineer responsible for the investigation shall establish the allowable soil bearing pressure based upon the soil's specific engineering properties. This may require that the soils be preconsolidated, artificially treated, or compacted.

3. A report prepared, signed and sealed by the engineer is required to be filed to substantiate the design soil pressures to be used on soil materials and it shall contain, at a minimum:
  - 3.1. Sufficient laboratory test data on the compressible material to indicate the soil strength and the preconsolidation pressure, coefficient of consolidation, coefficient of compressibility, permeability, secondary compression characteristics, and Atterberg limits.
  - 3.2. Where the design contemplates improvement of the natural bearing capacity and/or reduction in settlements by virtue of preloading: cross sections showing the amount of fill and surcharge to be placed, design details showing the required time for surcharging, and computations showing the amount of settlement to be expected during surcharging and the estimated amount and rate of settlement expected to occur after the structure has been completed, including the influence of dead and live loads of the structure.
  - 3.3. A detailed analysis showing that the anticipated future settlement will not adversely affect the performance of the structure.
  - 3.4. Where strip drains, sand drains, or stone columns are to be used, computations showing the diameter, spacing, and anticipated method of installation of such drains.
  - 3.5. Records of settlement plate elevations and pore pressure readings, before, during, and after surcharging.

**1804.2.2 Controlled fills.** Fills shall be considered as satisfactory bearing material of the applicable class when placed in accordance with the following procedures and subject to the special inspection provisions of Chapter 17:

1. Area to be filled shall be stripped of all organic materials, rubbish and debris.
2. Fill shall not be placed when frozen or on frozen or saturated subgrade.
3. The engineer, or the engineer's representative, shall approve the subgrade prior to fill placement.
4. Fill material shall consist of well graded sand, gravel, crushed rock, recycled concrete aggregate, or a mixture of these, or equivalent materials with a maximum of 10 percent passing the #200 sieve, as determined from the percent passing the #4 sieve.

5. Fill shall be placed and compacted in lifts, not exceeding 12 inches (305 millimeters), at its optimum moisture content, plus or minus two percent, and to not less than a density of ninety-five percent of the optimum density as determined by ASTM D 1557.
6. Fill density shall be verified by in-place tests made on each lift.
7. The allowable bearing value of controlled fill shall be limited to 3 tons per square foot (383 kPa) providing the underlying soil is not weaker than the controlled fill.

**1804.2.3 Uncontrolled fills.** Fills other than controlled fill may be considered as satisfactory bearing material of applicable class, subject to the following:

1. The soil within the building area shall be explored using test pits at every column. All test pits shall extend to depths equal to the smaller width of the footing and at least one test pit shall penetrate at least 8 feet (2438 mm) below the level of the bottom of the proposed footings. All test pits shall be backfilled with properly compacted fill. Borings may be used in lieu of test pits, provided that continuous samples of at least 3 inches (76 mm) in diameter are recovered.
2. The building area shall be additionally explored using one standard boring for every twenty-five hundred square foot (232.3 m<sup>2</sup>) of building footprint area. These borings shall be carried to a depth sufficient to penetrate into natural ground, but not less than 20 feet (6096 mm) below grade.
3. The fill shall be composed of material that is free of voids and free of extensive inclusions of mud, organic materials such as paper, wood, garbage, cans, or metallic objects, and debris.
4. The allowable soil bearing pressure on satisfactory uncontrolled fill material shall not exceed two tons per square foot (192 kPa). One- and two-family dwellings may be founded on satisfactory uncontrolled fill provided the dwelling site has been explored using at least one test pit, penetrating at least 8 feet (2438 mm) below the level of the bottom of the proposed footings, and that the fill has been found to be composed of material that is free of voids and generally free of mud, organic materials such as paper, garbage, cans, or metallic objects, and debris. Test pits shall be backfilled with properly compacted fill.

**1804.2.4 Artificially treated soils.** Nominally unsatisfactory soil materials that are artificially compacted, cemented, or preconsolidated may be used for the support of buildings, and nominally satisfactory soil materials that are similarly treated may be used to resist soil bearing pressures in excess of those indicated in Table 1804.1. The engineer shall develop treatment plans and procedures and post-treatment

performance and testing requirements and submit such plans, procedures, and requirements to the commissioner for approval. After treatment, a sufficient amount of sampling and/or in-situ tests shall be performed in the treated soil to demonstrate the efficacy of the treatment for the increased bearing pressure.

**1804.3 Reserved.**

## **SECTION BC 1805** **FOOTINGS AND FOUNDATIONS**

**1805.1 General.** Footings and foundations shall be designed and constructed in accordance with Sections 1805.1 through 1805.9. Footings and foundations shall be built on undisturbed soil, compacted fill material or CLSM. Compacted fill material shall be placed in accordance with Section 1803.5. CLSM shall be placed in accordance with Section 1803.6.

The top surface of footings shall be level. The bottom surface of footings is permitted to have a slope not exceeding one unit vertical in 10 units horizontal (10-percent slope). Footings shall be stepped where it is necessary to change the elevation of the top surface of the footing or where the surface of the ground slopes more than one unit vertical in 10 units horizontal (10-percent slope).

**1805.2 Depth of footings.** The minimum depth of footings below the undisturbed ground surface shall be 12 inches (305 mm). Where applicable, the depth of footings shall also conform to Sections 1805.2.1 through 1805.2.3.

**1805.2.1 Frost protection.** Except where otherwise protected from frost, foundation walls, piers and other permanent supports of buildings and structures shall be protected from frost by one or more of the following methods:

1. Extending a minimum of 4 feet (1219 mm) below grade;
2. Constructing in accordance with ASCE-32; or
3. Erecting on solid rock.

**Exception:** Free-standing buildings meeting all of the following conditions are shall not required to be protected:

1. Classified in Importance Category I (See Table 1604.5);
2. Area of 400 square feet (37 m<sup>2</sup>) or less; and
3. Eave height of 10 feet (3048 mm) or less.

Footings shall not bear on frozen soil unless such frozen condition is of a permanent character.



**1805.3 Foundations at different levels.** Where footings are supported at different levels, or are at different levels from the footings of adjacent structures, the influence of the pressures under the higher footings on the stability of the lower footings shall be considered in the design. The design shall consider the requirements for lateral support of the material supporting the higher footing, the additional load imposed on the lower footings, and assessment of the effects of dragdown on adjacent pile-supported buildings.

**1805.4 Footings.** Footings shall be designed and constructed in accordance with Sections 1805.4.1 through 1805.4.6.

**1805.4.1 Design.** Footings shall be so designed that the allowable bearing capacity of the soil is not exceeded, and that differential settlement is minimized. The minimum width of footings shall be 18 inches (457 mm).

**1805.4.1.1 Design loads.** Footings shall be designed for the most unfavorable effects due to the combinations of loads specified in Section 1605.3 and Section 1801.2. The dead load shall include the weight of foundations, footings and overlying fill. Reduced live loads, as specified in Section 1607.9, are permitted to be used in the design of footings.

**1805.4.1.2 Vibratory loads.** Where machinery operations or other vibrations are transmitted through the foundation, consideration shall be given in the footing design to prevent detrimental disturbances of the soil.

**1805.4.2 Concrete footings.** The design, materials and construction of concrete footings shall comply with Sections 1805.4.2.1 through 1805.4.2.6 and the provisions of Chapter 19.

**1805.4.2.1 Concrete strength.** Concrete in footings shall have a specified compressive strength ( $f'c$ ) of not less than 2,500 pounds per square inch (psi) (17 237 kPa) at 28 days.

**1805.4.2.2 Footing seismic ties.** Where a structure is assigned to Seismic Design Category D in accordance with Section 1616, individual spread footings founded on soil defined in Section 1615.1.1 as Site Class E or F shall be interconnected by ties. Ties shall be capable of carrying, in tension or compression, a force equal to the product of the larger footing load times the seismic coefficient  $S_{DS}$  divided by 10 unless it is demonstrated that equivalent restraint is provided by reinforced concrete beams within slabs on grade or reinforced concrete slabs on grade.

**1805.4.2.3 Plain concrete footings.** The edge thickness of plain concrete footings supporting walls of other than light-frame construction shall not be less than 8 inches (203 mm) where placed on soil.

**Exception:** For plain concrete footings supporting Group R-3 occupancies, the edge thickness is permitted to be 6 inches (152 mm), provided that the

footing does not extend beyond a distance greater than the thickness of the footing on either side of the supported wall.

**1805.4.2.4 Placement of concrete.** Concrete footings shall not be placed through water unless a tremie or other method approved by the commissioner is used. Where placed under or in the presence of water, the concrete shall be deposited by approved means to ensure minimum segregation of the mix and negligible turbulence of the water.

**1805.4.2.5 Protection of concrete.** No foundation shall be placed on frozen soil. No foundation shall be placed in freezing weather unless provision is made to maintain the underlying soil free of frost. Concrete footings shall be protected from freezing during depositing and for a period of not less than five days thereafter. Water shall not be allowed to flow through the deposited concrete.

**1805.4.3 Masonry-unit footings.** The design, materials and construction of masonry-unit footings shall comply with the provisions of Chapter 21.

**1805.4.4 Steel grillage footings.** Grillage footings of structural steel shapes shall be separated with approved steel spacers and be entirely encased in concrete with at least 6 inches (152 mm) on the bottom and at least 4 inches (102 mm) at all other points. The spaces between the shapes shall be completely filled with concrete or cement grout.

**1805.4.5 Timber footings.** Refer to Chapter 23.

**1805.4.6 Wood foundations.** Refer to Chapter 23.

**1805.5 Foundation walls.** Concrete and masonry foundation walls shall be designed in accordance with Chapter 19 or 21, respectively.

**1805.5.1 Foundation wall thickness.** The minimum thickness of concrete and masonry foundation walls shall comply with Section 1805.5.1.1.

**1805.5.1.1 Thickness based on walls supported.** The thickness of foundation walls shall not be less than the thickness of the wall supported, except that foundation walls of at least 8-inch (203 mm) nominal width are permitted to support brick-veneered frame walls and 10-inch-wide (254 mm) cavity walls.

**1805.5.2 Foundation wall drainage.** Foundation walls shall be designed to support the weight of the full hydrostatic pressure of undrained backfill unless a drainage system is installed in accordance with Sections 1807.4.2 and 1807.4.3. Foundation walls shall be designed to support the earth pressures due to the backfill including full hydrostatic pressure of undrained backfill unless a drainage system is installed in accordance with Sections 1807.4.2 and 1807.4.3.

**1805.5.3 Pier and curtain wall foundations.** Except in Seismic Design Category D,

pier and curtain wall foundations are permitted to be used to support light-frame construction not more than two stories in height, provided the following requirements are met:

1. All load-bearing walls shall be placed on continuous concrete footings bonded integrally with the exterior wall footings.
2. The minimum actual thickness of a load-bearing masonry wall shall not be less than 4 inches (102 mm) nominal or 3 <sup>5</sup>/<sub>8</sub> inches (92 mm) actual thickness, and shall be bonded integrally with piers spaced 6 feet (1829 mm) on center (o.c.).
3. Piers shall be constructed in accordance with Chapter 21 and the following:
  - 3.1. The unsupported height of the masonry piers shall not exceed 10 times their least dimension.
  - 3.2. Where structural clay tile or hollow concrete masonry units are used for piers supporting beams and girders, the cellular spaces shall be filled solidly with concrete or Type M or S mortar.

**Exception:** Unfilled hollow piers are permitted where the unsupported height of the pier is not more than four times its least dimension.
4. The maximum height of a 4-inch (102mm) load-bearing masonry foundation wall supporting wood frame walls and floors shall not be more than 4 feet (1219 mm) in height.
5. The unbalanced fill for 4-inch (102 mm) foundation walls shall not exceed 24 inches (610 mm) for solid masonry, nor 12 inches (305mm) for hollow masonry.

**1805.6** Reserved.

**1805.7** Reserved.

**1805.8** Reserved.

**1805.9 Seismic requirements.** See Section 1910 for additional requirements for footings and foundations of structures assigned to Seismic Design Category C or D. For structures assigned to Seismic Design Category D, provisions of ACI 318, Sections 21.10.1 to 21.10.3 shall apply when not in conflict with the provisions of Section 1805. Concrete shall have a specified compressive strength of not less than 3,000 psi (20.68 MPa) at 28 days.

**Exceptions:**

1. Group R or U occupancies of light-framed construction and two stories or less in height are permitted to use concrete with a specified compressive strength of not less than 2,500 psi (17.2 MPa) at 28 days.
2. One- and two-family dwellings not more than three stories in height are not required to comply with the provisions of ACI 318, Sections 21.10.1 to 21.10.3.

## **SECTION BC 1806** **RETAINING WALLS AND OTHER RETAINING STRUCTURES**

**1806.1 General.** Retaining walls shall be designed to ensure stability against overturning, sliding, excessive foundation pressure and water uplift. Retaining walls shall be designed for a safety factor of 1.5 against lateral sliding and overturning.

**1806.2 Seismic loads on retaining walls and other retaining structures.** Seismic foundation design shall comply with the requirements of ASCE 7, Section 9.7. The geotechnical analysis and design shall take into consideration the yielding characteristics of the retaining walls or other retaining structures.

## **SECTION BC 1807** **DAMPPROOFING AND WATERPROOFING**

**1807.1 Where required.** Walls or portions thereof that retain earth and enclose interior spaces and floors below grade shall be waterproofed and dampproofed in accordance with this section, with the exception of those spaces containing occupancy groups other than residential and institutional where such omission is not detrimental to the building or occupancy. Ventilation for crawl spaces shall comply with Section 1203.3.

**1807.1.1 Story above grade.** Where a basement or cellar is considered a story above grade and the finished ground level adjacent to the basement or cellar wall is below the basement or cellar floor elevation for 25 percent or more of the perimeter, the floor and walls shall be dampproofed in accordance with Section 1807.2 and a foundation drain shall be installed in accordance with Section 1807.4.2. The foundation drain shall be installed around the portion of the perimeter where the basement or cellar floor is belowground level. The provisions of Sections 1807.3 and 1807.4.1 shall not apply in this case.

**1807.1.2 Under-floor space.** The finished ground level of an under-floor space such as a crawl space shall not be located below the bottom of the footings. Where there is evidence that the ground-water table rises to within 6 inches (152 mm) of the ground level at the outside building perimeter, or that the surface water does not readily drain from the building site, the ground level of the under-floor space shall be as high as the outside finished ground level, unless an approved drainage system is provided. The provisions of Sections 1802.2.3, 1807.2, 1807.3 and 1807.4 shall not apply in this case.

**1807.1.2.1 Flood hazard areas.** For buildings and structures in areas of special flood hazard, the finished ground level of an under-floor space such as a crawl space shall comply with Appendix G.

**1807.1.3 Ground-water control.** Where the ground-water table is lowered and maintained at an elevation not less than 6 inches (152 mm) below the bottom of the lowest floor, the floor and walls shall be dampproofed in accordance with Section 1807.2. The design of the system to lower the ground-water table shall be based on accepted principles of engineering that shall consider, but not necessarily be limited to, permeability of the soil, rate at which water enters the drainage system, rated capacity of pumps, head against which pumps are to operate and the rated capacity of the disposal area of the system.

**1807.2 Dampproofing required.** Where hydrostatic pressure will not occur as determined by Section 1802, floors and walls for other than wood foundation systems shall be dampproofed in accordance with this section. Wood foundation systems shall be constructed in accordance with AFPA TR7.

**1807.2.1 Floors.** Dampproofing materials for floors shall be installed between the floor and the base course required by Section 1807.4.1, except where a separate floor is provided above a concrete slab. Where installed beneath the slab, dampproofing shall consist of not less than 6-mil (0.006 inch; 0.152 mm) polyethylene with joints lapped not less than 6 inches (152 mm), or other approved methods or materials. Where permitted to be installed on top of the slab, dampproofing shall consist of mopped-on bitumen, not less than 4-mil (0.004 inch; 0.102 mm) polyethylene, or other approved methods or materials. Joints in the membrane shall be lapped and sealed in accordance with the manufacturer's installation instructions.

**1807.2.2 Walls.** Dampproofing materials for walls shall be installed on the exterior surface of the wall, and shall extend from the top of the footing to above ground level. Dampproofing shall consist of a bituminous material, 3 pounds per square yard (16 N/m<sup>2</sup>) of acrylic modified cement, 1/8-inch (3.2 mm) coat of surface-bonding mortar complying with ASTM C 887, any of the materials permitted for waterproofing by Section 1807.3.2 or other approved methods or materials.

**1807.2.2.1 Surface preparation of walls.** Prior to application of dampproofing materials on concrete walls, holes and recesses resulting from the removal of form ties shall be sealed with a bituminous material or other approved methods or materials. Unit masonry walls shall be parged on the exterior surface below ground level with not less than 3/8 inch (9.5 mm) of portland cement mortar. The parging shall be covered at the footing.

**Exception:** Parging of unit masonry walls is not required where a material is approved for direct application to the masonry.

**1807.3 Waterproofing required.** Where the investigation required by Section 1802

indicates that a hydro-static pressure condition exists, and the design does not include a ground-water control system as described in Section 1807.1.3, walls and floors shall be waterproofed in accordance with this section.

**1807.3.1 Floors.** Floors required to be waterproofed shall be of concrete, designed and constructed to withstand the hydrostatic pressures to which the floors will be subjected. Waterproofing shall be accomplished by placing a membrane of rubberized asphalt, butyl rubber, or not less than 6-mil (0.006 inch; 0.152 mm) polyvinyl chloride with joints lapped not less than 6 inches (152 mm) or other approved materials under the slab. Joints in the membrane shall be lapped and sealed in accordance with the manufacturer's installation instructions.

**1807.3.2 Walls.** Walls required to be waterproofed shall be of concrete or masonry and shall be designed and constructed to withstand the hydrostatic pressures and other lateral loads to which the walls will be subjected. Waterproofing shall be applied from the bottom of the wall to not less than 12 inches (305 mm) above the maximum elevation of the ground-water table. The remainder of the wall shall be dampproofed in accordance with Section 1807.2.2. Waterproofing shall consist of two-ply hot-mopped felts, not less than 6-mil (0.006 inch; 0.152 mm) polyvinyl chloride, 40-mil (0.040 inch; 1.02 mm) polymer-modified asphalt, 6-mil (0.006 inch; 0.152 mm) polyethylene or other approved methods or materials capable of bridging nonstructural cracks. Joints in the membrane shall be lapped and sealed in accordance with the manufacturer's installation instructions.

**1807.3.2.1 Surface preparation of walls.** Prior to the application of waterproofing materials on concrete or masonry walls, the walls shall be prepared in accordance with Section 1807.2.2.1.

**1807.3.3 Joints and penetrations.** Joints in walls and floors, joints between the wall and floor and penetrations of the wall and floor shall be made water-tight utilizing approved methods and materials.

**1807.4 Subsoil drainage system.** Where a hydrostatic pressure is to be controlled by a subsoil drainage system, dampproofing, a floor base course, and subdrains around the foundation perimeter and under the floor shall be provided. A subsoil drainage system designed and constructed in accordance with Section 1807.1.3 shall be deemed adequate for lowering the ground-water table.

**1807.4.1 Floor base course.** Floors of basements or cellars, except as provided for in Section 1807.1.1, shall be placed over a floor base course not less than 4 inches (102 mm) in thickness that consists of gravel or crushed stone containing not more than 10 percent of material that passes through a No. 4 (4.75 mm) sieve.

**Exception:** Where a site is located in well-drained gravel or sand/gravel mixture soils, a floor base course is not required.

**1807.4.2 Foundation drain.** A drain that consists of gravel or crushed stone

containing not more than 10-percent material that passes through a No. 4 (4.75 mm) sieve shall be placed around the perimeter of a foundation. The drain shall extend a minimum of 12 inches (305 mm) beyond the outside edge of the footing. The thickness shall be such that the bottom of the drain is not higher than the bottom of the base under the floor, and that the top of the drain is not less than 6 inches (152 mm) above the top of the footing. The top of the drain shall be covered with an approved filter membrane material. Where a drain tile or perforated pipe is used, the invert of the pipe or tile shall not be higher than the floor elevation. The top of joints or the top of perforations shall be protected with an approved filter membrane material. The pipe or tile shall be placed on not less than 2 inches (51 mm) of gravel or crushed stone complying with Section 1807.4.1, and shall be covered with not less than 6 inches (152 mm) of the same material.

**1807.4.3 Drainage discharge.** The floor base and foundation perimeter drain shall discharge by gravity or mechanical means into an approved drainage system that complies with the *New York City Plumbing Code*.

**Exception:** Where a site is located in well-drained gravel or sand/gravel mixture soils, a dedicated drainage system is not required.

**1807.5 In-situ walls.** Applied waterproofing or damp-proofing need not be applied to slurry walls, or walls constructed below the water table. In-situ walls shall be constructed with watertight joints between individual elements and sealed by grouting to achieve a uniform watertight surface. External drains and waterproofing are not required. In-situ walls constructed using tangent pile or secant pile may require waterproofing systems, because their joints cannot be sealed. For both instances, an under floor seepage collection system or pressure slab shall be provided.

## **SECTION BC 1808** **PIER AND PILE FOUNDATIONS**

**1808.1 Definitions.** The following words and terms shall, for the purposes of this section, have the meanings shown herein.

**FLEXURAL LENGTH.** Flexural length is the length of the pile from the first point of zero lateral deflection to the underside of the pile cap or grade beam.

**PIER FOUNDATIONS.** Pier foundations consist of isolated masonry or cast-in-place concrete structural elements extending into firm materials. Piers are relatively short in comparison to their width, with lengths less than or equal to 12 times the least horizontal dimension of the pier. Piers derive their load-carrying capacity through skin friction, through end bearing, or a combination of both.

**Belled piers.** Belled piers are cast-in-place concrete piers constructed with a base that is larger than the diameter of the remainder of the pier. The belled base is designed to increase the load-bearing area of the pier in end bearing.

**PILE FOUNDATIONS.** Pile foundations consist of concrete, wood or steel structural elements either driven into the ground or cast in place. Piles are relatively slender in comparison to their length, with lengths exceeding 12 times the least horizontal dimension. Piles derive their load-carrying capacity through skin friction, through end bearing, or a combination of both.

**Augered-cast-in-place piles.** Augered-cast-in-place piles are constructed by pumping grout into an augered hole during the withdrawal of the auger. The pile is reinforced with a single reinforcing bar, a reinforcing steel cage or a structural steel section.

**Caisson piles.** Steel cased piles are constructed by driving a steel shell to a watertight seal at the top of rock and drilling of an uncased socket within the rock. The shell and socket is filled with a steel core section and concrete or grout.

**Compacted Concrete Piles.** Compacted concrete piles are constructed by filling a shaft with low strength concrete as the casing is withdrawn.

**Concrete-filled steel pipe and tube piles.** Concrete-filled steel pipe and tube piles are constructed by driving a steel pipe or tube section into the soil and filling the pipe or tube section with concrete. The steel pipe or tube section is left in place during and after the deposition of the concrete.

**Driven uncased piles.** Driven uncased piles are constructed by driving a steel shell into the soil to shore an unexcavated hole that is later filled with concrete. The steel casing is lifted out of the hole during the deposition of the concrete. These piles are allowed only if the concrete is placed under pressure.

**Enlarged base piles.** Enlarged base piles are cast-in-place concrete piles constructed with a base that is larger than the diameter of the remainder of the pile. The enlarged base is designed to increase the load-bearing area of the pile in end bearing. Enlarged base piles include piles installed by driving a pre-cast concrete tip or by compacting concrete into the base of the pile to form an enlarged base.

**H-Piles.** Steel H-piles are constructed by driving a steel H shaped section into the ground.

**Steel-cased piles.** Steel-cased piles are constructed by driving a steel shell into the soil to shore an unexcavated hole. The steel casing is left permanently in place and filled with concrete.

**Jacked Piles.** Steel pipe piles installed by hydraulically jacking the pile into the ground against a dead weight reaction. Piles installed by other static forces shall be considered in this category.

**Micro-piles / mini-piles.** Small diameter drilled steel cased piles, driven uncased piles or caisson piles.



**Open End Pipe Pile.** Steel pipe driven open ended that may or may not be filled with concrete or soil.

## **1808.2 Piers and piles—general requirements.**

**1808.2.1 Design.** Piles are permitted to be designed in accordance with provisions for piers in Section 1808 and Sections 1812.3 through 1812.11 where either of the following conditions exists, subject to the approval of the commissioner:

1. Group R-3 and U occupancies not exceeding two stories of light-frame construction, or
2. Where the surrounding foundation materials furnish adequate lateral support for the pile.

**1808.2.2 General.** Pier and pile foundations shall be designed and installed on the basis of a foundation investigation as defined in Section 1802.

The investigation and report provisions of Section 1802 shall be expanded to include, but not be limited to, the following:

1. Recommended pier or pile types and installed capacities.
2. Recommended center-to-center spacing of piers or piles.
3. Driving criteria.
4. Installation procedures.
5. Field inspection and reporting procedures (to include procedures for verification of the installed bearing capacity where required).
6. Pier or pile load test requirements.
7. Durability of pier or pile materials.
8. Designation of bearing stratum or strata.
9. Reductions for group action, where necessary.

Pier and pile foundations shall be designed and installed under the direct control of an engineer knowledgeable in the field of geotechnical engineering and pier and pile foundations and shall be subject to special inspection performed under the direct control of such engineer. The engineer shall certify to the commissioner that the piers or piles as installed satisfy the design criteria.

**1808.2.3 Special types of piles.** The use of types of piles not specifically mentioned

herein is permitted, subject to the approval of the commissioner, upon the submission of acceptable test data, calculations and other information relating to the structural properties and load capacity of such piles. The allowable stresses shall not in any case exceed the limitations specified herein.

**1808.2.4 Pile caps.** Pile caps shall be of reinforced concrete, and shall include all elements to which piles are connected, including grade beams and mats. The soil immediately below the pile cap shall not be considered as carrying any vertical load. The tops of piles shall be embedded not less than 3 inches (76 mm) into pile caps and the caps shall extend at least 4 inches (102 mm) beyond the edges of piles. The tops of piles shall be cut back to sound material before capping.

**1808.2.5 Stability.** Piers or piles shall be braced to provide lateral stability in all directions. Three or more piles connected by a rigid cap shall be considered braced, provided that the piles are located in radial directions from the centroid of the group not less than 60 degrees (1 rad) apart. A two-pile group in a rigid cap shall be considered to be braced along the axis connecting the two piles. Methods used to brace piers or piles shall be subject to the approval of the commissioner. Piles supporting walls shall be driven alternately in lines spaced at least 1 foot (305 mm) apart and located symmetrically under the center of gravity of the wall load carried, unless effective measures are taken to provide for eccentricity and lateral forces, or the wall piles are adequately braced to provide for lateral stability. A single row of piles without lateral bracing is permitted for one- and two-family dwellings and lightweight construction not exceeding two stories or 35 feet (10 668 mm) in height, provided the centers of the piles are located within the width of the foundation wall.

**1808.2.6 Structural integrity.** Piers or piles shall be installed in such a manner and sequence as to prevent distortion or damage to piles being installed or already in place to the extent that such distortion or damage affects the structural integrity of the piles.

**1808.2.6.1 Minimum spacing of piles.** Piles shall be spaced to meet the following requirements:

1. Spacing of piles shall provide for adequate distribution of the load on the pile group to the supporting soil. In no case shall the minimum center-to-center spacing of piles be less than 24 inches (610 mm) nor less than the following for the specific types of piling indicated in this chapter.
2. Minimum spacing between enlarged base concrete piles shall be 4 feet 6 inches (1372 mm), center to center except that where the shafts of such piles are cased for their full length, this spacing may be reduced to 3 feet 6 inches (1067 mm). Where a question exists as to possible damage to adjacent previously driven piles, these minimums shall be increased. Minimum center-to-center spacing of piles at the bearing level shall be at least two and one half times the outside diameter of the shell.
3. Unless special measures are taken to assure that piles will penetrate

sufficiently to meet the requirements of 1808.2.8 without interfering with or intersecting each other, the minimum center to center spacing of piles shall be twice the average diameter of the butt for round piles, one and three quarters times the diagonal for rectangular piles; or, for taper piles, twice the diameter at a level two thirds of the pile length measured up from the tip.

4. In cases of practical difficulty, the spacing of new piles from existing piles under an adjacent building may be less than the above values provided that the requirements relating to minimum embedment and pile interference are satisfied and that the soil under the proposed and existing buildings is not overloaded by the closer pile grouping.

**1808.2.6.2 Piles located near a lot line.** Piles located near a lot line shall be designed on the assumption that the adjacent lot will be excavated to a depth of 10 feet (3048 mm) below the nearest legally established curb level. Where such excavation would reduce the embedded length of the pile, the portion of the pile exposed shall be deemed to provide no lateral or vertical support, and the load carrying determination shall be made the resistance offered by the soil that is subject to potential excavation has been discounted.

**1808.2.7 Splices.** Splices shall be constructed so as to provide and maintain true alignment and position of the component parts of the pile during installation and subsequent thereto and shall be of adequate strength to transmit the vertical and lateral loads (including tensions) and the moments occurring in the pile section at the location of the splice without exceeding the allowable stresses for such materials as established in Section 1809. In all cases splices shall develop at least 50 percent of the capacity of the pile in bending. In all cases pile splices situated in the upper 10 feet (3048 mm) of the pile shall be capable of resisting (at allowable working stresses) the applied moments and shears or the moment and shear that would result from an assumed eccentricity of the pile load of 3 inches (76 mm), whichever is greater. For piles located near a lot line, the embedded length of such piles shall be determined on the basis that the adjacent site will be excavated to a depth of 10 feet (3048 mm) below the nearest established curb level as required in Section 1808.2.6.2.

**1808.2.8 Allowable pier or pile loads.** Allowable pier or pile loads shall be determined in accordance with Section 1808.2.8.1 through 1808.2.8.9.

**1808.2.8.1 Determination of allowable loads.** The allowable axial and lateral loads on piers or piles shall be determined by load tests or a recognized method of analysis. The allowable load shall be determined by a licensed engineer experienced in geotechnical engineering and shall be approved by the commissioner.

The allowable axial load on a pile shall be the least value permitted by consideration of the following factors (for battered piles, the axial load shall be

computed from the resultant of all vertical loads and lateral forces occurring simultaneously):

1. The capacity of the pile as a structural member.
2. The allowable bearing pressure on soil strata underlying the pile tips.
3. The resistance to penetration of the piles, including resistance to driving, resistance to jacking, the rate of penetration, or other equivalent criteria.
4. The capacity as indicated by load test, where load tests are required.
5. The maximum loads prescribed in Section 1808.2.8.1.3.

**1808.2.8.1.1 Bearing capacity.** The allowable pile load shall be limited by the provision that the pressures in materials at and below the pile tips, produced by the loads on individual piles and by the aggregate of all piles in a group or foundation, shall not exceed the allowable bearing values established in Table 1804.1. The transfer of load from piles to soil shall be determined by a recognized method of analysis. As an alternative, for purposes of this section, piles or pile groups may be assumed to transfer their loads to the underlying materials by spreading the load uniformly at an angle of sixty degrees with the horizontal, starting at a polygon circumscribing the piles, located as follows:

1. For piles embedded entirely in decomposed rock or granular soils, or in controlled fill materials, the polygon shall be circumscribed at a level located two-thirds of the embedded length of the pile, measured up from the tip.
2. For piles penetrating through silts and clays into bearing in decomposed rock or granular soils, the polygon shall be circumscribed at the bottom of the strata of silts or clays.

**1808.2.8.1.2 Bearing stratum.** The plans for the proposed work shall establish, in accordance with the requirements relating to allowable bearing pressure, the bearing stratum to which the piles in the various sections of the building must penetrate and the approximate elevations of the top of such bearing stratum. Where penetration of a given distance into the bearing strata is required for adequate distribution of the loads, such penetration shall be shown on the plans. The indicated elevations of the top of the bearing strata shall be modified by such additional data as may be obtained during construction. All piles shall penetrate to or into the designated bearing stratum.

**1808.2.8.1.3 Maximum loads.** Except as permitted by the provisions of Section 1808.2.8.3.1.6, the maximum allowable pile load shall not exceed the

values specified in Table 1808.2.8.1.3.

**TABLE 1808.2.8.1.3**  
**MAXIMUM ALLOWABLE PILE LOADS**  
**(Table attached to end of document)**

**1808.2.8.1.4 Minimum pile penetrations.** Piles shall penetrate the minimum distance required to develop the required load capacity of the pile as established by the required penetration resistance and load tests as applicable.

**1808.2.8.1.5 Capacity as indicated by resistance to penetration.** Where subsurface investigation and general experience in the area indicate that the soil that must be penetrated by the pile consists of glacial deposits containing boulders, or fills containing riprap, excavated detritus, masonry, concrete or other obstructions in sufficient numbers to present a hazard to the installation of the piles, the selection of type of pile and penetration criteria shall be subject to the approval of the commissioner but in no case shall the minimum penetration resistance be less than that stated in Tables 1808.2.8.1.5A and 1802.8.2.8.1.5B.

**TABLE 1808.2.8.1.5A**  
**MINIMUM DRIVING RESISTANCE AND MINIMUM**  
**HAMMER ENERGY FOR STEEL H-PILES, PIPE PILES, PRECAST AND**  
**CAST-IN-PLACE CONCRETE PILES AND COMPOSITE PILES**  
**(other than timber)**  
**(Table attached to end of document)**

**TABLE 1808.2.8.1.5B**  
**MINIMUM DRIVING RESISTANCE AND**  
**HAMMER ENERGY FOR TIMBER PILES**  
**(Table attached to end of document)**

**1808.2.8.1.5.1 Piles installed by use of steam-powered, air-powered, diesel-powered or hydraulic impact hammers.**

1. The minimum required driving resistance and the requirements for hammer energies for various types and capacities of piles are given in Tables 1808.2.8.1.5A and 1808.2.8.1.5.B. To obtain the required total driving resistance, the indicated driving resistances shall be added to any driving resistance experienced by the pile during installation, but which will be dissipated with time (resistance exerted by non-bearing materials or by materials which are to be excavated). For the purposes of this section, the resistance exerted by non-bearing materials may be approximated as the resistance to penetration of the pile recorded when the pile has penetrated to the bottom of the lowest stratum of nominally unsatisfactory bearing

material (class 6 and uncontrolled fills, but not controlled fill) or to the bottom of the lowest stratum of soft or loose deposits of soils of class 4 or 5 but only where such strata are completely penetrated by the pile.

2. Alternate for similitude method - The requirement for installation of piling to the penetration resistances given in tables 1808.2.8.1.5A and 1808.2.8.1.5B may be waived where the following six conditions are satisfied:

2.1. The piles bear on, or in, soil of class 2 through class 5.

2.2. The stratigraphy, as defined by not less than one boring for every 1600 square feet (149 m<sup>2</sup>) of building area, shall be reasonably uniform or divisible into areas of uniform conditions.

2.3. Regardless of pile type or capacity, one load test, as described in Section 1808.2.8.1.5.3, shall be conducted in each area of uniform conditions, but not less than two typical piles for the entire foundation installation of the building or group of buildings on the site, nor less than one pile for every 15,000 square feet (1394 m<sup>2</sup>) of pile foundation area shall be load tested.

2.4. Except as permitted by the provisions of paragraph 6 below, all building piles within the area of influence of a given load-tested pile of satisfactory performance shall be installed to the same or greater driving resistance as the successful load-tested pile. The same or heavier equipment of the same type that was used to install the load-tested pile shall be used to install all other building piles, and the equipment shall be operated identically. Also, all other piles shall be of the same type, shape, external dimension, and equal or greater cross-section as the load-tested pile. All building piles within the area of influence represented by a given satisfactory load-tested pile shall bear in, or on the same bearing stratum as the load test pile.

2.5. A report by an engineer shall be submitted to the commissioner for review and approval establishing that the soil bearing pressures do not exceed the values permitted by Table 1804.1 and that the probable differential settlements will not cause stress conditions in the building in excess of those permitted by the provisions of this code.

2.6. Where the structure of the building or the spacing and length of the piling is such as to cause the building and its foundation to act as an essentially rigid body, the building piles may be driven to length and/or penetration into the bearing stratum without regard to penetration resistance, subject to the requirement of paragraph 5 above, relating to the submission and approval of a report.

**1808.2.8.1.5.2 Piles installed by jacking or other static forces.** The carrying capacity of a pile installed by jacking or other static forces shall be not more than 50 percent of the load or force used to install the pile to the required penetration, except for piles jacked into position for underpinning. The working load of each permanent underpinning pile shall not exceed the larger of the following values: two-thirds of the total jacking force used to obtain the required penetration if the load is held constant for seven hours without measurable settlement; or one-half of the total jacking force at final penetration if the load is held for a period of one hour without measurable settlement. The jacking resistance used to determine the working load shall not include the resistance offered by non-bearing materials which will be dissipated with time.

**1808.2.8.1.5.3 Piles installed by use of vibratory hammer.** The capacity of piles installed by vibratory hammer shall not exceed the value established on the principle of similitude, as follows:

1. Comparison piles, as required by the provisions of Item 4 below, shall be installed using an impact hammer and driving resistances corresponding to the proposed pile capacities as determined in paragraph (c) below or to tip elevations and driving resistances as determined by the engineer.
2. For each comparison pile, an identical index pile shall be installed by use of the vibratory hammer at a location at least 4 feet (1219 mm), but not more than 6 feet (1829 mm), from each comparison pile. The index piles shall be installed to the same tip elevation as the comparison pile, except that where the comparison piles bear on rock, the index piles shall bear in or on similar material. All driving data for the index pile shall be recorded.
3. The index piles shall be load tested in accordance with the provisions of Item 4 of this section. Should the specified load test criteria indicate inadequate capacity of the index piles, steps a, b, and c shall be repeated using longer, larger, or other types of piles.
4. All building piles within the area of influence of a given, satisfactorily tested index pile shall be installed to the same or

lesser rate of penetration (inches per minute [mm per minute]) as the successful index pile. The same equipment that was used to install the index pile, identically operated in all aspects, shall be used to install the building piles. All building piles shall be of the same type size and shape as the index pile. All building piles within the area of influence as represented by a given satisfactorily tested index pile shall bear in, or on, the same bearing stratum as the index pile.

**1808.2.8.2 Driving criteria.** The allowable compressive load on steel and concrete piles, where determined solely by the application of an approved wave equation analyses, shall not exceed 40 tons (356 kN). The allowable compressive loads on timber piles, where determined solely by the wave equation analysis shall not exceed 30 tons. For allowable loads greater than these values, the wave equation method of analysis may be used to establish initial driving criteria, but final driving criteria and the allowable load shall be verified by load tests. The delivered energy of the hammer to be used shall be the maximum consistent with the size, strength and weight of the driven piles. The use of a follower is permitted only with the approval of the engineer of record. The introduction of fresh hammer cushion or pile cushion material just prior to final penetration is not permitted.

**1808.2.8.3 Load tests.** Where design compressive loads per pier or pile are greater than 40 tons, (30 tons for timber piles) or where drilled or jacked piles are not installed in Class 1.a, 1.b or 1.c material, or where final penetration is by a vibratory hammer, or where the design load for any pier or pile foundation is in doubt, piers or piles shall be load tested in accordance with this section. At least one pier or pile shall be test loaded in each area of uniform subsoil conditions.

**1808.2.8.3.1 Load test evaluation.** It shall be permitted to evaluate pile load tests with any of the following methods:

1. Davisson Offset Limit.
2. Brinch-Hansen 90 percent Criterion.
3. Chin-Konder Extrapolation.
4. Other methods approved by the commissioner.

**1808.2.8.3.1.1 Additional load tests.** Where required by the commissioner, additional piers or piles shall be load tested where necessary to establish the allowable capacity. The load capacity shall be determined by an engineer in accordance with 1808.2.8.3. For friction piles where the actual production pile lengths vary more than twenty five per cent from that of the test pile, the engineer shall require an investigation to determine the adequacy of the piles.



**1808.2.8.3.1.2 Load test requirements.** Before any load test is made, the proposed apparatus and structure to be used in making the load test shall be satisfactory to the commissioner. The test shall be made under the responsible engineer's surveillance. A complete record of such tests shall be filed with the commissioner. Areas of the foundation site within which the subsurface soil conditions are substantially similar in character shall be established by the engineer. For piles installed by impact hammer, one load test shall be conducted in each area of substantially similar conditions, but not less than one typical pile for the entire foundation installation of the building or group of buildings on the site occupying a total area of 5,000 square feet (465 m<sup>2</sup>) or less; and not less than two load tests for a site having a footprint between 5,000 (465 m<sup>2</sup>) and 30,000 (2787 m<sup>2</sup>) square feet and one additional load test for each 20,000 (1860 m<sup>2</sup>) square feet of added footprint area.

**1808.2.8.3.1.3 Load test procedures.** Load tests shall be conducted in accordance with ASTM D 1143 standard procedures and the following conditions:

1. Dial extensometer gages shall provide readings to the nearest 0.001 inch (0.025 mm) Electrical transducers may be used to make settlement observations provided that backup measurements are made utilizing dial extensometers as described herein at sufficient times to validate the transducer readings. The total test load shall remain in place until the rate of settlement does not exceed 0.012 inches (0.305 mm) over a time period of twelve hours. The total load shall be removed in decrements not exceeding twenty five per cent of the total load at one hour intervals or longer. In addition to observations required by ASTM D 1143, settlement observations shall be performed at one-half minute, one minute, two minute and four minute intervals after application of each load increment, and twenty four hours after the entire test load has been removed.
2. Any temporary supporting capacity that the soil might provide to the pile during a load test, but which would be dissipated with time, shall be eliminated by casing off or by other suitable means, such as increasing the total test load to account for such temporary capacity.

**1808.2.8.3.1.4 Alternative test methods.** Load test methods other than those described in Section 1808.2.8.3 may be used subject to the approval of the commissioner where three or more load tests are required. In such case, at least one alternative test shall be performed as a calibration on a static load tested pile or nearby pile driven to comparable resistance. No more than one half the required number of load tests may be performed by

alternative methods. Alternative tests shall be performed under the supervision of an engineer experienced in the methods used. The number of alternative tests shall be at least twice the number of replaced static load tests.

**1808.2.8.3.1.5 Acceptance criteria.** The allowable pile load shall be the lesser of the two values computed as follows:

1. Fifty percent of the applied load causing a net settlement of the pile of not more than one  $\frac{1}{100}$  of an inch per ton (0.25 mm per 8.9 kN) of applied load. Net settlement in this paragraph is defined as gross settlement due to the total test load minus the rebound after removing one hundred per cent of the test load.
2. Fifty percent of the applied load causing a net settlement of the pile of  $\frac{3}{4}$  of an inch (19 mm). Net settlement in this paragraph is defined as the gross settlement due to the total test load less the amount of elastic shortening in the pile section due to total test load. The elastic shortening shall be calculated as if the pile is designed as an end-bearing pile or as a friction pile. Alternatively, the net settlement may be measured directly using a telltale or other suitable instrumentation.

**1808.2.8.3.1.6 Substantiation of higher allowable loads.** The pile capacities tabulated in Table 1808.2.8.1.3 may be exceeded where a higher value can be substantiated on the basis of load tests and analysis. The provisions of paragraphs 1808.2.8.3.1.2 and 1808.2.8.3.1.3 shall be supplemented, as follows:

The final load increment shall remain in place for a total of not less than twenty-four hours; single test piles shall be subjected to cyclical loading or suitably instrumented with telltales and strain gauges so that the movements of the pile tip and butt may be independently determined and load transfer to the soil evaluated. A complete record demonstrating satisfactory performance of the test shall be submitted to the commissioner.

**1808.2.8.4 Allowable frictional resistance.** The assumed frictional resistance developed by any pier or uncased cast-in-place pile shall not exceed one-sixth of the bearing value of the soil material at minimum depth as set forth in Table 1804.1, up to a maximum of 500 psf (24 kPa), unless a greater value is allowed by the commissioner after a soil investigation as specified in Section 1802 is submitted. Frictional resistance and bearing resistance shall not be assumed to act simultaneously unless recommended by a soil investigation as specified in Section 1802.

**1808.2.8.5 Uplift capacity.** Where required by the design, the uplift capacity of a

single pier or pile shall be determined in accordance with accepted engineering practice based on a minimum factor of safety of three or by uplift load tests conducted in accordance with ASTM D 3689. The maximum allowable uplift load shall not exceed the ultimate load capacity divided by a factor of safety of two. The design uplift capacities of a pile group shall not exceed the sum of the design uplift capacities of the individual piles in the group, nor the uplift capacity calculating the group action of the pile in accordance with accepted engineering practice where the calculated ultimate group capacity is divided by a safety factor of 2.5.

**1808.2.8.6 Load-bearing capacity.** Piers, individual piles and groups of piles shall develop ultimate load capacities of at least twice the design working loads in the designated load-bearing layers. Analysis shall show that no soil layer underlying the designated load-bearing layers causes the load-bearing capacity safety factor to be less than two and that settlements of strata within the influence of the pile groups and the average area load of the supported structure are tolerable for the structure.

**1808.2.8.7 Bent piers or piles.** The load-bearing capacity of piers or piles discovered to have a sharp or sweeping bend shall be determined by an approved method of analysis in accordance with accepted engineering practice or by load testing a representative pier or pile.

**1808.2.8.8 Overloads on piers or piles.** The maximum compressive load on any pier or pile due to mislocation shall not exceed 110 percent of the allowable design load. If the total load on any pile, so determined, is in excess of one hundred ten percent of the allowable load bearing capacity, correction shall be made by installing additional piles or by other methods of load distribution as required to reduce the maximum pile load to one hundred ten percent of the capacity.

**1808.2.8.9 More than one pile type, pile capacity, or method of pile installation.** In the conditions described below, the several parts of the building supported on the different types, capacities, or modes of piling shall be separated by suitable joints providing for differential movement, or analysis shall be prepared by the engineer, establishing to the satisfaction of the commissioner that the proposed construction is adequate and safe, and showing that the probable settlements and differential settlements to be expected will be tolerable to the structure and not result in instability of the building. The load test requirements of 1808.2.8.3 shall apply separately and distinctly to each different type or capacity of piling, method of installation, or type or capacity of equipment used, except where analysis of the probable, comparative behavior of the different types or capacities of the piles or the methods of installation indicates that data on one type or capacity of pile permit a reliable extrapolation of the probable behavior of the piles of other types and capacities. The requirements of this section apply to the following proposed conditions:

1. Construction of a foundation for a building utilizing piles of more than one type or capacity; or
2. Modification of an existing foundation by the addition of piles of a type or capacity other than those of the existing piling; or
3. Construction or modification of a foundation utilizing different methods or more than one method of installation, or using different types or capacities of equipment (such as different types of hammers having markedly different striking energies or speeds); or
4. Support of part of a building on piles and part on footings.

### **1808.2.9 Lateral support.**

**1808.2.9.1 General.** Any soil other than fluid soil shall be deemed to afford sufficient lateral support to the pier or pile to prevent buckling and to permit the design of the pier or pile in accordance with accepted engineering practice and the applicable provisions of this code.

**1808.2.9.2 Unbraced piles.** Piles standing unbraced in air, water or in fluid soils shall be designed as columns in accordance with the provisions of this code. Such piles driven into firm ground can be considered fixed and laterally supported at 5 feet (1524 mm) below the ground surface and in soft material at 10 feet (3048 mm) below the ground surface unless otherwise prescribed by the engineer.

**1808.2.9.3 Allowable lateral load.** Where required by the design, the lateral load capacity of a pier, a single pile or a pile group shall be determined by an approved method of analysis in accordance with accepted engineering practice or by lateral load tests in accordance with ASTM D 3966 to at least twice the proposed design working load. The resulting allowable load shall not be more than one-half of that test load that produces a gross lateral movement of 1 inch (25mm) at the ground surface.

In the absence of specific project requirements as determined by the engineer, the resulting allowable load shall not be more than one-half of that test load that produces a gross lateral movement of 1 inch (25 mm) at the ground surface. The maximum allowable lateral load of a pile shall be 1 ton (8.9 kN), unless verified by load test. Lateral capacities for pile groups shall be modified to account for group effects in accordance with accepted engineering practice.

**1808.2.10 Allowable stresses in piles and use of higher allowable pier or pile stresses.** Allowable stresses for designing piles shall be as specified in Section 1809, 1810, and 1811. Allowable stresses greater than those specified for piers or for each pile type in Sections 1809 and 1810 are permitted where supporting data justifying such higher stresses are filed and approved by the commissioner. Such substantiating

data shall include:

1. A soils investigation in accordance with Section 1802.
2. Pier or pile load tests in accordance with Section 1808.2.8.3, regardless of the load supported by the pier or pile. The design and installation of the pier or pile foundation shall be under the direct supervision of an engineer knowledgeable in the field of soil mechanics and pier or pile foundations who shall certify to the commissioner that the piers or piles as installed satisfy the design criteria.

**1808.2.11 Piles in subsiding areas.** Where piles are driven through subsiding fills or other subsiding strata and derive support from underlying firmer materials, consideration shall be given to the downward frictional forces that may be imposed on the piles by the subsiding upper strata.

**1808.2.12 Settlement analysis.** The settlement of piers, individual piles or groups of piles shall be estimated based on approved methods of analysis. The predicted settlement shall cause neither harmful distortion of, nor instability in, the structure, nor cause any stresses to exceed allowable values.

**1808.2.13 Preexcavation.** The use of jetting, augering or other methods of preexcavation shall be subject to the approval of the commissioner. Where permitted, preexcavation shall be carried out in the same manner as used for piers or piles subject to load tests and in such a manner that will not impair the carrying capacity of the piers or piles already in place or damage adjacent structures. Pile tips shall be driven below the preexcavated depth until the required resistance or penetration is obtained.

**1808.2.14 Installation sequence.** Piles shall be installed in such sequence so as to avoid compacting the surrounding soil to the extent that other piles cannot be installed properly, and to prevent ground movements that are capable of damaging adjacent structures.

**1808.2.14.1 Protection of adjacent property.** Piles and piers shall be installed with adequate provision for the protection of adjacent buildings and property.

**1808.2.15 Use of vibratory drivers.** Vibratory drivers shall only be used to install piles where the pile is subsequently seated by an impact hammer to the final driving criteria established in accordance with Section 1808.2.8.2.

**1808.2.16 Pile driveability.** Pile cross sections shall be of sufficient size and strength to withstand driving stresses without damage to the pile, and to provide sufficient stiffness to transmit the required driving forces.

**1808.2.17 Protection of pile materials.** Where boring records or site conditions indicate possible deleterious action on pier or pile materials because of soil

constituents, changing water levels or other factors, the pier or pile materials shall be adequately protected by materials, methods or processes approved by the engineer. Protective materials shall be applied to the piles so as not to be rendered ineffective by driving. The effectiveness of such protective measures for the particular purpose shall have been thoroughly established by satisfactory service records or other evidence. The following specific provisions shall apply:

1. Untreated timber piles shall not be used unless the top level of the pile is below the permanent water table. The permanent water table level shall not be assumed higher than the invert level of sewer, drain, or subsurface structure in the adjacent streets, nor higher than the water level at the site resulting from the lowest drawdown of wells or sumps, but in no case shall untreated timber piles be used where the cut-off level is less than 10 feet (3048 mm) below the adjacent legal grade. Where treated piles are required, preservative treatment shall consist of impregnation with creosote or a creosote solution or CCA treatment. For piles entirely embedded below grade, a pentachlorophenol solution may be used. Treatment shall be in accordance with all requirements of the AWPA standards and as specified in Section 1809.1.2.
2. Piles installed in ash or garbage fills, cinder fills, and piles that are free-standing in or near a seawater environment, or that are used for the support of chemical plants, coal piles and piles under similar conditions of chemical seepage or aggressive action, or that are used for support of electrical generating plants, shall be investigated regarding the need for special protective treatment. Where special protective treatment is indicated by the engineer, such piles shall be protected against deterioration by encasement, coating, or other device acceptable to the engineer.

**1808.2.17.1 Protection of piles during installation.** Piling shall be handled and installed to the required penetration and resistance by methods that leave the piles' strength unimpaired and that develop and retain their required load bearing resistance. Any damaged pile shall be satisfactorily repaired or the pile shall be rejected. As an alternative and subject to the approval by the commissioner, damaged or misaligned piles or piles not reaching design tip elevation may be used at a reduced fraction of the design load based on an analysis by the engineer.

**1808.2.17.2 Equipment.** Equipment and methods of installation shall be such that piles are installed in their proper position and alignment, without damage. Equipment shall be maintained in good working order. The pile-driving hammer shall travel freely in the leads. The hammer shall deliver its rated energy and measurements shall be made of the fall of the ram or other suitable data shall be obtained at intervals necessary to verify the actual energy delivered during the final twenty blows of the hammer.

**1808.2.17.3 Cushion or cap block.** The cushion or cap block shall be a solid block of hardwood with its grains parallel to the axis of the pile and enclosed in a

tight-fitting steel housing, or other accepted equivalent assembly. If laminated materials are used, their type and construction shall be such that their strength is equal to or greater than hardwood. Wood chips, pieces of rope, hose, shavings, automobile tires or similar materials shall not be used. Cap block cushions shall be replaced if burned, crushed, or otherwise damaged. Other cushion materials may be used subject to the approval of the engineer.

**1808.2.17.4 Followers.** Followers shall not be used unless permitted in writing by the engineer responsible for the pile driving operation. The required driving resistance shall account for the losses of driving energy transmitted to the pile because of the follower. The follower shall be a single length section, shall be provided with a socket or hood carefully fitted to the top of the pile to minimize loss of energy and to prevent damage to the pile, and shall have sufficient rigidity to prevent “whip” during driving.

**1808.2.18 Use of existing piers or piles.** Piers or piles left in place where a structure has been demolished shall not be used for the support of new construction unless the piles are load tested, original installation and testing records are available, or the new loads are no more than half the calculated previous loads on the piles. The engineer shall determine and certify that the piers or piles are sound and meet the requirements of this code. The design load applied to such piers or piles shall be the lowest allowable load as determined by tests, redriving data or calculations.

**1808.2.19 Heaved piles.** Piles that have heaved during the driving of adjacent piles shall be redriven as necessary to develop the required capacity and penetration, or the capacity of the pile shall be verified by load tests in accordance with Section 1808.2.8.3.

**1808.2.20 Identification.** All pier or pile materials shipped or delivered to the job site shall be identified for conformity to the specified grade and this identification shall be maintained continuously from the point of manufacture to the point of installation. Such shipment or delivery shall be accompanied by a certification from the material supplier or manufacturer indicating conformance with the construction documents. Such certification shall be made available to the engineer of record and the department. In the absence of adequate data, pier or pile materials shall be tested by an approved agency to determine conformity to the specified grade. The approved agency shall furnish a certification of compliance to the engineer of record, or upon request to the commissioner.

**1808.2.21 Pier or pile location plan.** A plan showing the location and designation of piers or piles by an identification system shall be filed with the commissioner prior to installation of such piers or piles. Detailed records for piers or individual piles shall bear an identification corresponding to that shown on the plan.

**1808.2.21.1 Tolerance in alignment of the pile axis.** If the axis of any pile is installed out of plumb or deviates from the specified batter by more than four percent of the pile length, the design of the foundation shall be modified to resist

the resulting vertical and lateral forces. In types of piles for which subsurface inspection is not possible, this determination shall be made on the exposed section of the pile, which section, at the time of checking axial alignment, shall not be less than 2 feet (610 mm) in length. In piles that can be checked for axial alignment below the ground surface, the sweep of the pile axis shall not exceed four percent of the embedded length.

**1808.2.21.2 Tolerance in the location of the head of the pile.** A tolerance of 3 inches (76 mm) from the designed location shall be permitted in the installation of each pile, without reduction in load capacity of the pile group. Where piles are installed out of position in excess of this amount, the true loading on such piles shall be analytically determined from a survey that defines the actual location of the piles as driven, and using the actual eccentricity in the pile group with respect to the line of action of the applied load.

**1808.2.22 Special inspection.** Special inspections in accordance with Sections 1704.8 and 1704.9 shall be provided for piles and piers, respectively.

**1808.2.23 Seismic design of piers or piles.** Seismic design of piers and piles shall be done in accordance with Section 1808.2.23.1 through 1808.2.23.2.

**1808.2.23.1 Seismic design category C.** Where a structure is assigned to Seismic Design Category C in accordance with Section 1616, individual pile caps, piers or piles shall be interconnected by ties. Ties shall be capable of carrying, in tension and compression, a force equal to the product of the larger pile cap or column load times the seismic coefficient,  $S_{DS}$ , divided by 10 unless it can be demonstrated that equivalent restraint is provided by reinforced concrete beams within slabs on grade or reinforced concrete slabs on grade or confinement by competent rock, hard cohesive soils or very dense granular soils.

**Exception:** Piers supporting foundation walls, isolated interior posts detailed so the pier is not subject to lateral loads, and lightly loaded exterior decks and patios of Group R-3 and U occupancies not exceeding two stories of light-frame construction, are not subject to interconnection if it can be shown that the soils are of adequate stiffness, subject to the approval of the commissioner.

**1808.2.23.1.1 Connection to pile cap.** Concrete piles and concrete-filled steel pipe piles shall be connected to the pile cap by embedding the pile reinforcement or field-placed dowels anchored in the concrete pile and the pile cap for a distance equal to the development length. For deformed bars, the development length is the full development length for compression or tension, in the case of uplift, without reduction in length for excess area. Alternative measures for laterally confining concrete and maintaining toughness and ductile-like behavior at the top of the pile are permitted provided the design is such that any hinging occurs in the confined region.



Ends of hoops, spirals and ties shall be terminated with seismic hooks, as defined in Section 21.1 of ACI 318, turned into the confined concrete core. The minimum transverse steel ratio for confinement shall not be less than one-half of that required for columns.

For resistance to uplift forces, anchorage of steel pipe (round HSS sections), concrete-filled steel pipe or H-piles to the pile cap shall be made by means other than concrete bond to the bare steel section.

**Exception:** Anchorage of concrete-filled steel pipe piles is permitted to be accomplished using deformed bars developed into the concrete portion of the pile.

Splices of pile segments shall develop the full strength of the pile, but the splice need not develop the nominal strength of the pile in tension, shear and bending when it has been designed to resist axial and shear forces and moments from the load combinations of Section 1605.4.

**1808.2.23.1.2 Design details.** Pier or pile moments, shears and lateral deflections used for design shall be established considering the nonlinear interaction of the shaft and soil, as recommended by the engineer. Where the ratio of the depth of embedment of the pile-to-pile diameter or width is less than or equal to six, the pile may be assumed to be rigid.

Pile group effects from soil on lateral pile nominal strength shall be included where pile center-to-center spacing in the direction of lateral force is less than eight pile diameters. Pile group effects on vertical nominal strength shall be included where pile center-to-center spacing is less than three pile diameters. The pile uplift soil nominal strength shall be taken as the pile uplift strength as limited by the frictional force developed between the soil and the pile.

Where a minimum length for reinforcement or the extent of closely spaced confinement reinforcement is specified at the top of the pier or pile, provisions shall be made so that those specified lengths or extents are maintained after pier or pile cutoff.

**1808.2.23.2 Seismic design category D.** Where a structure is assigned to Seismic Design Category D in accordance with Section 1616, the requirements for Seismic Design Category C given in Section 1808.2.23.1 shall be met. Provisions of ACI 318, Section 21.10.4, shall also apply when not in conflict with the provisions of Sections 1808 through 1812. Concrete shall have a specified compressive strength of not less than 3,000 psi (20.68 MPa) at 28 days.

**Exceptions:**

1. Group R or U occupancies of light-framed construction and two stories or less in height are permitted to use concrete with a specified compressive strength of not less than 2,500 psi (17.2 MPa) at 28 days.
2. Detached one- and two-family dwellings of light-frame construction and two stories or less in height are not required to comply with the provisions of ACI 318, Section 21.10.4.
3. Section 21.10.4.4(a) of ACI 318 shall not apply to concrete piles.

**1808.2.23.2.1 Design details for piers, piles and grade beams.** Piers or piles shall be designed and constructed to withstand maximum imposed curvatures from earthquake ground motions and structure response. Curvatures shall include free-field soil strains modified for soil-pile-structure interaction coupled with pier or pile deformations induced by lateral pier or pile resistance to structure seismic forces. Concrete piers or piles on Site Class E or F sites, as determined in Section 1615.1.1, shall be designed and detailed in accordance with Sections 21.4.4.1, 21.4.4.2 and 21.4.4.3 of ACI 318 within seven pile diameters of the pile cap and the interfaces of soft to medium stiff clay or liquefiable strata. For precast prestressed concrete piles, detailing provisions as given in Sections 1809.2.3.2.1 and 1809.2.3.2.2 shall apply.

Grade beams shall be designed as beams in accordance with ACI 318, Chapter 21. When grade beams have the capacity to resist the forces from the load combinations in Section 1605.4, they need not conform to ACI 318, Chapter 21.

**1808.2.23.2.2 Connection to pile cap.** For piles required to resist uplift forces or provide rotational restraint, design of anchorage of piles into the pile cap shall be provided considering the combined effect of axial forces due to uplift and bending moments due to fixity to the pile cap. Anchorage shall develop a minimum of 25 percent of the strength of the pile in tension. Anchorage into the pile cap shall be capable of developing the following:

1. In the case of uplift, the lesser of the nominal tensile strength of the longitudinal reinforcement in a concrete pile, or the nominal tensile strength of a steel pile, or the pile uplift soil nominal strength factored by 1.3 or the axial tension force resulting from the load combinations of Section 1605.4.
2. In the case of rotational restraint, the lesser of the axial and shear forces, and moments resulting from the load combinations of Section 1605.4 or development of the full axial, bending and shear nominal strength of the pile.

**1808.2.23.2.3 Flexural strength.** Where the vertical, lateral-force-resisting elements are columns, the grade beam or pile cap flexural strengths shall

exceed the column flexural strength.

The connection between batter piles and grade beams or pile caps shall be designed to resist the nominal strength of the pile acting as a short column. Batter piles and their connections shall be capable of resisting forces and moments from the load combinations of Section 1605.4.

## **SECTION BC 1809** **DRIVEN PILE FOUNDATIONS**

**1809.1 Timber piles.** Timber piles shall be designed in accordance with the AF & PA NDS.

**1809.1.1 Materials.** Round timber piles shall conform to ASTM D 25. Sawn timber piles shall conform to DOC PS-20.

**1809.1.2 Preservative treatment.** Timber piles used to support permanent structures shall be treated in accordance with this section unless it is established that the tops of the untreated timber piles will be below the lowest ground-water level assumed to exist during the life of the structure as specified in Section 1808.2.17. Preservative and minimum final retention shall be in accordance with AWWA C3 for round timber piles and AWWA C24 for sawn timber piles. Preservative-treated timber piles shall be subject to a quality control program administered by an approved agency. Pile cutoffs shall be treated in accordance with AWWA M4.

**1809.1.3 End-supported piles.** Any sudden decrease in driving resistance of an end-supported timber pile shall be investigated with regard to the possibility of damage. If the sudden decrease in driving resistance cannot be correlated to load-bearing data, the pile shall be removed for inspection or rejected.

**1809.1.4 Sizes of piles.** Piles shall be of adequate size to resist the applied loads without creating stresses in the pile material in excess of twelve hundred psi (8.27 MPa) for piles of southern pine, Douglas fir, oak, or other wood of comparable strength; or eight hundred psi (5.52 MPa) for piles of cedar, Norway pine, spruce or other wood of comparable strength. Piles of twenty-five tons (222.5 kN) capacity or more shall have a minimum 8-inch tip (203 mm) with uniform taper. Piles of less than 25 tons (222.5 kN) capacity shall have a minimum 6-inch (152 mm) tip with uniform taper. All piles, regardless of capacity, driven to end bearing on bedrock of classes 1a to 1d and compact gravels and sands of class 2a shall have a minimum 8-inch (203 mm) tip and a uniform taper. Any species of wood may be used that conforms to ASTM D 25 and that will stand the driving stresses.

**1809.1.5 Lagged or inverted piles.** The use of lagged or inverted piles is permitted. Double lagging shall be adequately connected to the basic pile material to transfer the full pile load from the basic pile material to the lagging without exceeding values of allowable stress as established in Chapter 23. The connection for single lagging shall be proportioned for half the pile load. The diameter of any inverted pile at any section

shall be adequate to resist the applied load without exceeding the stresses specified in Section 1809.1.4, but in no case shall it be less than 8 inches (203 mm).

## **1809.2 Precast concrete piles.**

**1809.2.1 General.** The materials, reinforcement and installation of precast concrete piles shall conform to Sections 1809.2.1.1 through 1809.2.1.4.

**1809.2.1.1 Design and manufacture.** Piles shall be designed and manufactured in accordance with accepted engineering practice to resist all stresses induced by handling, driving and service loads.

**1809.2.1.2 Minimum dimension.** The minimum lateral dimension shall be 8 inches (203 mm). Corners of square piles shall be chamfered.

**1809.2.1.3 Reinforcement.** Longitudinal steel shall be arranged in a symmetrical pattern and be laterally tied with steel ties or wire spiral spaced not more than 4 inches (102 mm) apart, center to center, for a distance of 2 feet (610 mm) from the ends of the pile; and not more than 6 inches (152 mm) elsewhere except that at the ends of each pile, the first five ties or spirals shall be spaced 1 inch (25mm) center to center. The gage of ties and spirals shall be as follows:

1. For piles having a diameter of 16 inches (406 mm) or less, wire shall not be smaller than 0.22 inch (5.6 mm) (No. 5 gage).
2. For piles having a diameter of more than 16 inches (406 mm) and less than 20 inches (508 mm), wire shall not be smaller than 0.238 inch (6 mm) (No. 4 gage).
3. For piles having a diameter of 20 inches (508 mm) and larger, wire shall not be smaller than ¼ inch (6.4 mm) round or 0.259 inch (6.6 mm) (No. 3 gage).

**1809.2.1.4 Installation.** Piles shall be handled and driven so as not to cause injury or overstressing in a manner that affects durability or strength.

**1809.2.2 Precast nonprestressed piles.** Precast nonprestressed concrete piles shall conform to Sections 1809.2.2.1 through 1809.2.2.5.

**1809.2.2.1 Materials.** Concrete shall have a 28-day specified compressive strength ( $f'_c$ ) of not less than 3,000 psi (20.68 MPa).

**1809.2.2.2 Minimum reinforcement.** The minimum amount of longitudinal reinforcement shall be 0.8 percent of the concrete section and shall consist of at least four bars.

**1809.2.2.2.1 Seismic reinforcement in seismic design category C.** Where a

structure is assigned to Seismic Design Category C in accordance with Section 1616, longitudinal reinforcement with a minimum steel ratio of 0.01 shall be provided throughout the length of precast concrete piles. Within three pile diameters of the bottom of the pile cap, the longitudinal reinforcement shall be confined with closed ties or spirals of a minimum  $\frac{3}{8}$ -inch (9.5 mm) diameter. Ties or spirals shall be provided at a maximum spacing of eight times the diameter of the smallest longitudinal bar, not to exceed 6 inches (152 mm). Throughout the remainder of the pile, the closed ties or spirals shall have a maximum spacing of 16 times the smallest longitudinal-bar diameter, not to exceed 8 inches (203 mm).

**1809.2.2.2.2 Seismic reinforcement in seismic design category D.** Where a structure is assigned to Seismic Design Category D in accordance with Section 1616, the requirements for Seismic Design Category C in Section 1809.2.2.2.1 shall apply except as modified by this section. Transverse confinement reinforcement consisting of closed ties or equivalent spirals shall be provided in accordance with Sections 21.4.4.1, 21.4.4.2 and 21.4.4.3 of ACI 318 within three pile diameters of the bottom of the pile cap. For other than Site Class E or F, or liquefiable sites and where spirals are used as the transverse reinforcement, it shall be permitted to use a volumetric ratio of spiral reinforcement of not less than one-half that required by Section 21.4.4.1(a) of ACI 318.

**1809.2.2.3 Allowable stresses.** The allowable compressive stress in the concrete shall not exceed 33 percent of the 28-day specified compressive strength ( $f'_c$ ) applied to the gross cross-sectional area of the pile. The allowable compressive stress in the reinforcing steel shall not exceed 40 percent of the yield strength of the steel ( $f_y$ ) or a maximum of 30,000 psi (207 MPa). The allowable tensile stress in the reinforcing steel shall not exceed 50 percent of the yield strength of the steel ( $f_y$ ) or a maximum of 24,000 psi (165 MPa).

**1809.2.2.4 Installation.** A precast concrete pile shall not be driven before the concrete has attained a compressive strength of at least 75 percent of the 28-day specified compressive strength ( $f'_c$ ), but not less than the strength sufficient to withstand handling and driving forces.

**1809.2.2.5 Concrete cover.** Reinforcement for piles that are not manufactured under plant conditions shall have a concrete cover of not less than 2 inches (51 mm). Reinforcement for piles manufactured under plant control conditions shall have a concrete cover of not less than 1  $\frac{1}{4}$  inches (32 mm) for No. 5 bars and smaller, and not less than 1  $\frac{1}{2}$  inches (38mm) for No. 6 through No. 11 bars except that longitudinal bars spaced less than 1  $\frac{1}{2}$  inches (38 mm) clear distance apart shall be considered bundled bars for which the minimum concrete cover shall be equal to that for the equivalent diameter of the bundled bars. Reinforcement for piles exposed to seawater shall have a concrete cover of not less than 3 inches (76 mm).

**1809.2.3 Precast prestressed piles.** Precast prestressed concrete piles shall conform to the requirements of Sections 1809.2.3.1 through 1809.2.3.5.

**1809.2.3.1 Materials.** Prestressing steel shall conform to ASTM A 416. Concrete shall have a 28-day specified compressive strength ( $f'_c$ ) of not less than 5,000 psi (34.48 MPa).

**1809.2.3.2 Design.** Precast prestressed piles shall be designed to resist stresses induced by handling and driving as well as by loads. The effective prestress in the pile shall not be less than 400 psi (2.76MPa) for piles up to 30 feet (9144 mm) in length, 550 psi (3.79MPa) for piles up to 50 feet (15 240 mm) in length and 700 psi (4.83 MPa) for piles greater than 50 feet (15 240 mm) in length. Effective prestress shall be based on an assumed loss of 30,000 psi (207 MPa) in the prestressing steel. The tensile stress in the prestressing steel shall not exceed the values specified in ACI 318.

**1809.2.3.2.1 Design in seismic design category C.** Where a structure is assigned to Seismic Design Category C in accordance with Section 1616, the minimum volumetric ratio of spiral reinforcement shall not be less than 0.007 or the amount required by the following formula for the upper 20 feet (6096 mm) of the pile.

**(Equation 18-4 attached to end of document)**

At least one-half the volumetric ratio required by Equation 18-4 shall be provided below the upper 20 feet (6096 mm) of the pile.

The pile cap connection by means of dowels as indicated in Section 1808.2.23.1 is permitted. Pile cap connection by means of developing pile reinforcing strand is permitted provided that the pile reinforcing strand results in a ductile connection.

**1809.2.3.2.2 Design in seismic design category D.** Where a structure is assigned to Seismic Design Category D in accordance with Section 1616, the requirements for Seismic Design Category C in Section 1809.2.3.2.1 shall be met, in addition to the following:

1. Requirements in ACI 318, Chapter 21, do not apply, unless specifically referenced.
2. Where the total pile length in the soil is 35 feet (10 668 mm) or less, the lateral transverse reinforcement in the ductile region shall occur through the length of the pile. Where the pile length exceeds 35 feet (10 668 mm), the ductile pile region shall be taken as the greater of 35 feet (10 668 mm) or the distance from the underside of the pile cap to the point of zero curvature plus three times the least pile dimension.

3. In the ductile region, the center-to-center spacing of the spirals or hoop reinforcement shall not exceed one-fifth of the least pile dimension, six times the diameter of the longitudinal strand, or 8 inches (203 mm), whichever is smaller.
4. Circular spiral reinforcement shall be spliced by lapping one full turn and bending the end of the spiral to a 90-degree hook or by use of a mechanical or welded splice complying with Sec. 12.14.3 of ACI 318.
5. Where the transverse reinforcement consists of circular spirals, the volumetric ratio of spiral transverse reinforcement in the ductile region shall comply with the following:

**(Equation 18-5 attached to end of document)**

**(Equation 18-6 attached to end of document)**

**(Equation 18-7 attached to end of document)**

6. When transverse reinforcement consists of rectangular hoops and cross ties, the total cross-sectional area of lateral transverse reinforcement in the ductile region with spacings, and perpendicular to dimension,  $h_c$ , shall conform to:

**(Equation 18-8 attached to end of document)**

**(Equation 18-9 attached to end of document)**

The hoops and cross ties shall be equivalent to deformed bars not less than No. 3 in size. Rectangular hoop ends shall terminate at a corner with seismic hooks.

Outside of the length of the pile requiring transverse confinement reinforcing, the spiral or hoop reinforcing with a volumetric ratio not less than one-half of that required for transverse confinement reinforcing shall be provided.

**1809.2.3.3 Allowable stresses.** The maximum allowable design compressive stress,  $f_c$ , in concrete shall be determined as follows:

**(Equation 18-10 attached to end of document)**

**1809.2.3.4 Installation.** A prestressed pile shall not be driven before the concrete has attained a compressive strength of at least 75 percent of the 28-day specified compressive strength ( $f'_c$ ), but not less than the strength sufficient to withstand handling and driving forces.

**1809.2.3.5 Concrete cover.** Prestressing steel and pile reinforcement shall have a concrete cover of not less than 1 ¼ inches (32 mm) for square piles of 12 inches (305 mm) or smaller size and 1 ½ inches (38 mm) for larger piles, except that for piles exposed to seawater, the minimum protective concrete cover shall not be less than 2 ½ inches (64 mm).

**1809.3 Structural steel piles.** Structural steel piles shall conform to the requirements of Sections 1809.3.1 through 1809.3.4.

**1809.3.1 Materials.** Structural steel piles, steel pipe and fully welded steel piles fabricated from plates shall conform to ASTM A36, ASTM A252, ASTM A283, ASTM A572, ASTM A 588 or ASTM A 913.

**1809.3.2 Allowable stresses.** The allowable axial stresses shall not exceed 35 percent of the minimum specified yield strength ( $F_y$ ).

**Exception:** Where justified in accordance with Section 1808.2.10.1, the allowable axial stress is permitted to be increased above  $0.35F_y$ , but shall not exceed  $0.5F_y$ .

**1809.3.3 Dimensions of H-piles.** Sections of H-piles shall comply with the following:

- 1.** The flange projections shall not exceed 14 times the minimum thickness of metal in either the flange or the web and the flange widths shall not be less than 80 percent of the depth of the section.
- 2.** The nominal depth in the direction of the web shall not be less than 8 inches (203 mm).
- 3.** Flanges and web shall have a minimum nominal thickness of ⅜ inch (9.5 mm).

**1809.3.4 Dimensions of steel pipe piles.** Steel pipe piles driven open ended shall have a nominal outside diameter of not less than 8 inches (203 mm). The pipe shall have a minimum of 0.34 square inch (219 mm<sup>2</sup>) of steel in cross section to resist each 1,000 foot-pounds (1356 N×m) of pile hammer energy or the equivalent strength for steels having a yield strength greater than 35,000 psi (241 MPa). Where pipe wall thickness less than 0.188 inch (4.8 mm) is driven open ended, a suitable cutting shoe shall be provided.

## **SECTION 1810** **CAST-IN-PLACE CONCRETE PILE FOUNDATIONS**

**1810.1 General.** The materials, reinforcement and installation of cast-in-place concrete piles shall conform to Sections 1810.1.1 through 1810.1.3.



**1810.1.1 Materials.** Concrete shall have a 28-day specified compressive strength ( $f'_c$ ) of not less than 2,500 psi (17.24 MPa). Where concrete is placed through a funnel hopper at the top of the pile, the concrete mix shall be designed and proportioned so as to produce a cohesive workable mix having a slump of not less than 4 inches (102 mm) and not more than 6 inches (152 mm). Where concrete is to be pumped, the mix design including slump shall be adjusted to produce a pumpable concrete.

**1810.1.2 Reinforcement.** Except for steel dowels embedded 5 feet (1524 mm) or less in the pile, reinforcement where required shall be placed in accordance with Section 1810.3.4 and shall be assembled and tied together and placed in the pile as a unit before the reinforced portion of the pile is filled with concrete except in augered uncased cast-in-place piles. Tied reinforcement in augered uncased cast-in-place piles shall be placed after piles are filled, while the grout is still in a semifluid state.

**1810.1.2.1 Reinforcement in seismic design category C.** Where a structure is assigned to Seismic Design Category C in accordance with Section 1616, a minimum longitudinal reinforcement ratio of 0.0025 shall be provided for uncased cast-in-place concrete drilled or augered piles, piers or caissons in the top one-third of the pile length, a minimum length of 10 feet (3048 mm) below the ground or that required by analysis, whichever length is greatest. The minimum reinforcement ratio, but no less than that ratio required by rational analysis, shall be continued throughout the flexural length of the pile. There shall be a minimum of four longitudinal bars with closed ties (or equivalent spirals) of a minimum  $\frac{3}{8}$ -inch (9 mm) diameter provided at 16-longitudinal-bar diameter maximum spacing. Transverse confinement reinforcing with a maximum spacing of the lesser of 6 inches (152 mm) or 8-longitudinal-bar diameters shall be provided within a distance equal to three times the least pile dimension of the bottom of the pile cap.

**1810.1.2.2 Reinforcement in seismic design category D.** Where a structure is assigned to Seismic Design Category D in accordance with Section 1616, the requirements for Seismic Design Category C given above shall be met. In addition, a minimum longitudinal reinforcement ratio of 0.005 shall be provided for uncased cast-in-place drilled or augered concrete piles, piers or caissons in the top one-half of the pile length, a minimum length of 10 feet (3048 mm) below ground or throughout the flexural length of the pile, whichever length is greatest. The flexural length shall be taken as the length of the pile to a point where the concrete section cracking moment strength multiplied by 0.4 exceeds the required moment strength at that point. There shall be a minimum of four longitudinal bars with transverse confinement reinforcing provided in the pile in accordance with Sections 21.4.4.1, 21.4.4.2 and 21.4.4.3 of ACI 318 within three times the least pile dimension of the bottom of the pile cap. Use of a transverse spiral reinforcing ratio of not less than one-half of that required in Section 21.4.4.1(a) of ACI 318 for other than Class E, F or liquefiable sites is allowed. Tie spacing throughout the remainder of the concrete section shall not exceed 12-longitudinal-bar diameters,

one-half the least dimension of the section, nor 12 inches (305 mm). Ties shall be a minimum of No. 3 bars for piles with a least dimension up to 20 inches (508 mm), and No. 4 bars for larger piles.

**1810.1.3 Concrete placement.** Concrete shall be placed in such a manner as to ensure the exclusion of any foreign matter and to secure a full-sized shaft. Concrete shall not be placed through water except where a tremie or other approved method is used. When depositing concrete from the top of the pile, the concrete shall not be chuted directly into the pile but shall be poured in a rapid and continuous operation through a funnel hopper centered at the top of the pile. Grout for auger cast pile shall be pumped through a hollow stem auger and shall be maintained throughout placement.

**1810.2 Enlarged base piles.** Enlarged base piles shall conform to the requirements of Sections 1810.2.1 through 1810.2.5.

**1810.2.1 Materials.** The maximum size for coarse aggregate for concrete shall be  $\frac{3}{4}$  inch (19.1 mm). Concrete to be compacted shall have a zero slump.

**1810.2.2 Allowable stresses.** The maximum allowable design compressive stress for concrete not placed in a permanent steel casing shall be 25 percent of the 28-day specified compressive strength ( $f'_c$ ). Where the concrete is placed in a permanent steel casing, the maximum allowable concrete stress shall be 33 percent of the 28-day specified compressive strength ( $f'_c$ ).

**1810.2.3 Installation.** Enlarged bases formed either by compacting concrete or driving a precast base shall be formed in or driven into granular soils. Piles shall be constructed in the same manner as successful prototype test piles driven for the project. Pile shafts extending through peat or other organic soil shall be encased in a permanent steel casing. Where a cased shaft is used, the shaft shall be adequately reinforced to resist column action or the annular space around the pile shaft shall be filled sufficiently to re-establish lateral support by the soil. Where pile heave occurs, the pile shall be replaced unless it is demonstrated that the pile is undamaged and capable of carrying twice its design load.

**1810.2.4 Load-bearing capacity.** Pile load-bearing capacity shall be verified by load tests in accordance with Section 1808.2.8.3.

**1810.2.5 Concrete cover.** The minimum concrete cover shall be 2  $\frac{1}{2}$  inches (64 mm) for uncased shafts and 1 inch (25 mm) for cased shafts.

**1810.3 Drilled or augered uncased piles.** Drilled or augered uncased piles shall conform to Sections 1810.3.1 through 1810.3.5.

**1810.3.1 Allowable stresses.** The allowable design stress in the concrete of drilled uncased piles shall not exceed 33 percent of the 28-day specified compressive strength ( $f'_c$ ). The allowable design stress in the concrete of augered cast-in-place

piles shall not exceed 25 percent of the 28-day specified compressive strength ( $f'_c$ ). The allowable compressive stress of reinforcement shall not exceed 34 percent of the yield strength of the steel or 25,500 psi (175.8 Mpa).

**1810.3.2 Dimensions.** The minimum diameter of drilled or augered uncased piles shall be 12 inches (305 mm).

**1810.3.3 Installation.** Where pile shafts are formed through unstable soils and concrete is placed in an open-drilled hole, a steel liner shall be inserted in the hole prior to placing the concrete. Where the steel liner is withdrawn during concreting, the level of concrete shall be maintained above the bottom of the liner at a sufficient height to offset any hydrostatic or lateral soil pressure. Where grout is placed by pumping through a hollow-stem auger, the auger shall be permitted to rotate in a clockwise direction during withdrawal. An initial head of grout shall be established and maintained on the auger flights before withdrawal. The auger shall be withdrawn in a continuous manner in increments of about 12 inches (305 mm) each. Grout pumping pressures shall be measured and maintained high enough at all times to offset hydrostatic and lateral earth pressures. Grout volumes shall be measured to ensure that the volume of grout placed in each pile is equal to or greater than the theoretical volume of the hole created by the auger. Where the installation process of any pile is interrupted or a loss of grout pressure occurs, the pile shall be re-drilled to 5 feet (1524 mm) below the elevation of the tip of the auger when the installation was interrupted or grout pressure was lost and reformed. Augered cast-in-place piles shall not be installed within six pile diameters center to center of a pile filled with concrete or grout less than 12 hours old, unless approved by the engineer. The level at which return of the grout occurs during withdrawal shall be recorded. If the grout level in any completed pile drops during installation of an adjacent pile, the pile shall be replaced. The installation shall be performed under the direct supervision of the engineer. The engineer shall certify to the commissioner that the piles were installed in compliance with the approved construction documents.

**1810.3.4 Reinforcement.** For piles installed with a hollow-stem auger, where full-length longitudinal steel reinforcement is placed without lateral ties, the reinforcement shall be placed through ducts in the auger prior to filling the pile with concrete. All pile reinforcement shall have a concrete cover of not less than 2 ½ inches (64 mm).

**Exception:** Where physical constraints do not allow the placement of the longitudinal reinforcement prior to filling the pile with concrete or where partial-length longitudinal reinforcement is placed without lateral ties, the reinforcement is allowed to be placed after the piles are completely concreted but while concrete is still in a semifluid state.

**1810.3.5 Reinforcement in seismic design category C or D.** Where a structure is assigned to Seismic Design Category C or D in accordance with Section 1616, the corresponding requirements of Sections 1810.1.2.1 and 1810.1.2.2 shall be met.

**1810.4 Driven uncased piles.** Driven uncased piles shall conform to Sections 1810.4.1 through 1810.4.4.

**1810.4.1 Allowable stresses.** The allowable design stress in the concrete shall not exceed 25 percent of the 28-day specified compressive strength ( $f'_c$ ) applied to a cross-sectional area not greater than the inside area of the drive casing or mandrel.

**1810.4.2 Dimensions.** The minimum diameter of the driven uncased pile shall be 12 inches (305 mm).

**1810.4.3 Installation.** Piles shall not be driven within six pile diameters center to center in granular soils or within one-half the pile length in cohesive soils of a pile filled with concrete less than 48 hours old unless approved by the commissioner. If the concrete surface in any completed pile rises or drops, the pile shall be replaced. Piles shall not be installed in soils that could cause pile heave. The installation shall be performed under the direct supervision of the engineer, who shall certify to the commissioner that the piles were installed in compliance with the approved design

**1810.4.4 Concrete cover.** Pile reinforcement shall have a concrete cover of not less than 2 ½ inches (64 mm), measured from the inside face of the drive casing or mandrel.

**1810.5 Steel-cased piles.** Steel-cased piles shall comply with the requirements of Sections 1810.5.1 through 1810.5.4.

**1810.5.1 Materials.** Pile shells or casings shall be of steel and shall be sufficiently strong to resist collapse and sufficiently water tight to exclude any foreign materials during the placing of concrete. Steel shells shall have a sealed tip with a diameter of not less than 8 inches (203 mm).

**1810.5.2 Allowable stresses.** The allowable design compressive stress in the concrete shall not exceed 33 percent of the 28-day specified compressive strength ( $f'_c$ ). The allowable concrete compressive stress shall be 0.40 ( $f'_c$ ) for that portion of the pile meeting the conditions specified in Sections 1810.5.2.1 through 1810.5.2.4.

**1810.5.2.1 Shell thickness.** The thickness of the steel shell shall not be less than manufacturer's standard gage No. 14 gage (0.068 inch) (1.75 mm) minimum.

**1810.5.2.2 Shell type.** The shell shall be seamless or provided with seams of strength equal to the basic material and be of a configuration that will provide confinement to the cast-in-place concrete.

**1810.5.2.3 Strength.** The ratio of steel yield strength ( $f_y$ ) to 28-day specified compressive strength ( $f'_c$ ) shall not be less than six.

**1810.5.2.4 Diameter.** The nominal pile diameter shall not be greater than 16 inches (406 mm).

**1810.5.3 Installation.** Steel shells shall be mandrel driven their full length in contact with the surrounding soil. The steel shells shall be driven in such order and with such pacing as to ensure against distortion of or injury to piles already in place. A pile shall not be driven within four and one-half average pile diameters of a pile filled with concrete less than 24 hours old unless approved by the commissioner. Concrete shall not be placed in steel shells within heave range of driving.

**1810.5.4 Reinforcement.** Reinforcement shall not be placed within 1 inch (25 mm) of the steel shell. Reinforcing shall be required for unsupported pile lengths or where the pile is designed to resist uplift or unbalanced lateral loads.

**1810.5.4.1 Seismic reinforcement.** Where a structure is assigned to Seismic Design Category C or D in accordance with Section 1616, the reinforcement requirements for drilled or augered uncased piles in Section 1810.3.5 shall be met.

**Exception:** A spiral-welded metal casing of a thickness not less than manufacturer's standard gage No. 14 (0.068 inch) is permitted to provide concrete confinement in lieu of the closed ties or equivalent spirals required in an uncased concrete pile. Where used as such, the metal casing shall be protected against possible deleterious action due to soil constituents, changing water levels or other factors indicated by boring records of site conditions.

**1810.6 Concrete-filled steel pipe and tube piles.** Concrete-filled steel pipe and tube piles shall conform to the requirements of Sections 1810.6.1 through 1810.6.5.

**1810.6.1 Materials.** Steel pipe and tube sections used for piles shall conform to ASTM A 252 or ASTM A 283. Concrete shall conform to Section 1810.1.1. The maximum coarse aggregate size shall be ¾ inch (19.1 mm).

**1810.6.2 Allowable stresses.** The allowable design compressive stress in the concrete shall not exceed 33 percent of the 28-day specified compressive strength ( $f'_c$ ). The allowable design compressive stress in the steel shall not exceed 35 percent of the minimum specified yield strength of the steel ( $F_y$ ), provided  $F_y$  shall not be assumed greater than 36,000 psi (248 MPa) for computational purposes.

**Exception:** Where justified in accordance with Section 1808.2.10, the allowable stresses are permitted to be increased to  $0.50 F_y$ .

**1810.6.3 Minimum dimensions.** Piles shall have a nominal outside diameter of not less than 8 inches (203 mm) and a minimum wall thickness in accordance with Section 1809.3.4. For mandrel-driven pipe piles, the minimum wall thickness shall be ¼/10 inch (2.5 mm).

**1810.6.4 Reinforcement.** Reinforcement steel shall conform to Section 1810.1.2.

Reinforcement shall not be placed within 1 inch (25 mm) of the steel casing.

**1810.6.4.1 Seismic reinforcement.** Where a structure is assigned to Seismic Design Category C or D in accordance with Section 1616, minimum reinforcement no less than 0.01 times the cross-sectional area of the pile concrete shall be provided in the top of the pile with a length equal to two times the required cap embedment anchorage into the pile cap, but not less than the tension development length of the reinforcement. The wall thickness of the steel pipe shall not be less than  $\frac{3}{16}$  inch (5 mm).

**1810.6.5 Placing concrete.** The placement of concrete shall conform to Section 1810.1.3.

**1810.7 Caisson piles.** Caisson piles shall conform to the requirements of Sections 1810.7.1 through 1810.7.9.

**1810.7.1 Construction.** Caisson piles shall consist of a shaft section of concrete-filled pipe extending to bedrock with an uncased socket drilled into the bedrock and filled with concrete. The caisson pile shall have a full-length structural steel core or a stub core installed in the rock socket and extending into the pipe portion a distance equal to the socket depth.

**1810.7.2 Materials.** Pipe and steel cores shall conform to the material requirements in Section 1809.3. Pipes shall have a minimum wall thickness of  $\frac{3}{8}$  inch (9.5 mm) and shall be fitted with a suitable steel-driving shoe welded to the bottom of the pipe. Concrete shall have a 28-day specified compressive strength ( $f'_c$ ) of not less than 4,000 psi (27.58 MPa). The concrete mix shall be designed and proportioned so as to produce a cohesive workable mix with a slump of 4 inches to 6 inches (102 mm to 152 mm).

**1810.7.3 Design.** The depth of the rock socket shall be sufficient to develop the full load-bearing capacity of the caisson pile with a minimum safety factor of two, but the depth of the socket in class 1c rock or better below the shoe shall not be less than 3 feet of the outside diameter of the pipe. The minimum outside diameter of the caisson pile shall be 7 inches (194 mm), and the diameter of the rock socket shall be approximately equal to the inside diameter of the pile.

**1810.7.4 Structural core.** The gross cross-sectional area of the structural steel core shall not exceed 30 percent of the gross area of the caisson. The minimum clearance between the structural core and the pipe shall be 2 inches (51 mm). Where cores are to be spliced, the ends shall be milled or ground to provide full contact and shall be full-depth welded.

**1810.7.5 Allowable stresses.** The allowable design compressive stresses shall not exceed the following: concrete,  $0.33 f'_c$ ; steel pipe,  $0.35F_y$  and structural steel core,  $0.50F_y$ .

**1810.7.6 Installation.** The rock socket and pile shall be thoroughly cleaned of foreign materials before filling with concrete. Steel cores shall be set 1 inch above the base of the rock socket. Concrete shall not be placed through water except where a tremie or other method approved by the commissioner is used.

**1810.7.7 Dimensions of caisson piles.** Caisson piles shall consist of concrete pipe piles that are socketed into rock and constructed with steel reinforcement, and in which the socket is observed before the concrete is poured. Steel reinforcement shall be covered with at least 1½ inches (38 mm) of concrete. The minimum diameter of caisson piles shall be 7 inches (178 mm). A suitable steel driving shoe shall be welded to the bottom of each caisson pile. The center-to-center spacing of caisson sockets shall be at least two and one-half times the outside diameter of the shell but not less than 4 feet (1219 mm).

**1810.7.8 Inspection.** All rock sockets shall be inspected to verify rock quality. Inspection may be accomplished by direct observation or by video methods or by a core boring performed prior to the drilling of the socket. Load tests performed in accordance with 1808.2.8.3 may be substituted for inspection of rock sockets.

**1810.7.9 Caisson piles in soil.** Caisson piles as described in Sections 1810.7 may be installed in soil provided that the socket is formed entirely in soil of class 4 or better and the concrete is placed under pressure exceeding 1.5 times the existing total overburden pressure. The socket shall be formed by extending the casing to the bottom of the socket and withdrawing the casing while the concrete is being pumped under pressure. Piles shall be installed in accordance with the provisions of Section 1810.3 and 1810.7. For diameters less than 12 inches (305 mm), the casing above the socket shall remain in place permanently. Reinforcing to the socket shall be placed in the casing to the depth of the socket prior to placing concrete.

## **SECTION BC 1811** **COMPOSITE PILES**

**1811.1 General.** Composite piles shall conform to the requirements of Sections 1811.2 through 1811.5.

**1811.2 Design.** Composite piles consisting of two or more approved pile types shall be designed to meet the conditions of installation.

**1811.3 Limitation of load.** The maximum allowable load shall be limited by the capacity of the weakest section incorporated in the pile.

**1811.4 Splices.** Splices between concrete and steel or wood sections shall be designed to prevent separation both before and after the concrete portion has set, and to ensure the alignment and transmission of the total pile load. Splices shall be designed to resist uplift caused by upheaval during driving of adjacent piles, and shall develop the full compressive strength and not less than 50 percent of the tension and bending strength of

the weaker section.

**1811.5 Seismic reinforcement.** Where a structure is assigned to Seismic Design Category C or D, in accordance with Section 1616 and where concrete and steel are used as part of the pile assembly, the concrete reinforcement shall comply with Sections 1810.1.2.1 and 1810.1.2.2 and the steel section shall comply with Section 1809.3.45 or 1810.6.4.1.

## **SECTION BC 1812** **PIER FOUNDATIONS**

**1812.1 General.** Isolated and multiple piers used as foundations shall conform to the requirements of Sections 1812.2 through 1812.11, as well as the applicable provisions of Section 1808.2.

**1812.2 Lateral dimensions and height.** The minimum dimension of isolated piers used as foundations shall be 2 feet (610 mm), and the height shall not exceed 12 times the least horizontal dimension.

**1812.3 Materials.** Concrete shall have a 28-day specified compressive strength ( $f'_c$ ) of not less than 2,500 psi (17.24 MPa). Where concrete is placed through a funnel hopper at the top of the pier, the concrete mix shall be designed and proportioned so as to produce a cohesive workable mix having a slump of not less than 4 inches (102 mm) and not more than 6 inches (152 mm). Where concrete is to be pumped, the mix design including slump shall be adjusted to produce a pumpable concrete.

**1812.4 Reinforcement.** Except for steel dowels embedded 5 feet (1524 mm) or less in the pier, reinforcement where required shall be assembled and tied together and shall be placed in the pier hole as a unit before the reinforced portion of the pier is filled with concrete.

**Exception:** Reinforcement is permitted to be wet set and the 2½ inch (64 mm) concrete cover requirement permitted to be reduced to 2 inches (51 mm) for Group R-3 and U occupancies not exceeding two stories of light-frame construction, provided the construction method is approved by the commissioner.

Reinforcement shall conform to the requirements of Sections 1810.1.2.1 and 1810.1.2.2.

### **Exceptions:**

1. Isolated piers supporting posts of Group R-3 and U occupancies not exceeding two stories of light-frame construction are permitted to be reinforced as required by rational analysis but not less than a minimum of one No. 4 bar, without ties or spirals, when detailed so the pier is not subject to lateral loads and the soil is determined to be of adequate stiffness.



2. Isolated piers supporting posts and bracing from decks and patios appurtenant to Group R-3 and U occupancies not exceeding two stories of light-frame construction are permitted to be reinforced as required by rational analysis but not less than one No. 4 bar, without ties or spirals, when the lateral load,  $E$ , to the top of the pier does not exceed 200 pounds (890 N) and the soil is determined to be of adequate stiffness.
3. Piers supporting the concrete foundation wall of Group R-3 and U occupancies not exceeding two stories of light-frame construction are permitted to be reinforced as required by rational analysis but not less than two No. 4 bars, without ties or spirals, when it can be shown the concrete pier will not rupture when designed for the maximum seismic load,  $E_m$ , and the soil is determined to be of adequate stiffness.
4. Closed ties or spirals where required by Section 1810.1.2.2 are permitted to be limited to the top 3 feet (914 mm) of the piers 10 feet (3048 mm) or less in depth supporting Group R-3 and U occupancies of Seismic Design Category D, not exceeding two stories of light-frame construction.

**1812.5 Concrete placement.** Concrete shall be placed in such a manner as to ensure the exclusion of any foreign matter and to secure a full-sized shaft. Concrete shall not be placed through water except where a tremie or other approved method is used. When depositing concrete from the top of the pier, the concrete shall not be chuted directly into the pier but shall be poured in a rapid and continuous operation through a funnel hopper centered at the top of the pier.

**1812.6 Belled bottoms.** Where pier foundations are belled at the bottom, the edge thickness of the bell shall not be less than that required for the edge of footings. Where the sides of the bell slope at an angle less than 60 degrees (1 rad) from the horizontal, the effects of vertical shear shall be considered.

**1812.7 Reserved.**

**1812.8 Concrete.** Where adequate lateral support is not provided, and the ratio of unsupported height to least lateral dimension does not exceed three, piers of plain concrete shall be designed and constructed as pilasters in accordance with ACI 318. Where the unsupported height to least lateral dimension exceeds three, piers shall be constructed of reinforced concrete, and shall conform to the requirements for columns in ACI 318.

**Exception:** Where adequate lateral support is furnished by the surrounding materials as defined in Section 1808.2.9, piers are permitted to be constructed of plain or reinforced concrete. The requirements of ACI 318 for bearing on concrete shall apply.

**1812.9 Steel shell.** Where concrete piers are entirely encased with a circular steel shell, and the area of the shell steel is considered reinforcing steel, the steel shall be protected under the conditions specified in Section 1808.2.17. Horizontal joints in the shell shall be

spliced to comply with Section 1808.2.7.

**1812.10 Dewatering.** Where piers are carried to depths below water level, the piers shall be constructed by a method that will provide accurate preparation and inspection of the bottom in dry conditions.

**1812.11 Method of construction.** Methods of construction shall conform to ACI 336.1 “Standard Specification for the Construction of Drilled Piers.”

### **SECTION BC 1813** **LIQUEFACTION ANALYSIS**

**1813.1 General.** An assessment of the liquefaction potential shall be determined for each building site. The evaluation of liquefaction potential shall include the following considerations:

1. Non-cohesive soils below ground water table and less than 50 feet (15 240 mm) below the ground surface shall be considered to have potential for liquefaction.
2. The potential for liquefaction on level ground shall be determined on the basis of the Occupancy Categories associated with the uncorrected Standard Penetration Resistance (N) at the site, as defined in Figure 1813.1, or a site specific analysis performed by an engineer with specific expertise in the evaluation of liquefaction.

#### **FIGURE 1813.1** **LIQUEFACTION ASSESSMENT DIAGRAM** **(Figure attached to end of document)**

**1813.2 Site-specific analyses.** In evaluating liquefaction potential, the analysis shall consider the following parameters: ground surface acceleration, earthquake magnitude, magnitude scaling factor, effective overburden pressure, hammer energy, cone penetration resistance (where applicable), and fines content. If a site response analysis is conducted, bedrock acceleration time histories and a shear wave velocity profile based on in-situ measurements may be utilized. These analyses may consider the results of laboratory cyclic shear tests.

**1813.3 Foundation design analysis.** The foundation design analysis shall consider an assessment of potential consequences of any liquefaction and soil strength loss including estimation of differential settlement, lateral movement or reduction in foundation soil bearing capacity, and may incorporate the potential benefits of any proposed mitigation measures. Such measures may be given consideration in the design of the structure and can include, but are not limited to, ground improvement, pore pressure dissipation, selection of appropriate foundation type and depths, selection of appropriate structural systems to accommodate anticipated displacements, or any combination of these measures.

In evaluating the potential for liquefaction, the effect of settlements induced by seismic motions and loss of soil strength shall be considered. The analysis performed shall incorporate the effects of peak ground acceleration, appropriate earthquake magnitudes and duration consistent with the design earthquake ground motions as well as uncertainty and variability of soil properties across the site. Peak ground acceleration, seismically induced cyclic stress ratios and pore pressure development may be determined from a site-specific study taking into account soil amplification effects and ground motions appropriate for the seismic hazard. Other recognized methods of analysis may be used in the evaluation process subject to the approval of the commissioner. Effects of pore water pressure buildup shall be considered in the design except for the following conditions:

1. The calculated cyclic shear demand is equal to or less than 75 percent of the calculated cyclic shear strength for Category I, II, and III structures.
2. The calculated cyclic shear demand is equal to or less than 85 percent of the calculated cyclic shear strength for Category IV structures.

**1813.4 Design considerations.** At sites where liquefaction is determined to be probable, the following considerations shall be in the design:

1. Liquefiable soils shall be considered to have no passive (lateral) resistance or bearing capacity value during an earthquake, unless shown otherwise by accepted methods of analysis. The engineer shall submit an analysis for review and approval by the commissioner, demonstrating that the proposed construction is safe against the effects of soil liquefaction.
2. Where liquefiable soils are present in sloped ground or over sloped non-liquefiable substrata and where lateral displacement is possible, the engineer shall submit a stability analysis for review and approval by the commissioner, demonstrating that the proposed construction is safe against failure of the soil and that the effect of potential lateral displacements are acceptable.

## **SECTION BC 1814** **UNDERPINNING**

**1814.1 General.** Where the protection and/or support of adjacent structures is required, an engineer shall prepare a preconstruction report summarizing the condition of the structure as determined from examination of the structure, the review of available design documents and if necessary, the excavation of test pits. The engineer shall determine the requirements for underpinning and protection and prepare site-specific plans, details, and sequence of work for submission to the commissioner. Such support may be provided by underpinning, sheeting, and bracing, or by other means acceptable to the commissioner. Underpinning piers, walls, piles, and footings shall be designed and installed in accordance with provisions of this chapter and Chapter 33 and shall be inspected in accordance with provisions of Chapter 17.

**1814.1.1 Underpinning and bracing.** Where underpinning is used for the support of adjacent structures, the piers, wall piles or footings shall be installed in such manner so as to prevent the lateral or vertical displacement of the adjacent structure, to prevent deterioration of the foundations or other effects that would disrupt the adjacent structure. The sequence of installation and the requirements for sheeting, preloading, wedging with steel wedges, jacking or dry packing shall be identified in the design.

**1814.2 Use of rock support in lieu of underpinning.** Existing structures founded at a level above the level of adjacent new construction may be supported on Class 1a and 1b rock in lieu of underpinning, sheeting and bracing or retaining walls, provided that a report by the engineer substantiates the safety of the proposed construction. The engineer shall also certify that he or she has inspected the exposed rock and the jointing therein and has determined whether supplemental support of the rock face is required.

**1814.3 Monitoring of influenced structures.** A land surveyor or engineer shall monitor the behavior of influenced structures during construction and for as long as necessary after construction concludes, as determined by the commissioner.

$$d = 0.5A\{1 + [1 + (4.36h/A)]^{1/2}\} \quad \text{(Equation 18-1)}$$

where:

$$A = 2.34P/S_1 b.$$


---

$b$  = Diameter of round post or footing or diagonal dimension of square post or footing, feet (m).

$d$  = Depth of embedment in earth in feet (m) but not over 12 feet (3658 mm) for purpose of computing lateral pressure.

$h$  = Distance in feet (m) from ground surface to point of application of "P"

$P$  = Applied lateral force in pounds (kN).

$S_1$  = Allowable lateral soil-bearing pressure as set forth in Section 1804.3 based on a depth of one-third the depth of embedment in pounds per square foot (psf) (kPa).

---

$$d^2 = 4.25(Ph/S_3 b) \quad \text{(Equation 18-2)}$$

or alternatively

$$d^2 = 4.25 (M_g/S_3 b) \quad \text{(Equation 18-3)}$$

where:

$M_g$  = moment in the post at grade, in foot-pounds (kN-m).

$S_3$  = Allowable lateral soil-bearing pressure as set forth in Section 1804.3 based on a depth equal to the depth of embedment in pounds per square foot (kPa).

---

$$\rho_s = 0.12f'_c/f_{yh} \quad \text{(Equation 18-4)}$$

where:

$f'_c$  = Specified compressive strength of concrete, psi (MPa)

$f_{yh}$  = Yield strength of spiral reinforcement  $\leq$  85,000 psi (586 MPa).

$\rho_s$  = Spiral reinforcement index (vol. spiral/vol. core).

---

$$\rho_s = 0.25(f'_c/f_{yh})(A_g/A_{ch} - 1.0)[0.5 + 1.4P/(f'_c A_g)]$$

(Equation 18-5)

but not less than:

$$\rho_s = 0.12(f'_c/f_{yh})[0.5 + 1.4P/(f'_c A_g)]$$

(Equation 18-6)

and need not exceed:

$$\rho_s = 0.021 \quad \text{(Equation 18-7)}$$

where:

$A_g$  = Pile cross-sectional area, square inches (mm<sup>2</sup>).

---

$$A_{sh} = 0.3sh_c(f'_c/f_{yh})(A_g/A_{ch} - 1.0)[0.5 + 1.4P/(f'_c A_g)]$$

(Equation 18-8)

but not less than:

$$A_{sh} = 0.12sh_c(f'_c/f_{yh})[0.5 + 1.4P/(f'_c A_g)]$$

(Equation 18-9)

where:

$f_{yh}$  = ≤ 70,000 psi (483 MPa).

$h_c$  = Cross-sectional dimension of pile core measured center to center of hoop reinforcement, inch (mm).

$s$  = Spacing of transverse reinforcement measured along length of pile, inch (mm).

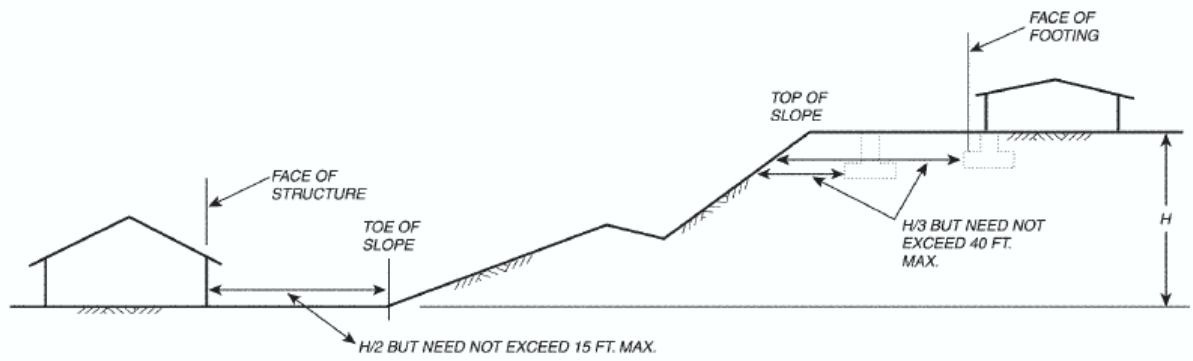
$A_{sh}$  = Cross-sectional area of transverse reinforcement, square inches (mm<sup>2</sup>)

$f'_c$  = Specified compressive strength of concrete, psi (MPa) ■

---

$$f_c = 0.33f'_c - 0.27f_{pc} \quad \text{(Equation 18-10)}$$

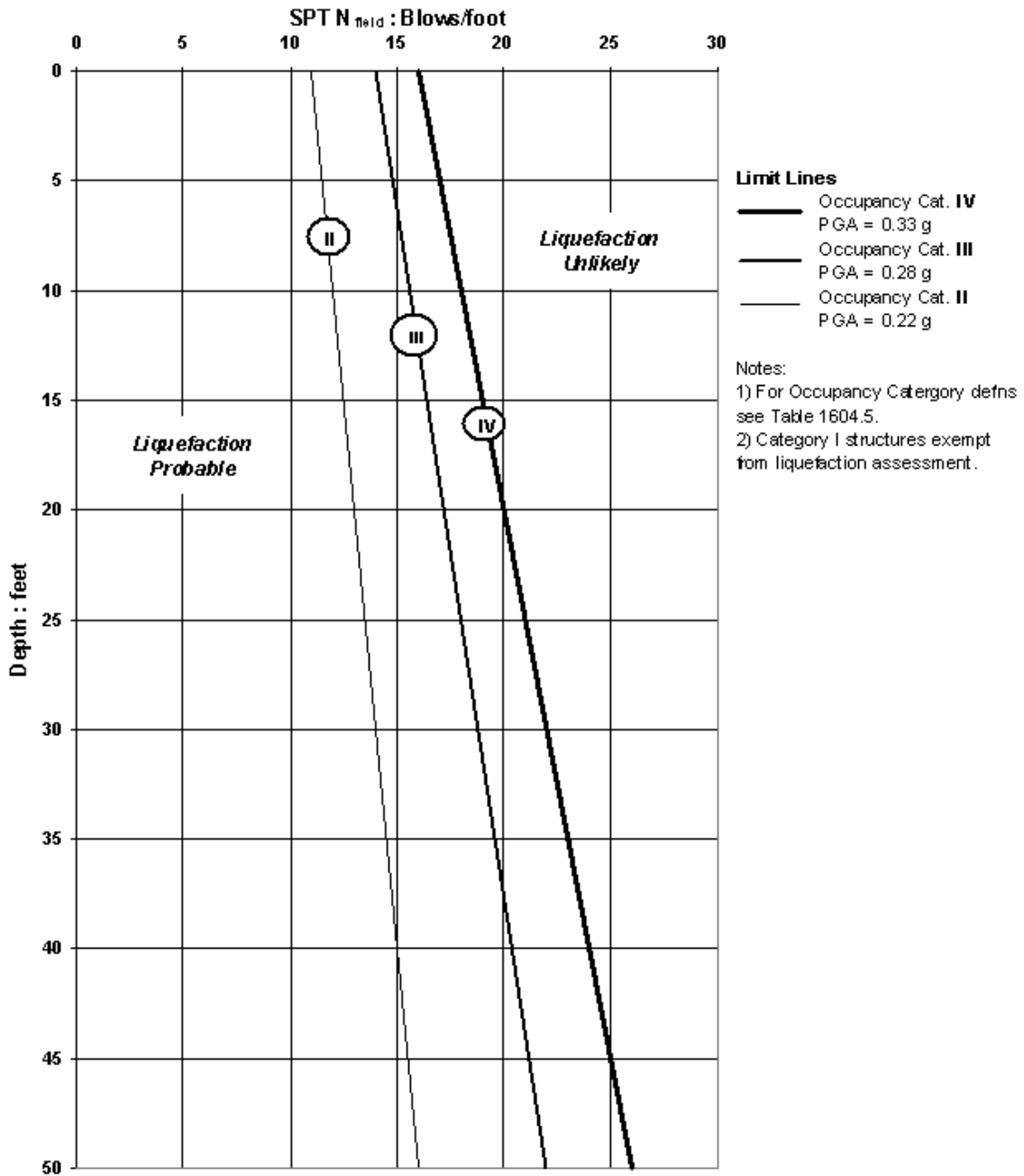

---



For SI: 1 foot = 304.8 mm.

FIGURE 1805.3.1  
FOUNDATION CLEARANCES FROM SLOPES

**FIGURE 1813.1**  
**LIQUEFACTION ASSESSMENT DIAGRAM**





**TABLE 1804.1**  
**ALLOWABLE BEARING PRESSURES**

<b><u>CLASS OF MATERIALS</u></b> <b><u>(Notes 1 and 3)</u></b>	<b><u>MAXIMUM</u></b> <b><u>ALLOWABLE</u></b> <b><u>FOUNDATION</u></b> <b><u>PRESSURE (TSF)</u></b>	<b><u>MAXIMUM</u></b> <b><u>ALLOWABLE</u></b> <b><u>FOUNDATION</u></b> <b><u>PRESSURE (kPa)</u></b>
1. <u>Bedrock (Notes 2 and 7)</u>		
1.a <u>Hard sound rock-gneiss, diabase, schist</u>	<u>60</u>	<u>5,746</u>
1.b <u>Medium Hard Rock-marble, serpentine</u>	<u>40</u>	<u>3,830</u>
1.c <u>Intermediate Rock-shale, sandstone</u>	<u>20</u>	<u>1,915</u>
1.d <u>Soft Rock-weathered rock</u>	<u>8</u>	<u>766</u>
2. <u>Sandy Gravel and Gravel (GW, GP) (Notes 3, 4, 8, and 9)</u>		
2.a <u>Dense</u>	<u>10</u>	<u>958</u>
2.b <u>Medium</u>	<u>6</u>	<u>575</u>
3. <u>Granular Soils (GC, GM, SW, SP,SM, and SC) (Notes 4, 5, 8, and 9)</u>		
3.a <u>Dense</u>	<u>6</u>	<u>575</u>
3.b <u>Medium</u>	<u>3</u>	<u>287</u>
4. <u>Clays (SC, CL, and CH) (Notes 4, 6, 8, and 9)</u>		
4.a <u>Hard</u>	<u>5</u>	<u>479</u>
4.b <u>Stiff</u>	<u>3</u>	<u>287</u>
4.c <u>Medium</u>	<u>2</u>	<u>192</u>
5. <u>Silts and Silty Soils (ML and MH) (Notes 4, 8, and 9)</u>		
5.a <u>Dense</u>	<u>3</u>	<u>287</u>
5.b <u>Medium</u>	<u>1.5</u>	<u>144</u>
6. <u>Organic silts, organic clays, peats, soft clays, loose granular soils and varved silts.</u>	<u>See 1804.2.1</u>	<u>See 1804.2.1</u>
7. <u>Controlled and Uncontrolled Fills.</u>	<u>See 1804.2.2 or 1804.2.3</u>	<u>See 1804.2.2 or 1804.2.3</u>

**Notes:**

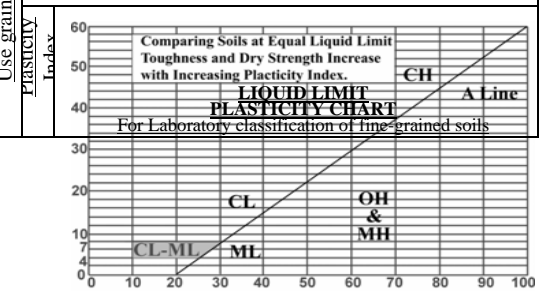
1. Where there is doubt as to the applicable classification of a soil stratum, the allowable bearing pressure applicable to the lower Class of material to which the given stratum might conform shall apply.
2. The tabulated values of allowable bearing pressures apply only for massive rocks or for sedimentary or foliated rocks, where the strata are level or nearly so, and, then only if the area has ample lateral support. Tilted strata and their relation to nearby slopes or excavations shall receive special

consideration. The tabulated values for Class 1a materials (Hard sound rock) may be increased by 25 percent provided the geotechnical engineer performs additional tests and/or analyses substantiating the increase.

3. For intermediate conditions, values of allowable bearing pressure shall be estimated by interpolation between indicated extremes.
4. Footing embedment in soils shall be in accordance with section 1805.2 and the width of the loaded area not less than 2 feet (610 mm), unless analysis demonstrates that the proposed construction will have a minimum factor of safety of 2.0 against shear failure of the soil.
5. Estimates of settlements shall govern the allowable bearing value, subject to the maximums given in this table, and as provided in Section 1804.2.
6. The bearing capacity of clay soils shall be established on the basis of the strength of such soils as determined by field or laboratory tests and shall provide a factor of safety against failure of the soil of not less than 2.0 computed on the basis of a recognized procedure of soils analysis, shall account for probable settlements of the building and shall not exceed the tabulated maximum values.
7. Increases in allowable bearing pressure due to embedment of the foundation: The allowable bearing values for intermediate to hard rock shall apply where the loaded area is on the surface of sound rock. Where the loaded area is below the adjacent rock surface and is fully confined by the adjacent rock mass and provided that the rock mass has not been shattered by blasting or otherwise is or has been rendered unsound, these values may be increased ten percent of the base value for each one foot (0.3 meters) of embedment below the surface of the adjacent rock surface in excess of one foot (0.3 meters), but shall not exceed 200 percent of the values.
8. The allowable bearing values for soils of Classes 2, 3, 4, and 5 determined in accordance with notes three, four and five above, shall apply where the loaded area is embedded 4 feet (1219 mm) or less in the bearing stratum. Where the loaded area is embedded more than 4 feet (1219 mm) below the adjacent surface of the bearing stratum, and is fully confined by the weight of the adjacent soil, these values may be increased five percent of the base value for each 1-foot (305) of additional embedment, but shall not exceed twice the values. Increases in allowable bearing pressure due to embedment shall not apply to soft rock, clays, silts and soils of classes 6 and 7.
9. The allowable bearing values for soils of Classes 2, 3, 4, and 5 determined in accordance with this table and the notes thereto, may be increased up to one third where the density of the bearing stratum below the bottom of the footings increases with depth and is not underlain by materials of a lower allowable bearing pressure. Such allowable bearing values shall be demonstrated by a recognized means of analysis that the probable settlement of the foundation due to compression, and/or consolidation does not exceed acceptable limits for the proposed building.
10. The maximum toe pressure for eccentrically loaded footings may exceed the allowable bearing value by up to 25 per cent if it is demonstrated that the heel of the footing is not subjected to tension.

**TABLE 1804.2**  
**UNIFIED SOIL CLASSIFICATION SYSTEM**

TABLE 1804.2 UNIFIED SOIL CLASSIFICATION (Including Identification and Description)										
Major Divisions		Group Symbols	Typical Names	Field Identification Procedures (Excluding particles larger than 3 in. and basing fractions on estimated weights)			Information Required for Describing Soils	Laboratory Classification Criteria		
1	2	3	4	5			6	7		
<u>Coarse-grained Soils</u> More than half of material is larger than No. 200 sieve size.  The No. 200 sieve size is about the smallest visible to the naked eye.	<u>Gravels</u> More than half of coarse fraction is larger than No. 4 sieve size. (For visual classification, the 1/4-in. size may be used as equivalent to the No. 4 sieve size.)	<u>GW</u> Clean Gravels (Little or no fines)	Well-graded gravels, gravel-sand mixture, little or no fines.	Wide range in grain size and substantial amounts of all intermediate particle sizes.			For undisturbed soils add information on stratification, degree of compactness, cementation, moisture condition, and drainage characteristics.  Give typical name; indicate approximate percentages of sand and gravel, maximum size; angularity, surface condition, and hardness of the coarse grains; local or geologic name and other pertinent descriptive information; and symbol in parentheses.	$C_u = \frac{D_{60}}{D_{10}}$ Greater than 4 $C_c = \frac{(D_{30})^2}{D_{10} \times D_{60}}$ Between 1 and 3 Not meeting all gradation requirements for GW	$C_u = \frac{D_{60}}{D_{10}}$ Greater than 4 $C_c = \frac{(D_{30})^2}{D_{10} \times D_{60}}$ Between 1 and 3 Not meeting all gradation requirements for SW	Atterberg limits above "A" line or PI less than 4 Limits plotting in hatched zone with PI between 4 and 7 are borderline cases requiring use of dual symbols.
		<u>GP</u> Clean Gravels (Little or no fines)	Poorly graded gravels or gravel-sand mixture, little or no fines.	Predominantly one size or a range of sizes with some intermediate sizes missing.						
		<u>GM</u> Gravels with Fines (Appreciable amount of fines)	Silty gravels, gravel-and-silt mixtures.	Nonplastic fines or fines with low plasticity (for identification procedures see ML below).						
		<u>GC</u> Gravels with Fines (Appreciable amount of fines)	Clayey gravels, gravel-and-clay mixtures.	Plastic fines (for identification procedures see CL below).						
		<u>SW</u> Clean Sands (Little or no fines)	Well-graded sands, gravelly sands, little or no fines.	Wide range in grain size and substantial amounts of all intermediate particle sizes.						
		<u>SP</u> Clean Sands (Little or no fines)	Poorly graded sands or gravelly sands, little or no fines.	Predominantly one size or a range of sizes with some intermediate sizes missing.						
		<u>SM</u> Sands with Fines (Appreciable amount of fines)	Silty sands, sand-silt mixtures.	Nonplastic fines or fines with low plasticity (for identification procedures see ML below).						
		<u>SC</u> Sands with Fines (Appreciable amount of fines)	Clayey sands, sand-clay mixtures.	Plastic fines (for identification procedures see CL below).						
	<u>Fine-grained Soils</u> More than half of material is smaller than No. 200 sieve size.  The No. 200 sieve size is about the smallest visible to the naked eye.	<u>Sands</u> More than half of coarse fraction is smaller than No. 4 sieve size. (For visual classification, the 1/4-in. size may be used as equivalent to the No. 4 sieve size.)	Identification Procedure on Fraction Smaller than No. 40 Sieve Size. Dry Strength (Crushing Characteristics)    Dilatancy (Reaction to shaking)    Toughness (Consistency near PL)			For undisturbed soils add information on structure, stratification, consistency in undisturbed and remolded states, moisture and drainage conditions	Use grain-size curve in identifying the fractions as given under field identification.  Determine percentage of gravel and sand from grain-size curve. Depending on percentage of fine (fraction smaller than No. 200 sieve size) coarse-grained soils are classified as follows: Less than 5%    GW, GP, SW, SP More than 12%    GM, GC, SM, SC 5% to 12%    Borderline cases requiring use of dual symbols.	Comparing Soils at Equal Liquid Limit Toughness and Dry Strength Increase with Increasing Plasticity Index. LIQUID LIMIT PLASTICITY CHART For Laboratory classification of fine-grained soils		
			<u>ML</u> Inorganic silts and very fine sands, rock flour, silty or clayey fine sands or clayey silts with slight plasticity	None to slight	Quick to slow				None	
<u>Silts and Clays</u> Liquid limit is less than 50	<u>CL</u> Inorganic clays of low to medium plasticity, gravelly clays, sandy clays, silty clays, lean clays.	Medium to high	None to very slow	Medium	CL, OH & MH, CL-ML, ML					



<u>Silts and Clays</u> <u>Liquid limit is</u> <u>greater than 50</u>	<u>OL</u>	<u>Organic silts and organic silty clays of low plasticity.</u>	<u>Slight to medium</u>	<u>Slow</u>	<u>Slight</u>	<u>Give typical name; indicate degree and character of plasticity; amount and maximum size of coarse grains; color in wet condition; odor, if any; local or geologic name and other pertinent descriptive information; and symbol in parentheses.</u>  <u>Example:</u> <u>Clayey silt, brown, slightly plastic; small percentage of fine sand; numerous vertical root holes; firm and dry in place; loess; (ML)</u>
	<u>MH</u>	<u>Inorganic silts, micaceous or diatomaceous fine sandy or silty soils, elastic silts.</u>	<u>Slight to medium</u>	<u>Slow to none</u>	<u>Slight to medium</u>	
	<u>CH</u>	<u>Inorganic clays of high plasticity, fat clays.</u>	<u>High to very high</u>	<u>None</u>	<u>High</u>	
	<u>OH</u>	<u>Organic clays of medium to high plasticity, organic silts.</u>	<u>Medium to high</u>	<u>None to very slow</u>	<u>Slight to medium</u>	
<u>Highly Organic Soils</u>	<u>Pt</u>	<u>Peat and other highly organic soils.</u>	<u>Readily identified by color, odor, spongy feel and frequently by fibrous texture</u>			
(1) <u>Boundary classifications: Soils possessing characteristics of two groups are designed by combinations of group symbols. For example GM-GC, well-graded gravel-sand mixture with clay binder.</u> (2) <u>All sieve sizes on this chart are U.S. standard.</u> (3) <u>Adopted by Corps of Engineers and Bureau of Reclamation, January 1952</u>						

**TABLE 1805.4.2**  
**FOOTINGS SUPPORTING WALLS OF LIGHT-FRAME CONSTRUCTION<sup>a, b, c, d, e</sup>**

NUMBER OF FLOORS SUPPORTED BY THE FOOTING <sup>f</sup>	WIDTH OF FOOTING (inches)	THICKNESS OF FOOTING (inches)
1	12	6
2	15	6
3	18	8 <sup>g</sup>

For SI: 1 inch = 25.4 mm, 1 foot = 304.8 mm.

- a. Depth of footings shall be in accordance with Section 1805.2.
- b. The ground under the floor is permitted to be excavated to the elevation of the top of the footing.
- c. Interior-stud-bearing walls are permitted to be supported by isolated footings. The footing width and length shall be twice the width shown in this table, and footings shall be spaced not more than 6 feet on center.
- d. See Section 1910 for additional requirements for footings of structures assigned to Seismic Design Category C, D, E or F.
- e. For thickness of foundation walls, see Section 1805.5.
- f. Footings are permitted to support a roof in addition to the stipulated number of floors. Footings supporting roof only shall be as required for supporting one floor.
- g. Plain concrete footings for Group R-3 occupancies are permitted to be 6 inches thick.

**TABLE 1805.5(2)**  
**8-INCH CONCRETE AND MASONRY FOUNDATION WALLS WITH REINFORCING WHERE  $d \geq 5$  INCHES<sup>a, b, c</sup>**

WALL HEIGHT (feet)	HEIGHT OF UNBALANCED BACKFILL (feet)	VERTICAL REINFORCEMENT		
		Soil classes and lateral soil load <sup>a</sup> (psf per foot below natural grade)		
		GW, GP, SW and SP soils 30	GM, GC, SM, SM-SC and ML soils 45	SC, MH, ML-CL and Inorganic CL soils 60
7	4 (or less)	#4 at 48" o.c.	#4 at 48" o.c.	#4 at 48" o.c.
	5	#4 at 48" o.c.	#4 at 48" o.c.	#4 at 40" o.c.
	6	#4 at 48" o.c.	#5 at 48" o.c.	#5 at 40" o.c.
	7	#4 at 40" o.c.	#5 at 40" o.c.	#6 at 48" o.c.
8	4 (or less)	#4 at 48" o.c.	#4 at 48" o.c.	#4 at 48" o.c.
	5	#4 at 48" o.c.	#4 at 48" o.c.	#4 at 40" o.c.
	6	#4 at 48" o.c.	#5 at 48" o.c.	#5 at 40" o.c.
	7	#5 at 48" o.c.	#6 at 48" o.c.	#6 at 40" o.c.
9	4 (or less)	#4 at 48" o.c.	#4 at 48" o.c.	#4 at 48" o.c.
	5	#4 at 48" o.c.	#4 at 48" o.c.	#5 at 48" o.c.
	6	#4 at 48" o.c.	#5 at 48" o.c.	#6 at 48" o.c.
	7	#5 at 48" o.c.	#6 at 48" o.c.	#7 at 48" o.c.
	8	#5 at 40" o.c.	#7 at 48" o.c.	#8 at 48" o.c.
	9	#6 at 40" o.c.	#8 at 48" o.c.	#8 at 32" o.c.

For SI: 1 inch = 25.4 mm, 1 foot = 304.8 mm, 1 pound per square foot per foot = 0.157 kPa/m.

a. For design lateral soil loads, see Section 1610. Soil classes are in accordance with the Unified Soil Classification System and design lateral soil loads are for moist soil conditions without hydrostatic pressure.

b. Provisions for this table are based on construction requirements specified in Section 1805.5.2.

c. For alternative reinforcement, see Section 1805.5.3.

**TABLE 1805.5(3)**  
**10-INCH CONCRETE AND MASONRY FOUNDATION WALLS WITH REINFORCING WHERE  $d \geq 6.75$  INCHES<sup>a, b, c</sup>**

WALL HEIGHT (feet)	HEIGHT OF UNBALANCED BACKFILL (feet)	VERTICAL REINFORCEMENT		
		Soil classes and lateral soil load <sup>a</sup> (psf per foot below natural grade)		
		GW, GP, SW and SP soils 30	GM, GC, SM, SM-SC and ML soils 45	SC, MH, ML-CL and Inorganic CL soils 60
7	4 (or less)	#4 at 56" o.c.	#4 at 56" o.c.	#4 at 56" o.c.
	5	#4 at 56" o.c.	#4 at 56" o.c.	#4 at 56" o.c.
	6	#4 at 56" o.c.	#4 at 48" o.c.	#4 at 40" o.c.
	7	#4 at 56" o.c.	#5 at 56" o.c.	#5 at 40" o.c.
8	4 (or less)	#4 at 56" o.c.	#4 at 56" o.c.	#4 at 56" o.c.
	5	#4 at 56" o.c.	#4 at 56" o.c.	#4 at 48" o.c.
	6	#4 at 56" o.c.	#4 at 48" o.c.	#5 at 56" o.c.
	7	#4 at 48" o.c.	#4 at 32" o.c.	#6 at 56" o.c.
	8	#5 at 56" o.c.	#5 at 40" o.c.	#7 at 56" o.c.
	4 (or less)	#4 at 56" o.c.	#4 at 56" o.c.	#4 at 56" o.c.
	5	#4 at 56" o.c.	#4 at 56" o.c.	#4 at 48" o.c.
	6	#4 at 56" o.c.	#4 at 40" o.c.	#4 at 32" o.c.
9	7	#4 at 40" o.c.	#5 at 48" o.c.	#6 at 48" o.c.
	8	#4 at 32" o.c.	#6 at 48" o.c.	#4 at 16" o.c.
	9	#5 at 40" o.c.	#6 at 40" o.c.	#7 at 40" o.c.

For SI: 1 inch = 25.4 mm, 1 foot = 304.8 mm, 1 pound per square foot per foot = 0.157 kPa/m.

a. For design lateral soil loads, see Section 1610. Soil classes are in accordance with the Unified Soil Classification System and design lateral soil loads are for moist soil conditions without hydrostatic pressure.

b. Provisions for this table are based on construction requirements specified in Section 1805.5.2.

c. For alternative reinforcement, see Section 1805.5.3.

**TABLE 1808.2.8.1.3**  
**MAXIMUM ALLOWABLE PILE LOADS**

<u>TYPE OF PILE</u>	<u>MAXIMUM ALLOWABLE PILE LOAD (TONS)</u>
<u>Caisson Piles</u>	<u>No upper limit</u>
<u>Open-end pipe (or tube) piles bearing on rock of classes 1a, 1b, or 1c</u>	<u>18-in O.D. and greater 250</u>
	<u>14-in to 18-in O.D. - 200</u>
	<u>12-in to 14-in - 150</u>
	<u>10-in to 12-in - 100</u>
	<u>8-in to 10-in - 60</u>
<u>Closed-end pipe (or tube) piles, H-piles, cast-in- place concrete, enlarged base piles, and precast concrete piles bearing on rock of Classes 1a, 1b, or 1c</u>	<u>150</u>
<u>Piles (other than timber piles) bearing on soft rock of Class 1d.</u>	<u>80</u>
<u>Piles (other than timber piles) that receive their principal support other than by direct bearing on rock of Class 1a. through 1d.</u>	<u>75</u>
<u>Timber piles bearing on rock of Class 1a. through 1d.</u>	<u>25</u>
<u>Timber piles bearing in suitable soils</u>	<u>40 tons maximum permissible with load test, 30 tons maximum without load test.</u>

**TABLE 1808.2.8.1.5A**  
**MINIMUM DRIVING RESISTANCE AND MINIMUM**  
**HAMMER ENERGY FOR STEEL H-PILES, PIPE PILES, PRECAST AND**  
**CAST-IN-PLACE CONCRETE PILES AND COMPOSITE PILES**  
**(other than timber)**

Minimum Driving Resistance <sup>a,c,d,e</sup>				
Pile Capacity (tons)	Hammer Energy <sup>b</sup> (ft. lbs.)	Friction Piles (blows/ ft.)	Piles Bearing on Soft Rock (Class 1.d (blows/ft.)	Piles Bearing on Rock (Class 1.a 1.b and 1.c)
<u>Up to 20</u>	<u>15,000</u>	<u>19</u>	<u>48</u>	5 Blows per 1/4 inch (Minimum hammer energy of 15,000 ft. lbs.)
	<u>19,000</u>	<u>15</u>	<u>27</u>	
	<u>24,000</u>	<u>11</u>	<u>16</u>	
<u>30</u>	<u>15,000</u>	<u>30</u>	<u>72</u>	
	<u>19,000</u>	<u>23</u>	<u>40</u>	
	<u>24,000</u>	<u>18</u>	<u>26</u>	
<u>40</u>	<u>15,000</u>	<u>44</u>	<u>96</u>	
	<u>19,000</u>	<u>32</u>	<u>53</u>	
	<u>24,000</u>	<u>24</u>	<u>34</u>	
<u>50</u>	<u>15,000</u>	<u>72</u>	<u>120</u>	
	<u>19,000</u>	<u>49</u>	<u>80</u>	
	<u>24,000</u>	<u>35</u>	<u>60</u>	
	<u>32,000</u>	<u>24</u>	<u>40</u>	
<u>60</u>	<u>15,000</u>	<u>96</u>	<u>240</u>	
	<u>19,000</u>	<u>63</u>	<u>150</u>	
	<u>24,000</u>	<u>44</u>	<u>100</u>	
	<u>32,000</u>	<u>30</u>	<u>50</u>	
<u>70 &amp; 80</u>	<u>19,000</u>		5 Blows per 1/4 inch (Minimum Hammer energy of 19,000 ft. lbs.)	
	<u>24,000</u>			
	<u>32,000</u>			

**Notes:**

- a. Final driving resistance shall be the sum of tabulated values plus resistance exerted by non-bearing materials. The driving resistance of non-bearing materials shall be taken as the resistance experienced by the pile during driving, but which will be dissipated with time and may be approximated as described in Section 1808.2.8.1.5.1.
- b. The hammer energy indicated is the rated energy.
- c. Sustained driving resistance. Where piles are to bear in Soft Rock, the minimum driving resistance shall be maintained for the last six inches, unless a higher sustained driving resistance requirement is established by load test. Where piles are to bear in soil classes 2 through 5, the minimum driving resistance shall be maintained for the last twelve inches unless load testing demonstrates a requirement for higher sustained driving resistance. No pile need be driven to a resistance to penetration (in blows per inch [blows per 25 mm] ) more than twice the resistance indicated in this table, nor beyond the point



at which there is no measurable net penetration under the hammer blow.

- d. The tabulated values assume that the ratio of total weight of pile to weight of striking part of the hammer does not exceed 3.5. If a larger ratio is to be used, or for other conditions for which no values are tabulated, the driving resistance shall be as approved by the commissioner.
- e. For intermediate values of pile capacity, minimum requirements for driving resistance may be determined by straight line interpolation.

**TABLE 1808.2.8.1.5B**  
**MINIMUM DRIVING RESISTANCE AND**  
**HAMMER ENERGY FOR TIMBER PILES**

<u>Pile Capacity (tons)</u>	<u>Minimum Driving Resistance (blows-in.) to be added to driving resistance exerted by non-bearing materials</u> <small>1.3.4</small>	<u>Hammer Energy (ft.-lbs.)<sup>2</sup></u>
<u>Up to 20</u>	<u>Formula in Note 4 shall apply</u>	<u>7,500-12,000</u>
<u>Over 20 to 25</u>		<u>9,000-12,000</u>
<u>Over 25 to 30</u>		<u>14,000-16,000</u>
<u>Greater than 30</u>		<u>12,000-16,000</u> <u>(single-acting hammers)</u>
		<u>15,000-20,000</u> <u>(double-acting hammers)</u>

**Notes:**

1. The driving resistance exerted by non-bearing materials is the resistance experienced by the pile during driving, but which will be dissipated with time and may be approximated as described in Section 1808.2.8.1.5.1.
2. The hammer energy indicated is the rated energy.
3. Sustained driving resistance. Where piles are to bear in soil classes Soft Rock, the minimum driving resistance shall be maintained for the last six inches, unless a higher sustained driving resistance requirement is established by load test. Where piles are to bear in soil classes 2 thru 5, the minimum driving resistance measured in blows per inch [blows per 25 mm] shall be maintained for the last twelve inches unless load testing demonstrates a requirement for higher sustained driving resistance. No pile need be driven to a resistance to penetration in blows per inch [blows per 25 mm] more than twice the resistance indicated in this table nor beyond the point at which there is no measurable net penetration under the hammer blow.
4. The minimum driving resistance shall be determined by the following formula:

$$P = \frac{2WhH}{(S + 0.1)} \quad \text{or} \quad P = \frac{2E}{(S + 0.1)}$$

- Where: P = Allowable pile load in pounds.  
Wp = Weight of pile in pounds.  
Wh = Weight of striking part of hammer in pounds.  
H = Actual height of fall of striking part of hammer in feet.  
E = Rated energy delivered by the hammer per blow in foot lbs.  
S = Penetration of pile per blow, in inches, after the pile has been driven to a depth where successive blows produce approximately equal net penetration.

The value Wp shall not exceed three times Wh.

**CHAPTER 19**  
**CONCRETE**

**SECTION BC 1901**  
**GENERAL**

**1901.1 Scope.** The provisions of this chapter shall govern the materials, quality control, design and construction of concrete used in structures.

**1901.2 Plain and reinforced concrete.** Structural concrete shall be designed and constructed in accordance with the requirements of this chapter and ACI 318 as amended in Section 1908 of this code. Except for the provisions of Sections 1904 and 1911, the design and construction of slabs on grade shall not be governed by this chapter unless they transmit vertical loads or lateral forces from other parts of the structure to the soil.

**1901.3 Source and applicability.** Sections 1902 through 1907 of this chapter are derived from the provisions for structural concrete in ACI 318. Where sections within Chapters 2 through 7 of ACI 318 are referenced in other chapters and appendices of ACI 318, the provisions of Sections 1902 through 1907 of this code shall apply.

**1901.4 Construction documents.** The construction documents for structural concrete construction shall include:

1. Specified compressive strength of concrete at the stated ages or stages of construction for which each concrete element is designed.
2. Specified strength or grade of reinforcement.
3. Size and location of structural elements, reinforcement, and anchors.
4. Provision for dimensional changes resulting from creep, shrinkage and temperature.
5. Magnitude and location of prestressing forces.
6. Anchorage length of reinforcement and location and length of lap splices.
7. Type and location of mechanical and welded splices of reinforcement.
8. Details and location of contraction or isolation joints specified for plain concrete.
9. Minimum concrete compressive strength at time of posttensioning.
10. Stressing sequence for posttensioning tendons.
11. For structures assigned to Seismic Design Category D, a statement if slab on

- grade is designed as a structural diaphragm (see Section 21.10.3.4 of ACI 318).
12. Freezing and thawing and deicing chemical exposure classifications (see Section 1904.2).
13. Sulfate exposure classification (see Section 1904.3).
14. Maximum water soluble chloride ion (CI) concentrations (see Section 1904.4).

**1901.5 Special inspection.** The special inspection of concrete elements of buildings and structures and concreting operations shall be in accordance with Chapter 17.

## **SECTION BC 1902** **DEFINITIONS**

**1902.1 General.** The following words and terms shall have the meanings shown herein.

**ADMIXTURE.** Material other than water, aggregate or hydraulic cement, used as an ingredient of concrete and added to concrete before or during its mixing to modify its properties.

**AGGREGATE.** Granular material, such as sand, gravel, crushed stone and iron blast-furnace slag, used with a cementing medium to form a hydraulic cement concrete or mortar.

**AGGREGATE, LIGHTWEIGHT.** Aggregate with a dry, loose weight of 70 pounds per cubic foot (pcf) (1120 kg/m<sup>3</sup>) or less.

**CEMENTITIOUS MATERIALS.** Materials as specified in Section 1903 that have cementing value when used in concrete either by themselves, such as portland cement, blended hydraulic cements and expansive cement, or such materials in combination with fly ash, other raw or calcined natural pozzolans, silica fume, and/or ground granulated blast-furnace slag.

**COLUMN.** A member with a ratio of height-to-least-lateral dimension exceeding three, used primarily to support axial compressive load.

**CONCRETE.** A mixture of portland cement or any other hydraulic cement, fine aggregate, coarse aggregate and water, with or without admixtures.

**CONCRETE, SPECIFIED COMPRESSIVE STRENGTH OF, ( $f'_c$ ).** The compressive strength of concrete used in design and evaluated in accordance with the provisions of Section 1905, expressed in pounds per square inch (psi) (MPa). Whenever the quantity  $f'_c$  is under a radical sign, the square root of the numerical value only is intended, and the result has units of psi (MPa).

**CONTRACTION JOINT.** Formed, sawed or tooled groove in a concrete structure to create a weakened plane and regulate the location of cracking resulting from the dimensional change of different parts of the structure.

**DEFORMED REINFORCEMENT.** Deformed reinforcing bars, bar mats, deformed wire, welded plain wire fabric and welded deformed wire fabric conforming to ACI 318, Section 3.5.3.

**DUCT.** A conduit (plain or corrugated) to accommodate prestressing steel for postensioned installation.

**EFFECTIVE DEPTH OF SECTION ( $d$ ).** The distance measured from extreme compression fiber to the centroid of tension reinforcement.

**ISOLATION JOINT.** A separation between adjoining parts of a concrete structure, usually a vertical plane, at a designed location such as to interfere least with performance of the structure, yet to allow relative movement in three directions and avoid formation of cracks elsewhere in the concrete and through which all or part of the bonded reinforcement is interrupted.

**PEDESTAL.** An upright compression member with a ratio of unsupported height-to-average-least-lateral dimension of three or less.

**PLAIN CONCRETE.** Structural concrete with no reinforcement or with less reinforcement than the minimum amount specified for reinforced concrete.

**PLAIN REINFORCEMENT.** Reinforcement that does not conform to the definition of “Deformed reinforcement” (see ACI 318, Section 3.5.4).

**POSTTENSIONING.** Method of prestressing in which prestressing steel is tensioned after concrete has hardened.

**PRECAST CONCRETE.** A structural concrete element cast elsewhere than its final position in the structure.

**PRESTRESSED CONCRETE.** Structural concrete in which internal stresses have been introduced to reduce potential tensile stresses in concrete resulting from loads.

**PRESTRESSING STEEL.** High-strength steel element such as wire, bar or strand, or a bundle of such elements, used to impart prestress forces to concrete.

**PRETENSIONING.** Method of prestressing in which prestressing steel is tensioned before concrete is placed.

**REINFORCED CONCRETE.** Structural concrete reinforced with no less than the minimum amounts of prestressing steel or nonprestressed reinforcement specified in ACI

318, Chapters 1 through 21 and ACI 318 Appendices A through C.

**REINFORCEMENT.** Material that conforms to Section 1903.5, excluding prestressing steel unless specifically included.

**RESHORES.** Shores placed snugly under a concrete slab or other structural member after the original forms and shores have been removed from a larger area, thus requiring the new slab or structural member to deflect and support its own weight and existing construction loads applied prior to the installation of the reshores.

**SHORES.** Vertical or inclined support members designed to carry the weight of the formwork, concrete and construction loads above.

**SPIRAL REINFORCEMENT.** Continuously wound reinforcement in the form of a cylindrical helix.

**STRIPPING OPERATIONS.** Removal on the floor of any parts of the concrete formwork including shoring, bracing and other supports.

**STIRRUP.** Reinforcement used to resist shear and torsion stresses in a structural member; typically bars, wires or welded wire fabric (plain or deformed) either single leg or bent into L, U or rectangular shapes and located perpendicular, or at an angle to, longitudinal reinforcement. (The term “stirrups” is usually applied to lateral reinforcement in flexural members and the term “ties” to those in compression members.)

**STRUCTURAL CONCRETE.** Concrete used for structural purposes, including plain and reinforced concrete.

**TENDON.** In pretensioning applications, the tendon is the prestressing steel. In posttensioned applications, the tendon is a complete assembly consisting of anchorages, prestressing steel and sheathing with coating for unbonded applications or ducts with grout for bonded applications.

### **SECTION BC 1903** **SPECIFICATIONS FOR TESTS AND MATERIALS**

**1903.1 General.** Materials used to produce concrete and testing thereof shall comply with the applicable standards listed in ACI 318 and this section. Tests of concrete and the materials used in concrete shall be in accordance with ACI 318, Section 3.8. Where required, special inspections and tests shall be in accordance with Chapter 17.

**1903.2 Cement.** Cement used to produce concrete shall comply with ACI 318, Section 3.2.

**1903.3 Aggregates.** Aggregates used in concrete shall comply with ACI 318, Section 3.3.

**1903.4 Water.** Water used in mixing concrete shall be clean and free from injurious amounts of oils, acids, alkalis, salts, organic materials or other substances that are deleterious to concrete or steel reinforcement and shall comply with ACI 318, Section 3.4.

**1903.5 Steel reinforcement.** Reinforcement and welding of reinforcement to be placed in concrete construction shall conform to the requirements of this section.

**1903.5.1 Reinforcement type.** Reinforcement shall be deformed reinforcement, except plain reinforcement is permitted for spirals or prestressing steel, and reinforcement consisting of structural steel, steel pipe or steel tubing is permitted where specified in ACI 318. Reinforcement shall comply with ACI 318, Section 3.5.

**1903.5.2 Welding.** Welding of reinforcing bars shall conform to AWS D1.4. Type and location of welded splices and other required welding of reinforcing bars shall be indicated on the construction documents or in the project specifications. The ASTM reinforcing bar specifications, except for ASTM A 706, shall be supplemented to require a report of material properties necessary to conform to the requirements in AWS D1.4. A written welding procedure shall be provided to the registered design professional of record for approval prior to any welding. All welding shall be subject to special inspection by an approved agency.

**1903.6 Admixtures.** Admixtures to be used in concrete shall be subject to prior approval by the registered design professional of record and shall comply with ACI 318, Section 3.6.

**1903.7 Storage of materials.** The storage of materials for use in concrete shall comply with the provisions of Sections 1903.7.1 and 1903.7.2.

**1903.7.1 Manner of storage.** Cementitious materials and aggregates shall be stored in such a manner as to prevent deterioration or intrusion of foreign matter.

**1903.7.2 Unacceptable material.** Any material that has deteriorated or has been contaminated shall not be used for concrete.

**1903.8 Glass fiber reinforced concrete.** Glass fiber reinforced concrete (GFRC) and the materials used in such concrete shall be in accordance with the PCI MNL 128 standard.

## **SECTION BC 1904** **DURABILITY REQUIREMENTS**

**1904.1 Water-cementitious materials ratio.** The water-cementitious materials ratios specified in Tables 1904.2.2 and 1904.3 shall be calculated using the weight of cement meeting ASTM C 150, ASTM C 595, ASTM C 845 or ASTM C 1157, plus the weight of fly ash and other pozzolans meeting ASTM C 618, slag meeting ASTM C 989 and silica fume meeting ASTM C 1240, if any, except that where concrete is exposed to deicing chemicals, Section 1904.2.3 further limits the amount of fly ash, pozzolans, silica fume,

slag or the combination of these materials.

**1904.2 Freezing and thawing exposures.** Concrete that will be exposed to freezing and thawing or deicing chemicals shall comply with Sections 1904.2.1 through 1904.2.3.

**1904.2.1 Air entrainment.** Normal-weight and lightweight concrete exposed to freezing and thawing or deicing chemicals shall be air entrained in accordance with Table 1904.2.1. Tolerance of air content as delivered shall be  $\pm 1.5$  percent. For specified compressive strength ( $f'_c$ ) greater than 5,000 psi (34.47 MPa), reduction of air content indicated in Table 1904.2.1 by 1.0 percent is permitted.

**TABLE 1904.2.1**  
**TOTAL AIR CONTENT FOR FROST-RESISTANT CONCRETE**  
**(Table 1904.2.1 attached to end of document)**

**1904.2.2 Concrete properties.** Concrete that will be subject to the exposures given in Table 1904.2.2(1) shall conform to the corresponding maximum water-cementitious materials ratios and minimum specified concrete compressive strength requirements of that table. In addition, concrete that will be exposed to deicing chemicals shall conform to Section 1904.2.3.

**Exception:** For Group R and accessory occupancies that are in buildings less than four stories in height, normal-weight aggregate concrete that is subject to freezing and thawing or deicer chemicals shall comply with the requirements of Table 1904.2.2(2).

**TABLE 1904.2.2(1)**  
**REQUIREMENTS FOR SPECIAL EXPOSURE CONDITIONS**  
**(Table 1904.2.2(1) attached to end of document)**

**TABLE 1904.2.2(2)**  
**MINIMUM SPECIFIED COMPRESSIVE STRENGTH ( $f'_c$ )**  
**(Table 1904.2.2(2) attached to end of document)**

**1904.2.3 Deicing chemicals.** For concrete exposed to deicing chemicals, the maximum weight of fly ash, other pozzolans, silica fume or slag that is included in the concrete shall not exceed the percentages of the total weight of cementitious materials given in Table 1904.2.3.

**TABLE 1904.2.3**  
**REQUIREMENTS FOR CONCRETE EXPOSED TO DEICING CHEMICALS**  
**(Table 1904.2.3 attached to end of document)**

**1904.3 Sulfate exposures.** Where concrete will be exposed to sulfate-containing solutions, it shall comply with the provisions of Sections 1904.3.1 and 1904.3.2.



**1904.3.1 Concrete quality.** Concrete to be exposed to sulfate-containing solutions or soils shall conform to the requirements of Table 1904.3 or shall be concrete made with a cement that provides sulfate resistance and that has a maximum water-cementitious materials ratio and minimum compressive strength as set forth in Table 1904.3.

**1904.3.2 Calcium chloride.** Calcium chloride as an admixture shall not be used in concrete to be exposed to those severe or very severe sulfate-containing solutions defined in Table 1904.3.

**TABLE 1904.3**  
**REQUIREMENTS FOR CONCRETE EXPOSED TO SULFATE-CONTAINING SOLUTIONS**

**(Table 1904.3 attached to end of document)**

**1904.4 Corrosion protection of reinforcement.** Reinforcement in concrete shall be protected from corrosion and exposure to chlorides as provided by Sections 1904.4.1 and 1904.4.2.

**1904.4.1 General.** For corrosion protection of reinforcement in concrete, the maximum water-soluble chloride ion concentrations in hardened concrete at ages from 28 to 42 days contributed from the ingredients including water, aggregates, cementitious materials and admixtures shall not exceed the limits of Table 1904.4.1. When testing is performed to determine water-soluble chloride ion content, test procedures shall conform to ASTM C 1218.

**TABLE 1904.4.1**  
**MAXIMUM CHLORIDE ION CONTENT FOR CORROSION PROTECTION OF REINFORCEMENT**

**(Table 1904.4.1 attached to end of document)**

**1904.4.2 Exposure to chlorides.** Where concrete with reinforcement will be exposed to chlorides from deicing chemicals, salt, saltwater, brackish water, seawater or spray from these sources, the requirements of Table 1904.2.2(1) for water-cementitious materials ratio and concrete strength, and the minimum concrete cover requirements of Section 1907.7, shall be satisfied. For corrosion protection of unbonded tendons compliance with ACI 318, Section 18.16 shall be required. The limits on acid-soluble and water-soluble chlorides in fresh concrete that contains reinforcing steel or other metals shall conform to the requirements of ACI 222, Section 3.2.

**SECTION BC 1905**  
**CONCRETE QUALITY, MIXING AND PLACING**

**1905.1 General.** The required strength and durability of concrete shall be governed by compliance with the proportioning, testing, mixing and placing provisions of Sections 1905.1.1 through 1905.13.

**1905.1.1 Strength.** Concrete shall be proportioned to provide an average compressive strength in accordance with Section 1905.3, and shall satisfy the durability criteria of Section 1904. Concrete shall be produced to minimize the frequency of strengths below  $f'_c$  in compliance with Section 1905.6.3.3. For concrete designed and constructed in accordance with this chapter,  $f'_c$  shall not be less than 2,500 psi (17.22 MPa). No maximum specified compressive strength shall apply unless restricted by a specific provision of this code or ACI 318.

**1905.1.2 Cylinder tests.** Requirements for  $f'_c$  shall be based on tests of cylinders made and tested in accordance with Section 1905.6.3.

**1905.1.3 Basis of  $f'_c$ .** Unless otherwise specified,  $f'_c$  shall be based on 28-day tests. If other than 28 days, test age for  $f'_c$  shall be as indicated in construction documents. If at any time during the concrete operations, the concrete is not in conformance with ASTM C 94 or is otherwise compromised, it shall be rejected. If it is placed, the location of the load shall be recorded and a pair of cylinders shall be molded from the load per ASTM C 31 and included in the average  $f'_c$ .

**1905.1.4 Lightweight aggregate concrete.** Where design criteria in ACI 318, Sections 9.5.2.3, 11.2 and 12.2.4, provide for use of a splitting tensile strength value of concrete ( $f_{ct}$ ), laboratory tests shall be made in accordance with ASTM C 330 to establish the value of  $f_{ct}$  corresponding to the specified value of  $f'_c$ .

**1905.1.5 Field acceptance.** Splitting tensile strength tests shall not be used as a basis for field acceptance of concrete.

**1905.2 Selection of concrete proportions.** Concrete proportions shall be determined in accordance with the provisions of Sections 1905.2.1 through 1905.2.3.

**1905.2.1 General.** Proportions of materials for concrete shall be established to provide:

1. Workability and consistency to permit concrete to be worked readily into forms and around reinforcement under the conditions of placement to be employed, without segregation or excessive bleeding.
2. Resistance to special exposures as required by Section 1904.
3. Conformance with the strength test requirements of Section 1905.6.

**1905.2.2 Different materials.** Where different materials are to be used for different portions of proposed work, each combination shall be evaluated.

**1905.2.3 Basis of proportions.** Concrete proportions shall be established in accordance with Section 1905.3 or Section 1905.4, and shall comply with the

applicable requirements of Section 1904.

**1905.3 Proportioning on the basis of field experience and/or trial mixtures.** Concrete proportioning determined on the basis of field experience or trial mixtures shall be done in accordance with ACI 318, Section 5.3. If the required  $f'_c$  is obtained for trial batch mixes prior to the date specified, the trial mix design may be approved. All mixes shall be approved by the registered design professional of record. prior to construction.

**1905.4 Proportioning without field experience or trial mixtures.** Concrete proportioning determined without field experience or trial mixtures shall be done in accordance with ACI 318, Section 5.4. This method of proportioning shall not be permitted for load carrying structural concrete or concrete mix proportions that are required to conform with Section 1904.

**1905.5 Average strength reduction.** As data become available during construction, it is permissible to reduce the amount by which the average compressive strength ( $f'_c$ ) is required to exceed the specified value of  $f'_c$  in accordance with ACI 318, Section 5.5.

**1905.6 Evaluation and acceptance of concrete.** The criteria for evaluation and acceptance of concrete shall be as specified in Sections 1905.6.2 through 1905.6.5.5.

**1905.6.1 Qualified technicians.** Concrete shall be tested in accordance with the requirements in Sections 1905.6.2 through 1905.6.5. An approved agency shall perform tests on fresh concrete at the job site, prepare specimens required for curing under field conditions, prepare specimens required for testing in the laboratory and record the temperature of the fresh concrete when preparing specimens for strength tests. All field sampling and testing, including the testing of aggregates, concrete mixes, and strength testing of specimens, shall be subject to special inspection by an approved agency. All testing laboratories shall be approved testing agencies and shall employ qualified special inspectors to perform all required laboratory tests. Test results shall be promptly distributed by the testing laboratory to the registered design professional of record, concrete producer, owner, and contractor.

**1905.6.2 Frequency of testing.** The frequency of conducting strength tests of concrete shall be as specified in Sections 1905.6.2.1 through 1905.6.2.4.

**1905.6.2.1 Minimum frequency.** Samples for strength tests of each class of concrete placed each day shall be taken not less than once a day, nor less than once for each 50 cubic yards (38 m<sup>3</sup>) of concrete nor less than once for each 5,000 square feet (465 m<sup>2</sup>) of surface area for slabs or walls. For concrete mixes proportioned for durability requirements specified in Section 1904, the registered design professional of record shall specify additional field testing of the concrete for unit weight, air, and water content. At the discretion of the registered design professional of record, the frequency of testing may be reduced, but not less than once for each 150 cubic yards (115 m<sup>3</sup>).

**1905.6.2.2 Minimum number.** On a given project, if the total volume of concrete is such that the frequency of testing required by Section 1905.6.2.1 would provide less than five strength tests for a given class of concrete, tests shall be made from at least five randomly selected batches or from each batch if fewer than five batches are used.

**1905.6.2.3 Small volume.** When the total volume of a given class of concrete is less than 50 cubic yards (38 m<sup>3</sup>), and the concrete is non-structural and is not subject to the durability requirements of Section 1904, testing may be waived by the registered design professional of record.

**1905.6.2.4 Strength test.** A strength test shall be the average of the strengths of two cylinders made from the same sample of concrete and tested at 28 days or at the test age designated for the determination of  $f'_c$ . Consideration shall be given specifying an  $f'_c$  at 56 days or later for concrete utilizing pozzolans in the mix proportions. At the discretion of the registered design professional of record or the approved agency performing the testing, additional pairs of test cylinders may be taken at the time of sampling for testing at a later date. The additional cylinders may be tested at a later date should the strength at the specified date not meet the required  $f'_c$ .

**1905.6.3 Laboratory-cured specimens.** Laboratory-cured specimens shall comply with the provisions of Sections 1905.6.3.1 through 1905.6.3.4.

**1905.6.3.1 Sampling.** Samples for strength tests shall be taken in accordance with ASTM C 172.

**1905.6.3.2 Cylinders.** Cylinders for strength tests shall be molded and laboratory-cured in accordance with ASTM C 31. The Contractor shall be responsible for providing the specified field storage curing facility and for monitoring the temperature as defined in ASTM C 31. The cylinders shall be tested in accordance with ASTM C 39.

**1905.6.3.3 Acceptance of results.** The strength level of an individual class of concrete shall be considered satisfactory if both of the following requirements are met:

1. Every arithmetic average of any three consecutive strength tests equals or exceeds  $f'_c$ .
2. No individual strength test (average of two cylinders) falls below  $f'_c$  by more than 500 psi (3.45 MPa) when  $f'_c$  is 5,000 psi (34.50 MPa) or less, or by more than 0.10  $f'_c$  when  $f'_c$  is more than 5,000 psi (34.50 MPa).

**1905.6.3.4 Correction.** If either of the requirements of Section 1905.6.3.3 is not met, steps shall be taken to increase the average of subsequent strength test results. The requirements of Section 1905.6.5 shall govern if the requirement of

Section 1905.6.3.3, subsection 2 is not met.

**1905.6.4 Field-cured specimens.** Field-cured specimens shall comply with the provisions of Sections 1905.6.4.1 through 1905.6.4.4.

**1905.6.4.1 When required.** Where required by the commissioner, the results of strength tests of cylinders cured under field conditions shall be provided to the department.

**1905.6.4.2 Curing.** Field-cured cylinders shall be cured under field conditions in accordance with ASTM C 31.

**1905.6.4.3 Sampling.** Field-cured test cylinders shall be molded at the same time and from the same samples as laboratory-cured test cylinders.

**1905.6.4.4 Correction.** Procedures for protecting and curing concrete shall be improved when the strength of field-cured cylinders at the test age designated for determination of  $f'_c$  is less than 85 percent of that of companion laboratory-cured cylinders. The 85-percent limitation shall not apply if the field-cured strength exceeds  $f'_c$  by more than 500 psi (3.45 MPa).

**1905.6.5 Low-strength test results.** The investigation of low-strength test results shall be in accordance with the provisions of Sections 1905.6.5.1 through 1905.6.5.5.

**1905.6.5.1 Precaution.** If any strength test of laboratory-cured cylinders performed in accordance with Section 1905.6.2.4 falls below the specified value of  $f'_c$  by more than the values given in Section 1905.6.3.3, subsection 2, or if tests of field-cured cylinders performed in accordance with Section 1905.6.4.4 indicate deficiencies in protection and curing, steps shall be taken to assure that the load-carrying capacity of the structure is not jeopardized.

**1905.6.5.2 Core tests.** Where calculations indicate that load-carrying capacity is significantly reduced, tests of cores drilled from the area in question in accordance with ASTM C 42 shall be permitted. In such cases, three cores shall be taken for each strength test that falls below the values given in Section 1905.6.3.3, subsection 2.

**1905.6.5.3 Condition of cores.** Cores shall be prepared for transport and storage by wiping drilling water from their surfaces and placing the cores in water-tight bags or containers immediately after drilling. Cores shall be tested not earlier than 48 hours nor later than seven days after coring unless approved by the registered design professional of record.

**1905.6.5.4 Test results.** Concrete in an area represented by core tests shall be considered structurally adequate if the average of three cores is equal to at least 85 percent of  $f'_c$  and if no single core is less than 75 percent of  $f'_c$ . Additional

testing of cores extracted from locations represented by erratic core strength results is permitted.

**1905.6.5.5 Strength evaluation.** If the criteria of Section 1905.6.5.4 are not met and the structural adequacy remains in doubt, the commissioner may order a strength evaluation in accordance with ACI 318, Chapter 20, for the questionable portion of the structure, or take other appropriate action. The registered design professional of record shall present to the commissioner a complete analysis showing the final safe load-carrying capacity of the questionable portion of the structure including any proposed remedial actions necessary for review and approval.

**1905.7 Preparation of equipment and place of deposit.** Preparation before concrete placement shall include the following:

1. Equipment for mixing and transporting concrete shall be clean.
2. Debris and ice shall be removed from spaces to be occupied by concrete.
3. Forms shall be properly coated.
4. Masonry filler units that will be in contact with concrete shall be well drenched.
5. Reinforcement shall be thoroughly clean of ice or other deleterious coatings.
6. Water shall be removed from the place of deposit before concrete is placed unless a tremie is to be used or unless otherwise permitted by the commissioner.
7. Laitance and other unsound material shall be removed before additional concrete is placed against hardened concrete.

**1905.8 Mixing.** Mixing of concrete shall be performed in accordance with Sections 1905.8.1 through 1905.8.3.

**1905.8.1 General.** Concrete shall be mixed until there is a uniform distribution of materials and shall be discharged completely before the mixer is recharged.

**1905.8.2 Ready-mixed concrete.** Ready-mixed concrete shall be mixed and delivered in accordance with the requirements of ASTM C 94 or ASTM C 685. Concrete plants shall be certified by the National Ready Mixed Concrete Association (NRMCA) and shall comply with the rules of the department. Concrete producers shall have their plants inspected quarterly and have their scales and trucks certified. In fulfilling this certification requirement, the concrete producer may present certification by either a New York City government agency, or by the New York State Department of Transportation subject to the approval of the commissioner. Concrete ready-mix truck drivers shall be certified by the NRMCA and shall comply

with the rules of the department.

If required by the registered design professional of record, batch tickets shall accompany every load of concrete delivered to a site. The batch ticket shall contain the information given below:

1. Plant Name and Location;
2. Contract Number and Project;
3. Mix Designation as to Type and Strength;
4. Each material in the load along with quantities of each by weight; and
5. The total amount of mix proportion water approved, quantity of water added at the plant and in transit, and the remaining water that can be added on site.

**1905.8.3 Job-mixed concrete.** Job-mixed concrete shall comply with ACI 318, Section 5.8.3.

**1905.9 Conveying.** The method and equipment for conveying concrete to the place of deposit shall comply with Sections 1905.9.1 and 1905.9.2.

**1905.9.1 Method of conveyance.** Concrete shall be conveyed from the mixer to the place of final deposit by methods that will prevent separation or loss of materials that may alter the properties of the concrete delivered. Cylinders shall be made at the truck to determine the quality of concrete delivered to the site. Cylinders shall be made at the point of placement to determine the quality of concrete in-place.

**1905.9.2 Conveying equipment.** The conveying equipment shall be capable of providing a supply of concrete at the site of placement without separation of ingredients and without interruptions sufficient to permit the loss of plasticity between successive increments.

**1905.10 Depositing.** The depositing of concrete shall comply with the provisions of Sections 1905.10.1 through 1905.10.8.

**1905.10.1 Segregation.** Concrete shall be deposited as nearly as practicable to its final position to avoid segregation due to rehandling or flowing.

**1905.10.2 Placement timing.** Concreting operations shall be carried on at such a rate that the concrete is at all times plastic and flows readily into spaces between reinforcement.

**1905.10.3 Unacceptable concrete.** Concrete that has partially hardened or been contaminated by foreign materials shall not be deposited in the structure.

**1905.10.4 Retempering.** Retempered concrete or concrete that has been remixed after initial set shall not be used unless approved by the registered design professional.

**1905.10.5 Continuous operation.** After concreting has started, it shall be carried on as a continuous operation until placing of a panel or section, as defined by its boundaries or predetermined joints, is completed, except as permitted or prohibited by Section 1906.8.

**1905.10.6 Placement in vertical lifts.** The top surfaces of vertically formed lifts shall be generally level.

**1905.10.7 Construction joints.** When construction joints are required, they shall be made in accordance with Section 1906.8.

**1905.10.8 Consolidation.** Concrete shall be thoroughly consolidated by suitable means during placement and shall be thoroughly worked around reinforcement and embedded fixtures and into corners of the forms.

**1905.11 Curing.** The curing of concrete shall be in accordance with Sections 1905.11.1 through 1905.11.3.

**1905.11.1 Regular.** Concrete (other than high early strength) shall be maintained above 50°F (10°C) and in a moist condition for at least the first seven days after placement, except when cured in accordance with Section 1905.11.3.

**1905.11.2 High-early-strength.** High-early-strength concrete shall be maintained above 50°F (10°C) and in a moist condition for at least the first three days, except when cured in accordance with Section 1905.11.3.

**1905.11.3 Accelerated curing.** Accelerated curing of concrete shall comply with ACI 318, Section 5.11.3.

**1905.12 Cold weather requirements.** Concrete that is to be placed during freezing or near-freezing weather shall comply with the following:

- 1. Adequate equipment shall be provided for heating concrete materials and protecting concrete during freezing or near-freezing weather.**
- 2. Concrete materials and reinforcement, forms, fillers and ground with which concrete is to in contact shall be free from frost.**
- 3. Frozen materials or materials containing ice shall not be used.**

**1905.13 Hot weather requirements.** During hot weather, proper attention shall be given to ingredients, production methods, handling, placing, protection and curing to prevent



excessive concrete temperatures or water evaporation that could impair the required strength or serviceability of the member or structure.

## **SECTION BC 1906** **FORMWORK, EMBEDDED PIPES AND CONSTRUCTION JOINTS**

**1906.1 General requirements.** The design, fabrication and erection of forms shall comply with the requirements of section 1906.1.1 through 1906.1.6.

**1906.1.1 Safe support of loads.** Formwork, including all related braces, shoring, framing, and auxiliary construction shall be proportioned, erected, supported, braced, and maintained so that it will safely support all vertical and lateral loads that might be applied until such loads can be supported by the permanent construction.

**1906.1.2 Vertical and lateral loads.** Vertical and lateral loads shall be carried to the ground by the formwork system, by the new construction after it has attained adequate strength for that purpose, or by existing structures. Forms and their supports shall be designed so as not to damage previously placed structures.

**1906.1.3 Bracing.** Forms shall be properly braced or tied together so as to maintain position and shape, and shall conform to the sizes and shapes of members as shown on the design drawings.

**1906.1.4 Ramps, runways, and platforms.** Ramps, runways, and platforms shall meet the requirements of Section 3315.

**1906.1.5 Design.** Design of formwork shall comply with ACI 318, Section 6.1.5.

**1906.1.6 Forms for pre-stressed and post-tensioned concrete.** Forms for pre-stressed and post-tensioned concrete members shall be designed and constructed to permit movement of the member without damage during application of the prestressing force.

**1906.2 Inspection.** Formwork, including shores, reshores, braces, and other supports, shall be inspected prior to placement of reinforcing steel to verify that the sizes of the concrete members that are being formed conform to the construction documents and form design drawings. Such inspections shall be performed by a qualified person designated by the contractor. Subsequently, inspections shall be performed by such person periodically during the placement of concrete. During and after concreting, the elevations, camber, and vertical alignment of formwork systems shall be inspected using tell-tale devices. A record of all such inspections shall be kept at the site available to the commissioner. The names of the persons responsible for such inspections and the foreman in charge of the formwork shall be posted in the field office.

**1906.3 Design of concrete formwork.** Wherever the shore height exceeds 14 feet (4267 mm) or the total load on the forms exceeds 150 pounds per square foot (732 kg/m<sup>2</sup>), or wherever power buggies or two-stage shores are used, the forms, including shoring

foundation, shall be designed by a registered design professional and shall be constructed in conformance with such design. A copy of the design drawings and any construction drawings and specifications shall be kept on the job site available to the commissioner.

**1906.3.1 Vertical loads.** Vertical loads shall include the total dead and live loads. Dead load shall include the weight of the formwork plus the weight of the reinforcement and fresh concrete. Live load shall allow for the weight of the workers and equipment, with allowance for impact, but in no case shall be less than 20 pounds per square foot (98 kg/m<sup>2</sup>).

**1906.3.2 Lateral concrete pressure.** Design of forms, ties, and bracing shall satisfy the minimum lateral pressures of fresh concrete specified in Table 1906.3.2.

**TABLE 1906.3.2**  
**MINIMUM LATERAL PRESSURES TO BE ASSUMED FOR FRESH**  
**CONCRETE WEIGHING 150 POUNDS PER CUBIC FOOT**  
**(Table 1906.3.2 attached to end of document)**

**1906.3.3 External lateral loads.** Braces and shores shall be designed to resist all external lateral loads including but not limited to wind, cable tensions, inclined supports, dumping of concrete, and starting and stopping of equipment. In no case shall the assumed value of lateral load due to wind, dumping of concrete, and equipment acting in any direction at each floorline be less than 100 plf edge or 2 percent of total dead load of the floor, whichever is greater. Except for foundation walls that are poured against a rigid backing, wall forms shall be designed for a minimum lateral load of 10 pounds per square foot (49 kg/m<sup>2</sup>), and bracing for wall forms shall be designed for a lateral load of at least 100 plf of wall, applied at the top. The lateral load acting on walls greater than 14 feet (4267 mm) high shall be determined by analysis of conditions applicable to the site and building.

**1906.3.4 Special loads.** The formwork shall be designed for any special conditions of construction likely to occur, such as unsymmetrical placement of concrete, impact of machine-delivered concrete, uplift, and concentrated loads.

**1906.3.5 Shoring and bracing.** Shoring and bracing shall comply with sections 1906.3.5.1 through 1906.3.5.4.

**1906.3.5.1 Approval.** When patented or commercial devices that are not susceptible to design are used for shoring, bracing, or splicing, they shall be approved by the commissioner.

**1906.3.5.2 Splices.** Splices shall develop the full strength of the spliced members.

**1906.3.5.3 Bracing.** Where shore height exceeds 10 feet (3048 mm), or when necessary to provide structural stability, diagonal bracing shall be provided. Struts, anchored into masonry or to panel joints of adjacent braced bays, may be

used to prevent buckling of individual members not supported by the diagonal bracing; but, bracing an entire tier of shores with struts without diagonal bracing shall be prohibited unless the system can be demonstrated to be braced by other rigid construction.

**1906.3.5.4 Unbraced length of shores.** The unbraced length of shores shall not exceed the maximum length determined in accordance with the requirements of this code for the structural material used.

**1906.3.6 Foundations.** Foundations for shores more than 10 feet (3048 mm) high and supported on the ground shall be designed by a registered design professional.

**1906.3.7 Settlement.** Formwork shall be so constructed that vertical adjustments can be made to compensate for take-up and settlements. Wedges, jacks, or other positive means shall be provided for this purpose.

**1906.3.8 Structural ramps, runways and platforms** Structural runways, ramps, and platforms shall comply with Section 3315 in addition to the requirements of Section 1906.3.

**1906.4 Construction.** Construction of concrete formwork shall comply with the requirements of Section 1906.4.1 through 1906.4.4.

**1906.4.1 Field constructed lap splices.** Field constructed lap splices, other than approved devices, shall not be used more often than for every other shore under slabs or for every third shore under beams, and shall develop the full strength of the members. Such spliced shores shall be uniformly distributed throughout the work. Splices shall not be located near the midheight of the shores unless lateral support is provided, nor midway between points of lateral support.

**1906.4.2 Vertical shores.** Vertical shores for multifloor forms shall be set plumb and in alignment with lower tiers so that loads from upper tiers are transferred directly to the lower tiers, or adequate transfer members shall be provided. Provision shall be made to transfer the lateral loads to the ground or to completed construction of adequate strength. Vertical shores shall be so erected that they cannot tilt, and shall have firm bearing. Inclined shores and the bearing ends of all shores shall be braced against slipping or sliding. The bearing surfaces shall be cut square and have a tight fit at splices.

**1906.4.3 Runways.** Runways for moving equipment shall be provided with struts or legs as required, and shall be supported directly on the formwork or structural member and not on the reinforcement.

**1906.4.4 Unsafe conditions.** Any unsafe condition or necessary adjustment revealed by inspection shall be remedied immediately. If, during construction, any weakness develops and the formwork shows any undue settlement or distortion, the work shall

be stopped, the affected construction removed if permanently damaged, and the formwork strengthened.

**1906.5 Removal of forms and shoring.** The removal of forms and shoring shall comply with the requirements of Section 1906.5.1 through 1906.5.6.

**1906.5.1 Removal schedule.** Before starting construction, the contractor shall develop a procedure and schedule for removal of shores and installation of reshores and for calculating the loads transferred to the structure during the process.

**1906.5.1.1 Data and analysis.** The structural analysis and concrete strength data used in planning and implementing form removal and reshoring shall be furnished by the registered design professional responsible for the removal schedule to the commissioner when so requested.

**1906.5.1.2 Support and removal.** No construction loads shall be supported on, nor any shoring removed from, any part of the structure under construction except when that portion of the structure in combination with the remaining forming and shoring system has sufficient strength to support safely its weight and the loads placed thereon.

**1906.5.1.3 Concrete strength.** Sufficient strength shall be demonstrated by structural analysis of the proposed loads, the strength of the forming and shoring system, and concrete strength data. Concrete strength data shall be based on tests of field-cured cylinders or, when approved by the commissioner, on other procedures for evaluating concrete strength.

**1906.5.2 Construction loads.** No construction loads exceeding the combination of superimposed dead load plus specified live load shall be supported on any unshored portion of the structure under construction, unless analysis indicates adequate strength to support such additional loads.

**1906.5.3 Prestressed members.** Form supports for prestressed concrete members shall not be removed until sufficient prestressing has been applied to prestressed members to carry their dead load and anticipated construction loads.

**1906.5.4 Manner of removal.** Forms shall be removed in such a manner as to assure the complete safety of the structure and workers.

**1906.5.5 Shores support.** Where the structure as a whole is supported on shores, beam and girder sides, columns, and similar vertical forms may be removed after the concrete is sufficiently hard to withstand damage from the removal. In no case shall the supporting forms or shoring be removed until the members have acquired sufficient strength to support safely their weight and the load thereon.

**1906.5.6 Control tests and alternate methods.** The results of control tests, including concrete cylinder specimens prepared in accordance with ANSI/ASTM C31, 2003a, cast-in-place cores, or other device that will produce test specimens representative of the condition of the concrete in place, of suitable size and proportions, and approved by the registered design professional of record shall be evidence that the concrete has attained sufficient strength or the strength as may be specified on the drawings. The contractor may submit alternate methods of stripping, reshoring, and strength control for approval by the registered design professional of record, subject to review by the commissioner.

**1906.6 Reshoring.** Reshoring shall be provided to support the construction where forms and shores are stripped before the concrete has attained sufficient strength to support the superimposed loads due to construction above. Reshoring shall comply with Section 1906.6.1 through 1906.6.7.

**1906.6.1 Reshores limitations.** Reshores shall comply with the requirements of section 1906.6.1.1 through 1906.6.1.7.

**1906.6.1.1 Secureness of reshores.** Reshores of wood or metal shall be screw adjusted or jacked and locked and wedged to make them secure. Reshores shall not be jacked or screwed so tight that they preload the floor below or remove the normal deflection of the slab above.

**1906.6.1.2 Reshores in proximity to facades.** Reshores within 10 feet (3048 mm) of the facade of a building shall be secured to prevent them from falling off the building.

**1906.6.1.3 Wedges.** Wedges shall not be used within 10 feet (3048 mm) of the facade or at such other locations as determined by the commissioner.

**1906.6.1.4 Stresses.** In no case shall shores be so located as to alter the pattern of stresses determined in the original structural analysis or to induce tensile stresses where reinforcing bars are not provided.

**1906.6.1.5 Angle to surface.** Reshores shall be perpendicular to the surface that they are supporting.

**1906.6.1.6 Adjusting devices.** Adjusting devices shall not be used if heavily rusted, bent, dented, rewelded or having broken weldments or other defects.

**1906.6.1.7 Metal shoring and accessory parts.** Metal shoring and accessory parts shall be fully operative when in use.

**1906.6.2 Site safety provisions.** Reshoring shall comply with all of the requirements of Chapter 33 regarding safeguards during construction and the requirements of Sections 1906.6.2.1 through 1906.6.2.3.

**1906.6.2.1 Emergency.** Extra shores or material and equipment that might be needed in an emergency shall be furnished.

**1906.6.2.2 Stripping.** Care shall be taken while stripping is underway to insure that material does not fall off the building.

**1906.6.2.3 Building materials.** Building materials shall be properly piled and tied or contained.

**1906.6.3 Bracing.** Lateral bracing shall be provided during reshoring operations, and reshores shall be located as close as practical to the same position on each floor to provide continuous support from floor to floor.

**1906.6.4 Reshoring beam and girder construction.** Where reshoring of beam and girder construction is required, the forms shall not be removed from more than one girder at a time, and the girder shall be reshored before any other supports are removed. After the supporting girders are reshored, the form shall be removed from one beam with its adjacent slabs and the beam shall be reshored before any other supports are removed. Slabs spanning 10 feet (3048 mm) or more shall be reshored along the center line of the span.

**1906.6.5 Reshoring flat slabs.** Where reshoring of flat slab construction is required, the formwork cannot be stripped until the concrete has acquired sufficient strength to safely support its weight and the load thereon, or temporary reshores are provided supporting the slab at intervals of no more than 8 feet (2438 mm) on center to be replaced by reshores prior to placing concrete on the floor above. Reshores must be installed and remain in place until the concrete reaches full or sufficient strength to sustain the superimposed loads to which the concrete will be subjected.

**1906.6.6 Stripping operation.** Waste debris as a result of stripping operations shall be immediately contained and removed at reasonable intervals. Stripping operations on concrete structures shall not be performed more than three stories below the story being formed.

**1906.6.7 Prestressed construction.** Solid safety shields shall be provided at end anchorages of prestressing beds, or where necessary, for protection against breakage of prestressing strands, cables, or other assemblies during prestressing or casting operations.

**1906.7 Conduits and pipes embedded in concrete.** Conduits, pipes and sleeves of any material not harmful to concrete and within the limitations of ACI 318, Section 6.3, are permitted to be embedded in concrete with approval of the registered design professional of record.

**1906.8 Construction joints.** Construction joints shall comply with the provisions of

Sections 1906.8.1 through 1906.8.6.

**1906.8.1 Surface cleaning.** The surface of concrete construction joints shall be cleaned and laitance removed.

**1906.8.2 Joint treatment.** Immediately before new concrete is placed, construction joints shall be wetted and standing water removed.

**1906.8.3 Location for force transfer.** Construction joints shall be so made and located as not to impair the strength of the structure. Provision shall be made for the transfer of shear and other forces through construction joints in accordance with ACI 318, Section 11.7.9.

**1906.8.4 Location in slabs, beams and girders.** Construction joints in floors shall be located within the middle third of spans of slabs, beams and girders. Joints in girders shall be offset a minimum distance of two times the width of intersecting beams.

**1906.8.5 Vertical support.** Beams, girders or slabs supported by columns or walls shall not be cast or erected until concrete in the vertical support members is no longer plastic.

**1906.8.6 Monolithic placement.** Beams, girders, haunches, drop panels and capitals shall be placed monolithically as part of a slab system, unless otherwise shown in the design drawings or specifications.

## **SECTION BC 1907** **DETAILS OF REINFORCEMENT**

**1907.1 Hooks.** Standard hooks on reinforcing bars used in concrete construction shall comply with ACI 318, Section 7.1.

**1907.2 Minimum bend diameters.** Minimum reinforcement bend diameters utilized in concrete construction shall comply with ACI 318, Section 7.2.

**1907.3 Bending.** The bending of reinforcement shall comply with Sections 1907.3.1 and 1907.3.2.

**1907.3.1 Cold bending.** Reinforcement shall be bent cold, unless otherwise permitted by the registered design professional of record.

**1907.3.2 Embedded reinforcement.** Reinforcement partially embedded in concrete shall not be field bent, except as shown on the construction documents or permitted by the registered design professional of record.

**1907.4 Surface conditions of reinforcement.** The surface conditions of reinforcement shall comply with the provisions of Sections 1907.4.1 through 1907.4.3.

**1907.4.1 Coatings.** At the time concrete is placed, reinforcement shall be free from mud, oil or other nonmetallic coatings that decrease bond. Epoxy coatings of steel reinforcement in accordance with ACI 318, Sections 3.5.3.7 and 3.5.3.8, are permitted.

**1907.4.2 Rust or mill scale.** Except for prestressing steel, steel reinforcement with rust, mill scale or a combination of both, shall be permitted, provided the minimum dimensions, including height of deformations and weight of a hand-wire-brushed test specimen, comply with applicable ASTM specifications specified in Section 1903.5.

**1907.4.3 Prestressing steel.** Prestressing steel shall be clean and free of oil, dirt, scale, pitting and excessive rust. A light coating of rust is permitted.

**1907.5 Placing reinforcement.** The placement of concrete reinforcement shall comply with the provisions of Sections 1907.5.1 through 1907.5.4.

**1907.5.1 Support.** Reinforcement, including tendons, and posttensioning ducts shall be accurately placed and adequately supported before concrete is placed, and shall be secured against displacement within tolerances permitted in Section 1907.5.2. Where approved by the registered design professional of record, embedded items (such as dowels or inserts) that either protrude from precast concrete members or remain exposed for inspection are permitted to be embedded while the concrete is in a plastic state, provided the following conditions are met:

1. Embedded items are maintained in the correct position while the concrete remains plastic.
2. The concrete is properly consolidated around the embedded item. Embedded items are not required to be hooked or tied to reinforcement within the concrete.

**1907.5.2 Tolerances.** Unless otherwise specified by the registered design professional of record, reinforcement, including tendons, and posttensioning ducts shall be placed within the tolerances specified in Sections 1907.5.2.1 and 1907.5.2.2.

**1907.5.2.1 Depth and cover.** Tolerance for depth,  $d$ , and minimum concrete cover in flexural members, walls and compression members shall be as shown in Table 1907.5.2.1, except that tolerance for the clear distance to formed soffits shall be minus  $\frac{1}{4}$  inch (6.4 mm) and tolerance for cover shall not exceed minus one-third the minimum concrete cover required in the design drawings or specifications.

**TABLE 1907.5.2.1**  
**TOLERANCES**

**(Table 1907.5.2.1 attached to end of document)**



**1907.5.2.2 Bends and ends.** Tolerance for longitudinal location of bends and ends of reinforcement shall be  $\pm 2$  inches ( $\pm 51$  mm) except the tolerance shall be  $\pm \frac{1}{2}$  inch ( $\pm 12.7$  mm) at the discontinuous ends of brackets and corbels, and  $\pm 1$  inch (25 mm) at the discontinuous ends of other members. The tolerance for minimum concrete cover of Section 1907.5.2.1 shall also apply at discontinuous ends of members.

**1907.5.3 Welded wire fabric.** Welded wire fabric with wire size not greater than W5 or D5 used in slabs not exceeding 10 feet (3048 mm) in span is permitted to be curved from a point near the top of the slab over the support to a point near the bottom of the slab at midspan, provided such reinforcement is either continuous over, or securely anchored at support.

**1907.5.4 Welding.** Welding of crossing bars shall not be permitted for assembly of reinforcement unless authorized by the registered design professional of record.

**1907.6 Spacing limits for reinforcement.** The clear distance between reinforcing bars, bundled bars, tendons and ducts shall comply with ACI 318, Section 7.6.

**1907.7 Concrete protection for reinforcement.** The minimum concrete cover for reinforcement shall comply with Sections 1907.7.1 through 1907.7.7.

**1907.7.1 Cast-in-place concrete (nonprestressed).** Minimum concrete cover shall be provided for reinforcement in nonprestressed, cast-in-place concrete construction in accordance with Table 1907.7.1, but shall not be less than required by Sections 1907.7.5 and 1907.7.7.

**TABLE 1907.7.1**  
**MINIMUM CONCRETE COVER**  
**(Table 1907.7.1 attached to end of document)**

**1907.7.2 Cast-in-place concrete (prestressed).** The minimum concrete cover for prestressed and nonprestressed reinforcement, ducts and end fittings in cast-in-place prestressed concrete shall comply with ACI 318, Section 7.7.2.

**1907.7.3 Precast concrete (manufactured under plant control conditions).** The minimum concrete cover for prestressed and nonprestressed reinforcement, ducts and end fittings in precast concrete manufactured under plant control conditions shall comply with ACI 318, Section 7.7.3.

**1907.7.4 Bundled bars.** The minimum concrete cover for bundled bars shall comply with ACI 318, Section 7.7.4.

**1907.7.5 Corrosive environments.** In corrosive environments or other severe exposure conditions, prestressed and nonprestressed reinforcement shall be provided

with additional protection in accordance with ACI 318, Section 7.7.5.

**1907.7.6 Future extensions.** Exposed reinforcement, inserts and plates intended for bonding with future extensions shall be protected from corrosion.

**1907.7.7 Fire protection.** When this code requires a thickness of cover for fire protection greater than the minimum concrete cover specified in Section 1907.7, such greater thickness shall be used.

**1907.8 Special reinforcement details for columns.** Offset bent longitudinal bars in columns and load transfer in structural steel cores of composite compression members shall comply with the provisions of ACI 318, Section 7.8.

**1907.9 Connections.** Connections between concrete framing members shall comply with the provisions of ACI 318, Section 7.9.

**1907.10 Lateral reinforcement for compression members.** Lateral reinforcement for compression members shall comply with the provisions of ACI 318, Section 7.10.

**1907.11 Lateral reinforcement for flexural members.** Lateral reinforcement for compression reinforcement in flexural members shall comply with the provisions of ACI 318, Section 7.11.

**1907.12 Shrinkage and temperature reinforcement.** Reinforcement for shrinkage and temperature stresses in concrete members shall comply with the provisions of ACI 318, Section 7.12.

**1907.13 Requirements for structural integrity.** The detailing of reinforcement and connections between concrete members shall comply with the provisions of ACI 318, Section 7.13.

## **SECTION BC 1908** **MODIFICATIONS TO ACI 318**

**1908.1 General.** The text of ACI 318 shall be modified as indicated in Sections 1908.1.1 through 1908.1. 7.

**1908.1.1 ACI 318, Section 21.1.** Modify existing definitions and add the following definitions to ACI 318, Section 21.1.

**DESIGN DISPLACEMENT.** Total lateral displacement expected for the design-basis earthquake, as specified by Section 9.5.5.7 of ASCE 7 or 1617.5.4 of this code.

**STORY DRIFT RATIO.** The design displacement over a story divided by the story height.

**WALL PIER.** A wall segment with a horizontal length-to-thickness ratio of at least

2.5, but not exceeding six, whose clear height is at least two times its horizontal length.

**1908.1.2 ACI 318, Section 21.2.1.** Modify Sections 21.2.1.2, 21.2.1.3 and 21.2.1.4 to read as follows:

21.2.1.2 For structures assigned to Seismic Design Category B, provisions of Chapters 1 through 18 and 22 shall apply except as modified by the provisions of this chapter. Where the seismic design loads are computed using provisions for intermediate or special concrete systems, the requirements of Chapter 21 for intermediate or special systems, as applicable, shall be satisfied.

21.2.1.3 For structures assigned to Seismic Design Category C, intermediate or special moment frames, or ordinary or special reinforced concrete structural walls shall be used to resist seismic forces induced by earthquake motions. Where the design seismic loads are computed using provisions for special concrete systems, the requirements of Chapter 21 for special systems, as applicable, shall be satisfied.

21.2.1.4 For structures assigned to Seismic Design Category D, E or F, special moment frames, special reinforced concrete structural walls, diaphragms and trusses and foundations complying with Sections 21.2 through 21.10 shall be used to resist forces induced by earthquake motions when special systems are required. Intermediate moment frames and ordinary reinforced concrete walls, where allowed, shall comply with Chapter 21. Frame members not proportioned to resist earthquake forces shall comply with Section 21.11.

**1908.1.3 ACI 318, Section 21.2.5.** Modify ACI 318, Section 21.2.5, by renumbering as Section 21.2.5.1 and adding new Sections 21.2.5.2, 21.2.5.3 and 21.2.5.4 to read as follows:

21.2.5 Reinforcement in members resisting earthquake-induced forces.

21.2.5.1 Except as permitted in Sections 21.2.5.2 through 21.2.5.4, reinforcement resisting earthquake-induced flexural and axial forces in frame members and in structural wall boundary elements shall comply with ASTM A 706. ASTM 615, Grades 40 and 60 reinforcement, shall be permitted in these members if (a) the actual yield strength based on mill tests does not exceed the specified yield strength by more than 18,000 psi (retests shall not exceed this value by more than an additional 3,000 psi), and (b) the ratio of the actual ultimate tensile strength to the actual tensile yield strength is not less than 1.25.

21.2.5.2 Prestressing steel shall be permitted in flexural members of frames, provided the average prestress,  $f_{pc}$ , calculated for an area equal to the member's shortest cross-sectional dimension multiplied by the perpendicular dimension shall be the lesser of 700 psi (4.83MPa) or  $f'_c/6$  at locations of nonlinear action

where prestressing steel is used in members of frames.

21.2.5.3 Unless the seismic-force-resisting frame is qualified for use through structural testing as required by the ACI Provisional Standard ITG/T1.1, for members in which prestressing steel is used together with mild reinforcement to resist earthquake-induced forces, prestressing steel shall not provide more than one-quarter of the strength for either positive or negative moments at the nonlinear action location and shall be anchored at the exterior face of the joint or beyond.

21.2.5.4 Anchorages for tendons must be demonstrated to perform satisfactorily for seismic loadings. Anchorage assemblies shall withstand, without failure, a minimum of 50 cycles of loading ranging between 40 and 85 percent of the minimum specified tensile strength of the prestressing steel.

**1908.1.4 ACI 318, Section 21.7.** Modify ACI 318, Section 21.7, by adding a new Section 21.7.10 to read as follows:

21.7.10 Wall piers and wall segments.

21.7.10.1 Wall piers not designed as a part of a special moment frame shall have transverse reinforcement designed to satisfy the requirements in Section 21.7.10.2.

**Exceptions:**

1. Wall piers that satisfy Section 21.11.
2. Wall piers along a wall line within a story where other shear wall segments provide lateral support to the wall piers, and such segments have a total stiffness of at least six times the sum of the stiffness of all the wall piers.

21.7.10.2 Transverse reinforcement shall be designed to resist the shear forces determined from Sections 21.3.4.2 and 21.4.5.1. Where the axial compressive force, including earthquake effects, is less than  $A_g f'_c / 20$ , transverse reinforcement in wall piers is permitted to have standard hooks at each end in lieu of hoops. Spacing of transverse reinforcement shall not exceed 6 inches (152 mm). Transverse reinforcement shall be extended beyond the pier clear height for at least the development length of the largest longitudinal reinforcement in the wall pier.

21.7.10.3 Wall segments with a horizontal length-to-thickness ratio less than 2.5 shall be designed as columns.

**1908.1.5 ACI 318, Section 21.10.1.1.** Modify ACI 318, Section 21.10.1.1, to read as

follows:

21.10.1.1 Foundations resisting earthquake-induced forces or transferring earthquake-induced forces between a structure and the ground shall comply with the requirements of Section 21.10 and other applicable provisions of ACI 318 unless modified by Chapter 18 of this code.

**1908.1.6 ACI 318, Section 21.11.** Modify ACI Sections 21.11.1 and 21.11.2.2 and add Sections 21.11.5 through 21.11.7 as follows:

21.11.1 Frame members assumed not to contribute to lateral resistance shall be detailed according to Section 21.11.2 or 21.11.3 depending on the magnitude of moments induced in those members when subjected to the design displacement. If effects of design displacements are not explicitly checked, it shall be permitted to apply the requirements of Section 21.11.3. Slab-column connections shall comply with Sections 21.11.5 through 21.11.7. Conformance to Section 21.11 satisfies the deformation compatibility requirements of Section 9.5.2.2.4.3 of ASCE 7.

21.11.2.2 Members with factored gravity axial forces exceeding  $(A_g f'_c / 10)$  shall satisfy Sections 21.4.3, 21.4.4.1(c), 21.4.4.3 and 21.4.5. The maximum longitudinal spacing of ties shall be,  $S_o$ , for the full column height. The spacing,  $S_o$ , shall not be more than six diameters of the smallest longitudinal bar enclosed or 6 inches (152 mm), whichever is smaller. Lap splices of longitudinal reinforcement in such members need not satisfy Section 21.4.3.2 in structures where the seismic force-resisting system does not include special moment frames.

21.11.5 Reinforcement to resist punching shear shall be provided in accordance with Sections 21.11.5.1 and 21.11.5.2 at slab column connections where story drift ratio exceeds  $[0.035 - 0.05 (V_u / \Phi V_c)]$  except that Sections 21.11.5.1 and 21.11.5.2 need not be satisfied where  $V_u / \Phi V_c$  is less than 0.2 or where the story drift ratio is less than 0.005.  $V_u$  equals the factored punching shear from gravity load excluding shear stress from unbalanced moment.  $V_u$  is calculated for the load combination  $1.2D + 1.0L + 0.2S$ . The load factor on  $L$  is permitted to be reduced to 0.5 in accordance with Section 9.2.1(a). In no case shall shear reinforcement be less than that required in Section 11.12 for loads without consideration of seismic effects.

21.11.5.1 — The slab shear reinforcement shall provide  $V_s$  not less than  $3.5 \sqrt{f'_c}$ .

21.11.5.2 — Slab shear reinforcement shall extend not less than five times the slab thickness from the face of column.

21.11.6 — Bottom bars or wires within the column strip shall conform to Section 13.3.8.5 except that splices shall be Class B.

21.11.7—Within the effective slab width defined in Section 13.5.3.2, the ratio of

nonprestressed bottom reinforcement to gross concrete area shall not be less than 0.004. Where bottom reinforcement is not required to be continuous, such reinforcement shall extend a minimum of five times the slab thickness plus one development length beyond the face of the column or terminated at the slab edge with a standard hook.

**1908.1.7 ACI 318, Section 21.13.2.** Modify ACI 318, Section 21.13.2, to read as follows:

21.13.2 In connections between wall panels, or between wall panels and the foundation, yielding shall be restricted to reinforcement.

**1908.2 General.** The text of ACI 318 shall be modified as indicated in Sections 1908.2.1 through 1908.2.4.

**1908.2.1 ACI 318, Section 10.15.** Modify ACI 318 by adding Section 10.15.4 to read as follows:

10.15.4 When the specified compressive strength of concrete in a column is greater than 1.4 times that specified for a floor system, the following additional requirements shall be adhered to:

1. All of the design provisions of Section 10.15 (unmodified) are adhered to.
2. The concrete construction is supervised and inspected continuously by a full-time professional engineer responsible for the concrete placement special inspection. Such professional engineer shall not delegate this responsibility to any subordinates.

**1908.2.2 ACI 318, Section 16.3.** Modify ACI 318 by adding Section 16.3.3 to read as follows:

16.3.3 - Lifting devices shall have a capacity sufficient to support four times the appropriate portion of the member's dead weight. The inclination of the lifting force shall be considered.

**1908.2.3 ACI 318, Section 21.12.3.** Modify ACI 318, Section 21.12.3 to read as follows:

21.12.3 Design shear strength of beams and columns resisting earthquake effect shall not be less than either 1 or 2:

1. The sum of the shear associated with development of nominal moment strengths of the member at each restrained end of the clear span and the shear calculated for factored gravity loads;

2. The maximum shear obtained from design load combinations that include earthquake effect E, with E assumed to be twice that prescribed by this code for earthquake-resistant design.

**1908.2.4 ACI 318, Section 21.12.6.8.** Modify ACI 318, Section 21.12.6.8 to read as follows:

21.12.6.8 At the critical sections for columns defined in 11.12.1.2, two-way shear caused by factored gravity loads shall not exceed  $0.4\phi V_c$ , where  $V_c$  shall be calculated as defined in 11.12.2.1. for nonprestressed slabs and in 11.12.2.2. for prestressed slabs. For slabs with shear reinforcing, it shall be permitted to waive this requirement if the contribution of the earthquake-induced factored two way shear stress transferred by eccentricity of shear in accordance with 11.12.6.1 and 11.12.6.2 at the point of maximum stress does not exceed one-half of the stress  $\phi V_n$  permitted by 11.12.6.2.

## **SECTION BC 1909** **STRUCTURAL PLAIN CONCRETE**

**1909.1 Scope.** The design and construction of structural plain concrete, both cast-in-place and precast, shall comply with the minimum requirements of Section 1909 and ACI 318, Chapter 22.

**1909.1.1 Special structures.** For special structures, such as arches, underground utility structures, gravity walls and shielding walls, the provisions of Section 1909 shall govern where applicable.

**1909.2 Limitations.** The use of structural plain concrete columns and structural plain concrete footings on piles is not permitted. In addition to the limitations set forth in Section 1910 of this chapter, the use of structural plain concrete shall otherwise be limited to:

1. Members that are continuously supported by soil, such as walls and footings, or by other structural members capable of providing continuous vertical support.
2. Members for which arch action provides compression under all conditions of loading.
3. Walls and pedestals.

**1909.3 Joints.** Contraction or isolation joints shall be provided to divide structural plain concrete members into flexurally discontinuous elements in accordance with ACI 318, Section 22.3.

**1909.4 Design.** Structural plain concrete walls, footings and pedestals shall be designed for adequate strength in accordance with ACI 318, Sections 22.4 through 22.8.

**Exception:** For Group R-3 occupancies and buildings of other occupancies less than two stories in height of light-frame construction, the required edge thickness of ACI 318 is permitted to be reduced to 6 inches (152 mm), provided that the footing does not extend more than 4 inches (102 mm) on either side of the supported wall.

**1909.5 Precast members.** The design, fabrication, transportation and erection of precast, structural plain concrete elements shall be in accordance with ACI 318, Section 22.9.

**1909.6 Walls.** In addition to the requirements of this section, structural plain concrete walls shall comply with the applicable requirements of ACI 318, Chapter 22.

**1909.6.1 Basement walls.** The thickness of exterior basement walls and foundation walls shall be not less than 7½ inches (191 mm). Structural plain concrete exterior basement walls shall be exempt from the requirements for special exposure conditions of Section 1904.2.2.

**1909.6.2 Other walls.** Except as provided in Section 1909.6.1, the thickness of bearing walls shall be not less than  $\frac{1}{24}$  the unsupported height or length, whichever is shorter, but not less than 5½ inches (140 mm).

**1909.6.3 Openings in walls.** Not less than two No. 5 bars shall be provided around window and door openings. Such bars shall extend at least 24 inches (610 mm) beyond the corners of openings.

## **SECTION BC 1910** **SEISMIC DESIGN PROVISIONS**

**1910.1 General.** The design and construction of concrete components that resist seismic forces shall conform to the requirements of this section and to ACI 318 as modified by Section 1908.

**1910.2 Classification of shear walls.** Structural concrete shear walls that resist seismic forces shall be classified in accordance with Sections 1910.2.1 through 1910.2.4.

**1910.2.1 Ordinary plain concrete shear walls.** Ordinary plain concrete shear walls are walls conforming to the requirements of Chapter 22 of ACI 318.

**1910.2.2 Detailed plain concrete shear walls.** Detailed plain concrete shear walls are walls conforming to the requirements for ordinary plain concrete shear walls and shall have reinforcement as follows: Vertical reinforcement of at least 0.20 square inch (129 mm<sup>2</sup>) in cross-sectional area shall be provided continuously from support to support at each corner, at each side of each opening and at the ends of walls. The continuous vertical bar required beside an opening is permitted to substitute for one of the two No. 5 bars required by Section 22.6.6.5 of ACI 318. Horizontal reinforcement at least 0.20 square inch (129 mm<sup>2</sup>) in cross-sectional area shall be



provided:

1. Continuously at structurally connected roof and floor levels and at the top of walls;
2. At the bottom of load-bearing walls or in the top of foundations where doweled to the wall; and
3. At a maximum spacing of 120 inches (3048 mm).

Reinforcement at the top and bottom of openings, where used in determining the maximum spacing specified in Item 3 above, shall be continuous in the wall.

**1910.2.3 Ordinary reinforced concrete shear walls.** Ordinary reinforced concrete shear walls are walls conforming to the requirements of ACI 318 for ordinary reinforced concrete structural walls.

**1910.2.4 Special reinforced concrete shear walls.** Special reinforced concrete shear walls are walls conforming to the requirements of ACI 318 for special reinforced concrete structural walls or special precast structural walls.

**1910.3 Seismic Design Category B.** Structures assigned to Seismic Design Category B, as determined in accordance with Section 1616, shall conform to the requirements for Seismic Design Category A and to the additional requirements for Seismic Design Category B of this section.

**1910.3.1 Ordinary moment frames.** In flexural members of ordinary moment frames forming part of the seismic-force-resisting system, at least two main flexural reinforcing bars shall be provided continuously top and bottom throughout the beams, through or developed within exterior columns or boundary elements.

**1910.3.1.1 Shear.** Columns of ordinary moment frames having a clear height-to-maximum-plan-dimension ratio of five or less shall be designed for shear in accordance with Section 21.12.3 of ACI 318.

**1910.4 Seismic Design Category C.** Structures assigned to Seismic Design Category C, as determined in accordance with Section 1616, shall conform to the requirements for Seismic Design Category B and to the additional requirements for Seismic Design Category C of this section.

**1910.4.1 Seismic-force-resisting systems.** Moment frames used to resist seismic forces shall be intermediate moment frames or special moment frames. Shear walls used to resist seismic forces shall be ordinary reinforced concrete shear walls or special reinforced concrete shear walls. Ordinary reinforced concrete shear walls constructed of precast concrete elements shall comply with the additional requirements of Section 21.13 of ACI 318 for intermediate precast concrete structural

walls, as modified by Section 1908.1.7.

**1910.4.2 Discontinuous members.** Columns supporting reactions from discontinuous stiff members, such as walls, shall be designed for the special load combinations in Section 1605.4 and shall be provided with transverse reinforcement at the spacing,  $S_o$ , as defined in Section 21.12.5.2 of ACI 318 over their full height beneath the level at which the discontinuity occurs. This transverse reinforcement shall be extended above and below the column as required in Section 21.4.4.5 of ACI 318.

**1910.4.3 Plain concrete.** Structural plain concrete members in structures assigned to Seismic Design Category C shall conform to ACI 318 and with Sections 1910.4.3.1 through 1910.4.3.3.

**1910.4.3.1 Walls.** Structural plain concrete walls are not permitted in structures assigned to Seismic Design Category C.

**Exception:** Structural plain concrete basement, foundation or other walls below the base are permitted in detached one- and two-family dwellings constructed with stud-bearing walls. Such walls shall have reinforcement in accordance with Section 22.6.6.5 of ACI 318.

**1910.4.3.2 Footings.** Isolated footings of plain concrete supporting pedestals or columns are permitted provided the projection of the footing beyond the face of the supported member does not exceed the footing thickness.

**Exception:** In detached one- and two-family dwellings three stories or less in height, the projection of the footing beyond the face of the supported member is permitted to exceed the footing thickness.

**1910.4.3.2.1 Reinforcing bars.** Plain concrete footings supporting walls shall be provided with not less than two continuous longitudinal reinforcing bars. Bars shall not be smaller than No. 4 and shall have a total area of not less than 0.002 times the gross cross-sectional area of the footing. For footings which exceed 8 inches (203 mm) in thickness, a minimum of one bar shall be provided at the top and bottom of the footing. For foundation systems consisting of a plain concrete footing and a plain concrete stem wall, a minimum of one bar shall be provided at the top of the stem wall and at the bottom of the footing. Continuity of reinforcement shall be provided at corners and intersections.

**Exceptions:**

- 1. In detached one- and two-family dwellings three stories or less in height and constructed with stud-bearing walls, plain concrete footings supporting walls are permitted without longitudinal reinforcement.**

2. Where a slab-on-ground is cast monolithically with the footing, one No. 5 bar is permitted to be located at either the top or bottom of the footing.

**1910.4.3.3 Pedestals.** Plain concrete pedestals shall not be used to resist lateral seismic forces.

**1910.5 Seismic Design Category D.** Structures assigned to Seismic Design Category D, as determined in accordance with Section 1616, shall conform to the requirements for Seismic Design Category C and to the additional requirements of this section.

**1910.5.1 Seismic-force-resisting systems.** Moment frames used to resist seismic forces shall be special moment frames. Shear walls used to resist seismic forces shall be special reinforced concrete shear walls.

**1910.5.2 Frame members not proportioned to resist forces induced by earthquake motions.** Frame components assumed not to contribute to lateral force resistance shall conform to ACI 318, Section 21.11, as modified by Section 1908.1. 6 of this chapter.

## **SECTION BC 1911**

### **MINIMUM SLAB PROVISIONS**

**1911.1 General.** The thickness of concrete floor slabs supported directly on the ground shall not be less than 3½ inches (89 mm). A 6-mil (0.006 inch; 0.152 mm) polyethylene vapor retarder with joints lapped not less than 6 inches (152 mm) shall be placed between the base course or subgrade and the concrete floor slab, or other acceptable equivalent methods or materials shall be used to retard vapor transmission through the floor slab.

**Exception:** A vapor retarder is not required:

1. For detached structures accessory to occupancies in Group R-3, such as garages, utility buildings or other unheated facilities.
2. For unheated storage rooms having an area of less than 70 square feet (6.5 m<sup>2</sup>) and carports attached to occupancies in Group R-3.
3. For buildings of other occupancies where migration of moisture through the slab from below will not be detrimental to the intended occupancy of the building.
4. For drive ways, walks, patios and other flat work that will not be enclosed at a later date.
5. Where approved based on local site conditions.

**SECTION BC 1912**  
**ANCHORAGE TO CONCRETE—ALLOWABLE STRESS DESIGN**

**1912.1 Scope.** The provisions of this section shall govern the allowable stress design of headed bolts and headed stud anchors cast in normal-weight concrete for purposes of transmitting structural loads from one connected element to the other. These provisions do not apply to anchors installed in hardened concrete or where load combinations include earthquake loads or effects. The bearing area of headed anchors shall be not less than one and one-half times the shank area. Where strength design is used, or where load combinations include earthquake loads or effects, the design strength of anchors shall be determined in accordance with Section 1913. Bolts shall conform to ASTM A 307 or an acceptable equivalent.

**1912.2 Allowable service load.** The allowable service load for headed anchors in shear or tension shall be as indicated in Table 1912.2. Where anchors are subject to combined shear and tension, the following relationship shall be satisfied:

**(Equation 19-1 attached to end of document)**

**TABLE 1912.2**  
**ALLOWABLE SERVICE LOAD ON EMBEDDED BOLTS (pounds)**  
**(Table 1912.2 attached to end of document)**

**1912.3 Required edge distance and spacing.** The allowable service loads in tension and shear specified in Table 1912.2 are for the edge distance and spacing specified. The edge distance and spacing are permitted to be reduced to 50 percent of the values specified with an equal reduction in allowable service load. Where edge distance and spacing are reduced less than 50 percent, the allowable service load shall be determined by linear interpolation.

**1912.4 Reserved.**

**1912.5 Increase for special inspection.** Where special inspection is provided for the installation of anchors, a 100-percent increase in the allowable tension values of Table 1912.2 is permitted. No increase in shear value is permitted.

**SECTION BC 1913**  
**ANCHORAGE TO CONCRETE—STRENGTH DESIGN**

**1913.1 Scope.** The provisions of this section shall govern the strength design of anchors installed in concrete for purposes of transmitting structural loads from one connected element to the other. Headed bolts, headed studs and hooked (J- or L-) bolts cast in concrete and expansion anchors and undercut anchors installed in hardened concrete shall be designed in accordance with Appendix D of ACI 318, provided they are within the scope of Appendix D.

**Exception:** Where the basic concrete breakout strength in tension of a single anchor,  $N_b$ , is determined in accordance with Equation (D-7), the concrete breakout strength requirements of Section D.4.2.2 shall be considered satisfied by the design procedures of Sections D.5.2 and D.6.2 for anchors exceeding 2 inches (51 mm) in diameter or 25 inches (635 mm) tensile embedment depth.

**1913.1.1 Anchors outside scope of Appendix D.** The strength design of anchors that are not within the scope of Appendix D of ACI 318, as modified by this code, shall be in accordance with a procedure subject to the approval of the commissioner.

## **SECTION BC 1914** **SHOTCRETE**

**1914.1 General.** Shotcrete is mortar or concrete that is pneumatically projected at high velocity onto a surface. Except as specified in this section, shotcrete shall conform to the requirements of this chapter for plain or reinforced concrete.

**1914.2 Proportions and materials.** Shotcrete proportions shall be selected that allow suitable placement procedures using the delivery equipment selected and shall result in finished in-place hardened shotcrete meeting the strength requirements of this code.

**1914.3 Aggregate.** Coarse aggregate, if used, shall not exceed  $\frac{3}{4}$  inch (19.1 mm).

**1914.4 Reinforcement.** Reinforcement used in shotcrete construction shall comply with the provisions of Sections 1914.4.1 through 1914.4.4.

**1914.4.1 Size.** The maximum size of reinforcement shall be No. 5 bars unless it is demonstrated by preconstruction tests that adequate encasement of larger bars will be achieved.

**1914.4.2 Clearance.** When No. 5 or smaller bars are used, there shall be a minimum clearance between parallel reinforcement bars of  $2\frac{1}{2}$  inches (64 mm). When bars larger than No. 5 are permitted, there shall be a minimum clearance between parallel bars equal to six diameters of the bars used. When two curtains of steel are provided, the curtain nearer the nozzle shall have a minimum spacing equal to 12 bar diameters and the remaining curtain shall have a minimum spacing of six bar diameters.

**Exception:** Subject to the approval of the commissioner, required clearances shall be reduced where it is demonstrated by preconstruction tests that adequate encasement of the bars used in the design will be achieved.

**1914.4.3 Splices.** Lap splices of reinforcing bars shall utilize the noncontact lap splice method with a minimum clearance of 2 inches (51 mm) between bars. The use of contact lap splices necessary for support of the reinforcing is permitted when approved by the commissioner, based on satisfactory preconstruction tests that show

that adequate encasement of the bars will be achieved, and provided that the splice is oriented so that a plane through the center of the spliced bars is perpendicular to the surface of the shotcrete.

**1914.4.4 Spirally tied columns.** Shotcrete shall not be applied to spirally tied columns.

**1914.5 Preconstruction tests.** When required by the commissioner, a test panel shall be shot, cured, cored or sawn, examined and tested prior to commencement of the project. The sample panel shall be representative of the project and simulate job conditions as closely as possible. The panel thickness and reinforcing shall reproduce the thickest and most congested area specified in the structural design. It shall be shot at the same angle, using the same nozzleman and with the same concrete mix design that will be used on the project. The equipment used in preconstruction testing shall be the same equipment used in the work requiring such testing, unless substitute equipment is approved by the commissioner.

**1914.6 Rebound.** Any rebound or accumulated loose aggregate shall be removed from the surfaces to be covered prior to placing the initial or any succeeding layers of shotcrete. Rebound shall not be used as aggregate.

**1914.7 Joints.** Except where permitted herein, unfinished work shall not be allowed to stand for more than 30 minutes unless edges are sloped to a thin edge. For structural elements that will be under compression and for construction joints shown on the approved construction documents, square joints are permitted. Before placing additional material adjacent to previously applied work, sloping and square edges shall be cleaned and wetted.

**1914.8 Damage.** In-place shotcrete that exhibits sags, sloughs, segregation, honeycombing, sand pockets or other obvious defects shall be removed and replaced. Shotcrete above sags and sloughs shall be removed and replaced while still plastic.

**1914.9 Curing.** During the curing periods specified herein, shotcrete shall be maintained above 40°F (4°C) and in moist condition.

**1914.9.1 Initial curing.** Shotcrete shall be kept continuously moist for 24 hours after shotcreting is complete or shall be sealed with an approved curing compound.

**1914.9.2 Final curing.** Final curing shall continue for seven days after shotcreting, or for three days if high-early-strength cement is used, or until the specified strength is obtained. Final curing shall consist of the initial curing process or the shotcrete shall be covered with an approved moisture-retaining cover.

**1914.9.3 Natural curing.** Natural curing shall not be used in lieu of that specified in this section unless the relative humidity remains at or above 85 percent, and is authorized by the registered design professional of record and approved by the

commissioner.

**1914.10 Strength tests.** Strength tests for shotcrete shall be made by an approved agency on specimens that are representative of the work and that have been water soaked for at least 24 hours prior to testing. When the maximum-size aggregate is larger than  $\frac{3}{8}$  inch (9.5 mm), specimens shall consist of not less than three 3-inch-diameter (76 mm) cores or 3-inch (76 mm) cubes. When the maximum-size aggregate is  $\frac{3}{8}$  inch (9.5 mm) or smaller, specimens shall consist of not less than 2-inch-diameter (51 mm) cores or 2-inch (51 mm) cubes.

**1914.10.1 Sampling.** Specimens shall be taken from the in-place work or from test panels, and shall be taken at least once each shift, but not less than one for each 50 cubic yards (38.2 m<sup>3</sup>) of shotcrete.

**1914.10.2 Panel criteria.** When the maximum-size aggregate is larger than  $\frac{3}{8}$  inch (9.5 mm), the test panels shall have minimum dimensions of 18 inches by 18 inches (457 mm by 457 mm). When the maximum size aggregate is  $\frac{3}{8}$  inch (9.5 mm) or smaller, the test panels shall have minimum dimensions of 12 inches by 12 inches (305 mm by 305 mm). Panels shall be shot in the same position as the work, during the course of the work and by the nozzlemen doing the work. The conditions under which the panels are cured shall be the same as the work.

**1914.10.3 Acceptance criteria.** The average compressive strength of three cores from the in-place work or a single test panel shall equal or exceed  $0.85 f'_c$  with no single core less than  $0.75 f'_c$ . The average compressive strength of three cubes taken from the in-place work or a single test panel shall equal or exceed  $f'_c$  with no individual cube less than  $0.88 f'_c$ . To check accuracy, locations represented by erratic core or cube strengths shall be retested.

## **SECTION BC 1915** **REINFORCED GYPSUM CONCRETE**

**1915.1 General.** Reinforced gypsum concrete shall comply with the requirements of ASTM C 317 and ASTM C 956.

**1915.2 Minimum thickness.** The minimum thickness of reinforced gypsum concrete shall be 2 inches (51 mm) except the minimum required thickness shall be reduced to 1½ inches (38 mm), provided the following conditions are satisfied:

1. The overall thickness, including the formboard, is not less than 2 inches (51 mm).
2. The clear span of the gypsum concrete between supports does not exceed 33 inches (838 mm).
3. Diaphragm action is not required.

4. The design live load does not exceed 40 pounds per square foot (psf) (1915 Pa).

**1915.3 Limitations of use.** Reinforced gypsum concrete shall not be used where exposed directly to the weather or where subject to frequent or continuous wetting. Precast units shall be protected by coverings or coatings from the weather and from contact with moisture during shipment and during storage at the work site.

## **SECTION BC 1916** **CONCRETE-FILLED PIPE COLUMNS**

**1916.1 General.** Concrete-filled pipe columns shall be manufactured from standard, extra-strong or double-extra-strong steel pipe or tubing that is filled with concrete so placed and manipulated as to secure maximum density and to ensure complete filling of the pipe without voids.

**1916.2 Design.** The safe supporting capacity of concrete-filled pipe columns shall be computed in accordance with ACI 318 and AISC-LRFD or AISC 335 or as determined by a test approved by the commissioner.

**1916.3 Connections.** Caps, base plates and connections shall be in accordance with ACI 318 and AISC-LRFD or AISC 335 and shall be positively attached to the shell and anchored to the concrete core. Welding of brackets without mechanical anchorage shall be prohibited. Where the pipe is slotted to accommodate webs of brackets or other connections, the integrity of the shell shall be restored by welding to ensure hooping action of the composite section.

**1916.4 Reinforcement.** Steel reinforcement shall be in the form of rods, structural shapes or pipe embedded in the concrete core in accordance with ACI 318 and AISC-LRFD or AISC 335 with sufficient clearance to ensure the composite action of the section, but not nearer than 1 inch (25 mm) to the exterior steel shell. Structural shapes used as reinforcement shall be milled to ensure bearing on cap and base plates.

**1916.5 Fire-resistance-rating protection.** Pipe columns shall be of such size or so protected as to develop the required fire-resistance ratings specified in Table 601. Where an outer steel shell is used to enclose the fire-resistant covering, the shell shall not be included in the calculations for strength of the column section. The minimum diameter of pipe columns shall be 4 inches (102 mm) except that in structures of Type V construction not exceeding three stories or 40 feet (12 192 mm) in height, pipe columns used in the basement and as secondary steel members shall have a minimum diameter of 3 inches (76 mm).

**1916.6 Approvals.** Details of column connections and splices shall be shop fabricated in accordance with ACI 318 and AISC-LRFD or AISC 335. Shop-fabricated concrete-filled pipe columns shall be inspected by an approved agency pursuant to Chapter 17 of this code.



**SECTION BC 1917**  
**STRUCTURAL INTEGRITY REQUIREMENTS**

**1917.1 General.** Reinforced concrete structures shall meet all the requirements of sections 1917.1 through 1917.3. Concrete slabs on metal deck shall be governed by the provisions of Chapter 22. Reinforcement provided for gravity, seismic and wind forces or for other purposes may be regarded as forming part of, or the whole of, these requirements. Reinforcing provided for one requirement may be counted towards the other requirements.

**1917.2 Continuity and ties.** The structural integrity requirements of ACI 318, Section 7.13, shall apply. In addition, the following requirements shall be met.

**1917.2.1 Slab reinforcement.** At all floor and roof levels, slabs shall have a mat of bottom reinforcement in two perpendicular (or roughly perpendicular) directions. Reinforcement in this bottom mat shall be made continuous with lap, mechanical or welded tension splices.

**1917.2.1.1 Bottom mat reinforcement.** In each direction, the bottom mat reinforcement shall be not less than, the steel required for temperature reinforcement. The bottom mat reinforcement shall be anchored at discontinuous edges within the column strip, re-entrant corners, elevation changes and anywhere else the continuity of the reinforcing is interrupted.

**Exception:** Flat plate middle strip bottom mat reinforcing perpendicular to discontinuous slab edges.

In addition, the main bottom mat reinforcement in one-way slabs shall be anchored at discontinuous edges.

**1917.2.2 Peripheral ties.** At each floor and roof level, reinforcement forming a continuous peripheral tie shall be provided. Peripheral ties shall be located within perimeter beams or walls, where they occur, or within 4 feet (1219 mm) of the edge of slab, where perimeter beams or walls do not occur. Continuous tie reinforcement shall be equal to half of the bottom reinforcement within the edge or edge strip for two-way slabs but not less than two bars.

**1917.2.3 Horizontal ties.** At each column, beam reinforcement or slab bottom reinforcement shall be provided at each level that can develop a tension force equal to the maximum of 1 or 2:

1. Three times the load entering the column at that level, using a load combination of 1.0 x DL (self weight of structure only).
2. One and a half times the load entering the column at that level using the load combinations of (1.2 DL + 1.6 LL) or 1.4 DL.

**1917.2.3.1** This beam or slab bottom reinforcement shall be distributed around the column perimeter and shall be extended on all sides of the column into the adjacent slab for at least  $\frac{1}{3}$  of the span length. Where reinforcing bars cannot be extended beyond the column (e.g., at slab edges and openings), they shall be hooked or otherwise developed within the column.

**1917.2.4 Vertical ties.** Each column and each wall carrying vertical load shall be vertically tied continuously from its lowest to highest level. The vertical ties composed of vertical column reinforcement shall be capable of resisting a tensile force equal to the maximum design dead and live load received by the column or wall from any one story within four floors below.

**1917.3 Precast concrete general.** Precast concrete structural elements shall be reinforced to meet all of the requirements of this section. However, reinforcement provided for gravity, seismic and wind forces and for other purposes may be regarded as forming part of, or the whole of, these requirements. Reinforcing provided for one requirement may be counted towards the other requirements.

**1917.3.1 Continuity and ties.** The structural integrity requirements of ACI 318, Section 16.5, shall apply. In precast and composite structures, ties within precast structural elements shall be continuous and shall be anchored to the supporting structure. In addition to Sections 1917.2.2 and 1917.2.4 the following requirements shall be met.

**1917.3.1.1 End connections.** End connections of all precast beams and girders shall have an axial tension capacity equal to the larger of the vertical shear capacity of the connection at either end, or at least 2 percent of the maximum factored vertical dead and live load in the precast compression element, whichever is larger, but not less than 20 kips. Where more than one element frames in one direction, none of the elements or connections shall have an axial tension capacity of less than 1 percent of the column load but not less than 20 kips.

**1917.3.1.2 Side connections.** Side connections of all precast elements shall have an axial tension capacity not less than the steel required for temperature reinforcement of the larger element at either side.

**1917.3.1.3 Connection forces.** For design of the connections, the transverse shear force and the axial tensile force need not be considered to act simultaneously.

**1917.3.2 Joints.** Joints in precast structures shall not rely on friction due to gravity to transfer load.

**1917.3.3 Bearing.** The net bearing area shall not be less than 2 inches (51 mm) wide and 4 inches (102 mm) long in the direction of the member.

$$(P_s/P_t)^{5/3} + (V_s/V_t)^{5/3} \leq 1 \quad \text{(Equation 19-1)}$$

where:

$P_s$  = Applied tension service load, pounds (newtons).

$P_t$  = Allowable tension service load from Table 1912.2, pounds (newtons).

$V_s$  = Applied shear service load, pounds (newtons).

$V_t$  = Allowable shear service load from Table 1912.2, pounds (newtons).

**TABLE 1904.2.1  
TOTAL AIR CONTENT FOR FROST-RESISTANT CONCRETE**

NOMINAL MAXIMUM AGGREGATE SIZE <sup>a</sup> (inches)	AIR CONTENT (percent)	
	Severe exposure <sup>b</sup>	Moderate exposure <sup>b</sup>
$\frac{3}{8}$	$7\frac{1}{2}$	6
$\frac{1}{2}$	7	$5\frac{1}{2}$
$\frac{3}{4}$	6	5
1	6	$4\frac{1}{2}$
$1\frac{1}{2}$	$5\frac{1}{2}$	$4\frac{1}{2}$
2 <sup>c</sup>	5	4
3 <sup>c</sup>	$4\frac{1}{2}$	$3\frac{1}{2}$

For SI: 1 inch = 25.4 mm.

- a. See ASTM C 33 for tolerance on oversize for various nominal maximum size designations.
- b. The severe and moderate exposures referenced in this table are not based on the weathering regions shown in Figure 1904.2.2. For the purposes of this section, severe and moderate exposures shall be defined as follows:
  1. Severe exposure occurs where concrete will be in almost continuous contact with moisture prior to freezing, or where deicing salts are used. Examples are pavements, bridge decks, sidewalks, parking garages and water tanks.
  2. Moderate exposure occurs where concrete will be only occasionally exposed to moisture prior to freezing, and where deicing salts are not used. Examples are certain exterior walls, beams, girders and slabs not in direct contact with soil.
- c. These air contents apply to total mix, as for the preceding aggregate sizes. When testing these concretes, however, aggregate larger than  $1\frac{1}{2}$  inches is removed by hand picking or sieving and air content is determined on the minus  $1\frac{1}{2}$ -inch fraction of the mix (tolerance on air content as delivered applies to this value). Air content of total mix is computed from value determined on the minus  $1\frac{1}{2}$ -inch fraction.

**TABLE 1904.2.2(1)**  
**REQUIREMENTS FOR SPECIAL EXPOSURE CONDITIONS**

EXPOSURE CONDITION	MAXIMUM WATER-CEMENTITIOUS MATERIALS RATIO, BY WEIGHT, NORMAL-WEIGHT AGGREGATE CONCRETE	MINIMUM $f'_c$ , NORMAL-WEIGHT AND LIGHTWEIGHT AGGREGATE CONCRETE (psi)
Concrete intended to have low permeability when exposed to water	0.50	4,000
Concrete exposed to freezing and thawing in a moist condition or to deicing chemicals	0.45	4,500
For corrosion protection of reinforcement in concrete exposed to chlorides from deicing chemicals, salt, saltwater, brackish water, seawater or spray from these sources	0.40	5,000

For SI: 1 pound per square inch = 0.00689 MPa.

**TABLE 1904.2.2(2)**  
**MINIMUM SPECIFIED COMPRESSIVE STRENGTH (f 'c)**  
**(AS REVISED)**

<u><b>TYPE OR LOCATION OF CONCRETE CONSTRUCTION</b></u>	<u><b>MINIMUM SPECIFIED COMPRESSIVE STRENGTH</b></u> <u><b>(f'c at 28 days, psi)</b></u>
<u>Basement walls<sup>c</sup> and foundations not exposed to the weather</u>	<u>2,500<sup>a</sup></u>
<u>Basement slabs and interior slabs on grade, except garage floor slabs</u>	<u>2,500<sup>a</sup></u>
<u>Basement walls<sup>c</sup>, foundation walls, exterior walls and other vertical concrete surfaces exposed to the weather</u>	<u>3,000<sup>b</sup></u>
<u>Driveways, curbs, walks, patios, porches, carport slabs, steps and other flatwork exposed to the weather, and garage floor slabs</u>	<u>3,500<sup>b</sup></u>

For SI: 1 pound per square inch = 0.00689 MPa.

- a. Concrete in these locations that can be subjected to freezing and thawing during construction shall be of air-entrained concrete in accordance with Table 1904.2.1.
- b. Concrete shall be air entrained in accordance with Table 1904.2.1.
- c. Structural plain concrete basement walls are exempt from the requirements for special exposure conditions of Section 1904.2.2 (see Section 1909.1.1).

**TABLE 1904.2.2(2)**  
**MINIMUM SPECIFIED COMPRESSIVE STRENGTH ( $f'_c$ )**

TYPE OR LOCATION OF CONCRETE CONSTRUCTION	MINIMUM SPECIFIED COMPRESSIVE STRENGTH ( $f'_c$ at 28 days, psi)		
	Negligible exposure	Moderate exposure	Severe exposure
Basement walls <sup>c</sup> and foundations not exposed to the weather	2,500	2,500	2,500 <sup>a</sup>
Basement slabs and interior slabs on grade, except garage floor slabs	2,500	2,500	2,500 <sup>a</sup>
Basement walls <sup>c</sup> , foundation walls, exterior walls and other vertical concrete surfaces exposed to the weather	2,500	3,000 <sup>b</sup>	3,000 <sup>b</sup>
Driveways, curbs, walks, patios, porches, carport slabs, steps and other flatwork exposed to the weather, and garage floor slabs	2,500	3,000 <sup>b</sup>	3,500 <sup>b</sup>

For SI: 1 pound per square inch = 0.00689 MPa.

- Concrete in these locations that can be subjected to freezing and thawing during construction shall be of air-entrained concrete in accordance with Table 1904.2.1.
- Concrete shall be air entrained in accordance with Table 1904.2.1.
- Structural plain concrete basement walls are exempt from the requirements for special exposure conditions of Section 1904.2.2 (see Section 1909.1.1).

**TABLE 1904.2.3**  
**REQUIREMENTS FOR CONCRETE EXPOSED TO DEICING CHEMICALS**

CEMENTITIOUS MATERIALS	MAXIMUM PERCENT OF TOTAL CEMENTITIOUS MATERIALS BY WEIGHT <sup>a, b</sup>
Fly ash or other pozzolans conforming to ASTM C 618	25
Slag conforming to ASTM C 989	50
Silica fume conforming to ASTM C 1240	10
Total of fly ash or other pozzolans, slag and silica fume	50 <sup>c</sup>
Total of fly ash or other pozzolans and silica fume	35 <sup>c</sup>

- The total cementitious material also includes ASTM C 150, ASTM C 595, ASTM C 845 and ASTM C 1157 cement.
- The maximum percentages shall include:
  - Fly ash or other pozzolans present in Type IP or I (PM) blended cement, ASTM C 595, or ASTM C 1157.
  - Slag used in the manufacture of an IS or I (SM) blended cement, ASTM C 595, or ASTM C 1157.
  - Silica fume, ASTM C 1240, present in a blended cement.
- Fly ash or other pozzolans and silica fume shall constitute no more than 25 and 10 percent, respectively, of the total weight of the cementitious materials.

**TABLE 1904.3**  
**REQUIREMENTS FOR CONCRETE EXPOSED TO SULFATE-CONTAINING SOLUTIONS**

SULFATE EXPOSURE	WATER SOLUBLE SULFATE (SO <sub>4</sub> ) IN SOIL, PERCENT BY WEIGHT	SULFATE (SO <sub>4</sub> ) IN WATER (ppm)	CEMENT TYPE			MAXIMUM WATER-CEMENTITIOUS MATERIALS RATIO, BY WEIGHT, NORMAL-WEIGHT AGGREGATE CONCRETE <sup>a</sup>	MINIMUM $f'_c$ , NORMAL-WEIGHT AND LIGHTWEIGHT AGGREGATE CONCRETE (psi) <sup>a</sup>
			ASTM C 150	ASTM C 595	ASTM C 1157		
Negligible	0.00 - 0.10	0 - 150	—	—	—	—	
Moderate <sup>b</sup>	0.10 - 0.20	150 - 1,500	II	II, IP (MS), IS (MS), P (MS), I (PM)(MS), I (SM)(MS)	MS	0.50	4,000
Severe	0.20 - 2.00	1,500 - 10,000	V	—	HS	0.45	4,500
Very severe	Over 2.00	Over 10,000	V plus pozzolan <sup>c</sup>	—	HS plus pozzolan <sup>d</sup>	0.45	4,500

For SI: 1 pound per square inch = 0.00689 MPa.

- A lower water-cementitious materials ratio or higher strength may be required for low permeability or for protection against corrosion of embedded items or freezing and thawing (see Table 1904.2.2).
- Seawater.
- Pozzolan that has been determined by test or service record to improve sulfate resistance when used in concrete containing Type V cement.
- Pozzolan that has been determined by test or service record to improve sulfate resistance when used in concrete containing Type HS blended cement.

TABLE 1904.4.1  
MAXIMUM CHLORIDE ION CONTENT FOR CORROSION PROTECTION OF REINFORCEMENT

TYPE OF MEMBER	MAXIMUM WATER SOLUBLE CHLORIDE ION (Cl) IN CONCRETE, PERCENT BY WEIGHT OF CEMENT
Prestressed concrete	0.06
Reinforced concrete exposed to chloride in service	0.15
Reinforced concrete that will be dry or protected from moisture in service	1.00
Other reinforced concrete construction	0.30

**TABLE 1906.3.2**  
**MINIMUM LATERAL PRESSURES TO BE ASSUMED FOR FRESH**  
**CONCRETE WEIGHING 150 POUNDS PER CUBIC FOOT**

Type of Work	Minimum Lateral Pressure Assumed (psf)	Limitations
Columns: Ordinary work with normal internal vibration	$p = 150 + \frac{9000R}{T}$	Maximum 3,000 psf or 150h, whichever is less
Walls: Rate of placement at 7 ft. per hr. or less	$p = 150 + \frac{9000R}{T}$	Maximum 2,000 psf or 150h, whichever is less
Walls: Rate of placement at greater than 7 feet per hr.	$p = 150 + \frac{43400}{T} + \frac{2800R}{T}$	Maximum 2,000 psf or 150h, whichever is less
Slabs	$p = 150h$	None

Where:

R = rate of placement, feet per hour

T = temperature of concrete in the forms, degrees F.

h = height of fresh concrete above point considered, feet.

- a. Allowances for change in lateral pressure shall be made for concrete weighing other than one hundred fifty pcf; for concrete containing pozzolanic additions or cements other than type I, for concrete having slumps greater than six inches, or for concrete consolidated by revibration or external vibration of forms.
- b. Where retarding admixtures are employed under hot weather conditions an effective value of temperature less than that of the concrete in the forms shall be used in the above formulae.
- c. If retarding admixtures are used in cold weather, the lateral pressure may be assumed as that exerted by a fluid weighing one hundred fifty pcf.



**{NOTE: TABLE 1907.5.2.1 BELOW; ROW 1, COLUMN 1 SHOULD READ “d ≤ 8”}**

**TABLE 1907.5.2.1  
TOLERANCES**

DEPTH ( <i>d</i> ) (inches)	TOLERANCE ON <i>d</i> (inch)	TOLERANCE ON MINIMUM CONCRETE COVER (inch)
$d > 8$	$\pm \frac{3}{8}$	$-\frac{3}{8}$
$d > 8$	$\pm \frac{1}{2}$	$-\frac{1}{2}$

For SI: 1 inch = 25.4 mm.

**TABLE 1907.7.1  
MINIMUM CONCRETE COVER**

CONCRETE EXPOSURE	MINIMUM COVER (inches)
1. Concrete cast against and permanently exposed to earth	3
2. Concrete exposed to earth or weather No. 6 through No. 18 bar No. 5 bar, W31 or D31 wire, and smaller	2 1½
3. Concrete not exposed to weather or in contact with ground Slabs, walls, joists: No. 14 and No. 18 bars No. 11 bar and smaller Beams, columns: Primary reinforcement, ties, stirrups, spirals Shells, folded plate members: No. 6 bar and larger No. 5 bar, W31 or D31 wire, and smaller	1½ ¾ 1½ ¾ ½

For SI: 1 inch = 25.4 mm.

**TABLE 1912.2**  
**ALLOWABLE SERVICE LOAD ON EMBEDDED BOLTS (pounds)**

BOLT DIAMETER (inches)	MINIMUM EMBEDMENT (inches)	EDGE DISTANCE (inches)	SPACING (inches)	MINIMUM CONCRETE STRENGTH (psi)					
				$f'_c = 2,500$		$f'_c = 3,000$		$f'_c = 4,000$	
				Tension	Shear	Tension	Shear	Tension	Shear
$1/4$	$2 1/2$	$1 1/2$	3	200	500	200	500	200	500
$3/8$	3	$2 1/4$	$4 1/2$	500	1,100	500	1,100	500	1,100
$1/2$	4	3	6	950	1,250	950	1,250	950	1,250
	4	5	5	1,450	1,600	1,500	1,650	1,550	1,750
$5/8$	$4 1/2$	$3 3/4$	$7 1/2$	1,500	2,750	1,500	2,750	1,500	2,750
	$4 1/2$	$6 1/4$	$7 1/2$	2,125	2,950	2,200	3,000	2,400	3,050
$3/4$	5	$4 1/2$	9	2,250	3,250	2,250	3,560	2,250	3,560
	5	$7 1/2$	9	2,825	4,275	2,950	4,300	3,200	4,400
$7/8$	6	$5 1/4$	$10 1/2$	2,550	3,700	2,550	4,050	2,550	4,050
1	7	6	12	3,050	4,125	3,250	4,500	3,650	5,300
$1 1/8$	8	$6 3/4$	$13 1/2$	3,400	4,750	3,400	4,750	3,400	4,750
$1 1/4$	9	$7 1/2$	15	4,000	5,800	4,000	5,800	4,000	5,800

For SI: 1 inch = 25.4 mm, 1 pound per square inch = 0.00689 MPa, 1 pound = 4.45 N.

**CHAPTER 20**  
**ALUMINUM**

**SECTION BC 2001**  
**GENERAL**

**2001.1 Scope.** This chapter shall govern the quality, design, fabrication and erection of aluminum.

**SECTION BC 2002**  
**MATERIALS**

**2002.1 General.** Aluminum used for structural purposes in buildings and structures shall comply with AA ASM 35 and Parts 1-A and 1-B of the Aluminum Design Manual. The nominal loads shall be the minimum design loads required by Chapter 16 of this code.

**SECTION BC 2003**  
**ADDITIONAL REQUIREMENTS**

**2003.1 Identification.** Aluminum for structural elements shall at all times in the fabricator's plant, be marked, segregated, or otherwise handled so that the separate alloys and tempers are positively identified, and after completion of fabrication shall be marked to identify the alloy and temper. Such markings shall be affixed to completed members and assemblies or to boxed or bundled shipments of multiple units prior to shipment from the fabricator's plant.

**2003.2 Quality control.**

**2003.2.1 Reference.** Welding operations in structural connections where the calculated stresses in welds are 50 percent or more of the basic allowable values shall be subjected to the special inspections as required by Chapter 17 of this code.

**2003.2.2 Welding operations.**

- 1. Welding work shall be performed only by persons who have obtained a license from the commissioner.**
- 2. Tack welds that are not later incorporated into finished welds carrying calculated stress shall not be considered as structural welds.**
- 3. The inspection of welding operations shall include a check to ascertain that the welders employed on the work have the required license.**

**2003.3 Erection.**

**2003.3.1 Bracing.** All framework shall be carried up true and plumb. Temporary bracing shall be provided to support all loads imposed upon the framework during construction that are in excess of those for which the framework was designed.

**2003.3.2 Temporary connections.** As erection progresses, the work shall be securely bolted, or welded, to resist all dead loads, wind, and erection stresses.

**2003.3.3 Alignment.** The structure shall be properly aligned before riveting, permanent bolting, or welding is performed.

**CHAPTER 21**  
**MASONRY**

**SECTION BC 2101**  
**GENERAL**

**2101.1 Scope.** This chapter shall govern the materials, design, construction and quality of masonry.

**2101.2 Design methods.** Masonry shall comply with the provisions of one of the following design methods in this chapter as well as the requirements of Sections 2101 through 2104. Masonry designed by the working stress design provisions of Section 2101.2.1, the strength design provisions of Section 2101.2.2 or the prestressed masonry provisions of Section 2101.2.3 shall comply with Section 2105 for Quality Assurance.

**2101.2.1 Working stress design.** Masonry designed by the working stress design method shall comply with the provisions of Sections 2106 and 2107.

**2101.2.2 Strength design.** Masonry designed by the strength design method shall comply with the provisions of Sections 2106 and 2108.

**2101.2.3 Prestressed masonry.** Prestressed masonry shall be designed in accordance with Chapters 1 and 4 of ACI 530/ASCE 5/TMS 402 and Section 2106. Special inspection during construction shall be provided as set forth in Section 1704.5.

**2101.2.4 Empirical design.** Masonry designed by the empirical design method shall comply with the provisions of Sections 2106 and 2109 or Chapter 5 of ACI 530/ASCE 5/TMS 402.

**2101.2.5 Glass masonry.** Glass masonry shall comply with the provisions of Section 2110 or with the requirements of Chapter 7 of ACI 530/ASCE 5/TMS 402.

**2101.2.6 Masonry veneer.** Masonry veneer shall comply with the provisions of Chapter 14.

**2101.3 Construction documents.** The construction documents shall show all of the items required by this code including the following:

1. Specified size, grade, type and location of reinforcement, anchors and wall ties.
2. Reinforcing bars to be welded and welding procedure.
3. Size and location of structural elements.
4. Provisions for dimensional changes resulting from elastic deformation, creep,

shrinkage, temperature and moisture.

**2101.3.1 Fireplace drawings.** The construction documents shall describe in sufficient detail the location, size and construction of masonry fireplaces. The thickness and characteristics of materials and the clearances from walls, partitions and ceilings shall be clearly indicated. The masonry fireplace shall comply with the provisions of Section 2111.0.

## **SECTION BC 2102** **DEFINITIONS AND NOTATIONS**

**2102.1 General.** The following words and terms shall, for the purposes of this chapter and as used elsewhere in this code, have the meanings shown herein.

**ANCHOR.** Metal rod, wire or strap that secures masonry to its structural support.

**ARCHITECTURAL TERRA COTTA.** Plain or ornamental hard-burned modified clay units, larger in size than brick, with glazed or unglazed ceramic finish.

### **AREA.**

**Bedded.** The area of the surface of a masonry unit that is in contact with mortar in the plane of the joint.

**Gross cross-sectional.** The area delineated by the out-to-out specified dimensions of masonry in the plane under consideration.

**Net cross-sectional.** The area of masonry units, grout and mortar crossed by the plane under consideration based on out-to-out specified dimensions.

**BED JOINT.** The horizontal layer of mortar on which a masonry unit is laid.

**BOND BEAM.** A horizontal grouted element within masonry in which reinforcement is embedded.

**BOND REINFORCING.** The adhesion between steel reinforcement and mortar or grout.

### **BRICK.**

**Calcium silicate (sand lime brick).** A masonry unit made of sand and lime.

**Clay or shale.** A masonry unit made of clay or shale, usually formed into a rectangular prism while in the plastic state and burned or fired in a kiln.

**Concrete.** A masonry unit having the approximate shape of a rectangular prism and composed of inert aggregate particles embedded in a hardened cementitious matrix.

**BUTTRESS.** A projecting part of a masonry wall built integrally therewith to provide lateral stability.

**CAST STONE.** A building stone manufactured from portland cement concrete precast and used as a trim, veneer or facing on or in buildings or structures.

**CELL.** A void space having a gross cross-sectional area greater than 1½-square inches (967 mm<sup>2</sup>).

**CHIMNEY.** A primarily vertical enclosure containing one or more flues used to remove hot gases from burning fuel, refuse, or from industrial processes to the outside atmosphere.

#### **CHIMNEY TYPES.**

**High-heat appliance type.** An approved chimney for removing the products of combustion from fuel-burning, high-heat appliances producing combustion gases in excess of 2,000°F (1093°C) measured at the appliance flue outlet (see Section 2113.11.3).

**Low-heat appliance type.** An approved chimney for removing the products of combustion from fuel-burning, low-heat appliances producing combustion gases not in excess of 1,000°F (538°C) under normal operating conditions, but capable of producing combustion gases of 1,400°F (760°C) during intermittent forces firing for periods up to 1 hour. Temperatures shall be measured at the appliance flue outlet.

**Masonry type.** A field-constructed chimney of solid masonry units or stones.

**Medium-heat appliance type.** An approved chimney for removing the products of combustion from fuel-burning, medium-heat appliances producing combustion gases between 1000°F (538°C) and 2,000°F (1093°C) measured at the appliance flue outlet (see Section 2113.11.2).

**CLEANOUT.** An opening to the bottom of a grout space of sufficient size and spacing to allow the removal of debris.

**COLLAR JOINT.** Vertical longitudinal joint between wythes of masonry or between masonry and backup construction that is permitted to be filled with mortar or grout.

**COLUMN, MASONRY.** An isolated vertical member whose horizontal dimension measured at right angles to its thickness does not exceed three times its thickness and whose height is at least four times its thickness.

**COMPOSITE ACTION.** Transfer of stress between components of a member designed so that in resisting loads, the combined components act together as a single member.

**COMPOSITE MASONRY.** Multiwythe masonry members acting with composite action.

**COMPRESSIVE STRENGTH OF MASONRY.** Maximum compressive force resisted per unit of net cross-sectional area of masonry, determined by the testing of masonry prisms or a function of individual masonry units, mortar and grout.

**CONNECTOR.** A mechanical device for securing two or more pieces, parts or members together, including anchors, wall ties and fasteners.

**COVER.** Distance between surface of reinforcing bar and edge of member.

**DIAPHRAGM.** A roof or floor system designed to transmit lateral forces to shear walls or other lateral-load-resisting elements.

## **DIMENSIONS.**

**Actual.** The measured dimension of a masonry unit or element.

**Nominal.** A dimension equal to a specified dimension plus an allowance for the joints with which the units are to be laid. Thickness is given first, followed by height and then length.

**Specified.** The dimensions specified for the manufacture or construction of masonry, masonry units, joints or any other component of a structure.

**EFFECTIVE HEIGHT.** For braced members, the effective height is the clear height between lateral supports and is used for calculating the slenderness ratio. The effective height for unbraced members is calculated in accordance with engineering mechanics.

**FIREPLACE.** A hearth and fire chamber or similar prepared place in which a fire may be made and which is built in conjunction with a chimney.

**FIREPLACE THROAT.** The opening between the top of the firebox and the smoke chamber.

**FLUE.** A passageway within a chimney or vent through which gaseous combustion products pass.

**FLUE, APPLIANCE.** The passage(s) within an appliance through which combustion products pass from the combustion chamber of the appliance to the draft hood inlet



opening on an appliance equipped with a draft hood or to the outlet of the appliance on an appliance not equipped with a draft hood.

**FLUE GASES.** Products of combustion plus excess air in appliance flues or heat exchangers.

**FLUE LINER (LINING).** A system or material used to form the inside surface of a flue in a chimney or vent, for the purpose of protecting the surrounding structure from the effects of combustion products and for conveying combustion products without leakage into the atmosphere.

**GROUT.** Flowable cementitious material comprising cement mixed with fine or coarse aggregates and having a compressive strength not less than 2,000 pounds per square inch (13 790 kPa) at 28 days, and a slump of 8 inches to 11 inches (203 mm to 279 mm).

### **GROUTED MASONRY.**

**Grouted hollow-unit masonry.** That form of grouted masonry construction in which certain designated cells of hollow units are continuously filled with grout.

**Grouted multi-wythe masonry.** That form of grouted masonry construction in which the space between the wythes is solidly or periodically filled with grout.

**HEAD JOINT.** Vertical mortar joint placed between masonry units within the wythe at the time the masonry units are laid.

**HEADER (Bonder).** A masonry unit that connects two or more adjacent wythes of masonry.

**HEIGHT, WALLS.** The vertical distance from the foundation wall or other immediate support of such wall to the top of the wall.

**MASONRY.** A built-up construction or combination of building units or materials of clay, shale, concrete, glass, gypsum, stone or other approved units bonded together with or without mortar or grout or other accepted method of joining.

**Ashlar masonry.** Masonry composed of various sized rectangular units having sawed, dressed or squared bed surfaces, properly bonded and laid in mortar.

**Coursed ashlar.** Ashlar masonry laid in courses of stone of equal height for each course, although different courses shall be permitted to be of varying height.

**Glass unit masonry.** Nonload-bearing masonry composed of glass units bonded by mortar.

**Plain masonry.** Masonry in which the tensile resistance of the masonry is taken into consideration and the effects of stresses in reinforcement are neglected.

**Random ashlar.** Ashlar masonry laid in courses of stone set without continuous joints and laid up without drawn patterns. When composed of material cut into modular heights, discontinuous but aligned horizontal joints are discernible.

**Reinforced masonry.** Masonry construction in which reinforcement acting in conjunction with the masonry is used to resist forces.

**Solid masonry.** Masonry consisting of solid masonry units laid contiguously with the joints between the units filled with mortar.

**MASONRY UNIT.** Brick, tile, stone, glass block or concrete block conforming to the requirements specified in Section 2103.

**Clay.** A building unit larger in size than a brick, composed of burned clay, shale, fire clay or mixtures thereof.

**Concrete.** A building unit or block larger in size than 12 inches by 4 inches by 4 inches (305 mm by 102 mm by 102 mm) made of cement and suitable aggregates.

**Hollow.** A masonry unit whose net cross-sectional area in any plane parallel to the load-bearing surface is less than 75 percent of its gross cross-sectional area measured in the same plane.

**Solid.** A masonry unit whose net cross-sectional area in every plane parallel to the load-bearing surface is 75 percent or more of its gross cross-sectional area measured in the same plane.

**MEAN DAILY TEMPERATURE.** The average daily temperature of temperature extremes predicted by a local weather bureau for the next 24 hours.

**MORTAR.** A plastic mixture of approved cementitious materials, fine aggregates and water used to bond masonry or other structural units.

**MORTAR, SURFACE-BONDING.** A mixture to bond concrete masonry units that contains hydraulic cement, glass fiber reinforcement with or without inorganic fillers or organic modifiers and water.

**PLASTIC HINGE.** The zone in a structural member in which the yield moment is anticipated to be exceeded under loading combinations that include earthquakes.

**PRESTRESSED MASONRY.** Masonry in which internal stresses have been introduced to counteract potential tensile stresses in masonry resulting from applied loads.

**PRISM.** An assemblage of masonry units and mortar with or without grout used as a test specimen for determining properties of the masonry.

**RUBBLE MASONRY.** Masonry composed of roughly shaped stones.

**Coursed rubble.** Masonry composed of roughly shaped stones fitting approximately on level beds and well bonded.

**Random rubble.** Masonry composed of roughly shaped stones laid without regularity of coursing but well-bonded and fitted together to form well-divided joints.

**Rough or ordinary rubble.** Masonry composed of unsquared field stones laid without regularity of coursing but well-bonded.

**RUNNING BOND.** The placement of masonry units such that head joints in successive courses are horizontally offset at least one-quarter the unit length.

**SHEAR WALL.**

**Detailed plain masonry shear wall.** A masonry shear wall designed to resist lateral forces neglecting stresses in reinforcement, and designed in accordance with Section 2106.1.1.

**Intermediate pre-stressed masonry shear wall.** A pre-stressed masonry shear wall designed to resist lateral forces considering stresses in reinforcement, and designed in accordance with Section 2106.1.1.2.

**Intermediate reinforced masonry shear wall.** A masonry shear wall designed to resist lateral forces considering stresses in reinforcement, and designed in accordance with Section 2106.1.1.

**Ordinary plain masonry shear wall.** A masonry shear wall designed to resist lateral forces neglecting stresses in reinforcement, and designed in accordance with Section 2106.1.1.

**Ordinary plain pre-stressed masonry shear wall.** A pre-stressed masonry shear wall designed to resist lateral forces considering stresses in reinforcement, and designed in accordance with Section 2106.1.1.1.

**Ordinary reinforced masonry shear wall.** A masonry shear wall designed to resist lateral forces considering stresses in reinforcement, and designed in accordance with Section 2106.1.1.

**Special pre-stressed masonry shear wall.** A pre-stressed masonry shear wall

designed to resist lateral forces considering stresses in reinforcement and designed in accordance with Section 2106.1.1.3 except that only grouted, laterally restrained tendons are used.

**Special reinforced masonry shear wall.** A masonry shear wall designed to resist lateral forces considering stresses in reinforcement, and designed in accordance with Section 2106.1.1.

**SHELL.** The outer portion of a hollow masonry unit as placed in masonry.

**SPECIFIED.** Required by construction documents.

**SPECIFIED COMPRESSIVE STRENGTH OF MASONRY,  $f'_m$ .** Minimum compressive strength, expressed as force per unit of net cross-sectional area, required of the masonry used in construction by the construction documents, and upon which the project design is based. Whenever the quantity  $f'_m$  is under the radical sign, the square root of numerical value only is intended and the result has units of pounds per square inch (psi) (Mpa).

**STACK BOND.** The placement of masonry units in a bond pattern is such that head joints in successive courses are vertically aligned. For the purpose of this code, requirements for stack bond shall apply to masonry laid in other than running bond.

**STONE MASONRY.** Masonry composed of field, quarried or cast stone units bonded by mortar.

**Ashlar stone masonry.** Stone masonry composed of rectangular units having sawed, dressed or squared bed surfaces and bonded by mortar.

**Rubble stone masonry.** Stone masonry composed of irregular-shaped units bonded by mortar.

## **STRENGTH.**

**Design strength.** Nominal strength multiplied by a strength reduction factor.

**Nominal strength.** Strength of a member or cross section calculated in accordance with these provisions before application of any strength-reduction factors.

**Required strength.** Strength of a member or cross section required to resist factored loads.

**TIE, LATERAL.** Loop of reinforcing bar or wire enclosing longitudinal reinforcement.

**TIE, WALL.** A connector that connects wythes of masonry walls together.

**TILE.** A ceramic surface unit, usually relatively thin in relation to facial area, made from clay or a mixture of clay or other ceramic materials, called the body of the tile, having either a “glazed” or “unglazed” face and fired above red heat in the course of manufacture to a temperature sufficiently high enough to produce specific physical properties and characteristics.

**TILE, STRUCTURAL CLAY.** A hollow masonry unit composed of burned clay, shale, fire clay or mixture thereof, and having parallel cells.

**WALL.** A vertical element with a horizontal length-to-thickness ratio greater than three, used to enclose space.

**Cavity wall.** A wall built of masonry units or of concrete, or a combination of these materials, arranged to provide an airspace within the wall, and in which the inner and outer parts of the wall are tied together with metal ties.

**Composite wall.** A wall built of a combination of two or more masonry units bonded together, one forming the backup and the other forming the facing elements.

**Dry-stacked, surface-bonded walls.** A wall built of concrete masonry units where the units are stacked dry, without mortar on the bed or head joints, and where both sides of the wall are coated with a surface-bonding mortar.

**Masonry-bonded hollow wall.** A wall built of masonry units so arranged as to provide an airspace within the wall, and in which the facing and backing of the wall are bonded together with masonry units.

**Parapet wall.** The part of any wall entirely above the roof line.

**WEB.** An interior solid portion of a hollow masonry unit as placed in masonry.

**WYTHER.** Each continuous, vertical section of a wall, one masonry unit in thickness.

### **NOTATIONS.**

$A_n$  = Net cross-sectional area of masonry, square inches ( $\text{mm}^2$ ).

$b$  = Effective width of rectangular member or width of flange for T and I sections, inches (mm).

$d_b$  = Diameter of reinforcement, inches (mm).

$f_r$  = Modulus of rupture, psi (MPa).

$f_y$  = Specified yield stress of the reinforcement or the anchor bolt, psi (MPa).

$f_m$  = Specified compressive strength of masonry at age of 28 days, psi (MPa).

$K$  = The lesser of the masonry cover, clear spacing between adjacent reinforcement, or five times  $d_b$ , inches (mm).

$L_s$  = Distance between supports, inches (mm).

$L_w$  = Length of wall, inches (mm).

$l_d$  = Required development length of reinforcement, inches (mm).

$l_{de}$  = Embedment length of reinforcement, inches (mm).

$P_w$  = Weight of wall tributary to section under consideration, pounds (N).

$T$  = Specified wall thickness dimension or the least lateral dimension of a column, inches (mm).

$V_n$  = Nominal shear strength, pounds (N).

$V_u$  = Required shear strength due to factored loads, pounds (N).

$W$  = Wind load, or related internal moments in forces.

$\gamma$  = Reinforcement size factor.

$\rho_n$  = Ratio of distributed shear reinforcement on plane perpendicular to plane of  $A_{mv}$ .

$\rho_{max}$  = Maximum reinforcement ratio.

$\phi$  = Strength reduction factor.

## **SECTION BC 2103** **MASONRY CONSTRUCTION MATERIALS**

**2103.1 Concrete masonry units.** Concrete masonry units shall conform to the following standards: ASTM C 55 for concrete brick; ASTM C 90 for load-bearing concrete masonry units; ASTM C 129 for non-load bearing concrete masonry units or ASTM C 744 for prefaced concrete and calcium silicate masonry units.

**2103.2 Clay or shale masonry units.** Clay or shale masonry units shall conform to the following standards: ASTM C 34 for structural clay load-bearing wall tile; ASTM C 56 for structural clay nonload-bearing wall tile; ASTM C 62 for building brick (solid

masonry units made from clay or shale); ASTM C 1088 for solid units of thin veneer brick; ASTM C 126 for ceramic-glazed structural clay facing tile, facing brick and solid masonry units; ASTM C 212 for structural clay facing tile; ASTM C 216 for facing brick (solid masonry units made from clay or shale); ASTM C 652 for hollow brick (hollow masonry units made from clay or shale) and ASTM C 73 for calcium silicate face brick.

**Exception:** Structural clay tile for nonstructural use in fireproofing of structural members and in wall furring shall not be required to meet the compressive strength specifications. The fire-resistance rating shall be determined in accordance with ASTM E 119 and shall comply with the requirements of Table 602.

**2103.3 Stone masonry units.** Stone masonry units shall conform to the following standards: ASTM C 503 for marble building stone (exterior); ASTM C 568 for limestone building stone; ASTM C 615 for granite building stone; ASTM C 616 for sandstone building stone or ASTM C 629 for slate building stone.

**2103.4 Ceramic tile.** Ceramic tile shall be as defined in, and shall conform to the requirements of, ANSI A137.1.

**2103.5 Glass unit masonry.** Hollow glass units shall be partially evacuated and have a minimum average glass face thickness of  $\frac{3}{16}$  inch (4.8 mm). Solid glass-block units shall be provided when required. The surfaces of units intended to be in contact with mortar shall be treated with a polyvinyl butyral coating or latex-based paint. Reclaimed units shall not be used.

**2103.6 Second-hand units.** Second-hand masonry units shall not be reused unless they conform to the requirements of new units. The units shall be of whole, sound materials and free from cracks and other defects that will interfere with proper laying or use. Old mortar shall be cleaned from the unit before reuse.

**Exception:** second-hand masonry units need not conform to the requirements for new units when their reuse is to comply with historic restoration standards or requirements of the New York City Landmarks Preservation Commission or the New York State Historic Preservation Office.

**2103.7 Mortar.** Mortar for use in masonry construction shall conform to ASTM C 270 and shall conform to the proportion specifications of Table 2103.7(1) or the property specifications of Table 2103.7(2). Type S or N mortar shall be used for glass unit masonry. The amount of water used in mortar for glass unit masonry shall be adjusted to account for the lack of absorption. Re-tempering of mortar for glass unit masonry shall not be permitted after initial set. Unused mortar shall be discarded within 2 ½ hours after initial mixing except that unused mortar for glass unit masonry shall be discarded within 1 ½ hours after initial mixing.

**TABLE 2103.7(1)**

## **MORTAR PROPORTIONS**

**(Table 2103.7(1) attached to end of document)**

## **TABLE 2103.7(2)**

### **MORTAR PROPERTIES**

**(Table 2103.7(2) attached to end of document)**

**2103.8 Surface-bonding mortar.** Surface-bonding mortar shall comply with ASTM C 887. Surface bonding of concrete masonry units shall comply with ASTM C 946.

**2103.9 Mortars for ceramic wall and floor tile.** Portland cement mortars for installing ceramic wall and floor tile shall comply with ANSI A108.1A and ANSI A108.1B and be of the compositions indicated in Table 2103.9.

## **TABLE 2103.9**

### **CERAMIC TILE MORTAR COMPOSITIONS**

**(Table 2103.9 attached to end of document)**

**2103.9.1 Dry-set portland cement mortars.** Premixed prepared portland cement mortars, which require only the addition of water and are used in the installation of ceramic tile, shall comply with ANSI A118.1. The shear bond strength for tile set in such mortar shall be as required in accordance with ANSI A118.1. Tile set in dry-set portland cement mortar shall be installed in accordance with ANSI A108.5.

**2103.9.2 Electrically conductive dry-set mortars.** Premixed prepared portland cement mortars, which require only the addition of water and comply with ANSI A118.2, shall be used in the installation of electrically conductive ceramic tile. Tile set in electrically conductive dry-set mortar shall be installed in accordance with ANSI A108.7.

**2103.9.3 Latex-modified portland cement mortar.** Latex-modified portland cement thin-set mortars in which latex is added to dry-set mortar as a replacement for all or part of the gauging water that are used for the installation of ceramic tile shall comply with ANSI A118.4. Tile set in latex- modified portland cement shall be installed in accordance with ANSI A108.5.

**2103.9.4 Epoxy mortar.** Ceramic tile set and grouted with chemical-resistant epoxy shall comply with ANSI A118.3. Tile set and grouted with epoxy shall be installed in accordance with ANSI A108.6.

**2103.9.5 Furan mortar and grout.** Chemical-resistant furan mortar and grout that are used to install ceramic tile shall comply with ANSI A118.5. Tile set and grouted with furan shall be installed in accordance with ANSI A108.8.

**2103.9.6 Modified epoxy-emulsion mortar and grout.** Modified epoxy-emulsion



mortar and grout that are used to install ceramic tile shall comply with ANSI A118.8. Tile set and grouted with modified epoxy-emulsion mortar and grout shall be installed in accordance with ANSI A108.9.

**2103.9.7 Organic adhesives.** Water-resistant organic adhesives used for the installation of ceramic tile shall comply with ANSI A136.1. The shear bond strength after water immersion shall not be less than 40 psi (275 kPa) for Type I adhesive, and not less than 20 psi (138 kPa) for Type II adhesive, when tested in accordance with ANSI A136.1. Tile set in organic adhesives shall be installed in accordance with ANSI A108.4.

**2103.9.8 Portland cement grouts.** Portland cement grouts used for the installation of ceramic tile shall comply with ANSI A118.6. Portland cement grouts for tile work shall be installed in accordance with ANSI A108.10.

**2103.10 Grout.** Grout shall conform to Table 2103.10 or to ASTM C 476. When grout conforms to ASTM C 476, the grout shall be specified by proportion requirements or property requirements.

**TABLE 2103.10**  
**GROUT PROPORTIONS BY VOLUME FOR**  
**MASONRY CONSTRUCTION**  
**(Table 2103.10 attached to end of document)**

**2103.11 Metal reinforcement and accessories.** Metal reinforcement and accessories shall conform to Sections 2103.11.1 through 2103.11.7.

**2103.11.1 Deformed reinforcing bars.** Deformed reinforcing bars shall conform to one of the following standards: ASTM A 615 for deformed and plain billet-steel bars for concrete reinforcement; ASTM A 706 for low-alloy steel deformed bars for concrete reinforcement; ASTM A 767 for zinc-coated reinforcing steel bars; ASTM A 775 for epoxy-coated reinforcing steel bars and ASTM A 996 for rail steel and axle steel deformed bars for concrete reinforcement.

**2103.11.2 Joint reinforcement.** Joint reinforcement shall comply with ASTM A 951. The maximum spacing of crosswires in ladder-type joint reinforcement and of point of connection of cross wires to longitudinal wires of truss-type reinforcement shall be 16 inches (406 mm).

**2103.11.3 Deformed reinforcing wire.** Deformed reinforcing wire shall conform to ASTM A 496.

**2103.11.4 Wire fabric.** Wire fabric shall conform to ASTM A 185 for plain steel-welded wire fabric for concrete reinforcement or ASTM A 496 for welded deformed steel wire fabric for concrete reinforcement.

**2103.11.5 Anchors, ties and accessories.** Anchors, ties and accessories shall conform to the following standards: ASTM A 36 for structural steel; ASTM A 82 for plain steel wire for concrete reinforcement; ASTM A 185 for plain steel-welded wire fabric for concrete reinforcement; ASTM A 167, Type 304, for stainless and heat-resisting chromium- nickel steel plate, sheet and strip and ASTM A 366 for cold-rolled carbon steel sheet, commercial quality.

**2103.11.6 Prestressing tendons.** Prestressing tendons shall conform to one of the following standards:

- a. Wire . . . . .ASTM A 421
- b. Low-relaxation wire . . .ASTM A 421
- c. Strand . . . . .ASTM A 416
- d. Low-relaxation strand. . ASTM A 416
- e. Bar . . . . .ASTM A 722

**Exceptions:**

- 1. Wire, strands and bars not specifically listed in ASTM A 421, ASTM A 416 or ASTM A 722 are permitted, provided they conform to the minimum requirements in ASTM A 421, ASTM A 416, or ASTM A 722 and are approved by the architect/engineer.
- 2. Bars and wires of less than 150 kips per square inch (ksi) (1034 MPa) tensile strength and conforming to ASTM A 82, ASTM A 510, ASTM A 615, ASTM A 616, ASTM A 996 or ASTM A 706/A 706 M are permitted to be used as pre-stressed tendons provided that:
  - 2.1. The stress relaxation properties have been assessed by tests according to ASTM E 328 for the maximum permissible stress in the tendon.
  - 2.2. Other nonstress-related requirements of ACI 530/ASCE 5/TMS 402, Chapter 4, addressing pre-stressing tendons are met.

**2103.11.7 Corrosion protection.** Corrosion protection for pre-stressing tendons, pre-stressing anchorages, couplers and end block shall comply with the requirements of ACI 530.1/ASCE 6/TMS 602, Article 2.4G. Corrosion protection for carbon steel accessories used in exterior wall construction or interior walls exposed to a mean relative humidity exceeding 75 percent shall comply with either Section 2103.11.7.1 or 2103.11.7.2. Corrosion protection for carbon steel accessories used in interior

walls exposed to a mean relative humidity equal to or less than 75 percent shall comply with either Section 2103.11.7.1, 2103.11.7.2 or 2103.11.7.3.

**2103.11.7.1 Hot-dipped galvanized.** Apply a hot-dipped galvanized coating after fabrication as follows:

1. For joint reinforcement, wall ties, anchors and inserts, apply a minimum coating of 1.5 ounces per square foot (psf) (458 g/m<sup>2</sup>) complying with the requirements of ASTM A 153, Class B.
2. For sheet metal ties and sheet metal anchors, comply with the requirements of ASTM A 153, Class B.
3. For steel plates and bars, comply with the requirements of either ASTM A 123 or ASTM A 153, Class B.

**2103.11.7.2 Epoxy coatings.** Carbon steel accessories shall be epoxy-coated as follows:

1. For joint reinforcement, comply with the requirements of ASTM A 884 Class B, Type 2 – 18 mils (457μm).
2. For wire ties and anchors, comply with the requirements of ASTM A 899 Class C—20mils (508μm).
3. For sheet metal ties and anchors, provide a minimum thickness of 20 mils (508μm) or in accordance with the manufacturer's specification.

**2103.11.7.3 Mill galvanized.** Apply a mill galvanized coating as follows:

1. For joint reinforcement, wall ties, anchors and inserts, apply a minimum coating of 0.1 ounce psf (31g/m<sup>2</sup>) complying with the requirements of ASTM A 641.
2. For sheet metal ties and sheet metal anchors, apply a minimum coating complying with Coating Designation G-60 according to the requirements of ASTM A 653.
3. For anchor bolts, steel plates or bars not exposed to the earth, weather or a mean relative humidity exceeding 75 percent, a coating is not required.

**2103.11.8 Tests.** Where unidentified reinforcement is approved for use, not less than three tension and three bending tests shall be made on representative specimens of the reinforcement from each shipment and grade of reinforcing steel proposed for use in the work.

## SECTION BC 2104 CONSTRUCTION

**2104.1 Masonry construction.** Masonry construction shall comply with the requirements of Sections 2104.1.1 through 2104.5 and with ACI 530.1/ASCE 6/TMS 602.

**2104.1.1 Tolerances.** Masonry, except masonry veneer, shall be constructed within the tolerances specified in ACI 530.1/ASCE 6/TMS 602.

**2104.1.2 Placing mortar and units.** Placement of mortar and units shall comply with Sections 2104.1.2.1 through 2104.1.2.5.

**2104.1.2.1 Bed and head joints.** Unless otherwise required or indicated on the construction documents, head and bed joints shall be  $\frac{3}{8}$  inch (9.5 mm) thick, except that the thickness of the bed joint of the starting course placed over foundations shall not be less than  $\frac{1}{4}$  inch (6.4 mm) and not more than  $\frac{3}{4}$  inch (19.1 mm).

**2104.1.2.1.1 Open-end units.** Open-end units with beveled ends shall be fully grouted. Head joints of open-end units with beveled ends need not be mortared. The beveled ends shall form a grout key that permits grouts within  $\frac{5}{8}$  inch (15.9 mm) of the face of the unit. The units shall be tightly butted to prevent leakage of the grout.

**2104.1.2.2 Hollow units.** Hollow units shall be placed such that face shells of bed joints are fully mortared. Webs shall be fully mortared in all courses of piers, columns, pilasters, in the starting course on foundations where adjacent cells or cavities are to be grouted, and where otherwise required. Head joints shall be mortared a minimum distance from each face equal to the face shell thickness of the unit.

**2104.1.2.3 Solid units.** Unless otherwise required or indicated on the construction documents, solid units shall be placed in fully mortared bed and head joints. The ends of the units shall be completely buttered. Head joints shall not be filled by slushing with mortar. Head joints shall be constructed by shoving mortar tight against the adjoining unit. Bed joints shall not be furrowed deep enough to produce voids.

**2104.1.2.4 Glass unit masonry.** Glass units shall be placed so head and bed joints are filled solidly. Mortar shall not be furrowed. Unless otherwise required, head and bed joints of glass unit masonry shall be  $\frac{1}{4}$  inch (6.4 mm) thick, except that vertical joint thickness of radial panels shall not be less than  $\frac{1}{8}$  inch (3.2 mm). The bed joint thickness tolerance shall be minus  $\frac{1}{16}$  inch (1.6 mm) and plus  $\frac{1}{8}$

inch (3.2 mm). The head joint thickness tolerance shall be plus or minus 1/8 inch (3.2 mm).

**2104.1.2.5 All units.** Units shall be placed while the mortar is soft and plastic. Any unit disturbed to the extent that the initial bond is broken after initial positioning shall be removed and relaid in fresh mortar.

**2104.1.3 Installation of wall ties.** The ends of wall ties shall be embedded in mortar joints. Wall tie ends shall engage outer face shells of hollow units by at least 1/2 inch (12.7 mm). Wire wall ties shall be embedded at least 1 1/2 inches (38 mm) into the mortar bed of solid masonry units or solid-grouted hollow units. Wall ties shall not be bent after being embedded in grout or mortar.

**2104.1.4 Chases and recesses.** Chases and recesses shall be constructed as masonry units are laid. Masonry directly above chases or recesses wider than 12 inches (305 mm) shall be supported on lintels.

**2104.1.5 Lintels.** The design of masonry lintels shall be in accordance with the masonry design provisions of either Section 2107 or 2108. Minimum length of end support shall be 4 inches (102 mm).

**2104.1.6 Support on wood.** Masonry shall not be supported on wood girders or other forms of wood construction except as permitted in Section 2304.12.

**2104.1.7 Masonry protection.** The top of unfinished masonry work shall be covered to protect the masonry from the weather.

**2104.1.8 Weep holes.** Weep holes shall be provided in the exterior wythe of masonry walls and shall be at a maximum spacing of 33 inches (838 mm) on center (o.c.). Weep holes shall not be less than 3/16 inch (4.8 mm) in diameter.

**2104.2 Corbeled masonry.** The maximum corbeled projection beyond the face of the wall shall not be more than one-half of the wall thickness nor one-half the wythe thickness for hollow walls. The maximum projection of one unit shall neither exceed one-half the height of the unit nor one-third the thickness at right angles to the wall.

**2104.2.1 Molded cornices.** Unless structural support and anchorage are provided to resist the overturning moment, the center of gravity of projecting masonry or molded cornices shall lie within the middle one-third of the supporting wall. Terra cotta and metal cornices shall be provided with a structural frame of approved noncombustible material anchored in a manner approved by the commissioner.

**2104.3 Cold weather construction.** The cold weather construction provisions of ACI 530.1/ASCE 6/TMS 602, Article 1.8 C, or the following procedures shall be implemented when either the ambient temperature falls below 40°F (4°C) or the temperature of

masonry units is below 40°F (4°C).

### **2104.3.1 Preparation.**

1. Temperatures of masonry units shall not be less than 20°F (-7°C) when laid in the masonry. Masonry units containing frozen moisture, visible ice or snow on their surface shall not be laid.
2. Visible ice and snow shall be removed from the top surface of existing foundations and masonry to receive new construction. These surfaces shall be heated to above freezing, using methods that do not result in damage.
3. No salt or other chemicals for the purpose of lowering the freezing temperature of water shall be permitted in the mortar mix.

**2104.3.2 Construction.** The following requirements shall apply to work in progress and shall be based on ambient temperature.

**2104.3.2.1 Construction requirements for temperatures between 40°F (4°C) and 32°F (0°C).** The following construction requirements shall be met when the ambient temperature is between 40°F (4°C) and 32°F (0°C):

1. Glass unit masonry shall not be laid.
2. Water and aggregates used in mortar and grout shall not be heated above 140°F (60°C).
3. Mortar sand or mixing water shall be heated to produce mortar temperatures between 40°F (4°C) and 120°F (49°C) at the time of mixing. When water and aggregates for grout are below 32°F (0°C), they shall be heated.

**2104.3.2.2 Construction requirements for temperatures between 32°F (0°C) and 25°F (-4°C).** The requirements of Section 2104.3.2.1 and the following construction requirements shall be met when the ambient temperature is between 32°F (0°C) and 25°F (-4°C):

1. The mortar temperature shall be maintained above freezing until used in masonry.
2. Aggregates and mixing water for grout shall be heated to produce grout temperatures between 70°F (21°C) and 120°F (49°C) at the time of mixing. Grout temperature shall be maintained above 70°F (21°C) at the time of grout placement.

**2104.3.2.3 Construction requirements for temperatures between 25°F (-4°C) and 20°F (-7°C).** The requirements of Sections 2104.3.2.1 and 2104.3.2.2 and the following construction requirements shall be met when the ambient temperature is between 25°F (-4°C) and 20°F (-7°C):

1. Masonry surfaces under construction shall be heated to 40°F (4°C).
2. Wind breaks or enclosures shall be provided when the wind velocity exceeds 15 miles per hour (mph) (24 km/h).
3. Prior to grouting, masonry shall be heated to a minimum of 40°F (4°C).

**2104.3.2.4. Construction requirements for temperatures below 20°F (-7°C).** The requirements of Sections 2104.3.2.1, 2104.3.2.2 and 2104.3.2.3 and the following construction requirement shall be met when the ambient temperature is below 20°F (-7°C): Enclosures and auxiliary heat shall be provided to maintain air temperature within the enclosure to above 32°F (0°C).

**2104.3.3 Protection.** The requirements of this section and Sections 2104.3.3.1 through 2104.3.3.4 apply after the masonry is placed and shall be based on anticipated minimum daily temperature for grouted masonry and anticipated mean daily temperature for ungrouted masonry.

**2104.3.3.1 Glass unit masonry.** The temperature of glass unit masonry shall be maintained above 40°F (4°C) for 48 hours after construction.

**2104.3.3.2 Protection requirements for temperatures between 40°F (4°C) and 25°F (-4°C).** When the temperature is between 40°F (4°C) and 25°F (-4°C), newly constructed masonry shall be covered with a weather-resistive membrane for 24 hours after being completed.

**2104.3.3.3 Protection requirements for temperatures between 25°F (-4°C) and 20°F (-7°C).** When the temperature is between 25°F (-4°C) and 20°F (-7°C), newly constructed masonry shall be completely covered with weather-resistive insulating blankets, or equal protection, for 24 hours after being completed. The time period shall be extended to 48 hours for grouted masonry, unless the only cement in the grout is Type III portland cement.

**2104.3.3.4 Protection requirements for temperatures below 20°F (-7°C).** When the temperature is below 20°F (-7°C), newly constructed masonry shall be maintained at a temperature above 32°F (0°C) for at least 24 hours after being completed by using heated enclosures, electric heating blankets, infrared lamps or other acceptable methods. The time period shall be extended to 48 hours for grouted masonry, unless the only cement in the grout is Type III portland cement.

**2104.4 Hot weather construction.** The hot weather construction provisions of ACI 530.1/ASCE 6/TMS 602, Article 1.8 D, or the following procedures shall be implemented when the temperature or the temperature and wind-velocity limits of this section are exceeded.

**2104.4.1 Preparation.** The following requirements shall be met prior to conducting masonry work.

**2104.4.1.1 Temperature.** When the ambient temperature exceeds 100°F (38°C), or exceeds 90°F (32°C) with a wind velocity greater than 8 mph (13 km/h):

1. Necessary conditions and equipment shall be provided to produce mortar having a temperature below 120°F (49°C).
2. Sand piles shall be maintained in a damp, loose condition.

**2104.4.1.2 Special conditions.** When the ambient temperature exceeds 115°F (46°C), or 105°F (40°C) with a wind velocity greater than 8 mph (13 km/h), the requirements of Section 2104.4.1.1 shall be implemented, and materials and mixing equipment shall be shaded from direct sunlight.

**2104.4.2 Construction.** The following requirements shall be met while masonry work is in progress.

**2104.4.2.1 Temperature.** When the ambient temperature exceeds 100°F (38°C), or exceeds 90°F (32°C) with a wind velocity greater than 8 mph (13 km/h):

1. The temperature of mortar and grout shall be maintained below 120°F (49°C).
2. Mixers, mortar transport containers and mortar boards shall be flushed with cool water before they come into contact with mortar ingredients or mortar.
3. Mortar consistency shall be maintained by retempering with cool water.
4. Mortar shall be used within 2 hours of initial mixing.

**2104.4.2.2 Special conditions.** When the ambient temperature exceeds 115°F (46°C), or exceeds 105°F (40°C) with a wind velocity greater than 8 mph (13 km/h), the requirements of Section 2104.4.2.1 shall be implemented and cool mixing water shall be used for mortar and grout. The use of ice shall be permitted in the mixing water prior to use. Ice shall not be permitted in the mixing water when added to the other mortar or grout materials.



**2104.4.3 Protection.** When the mean daily temperature exceeds 100°F (38°C), or exceeds 90°F (32°C) with a wind velocity greater than 8 mph (13 km/h), newly constructed masonry shall be fog sprayed until damp at least three times a day until the masonry is three days old.

**2104.5 Wetting of brick.** Brick (clay or shale) at the time of laying shall require wetting if the unit's initial rate of water absorption exceeds 21.42 grams per 30 square inches (19 355 mm<sup>2</sup>) per minute or 0.025 ounce psi (1 g/645 mm<sup>2</sup>), as determined by ASTM C 67.

## **SECTION BC 2105** **QUALITY ASSURANCE**

**2105.1 General.** A quality assurance program shall be used to ensure that the constructed masonry is in compliance with the construction documents. The quality assurance program shall comply with the inspection and testing requirements of Chapter 17.

### **2105.2 Acceptance relative to strength requirements.**

**2105.2.1 Compliance with  $f'_m$ .** Compressive strength of masonry shall be considered satisfactory if the compressive strength of each masonry wythe and grouted collar joint equals or exceeds the value of  $f'_m$ .

**2105.2.2 Determination of compressive strength.** The compressive strength for each wythe shall be determined by the unit strength method or by the prism test method as specified herein.

#### **2105.2.2.1 Unit strength method.**

**2105.2.2.1.1 Clay masonry.** The compressive strength of masonry shall be determined based on the strength of the units and the type of mortar specified using Table 2105.2.2.1.1, provided:

1. Units conform to ASTM C 62, ASTM C 216 or ASTM C 652 and are sampled and tested in accordance with ASTM C 67.
2. Thickness of bed joints does not exceed  $\frac{5}{8}$  inch (15.9 mm).
3. For grouted masonry, the grout meets one of the following requirements:
  - 3.1. Grout conforms to ASTM C 476.
  - 3.2. Minimum grout compressive strength equals  $f'_m$  but not less than 2,000 psi (13.79 MPa). The compressive strength of grout shall be determined in accordance with ASTM C 1019.

**TABLE 2105.2.2.1.1**  
**COMPRESSIVE STRENGTH OF CLAY MASONRY**  
**(Table 2105.2.2.1.1 attached at the end of document)**

**2105.2.2.1.2 Concrete masonry.** The compressive strength of masonry shall be determined based on the strength of the unit and type of mortar specified using Table 2105.2.2.1.2, provided:

1. Units conform to ASTM C 55 or ASTM C 90 and are sampled and tested in accordance with ASTM C 140.
2. Thickness of bed joints does not exceed  $\frac{5}{8}$  inch (15.9 mm).
3. For grouted masonry, the grout meets one of the following requirements:
  - 3.1. Grout conforms to ASTM C 476.
  - 3.2. Minimum grout compressive strength equals  $f'_m$  but not less than 2,000 psi (13.79 MPa). The compressive strength of grout shall be determined in accordance with ASTM C 1019.

**TABLE 2105.2.2.1.2**  
**COMPRESSIVE STRENGTH OF CONCRETE MASONRY**  
**(Table 2105.2.2.1.1 attached to end of document)**

**2105.2.2.2 Prism test method.**

**2105.2.2.2.1 General.** The compressive strength of masonry shall be determined by the prism test method:

1. Where specified in the construction documents.
2. Where masonry does not meet the requirements for application of the unit strength method in Section 2105.2.2.1.

**2105.2.2.2.2 Number of prisms per test.** A prism test shall consist of three prisms constructed and tested in accordance with ASTM C 1314.

**2105.3 Testing prisms from constructed masonry.** When approved by the commissioner acceptance of masonry that does not meet the requirements of Section 2105.2.2.1 or 2105.2.2.2 shall be permitted to be based on tests of prisms cut from the masonry construction in accordance with Sections 2105.3.1, 2105.3.2 and 2105.3.3.

**2105.3.1 Prism sampling and removal.** A set of three masonry prisms that are at least 28 days old shall be saw cut from the masonry for each 5,000 square feet (465 m<sup>2</sup>) of the wall area that is in question but not less than one set of three masonry prisms for the project. The length, width and height dimensions of the prisms shall comply with the requirements of ASTM C 1314. Transporting, preparation and testing of prisms shall be in accordance with ASTM C 1314.

**2105.3.2 Compressive strength calculations.** The compressive strength of prisms shall be the value calculated in accordance ASTM C 1314, except that the net cross-sectional area of the prism shall be based on the net mortar bedded area.

**2105.3.3 Compliance.** Compliance with the requirement for the specified compressive strength of masonry,  $f'_{m_s}$ , shall be considered satisfied provided the modified compressive strength equals or exceeds the specified  $f'_{m_s}$ . Additional testing of specimens cut from locations in question shall be permitted.

## **SECTION BC 2106** **SEISMIC DESIGN**

**2106.1 Seismic design requirements for masonry.** Masonry structures and components shall comply with the requirements in Section 1.13.2.2 of ACI 530/ASCE 5/TMS 402 and Section 1.13.3, 1.13.4, 1.13.5, 1.13.6 or 1.13.7 of ACI 530/ASCE 5/TMS 402 depending on the structure's seismic design category as determined in Section 1616.3. All masonry walls, unless isolated on three edges from in-plane motion of the basic structural systems, shall be considered to be part of the seismic-force-resisting system. In addition, the following requirements shall be met.

**2106.1.1 Basic seismic-force-resisting system.** Buildings relying on masonry shear walls as part of the basic seismic-force-resisting system shall comply with Section 1.13.2.2 of ACI 530/ASCE 5/TMS 402 or with Section 2106.1.1.1, 2106.1.1.2 or 2106.1.1.3.

**2106.1.1.1 Ordinary plain prestressed masonry shear walls.** Ordinary plain prestressed masonry shear walls shall comply with the requirements of Chapter 4 of ACI 530/ASCE 5/TMS 402.

**2106.1.1.2 Intermediate prestressed masonry shear walls.** Intermediate prestressed masonry shear walls shall comply with the requirements of Section 1.13.2.2.4 of ACI 530/ASCE 5/TMS 402 and shall be designed by Chapter 4, Section 4.5.3.3, of ACI 530/ASCE 5/TMS 402 for flexural strength and by Section 3.2.4.1.2 of ACI 530/ASCE 5/TMS 402 for shear strength. Sections 1.13.2.2.5(a), 3.2.3.5 and 3.2.4.3.2(c) of ACI 530/ASCE 5/TMS 402 shall be applicable for reinforcement. Flexural elements subjected to load reversals shall be symmetrically reinforced. The nominal moment strength at any section along a member shall not be less than one-fourth the maximum moment strength. The

cross-sectional area of bonded tendons shall be considered to contribute to the minimum reinforcement in Section 1.13.2.2.4 of ACI 530/ASCE 5/TMS 402. Tendons shall be located in cells that are grouted the full height of the wall.

**2106.1.1.3 Special prestressed masonry shear walls.** Special prestressed masonry shear walls shall comply with the requirements of Section 1.13.2.2.5 of ACI 530/ASCE 5/TMS 402 and shall be designed by Chapter 4, Section 4.5.3.3, of ACI 530/ASCE 5/TMS 402 for flexural strength and by Section 3.2.4.1.2 of ACI 530/ASCE 5/TMS 402 for shear strength. Sections 1.13.2.2.5(a), 3.2.3.5 and 3.2.4.3.2(c) of ACI 530/ASCE 5/TMS 402 shall be applicable for reinforcement. Flexural elements subjected to load reversals shall be symmetrically reinforced. The nominal moment strength at any section along a member shall not be less than one-fourth the maximum moment strength. The cross-sectional area of bonded tendons shall be considered to contribute to the minimum reinforcement in Section 1.13.2.2.5 of ACI 530/ASCE 5/TMS 402. Special prestressed masonry shear walls shall also comply with the requirements of Section 3.2.3.5 of ACI 530/ASCE 5/TMS 402.

**2106.1.1.3.1 Prestressing tendons.** Prestressing tendons shall consist of bars conforming to ASTM A 722.

**2106.1.1.3.2 Grouting.** All cells of the masonry wall shall be grouted.

**2106.2 Anchorage of masonry walls.** Masonry walls shall be anchored to the roof and floors that provide lateral support for the wall in accordance with Section 1604.8.2.

**2106.3 Seismic Design Category B.** Structures assigned to Seismic Design Category B shall conform to the requirements of Section 1.13.4 of ACI 530/ASCE 5/TMS 402.

**2106.3.1 Masonry walls not part of the lateral-force-resisting system.** Masonry partition walls, masonry screen walls and other masonry elements that are not designed to resist vertical or lateral loads, other than those induced by their own mass, shall be isolated from the structure so that the vertical and lateral forces are not imparted to these elements. Isolation joints and connectors between these elements and the structure shall be designed to accommodate the design story drift.

**2106.4 Seismic Design Category C.** Structures assigned to Seismic Design Category C shall conform to the requirements of Section 1.13.5 of ACI 530/ASCE 5/TMS 402 and the additional requirements of this section.

**2106.4.1 Design of discontinuous members that are part of the lateral-force-resisting system.** Columns and pilasters that are part of the lateral-force-resisting system and that support reactions from discontinuous stiff members such as walls shall be provided with transverse reinforcement spaced at no more than one-fourth of the least nominal dimension of the column or pilaster. The minimum transverse

reinforcement ratio shall be 0.0015. Beams supporting reactions from discontinuous walls or frames shall be provided with transverse reinforcement spaced at no more than one-half of the nominal depth of the beam. The minimum transverse reinforcement ratio shall be 0.0015.

**2106.4.2 Masonry walls not part of the lateral-force-resisting system.** Masonry partition walls, masonry screen walls and other masonry elements that are not designed to resist vertical or lateral loads, other than those loads induced by their own mass, shall be isolated from the structure so that the vertical and lateral forces are not imparted to these elements. Isolation joints and connectors between these elements and the structure shall be designed to accommodate the design story drift.

**2106.5 Seismic Design Category D.** Structures assigned to Seismic Design Category D shall conform to the requirements of Section 2106.4, Section 1.13.6 of ACI 530/ASCE 5/TMS 402 and the additional requirements of this section.

**2106.5.1 Loads for shear walls designed by the working stress design method.** When calculating in-plane shear or diagonal tension stresses by the working stress design method, shear walls that resist seismic forces shall be designed to resist 1.5 times the forces required by Chapter 16. The 1.5 multiplier need not be applied to the overturning moment.

**2106.5.2 Shear wall shear strength.** For a shear wall whose nominal shear strength exceeds the shear corresponding to development of its nominal flexural strength, two shear regions exist.

For all cross sections within a region defined by the base of the shear wall and a plane at a distance  $L_w$  above the base of the shear wall, the nominal shear strength shall be determined by Equation 21-1.

**(Equation 21-1 attached to end of document)**

The required shear strength for this region shall be calculated at a distance  $L_w/2$  above the base of the shear wall, but not to exceed one-half story height.

For the other region, the nominal shear strength of the shear wall shall be determined from Section 2108.

**2106.6 Reserved.**

## **SECTION BC 2107** **WORKING STRESS DESIGN**

**2107.1 General.** The design of masonry structures using working stress design shall comply with Section 2106 and the requirements of Chapters 1 and 2, except Section

2.1.2.1 and 2.1.3.3 of ACI 530/ASCE 5/TMS 402. The text of ACI 530/ASCE 5/TMS 402 shall be modified as follows.

**2107.2 Modifications to ACI 530/ASCE 5/TMS 402.**

**2107.2.1 ACI 530/ASCE 5/TMS 402, Chapter 2.** Special inspection during construction shall be provided as set forth in Section 1704.5.

**2107.2.2 ACI 530/ASCE 5/TMS 402, Section 2.1.6.** Masonry columns used only to support light-frame roofs of carports, porches, sheds or similar structures with a maximum area of 450 square feet (41.8 m<sup>2</sup>) assigned to Seismic Design Category B or C are permitted to be designed and constructed as follows:

1. Concrete masonry materials shall be in accordance with Section 2103.1. Clay or shale masonry units shall be in accordance with Section 2103.2.
2. The nominal cross-sectional dimension of columns shall not be less than 8 inches (203 mm).
3. Columns shall be reinforced with not less than one No. 4 bar centered in each cell of the column.
4. Columns shall be grouted solid.
5. Columns shall not exceed 12 feet (3658 mm) in height.
6. Roofs shall be anchored to the columns. Such anchorage shall be capable of resisting the design loads specified in Chapter 16.
7. Where such columns are required to resist uplift loads, the columns shall be anchored to their footings with two No. 4 bars extending a minimum of 24 inches (610 mm) into the columns and bent horizontally a minimum of 15 inches (381 mm) in opposite directions into the footings. One of these bars is permitted to be the reinforcing bar specified in Item 3 above. The total weight of a column and its footing shall not be less than 1.5 times the design uplift load.

**2107.2.3 ACI 530/ASCE 5/TMS 402, Section 2.1.10.6.1.1, lap splices.** The minimum length of lap splices for reinforcing bars in tension or compression,  $l_{ld}$ , shall be calculated by Equation 21-2, but shall not be less than 15 inches (381 mm).

**(Equation 21-2 attached to end of document)**

**2107.2.4 ACI 530/ASCE 5/TMS 402, maximum bar size.** The bar diameter shall not exceed one-eighth of the nominal wall thickness and shall not exceed one-quarter

of the least dimension of the cell, course or collar joint in which it is placed.

**2107.2.5 ACI 530/ASCE 5/TMS 402, splices for large bars.** Reinforcing bars larger than No. 9 in size shall be spliced using mechanical connectors in accordance with ACI 530/ASCE 5/TMS 402, Section 2.1.10.6.3.

**2107.2.6 ACI 530/ASCE 5/TMS 402, Maximum reinforcement percentage.** Special reinforced masonry shear walls having a shear span ratio,  $M/Vd$ , equal to or greater than 1.0 and having an axial load,  $P$  greater than  $0.05 f'_m A_n$  which are subjected to in-plane forces, shall have a maximum reinforcement ratio,  $\rho_{max}$ , not greater than that computed as follows:

**(Equation 21-3 attached to end of document)**

## **SECTION BC 2108** **STRENGTH DESIGN OF MASONRY**

**2108.1 General.** The design of masonry structures using strength design shall comply with Section 2106 and the requirements of Chapters 1 and 3 of ACI 530/ASCE 5/TMS 402. The minimum nominal thickness for hollow clay masonry in accordance with Section 3.2.5.5 of ACI 530/ASCE 5/TMS 402 shall be 4 inches (102 mm). The text of ACI 530/ASCE 5/TMS 402 shall be modified as follows:

**2108.2 ACI 530/ASCE 5/TMS 402, Section 3.2.2(g).** Modify Section 3.2.2(g) as follows:

3.2.2(g). The relationship between masonry compressive stress and masonry strain shall be assumed to be defined by the following:

Masonry stress of  $0.80 f'_m$  shall be assumed uniformly distributed over an equivalent compression zone bounded by edges of the cross section and a straight line located parallel to the neutral axis at a distance,  $a = 0.80 c$ , from the fiber of maximum compressive strain. The distance,  $c$ , from the fiber of maximum strain to the neutral axis shall be measured perpendicular to that axis. For out-of-plane bending, the width of the equivalent stress block shall not be taken greater than six times the nominal thickness of the masonry wall or the spacing between reinforcement, whichever is less. For in-plane bending of flanged walls, the effective flange width shall not exceed six times the thickness of the flange.

**2108.3 ACI 530/ASCE 5/TMS 402, Section 3.2.3.4.** Modify Section 3.2.3.4 (b) and (c) as follows:

3.2.3.4 (b). A welded splice shall have the bars butted and welded to develop at least 125 percent of the yield strength,  $f_y$ , of the bar in tension or compression, as required. Welded splices shall be of ASTM A 706 steel reinforcement. Welded splices shall not

be permitted in plastic hinge zones of intermediate or special reinforced walls or special moment frames of masonry.

3.2.3.4 (c). Mechanical splices shall be classified as Type 1 or 2 according to Section 21.2.6.1 of ACI 318. Type 1 mechanical splices shall not be used within a plastic hinge zone or within a beam-column joint of intermediate or special reinforced masonry shear walls or special moment frames. Type 2 mechanical splices are permitted in any location within a member.

**2108.4 ACI 530/ASCE 5/TMS 402, Section 3.2.3.5.1.** Add the following text to Section 3.2.3.5.1:

For special prestressed masonry shear walls, strain in all prestressing steel shall be computed to be compatible with a strain in the extreme tension reinforcement equal to five times the strain associated with the reinforcement yield stress,  $f_y$ . The calculation of the maximum reinforcement shall consider forces in the prestressing steel that correspond to these calculated strains.

## **SECTION BC 2109** **EMPIRICAL DESIGN OF MASONRY**

**2109.1 General.** Empirically designed masonry shall conform to this chapter or Chapter 5 of ACI 530/ASCE 5/TMS 402.

**2109.1.1 Limitations.** Empirical masonry design shall not be utilized for any of the following conditions:

1. The design or construction of masonry in buildings assigned to Seismic Design Category D as specified in Section 1616, and the design of the seismic-force-resisting system for buildings assigned to Seismic Design Category B or C.
2. Buildings more than 35 feet (10 668 mm) in height which have masonry wall lateral-force-resisting systems.

In buildings that exceed one or more of the above limitations, masonry shall be designed in accordance with the engineered design provisions of Section 2107 or 2108.

**2109.2 Lateral stability.**

**2109.2.1 Shear walls.** Where the structure depends upon masonry walls for lateral stability, shear walls shall be provided parallel to the direction of the lateral forces resisted.



**2109.2.1.1 Shear wall thickness.** Minimum nominal thickness of masonry shear walls shall be 8 inches (203 mm).

**Exception:** Shear walls of one-story buildings are permitted to be a minimum nominal thickness of 6 inches (152 mm).

**2109.2.1.2 Cumulative length of shear walls.** In each direction in which shear walls are required for lateral stability, shear walls shall be positioned in two separate planes. The minimum cumulative length of shear walls provided shall be 0.4 times the long dimension of the building. Cumulative length of shear walls shall not include openings or any element whose length is less than one-half its height.

**2109.2.1.3 Maximum diaphragm ratio.** Masonry shear walls shall be spaced so that the length-to-width ratio of each diaphragm transferring lateral forces to the shear walls does not exceed the values given in Table 2109.2.1.3.

**TABLE 2109.2.1.3**  
**DIAPHRAGM LENGTH-TO-WIDTH RATIOS**  
**(Table 2109.2.1.3 attached to end of document)**

**2109.2.2 Roofs.** The roof construction shall be designed so as not to impart out-of-plane lateral thrust to the walls under roof gravity load.

**2109.2.3 Surface-bonded walls.** Dry-stacked, surface-bonded concrete masonry walls shall comply with the requirements of this code for masonry wall construction, except where otherwise noted in this section.

**2109.2.3.1 Strength.** Dry-stacked, surface-bonded concrete masonry walls shall be of adequate strength and proportions to support all superimposed loads without exceeding the allowable stresses listed in Table 2109.2.3.1. Allowable stresses not specified in Table 2109.2.3.1 shall comply with the requirements of ACI 530/ASCE 5/TMS 402.

**TABLE 2109.2.3.1**  
**ALLOWABLE STRESS GROSS CROSS-SECTIONAL AREA FOR DRY-STACKED, SURFACE-BONDED CONCRETE MASONRY WALLS**  
**(Table 2109.2.3.1 attached to end of document)**

**2109.2.3.2 Construction.** Construction of dry-stacked, surface-bonded masonry walls, including stacking and leveling of units, mixing and application of mortar and curing and protection shall comply with ASTM C 946.

**2109.3 Compressive stress requirements.**

**2109.3.1 Calculations.** Compressive stresses in masonry due to vertical dead plus live loads, excluding wind or seismic loads, shall be determined in accordance with Section 2109.3.2.1. Dead and live loads shall be in accordance with Chapter 16, with live load reductions as permitted in Section 1607.9.

**2109.3.2 Allowable compressive stresses.** The compressive stresses in masonry shall not exceed the values given in Table 2109.3.2. Stress shall be calculated based on specified rather than nominal dimensions.

**TABLE 2109.3.2**  
**ALLOWABLE COMPRESSIVE STRESSES FOR EMPIRICAL DESIGN OF**  
**MASONRY**  
**(Table 2109.3.2 attached to end of document)**

**2109.3.2.1 Calculated compressive stresses.** Calculated compressive stresses for single wythe walls and for multi-wythe composite masonry walls shall be determined by dividing the design load by the gross cross-sectional area of the member. The area of openings, chases or recesses in walls shall not be included in the gross cross-sectional area of the wall.

**2109.3.2.2 Multi-wythe walls.** The allowable stress shall be as given in Table 2109.3.2 for the weakest combination of the units used in each wythe.

**2109.4 Lateral support.**

**2109.4.1 Intervals.** Masonry walls shall be laterally supported in either the horizontal or vertical direction at intervals not exceeding those given in Table 2109.4.1.

**TABLE 2109.4.1**  
**WALL LATERAL SUPPORT REQUIREMENTS**  
**(Table 2109.4.1 attached to end of document)**

**2109.4.2 Thickness.** Except for cavity walls and cantilever walls, the thickness of a wall shall be its nominal thickness measured perpendicular to the face of the wall. For cavity walls, the thickness shall be determined as the sum of the nominal thicknesses of the individual wythes. For cantilever walls, except for parapets, the ratio of height-to-nominal thickness shall not exceed six for solid masonry or four for hollow masonry. For parapets, see Section 2109.5.5.

**2109.4.3 Support elements.** Lateral support shall be provided by cross-walls, pilasters, buttresses or structural frame members when the limiting distance is taken horizontally, or by floors, roofs acting as diaphragms or structural frame members when the limiting distance is taken vertically.

**2109.5 Thickness of masonry.** Minimum thickness requirements shall be based on

nominal dimensions of masonry.

**2109.5.1 Thickness of walls.** The thickness of masonry walls shall conform to the requirements of Section 2109.5.

**2109.5.2 Minimum thickness.** The minimum thickness of masonry bearing walls more than one story high shall be 8 inches (203 mm) where the height floor to floor does not exceed 12 feet (3658 mm), the floor live load does not exceed 60 pounds per square feet (psf) (0.156 kg/m<sup>2</sup>), and the roof is designed so that the dead load imparts no lateral thrust to the wall. Bearing walls of one-story buildings shall not be less than 6 inches (152 mm) thick. However, the overall thickness of cavity or masonry-bonded hollow walls shall not be less than 8 inches (203 mm), including cavity.

**2109.5.2.1 Walls above roof level.** Masonry walls above roof level, 12 feet (3658 mm) or less in height, enclosing stairways, machinery rooms, shafts, or penthouses, may be up to 8 inches (203 mm) thick and shall be considered as neither increasing the height nor requiring any increase in the thickness of the wall below.

**2109.5.3 Rubble stone walls.** The minimum thickness of rough or random or coursed rubble stone walls shall be 16 inches (406 mm).

**2109.5.4 Change in thickness.** Where walls of masonry of hollow units or masonry bonded hollow walls are decreased in thickness, a course or courses of solid masonry shall be interposed between the wall below and the thinner wall above, or special units or construction shall be used to transmit the loads from face shells or wythes above to those below.

**2109.5.5 Parapet walls.**

**2109.5.5.1 Minimum thickness.** Unreinforced parapet walls shall be at least 8 inches (203 mm) thick, and their height shall not exceed three times their thickness.

**2109.5.5.2 Parapet wall construction.** All cells in the hollow masonry units and all joints in solid, cavity, or masonry-bonded hollow wall construction shall be filled solid with mortar. All corners of masonry parapet walls shall be reinforced with joint reinforcement or its equivalent at vertical intervals not greater than 12 inches (305 mm). Such reinforcement shall extend around the corner for at least 4 feet (1219 mm) in both directions and splices shall be lapped at least 6 inches (152 mm).

**2109.5.5.3 Parapet anchorage.** Parapets of buildings taller than 35 feet (10 668 mm) shall be reinforced vertically and shall be anchored to the roof and floors that provide lateral support for the wall in accordance with section 1604.8.2.

**2109.5.5.4 Additional provisions.** Additional provisions for parapet walls are contained in Sections 1503.2 and 1503.3.

**2109.5.6 Foundation walls.** Foundation walls shall comply with the requirements of Sections 2109.5.6.1 and 2109.5.6.2.

**2109.5.6.1 Minimum thickness.** Minimum thickness for foundation walls shall comply with the requirements of Table 2109.5.6.1. The provisions of Table 2109.5.6.1 are only applicable where the following conditions are met:

1. The foundation wall does not exceed 8 feet (2438 mm) in height between lateral supports,
2. The terrain surrounding foundation walls is graded to drain surface water away from foundation walls,
3. Backfill is drained to remove ground water away from foundation walls,
4. Lateral support is provided at the top of foundation walls prior to back-filling,
5. The length of foundation walls between perpendicular masonry walls or pilasters is a maximum of three times the basement wall height,
6. The backfill is granular and soil conditions in the area are non-expansive, and
7. Masonry is laid in running bond using Type M or S mortar.

**TABLE 2109.5.6.1**  
**FOUNDATION WALL CONSTRUCTION**  
**(Table 2109.5.6.1 attached to end of document)**

**2109.5.6.2 Design requirements.** Where the requirements of Section 2109.5.6.1 are not met, foundation walls shall be designed in accordance with Section 1805.5.

**2109.5.7 Partitions.** The minimum thickness for partitions shall be as follows:

**Table 2109.5.7**  
**MINIMUM THICKNESS OF MASONRY PARTITIONS**  
**(Table 2109.5.7 attached to end of document)**

**2109.6 Bond.**

**2109.6.1 General.** The facing and backing of multi-wythe masonry walls shall be bonded in accordance with Section 2109.6.2, 2109.6.3 or 2109.6.4.

**2109.6.2 Bonding with masonry headers.**

**2109.6.2.1 Solid units.** Where the facing and backing (adjacent wythes) of solid masonry construction are bonded by means of masonry headers, no less than 4 percent of the wall surface of each face shall be composed of headers extending not less than 3 inches (76 mm) into the backing. The distance between adjacent full-length headers shall not exceed 24 inches (610 mm) either vertically or horizontally. In walls in which a single header does not extend through the wall, headers from the opposite sides shall overlap at least 3 inches (76 mm), or headers from opposite sides shall be covered with another header course overlapping the header below at least 3 inches (76 mm).

**2109.6.2.2 Hollow units.** Where two or more hollow units are used to make up the thickness of a wall, the stretcher courses shall be bonded at vertical intervals not exceeding 34 inches (864 mm) by lapping at least 3 inches (76 mm) over the unit below, or by lapping at vertical intervals not exceeding 17 inches (432 mm) with units that are at least 50 percent greater in thickness than the units below.

**2109.6.2.3 Masonry bonded hollow walls.** In masonry bonded hollow walls, the facing and backing shall be bonded so that not less than 4 percent of the wall surface of each face is composed of masonry bonded units extending not less than 3 inches (76 mm) into the backing. The distance between adjacent bonders shall not exceed 24 inches (610 mm) either vertically or horizontally.

**2109.6.3 Bonding with wall ties or joint reinforcement.**

**2109.6.3.1 Bonding with wall ties.** Except as required by Section 2109.6.3.1.1, where the facing and backing (adjacent wythes) of masonry walls are bonded with wire size W2.8 (MW 18) wall ties or metal wire of equivalent stiffness embedded in the horizontal mortar joints, there shall be at least one metal tie for each 4 ½ square feet (0.42 m<sup>2</sup>) of wall area. The maximum vertical distance between ties shall not exceed 24 inches (610 mm), and the maximum horizontal distance shall not exceed 36 inches (914 mm). Rods or ties bent to rectangular shape shall be used with hollow masonry units laid with the cells vertical. In other walls, the ends of ties shall be bent to 90-degree (1.57 rad) angles to provide hooks no less than 2 inches (51 mm) long. Wall ties shall be without drips. Additional bonding ties shall be provided at all openings, spaced not more than 36 inches (914 mm) apart around the perimeter and within 12 inches (305 mm) of the opening.

**2109.6.3.1.1 Bonding with adjustable wall ties.** Where the facing and backing (adjacent wythes) of masonry are bonded with adjustable wall ties,

there shall be at least one tie for each 1.77 square feet (0.16 m<sup>2</sup>) of wall area. Neither the vertical nor horizontal spacing of the adjustable wall ties shall exceed 16 inches (406 mm). The maximum vertical offset of bed joints from one wythe to the other shall be 1/4 inches (32 mm). The maximum clearance between connecting parts of the ties shall be 1/16 inch (1.6 mm). When pintle legs are used, ties shall have at least two wire size W2.8 (MW 18) legs.

**2109.6.3.2 Bonding with prefabricated joint reinforcement.** Where the facing and backing (adjacent wythes) of masonry are bonded with prefabricated joint reinforcement, there shall be at least one cross wire serving as a tie for each 2<sup>2</sup>/3 square feet (0.25 m<sup>2</sup>) of wall area. The vertical spacing of the joint reinforcing shall not exceed 24 inches (610 mm). Cross wires on prefabricated joint reinforcement shall not be less than W1.7 (MW 11) and shall be without drips. The longitudinal wires shall be embedded in the mortar.

#### **2109.6.4 Bonding with natural or cast stone.**

**2109.6.4.1 Ashlar masonry.** In ashlar masonry, bonder units, uniformly distributed, shall be provided to the extent of not less than 10 percent of the wall area. Such bonder units shall extend not less than 4 inches (102 mm) into the backing wall.

**2109.6.4.2 Rubble stone masonry.** Rubble stone masonry 24 inches (610 mm) or less in thickness shall have bonder units with a maximum spacing of 36 inches (914 mm) vertically and 36 inches (914 mm) horizontally, and if the masonry is of greater thickness than 24 inches (610 mm), shall have one bonder unit for each 6 square feet (0.56 m<sup>2</sup>) of wall surface on both sides.

#### **2109.6.5 Masonry bonding pattern.**

**2109.6.5.1 Masonry laid in running bond.** Each wythe of masonry shall be laid in running bond, head joints in successive courses shall be offset by not less than one-fourth the unit length or the masonry walls shall be reinforced longitudinally as required in Section 2109.6.5.2.

**2109.6.5.2 Masonry laid in stack bond.** Where unit masonry is laid with less head joint offset than in Section 2109.6.5.1, the minimum area of horizontal reinforcement placed in mortar bed joints or in bond beams spaced not more than 48 inches (1219 mm) apart, shall be 0.0003 times the vertical cross-sectional area of the wall.

#### **2109.7 Anchorage.**

**2109.7.1 General.** Masonry elements shall be anchored in accordance with Sections 2109.7.2 through 2109.7.4.

**2109.7.2 Intersecting walls.** Masonry walls depending upon one another for lateral support shall be anchored or bonded at locations where they meet or intersect by one of the methods indicated in Sections 2109.7.2.1 through 2109.7.2.5.

**2109.7.2.1 Bonding pattern.** Fifty percent of the units at the intersection shall be laid in an overlapping masonry bonding pattern, with alternate units having a bearing of not less than 3 inches (76 mm) on the unit below.

**2109.7.2.2 Steel connectors.** Walls shall be anchored by steel connectors having a minimum section of ¼ inch (6.4 mm) by 1½ inches (38 mm), with ends bent up at least 2 inches (51 mm) or with cross pins to form anchorage. Such anchors shall be at least 24 inches (610 mm) long and the maximum spacing shall be 48 inches (1219 mm).

**2109.7.2.3 Joint reinforcement.** Walls shall be anchored by joint reinforcement spaced at a maximum distance of 8 inches (203 mm). Longitudinal wires of such reinforcement shall be at least wire size W1.7 (MW 11) and shall extend at least 30 inches (762 mm) in each direction at the intersection.

**2109.7.2.4 Interior nonload-bearing walls.** Interior nonload-bearing walls shall be anchored at their intersection, at vertical intervals of not more than 16 inches (406 mm) with joint reinforcement or ¼-inch (6.4 mm) mesh galvanized hardware cloth.

**2109.7.2.5 Ties, joint reinforcement or anchors.** Other metal ties, joint reinforcement or anchors, if used, shall be spaced to provide equivalent area of anchorage to that required by this section and be approved by the commissioner.

**2109.7.3 Floor and roof anchorage.** Floor and roof diaphragms providing lateral support to masonry shall comply with the live loads in Section 1607.3 and shall be connected to the masonry in accordance with Sections 2109.7.3.1 through 2109.7.3.3.

**2109.7.3.1 Wood floor joists.** Wood floor joists bearing on masonry walls shall be anchored to the wall at intervals not to exceed 72 inches (1829 mm) by metal strap anchors. Joists parallel to the wall shall be anchored with metal straps spaced not more than 72 inches (1829 mm) o.c. extending over or under and secured to at least three joists. Blocking shall be provided between joists at each strap anchor.

**2109.7.3.1.1 Bearing details.** Concentrated loads shall be supported upon construction of solid masonry, concrete, or masonry of hollow units with cells filled with mortar, grout, or concrete and of sufficient height to distribute safely the loads to the wall or column, or other adequate provisions shall be made to distribute the loads.

**2109.7.3.1.2 Joists.** Solid construction for support under joists shall be at least 2 ¼ inches (57 mm) in height, and joists supported on such construction shall extend into the masonry at least 3 inches (76 mm).

**2109.7.3.1.3 Beams.** Solid construction for support under beams, girders, or other concentrated loads shall be at least 4 inches (102 mm) in height, and the bearing of beams shall extend into the masonry at least 4 inches (102 mm).

**2109.7.3.1.4 Isolated piers.** Isolated masonry piers shall be bonded as required for solid walls of the same thickness and shall be provided with adequate means for distributing the load at the top of the pier.

**2109.7.3.2 Steel floor joists.** Steel floor joists bearing on masonry walls shall be anchored to the wall with ¾-inch (9.5 mm) round bars, or their equivalent, spaced not more than 72 inches (1829 mm) o.c. Where joists are parallel to the wall, anchors shall be located at joist bridging.

**2109.7.3.3 Roof diaphragms.** Roof diaphragms shall be anchored to masonry walls with ½-inch-diameter (12.7 mm) bolts, 72 inches (1829 mm) o.c. or their equivalent. Bolts shall extend and be embedded at least 15 inches (381 mm) into the masonry, or be hooked or welded to not less than 0.20 square inch (0.02 m<sup>2</sup>) of bond beam reinforcement placed not less than 6 inches (152 mm) from the top of the wall.

**2109.7.4 Walls adjoining structural framing.** Where walls are dependent upon the structural frame for lateral support, they shall be anchored to the structural members with metal anchors or otherwise keyed to the structural members. Metal anchors shall consist of ½-inch (12.7 mm) bolts spaced at 48 inches (1219 mm) o.c. embedded 4 inches (102 mm) into the masonry, or their equivalent area.

**2109.7.4.1 Use of existing walls.** An existing masonry wall may be used in the alteration or extension of a building provided that it meets the requirements of this standard.

**2109.7.4.2 Walls of insufficient thickness.** Existing walls of masonry units that are structurally sound, but that are of insufficient thickness when increased in height, may be strengthened by an addition of similar masonry units laid in type M or S mortar. The foundations and lateral support shall be equivalent to those required for newly constructed walls under similar conditions. All such linings shall be thoroughly bonded into existing masonry by toothings to assure combined action of wall and lining. Toothings shall be distributed uniformly throughout the wall, and shall aggregate in vertical cross-sectional area at least 15 percent of the total surface area of the lining. Stresses in the masonry under the new conditions shall not exceed the allowable stresses.



**2109.7.4.3 Precautions during erection.** Temporary bracing shall be used wherever necessary to resist loads to which the walls may be subjected during erection. Such bracing shall remain in place as long as may be required for safety.

**2109.7.4.4 Horizontal joints.** All concrete framed buildings to be constructed over 35 feet (10 668 mm) in height (as measured from adjoining grade to the main roof level), whose exterior wythe are of cavity wall construction with steel lintels, shall have horizontal joints in the exterior wythe to prevent masonry distress induced by vertical shortening of the structural frame.

**2109.7.4.4.1 Joint minimum thickness.** Unless substantiated as indicated by 2109.7.4.4.2, horizontal joints shall be ¼ inch (6.4 mm) minimum thickness, with neoprene, polyethylene, or urethane gasket or equivalent joint filler filling the entire joint, except for a recess from the toe of the lintel angle to the exterior of the facing brick, to provide space for caulking. These joints shall be placed at each floor.

**2109.7.4.4.2 Joint thickness by analysis.** The applicant of record shall submit an engineering analysis establishing that proposed building horizontal joints spaced further apart than in 2109.7.4.4.1 are sufficient to provide for the effects of vertical shortening of the structural frame.

## **SECTION BC 2110** **GLASS UNIT MASONRY**

**2110.1 Scope.** This section covers the empirical requirements for non-load-bearing glass unit masonry elements in exterior or interior walls.

**2110.1.1 Limitations.** Solid or hollow approved glass block shall not be used in firewalls, party walls, fire barriers or fire partitions, or for load-bearing construction. Such blocks shall be erected with mortar and reinforcement in metal channel-type frames, structural frames, masonry or concrete recesses, embedded panel anchors as provided for both exterior and interior walls or other approved joint materials. Wood strip framing shall not be used in walls required to have a fire-resistance rating by other provisions of this code.

**Exception:** Glass-block assemblies having a fire protection rating of not less than ¾ hour shall be permitted as opening protectives in accordance with Section 715 in barriers and fire partitions that have a required fire-resistance rating of 1 hour and do not enclose exit stairways or exit passageways.

**2110.2 Units.** Hollow or solid glass-block units shall be standard or thin units.

**2110.2.1 Standard units.** The specified thickness of standard units shall be 3<sup>7</sup>/<sub>8</sub>

inches (98 mm).

**2110.2.2 Thin units.** The specified thickness of thin units shall be  $3\frac{1}{8}$  inches (79 mm) for hollow units or 3 inches (76 mm) for solid units.

### **2110.3 Panel size.**

**2110.3.1 Exterior standard-unit panels.** The maximum area of each individual exterior standard-unit panel shall be 144 square feet ( $13.4 \text{ m}^2$ ) when the design wind pressure is 20 psf ( $958 \text{ N/m}^2$ ). The maximum panel dimension between structural supports shall be 25 feet (7620 mm) in width or 20 feet (6096 mm) in height. The panel areas are permitted to be adjusted in accordance with Figure 2110.3.1 for other wind pressures.

#### **FIGURE 2110.3.1** **GLASS MASONRY DESIGN WIND LOAD RESISTANCE** **(Figure 2110.3.1 attached to end of document)**

**2110.3.2 Exterior thin-unit panels.** The maximum area of each individual exterior thin-unit panel shall be 85 square feet ( $7.9 \text{ m}^2$ ). The maximum dimension between structural supports shall be 15 feet (4572 mm) in width or 10 feet (3048 mm) in height. Thin units shall not be used in applications where the design wind pressure exceeds 20 psf ( $958 \text{ N/m}^2$ ).

**2110.3.3 Interior panels.** The maximum area of each individual standard-unit panel shall be 250 square feet ( $23.2 \text{ m}^2$ ). The maximum area of each thin-unit panel shall be 150 square feet ( $13.9 \text{ m}^2$ ). The maximum dimension between structural supports shall be 25 feet (7620 mm) in width or 20 feet (6096 mm) in height.

**2110.3.4 Solid units.** The maximum area of solid glass-block wall panels in both exterior and interior walls shall not be more than 100 square feet ( $9.3 \text{ m}^2$ ).

**2110.3.5 Curved panels.** The width of curved panels shall conform to the requirements of Sections 2110.3.1, 2110.3.2 and 2110.3.3, except additional structural supports shall be provided at locations where a curved section joins a straight section, and at inflection points in multi-curved walls.

### **2110.4 Support.**

**2110.4.1 Isolation.** Glass unit masonry panels shall be isolated so that in-plane loads are not imparted to the panel.

**2110.4.2 Vertical.** Maximum total deflection of structural members supporting glass unit masonry shall not exceed  $\frac{1}{600}$ .

**2110.4.3 Lateral.** Glass unit masonry panels more than one unit wide or one unit high shall be laterally supported along their tops and sides. Lateral support shall be provided by panel anchors along the top and sides spaced not more than 16 inches (406 mm) o.c. or by channel-type restraints. Glass unit masonry panels shall be recessed at least 1 inch (25 mm) within channels and chases. Channel-type restraints shall be oversized to accommodate expansion material in the opening and packing and sealant between the framing restraints and the glass unit masonry perimeter units. Lateral supports for glass unit masonry panels shall be designed to resist applied loads, or a minimum of 200 pounds per lineal feet (plf) (2919 N/m) of panel, whichever is greater.

**Exceptions:**

1. Lateral support at the top of glass unit masonry panels that are no more than one unit wide shall not be required.
2. Lateral support at the sides of glass unit masonry panels that are no more than one unit high shall not be required.

**2110.4.3.1 Single unit panels.** Single unit glass unit masonry panels shall conform to the requirements of Section 2110.4.3, except lateral support shall not be provided by panel anchors.

**2110.5 Expansion joints.** Glass unit masonry panels shall be provided with expansion joints along the top and sides at all structural supports. Expansion joints shall have sufficient thickness to accommodate displacements of the supporting structure, but shall not be less than  $\frac{3}{8}$  inch (9.5 mm) in thickness. Expansion joints shall be entirely free of mortar or other debris and shall be filled with resilient material. The sills of glass-block panels shall be coated with approved water-based asphaltic emulsion, or other elastic waterproofing material, prior to laying the first mortar course.

**2110.6 Mortar.** Mortar for glass unit masonry shall comply with Section 2103.7.

**2110.7 Reinforcement.** Glass unit masonry panels shall have horizontal joint reinforcement spaced not more than 16 inches (406 mm) on center, located in the mortar bed joint, and extending the entire length of the panel but not across expansion joints. Longitudinal wires shall be lapped a minimum of 6 inches (152 mm) at splices. Joint reinforcement shall be placed in the bed joint immediately below and above openings in the panel. The reinforcement shall have not less than two parallel longitudinal wires of size W1.7 (MW 11), and have welded cross wires of size W1.7 (MW 11).

**SECTION BC 2111**  
**MASONRY FIREPLACES**

**2111.1 Definition.** A masonry fireplace is a fireplace constructed of concrete or masonry. Masonry fireplaces shall be constructed in accordance with this section, Table 2111.1 and Figure 2111.1.

**TABLE 2111.1**  
**SUMMARY OF REQUIREMENTS FOR MASONRY FIREPLACES AND**  
**CHIMNEYS<sup>a</sup>**

**(Table 2111.1 attached to end of document)**

**FIGURE 2111.1**  
**FIREPLACE AND CHIMNEY DETAILS**  
**(Table 2111.1 attached to end of document)**

**2111.2 Footings and foundations.** Footings for masonry fireplaces and their chimneys shall be constructed of reinforced concrete or solid masonry at least 12 inches (305 mm) thick and shall extend at least 6 inches (152 mm) beyond the face of the fireplace or foundation wall on all sides. Footings shall be founded on natural undisturbed earth or engineered fill below frost depth. In areas not subjected to freezing, footings shall be at least 12 inches (305 mm) below finished grade. Foundations and footings shall be designed to support the fireplace loading and shall have a minimum fire resistance rating of three hours.

**2111.2.1 Ash dump clean-out.** Clean-out openings, located within foundation walls below fireboxes, when provided, shall be equipped with ferrous metal or masonry doors and frames constructed to remain tightly closed, except when in use. Clean outs shall be accessible and located so that ash removal will not create a hazard to combustible materials.

**2111.3 Seismic reinforcing.** Masonry or concrete fireplaces shall be constructed, anchored, supported and reinforced as required in this chapter. In Seismic Design Category D, masonry and concrete fireplaces shall be reinforced and anchored as detailed in Sections 2111.3.1, 2111.3.2, 2111.4 and 2111.4.1 for chimneys serving fireplaces. In Seismic Design Category B or C, reinforcement and seismic anchorage is not required.

**2111.3.1 Vertical reinforcing.** For fireplaces with chimneys up to 40 inches (1016 mm) wide, four No. 4 continuous vertical bars, anchored in the foundation, shall be placed in the concrete, between wythes of solid masonry or within the cells of hollow unit masonry and grouted in accordance with Section 2103.10. For fireplaces with chimneys greater than 40 inches (1016 mm) wide, two additional No. 4 vertical bars shall be provided for each additional 40 inches (1016 mm) in width or fraction thereof.

**2111.3.2 Horizontal reinforcing.** Vertical reinforcement shall be placed enclosed within ¼-inch (6.4 mm) ties or other reinforcing of equivalent net cross-sectional area, spaced not to exceed 18 inches (457 mm) on center in concrete; or placed in the

bed joints of unit masonry at a minimum of every 18 inches (457 mm) of vertical height. Two such ties shall be provided at each bend in the vertical bars.

**2111.4 Seismic anchorage.** Masonry and concrete chimneys in Seismic Design Category D shall be anchored at each floor, ceiling or roof line more than 6 feet (1829 mm) above grade, except where constructed completely within the exterior walls. Anchorage shall conform to the following requirements.

**2111.4.1 Anchorage.** Two  $\frac{3}{16}$ -inch by 1-inch (4.8 mm by 25 mm) straps shall be embedded a minimum of 12 inches (305 mm) into the chimney. Straps shall be hooked around the outer bars and extend 6 inches (152 mm) beyond the bend. Each strap shall be fastened to a minimum of four floor joists with two  $\frac{1}{2}$ -inch (12.7 mm) bolts.

**2111.5 Firebox walls.** Masonry fireboxes shall be constructed of solid masonry units, hollow masonry units grouted solid, stone or concrete. When a lining of firebrick at least 2 inches (51 mm) in thickness or other approved lining is provided, the minimum thickness of back and side-walls shall each be 8 inches (203 mm) of solid masonry, including the lining. The approved lining shall be able to withstand a temperature of 2000°F (1093°C) without cracking. The width of joints between firebricks shall not be greater than  $\frac{1}{4}$  inch (6.4 mm). When no lining is provided, the total minimum thickness of back and side-walls shall be 12 inches (305 mm) of solid masonry. Firebrick shall conform to ASTM C 27 or ASTM C 1261 and shall be laid with medium-duty refractory mortar conforming to ASTM C 199.

**2111.5.1 Steel fireplace units.** Steel fireplace units are permitted to be installed with solid masonry to form a masonry fireplace provided they are installed according to either the requirements of their listing or the requirements of this section. Steel fireplace units incorporating a steel firebox lining shall be constructed with steel not less than  $\frac{1}{4}$  inch (6.4 mm) in thickness, and an air-circulating chamber which is ducted to the interior of the building. The firebox lining shall be encased with solid masonry to provide a total thickness at the back and sides of not less than 8 inches (203 mm), of which not less than 4 inches (102 mm) shall be of solid masonry or concrete. Circulating air ducts employed with steel fireplace units shall be constructed of metal or masonry.

**2111.6 Firebox dimensions.** The firebox of a concrete or masonry fireplace shall have a minimum depth of 20 inches (508 mm). The throat shall not be less than 8 inches (203 mm) above the fireplace opening. The throat opening shall not be less than 4 inches (102 mm) in depth. The cross-sectional area of the passageway above the firebox, including the throat, damper and smoke chamber, shall not be less than the cross-sectional area of the flue.

**Exception:** Rumford fireplaces shall be permitted provided that the depth of the fireplace is at least 12 inches (305 mm) and at least one-third of the width of the

fireplace opening, and the throat is at least 12 inches (305 mm) above the lintel, and at least  $\frac{1}{20}$  the cross-sectional area of the fireplace opening.

**2111.7 Lintel and throat.** Masonry over a fireplace opening shall be supported by a lintel of noncombustible material. The minimum required bearing length on each end of the fireplace opening shall be 4 inches (102 mm). The fireplace throat or damper shall be located a minimum of 8 inches (203 mm) above the top of the fireplace opening.

**2111.7.1 Damper.** Masonry fireplaces shall be equipped with a ferrous metal damper located at least 8 inches (203 mm) above the top of the fireplace opening. Dampers shall be installed in the fireplace or at the top of the flue venting the fireplace, and shall be operable from the room containing the fireplace. Damper controls shall be permitted to be located in the fireplace. The damper shall be able to withstand distortion from binding, cracking or corrosion when exposed to the fireplace operating temperature.

**2111.8 Smoke chamber walls.** Smoke chamber walls shall be constructed of solid masonry units, hollow masonry units grouted solid, stone or concrete. Corbeling of masonry units shall not leave unit cores exposed to the inside of the smoke chamber. The inside surface of corbeled masonry shall be parged smooth. Where no lining is provided, the total minimum thickness of front, back and side walls shall be 8 inches (203 mm) of solid masonry. When a lining of firebrick at least 2 inches (51 mm) thick, or a lining of vitrified clay at least  $\frac{5}{8}$  inch (15.9 mm) thick, is provided, the total minimum thickness of front, back and side walls shall be 6 inches (152 mm) of solid masonry, including the lining. Firebrick shall conform to ASTM C 27 or ASTM C 1261 and shall be laid with refractory mortar conforming to ASTM C 199.

**2111.8.1 Smoke chamber dimensions.** The inside height of the smoke chamber from the fireplace throat to the beginning of the flue shall not be greater than the inside width of the fireplace opening. The inside surface of the smoke chamber shall not be inclined more than 45 degrees (0.76 rad) from vertical when prefabricated smoke chamber linings are used or when the smoke chamber walls are rolled or sloped rather than corbeled. When the inside surface of the smoke chamber is formed by corbeled masonry, the walls shall not be corbeled more than 30 degrees (0.52 rad) from vertical.

**2111.9 Hearth and hearth extension.** Masonry fireplace hearths and hearth extensions shall be constructed of concrete, ceramic tile, masonry or equivalent, supported by noncombustible materials, and reinforced to carry their own weight and all imposed loads. No combustible material shall remain against the underside of hearths or hearth extensions after construction.

**2111.9.1 Hearth thickness.** The minimum thickness of fireplace hearths shall be 4 inches (102 mm).

**2111.9.2 Hearth extension thickness.** The minimum thickness of hearth extensions shall be 2 inches (51 mm).

**Exception:** When the bottom of the firebox opening is raised at least 8 inches (203 mm) above the top of the hearth extension, a hearth extension of not less than  $\frac{3}{8}$ -inch-thick (9.5 mm) brick, concrete, stone, tile or other approved noncombustible material is permitted.

**2111.10 Hearth extension dimensions.** Hearth extensions shall extend at least 16 inches (406 mm) in front of, and at least 8 inches (203 mm) beyond, each side of the fireplace opening. Where the fireplace opening is 6 square feet (0.56 m<sup>2</sup>) or larger, the hearth extension shall extend at least 20 inches (508 mm) in front of, and at least 12 inches (305 mm) beyond, each side of the fireplace opening.

**2111.10.1 Elevated or overhanging fireplace.** Where a fireplace is elevated or overhangs a floor, the hearth extension shall also extend over the area under the fireplace.

**2111.11 Fireplace clearance.** Any portion of a masonry fireplace located in the interior of a building or within the exterior wall of a building shall have a clearance to combustibles of not less than 2 inches (51 mm) from the front faces and sides of masonry fireplaces and not less than 4 inches (102 mm) from the back faces of masonry fireplaces. The airspace shall not be filled, except to provide fireblocking in accordance with Section 2111.13.

**Exceptions:**

1. Masonry fireplaces listed and labeled for use in contact with combustibles in accordance with UL 127, and installed in accordance with the manufacturer's installation instructions, are permitted to have combustible material in contact with their exterior surfaces.
2. When masonry fireplaces are constructed as part of masonry or concrete walls, combustible materials shall not be in contact with the masonry or concrete walls less than 12 inches (306 mm) from the inside surface of the nearest firebox lining.
3. Exposed combustible trim and the edges of sheathing materials, such as wood siding, flooring and drywall, are permitted to abut the masonry fireplace sidewalls and hearth extension, in accordance with Figure 2111.11, provided such combustible trim or sheathing is a minimum of 12 inches (306 mm) from the inside surface of the nearest firebox lining.
4. Exposed combustible mantels or trim is permitted to be placed directly on the masonry fireplace front surrounding the fireplace opening provided such

combustible materials shall not be placed within 6 inches (153 mm) of a fireplace opening. Combustible material within 12 inches (306 mm) of the fireplace opening shall not project more than 1/8 inch (3.2 mm) for each 1-inch (25 mm) distance from such opening.

**FIGURE 2111.11**  
**ILLUSTRATION OF EXCEPTION TO FIREPLACE CLEARANCE**  
**PROVISION**

**(Figure 2111.11 attached to end of document)**

**2111.12 Mantel and trim.** Woodwork or other combustible materials shall not be placed within 6 inches (152 mm) of a fireplace opening. Combustible material within 12 inches (305 mm) of the fireplace opening shall not project more than 1/8 inch (3.2 mm) for each 1-inch (25mm) distance from such opening.

**2111.13 Fireplace fireblocking.** All spaces between fireplaces and floors and ceilings through which fireplaces pass shall be fire-blocked with approved noncombustible material securely fastened in place. The fire-blocking of spaces between wood joists, beams or headers shall be to a depth of 1 inch (25 mm) and shall only be placed on strips of metal or metal lath laid across the spaces between combustible material and the chimney.

**2111.14 Exterior air.** Factory-built or masonry fireplaces covered in this section shall be equipped with an exterior air supply to ensure proper fuel combustion unless the room is mechanically ventilated and controlled so that the indoor pressure is neutral or positive.

**2111.14.1 Factory-built fireplaces.** Exterior combustion air ducts for factory-built fireplaces shall be listed components of the fireplace, and installed according to the fireplace manufacturer's instructions.

**2111.14.2 Masonry fireplaces.** Listed combustion air ducts for masonry fireplaces shall be installed according to the terms of their listing and manufacturer's instructions.

**2111.14.3 Exterior air intake.** The exterior air intake shall be capable of providing all combustion air from the exterior of the dwelling. The exterior air intake shall not be located within the garage, attic, basement or crawl space of the dwelling nor shall the air intake be located at an elevation higher than the firebox. The exterior air intake shall be covered with a corrosion-resistant screen of 1/4-inch (6.4 mm) mesh.

**2111.14.4 Clearance.** Unlisted combustion air ducts shall be installed with a minimum 1-inch (25 mm) clearance to combustibles for all parts of the duct within 5 feet (1524 mm) of the duct outlet.

**2111.14.5 Passageway.** The combustion air passageway shall be a minimum of 6



square inches (3870 mm<sup>2</sup>) and not more than 55 square inches (0.035 m<sup>2</sup>), except that combustion air systems for listed fireplaces or for fireplaces tested for emissions shall be constructed according to the fireplace manufacturer's instructions.

**2111.14.6 Outlet.** The exterior air outlet is permitted to be located in the back or sides of the firebox chamber or within 24 inches (610 mm) of the firebox opening on or near the floor. The outlet shall be closable and designed to prevent burning material from dropping into concealed combustible spaces.

## **SECTION BC 2112** **MASONRY HEATERS**

**2112.1 Definition.** A masonry heater is a heating appliance constructed of concrete or solid masonry, hereinafter referred to as "masonry," having a mass of at least 1,760 pounds (800 kg), excluding the chimney and foundation, which is designed to absorb and store heat from a solid fuel fire built in the firebox by routing the exhaust gases through internal heat exchange channels in which the flow path downstream of the firebox includes at least one 180-degree (3.14 rad) change in flow direction before entering the chimney, and that delivers heat by radiation from the masonry surface of the heater that shall not exceed 230°F (110°C) except within 8 inches (203 mm) surrounding the fuel loading door(s).

**2112.2 Installation.** Masonry heaters may be installed only when their use is permitted by the *New York City Air Pollution Control Code*. When such use is permitted, masonry heaters shall be installed in accordance with ASTM E 1602. If permitted, such appliances shall be operated in compliance with the *New York City Air Pollution Control Code*.

**2112.3 Seismic reinforcing.** Seismic reinforcing shall not be required within the body of a masonry heater whose height is equal to or less than 2.5 times its body width and where the masonry chimney serving the heater is not supported by the body of the heater. Where the masonry chimney shares a common wall with the facing of the masonry heater, the chimney portion of the structure shall be reinforced in accordance with Sections 2113.3 and 2113.4.

**2112.4 Masonry heater clearance.** Wood or other combustible framing shall not be placed within 4 inches (102 mm) of the outside surface of a masonry heater, provided the wall thickness of the firebox is not less than 8 inches (203 mm) and the wall thickness of the heat exchange channels is not less than 5 inches (127 mm). A clearance of at least 8 inches (203 mm) shall be provided between the gas-tight capping slab of the heater and a combustible ceiling. The required space between the heater and combustible material shall be fully vented to permit the free flow of air around all heater surfaces.

## **SECTION BC 2113** **MASONRY CHIMNEYS**

**2113.1 General.** A masonry chimney is a chimney constructed of concrete or masonry, hereinafter referred to as “masonry.” Masonry chimneys shall be constructed, anchored, supported and reinforced as required in this chapter.

Chimneys shall be designed and constructed so as to provide the necessary draft and capacity for each appliance connected to them to completely exhaust the products of combustion to the outside air. The temperature on adjacent combustible surfaces shall not be raised above 160°F (71°C). Condensation shall not be allowed to develop to an extent that can cause deterioration of the chimney or vent.

In any case, the outlet shall be arranged so that the flue gases are not directed so that they jeopardize people, overheat combustible structures, or enter building openings in the vicinity of the outlet. Gas-fired appliances shall be vented in accordance with this code and NFPA 54.

Chimneys shall not be supported by the equipment they serve unless such equipment has been specifically designed for such loads.

**2113.1.1 Chimney adequacy for temperature and gas action.** Chimneys shall be of adequate structural strength, and resistant to the temperatures to which they may be subjected and to the corrosive action of gases.

**2113.1.2 Chimney caps.** Termination caps shall not be permitted and a 3 inch (76 mm) minimum drain shall be installed to receive collected water. A positive means shall be provided to prevent water from entering the appliance.

**Exception:** Termination caps shall be permitted on listed factory-built chimneys,

**2113.1.2.1 Decorative shrouds.** Decorative shrouds shall not be installed at the termination of factory-built chimneys except where such shrouds are listed and labeled for use with the specific factory-built chimney system and are installed in accordance with the manufacturers’ installation instructions.

**2113.1.3 Chimney linings.** The lining in chimneys shall not be considered as taking either compression or tension stresses.

**2113.1.4 Chimney expansion and contraction.** Expansion and contraction in chimney walls due to temperature variations shall be accommodated solely by the use of steel reinforcing rings.

**2113.1.5 Reinforcing Rings.** Reinforcing rings shall be provided at all changes in wall thickness, at the top of the chimney, and above and below all flue openings.

**2113.1.6 Adjoining chimneys and vents.** Adjoining chimneys and vents shall be in accordance with Sections 2113.1.6.1 to 2113.1.6.8.

**2113.1.6.1 Responsibility of owner of taller building.** Whenever a building is erected, enlarged, or increased in height so that any portion of such building, except chimneys or vents, extends higher than the top of any previously constructed chimneys or vents within 100 feet (30 480 mm), the owner of such new or altered building shall have the responsibility of altering such chimneys or vents to make them conform with the requirements of this chapter. A chimney or vent that is no longer connected with a fireplace or combustion or other equipment for which a chimney or vent was required, shall be exempt from this requirement. Such alterations shall be accomplished by one of the following means or a combination thereof:

1. Carry up the previously constructed chimneys or vents to the height required in this chapter.
2. Offset such chimneys or vents to a distance beyond that required in this chapter from the new or altered building provided that the new location of the outlet of the offset chimney or vent shall otherwise comply with the requirements of this chapter.
3. Such requirements shall not dispense with or modify any additional requirements that may be applicable pursuant to rules of the New York City Department of Environmental Protection.

**2113.1.6.2 Protection of draft.** After the alteration of a chimney or vent as required by this section, it shall be the responsibility of the owner of the new or altered building to provide any mechanical equipment or devices necessary to maintain the proper draft in the equipment.

**2113.1.6.3 Written notification.** The owner of the new or altered building shall notify the owner of the building affected in writing at least 45 days before starting the work required and request written consent to do such work. Such notice shall be accompanied by plans indicating the manner in which the proposed alterations are to be made.

**2113.1.6.4 Approval.** The plans and method of alteration shall be subject to the approval of the commissioner.

**2113.1.6.5 Refusal of consent.** If consent is not granted by the owner of the previously constructed building to do the alteration work required by this section, such owner shall signify his or her refusal in writing to the owner of the new or altered building and to the commissioner; and the owner of the new or altered building having submitted plans that conform to the requirements of this section, shall thereupon be released from any responsibility for the proper operation of the equipment due to loss of draft and for any health hazard or nuisance that may

occur as a result of the new or altered building. Such responsibilities shall then be assumed by the owner of the previously constructed building. Similarly, should such owner fail to grant consent within forty-five days from the date of written request or fail to signify his or her refusal, he or she shall then assume all responsibilities as prescribed above.

**2113.1.6.6 Procedure.** It shall be the obligation of the owner of the new or altered building to:

1. Schedule this work so as to create a minimum of disturbance to the occupants of the affected building; and
2. Provide such essential services as are normally supplied by the equipment while it is out of service; and
3. Where necessary, support such extended chimneys, vents and equipment from this building or to carry up such chimneys or vents within his or her building; and
4. Provide for the maintenance, repair, and/or replacement of such extensions and added equipment; and
5. Make such alterations of the same material as the original chimney or vent so as to maintain the same quality and appearance, except where the affected owner of the chimney or vent shall give his or her consent to do otherwise. All work shall be done in such fashion as to maintain the architectural aesthetics of the existing building. Where there is practical difficulty in complying strictly with the provisions of this Item, the commissioner may permit an equally safe alternative.

**2113.1.6.7 Existing violations.** Any existing violations on the previously constructed equipment shall be corrected by the owner of the equipment before any equipment is added or alterations made at the expense of the owner of the new or altered building.

**2113.1.6.8 Variance.** The commissioner may grant a variance in accordance with the provisions of this code.

**2113.2 Footings and foundations.** Foundations for masonry chimneys shall be constructed of concrete or solid masonry at least 12 inches (305 mm) thick and shall extend at least 6 inches (152 mm) beyond the face of the foundation or support wall on all sides. Footings shall be founded on natural undisturbed earth or engineered fill below frost depth. In areas not subjected to freezing, footings shall be at least 12 inches (305 mm) below finished grade.

**2113.3 Seismic reinforcing.** Masonry or concrete chimneys shall be constructed, anchored, supported and reinforced as required in this chapter. In Seismic Design Category D, masonry and concrete chimneys shall be reinforced and anchored as detailed in Sections 2113.3.1, 2113.3.2, and 2113.4. In Seismic Design Category B or C, reinforcement and seismic anchorage is not required.

**2113.3.1 Vertical reinforcing.** For chimneys up to 40 inches (1016 mm) wide, four No. 4 continuous vertical bars anchored in the foundation shall be placed in the concrete, between wythes of solid masonry or within the cells of hollow unit masonry and grouted in accordance with Section 2103.10. Grout shall be prevented from bonding with the flue liner so that the flue liner is free to move with thermal expansion. For chimneys greater than 40 inches (1016 mm) wide, two additional No. 4 vertical bars shall be provided for each additional 40 inches (1016 mm) in width or fraction thereof.

**2113.3.2 Horizontal reinforcing.** Vertical reinforcement shall be placed enclosed within ¼-inch (6.4 mm) ties, or other reinforcing of equivalent net cross-sectional area, spaced not to exceed 18 inches (457 mm) o.c. in concrete, or placed in the bed joints of unit masonry, at a minimum of every 18 inches (457 mm) of vertical height. Two such ties shall be provided at each bend in the vertical bars.

**2113.4 Seismic anchorage.** Masonry and concrete chimneys and foundations in Seismic Design Category D shall be anchored at each floor, ceiling or roof line more than 6 feet (1829 mm) above grade, except where constructed completely within the exterior walls. Anchorage shall conform to the following requirements.

**2113.4.1 Anchorage.** Two ¾/16-inch by 1-inch (4.8 mm by 25 mm) straps shall be embedded a minimum of 12 inches (305 mm) into the chimney. Straps shall be hooked around the outer bars and extend 6 inches (152 mm) beyond the bend. Each strap shall be fastened to a minimum of four floor joists with two ½-inch (12.7 mm) bolts.

**2113.5 Corbeling.** Masonry chimneys shall not be corbeled more than half of the chimney's wall thickness from a wall or foundation, nor shall a chimney be corbeled from a wall or foundation that is less than 12 inches (305 mm) in thickness unless it projects equally on each side of the wall, except that on the second story of a two-story dwelling, corbeling of chimneys on the exterior of the enclosing walls is permitted to equal the wall thickness. The projection of a single course shall not exceed one-half the unit height or one-third of the unit bed depth, whichever is less. No masonry shall be corbeled from hollow or cavity wall masonry units.

**2113.6 Changes in dimension.** The chimney wall or chimney flue lining shall not change in size or shape within 6 inches (152 mm) above or below where the chimney passes through floor components, ceiling components or roof components.

**2113.7 Offsets.** Where a masonry chimney is constructed with a fireclay flue liner surrounded by one wythe of masonry, the maximum offset shall be such that the centerline of the flue above the offset does not extend beyond the center of the chimney wall below the offset. Where the chimney offset is supported by masonry below the offset in an approved manner, the maximum offset limitations shall not apply. Each individual corbeled masonry course of the offset shall not exceed the projection limitations specified in Section 2113.5.

**2113.8 Additional load.** Chimneys shall not support loads other than their own weight unless they are designed and constructed to support the additional load. Masonry chimneys are permitted to be constructed as part of the masonry walls or concrete walls of the building.

**2113.9 Termination.** Chimneys serving appliances that operate at less than 600°F (316°C) shall extend at least 3 feet (914 mm) above the highest construction, such as a roof ridge, parapet wall, or penthouse, within 10 feet (3048 mm) of the chimney outlet, whether the construction is on the same building as the chimney or on another building. However, such constructions do not include other chimneys, vents, or open structural framing. Any chimney located beyond 10 feet (3048 mm) from such construction, but not more than the distance determined from Equation 21-5 and Table 2113.9, shall be at least as high as the construction.

Chimneys serving appliances that operate at between 600°F (316°C) and 1000°F (538°C) shall extend at least 10 feet (3048 mm) above the highest construction, such as a roof ridge, or parapet wall or penthouse within 20 feet (6096 mm) of the chimney outlet, whether the construction is on the same building as the chimney or on another building. However, such construction does not include other chimneys, vents or open structural framing. Any chimney located beyond 20 feet (6096 mm) from such construction, but not more than the distance determined from Equation 21-5 and Table 2113.9, shall be at least as high as the construction.

**(Equation 21-5 attached to end of document)**

**TABLE 2113.9**  
**“F” FACTOR FOR DETERMINING CHIMNEY DISTANCES**  
**(Table 2113.9 attached to end of document)**

**2113.9.1 Spark arrestors.** Where a spark arrestor is installed on a masonry chimney, the spark arrestor shall meet all of the following requirements:

- 1. The net free area of the arrestor shall not be less than four times the net free area of the outlet of the chimney flue it serves.**
- 2. The arrestor screen shall have heat and corrosion resistance equivalent to 19-gage galvanized steel or 24-gage stainless steel.**

3. Openings shall not permit the passage of spheres having a diameter greater than ½ inch (12.7 mm) nor block the passage of spheres having a diameter less than ⅜ inch (9.5 mm).
4. The spark arrestor shall be accessible for cleaning and the screen or chimney cap shall be removable to allow for cleaning of the chimney flue.

**2113.10 Wall thickness.** Masonry chimney walls shall be constructed of concrete, solid masonry units or hollow masonry units grouted solid with not less than 4 inches (102 mm) nominal thickness, or 8 inches (203 mm) nominal thickness for chimney walls extending more than 3 feet (914 mm) above the highest lateral support point.

**2113.11 Flue lining (material).** Masonry chimneys shall be lined. The lining material shall be appropriate for the type of appliance connected, according to the terms of the appliance listing and the manufacturer's instructions.

**2113.11.1 Residential-type appliances (general).** Flue lining systems shall comply with one of the following:

1. Clay flue lining complying with the requirements of ASTM C 315, or equivalent.
2. Listed chimney lining systems complying with UL 1777.
3. Factory-built chimneys or chimney units listed for installation within masonry chimneys.
4. Other approved materials that will resist corrosion, erosion, softening or cracking from flue gases and condensate at temperatures up to 1,800°F (982°C).

**2113.11.1.1 Flue linings for specific appliances.** Flue linings other than those covered in Section 2113.11.1 intended for use with specific appliances shall comply with Sections 2113.11.1.2 through 2113.11.1.4 and Sections 2113.11.2 and 2113.11.3.

**2113.11.1.2 Gas appliances.** Flue lining systems for gas appliances shall be in accordance with the *New York City Fuel Gas Code*.

**2113.11.1.3 Pellet fuel-burning appliances.** Pellet fuel-burning appliances may be installed only when their use is permitted by the *New York City Air Pollution Control Code*. Any such appliances shall be listed and labeled and shall be installed in accordance with the terms of the listing. If permitted, such appliances shall be operated in compliance with the *New York City Air Pollution Control*

Code. Flue lining and vent systems for use in masonry chimneys with pellet fuel-burning appliances shall be limited to flue lining systems complying with Section 2113.11.1 and pellet vents listed for installation within masonry chimneys (see Section 2113.11.1.5 for marking).

**2113.11.1.4 Oil-fired appliances approved for use with L-vent.** Flue lining and vent systems for use in masonry chimneys with oil-fired appliances approved for use with Type L vent shall be limited to flue lining systems complying with Section 2113.11.1 and listed chimney liners complying with UL 641 (see Section 2113.11.1.5 for marking).

**2113.11.1.5 Notice of usage.** When a flue is relined with a material not complying with Section 2113.11.1, the chimney shall be plainly and permanently identified by a label attached to a wall, ceiling or other conspicuous location adjacent to where the connector enters the chimney. The label shall include the following message or equivalent language: “This chimney is for use only with (type or category of appliance) that burns (type of fuel). Do not connect other types of appliances.”

## **2113.11.2 Concrete and masonry chimneys for medium heat appliances.**

**2113.11.2.1 General.** Concrete and masonry chimneys for medium-heat appliances shall comply with Sections 2113.1 through 2113.5.

**2113.11.2.2 Construction.** Chimneys for medium-heat appliances shall be constructed of solid masonry units or of concrete with walls a minimum of 8 inches (203 mm) thick, or with stone masonry a minimum of 12 inches (305 mm). Chimneys for medium-heat appliances constructed with radial brick may be permitted to have different requirements. Design of all such chimneys shall be submitted to the commissioner for approval.

**2113.11.2.3 Lining.** Concrete and masonry chimneys shall be lined with an approved medium-duty refractory brick a minimum of 4½ inches (114 mm) thick laid on the 4½-inch bed (114 mm) in an approved medium-duty refractory mortar. The lining shall start 2 feet (610 mm) or more below the lowest chimney connector entrance. Chimneys terminating 25 feet (7620 mm) or less above a chimney connector entrance shall be lined to the top.

**2113.11.2.4 Multiple passageway.** Concrete and masonry chimneys containing more than one passageway shall have the liners separated by a minimum 4-inch-thick (102 mm) concrete or solid masonry wall.

**2113.11.2.5 Termination height.** Chimneys serving appliances that operate at greater than 1,000°F (538°C) shall extend at least 20 feet (6096 mm) above the highest construction, such as roof ridge, parapet wall, penthouse, or other



obstruction within 50 feet (15 240 mm) of the chimney outlet, whether the construction is on the same building as the chimney or in another building. However, such construction does not include other chimneys, vents, or open structural framing. Any chimney located beyond 50 feet (15 240 mm) from such construction but not more than the distance determined from Equation 21-5 and Table 2113.9, shall be at least as high as the construction.

**2113.11.2.6 Clearance.** A minimum clearance of 4 inches (102 mm) shall be provided between the exterior surfaces of a concrete or masonry chimney for medium-heat appliances and combustible material.

### **2113.11.3 Concrete and masonry chimneys for high-heat appliances.**

**2113.11.3.1 General.** Concrete and masonry chimneys for high-heat appliances shall comply with Sections 2113.1 through 2113.5.

**2113.11.3.2 Construction.** Chimneys for high-heat appliances shall be constructed with double walls of solid masonry units or of concrete, each wall to be a minimum of 8 inches (203 mm) thick with a minimum airspace of 2 inches (51 mm) between the walls. Alternate chimney designs for high-heat appliances constructed with radial brick shall be permitted subject to the approval of the commissioner.

**2113.11.3.3 Lining.** The inside of the interior wall shall be lined with an approved high-duty refractory brick, a minimum of 4½ inches (114 mm) thick laid on the 4½-inch bed (114 mm) in an approved high-duty refractory mortar. The lining shall start at the base of the chimney and extend continuously to the top.

**2113.11.3.4 Termination height.** Concrete and masonry chimneys for high-heat appliances shall extend at least 20 feet (6069 mm) above the highest construction, such as roof ridge, parapet wall, penthouse, or other obstruction within 50 feet (15 240 mm) of the chimney outlet, whether the construction is on the same building as the chimney or on another building. However, such constructions do not include other chimneys, vents, or open structural framing. Any chimney located beyond 50 feet (15 240 mm) from such construction but not more than the distance determined from Equation 21-5 and Table 2113.9, shall be at least as high as the construction.

**2113.11.3.5 Clearance.** Concrete and masonry chimneys for high-heat appliances shall have approved clearance from buildings and structures to prevent overheating combustible materials, permit inspection and maintenance operations on the chimney and prevent danger of burns to persons.

**2113.12 Flue lining (installation).** Flue liners shall be installed in accordance with

ASTM C 1283 and extend from a point not less than 8 inches (203 mm) below the lowest inlet or, in the case of fireplaces, from the top of the smoke chamber, to a point above the enclosing walls. The lining shall be carried up vertically, with a maximum slope no greater than 30 degrees (0.52 rad) from the vertical. Fireclay flue liners shall be laid in medium-duty refractory mortar conforming to ASTM C 199, with tight mortar joints left smooth on the inside and installed to maintain an airspace or insulation not to exceed the thickness of the flue liner separating the flue liners from the interior face of the chimney masonry walls. Flue lining shall be supported on all sides. Only enough mortar shall be placed to make the joint and hold the liners in position.

### **2113.13 Additional requirements.**

**2113.13.1 Listed materials.** Listed materials used as flue linings shall be installed in accordance with the terms of their listings and the manufacturer's instructions.

**2113.13.2 Space around lining.** The space surrounding a chimney lining system or vent installed within a masonry chimney shall not be used to vent any other appliance.

**Exception:** This shall not prevent the installation of a separate flue lining in accordance with the manufacturer's instructions.

**2113.14 Multiple flues.** When two or more flues are located in the same chimney, masonry wythes shall be built between adjacent flue linings. The masonry wythes shall be at least 4 inches (102 mm) thick and bonded into the walls of the chimney.

**Exception:** When venting only one appliance, two flues are permitted to adjoin each other in the same chimney with only the flue lining separation between them. The joints of the adjacent flue linings shall be staggered at least 4 inches (102 mm).

**2113.15 Flue area (appliance).** Chimney flues shall not be smaller in area than the area of the connector from the appliance. Chimney flues connected to more than one appliance shall not be less than the area of the largest connector plus 50 percent of the areas of additional chimney connectors.

#### **Exceptions:**

1. Chimney flues serving oil-fired appliances sized in accordance with NFPA 31.
2. Chimney flues serving gas-fired appliances sized in accordance with the *New York City Fuel Gas Code*.

**2113.16 Flue area (masonry fireplace).** Flue sizing for chimneys serving fireplaces shall be in accordance with Section 2113.16.1 or 2113.16.2.

**2113.16.1 Minimum area.** Round chimney flues shall have a minimum net cross-sectional area of at least  $\frac{1}{12}$  of the fireplace opening. Square chimney flues shall have a minimum net cross-sectional area of at least  $\frac{1}{10}$  of the fireplace opening. Rectangular chimney flues with an aspect ratio less than 2 to 1 shall have a minimum net cross-sectional area of at least  $\frac{1}{10}$  of the fireplace opening. Rectangular chimney flues with an aspect ratio of 2 to 1 or more shall have a minimum net cross-sectional area of at least  $\frac{1}{8}$  of the fireplace opening.

**2113.16.2 Determination of minimum area.** The minimum net cross-sectional area of the flue shall be determined in accordance with Figure 2113.16. A flue size providing at least the equivalent net cross-sectional area shall be used. Cross-sectional areas of clay flue linings are as provided in Tables 2113.16(1) and 2113.16(2) or as provided by the manufacturer or as measured in the field. The height of the chimney shall be measured from the firebox floor to the top of the chimney flue.

**FIGURE 2113.16**  
**FLUE SIZES FOR MASONRY CHIMNEYS**  
**(Table 2113.16 attached to end of document)**

**TABLE 2113.16(1)**  
**NET CROSS-SECTIONAL AREA OF ROUND FLUE SIZES<sup>a</sup>**  
**(Table 2113.16(1) attached to end of document)**

**TABLE 2113.16(2)**  
**NET CROSS-SECTIONAL AREA OF SQUARE AND RECTANGULAR FLUE**  
**SIZES<sup>a</sup>**  
**(Table 2113.16(2) attached to end of document)**

**2113.17 Inlet.** Inlets to masonry chimneys shall enter from the side. Inlets shall have a thimble of fireclay, rigid refractory material or metal that will prevent the connector from pulling out of the inlet or from extending beyond the wall of the liner.

**2113.18 Masonry chimney cleanout openings.** Cleanout openings shall be provided within 6 inches (152 mm) of the base of each flue within every masonry chimney. The upper edge of the cleanout shall be located at least 6 inches (152 mm) below the lowest chimney inlet opening. The height of the opening shall be at least 6 inches (152 mm). The cleanout shall be provided with a noncombustible cover.

**Exception:** Chimney flues serving masonry fireplaces, where cleaning is possible through the fireplace opening.

**2113.19 Chimney clearances.** Any portion of a masonry chimney located in the interior of the building or within the exterior wall of the building shall have a minimum airspace clearance to combustibles of 2 inches (51 mm). Chimneys located entirely outside the exterior walls of the building, including chimneys that pass through the soffit or cornice,

shall have a minimum airspace clearance of 1 inch (25 mm). The airspace shall not be filled, except to provide fireblocking in accordance with Section 2113.20.

**Exceptions:**

1. Masonry chimneys equipped with a chimney lining system listed and labeled for use in chimneys in contact with combustibles in accordance with UL 1777, and installed in accordance with the manufacturer's instructions, are permitted to have combustible material in contact with their exterior surfaces.
2. Where masonry chimneys are constructed as part of masonry or concrete walls, combustible materials shall not be in contact with the masonry or concrete wall less than 12 inches (305 mm) from the inside surface of the nearest flue lining.
3. Exposed combustible trim and the edges of sheathing materials, such as wood siding, are permitted to abut the masonry chimney sidewalls, in accordance with Figure 2113.19, provided such combustible trim or sheathing is a minimum of 12 inches (305 mm) from the inside surface of the nearest flue lining. Combustible material and trim shall not overlap the corners of the chimney by more than 1 inch (25 mm).

**2113.19.1 Additional requirements for clearance.**

1. Trimmers shall be not less than 5 inches (127 mm) from the inside face of the concrete or masonry chimney wall. Finished flooring shall have at least one-half inch clearance from chimney walls.
2. A clearance of at least 2 inches (51 mm) shall be provided between the exterior surfaces of interior masonry or concrete chimneys for all wood-burning appliances.
3. No combustible lathing, furring, or plaster grounds shall be placed against a chimney at any point more than 1½ inches (38 mm) from the corner of the chimney; but this shall not prevent plastering directly on masonry or on metal lath and metal furring nor shall it prevent placing chimneys for low temperature equipment entirely on the exterior of a building against the sheathing.

**FIGURE 2113.19**

**ILLUSTRATION OF EXCEPTION TO CHIMNEY CLEARANCE PROVISION**

**(Figure 2113.19 attached to end of document)**

**2113.20 Chimney fireblocking.** All spaces between chimneys and floors and ceilings

through which chimneys pass shall be fireblocked with noncombustible material securely fastened in place. The fireblocking of spaces between wood joists, beams or headers shall be to a depth of 1 inch (25 mm) and shall only be placed on strips of metal or metal lath laid across the spaces between combustible material and the chimney.

**2113.21 Test run.** All new chimneys shall be test run by the registered design professional responsible for the testing under standard conditions to demonstrate fire safety and the complete exhausting of smoke and the products of combustion to the outer air. The results of such test run shall be certified as correct by the design professional engineer responsible for the test and shall be submitted in writing to the department.

**2113.22 Requirement of a smoke test.** A smoke test shall be made as outlined below. Any faults or leaks found shall be corrected. Such smoke test shall be witnessed by a representative of the commissioner. In lieu thereof, the commissioner may accept the test report of the design professional engineer responsible for the test, which shall be submitted in writing to the department.

**2113.22.1 Smoke test.** To determine the tightness of chimney construction, a smoke test shall be made in accordance with the following conditions and requirements:

1. The equipment, materials, power and labor necessary for such test shall be furnished by, and at the expense of, the owner or holder of the work permit.
2. If the test shows any evidence of leakage or other defects, such defects shall be corrected in accordance with the requirement of this chapter and the test shall be repeated until the results are satisfactory.
3. Method of test. The chimney shall be filled with a thick penetrating smoke produced by one or more smoke machines, or smoke bombs, or other equivalent method. As the smoke appears at the stack opening on the roof, such opening shall be tightly closed, and a pressure equivalent to ½ inch (12.7 mm) column of water measured at the base of the stack shall be applied. The test shall be conducted for a length of time sufficient to permit the inspection of the chimney.

## **SECTION BC 2114** **STRUCTURAL INTEGRITY REQUIREMENTS**

**2114.1 General.** Load-bearing masonry structures shall be reinforced to meet all of the requirements of this section. However, reinforcement provided for gravity, seismic or wind forces or for other purposes may be regarded as satisfying part of, or the whole of, these requirements. Reinforcement provided for one requirement may be counted towards the other requirements.

**2114.2 Continuity and ties.** Load-bearing masonry structures shall be reinforced to obtain a continuous system of vertical and horizontal ties. Continuity of all ties shall be ensured by providing lap, welded or mechanical tension splices. The following requirements shall be met for walls, columns and piers:

**2114.2.1 Horizontal.** At each floor and roof level, continuous horizontal ties shall be provided in all load-bearing masonry walls, and around the perimeter of the building. Minimum horizontal tie reinforcement shall be not less than the equivalent of two No. 4 bars.

**2114.2.1.1 Location of horizontal ties.** Ties shall be located within the thickness of walls or beams, where they occur, or within 1 foot (305 mm) of the edge of slab, where walls or beams do not occur.

**2114.2.1.2 End connections of horizontal ties.** All horizontal ties shall be terminated in a perpendicular horizontal tie. Where no perpendicular horizontal tie exists within 4 feet (1219 mm) of the end of a wall, the horizontal tie shall be anchored at the end of the wall. The vertical reinforcement at the end of such walls shall not be less than two No. 4 bars placed within 16 inches (406 mm) of the end of the wall. This vertical reinforcement shall be continuous from the lowest to highest level of the wall, and anchored at each end in a horizontal tie or the foundation element.

**2114.2.2 End connections.** Where slab or beam elements are supported on a masonry wall, column or pier, the connection shall be designed to sustain an axial tension capacity equal to the greater of the vertical shear capacity of the connected element at either end or two percent of the maximum factored vertical dead and live load in the compression masonry element. The design of the end connections shall ensure the transfer of such loads to horizontal or vertical ties.

Where more than one element frames in one direction, none of the elements or connections shall have an axial tension capacity of less than one percent of the vertical load.

For the design of the connections, the transverse shear force and the axial tensile force need not be considered to act simultaneously.

The reinforcement of the end connections shall be equivalent to at least one No. 4 bar, at a maximum spacing of 24 inches (610 mm) on center. Where end connections occur at a masonry pier or column, reinforcement equivalent to a minimum of four fully developed No. 4 bars shall be provided. The reinforcement shall be distributed around the perimeter of the column or pier. The minimum anchorage into both the slab and the masonry compression element shall be equivalent to the capacity of the fully developed No. 4 bar.

Where the floor extends on both sides of a bearing wall, the portion of the tie within the slab shall alternate between both sides.

**2114.2.3 Vertical ties.** Each column, pier and wall shall be vertically tied continuously from its lowest to highest level. The vertical reinforcement shall be terminated in a horizontal tie or foundation or their equivalent. Where openings in bearing walls greater than 24 inches (610 mm) in height occur, ties shall be provided at each side of the opening that extend and are anchored in the masonry above and below the opening. Vertical ties shall be placed on both sides of control joints in bearing walls.

**2114.2.3.1 Vertical ties reinforcing.** Vertical tie reinforcing shall not be less than the equivalent of one No. 4 bar, at a maximum spacing of 48 inches (1219 mm) on center. A minimum of four continuous No. 4 bars shall be provided per masonry column or pier.

$$V_n = A_n \rho_n f_y \quad (\text{Equation 21-1})$$

$$l_{ld} = \frac{0.16 d_b^2 f_y \gamma}{K \sqrt{f'_m}} \quad (\text{Equation 21-2})$$

$$\text{For SI: } l_{ld} = \frac{1.95 d_b^2 f_y \gamma}{K \sqrt{f'_m}}$$

where:

$d_b$  = Diameter of reinforcement, inches (mm).

$f_y$  = Specified yield stress of the reinforcement or the anchor bolt, psi (MPa).

$f'_m$  = Specified compressive strength of masonry at age of 28 days, psi (MPa).

$l_{ld}$  = Minimum lap splice length, inches (mm).

$K$  = The lesser of the masonry cover, clear spacing between adjacent reinforcement or five times  $d_b$ , inches (mm).

$\gamma$  = 1.0 for No. 3 through No. 5 reinforcing bars. 1.4 for No. 6 and No. 7 reinforcing bars. 1.5 for No. 8 through No. 9 reinforcing bars.

**{NOTE: DELETE SENTENCE UNDER EQUATION 21-3 BELOW}**

$$\rho_{\max} = \frac{n f'_m}{2 f_y \left( n + \frac{f_y}{f'_m} \right)} \quad (\text{Equation 21-3})$$

The maximum reinforcement ratio does not apply in the out-of-plane direction.

$$f_r = 3 W L_s / 2 b t^2 \quad (\text{Equation 21-4})$$

where, for the purposes of this section only:

$b$  = Width of the test specimen measured parallel to the loading cylinder, inches (mm).

$f_r$  = Modulus of rupture, psi (MPa).

$L_s$  = Distance between supports, inches (mm).

$t$  = Thickness of the test specimen measured parallel to the direction of load, inches (mm).

$W$  = The applied load at failure, pounds (N).



**(Equation 21-5)**

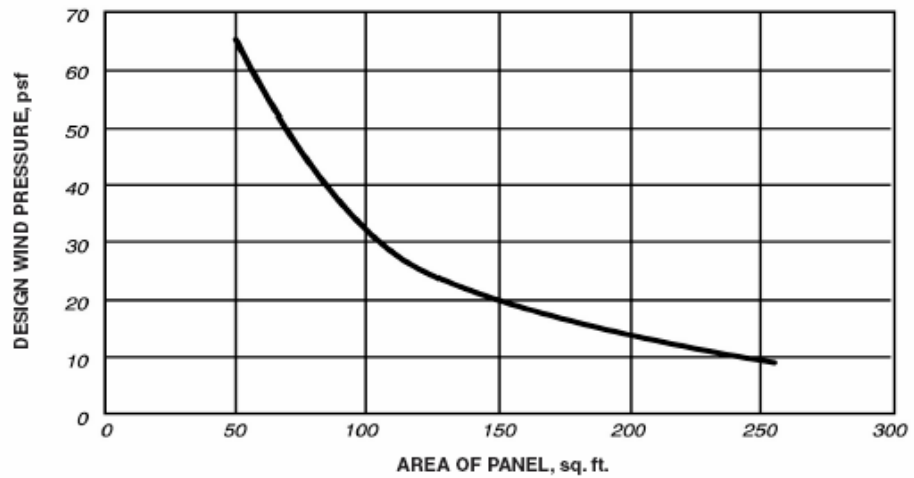
$D = F \times \sqrt{A}$

where:

D = Distance, in feet, measured from the center of the chimney outlet to the nearest edge of the construction.

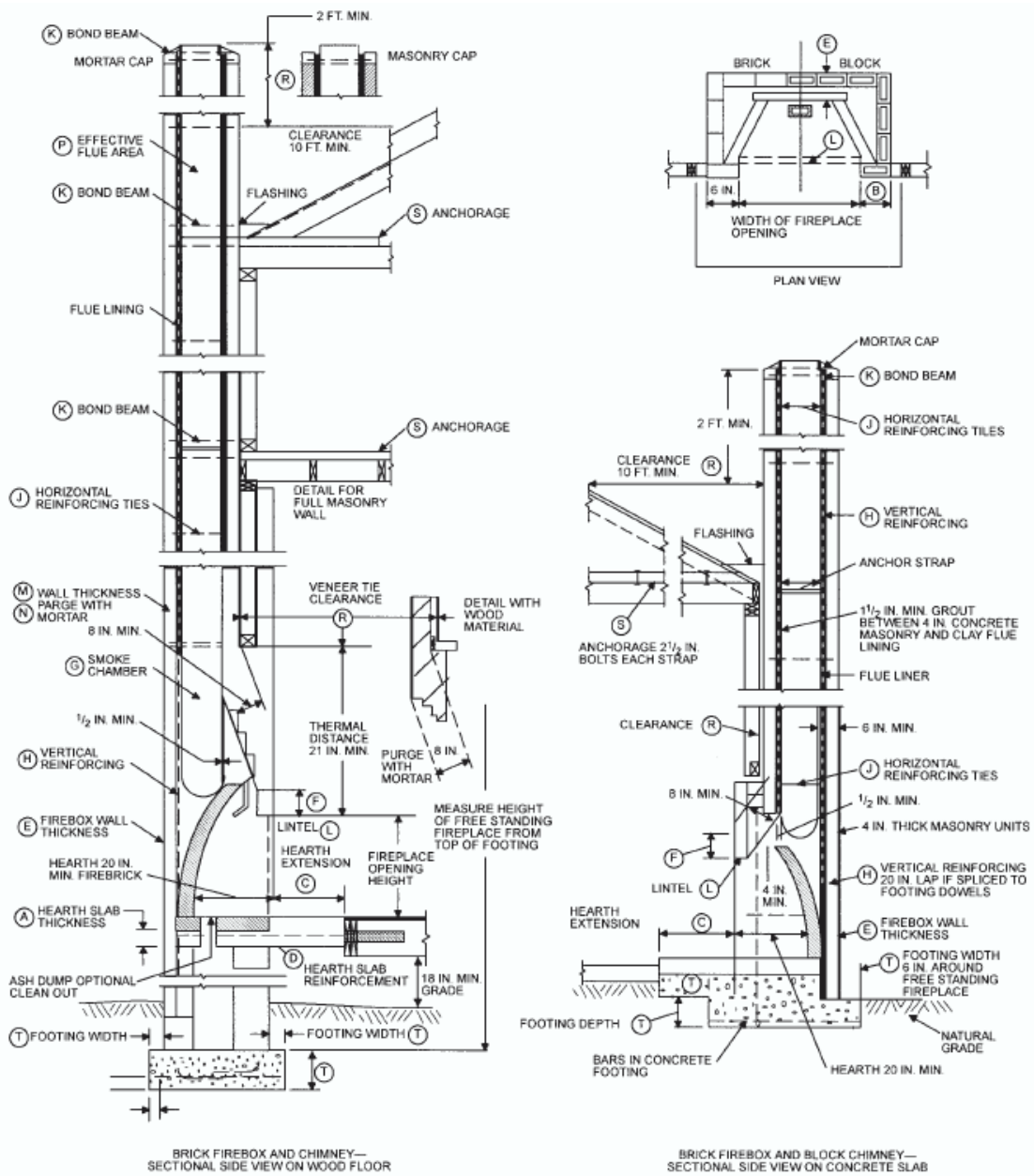
F = Value determined from Table 2113.9.

A = Free area, in square inches, of chimney flue space.



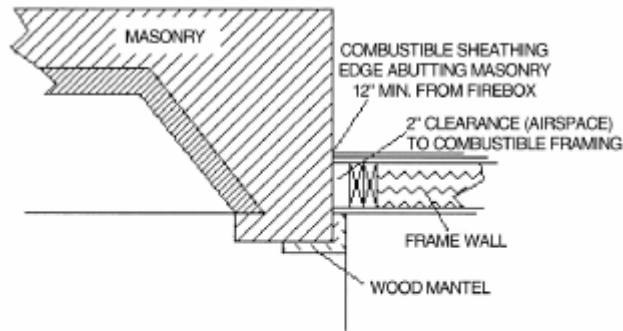
For SI: 1 square foot = 0.0929 m<sup>2</sup>, 1 pound per square foot = 47.9 N/m<sup>2</sup>.

**FIGURE 2110.3.1  
GLASS MASONRY DESIGN WIND LOAD RESISTANCE**



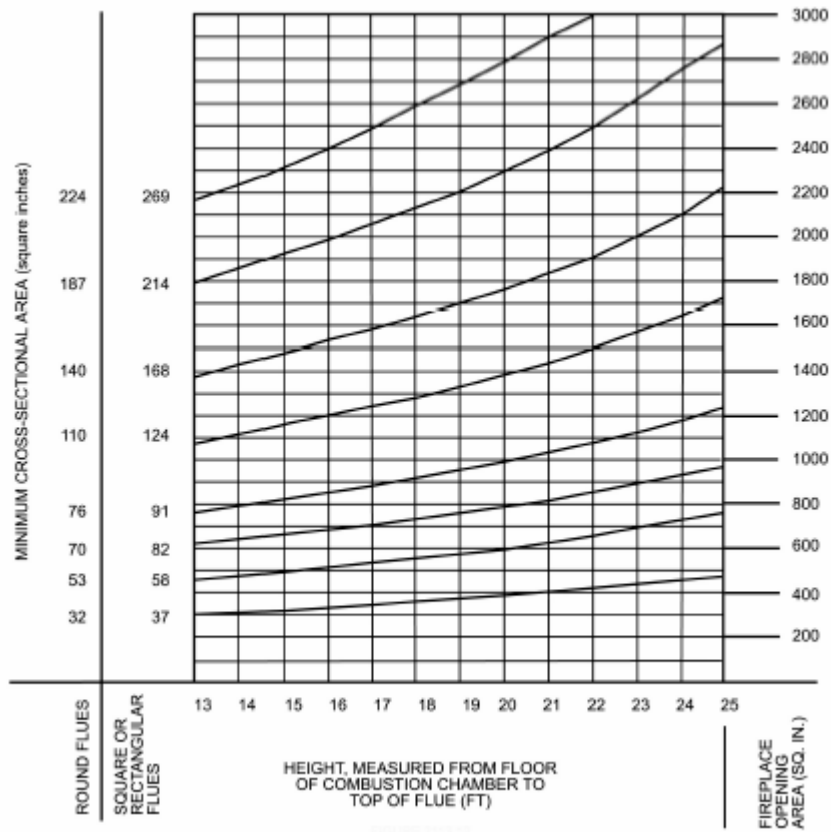
For SI: 1 inch = 25.4 mm, 1 foot = 304.8 mm.

**FIGURE 2111.1**  
**FIREPLACE AND CHIMNEY DETAILS**



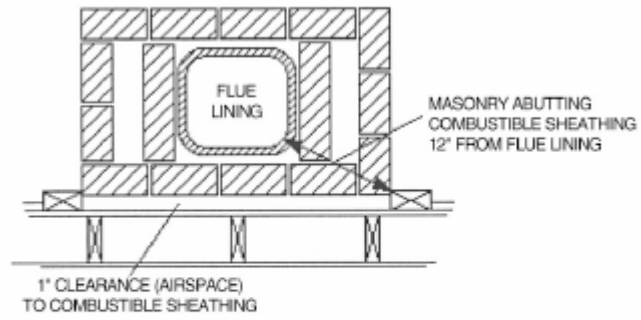
For SI: 1 inch = 25.4 mm

**FIGURE 2111.11  
ILLUSTRATION OF EXCEPTION TO  
FIREPLACE CLEARANCE PROVISION**



For SI: 1 inch = 25.4 mm, 1 square inch = 645 mm<sup>2</sup>.

**FIGURE 2113.16  
FLUE SIZES FOR MASONRY CHIMNEYS**



For SI: 1 inch = 25.4 mm

**FIGURE 2113.19  
ILLUSTRATION OF EXCEPTION TO  
CHIMNEY CLEARANCE PROVISION**

TABLE 2103.7(1)  
MORTAR PROPORTIONS

MORTAR	TYPE	PROPORTIONS BY VOLUME (cementitious materials)							HYDRATED LIME <sup>e</sup> OR LIME PUTTY	AGGREGATE MEASURED IN A DAMP, LOOSE CONDITION
		Portland cement <sup>a</sup> or blended cement <sup>b</sup>	Masonry cement <sup>c</sup>			Mortar cement <sup>d</sup>				
			M	S	N	M	S	N		
Cement-lime	M	1	—	—	—	—	—	—	$\frac{1}{4}$ over $\frac{1}{4}$ to $\frac{1}{2}$ over $\frac{1}{2}$ to $1\frac{1}{4}$ over $1\frac{1}{4}$ to $2\frac{1}{2}$	Not less than $2\frac{1}{4}$ and not more than 3 times the sum of the separate volumes of cementitious materials
	S	1	—	—	—	—	—	—		
	N	1	—	—	—	—	—	—		
	O	1	—	—	—	—	—	—		
Mortar cement	M	1	—	—	—	—	—	1	—	
	M	—	—	—	—	1	—	—	—	
	S	$\frac{1}{2}$	—	—	—	—	—	1	—	
	S	—	—	—	—	—	1	—	—	
	N	—	—	—	—	—	—	1	—	
	O	—	—	—	—	—	—	1	—	
Masonry cement	M	1	—	—	1	—	—	—	—	
	M	—	1	—	—	—	—	—	—	
	S	$\frac{1}{2}$	—	—	1	—	—	—	—	
	S	—	—	1	—	—	—	—	—	
	N	—	—	—	1	—	—	—	—	
	O	—	—	—	1	—	—	—	—	

- a. Portland cement conforming to the requirements of ASTM C 150.  
b. Blended cement conforming to the requirements of ASTM C 595.  
c. Masonry cement conforming to the requirements of ASTM C 91.  
d. Mortar cement conforming to the requirements of ASTM C 1329.  
e. Hydrated lime conforming to the requirements of ASTM C 207.

TABLE 2103.7(2)  
MORTAR PROPERTIES<sup>a</sup>

MORTAR	TYPE	AVERAGE COMPRESSIVE <sup>b</sup> STRENGTH AT 28 DAYS minimum (psi)	WATER RETENTION minimum (%)	AIR CONTENT maximum (%)
Cement-lime	M	2,500	75	12
	S	1,800	75	12
	N	750	75	14 <sup>c</sup>
	O	350	75	14 <sup>c</sup>
Mortar cement	M	2,500	75	12
	S	1,800	75	12
	N	750	75	14 <sup>c</sup>
	O	350	75	14 <sup>c</sup>
Masonry cement	M	2,500	75	18
	S	1,800	75	18
	N	750	75	20 <sup>d</sup>
	O	350	75	20 <sup>d</sup>

- For SI: 1 inch = 25.4 mm, 1 pound per square inch = 6.895 kPa.  
a. This aggregate ratio (measured in damp, loose condition) shall not be less than  $2\frac{1}{4}$  and not more than 3 times the sum of the separate volumes of cementitious materials.  
b. Average of three 2-inch cubes of laboratory-prepared mortar, in accordance with ASTM C 270.  
c. When structural reinforcement is incorporated in cement-lime or mortar cement mortars, the maximum air content shall not exceed 12 percent.  
d. When structural reinforcement is incorporated in masonry cement mortar, the maximum air content shall not exceed 18 percent.

**TABLE 2103.9  
CERAMIC TILE MORTAR COMPOSITIONS**

LOCATION	MORTAR	COMPOSITION
Walls	Scratchcoat	1 cement; 1/5 hydrated lime; 4 dry or 5 damp sand
	Setting bed and leveling coat	1 cement; 1/2 hydrated lime; 5 damp sand to 1 cement 1 hydrated lime, 7 damp sand
Floors	Setting bed	1 cement; 1/2 hydrated lime; 5 dry or 6 damp sand; or 1 cement; 5 dry or 6 damp sand
Ceilings	Scratchcoat and sand bed	1 cement; 1/2 hydrated lime; 2 1/2 dry sand or 3 damp sand

**TABLE 2103.10  
GROUT PROPORTIONS BY VOLUME FOR  
MASONRY CONSTRUCTION**

TYPE	PARTS BY VOLUME OF PORTLAND CEMENT OR BLENDED CEMENT	PARTS BY VOLUME OF HYDRATED LIME OR LIME PUTTY	AGGREGATE, MEASURED IN A DAMP, LOOSE CONDITION	
			Fine	Coarse
Fine grout	1	0-1/10	2 1/2-3 times the sum of the volumes of the cementitious materials	—
Coarse grout	1	0-1/10	2 1/2-3 times the sum of the volumes of the cementitious materials	1-2 times the sum of the volumes of the cementitious materials

**TABLE 2105.2.2.1.1  
COMPRESSIVE STRENGTH OF CLAY MASONRY**

NET AREA COMPRESSIVE STRENGTH OF CLAY MASONRY UNITS (psi)		NET AREA COMPRESSIVE STRENGTH OF MASONRY (psi)
Type M or S mortar	Type N mortar	
1,700	2,100	1,000
3,350	4,150	1,500
4,950	6,200	2,000
6,600	8,250	2,500
8,250	10,300	3,000
9,900	—	3,500
13,200	—	4,000

For SI: 1 pound per square inch = 0.00689 Mpa.

**TABLE 2105.2.2.1.2  
COMPRESSIVE STRENGTH OF CONCRETE MASONRY**

NET AREA COMPRESSIVE STRENGTH OF CONCRETE MASONRY UNITS (psi)		NET AREA COMPRESSIVE STRENGTH OF MASONRY (psi) <sup>a</sup>
Type M or S mortar	Type N mortar	
1,250	1,300	1,000
1,900	2,150	1,500
2,800	3,050	2,000
3,750	4,050	2,500
4,800	5,250	3,000

For SI: 1 inch = 25.4 mm, 1 pound per square inch = 0.00689 MPa.  
a. For units less than 4 inches in height, 85 percent of the values listed.

**TABLE 2109.2.1.3  
DIAPHRAGM LENGTH-TO-WIDTH RATIOS**

FLOOR OR ROOF DIAPHRAGM CONSTRUCTION	MAXIMUM LENGTH-TO-WIDTH RATIO OF DIAPHRAGM PANEL
Cast-in-place concrete	5:1
Precast concrete	4:1
Metal deck with concrete fill	3:1
Metal deck with no fill	2:1
Wood	2:1

**TABLE 2109.2.3.1  
ALLOWABLE STRESS GROSS CROSS-SECTIONAL  
AREA FOR DRY-STACKED, SURFACE-BONDED  
CONCRETE MASONRY WALLS**

DESCRIPTION	MAXIMUM ALLOWABLE STRESS (psi)
Compression standard block	45
Shear	10
Flexural tension	
Vertical span	18
Horizontal span	30

For SI:1 pound per square inch = 0.006895 Mpa.



**TABLE 2109.3.2  
ALLOWABLE COMPRESSIVE STRESSES FOR EMPIRICAL DESIGN OF MASONRY**

CONSTRUCTION; COMPRESSIVE STRENGTH OF UNIT GROSS AREA (psi)	ALLOWABLE COMPRESSIVE STRESSES <sup>a</sup> GROSS CROSS-SECTIONAL AREA (psi)	
	Type M or S mortar	Type N mortar
Solid masonry of brick and other solid units of clay or shale; sand-lime or concrete brick:		
8,000 or greater	350	300
4,500	225	200
2,500	160	140
1,500	115	100
Grouted masonry, of clay or shale; sand-lime or concrete:		
4,500 or greater	225	200
2,500	160	140
1,500	115	100
Solid masonry of solid concrete masonry units:		
3,000 or greater	225	200
2,000	160	140
1,200	115	100
Masonry of hollow load-bearing units:		
2,000 or greater	140	120
1,500	115	100
1,000	75	70
700	60	55
Hollow walls (noncomposite masonry bonded) <sup>b</sup>		
Solid units:		
2,500 or greater	160	140
1,500	115	100
Hollow units	75	70
Stone ashlar masonry:		
Granite	720	640
Limestone or marble	450	400
Sandstone or cast stone	360	320
Rubble stone masonry		
Coursed, rough or random	120	100

For SI: 1 pound per square inch = 0.006895 MPa.

- a. Linear interpolation for determining allowable stresses for masonry units having compressive strengths which are intermediate between those given in the table is permitted.
- b. Where floor and roof loads are carried upon one wythe, the gross cross-sectional area is that of the wythe under load; if both wythes are loaded, the gross cross-sectional area is that of the wall minus the area of the cavity between the wythes. Walls bonded with metal ties shall be considered as noncomposite walls unless collar joints are filled with mortar or grout.

**TABLE 2109.4.1  
WALL LATERAL SUPPORT REQUIREMENTS**

CONSTRUCTION	MAXIMUM WALL LENGTH TO THICKNESS OR WALL HEIGHT TO THICKNESS
Bearing walls	
Solid units or fully grouted	20
All others	18
Nonbearing walls	
Exterior	18
Interior	36

**TABLE 2109.5.7**  
**MINIMUM THICKNESS OF MASONRY PARTITIONS**

<b>Height of Walls</b>	<b>Thickness</b>
8 ft. and under.....	2 in.
Over 8 ft. to 12 ft.....	3 in.
Over 12 ft. to 16 ft.....	4 in.
Over 16 ft. to 20 ft.....	6 in.
Over 20 ft. to 24 ft.....	8 in.

**TABLE 2109.5.6.1**  
**FOUNDATION WALL CONSTRUCTION**

WALL CONSTRUCTION	NOMINAL WALL THICKNESS (inches)	MAXIMUM DEPTH OF UNBALANCED BACKFILL (feet)
Hollow unit masonry	8	5
	10	6
	12	7
Solid unit masonry	8	5
	10	7
	12	7
Fully grouted masonry	8	7
	10	8
	12	8

For SI: 1 inch = 25.4 mm, 1 foot = 304.8 mm.

TABLE 2109.8.3.1  
ALLOWABLE SHEAR ON BOLTS IN ADOBE MASONRY

DIAMETER OF BOLTS (inches)	MINIMUM EMBEDMENT (inches)	SHEAR (pounds)
$\frac{1}{2}$	—	—
$\frac{5}{8}$	12	200
$\frac{3}{4}$	15	300
$\frac{7}{8}$	18	400
1	21	500
$1\frac{1}{8}$	24	600

For SI: 1 inch = 25.4 mm, 1 pound = 4.448 N.

**TABLE 2111.1  
SUMMARY OF REQUIREMENTS FOR MASONRY FIREPLACES AND CHIMNEYS<sup>a</sup>**

ITEM	LETTER	REQUIREMENTS	SECTION
Hearth and hearth extension thickness	A	4-inch minimum thickness for hearth, 4-inch minimum thickness for hearth extension.	2111.9
Hearth extension (each side of opening)	B	8 inches for fireplace opening less than 6 square feet. 12 inches for fireplace opening greater than or equal to 6 square feet.	2111.10
Hearth extension (front of opening)	C	16 inches for fireplace opening less than 6 square feet. 20 inches for fireplace opening greater than or equal to 6 square feet.	2111.10
Firebox dimensions	—	20-inch minimum firebox depth. 12-inch minimum firebox depth for Rumford fireplaces.	2111.6
Hearth and hearth extension reinforcing	D	Reinforced to carry its own weight and all imposed loads.	2111.9
Thickness of wall of firebox	E	10 inches solid masonry or 8 inches where firebrick lining is used.	2111.5
Distance from top of opening to throat	F	8 inches minimum.	2111.7 2111.7.1
Smoke chamber wall thickness dimensions	G	6 inches lined; 8 inches unlined. Not taller than opening width; walls not inclined more than 45 degrees from vertical for prefabricated smoke chamber linings or 30 degrees from vertical for corbeled masonry.	2111.8
Chimney vertical reinforcing	H	Four No. 4 full-length bars for chimney up to 40 inches wide. Add two No. 4 bars for each additional 40 inches or fraction of width, or for each additional flue.	2111.3.1, 2113.3.1
Chimney horizontal reinforcing	J	$\frac{1}{4}$ -inch ties at each 18 inches, and two ties at each bend in vertical steel.	2111.3.2, 2113.3.2
Fireplace lintel	L	Noncombustible material with 4-inch bearing length of each side of opening.	2111.7
Chimney walls with flue lining	M	4-inch-thick solid masonry with $\frac{5}{8}$ -inch fireclay liner or equivalent. $\frac{1}{2}$ -inch grout or airspace between fireclay liner and wall.	2113.11.1
Effective flue area (based on area of fireplace opening and chimney)	P	See Section 2113.16.	2113.16
Clearances	R		
From chimney		2 inches interior, 1 inch exterior or 12 inches from lining.	2113.19
From fireplace		2 inches back or sides or 12 inches from lining.	2111.11
From combustible trim or materials		6 inches from opening	2111.12
Above roof		3 feet above roof penetration, 2 feet above part of structure within 10 feet.	2113.9
Anchorage strap	S	$\frac{3}{16}$ inch by 1 inch	
Number required		Two	2111.4
Embedment into chimney		12 inches hooked around outer bar with 6-inch extension.	
Fasten to		4 joists	2113.4.1
Number of bolts		Two $\frac{1}{2}$ -inch diameter.	
Footing	T		
Thickness		12-inch minimum.	2111.2
Width		6 inches each side of fireplace wall.	

For SI: 1 inch = 25.4 mm, 1 foot = 304.8 mm, 1 square foot = 0.0929 m<sup>2</sup>, 1 degree = 0.017 rad.

a. This table provides a summary of major requirements for the construction of masonry chimneys and fireplaces. Letter references are to Figure 2111.1, which shows examples of typical construction. This table does not cover all requirements, nor does it cover all aspects of the indicated requirements. For the actual mandatory requirements of the code, see the indicated section of text.

**TABLE 2113.9**  
**“F” FACTOR FOR DETERMINING CHIMNEY DISTANCES**

<b><u>“F” FACTOR FOR DETERMINING CHIMNEY DISTANCES</u></b>			
<b><u>Type of Fuel</u></b>	<b><u>“F” Factor</u></b>		
	<u>600°F (316°C ) and less</u>	<u>600°F (316°C ) to 1000°F (538°C)</u>	<u>Greater than 1000°F (538°C)</u>
<u>Gas</u>	<u>2</u>	<u>2</u>	<u>3</u>
<u>No. 2 Fuel Oil</u>	<u>2.5</u>	<u>2.5</u>	<u>3</u>
<u>No. 4, No. 6 Fuel Oils, Solid Fuels and Incinerators</u>	<u>3</u>	<u>3</u>	<u>3</u>

**TABLE 2113.16(1)  
NET CROSS-SECTIONAL AREA OF ROUND FLUE SIZES<sup>a</sup>**

FLUE SIZE, INSIDE DIAMETER (inches)	CROSS-SECTIONAL AREA (square inches)
6	28
7	38
8	50
10	78
10 <sup>3</sup> / <sub>4</sub>	90
12	113
15	176
18	254

For SI: 1 inch = 25.4 mm, 1 square inch = 645.16 mm<sup>2</sup>.

a. Flue sizes are based on ASTM C 315.

**TABLE 2113.16(2)  
NET CROSS-SECTIONAL AREA OF SQUARE AND  
RECTANGULAR FLUE SIZES<sup>a</sup>**

FLUE SIZE, INSIDE DIMENSION (inches)	CROSS-SECTIONAL AREA (square inches)
4 <sup>1</sup> / <sub>2</sub> × 13	34
7 <sup>1</sup> / <sub>2</sub> × 7 <sup>1</sup> / <sub>2</sub>	37
8 <sup>1</sup> / <sub>2</sub> × 8 <sup>1</sup> / <sub>2</sub>	47
7 <sup>1</sup> / <sub>2</sub> × 11 <sup>1</sup> / <sub>2</sub>	58
8 <sup>1</sup> / <sub>2</sub> × 13	74
7 <sup>1</sup> / <sub>2</sub> × 15 <sup>1</sup> / <sub>2</sub>	82
11 <sup>1</sup> / <sub>2</sub> × 11 <sup>1</sup> / <sub>2</sub>	91
8 <sup>1</sup> / <sub>2</sub> × 17 <sup>1</sup> / <sub>2</sub>	101
13 × 13	122
11 <sup>1</sup> / <sub>2</sub> × 15 <sup>1</sup> / <sub>2</sub>	124
13 × 17 <sup>1</sup> / <sub>2</sub>	165
15 <sup>1</sup> / <sub>2</sub> × 15 <sup>1</sup> / <sub>2</sub>	168
15 <sup>1</sup> / <sub>2</sub> × 19 <sup>1</sup> / <sub>2</sub>	214
17 <sup>1</sup> / <sub>2</sub> × 17 <sup>1</sup> / <sub>2</sub>	226
19 <sup>1</sup> / <sub>2</sub> × 19 <sup>1</sup> / <sub>2</sub>	269
20 × 20	286

For SI: 1 inch = 25.4 mm, 1 square inch = 645.16 mm<sup>2</sup>.

a. Flue sizes are based on ASTM C 315.

**CHAPTER 22**  
**STEEL**

**SECTION BC 2201**  
**GENERAL**

**2201.1 Scope.** The provisions of this chapter govern the quality, design, fabrication and erection of steel used structurally in buildings or structures.

**SECTION BC 2202**  
**DEFINITIONS AND NOMENCLATURE**

**2202.1 Definitions.** The following words and terms shall, for the purposes of this chapter and as used elsewhere in this code, have the meaning shown herein.

**ADJUSTED SHEAR RESISTANCE.** In Type II shear walls, the unadjusted shear resistance multiplied by the shear resistance adjustment factors of Table 2211.3.

**STEEL CONSTRUCTION, COLD-FORMED.** That type of construction made up entirely or in part of steel structural members cold formed to shape from sheet or strip steel such as roof deck, floor and wall panels, studs, floor joists, roof joists and other structural elements.

**STEEL JOIST.** Any steel structural member of a building or structure made of hot-rolled or cold-formed solid or open-web sections, or riveted or welded bars, strip or sheet steel members, or slotted and expanded, or otherwise deformed rolled sections.

**STEEL MEMBER, STRUCTURAL.** Any steel structural member of a building or structure consisting of a rolled steel structural shape other than cold-formed steel, or steel joist members.

**TYPE I SHEAR WALL.** A wall designed to resist in-plane lateral forces that is fully sheathed and provided with hold-down anchors at each end of the wall segment. Type I walls are permitted to have openings where detailing for force transfer around the openings is provided (see Figure 2202.1).

**TYPE II SHEAR WALL.** A wall designed to resist in-plane lateral forces that is sheathed with wood structural panel or sheet steel that contains openings, that have not been specifically designed and detailed for force transfer around wall openings. Hold-down anchors for Type II shear walls are only required at the ends of the wall (see Figure 2202.1).

**TYPE II SHEAR WALL SEGMENT.** A section of shear wall with full-height sheathing and which meets the aspect ratio limits of Section 2211.3.2(3).

**UNADJUSTED SHEAR RESISTANCE.** In Type II walls, the unadjusted shear

resistance is based on the design shear and the limitations of Section 2211.3.1.

**FIGURE 2202.1**  
**TYPE I AND TYPE II SHEAR WALLS**  
**(Figure 2202.1 attached to end of document)**

**2202.2 Nomenclature.** The following symbols shall, for the purposes of this chapter and as used elsewhere in this code, have the meanings shown herein.

$\phi$  = Resistance factor (see Section 2211.2.1).

$\Omega$  = Factor of safety (see Section 2211.2.1).

$\Omega_o$  = System over-strength factor (see Section 1617.6).

$C_o$  = Shear resistance adjustment factor from Table 2211.3.

$\Sigma L_i$  = Sum of widths of Type II shear wall segments, feet (mm/1,000).

$C$  = Compression chord uplift force, lbs (kN).

$V$  = Shear force in Type II shear wall, lbs (kN).

$H$  = The height of a shear wall measured as:

1. The maximum clear height from top of foundation to bottom of diaphragm framing above; or
2. The maximum clear height from top of a diaphragm to bottom of diaphragm framing above.

$v$  = Unit shear force, plf (kN/m).

$w$  = The width of a shear wall or wall pier in the direction of application of force measured as the sheathed dimension of the shear wall.

**SECTION BC 2203**  
**IDENTIFICATION AND PROTECTION OF STEEL FOR STRUCTURAL**  
**PURPOSES**

**2203.1 Identification.** Steel furnished for structural load-carrying purposes shall be properly identified for conformity to the ordered grade in accordance with the specified ASTM standard or other specification and the provisions of this chapter. Steel that is not readily identifiable as to grade from marking and test records shall be tested to determine conformity to such standards.



**2203.2 Protection.** Painting of structural steel shall comply with the requirements contained in either the AISC Load and Resistance Factor Design Specification for Structural Steel Buildings (AISC-LRFD), AISC Specification for Structural Steel Buildings—Allowable Stress Design (AISC 335) or AISC Specification for the Design of Steel Hollow Structural Sections (AISC-HSS). Individual structural members and assembled panels of cold-formed steel construction, except where fabricated of approved corrosion-resistant steel or of steel having a corrosion resistant or other approved coating, shall be protected against corrosion with an approved coat of paint, enamel or other approved protection.

**2203.2.1 Protection of structural steel.** All structural steel shall receive one coat of paint, zinc, or bituminous coating, or equivalent metal protection before erection. The protection shall be applied thoroughly and evenly to dry surfaces which have been cleaned of loose mill scale, loose rust, weld slag flux deposit, dirt, and other foreign matter. Oil and grease deposits shall be removed. Surfaces inaccessible after assembly shall be treated as required by this section prior to assembly. Structural steel that will remain exposed to the weather or to a corrosive atmosphere shall receive an additional coat of metal protection of another color after erection, except for types of structural steels that have been specifically intended for use under exposure to the weather without protection. All abrasions to, or deteriorations of, the protective coating shall be spot painted.

**Exceptions:** Surfaces of structural steel shall not be required to receive metal protection when the structural steel is used under the conditions listed below. However, these surfaces shall be cleaned of oil and grease by solvent cleaners and be cleaned of dirt and other foreign material by thorough brushing with a fiber brush.

1. Structural steel that is encased in concrete (other than cinder concrete) or surfaces that abut concrete (other than cinder concrete) at interior locations.
2. Structural steel encased in non-corrosive fire resistive materials that are bonded or secured to the steel surfaces by approved means.
3. Surfaces of structural steel that are to be riveted, bolted or welded together; provided, however, that parts of structural members left unpainted because of welding, bolting or riveting operations are not exempted from painting and shall receive a field application of approved metal protection.
4. Surfaces of structural steel within 2 inches (51 mm) of field welds shall be free of protective coatings that would prevent proper welding or produce objectionable fumes while welding is being done.
5. Surfaces of structural steel that have been machine finished.

6. Surfaces of types of structural steel that have been specifically approved for use without metal protection.
7. Structural steel members that are completely concealed by interior finish such as lath and plaster, and masonry, need not be painted except that where such members are subject to condensation from piping, are in shower or steam rooms, are exposed to chemical fumes or are exposed to other conditions of potentially aggressive corrosion.

## **SECTION BC 2204** **CONNECTIONS**

**2204.1 Welding.** The details of design, workmanship and technique for welding, inspection of welding and qualification of welding operators shall conform to the requirements of the specifications listed in Sections 2205, 2206, 2207, 2209 and 2210. Special inspection of welding shall be provided where required by Section 1704.

**2204.1.1 Tack welds.** Tack welds, which are later incorporated into finished welds carrying calculated stress, shall not be considered as structural welds.

**2204.2 Bolting.** The design, installation and inspection of bolts shall be in accordance with the requirements of the specifications listed in Sections 2205, 2206, 2209 and 2210. Special inspection of the installation of high-strength bolts shall be provided where required by Section 1704.

**2204.2.1 Anchor rods.** Anchor rods shall be set accurately to the pattern and dimensions called for on the plans. The protrusion of the threaded ends through the connected material shall be sufficient to fully engage the threads of the nuts, but shall not be greater than the length of the threads on the bolts.

## **SECTION BC 2205** **STRUCTURAL STEEL**

**2205.1 General.** The design, fabrication and erection of structural steel for buildings and structures shall be in accordance with either the AISC-LRFD, AISC 335 or AISC-HSS. Where required, the seismic design of steel structures shall be in accordance with the additional provisions of Section 2205.2.

**2205.1.1 Structural steel.** Material for use as structural steel not listed in AISC-LRFD and AISC 335 may be used in accordance with AISC-LRFD and AISC 335 when approved by the commissioner for such use.

**2205.2 Seismic requirements for steel structures.** The design of structural steel structures to resist seismic forces shall be in accordance with the provisions of Section 2205.2.1 or 2205.2.2 for the appropriate seismic design category.

**2205.2.1 Seismic Design Category B or C.** Structural steel structures assigned to Seismic Design Category B or C, in accordance with Section 1616, shall be of any construction permitted in Section 2205. An *R* factor as set forth in Section 1617.6 for the appropriate steel system is permitted where the structure is designed and detailed in accordance with the provisions of AISC 341, Parts I and III. Systems not detailed in accordance with the above shall use the *R* factor in Section 1617.6 designated for “steel systems not detailed for seismic.”

Pre-qualified moment connections detailed in FEMA 350 (FEMA 2000a) may be considered as pre-qualified with regard to AISC 341 requirements for Special Moment Frames (SMF’s), Intermediate Moment Frames (IMF’s), and link-to-column connections of Eccentrically Brace Frames (EBF’s).

**2205.2.2 Seismic Design Category D.** Structural steel structures assigned to Seismic Design Category D shall be designed and detailed in accordance with AISC 341, Part I or Part III.

**2205.3 Seismic requirements for composite construction.** The design, construction and quality of composite steel and concrete components that resist seismic forces shall conform to the requirements of the AISC-LRFD and ACI 318. An *R* factor as set forth in Section 1617.6 for the appropriate composite steel and concrete system is permitted where the structure is designed and detailed in accordance with the provisions of AISC 341, Part II. In Seismic Design Category B or above, the design of such systems shall conform to the requirements of AISC 341, Part II.

**2205.3.1 Seismic Design Category D.** Composite structures are permitted in Seismic Design Categories D, subject to the limitations in Section 1617.6, where substantiating evidence is provided to demonstrate that the proposed system will perform as intended by AISC 341, Part II. The substantiating evidence shall be subject to the commissioner’s approval. Where composite elements or connections are required to sustain inelastic deformations, the substantiating evidence shall be based on cyclic testing.

**2205.4 Composite members.** In addition to the provisions for composite members in Reference Standards AISC-LRFD and AISC 335, the following provisions shall be used:

**2205.4.1 Heavy vehicle loads.** Composite construction used for members subject to heavy vehicle loads (excluding passenger cars), shall be designed for moving loads and shall be proportioned in accordance with the requirements for Highway Bridges, AASHTO HB-16 REV 02, Standard Specification for Highway Bridges.

**2205.4.2 Concrete encased beams.** Where the design strength of concrete encased structural steel beams is determined from the plastic stress distribution of the structural steel beam alone in accordance with AISC-LRFD or from AISC 335 where the allowable bending stress of the structural steel beam alone is used, the yield stress

of the structural steel shall not exceed 36 ksi (250 Mpa), the steel beam depth shall not exceed 40 inches (1016 mm), the concrete compressive strength shall not be less than 3,000 psi (20 685 kPa) and the concrete aggregate shall conform with ASTM C33.

**2205.4.3 Special cases.** Where special cases for composite construction are considered in accordance with AISC-LRFD and AISC 335, test programs shall be satisfactory to the commissioner.

**2205.5 Ponding.** In addition to the provisions of AISC-LRFD and AISC 335, in flat roof systems (slope less than 1° (0.02 rad)) where secondary members are made up of members of materials other than steel, the depth of the structural steel members shall not be less than  $f_b/600$  times the span length whether designed as simple or continuous.  $f_b$  shall be taken as the computed bending stress of the structural steel member.

**2205.6 Fabrication, erection and quality control.** In addition to the provisions for fabrication, erection and quality control in AISC-LRFD and AISC 335, the following provisions shall be used.

**2205.6.1 Shop drawings.** Shop drawings shall include the location of oversized, short slotted and long slotted holes.

**2205.6.2 Field connections.** Field connections shall meet the requirements for corresponding types of shop connections described in AISC-LRFD and AISC 335. No holes, copes or cuts of any type shall be made to facilitate erection unless specifically shown on the shop drawings or authorized in writing by the engineer or architect of record.

**2205.6.3 Handling and storing materials.** All structural steel members shall be shipped and handled in a manner that will not cause injury to protective coatings or permanent deformations of the members. Structural steel members shall not be dropped, thrown, or dragged. Any bends, crimps or other evidence of permanent deformations shall be straightened by methods approved by the engineer or architect of record or the piece shall be rejected. Materials shall be stored out of contact with the ground, kept clean, and protected against damage and corrosion.

**2205.6.4 Structural steel erection.**

**2205.6.4.1 Placing of structural members.** During the placing of a structural member, the load shall not be released from the hoisting rope until the member is securely supported.

Open web steel joists that are hoisted singly shall be transferred from their place of storage directly to their permanent location and safely secured. No load shall be placed on open web steel joists until they are permanently fastened in place.

**2205.6.4.2 Tag lines.** While structural members or assemblies are being hoisted, tag lines shall be used to prevent uncontrolled movement.

**2205.6.4.3 Erection of trusses.** All trusses shall be laterally braced or guyed as necessary for the safety of the structure.

**2205.6.4.4 Erection of frames.** All structural frames shall be properly braced with shores or guyed cables and turnbuckles as necessary for the safety of the structure.

**2205.6.4.5 Permanent flooring and steel erection in tiered buildings.** The permanent floors of such buildings or other structures shall be installed as soon as possible as the erection of structural steel members progresses. In no case shall there be more than eight stories, floors or equivalent levels or 120 feet (36 576 mm), whichever is less, between the erection floor and the uppermost permanent floor.

## **SECTION BC 2206** **STEEL JOISTS**

**2206.1 General.** The design, manufacturing and use of open web steel joists and joist girders shall be in accordance with one of the following Steel Joist Institute specifications:

1. Standard Specifications for Open Web Steel joists, K Series.
2. Standard Specifications for Longspan Steel joists, LH Series and Deep Longspan Steel joists, DLH Series.
3. Standard Specifications for Joist Girders.

Where required, the seismic design of buildings shall be in accordance with the additional provisions of Section 2205.2 or 2211.

**2206.2 Painting.** Open web steel joists shall be painted. The shop coat shall be applied at the place of manufacture. All abrasions shall be touched up at the job site with the same material. Steel joists that remain exposed to the weather or a corrosive atmosphere shall receive an additional coat of metal protection of another color after erection, except for types of structural steels that have been specifically approved for use under exposure to the weather without metal protection.

**2206.3 Limitations of use.** Open web steel joists are prohibited in high rise buildings in all occupancy groups except R-2 and R-3.

## **SECTION BC 2207** **STEEL CABLE STRUCTURES**

**2207.1 General.** The design, fabrication and erection including related connections, and protective coatings of steel cables for buildings shall be in accordance with ASCE 19.

**2207.1.1 Protection of steel cables.** The minimum protection of all wires or strands used in building structures shall be a class “A” coating as defined in ASTM A 586 and A 603, whether the cable is used on the interior or exterior.

**2207.2 Seismic requirements for steel cable.** The design strength of steel cables shall be determined by the provisions of ASCE 19 except as modified by these provisions.

1. A load factor of 1.1 shall be applied to the prestress force included in  $T_3$  and  $T_4$  as defined in Section 3.12.
2. In Section 3.2.1, Item (c) shall be replaced with “1.5  $T_3$ ” and Item (d) shall be replaced with “1.5  $T_4$ ”

### **SECTION BC 2208** **STEEL STORAGE RACKS**

**2208.1 Storage racks.** The design, testing and utilization of industrial steel storage racks shall be in accordance with the *RMI Specification for the Design, Testing and Utilization of Industrial Steel Storage Racks*. Racks in the scope of this specification include industrial pallet racks, movable shelf racks and stacker racks, and does not apply to other types of racks, such as drive-in and drive-through racks, cantilever racks, portable racks or rack buildings. Where required, the seismic design of storage racks shall be in accordance with the provisions of Section 9.6.2.9 of ASCE 7.

### **SECTION BC 2209** **COLD-FORMED STEEL**

**2209.1 General.** The design of cold-formed carbon and low-alloy steel structural members shall be in accordance with the *North American Specification for the Design of Cold-formed steel Structural Members (AISI-NASPEC)*. The design of cold-formed stainless-steel structural members shall be in accordance with ASCE 8. Cold-formed steel light-framed construction shall comply with Section 2210.

#### **2209.1.1 Other steels.**

1. Cold-formed steel not listed in the *North American Specification for the Design of Cold-formed steel Structural Members (AISI-NASPEC)* may be used in accordance with AISI-NASPEC when approved by the commissioner for such use.
2. Cold-formed stainless steel not listed in ASCE 8 may be used in accordance with ASCE 8 when approved by the commissioner for such use.

**2209.1.2 Load tests.** The Load test requirements of Chapter 17 shall apply in lieu of the load test procedures of Chapter 6.2 of ASCE 8 and Chapter F of AISI-NASPEC.

**2209.1.3 Fabrication and erection.**

1. All materials shall be flat, clean and straight. If straightening or flattening is necessary, it shall be done by a suitable process or method and in a manner that will not injure the material.
2. Profiles used structurally shall conform to the specified dimension. Care shall be taken not to stretch, bend, or otherwise distort parts of the sections unless such forming is an integral part of the design.
3. Components may be cut by slitting, shearing, sawing, or flame cutting. All punched holes and sheared or flame cut edges of material in members subject to calculated stress shall be clean and free from notches and burred edges.
4. Care shall be taken to avoid damage when loading, unloading, and handling members.

**2209.2 Composite slabs on steel decks.** Composite slabs of concrete and steel deck shall be designed and constructed in accordance with ASCE 3.

**SECTION BC 2210**

**COLD-FORMED STEEL LIGHT-FRAMED CONSTRUCTION**

**2210.1 General.** The design, installation and construction of cold-formed carbon or low-alloy steel, structural and nonstructural steel framing, shall be in accordance with the *Standard for Cold-formed steel Framing—General Provisions, American Iron and Steel Institute (AISI-General) and AISI-NASPEC.*

**2210.2 Headers.** The design and installation of cold-formed steel box and back-to-back headers, and double L-headers used in single-span conditions for load-carrying purposes shall be in accordance with the *Standard for Cold-formed steel Framing—Header Design, American Iron and Steel Institute (AISI-Header),* subject to the limitations therein.

**2210.3 Trusses.** The design, quality assurance, installation and testing of cold-formed steel trusses shall be in accordance with the *Standard for Cold-formed steel Framing—Trusses, American Iron and Steel Institute (AISI-Truss),* subject to the limitations therein.

**SECTION BC 2211**

**COLD-FORMED STEEL LIGHT-FRAMED SHEAR WALLS**

**2211.1 General.** In addition to the requirements of Section 2210, the design of cold-formed steel light-framed shear walls, to resist wind and seismic loads shall be in accordance with the requirements of Section 2211.2 for Type I (segmented) shear walls

or Section 2211.3 for Type II (perforated) shear walls.

Light-framed structures assigned to Seismic Design Category B, in accordance with Section 1616, shall be of any construction permitted in Section 2210. An  $R$  factor as set forth in Section 1617.6 for the appropriate steel system is permitted where the lateral design of the structure is in accordance with the provisions of Section 2211.4. Systems not detailed in accordance with Section 2211.4 shall use the  $R$  factor in Section 1617.6 designated for “steel systems not detailed for seismic.”

In Seismic Design Category D, the lateral design of light-framed structures shall also comply with the requirements in Section 2211.4

**2211.2 Type I shear walls.** The design of Type I shear walls, of cold-formed steel light-framed construction, to resist wind and seismic loads, shall be in accordance the requirements of this section.

1. The nominal shear value for Type I shear walls, as shown in Table 2211.2(1) for wind loads, Table 2211.2(2) for wind or seismic loads or Table 2211.2(3) for seismic loads, is permitted to establish allowable shear values or design strength values.
2. Boundary members, chords, collectors and connections thereto shall be proportioned to transmit the induced forces.
3. As an alternative to the values in Tables 2211.2(1), 2211.2(2) and 2211.2(3), shear values are permitted to be calculated by the principles of mechanics by using approved fastener values and shear values appropriate for the sheathing material attached.
4. Type I shear walls sheathed with wood structural or sheet steel panels are permitted to have window openings, between hold-down anchors at each end of a wall segment, where details are provided to account for force transfer around openings.
5. The aspect ratio limitations of Section 2211.2.2, Item 5, shall apply to the entire Type I segment and to each wall pier at the side of each opening.
6. The height of the wall pier ( $h$ ) shall be defined as the clear height of the pier at the side of an opening.
7. The width of a pier ( $w$ ) shall be defined as the sheathed width of the pier.
8. The width of wall piers shall not be less than 24 inches (610 mm).
9. Hold-down anchors shall be provided at each end of a Type I shear wall capable of resisting the design forces.



**TABLE 2211.2(1)**  
**NOMINAL SHEAR VALUES FOR WIND FORCES IN POUNDS PER FOOT**  
**FOR SHEAR WALLS FRAMED WITH COLD-FORMED STEEL STUDS<sup>a</sup>**  
**(Table 2211.2(1) attached to end of document)**

**TABLE 2211.2(2)**  
**NOMINAL SHEAR VALUES FOR WIND FORCES IN POUNDS PER FOOT**  
**FOR SHEAR WALLS FRAMED WITH COLD-FORMED STEEL STUDS AND**  
**FACED WITH GYPSUM BOARD<sup>a,b</sup>**  
**(Table 2211.2(2) attached to end of document)**

**TABLE 2211.2(3)**  
**NOMINAL SHEAR VALUES FOR SEISMIC FORCES IN POUNDS PER FOOT**  
**FOR SHEAR WALLS FRAMED WITH COLD-FORMED STEEL STUDS<sup>a</sup>**  
**(Table 2211.2(3) attached to end of document)**

**2211.2.1 Design shear determination.** Where allowable stress design (ASD) is used, the allowable shear value shall be determined by dividing the nominal shear value, shown in Tables 2211.2(1), 2211.2(2) and 2211.2(3), by a factor of safety ( $\Omega$ ) of 2.5.

Where load and resistance factor design (LRFD) is used, the design strength value shall be determined by multiplying the nominal shear value, shown in Tables 2211.2(1), 2211.2(2) and 2211.2(3), by a resistance factor ( $\Phi$ ) of 0.55.

**2211.2.2 Limitations for systems.** The lateral-resistant systems listed in Tables 2211.2(1), 2211.2(2) and 2211.2(3) shall conform to the following requirements:

1. Studs shall be a minimum 1<sup>5</sup>/<sub>8</sub> inches (41 mm) by 3<sup>1</sup>/<sub>2</sub> inches (89 mm) with a <sup>3</sup>/<sub>8</sub>-inch (9.5 mm) return lip. As a minimum, studs shall be doubled (back to back) at shear wall ends.
2. Track shall be a minimum 1<sup>1</sup>/<sub>4</sub> inches (32 mm) by 3<sup>1</sup>/<sub>2</sub> inches (89 mm).
3. Both studs and track shall have a minimum uncoated base metal thickness of 33 mils (0.84 mm) and shall be of the following grades of structural quality steel: ASTM A 653 SS Grade 33, ASTM A 792 SS Grade 33 or ASTM A 875 SS Grade 33.
4. Fasteners along the edges in shear panels shall be placed not less than <sup>3</sup>/<sub>8</sub> inch (9.5 mm) in from panel edges.
5. The height-to-width shear wall aspect ratio ( $h/w$ ) of wall systems shall not exceed the values in Tables 2211.2(1), 2211.2(2) and 2211.2(3). Where the limiting ratio of  $h/w$  is greater than 2:1, the shear values shall be multiplied by  $2w/h$ .

6. Panel thicknesses shown are minimums. Panels less than 12 inches (305 mm) wide shall not be used. All panel edges shall be fully blocked.
7. Where horizontal strap blocking is used to provide edge blocking, it shall be a minimum 1½ inches (38 mm) wide and of the same material and equal or greater thickness as the track and studs.
8. The design shear values for shear panels with different nominal shear values applied to the same side of a wall are not cumulative except as permitted in Tables 2211.2(1), 2211.2(2) and 2211.2(3). For walls with material applied to both faces of the same wall, the design shear value of material of the same capacity is cumulative. Where the material nominal shear values are not equal, the design shear value shall be either two times the design shear value of the material with the smaller values or shall be taken as the value of the stronger side, whichever is greater. Summing shear values of dissimilar material applied to opposite faces or to the same wall line is not allowed unless permitted by Table 2211.2(1).

**2211.2.2.1 Sheet steel sheathing.** Steel sheets, attached to cold-formed steel framing, are permitted to resist horizontal forces produced by wind or seismic loads.

1. Steel sheets shall have a minimum base metal thickness as shown in Table 2211.2(1) or 2211.2(3), and shall be of the following grades of structural quality steel: ASTM A 653 SS Grade 33, ASTM A792 SS Grade 33 or ASTM A 875 SS Grade 33.
2. Nominal shear values, used to establish the allowable shear value or design strength value, are given in Tables 2211.2(1) for wind loads and 2211.2(3) for seismic loads.
3. Steel sheets are permitted to be applied either parallel or perpendicular to framing. All edges of steel sheets shall be attached to framing members, strap blocking or shall be overlapped and attached to each other with screw spacing as required for edges.
4. Screws used to attach steel sheets shall be a minimum No. 8 modified truss head.

**2211.2.2.2 Wood structural panel sheathing.** Cold-formed steel framed wall systems, sheathed with wood structural panels, are permitted to resist horizontal forces produced by wind or seismic loads subject to the following:

1. Nominal shear values, used to establish the allowable shear value or design strength value, are given in Tables 2211.2(1), for wind loads, and 2211.2(3), for seismic loads.

2. Wood structural panels shall comply with DOC PS 1 or PS 2 and shall be manufactured using exterior glue.
3. Wood structural panels shall be attached to steel framing with flat-head self-drilling tapping screws with a minimum head diameter of 0.292 inch (7.4 mm).
4. Where  $\frac{7}{16}$ -inch (11.1 mm) oriented strand board (OSB) is specified,  $\frac{15}{32}$ -inch (12 mm) structural 1 sheathing (plywood) is permitted.
5. Structural panels are permitted to be applied either parallel or perpendicular to framing.
6. Increases of the nominal loads shown in Tables 2211.2(1) and 2211.2(3) shall not be permitted for duration of load as permitted in Chapter 23.

**2211.2.2.3 Gypsum board panel sheathing.** Cold-formed steel framed wall systems, sheathed with gypsum board, are permitted to resist horizontal forces produced by wind or seismic loads subject to the following:

1. Nominal shear values, used to establish the allowable shear value or design strength value, are given in Table 2211.2(2).
2. The shear values listed in Table 2211.2(2) shall not be cumulative with the shear values of other materials applied to the same wall unless otherwise permitted herein.
3. The nominal shear values shown are for gypsum board that is applied to both sides of the wall.
4. Where gypsum board is only applied to one side of the wall, the nominal shear values shall be taken as one-half of the value shown.
5. Where gypsum board is applied perpendicular to studs, end joints of adjacent courses of gypsum board sheets shall not occur over the same stud.
6. Screws used to attach gypsum board shall be a minimum No. 6 in accordance with ASTM C 954.
7. Walls resisting seismic loads shall be subject to the limitations in Section 1617.6.

**2211.3 Type II shear walls.** Type II (Perforated) shear walls sheathed with wood structural panels or sheet steel are permitted to resist wind and seismic loads when designed in accordance with this section. Type II walls shall meet the requirements for Type I walls except as revised by this section.

**TABLE 2211.3**  
**SHEAR RESISTANCE ADJUSTMENT FACTOR— $C_o$**   
**(Table 2211.3 attached to end of document)**

**2211.3.1 Limitations.** The following limitations shall apply to the use of Type II shear walls:

1. A Type II shear wall segment, meeting the minimum aspect ratio ( $h/w$ ) of Section 2211.3.2, Item 3, shall be located at each end of a Type II shear wall. Openings shall be permitted to occur beyond the ends of the Type II shear wall; however, the width of such openings shall not be included in the width of the Type II shear wall.
2. In Seismic Design Categories B, C, and D, the nominal shear values shall be based upon edge screw spacing not less than 4 inches (102 mm) o.c.
3. A Type II shear wall shall not have out-of-plane (horizontal) offsets. Where out-of-plane offsets occur, portions of the wall on each side of the offset shall be considered as separate Type II shear walls.
4. Collectors for shear transfer shall be provided through the full length of the Type II shear wall.
5. A Type II shear wall shall have uniform top of wall and bottom of wall elevations. Type II shear walls not having uniform elevations shall be designed by other methods.
6. Type II shear wall height,  $h$ , shall not exceed 20 feet (6096 mm).

**2211.3.2 Type II shear wall resistance.** The Type II shear wall resistance shall be equal to the adjusted shear resistance multiplied by the sum of the widths ( $\Sigma L_i$ ) of the Type II shear wall segments and shall be calculated in accordance with the following:

1. Percent full-height sheathing. The percent of full-height sheathing shall be calculated as the sum of widths ( $\Sigma L_i$ ) of Type II shear wall segments divided by the total width of the Type II shear wall including openings.
2. Maximum opening height ratio. The maximum opening height ratio shall be calculated by dividing the maximum opening clear height by the shear wall height,  $h$ .
3. Unadjusted shear resistance. The unadjusted shear resistance shall be the design shear values calculated in accordance with Section 2211.2.1 based upon the values in Tables 2211.2(1) and 2211.2(3). The aspect ratio of all Type II shear wall segments used in calculations shall not exceed 2:1.

**Exception:** Where permitted by Tables 2211.2(1) and 2211.2(3), the aspect ratio ( $h/w$ ) of Type II wall segments greater than 2:1, but in no case greater than 4:1, is permitted to be included in the calculation of the unadjusted shear resistance for the wall, provided the values are multiplied by  $2w/h$ .

4. Adjusted shear resistance. The adjusted shear resistance shall be calculated by multiplying the unadjusted shear resistance by the shear resistance adjustment factors of Table 2211.3. For intermediate percentages of full-height sheathing, the values are permitted to be determined by interpolation.

**2211.3.3 Anchorage and load path.** Design of Type II shear wall anchorage and load path shall conform to the requirements of this section, or shall be calculated using principles of mechanics.

**2211.3.3.1 Anchorage for in-plane shear.** The unit shear force,  $v$ , transmitted into the top and out of the base of the Type II shear wall full-height sheathing segments, and into collectors (drag struts) connecting shear wall segments, shall be calculated in accordance with the following:

**(Equation 22-1 attached to end of document)**

**2211.3.3.2 Uplift anchorage at Type II shear wall ends.** Anchorage for uplift forces due to overturning shall be provided at each end of the Type II shear wall. Where seismic loads govern, the uplift anchorage shall be determined in accordance with the requirements of Section 2211.4.3.

**2211.3.3.3 Uplift anchorage between Type II shear wall ends.** In addition to the requirements of Section 2211.3.3.1, Type II shear wall bottom plates at full-height sheathing shall be anchored for a uniform uplift force,  $t$ , equal to the unit shear force,  $v$ , determined in Section 2211.3.3.1.

**2211.3.3.4 Compression chords.** Vertical elements at each end of each Type II shear wall segment shall be designed for a compression force,  $C$ , from each story calculated in accordance with the following:

**(Equation 22-2 attached to end of document)**

**2211.3.3.5 Load path.** A load path to the foundation shall be provided for the uplift shear and compression forces as determined from Sections 2211.3.3.1 through 2211.3.3.4, inclusive. Elements resisting shear wall forces contributed by multiple stories shall be designed for the sum of forces contributed by each story.

## **2211.4 Seismic Design Category D.**

**2211.4.1 General.** In addition to the requirements of Sections 2211.2 and 2211.3, light-framed cold-formed steel wall systems, that resist seismic loads, in buildings assigned to Seismic Design Category D, shall comply with the requirements of this section.

**2211.4.2 Connections.** Connections for diagonal bracing members, top chord splices, boundary members and collectors shall be designed to develop the lesser of the nominal tensile strength of the member or the design seismic force multiplied by the seismic overstrength factor,  $\Omega_o$ , from Section 1617.6. The pull-out resistance of screws shall not be used to resist design seismic forces.

**2211.4.3 Anchorage of braced wall segments.** Studs or other vertical boundary members at the ends of wall segments, that resist seismic loads, braced with either sheathing or diagonal braces, shall be anchored such that the bottom track is not required to resist uplift by bending of the track web. Both flanges of the studs shall be braced to prevent lateral torsional buckling. Studs or other vertical boundary members and anchorage thereto shall have the nominal strength to resist design seismic force multiplied by the seismic overstrength factor,  $\Omega_o$ , from Section 1617.6.

**2211.4.4 Sheet steel sheathing.** Where steel sheathing provides lateral resistance, the design and construction of such walls shall be in accordance with the additional requirements of this section. Perimeter members at openings shall be provided and shall be detailed to distribute the shearing stresses. Wall studs and track shall have a minimum uncoated base metal thickness of 33 mils (0.84 mm) and shall not have an uncoated base metal thickness greater than 48 mils (1.10 mm). The nominal shear value for light-framed wall systems for buildings in Seismic Design Category D shall be based upon values from Table 2211.2(3).

**2211.4.5 Wood structural panel sheathing.** Where wood structural panels provide lateral resistance, the design and construction of such walls shall be in accordance with the additional requirements of this section. Perimeter members at openings shall be provided and shall be detailed to distribute the shearing stresses. Wood sheathing shall not be used to splice these members. Wall studs and track shall have a minimum uncoated base metal thickness of 33 mils (0.84 mm) and shall not have an uncoated base metal thickness greater than 48 mils (1.10 mm). The nominal shear value for light-framed wall systems for buildings in Seismic Design Category D shall be based upon values from Table 2211.2(3).

**2211.4.6 Diagonal bracing.** Where diagonal bracing is provided for lateral resistance, provisions shall be made for pretensioning or other methods of installing. Tension-only bracing shall be used to guard against loose diagonal straps. The  $l/r$  of the brace is permitted to exceed 200.

**2211.4.7 Gypsum board panel sheathing.** Gypsum board panel sheathing is permitted to resist seismic loads, subject to the limitations in Table 2211.2(2) and Section 1617.6.

**SECTION BC 2212**  
**MINIMUM THICKNESS OF METAL**

**2212.1 Exterior members.** All exterior structural steel members exposed to weather shall have a minimum thickness of metal of 0.23 inches (5.8 mm).

**Exceptions:**

1. When an approved type of atmospheric corrosion resistant steel is used.
2. Exposed surfaces are zinc coated with a minimum weight of coating of approximately 0.6 ounces per square foot (0.00156 kg/m<sup>2</sup>) of exposed surface and covered with a protective coating as required by Section 2203.2.
3. Exposed surfaces are protected by other means approved by the commissioner.
4. Temporary construction that will be in place for a period of one year or less, provided that all surfaces which are exposed to the weather shall have a protective coating as required by Section 2203.2.
5. Joists or purlins that are exposed to the weather but which do not support more than 200 square feet (19 m<sup>2</sup>) of floor or roof area, and which have a protective coating as required by 2203.2.

**SECTION BC 2213**  
**STRUCTURAL INTEGRITY REQUIREMENTS**

**2213.1 General.** Structural steel members shall be designed to meet all of the requirements of this section. However, details provided for gravity, seismic and wind forces and for other purposes may be regarded as forming part of, or the whole of, these requirements. Detailing provided for one requirement may be counted towards the other requirements.

**Exceptions:**

1. One story structures less than 5,000 square feet (465 m<sup>2</sup>) not to exceed 15 feet (4572 mm) in height.
2. Structures in occupancy category R-3 not more than three stories in height.

**2213.2 Continuity and ties.** The following requirements shall be met:

1. All bolted connections shall have at least two bolts.
2. Bolted connections of all columns, beams, braces and other structural elements that are part of the lateral load resisting system shall have slip critical bolts.
3. End connections of all beams and girders shall have an axial tension strength equal to the larger of the vertical shear strength capacity of the connections at

either end, but not less than 10 kips (45 kN). For design of the connections, the shear force and the axial tensile force need not be considered to act simultaneously. For the purpose of meeting this integrity provision only, at short slotted holes one can assume the bolts have moved to the end of the slots and act in bearing for the strength check to resist the axial tension parallel to the slot. The connecting elements need to be verified for bearing at the bolt holes.

4. Elements and their connections that brace compression elements shall have an axial tension strength capacity of at least two percent of the maximum factored design load in the compression element being braced, but not less than 10 kips (45 kN). For design of the connections, the shear force and the axial tensile force need not be considered to act simultaneously. Where more than one element frames in one direction, none of the elements or connections shall have an axial tension strength capacity of less than 1 percent of the column load but not less than 10 kips (45 kN).

**2213.2.1 Vertical ties.** Each column splice shall be capable of resisting a tensile force equal to the largest factored vertical dead and live load reaction applied to the column at any floor level located within four floors below the splice.

**2213.3 Composite construction.** For steel framing members and/or decking acting compositely with concrete slabs, the following requirements shall be met.

1. Shear studs shall not be less than ½ inch (12.7 mm) in diameter. The spacing of shear studs shall not be greater than one per foot (305 mm) averaged over the length of the beam.
2. Connections at the discontinuous edges of permanent metal decking to supporting members shall have as a minimum a connection with a strength in the direction parallel to the rib of the deck equal to the shear strength of a ¾-inch (19.1 mm) puddle weld every 12 inches (305 mm) on center.
3. Side lap connections of permanent metal decking shall have as a minimum a connection with a strength equal to the strength of a button punch every 24 inches (610 mm) on center.
4. Welded wire fabric reinforcement in concrete slabs shall be continuous over all supports and in all spans. Minimum area of continuous reinforcement shall be 0.0015 times the area of concrete. The mesh should have tension splices and be anchored at discontinuous edges.



$$v = \frac{V}{C_o \Sigma L_i} \quad (\text{Equation 22-1})$$

where:

$v$  = Unit shear force, plf (kN/m).

$V$  = Shear force in Type II shear wall, lbs (kN).

$C_o$  = Shear resistance adjustment factor from Table 2211.3.

$\Sigma L_i$  = Sum of widths of Type II shear wall segments, feet (mm/1,000).

$$C = \frac{Vh}{C_o \Sigma L_i} \quad (\text{Equation 22-2})$$

where:

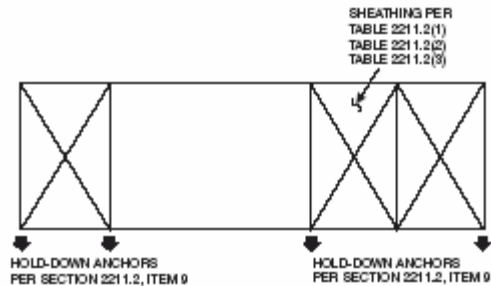
$C$  = Compression chord uplift force, lbs (kN).

$V$  = Shear force in Type II shear wall, lbs (kN).

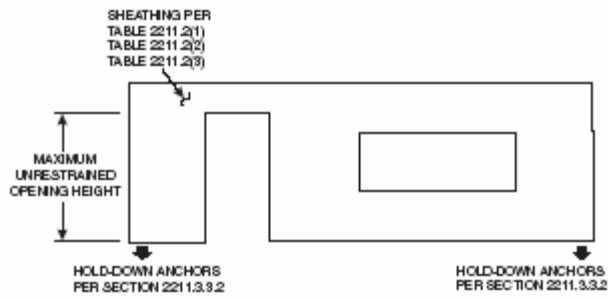
$h$  = Shear wall height feet, (mm/1,000).

$C_o$  = Shear resistance adjustment factor from Table 2211.3.

$\Sigma L_i$  = Sum of widths of Type II shear wall segments, feet (mm/1,000).



TYPE 1 SHEAR WALL



TYPE II SHEAR WALL

FIGURE 2203.1  
TYPE I AND TYPE II SHEAR WALLS

**{NOTE: Modify the title of Table 2211.2(2) below to read as follows: NOMINAL SHEAR VALUES FOR WIND AND SEISMIC FORCES IN POUNDS PER FOOT FOR SHEAR WALLS FRAMED WITH COLD-FORMED STEEL STUDS AND FACED WITH GYPSUM BOARD <sup>a,b</sup>}**

**TABLE 2211.2(1)**  
**NOMINAL SHEAR VALUES FOR WIND FORCES IN POUNDS PER FOOT FOR SHEAR WALLS**  
**FRAMED WITH COLD-FORMED STEEL STUDS<sup>a</sup>**

ASSEMBLY DESCRIPTION	MAXIMUM HEIGHT/LENGTH RATIO $h/w$	FASTENER SPACING AT PANEL EDGES <sup>b</sup> (inches)				MAXIMUM FRAMING SPACING (inches o.c.)
		6	4	3	2	
<sup>15</sup> / <sub>32</sub> -inch structural 1 sheathing (4-ply) plywood one side	2:1	1,065 <sup>c</sup>	—	—	—	24
<sup>7</sup> / <sub>16</sub> -inch rated sheathing (OSB), one side	2:1	910 <sup>c</sup>	1,410	1,735	1,910	24
<sup>7</sup> / <sub>16</sub> -inch rated sheathing (OSB), one side, oriented perpendicular to framing	2:1	1,020 <sup>c</sup>	—	—	—	24
<sup>7</sup> / <sub>16</sub> -inch rated sheathing (OSB), one side	4:1 <sup>d</sup>	—	1,025	1,425	1,825	24
0.018-inch steel sheet, one side	2:1	485	—	—	—	24
0.027-inch steel sheet, one side	4:1 <sup>d</sup>	—	1,000	—	—	24

For SI: 1 inch = 25.4 mm, 1 pound per foot = 14.5939 N/m.

- Nominal shear values shall be multiplied by the resistance factor  $\phi$  to determine design strength or divided by the safety factor  $\Omega$  to determine allowable shear values as set forth in Section 2211.2.1.
- Screws shall be attached to intermediate supports at 12 inches on center unless otherwise shown.
- Where fully blocked gypsum board is applied to the opposite side of this assembly, in accordance with Table 2211.2(2) with screw spacing at 7 inches o.c. edge and 7 inches o.c. field, these nominal values are permitted to be increased by 30 percent.
- Where aspect ratio ( $h/w$ ) is greater than 2:1, the design shear shall be reduced as required by Section 2211.2.2, item 5.

**TABLE 2211.2(2)**  
**NOMINAL SHEAR VALUES FOR WIND FORCES IN POUNDS PER FOOT FOR SHEAR WALLS**  
**FRAMED WITH COLD-FORMED STEEL STUDS AND FACED WITH GYPSUM BOARD<sup>a,b</sup>**

WALL CONSTRUCTION	MAXIMUM HEIGHT/LENGTH RATIO $h/w$	ORIENTATION	SCREW SPACING (inches)		NOMINAL SHEAR VALUE (plf)
			Edge	Field	
<sup>1</sup> / <sub>2</sub> -inch gypsum board on both sides of wall; Studs maximum 24 inches o.c.	2:1	Gypsum board applied perpendicular to framing with strap blocking behind the horizontal joint and with solid blocking between the first two end studs	7	7	585
			4	4	850

For SI: 1 inch = 25.4 mm, 1 pound per foot = 14.5939 N/m.

- Nominal shear values shall be multiplied by the resistance factor  $\phi$  to determine design strength or divided by the safety factor  $\Omega$  to determine allowable shear values as set forth in Section 2211.2.1.
- Walls resisting seismic loads shall be subject to the limitations in Section 1617.6.

**TABLE 2211.2(3)**  
**NOMINAL SHEAR VALUES FOR SEISMIC FORCES IN POUNDS PER FOOT FOR SHEAR WALLS**  
**FRAMED WITH COLD-FORMED STEEL STUDS<sup>a</sup>**

ASSEMBLY DESCRIPTION	MAXIMUM HEIGHT/LENGTH RATIO $h/w$	FASTENER SPACING AT PANEL EDGES <sup>b</sup> (inches)				MAXIMUM FRAMING SPACING (inches o.c.)
		6	4	3	2	
<sup>15</sup> / <sub>32</sub> -inch Structural 1 Sheathing (4-ply) plywood one side	2:1 <sup>c</sup>	780	990	1,465	1,625	24
<sup>15</sup> / <sub>32</sub> -inch Structural 1 Sheathing (4-ply) plywood one side; end studs 0.043 inch minimum thickness	2:1	—	—	1,775	2,190	24
<sup>15</sup> / <sub>32</sub> -inch Structural 1 Sheathing (4-ply) plywood one side; all studs and track 0.043 inch minimum thickness	2:1	890	1,330	1,775	2,190	24
<sup>7</sup> / <sub>16</sub> -inch OSB one side	2:1 <sup>c</sup>	700	915	1,275	1,625	24
<sup>7</sup> / <sub>16</sub> -inch OSB one side end studs, 0.043 inch minimum thickness	2:1	—	—	1,520	2,060	24
0.018-inch minimum thickness steel sheet one side	2:1	390	—	—	—	24
0.027-inch minimum thickness steel sheet one side	2:1 <sup>c</sup>	—	1,000	1,085	1,170	24

For SI: 1 inch = 25.4 mm, 1 pound per foot = 14.5939 N/m.

- Nominal shear values shall be multiplied by the resistance factor  $\phi$  to determine design strength or divided by the safety factor  $\Omega$  to determine allowable shear values as set forth in Section 2211.2.1.
- Screws shall be attached to intermediate supports at 12 inches o.c. unless otherwise shown.
- In Seismic Design Category A, B and C the aspect ratio ( $h/w$ ) is permitted to be 4:1 where the design shear is reduced as required by Section 2211.2.2, item 5.

**{NOTE: Modify the notes to Table 2211.3 below to read as follows: a. See Section 2211.3.2, item 2., b. See Section 2211.3.2, item b.}**

**TABLE 2211.3  
SHEAR RESISTANCE ADJUSTMENT FACTOR— $C_0$**

WALL HEIGHT ( $h$ )	MAXIMUM OPENING HEIGHT RATIO <sup>a</sup> AND HEIGHT				
	$h/3$	$h/2$	$2h/3$	$5h/6$	$h$
8'0"	2'8"	4'0"	5'4"	6'8"	8'0"
10'0"	3'4"	5'0"	6'8"	8'4"	10'0"
Percent full-height sheathing <sup>b</sup>	Shear Resistance Adjustment Factor				
10%	1.00	0.69	0.53	0.43	0.36
20%	1.00	0.71	0.56	0.45	0.38
30%	1.00	0.74	0.59	0.49	0.42
40%	1.00	0.77	0.63	0.53	0.45
50%	1.00	0.80	0.67	0.57	0.50
60%	1.00	0.83	0.71	0.63	0.56
70%	1.00	0.87	0.77	0.69	0.63
80%	1.00	0.91	0.83	0.77	0.71
90%	1.00	0.95	0.91	0.87	0.83
100%	1.00	1.00	1.00	1.00	1.00

a. See Section 2211.3.2(2).

b. See Section 2211.3.2(1).

**CHAPTER 23**  
**WOOD**

**SECTION BC 2301**  
**GENERAL**

**2301.1 Scope.** The provisions of this chapter shall govern the materials, design, construction and quality of wood members and their fasteners.

**2301.2 General design requirements.** The design of structural elements or systems, constructed partially or wholly of wood or wood-based products, shall be based on one of the following methods.

**2301.2.1 Allowable stress design.** Design using allowable stress design methods shall resist the applicable load combinations of Chapter 16 in accordance with the provisions of Sections 2304, 2305 and 2306.

**2301.2.2 Load and resistance factor design (LRFD).** Design using load and resistance factor design (LRFD) methods shall resist the applicable load combinations of Chapter 16 in accordance with the provisions of Sections 2304, 2305 and 2307.

**2301.2.3 Conventional light-frame wood construction.** The design and construction of conventional light-frame wood construction shall be in accordance with the provisions of Sections 2304 and 2308.

**Exception:** Buildings designed in accordance with the provisions of the *AF&PA Wood Frame Construction Manual for One- and Two-Family Dwellings* shall be deemed to meet the requirements of the provisions of Section 2308.

**2301.3 Nominal sizes.** For the purposes of this chapter, where dimensions of lumber are specified, they shall be deemed to be nominal dimensions unless specifically designated as actual dimensions (see Section 2304.2).

**SECTION BC 2302**  
**DEFINITIONS**

**2302.1 Definitions.** The following words and terms shall, for the purposes of this chapter, have the meanings shown herein.

**ADJUSTED SHEAR RESISTANCE.** The unadjusted shear resistance multiplied by the shear resistance adjustment factors of Table 2305.3.7.2.

**BRACED WALL LINE.** A series of braced wall panels in a single story that meets the requirements of Section 2308.3 or 2308.12.4.

**BRACED WALL PANEL.** A section of wall braced in accordance with Section

2308.9.3 or 2308.12.4.

**COLLECTOR.** A horizontal diaphragm element parallel and in line with the applied force that collects and transfers diaphragm shear forces to the vertical elements of the lateral-force-resisting system and/or distributes forces within the diaphragm.

**CONVENTIONAL LIGHT-FRAME WOOD CONSTRUCTION.** A type of construction whose primary structural elements are formed by a system of repetitive wood-framing members. See Section 2308 for conventional light-frame wood construction provisions.

**CRIPPLE WALL.** A framed stud wall extending from the top of the foundation to the underside of floor framing for the lowest occupied floor level.

**DIAPHRAGM, UNBLOCKED.** A diaphragm that has edge nailing at supporting members only. Blocking between supporting structural members at panel edges is not included. Diaphragm panels are field nailed to supporting members.

**DRAG STRUT.** See “Collector.”

**FIBERBOARD.** A fibrous, homogeneous panel made from lignocellulosic fibers (usually wood or cane) and having a density of less than 31 pounds per cubic foot (pcf) ( $497 \text{ kg/m}^3$ ) but more than 10 pcf ( $160 \text{ kg/m}^3$ ).

**FIRECUTTING.** The ends of wood beams, joists, and rafters resting on masonry or concrete walls shall be fire cut to a bevel of three inches in their depth.

**GLUED BUILT-UP MEMBER.** A structural element, the section of which is composed of built-up lumber, wood structural panels or wood structural panels in combination with lumber, all parts bonded together with structural adhesives.

**GRADE (LUMBER).** The classification of lumber in regard to strength and utility in accordance with American Softwood Lumber Standard DOC PS 20 and the grading rules of an approved lumber rules-writing agency.

**HARDBOARD.** A fibrous-felted, homogeneous panel made from lignocellulosic fibers consolidated under heat and pressure in a hot press to a density not less than 31 pcf ( $497 \text{ kg/m}^3$ ).

**NAILING, BOUNDARY.** A special nailing pattern required by design at the boundaries of diaphragms.

**NAILING, EDGE.** A special nailing pattern required by design at the edges of each panel within the assembly of a diaphragm or shear wall.

**NAILING, FIELD.** Nailing required between the sheathing panels and framing members

at locations other than boundary nailing and edge nailing.

**NATURALLY DURABLE WOOD.** The heartwood of the following species with the exception that an occasional piece with corner sapwood is permitted if 90 percent or more of the width of each side on which it occurs is heartwood.

**Decay resistant.** Redwood, cedar, black locust and black walnut.

**Termite resistant.** Redwood and Eastern red cedar.

**NOMINAL SIZE (LUMBER).** The commercial size designation of width and depth, in standard sawn lumber and glued-laminated lumber grades; somewhat larger than the standard net size of dressed lumber, in accordance with DOC PS 20 for sawn lumber and with the *National Design Specification for Wood Construction* (NDS) for glued-laminated lumber.

**PARTICLEBOARD.** A generic term for a panel primarily composed of cellulosic materials (usually wood), generally in the form of discrete pieces or particles, as distinguished from fibers. The cellulosic material is combined with synthetic resin or other suitable bonding system by a process in which the interparticle bond is created by the bonding system under heat and pressure.

**PERFORATED SHEAR WALL.** A wood structural panel sheathed wall with openings, that has not been specifically designed and detailed for force transfer around openings.

**PERFORATED SHEAR WALL SEGMENT.** A section of shear wall with full-height sheathing that meets the aspect ratio limits of Section 2305.3.3.

**PRESERVATIVE-TREATED WOOD.** Wood (including plywood) pressure treated with preservatives in accordance with Section 2303.1.8.

**REFERENCE RESISTANCE (*D*).** The resistance (force or moment as appropriate) of a member or connection computed at the reference end use conditions.

**SHEAR WALL.** A wall designed to resist lateral forces parallel to the plane of a wall.

**STRUCTURAL GLUED-LAMINATED TIMBER.** Any member comprising an assembly of laminations of lumber in which the grain of all laminations is approximately parallel longitudinally, in which the laminations are bonded with adhesives.

**SUBDIAPHRAGM.** A portion of a larger wood diaphragm designed to anchor and transfer local forces to primary diaphragm struts and the main diaphragm.

**TIE-DOWN (HOLD-DOWN).** A device used to resist uplift of the chords of shear walls.

**TREATED WOOD.** Wood impregnated under pressure with compounds that reduce its susceptibility to flame spread or to deterioration caused by fungi, insects or marine borers.

**UNADJUSTED SHEAR RESISTANCE.** The allowable shear set forth in Table 2306.4.1 where the aspect ratio of any perforated shear wall segment used in calculation of perforated shear wall resistance does not exceed 2:1. Where the aspect ratio of any perforated shear wall segment used in calculation of perforated shear wall resistance is greater than 2:1, but not exceeding 3.5:1, the unadjusted shear resistance shall be the allowable shear set forth in Table 2306.4.1, multiplied by  $2w/h$ .

**WOOD SHEAR PANEL.** A wood floor, roof or wall component sheathed to act as a shear wall or diaphragm.

**WOOD STRUCTURAL PANEL.** A panel manufactured from veneers, or wood strands or wafers, or a combination of veneer and wood strands or wafers, bonded together with waterproof synthetic resins or other suitable bonding systems. Examples of wood structural panels are:

**Composite panels.** A structural panel that is made of layers of veneer and wood-based material;

**Oriented strand board (OSB).** A wood structural panel that is a mat-formed product composed of thin rectangular wood strands or wafers arranged in oriented layers; or

**Plywood.** A wood structural panel comprised of plies of wood veneer arranged in cross-aligned layers.

## **SECTION BC 2303** **MINIMUM STANDARDS AND QUALITY**

**2303.1 General.** Structural lumber, end-jointed lumber, prefabricated I-joists, structural glued-laminated timber, wood structural panels, fiberboard sheathing (when used structurally), hardboard siding (when used structurally), particleboard, preservative-treated wood, fire-retardant-treated wood, hardwood, plywood, trusses and joist hangers shall conform to the applicable provisions of this section.

**2303.1.1 Lumber.** Lumber used for load-supporting purposes, including end-jointed or edge-glued lumber, machine stress-rated or machine evaluated lumber, shall be identified by the grade mark of a lumber grading or inspection agency that has been approved by the commissioner that complies with DOC PS 20 or equivalent. Grading practices and identification shall comply with rules published by an agency approved in accordance with the procedures of DOC PS 20 or equivalent procedures. In lieu of a grade mark on the material, a certificate of inspection as to species and grade issued by a lumber-grading or inspection agency meeting the requirements of this section is permitted to be accepted for precut, remanufactured or rough-sawn lumber, and for



sizes larger than 3 inches (76 mm) nominal thickness. Approved end-jointed lumber is permitted to be used interchangeably with solid-sawn members of the same species and grade.

**2303.1.2 Prefabricated wood I-joists.** Structural capacities and design provisions for prefabricated wood I-joists shall be established and monitored in accordance with ASTM D 5055.

**2303.1.3 Structural glued-laminated timber.** Glued-laminated timbers shall be manufactured and identified as required in AITC A190.1 and ASTM D 3737.

**2303.1.4 Wood structural panels.** Wood structural panels, when used structurally (including those used for siding, roof and wall sheathing, sub-flooring, diaphragms and built-up members), shall conform to the requirements for their type in DOC PS 1 or PS 2. Each panel or member shall be identified for grade and glue type by the trademarks of an approved testing and grading agency. Wood structural panel components shall be designed and fabricated in accordance with the applicable standards listed in Section 2306.1 and identified by the trademarks of an approved testing and inspection agency indicating conformance with the applicable standard. In addition, wood structural panels when permanently exposed in outdoor applications shall be of exterior type, except that wood structural panel roof sheathing exposed to the outdoors on the underside is permitted to be interior type bonded with exterior glue, Exposure 1.

**2303.1.5 Fiberboard.** Fiberboard for its various uses shall conform to ANSI/AHA A 194.1 or ASTM C 208. Fiberboard sheathing, when used structurally, shall be so identified by an approved agency as conforming to ANSI/AHA A 194.1 or ASTM C 208.

**2303.1.5.1 Jointing.** To ensure tight-fitting assemblies, edges shall be manufactured with square, ship-lapped, beveled, tongue-and-groove or U-shaped joints.

**2303.1.5.2 Roof insulation.** Where used as roof insulation in all types of construction, fiberboard shall be protected with an approved roof covering.

**2303.1.5.3 Wall insulation.** Where installed and fire-blocked to comply with Chapter 7, fiberboards are permitted as wall insulation in all types of construction. In fire walls and fire barriers, unless treated to comply with Section 803.1 for Class A materials, the boards shall be cemented directly to the concrete, masonry or other noncombustible base and shall be protected with an approved noncombustible veneer anchored to the base without intervening airspaces.

**2303.1.5.3.1 Protection.** Fiberboard wall insulation applied on the exterior of foundation walls shall be protected below ground level with a bituminous coating.

**2303.1.5.4 Insulating roof deck.** Where used as roof decking in open beam construction, fiberboard insulation roof deck shall have a nominal thickness of not less than 1 inch (25 mm).

**2303.1.6 Hardboard.** Hardboard siding used structurally shall be identified by an approved agency conforming to AHA A135.6. Hardboard under-layment shall meet the strength requirements of  $\frac{7}{32}$ -inch (5.6 mm) or  $\frac{1}{4}$ -inch (6.4 mm) service class hardboard planed or sanded on one side to a uniform thickness of not less than 0.200 inch (5.1 mm). Prefinished hardboard paneling shall meet the requirements of AHA A135.5. Other basic hardboard products shall meet the requirements of AHA A135.4. Hardboard products shall be installed in accordance with manufacturer's recommendations.

**2303.1.7 Particleboard.** Particleboard shall conform to ANSI A208.1. Particleboard shall be identified by the grade mark or certificate of inspection issued by an approved agency. Particleboard shall not be utilized for applications other than indicated in this section unless the particleboard complies with the provisions of Section 2306.4.3.

**2303.1.7.1 Floor underlayment.** Particleboard floor underlayment shall conform to Type PBU of ANSI A208.1. Type PBU underlayment shall not be less than  $\frac{1}{4}$ -inch (6.4 mm) thick and shall be installed in accordance with the instructions of the Composite Panel Association.

**2303.1.8 Preservative-treated wood.** Lumber, timber, plywood, piles and poles supporting permanent structures required by Section 2304.11 to be preservative-treated shall conform to the requirements of the applicable AWWA Standard C1, C2, C3, C4, C9, C14, C15, C16, C22, C23, C24, C28, C31, C33 and M4, for the species, product, preservative and end use. Preservatives shall conform to AWWA P1/P13, P2, P5, P8 and P9. Lumber and plywood used in wood foundation systems shall conform to Chapter 18.

**2303.1.8.1 Identification.** Wood required by Section 2304.11 to be preservative-treated shall bear the quality mark of an inspection agency that maintains continuing supervision, testing and inspection over the quality of the preservative-treated wood. Inspection agencies for preservative-treated wood shall be listed by an accreditation body that complies with the requirements of the American Lumber Standards Treated Wood Program, or its equivalent. The quality mark shall be on a stamp or label affixed to the preservative-treated wood, and shall include the following information:

1. Identification of treating manufacturer.
2. Type of preservative used.

3. Minimum preservative retention (pcf).
4. End use for which the product is treated.
5. AWWPA standard to which the product was treated.
6. Identity of the accredited inspection agency.

**2303.1.8.2 Moisture content.** Where preservative-treated wood is used in enclosed locations where drying in service cannot readily occur, such wood shall be at a moisture content of 19 percent or less before being covered with insulation, interior wall finish, floor covering or other materials.

**2303.1.9 Structural composite lumber.** Structural capacities for structural composite lumber shall be established and monitored in accordance with ASTM D 5456.

**2303.2 Fire-retardant-treated wood.** Fire-retardant-treated wood is any wood product which, when impregnated with chemicals by a pressure process or other means during manufacture, shall have, when tested in accordance with ASTM E 84, a listed flame spread index of 25 or less and show no evidence of significant progressive combustion when the test is continued for an additional 20-minute period. In addition, the flame front shall not progress more than 10.5 feet (3200 mm) beyond the centerline of the burners at any time during the test.

**2303.2.1 Labeling.** Fire-retardant-treated lumber and wood structural panels shall be labeled. The label shall contain the following items:

1. The identification of an approved agency in accordance with chapter 1 of Title 28 of the *Administrative Code*.
2. Identification of the treating manufacturer.
3. The name of the fire-retardant treatment.
4. The species of wood treated.
5. Flame spread and smoke-developed index.
6. Method of drying after treatment.
7. Conformance with appropriate standards in accordance with Sections 2303.2.2 through 2303.2.5.
8. For fire-retardant-treated wood exposed to weather, damp or wet locations, include the words “No increase in the listed classification when subjected to

the Standard Rain Test” (ASTM D 2898).

**2303.2.2 Strength adjustments.** Design values for untreated lumber and wood structural panels, as specified in Section 2303.1, shall be adjusted for fire-retardant-treated wood. Adjustments to design values shall be based on an approved method of investigation that takes into consideration the effects of the anticipated temperature and humidity to which the fire-retardant-treated wood will be subjected, the type of treatment and redrying procedures.

**2303.2.2.1 Wood structural panels.** The effect of treatment and the method of redrying after treatment, and exposure to high temperatures and high humidities on the flexure properties of fire-retardant-treated softwood plywood shall be determined in accordance with ASTM D 5516. The test data developed by ASTM D 5516 shall be used to develop adjustment factors, maximum loads and spans, or both, for untreated plywood design values in accordance with ASTM D 6305. Each manufacturer shall publish the allowable maximum loads and spans for service as floor and roof sheathing for its treatment.

**2303.2.2.2 Lumber.** For each species of wood treated, the effect of the treatment and the method of redrying after treatment and exposure to high temperatures and high humidities on the allowable design properties of fire-retardant-treated lumber shall be determined in accordance with ASTM D 5664. The test data developed by ASTM D 5664 shall be used to develop modification factors for use at or near room temperature and at elevated temperatures and humidity in accordance with an approved method of investigation. Each manufacturer shall publish the modification factors for service at temperatures of not less than 80°F (26.7°C) and for roof framing. The roof framing modification factors shall take into consideration the climatological location.

**2303.2.3 Exposure to weather, damp or wet locations.** Where fire-retardant-treated wood is exposed to weather, or damp or wet locations, it shall be identified as “Exterior” to indicate there is no increase in the listed flame spread index as defined in Section 2303.2 when subjected to ASTM D 2898.

**2303.2.4 Interior applications.** Interior fire-retardant-treated wood shall have moisture content of not over 28 percent when tested in accordance with ASTM D 3201 procedures at 92-percent relative humidity. Interior fire-retardant-treated wood shall be tested in accordance with Section 2303.2.2.1 or 2303.2.2.2. Interior fire-retardant-treated wood designated as Type A shall be tested in accordance with the provisions of this section.

**2303.2.5 Moisture content.** Fire-retardant-treated wood shall be dried to a moisture content of 19 percent or less for lumber and 15 percent or less for wood structural panels before use. For wood kiln dried after treatment (KDAT), the kiln temperatures shall not exceed those used in kiln drying the lumber and plywood submitted for the tests described in Section 2303.2.2.1 for plywood and 2303.2.2.2 for lumber.

**2303.2.6 Type I and II construction applications.** See Section 603.1 for limitations on the use of fire-retardant-treated wood in buildings of Type I or II construction.

**2303.3 Hardwood plywood.** Hardwood and decorative plywood shall be manufactured and identified as required in HPVA HP-1.

**2303.4 Trusses.** Metal-plate-connected wood trusses shall be manufactured as required by TPI 1. Each manufacturer of trusses using metal plate connectors shall retain an approved agency to make unscheduled inspections of truss manufacturing and delivery operations. The inspection shall cover all phases of truss operations, including lumber storage, handling, cutting fixtures, presses or rollers, manufacturing, bundling and banding.

**2303.4.1 Truss design drawings.** Truss construction documents shall be prepared by a registered design professional and shall be provided to the commissioner and approved prior to installation. These construction documents shall include, at a minimum, the information specified below. Truss shop drawings shall be provided with the shipment of trusses delivered to the job site.

1. Slope or depth, span and spacing;
2. Location of joints;
3. Required bearing widths;
4. Design loads as applicable;
5. Top chord live load (including snow loads);
6. Top chord dead load;
7. Bottom chord live load;
8. Bottom chord dead load;
9. Concentrated loads and their points of application;
10. Controlling wind and earthquake loads;
11. Adjustments to lumber and metal connector plate design value for conditions of use;
12. Each reaction force and direction;
13. Metal connector plate type, size, thickness or gage, and the dimensioned

location of each metal connector plate except where symmetrically located relative to the joint interface;

14. Lumber size, species and grade for each member;

15. Connection requirements for:

15.1. Truss to truss girder;

15.2. Truss ply to ply; and

15.3. Field splices;

16. Calculated deflection ratio or maximum deflection for live and total load;

17. Maximum axial compression forces in the truss members to design the size, connections and anchorage of the permanent continuous lateral bracing. Forces shall be shown on the truss construction documents or on supplemental documents; and

18. Required permanent truss member bracing location.

**2303.5 Test standard for joist hangers and connectors.** For the required test standards for joist hangers and connectors, see Section 1715.1.

**2303.6 Nails and staples.** Nails and staples shall conform to requirements of ASTM F 1667. Nails used for framing and sheathing connections shall have minimum average bending yield strengths as follows: 80 kips per square inch (ksi) (551 MPa) for shank diameters larger than 0.177 inch (4.50 mm) but not larger than 0.254 inch (6.45 mm), 90 ksi (620 MPa) for shank diameters larger than 0.142 inch (3.61 mm) but not larger than 0.177 inch (4.50 mm) and 100 ksi (689 MPa) for shank diameters of 0.142 inch (3.61 mm) or less.

**2303.7 Shrinkage.** Consideration shall be given in design to the possible effect of cross-grain dimensional changes considered vertically which may occur in lumber fabricated in a green condition.

## **SECTION BC 2304**

### **GENERAL CONSTRUCTION REQUIREMENTS**

**2304.1 General.** The provisions of this section apply to design methods specified in Section 2301.2.

**2304.2 Size of structural members.** Computations to determine the required sizes of members shall be based on the net dimensions (actual sizes) and not nominal sizes.

**2304.3 Wall framing.** The framing of exterior and interior walls shall be in accordance with the provisions specified in Section 2308 unless a specific design is furnished.

**2304.3.1 Bottom plates.** Studs shall have full bearing on a 2-inch-thick (actual 1 ½-inch, 38 mm) or larger plate or sill having a width at least equal to the width of the studs.

**2304.3.2 Framing over openings.** Headers, double joists, trusses or other approved assemblies that are of adequate size to transfer loads to the vertical members shall be provided over window and door openings in load-bearing walls and partitions.

**2304.3.3. Shrinkage.** Wood walls and bearing partitions shall not support more than two floors and a roof unless an analysis satisfactory to the commissioner shows that shrinkage of the wood framing will not have adverse effects on the structure or any plumbing, electrical or mechanical systems, or other equipment installed therein due to excessive shrinkage or differential movements caused by shrinkage. The analysis shall also show that the roof drainage system and the foregoing systems or equipment will not be adversely affected or, as an alternate, such systems shall be designed to accommodate the differential shrinkage or movements.

**2304.4 Floor and roof framing.** The framing of wood-joisted floors and wood framed roofs shall be in accordance with the provisions specified in Section 2308 unless a specific design is furnished.

**2304.5 Framing around flues and chimneys.** Combustible framing shall be a minimum of 2 inches (51 mm), but shall not be less than the distance specified in Sections 2111 and 2113 and the *New York City Mechanical Code*, from flues, chimneys and fireplaces, and 6 inches (152 mm) away from flue openings.

**2304.6 Wall sheathing.** Except as provided for in Section 1405 for weather boarding or where stucco construction that complies with Section 2510 is installed, enclosed buildings shall be sheathed with one of the materials of the nominal thickness specified in Table 2304.6 or any other approved material of equivalent strength or durability.

**2304.6.1 Wood structural panel sheathing.** Where wood structural panel sheathing is used as the exposed finish on the exterior of outside walls, it shall have an exterior exposure durability classification. Where wood structural panel sheathing is used on the exterior of outside walls but not as the exposed finish, it shall be of a type manufactured with exterior glue (Exposure 1 or Exterior). Where wood structural panel sheathing is used elsewhere, it shall be of a type manufactured with intermediate or exterior glue.

**2304.6.2 Interior paneling.** Softwood wood structural panels used for interior paneling shall conform with the provisions of Chapter 8 and shall be installed in accordance with Table 2304.9.1. Panels shall comply with DOC PS 1 or PS 2. Prefinished hardboard paneling shall meet the requirements of AHA A135.5,

*Prefinished Hardboard Paneling.* Hardwood plywood shall conform to HPVA HP-1, *The American National Standard for Hardwood and Decorative Plywood.*

**TABLE 2304.6**  
**MINIMUM THICKNESS OF WALL SHEATHING**  
**(Table 2304.6 attached to end of document)**

**2304.7 Floor and roof sheathing.**

**2304.7.1 Structural floor sheathing.** Structural floor sheathing shall be designed in accordance with the general provisions of this code and the special provisions in this section. Floor sheathing conforming to the provisions of Table 2304.7(1), 2304.7(2), 2304.7(3) or 2304.7(4) shall be deemed to meet the requirements of this section.

**2304.7.2 Structural roof sheathing.** Structural roof sheathing shall be designed in accordance with the general provisions of this code and the special provisions in this section. Roof sheathing conforming to the provisions of Table 2304.7(1), 2304.7(2), 2304.7(3) or 2304.7(5) shall be deemed to meet the requirements of this section. Wood structural panel roof sheathing shall be bonded by exterior glue.

**TABLE 2304.7(1)**  
**ALLOWABLE SPANS FOR LUMBER FLOOR AND ROOF SHEATHING<sup>a,b</sup>**  
**(Table 2304.7(1) attached to end of document)**

**TABLE 2304.7(2)**  
**SHEATHING LUMBER, MINIMUM GRADE REQUIREMENTS: BOARD**  
**GRADE**  
**(Table 2304.7(2) attached to end of document)**

**TABLE 2304.7(3)**  
**ALLOWABLE SPANS AND LOADS FOR WOOD STRUCTURAL PANEL**  
**SHEATHING AND SINGLE-FLOOR GRADES CONTINUOUS OVER TWO OR**  
**MORE SPANS WITH STRENGTH AXIS PERPENDICULAR TO SUPPORTS<sup>a,b</sup>**  
**(Table 2304.7(3) attached to end of document)**

**TABLE 2304.7(4)**  
**ALLOWABLE SPAN FOR WOOD STRUCTURAL PANEL COMBINATION**  
**SUBFLOOR-UNDERLAYMENT (SINGLE FLOOR)<sup>a,b</sup>**  
**(Panels Continuous Over Two or More Spans and Strength Axis Perpendicular to**  
**Supports)**  
**(Table 2304.7(4) attached to end of document)**

**TABLE 2304.7(5)**  
**ALLOWABLE LOAD (PSF) FOR WOOD STRUCTURAL PANEL ROOF**  
**SHEATHING CONTINUOUS OVER**  
**TWO OR MORE SPANS AND STRENGTH AXIS PARALLEL TO SUPPORTS**



**(Plywood Structural Panels Are Five-Ply, Five-Layer Unless Otherwise Noted)<sup>a,b</sup>**  
**(Table 2304.7(5) attached to end of document)**

**2304.8 Mechanically laminated floors and decks.**

**2304.8.1 General.** A laminated lumber floor or deck built up of wood members set on edge, when meeting the following requirements, is permitted to be designed as a solid floor or roof deck of the same thickness, and continuous spans are permitted to be designed on the basis of the full cross section using the simple span moment coefficient.

Nail lengths shall not be less than two and one-half times the net thickness of each lamination. Where deck supports are 4 feet (1219 mm) on center (o.c.) or less, side nails shall be spaced not more than 30 inches (762 mm) o.c. alternately near top and bottom edges, and staggered one-third of the spacing in adjacent laminations. Where supports are spaced more than 4 feet (1219 mm) o.c., side nails shall be spaced not more than 18 inches (457 mm) o.c. alternately near top and bottom edges, and staggered one-third of the spacing in adjacent laminations. Two side nails shall be used at each end of butt-jointed pieces.

Laminations shall be toenailed to supports with 20d or larger common nails. Where the supports are 4 feet (1219 mm) o.c. or less, alternate laminations shall be toenailed to alternate supports; where supports are spaced more than 4 feet (1219 mm) o.c., alternate laminations shall be toenailed to every support. A single-span deck shall have all laminations full length. A continuous deck of two spans shall not have more than every fourth lamination spliced within quarter points adjoining supports. Joints shall be closely butted over supports or staggered across the deck but within the adjoining quarter spans. No lamination shall be spliced more than twice in any span.

**2304.9 Connections and fasteners.**

**2304.9.1 Fastener requirements.** Connections for wood members shall be designed in accordance with the appropriate methodology in Section 2301.2. The number and size of nails connecting wood members shall not be less than that set forth in Table 2304.9.1.

**TABLE 2304.9.1**  
**FASTENING SCHEDULE**  
**(Table 2304.9.1 attached to end of document)**

**2304.9.2 Sheathing fasteners.** Sheathing nails or other approved sheathing connectors shall be driven so that their head or crown is flush with the surface of the sheathing.

**2304.9.3 Joist hangers and framing anchors.** Connections depending on joist

hangers or framing anchors, ties and other mechanical fastenings not otherwise covered are permitted where approved. The vertical load-bearing capacity, torsional moment capacity and deflection characteristics of joist hangers shall be determined in accordance with Section 1715.1.

**2304.9.4 Other fasteners.** Clips, staples, glues and other approved methods of fastening are permitted where approved.

**2304.9.5 Fasteners in preservative-treated and fire-retardant-treated wood.** Fasteners for preservative-treated and fire-retardant-treated wood shall be of hot-dipped zinc-coated galvanized steel, stainless steel, silicon bronze or copper. Fastenings for wood foundations shall be as required in AF & PA Technical Report No. 7.

**2304.9.6 Load path.** Where wall framing members are not continuous from foundation sill to roof, the members shall be secured to ensure a continuous load path. Where required, sheet metal clamps, ties or clips shall be formed of galvanized steel or other approved corrosion-resistant material not less than 0.040 inch (1.01 mm) nominal thickness.

**2304.9.7 Framing requirements.** Wood columns and posts shall be framed to provide full end bearing. Alternatively, column-and-post end connections shall be designed to resist the full compressive loads, neglecting end-bearing capacity. Column-and-post end connections shall be fastened to resist lateral and net induced uplift forces.

## **2304.10 Heavy timber construction.**

### **2304.10.1 Minimum member sizes.**

**2304.10.1.1 Columns.** Columns shall be at least 8 inches (203 mm) in all dimensions when supporting floor loads and at least 6 inches (152 mm) wide and 8 inches (203 mm) deep when supporting roof and ceiling loads only.

**2304.10.1.2 Beams and girders.** Beams and girders shall be at least 6 inches (152 mm) wide and 10 inches (254 mm) deep.

**2304.10.1.3 Frames and arches.** Frames and arches that spring from grade or the floor line and support floor loads shall be at least 8 inches (203 mm) in all dimensions. Frames or arches for roof construction that spring from grade or the floor line and do not support floor loads shall have members at least 6 inches (152 mm) wide and 8 inches (203 mm) deep for the lower half of the height, and at least 6 inches (152 mm) deep for the upper half.

Frames or arches for roof construction that spring from the top of walls or wall abutments, framed timber trusses, and other roof framing, which do not

support floor loads, shall have members at least 4 inches (102 mm) wide and 6 inches (152 mm) deep. Spaced members may be composed of two or more pieces at least 3 inches (76 mm) thick when blocked solidly through their intervening spaces or when such spaces are tightly closed by a continuous wood cover plate at least 2 inches (51 mm) thick secured to the underside of the members. Splice plates shall be at least 3 inches (76 mm) thick. When protected by approved automatic sprinklers under the roof deck, framing members shall be at least 3 inches (76 mm) wide.

**2304.10.1.4 Trusses.** Timber trusses supporting floor loads shall have members at least 8 inches (203 mm) in all dimensions.

**2304.10.2 Columns.** Columns shall be continuous or superimposed throughout all stories by means of reinforced concrete or metal caps with brackets, or shall be connected by properly designed steel or iron caps, with pintles and base plates, or by timber splice plates affixed to the columns by metal connectors housed within the contact faces, or by other approved methods.

**2304.10.2.1 Column connections.** Girders and beams shall be closely fitted around columns and adjoining ends shall be cross tied to each other, or inter-tied by caps or ties, to transfer horizontal loads across joints. Wood bolsters shall not be placed on tops of columns unless the columns support roof loads only.

**2304.10.3 Floor framing.** Approved wall plate boxes or hangers shall be provided where wood beams, girders or trusses rest on masonry or concrete walls. Where intermediate beams are used to support a floor, they shall rest on top of girders, or shall be supported by ledgers or blocks securely fastened to the sides of the girders, or they shall be supported by an approved metal hanger into which the ends of the beams shall be closely fitted.

**2304.10.4 Roof framing.** Every roof girder and at least every alternate roof beam shall be anchored to its supporting member; and every monitor and every saw tooth construction shall be anchored to the main roof construction. Such anchors shall consist of steel bolts of sufficient strength to resist vertical uplift of the roof.

**2304.10.5 Floor decks.** Floor decks and covering shall not extend closer than ½ inch (12.7 mm) to walls. Such ½-inch (12.7 mm) spaces shall be covered by a molding fastened to the wall either above or below the floor and arranged such that the molding will not obstruct the expansion or contraction movements of the floor. Corbeling of masonry walls under floors is permitted in place of such molding.

**2304.10.6 Roof decks.** Where supported by a wall, roof decks shall be anchored to walls to resist uplift forces determined in accordance with Chapter 16. Such anchors shall consist of steel bolts of sufficient strength to resist vertical uplift of the roof.

**2304.10.7 Fabrication.** All timber shall be accurately cut and framed to a close fit in

such a manner that the joints will have even bearing over the contact surfaces. Mortises shall be true to size for their full depth and tenons shall fit snugly. No shimming in joints, or open joints, shall be permitted.

**2304.10.8 Erection.** Joints shall have a tight fit. Fasteners shall be installed in a manner that will not damage the wood. End compression joints shall be brought to full bearing. All framework shall be carried up true and plumb. As erection progresses, the work shall be bolted, or nailed as necessary, to resist all dead load, wind, and erection stresses. The structure shall be properly aligned before final tightening of the connections.

### **2304.11 Protection against decay and termites.**

**2304.11.1 General.** Where required by this section, protection from decay and termites shall be provided by the use of naturally durable or preservative-treated wood.

**2304.11.2 Wood used above ground.** Wood installed above ground in the locations specified in Sections 2304.11.2.1 through 2304.11.2.6 shall be naturally durable wood or preservative-treated wood that uses water-borne preservatives, and shall be treated in accordance with AWPAC2 or C9 or applicable AWPAC standards for above ground use.

**2304.11.2.1 Joists, girders and subfloor.** Where wood joists or the bottom of a wood structural floor without joists are closer than 18 inches (457 mm), or wood girders are closer than 12 inches (305 mm) to the exposed ground in crawl spaces or unexcavated areas located within the perimeter of the building foundation, the floor assembly (including posts, girders, joists and subfloor) shall be of naturally durable or preservative-treated wood.

**2304.11.2.2 Framing.** Wood framing members, including wood sheathing, which rest on exterior foundation walls and are less than 8 inches (203 mm) from exposed earth shall be of naturally durable or preservative-treated wood. Wood framing members and furring strips attached directly to the interior of exterior masonry or concrete walls below grade shall be of approved naturally durable or preservative-treated wood.

**2304.11.2.3 Sleepers and sills.** Sleepers and sills on a concrete or masonry slab that is in direct contact with earth shall be of naturally durable or preservative-treated wood.

**2304.11.2.4 Girder ends.** The ends of wood girders entering exterior masonry or concrete walls shall be provided with a 1/2-inch (12.7 mm) air space on top, sides and end, unless naturally durable or preservative-treated wood is used.

**2304.11.2.5 Wood siding.** Clearance between wood siding and earth on the

exterior of a building shall not be less than 6 inches (152 mm) except where siding, sheathing and wall framing are of naturally durable or preservative-treated wood.

**2304.11.2.6 Posts or columns.** Posts or columns supporting permanent structures and supported by a concrete or masonry slab or footing that is in direct contact with the earth shall be of naturally durable or preservative-treated wood.

**Exceptions:**

1. Posts or columns that are either exposed to the weather or located in basements or cellars, supported by concrete piers or metal pedestals projected at least 1 inch (25 mm) above the slab or deck and 6 inches (152 mm) above exposed earth, and are separated therefrom by an impervious moisture barrier.
2. Posts or columns in enclosed crawl spaces or unexcavated areas located within the periphery of the building, supported by a concrete pier or metal pedestal at a height greater than 8 inches (203 mm) from exposed ground, and are separated therefrom by an impervious moisture barrier.

**2304.11.3 Laminated timbers.** The portions of glued-laminated timbers that form the structural supports of a building or other structure and are exposed to weather and not properly protected by a roof, eave or similar covering shall be pressure-treated with preservative, or be manufactured from naturally durable or preservative-treated wood.

**2304.11.4 Wood in contact with the ground or fresh water.** Wood in contact with the ground (exposed earth) that supports permanent structures shall be of naturally durable (species for both decay and termite resistance) or preservative-treated wood using water-borne preservatives and shall be treated in accordance with AWPAC2, C9 or other applicable AWPAC standard for soil or fresh water contact, where used in the locations specified in Sections 2304.11.4.1 and 2304.11.4.2.

**Exception:** Untreated wood is permitted where such wood is continuously and entirely below the ground-water level or submerged in fresh water.

**2304.11.4.1 Posts or columns.** Posts and columns supporting permanent structures that are embedded in concrete in direct contact with the earth or embedded in concrete exposed to the weather, or in direct contact with the earth, shall be of preservative-treated wood.

**2304.11.4.2 Wood structural members.** Wood structural members that support moisture-permeable floors or roofs that are exposed to the weather, such as concrete or masonry slabs, shall be of naturally durable or preservative-treated

wood unless separated from such floors or roofs by an impervious moisture barrier.

**2304.11.5 Supporting member for permanent appurtenances.** Naturally durable or preservative-treated wood shall be utilized for those portions of wood members that form the structural supports of buildings, balconies, porches or similar permanent building appurtenances where such members are exposed to the weather without adequate protection from a roof, eave, overhang or other covering to prevent moisture or water accumulation on the surface or at joints between members.

**2304.11.6 Termite protection.** In geographical areas where the hazard of termite damage is known to be very heavy, the floor framing shall be of naturally durable or preservative-treated wood, or provided with approved methods of termite protection.

**2304.11.7 Wood used in retaining walls and cribs.** Wood installed in retaining or crib walls shall be of preservative-treated wood treated in accordance with AWWA C2 or C9 for soil and fresh water contact.

**2304.11.8 Attic ventilation.** For attic ventilation, see Section 1203.2.

**2304.11.9 Under-floor ventilation (crawl space).** For under-floor ventilation (crawl space), see Section 1203.3.

**2304.11.10 Firecutting.** The ends of wood beams, joists and rafters resting on masonry or concrete walls shall be firecut to a bevel of three inches in their depth.

**2304.11.11 Debris.** All loose wood and debris and all wood forms shall be removed from spaces under the building. All stump and roots shall be grubbed to a minimum depth of twelve inches.

**2304.12 Wood supporting masonry or concrete.** Wood members shall not be used to permanently support the dead load of any masonry or concrete.

**Exceptions:**

1. Masonry or concrete nonstructural floor or roof surfacing not more than 4 inches (102 mm) thick is permitted to be supported by wood members.
2. Any structure is permitted to rest upon wood piles constructed in accordance with the requirements of Chapter 18.
3. Veneer of brick, concrete or stone applied as specified in Section 1405.5 having an installed weight of 40 pounds per square foot (psf) (1.9 kN/m<sup>2</sup>) or less is permitted to be supported by an approved treated wood foundation when the maximum height of veneer does not exceed 30 feet (9144 mm) above the foundation. Such veneer used as an interior wall finish is permitted

to be supported on wood floor construction. The wood floor construction shall be designed to support the additional weight of the veneer plus any other loads and to limit the deflection and shrinkage to  $\frac{1}{600}$  of the span of the supporting members.

4. Glass unit masonry having an installed weight of 20 psf (0.96 kN/m<sup>2</sup>) or less is permitted to be installed in accordance with the provisions of Section 2110. The wood construction supporting the glass unit masonry shall be designed for dead and live loads to limit deflection and shrinkage to  $\frac{1}{600}$  of the span of the supporting members.

## **SECTION BC 2305** **GENERAL DESIGN REQUIREMENTS FOR LATERAL-FORCE-RESISTING SYSTEMS**

**2305.1 General.** Structures using wood shear walls and diaphragms to resist wind, seismic and other lateral loads shall be designed and constructed in accordance with the provisions of this section.

**2305.1.1 Shear resistance based on principles of mechanics.** Shear resistance of diaphragms and shear walls are permitted to be calculated by principles of mechanics using values of fastener strength and sheathing shear resistance.

**2305.1.2 Framing.** Boundary elements shall be provided to transmit tension and compression forces. Perimeter members at openings shall be provided and shall be detailed to distribute the shearing stresses. Diaphragm and shear wall sheathing shall not be used to splice boundary elements. Diaphragm chords and collectors shall be placed in, or tangent to, the plane of the diaphragm framing unless it can be demonstrated that the moments, shears and deformations, considering eccentricities resulting from other configurations can be tolerated without exceeding the adjusted resistance and drift limits.

**2305.1.2.1 Framing members.** Framing members shall be at least 2 inch (51 mm) nominal width. In general, adjoining panel edges shall bear and be attached to the framing members and butt along their centerlines. Nails shall be placed not less than  $\frac{3}{8}$  inch (9.5 mm) from the panel edge, not more than 12 inches (305 mm) apart along intermediate supports, and 6 inches (152 mm) along panel edge bearings, and shall be firmly driven into the framing members.

**2305.1.3 Openings in shear panels.** Openings in shear panels that materially affect their strength shall be fully detailed on the plans, and shall have their edges adequately reinforced to transfer all shearing stresses.

**2305.1.4 Shear panel connections.** Positive connections and anchorages, capable of resisting the design forces, shall be provided between the shear panel and the attached components. In Seismic Design Category D, toenails shall not be used to transfer

lateral forces in excess of 150 pounds per foot (2189 N/m) from diaphragms to shear walls, drag struts (collectors) or other elements, or from shear walls to other elements.

**2305.1.5 Wood members resisting horizontal seismic forces contributed by masonry and concrete.** Wood shear walls, diaphragms, horizontal trusses and other members shall not be used to resist horizontal seismic forces contributed by masonry or concrete construction in structures over one story in height.

**Exceptions:**

1. Wood floor and roof members are permitted to be used in horizontal trusses and diaphragms to resist horizontal seismic forces contributed by masonry or concrete construction (including those due to masonry veneer, fireplaces and chimneys) provided such forces do not result in torsional force distribution through the truss or diaphragm.
2. Wood structural panel sheathed shear walls are permitted to be used to provide resistance to seismic forces contributed by masonry or concrete construction in two-story structures of masonry or concrete construction, provided the following requirements are met:
  - 2.1. Story-to-story wall heights shall not exceed 12 feet (3658 mm).
  - 2.2. Diaphragms shall not be designed to transmit lateral forces by rotation. Diaphragms shall not cantilever past the outermost supporting shear wall.
  - 2.3. Combined deflections of diaphragms and shear walls shall not permit story drift of supported masonry or concrete walls to exceed the limit of Section 1617.3.
  - 2.4. Wood structural panel sheathing in diaphragms shall have unsupported edges blocked. Wood structural panel sheathing for both stories of shear walls shall have unsupported edges blocked and, for the lower story, shall have a minimum thickness of  $\frac{15}{32}$  inch (11.9 mm).
  - 2.5. There shall be no out-of-plane horizontal offsets between the first and second stories of wood structural panel shear walls.

**2305.2 Design of wood diaphragms.**

**2305.2.1 General.** Wood diaphragms are permitted to be used to resist horizontal forces provided the deflection in the plane of the diaphragm, as determined by calculations, tests or analogies drawn therefrom, does not exceed the permissible deflection of attached distributing or resisting elements. Connections shall extend into



the diaphragm a sufficient distance to develop the force transferred into the diaphragm.

**2305.2.2 Deflection.** Permissible deflection shall be that deflection up to which the diaphragm and any attached distributing or resisting element will maintain its structural integrity under design load conditions, such that the resisting element will continue to support design loads without danger to occupants of the structure. Calculations for diaphragm deflection shall account for the usual bending and shear components as well as any other factors, such as nail deformation, which will contribute to deflection. The deflection ( $\Delta$ ) of a blocked wood structural panel diaphragm uniformly nailed throughout is permitted to be calculated by using the following formula. If not uniformly nailed, the constant 0.188 (For SI: 1/1627) in the third term must be modified accordingly.

**(Equation 23-1 attached to end of document)**

**2305.2.3 Diaphragm aspect ratios.** Size and shape of diaphragms shall be limited as set forth in Table 2305.2.3.

**TABLE 2305.2.3**  
**MAXIMUM DIAPHRAGM DIMENSION RATIOS HORIZONTAL AND**  
**SLOPED DIAPHRAGM**  
**(Table 2305.2.3 attached to end of document)**

**2305.2.4 Construction.** Shear panels shall be constructed of wood structural panels, manufactured with exterior glue, not less than 4 feet by 8 feet (1219 mm by 2438 mm), except at boundaries and changes in framing. Boundary elements shall be connected at corners. Wood structural panel thickness for horizontal diaphragms shall not be less than set forth in Tables 2304.7(3) and 2304.7(5) for corresponding joist spacing and loads, except that ¼ inch (6.4 mm) is permitted to be used where perpendicular loads permit. Sheet-type sheathing shall be arranged so that the width of a sheet in a shear wall shall not be less than 2 feet (610 mm).

**2305.2.5 Rigid diaphragms.** Design of structures with rigid diaphragms shall conform to the structure configuration requirements of Section 9.5.2.3 of ASCE 7 and the horizontal shear distribution requirements of Section 9.5.5.5 of ASCE 7.

Open front structures with rigid wood diaphragms resulting in torsional force distribution are permitted provided the length,  $l$ , of the diaphragm normal to the open side does not exceed 25 feet (7620 mm), the diaphragm sheathing conforms to Section 2305.2.4, and the  $l/w$  ratio [as shown in Figure 2305.2.5(1)] is less than 1.0 for one-story structures or 0.67 for structures over one story in height.

**Exception:** Where calculations show that diaphragm deflections can be tolerated, the length,  $l$ , normal to the open end is permitted to be increased to a  $l/w$  ratio not greater than 1.5 where sheathed in compliance with Section 2305.2.4 or to 1.0

where sheathed in compliance with Section 2306.3.4 or 2306.3.5.

Rigid wood diaphragms are permitted to cantilever past the outermost supporting shear wall (or other vertical resisting element) a length,  $l$ , of not more than 25 feet (7620 mm) or two-thirds of the diaphragm width,  $w$ , whichever is the smaller. Figure 2305.2.5(2) illustrates the dimensions of  $l$  and  $w$  for a cantilevered diaphragm.

Structures with rigid wood diaphragms having a torsional irregularity in accordance with Table 1616.5.1.1, Item 1, shall meet the following requirements: The  $l/w$  ratio shall not exceed 1.0 for one-story structures or 0.67 for structures over one story in height, where  $l$  is the dimension parallel to the load direction for which the irregularity exists.

**Exception:** Where calculations demonstrate that the diaphragm deflections can be tolerated, the width is permitted to be increased and the  $l/w$  ratio is permitted to be increased to 1.5 where sheathed in compliance with Section 2306.3.4 or 2306.3.5.

**FIGURE 2305.2.5(1)**  
**DIAPHRAGM LENGTH AND WIDTH FOR PLAN VIEW OF OPEN FRONT**  
**BUILDING**

**(Figure 2305.2.5(1) attached to end of document)**

**FIGURE 2305.2.5(2)**  
**DIAPHRAGM LENGTH AND WIDTH FOR PLAN VIEW OF CANTILEVERED**  
**DIAPHRAGM**

**(Figure 2305.2.5(2) attached to end of document)**

**2305.3 Design of wood shear walls.**

**2305.3.1 General.** Wood shear walls are permitted to resist horizontal forces in vertical distributing or resisting elements, provided the deflection in the plane of the shear wall, as determined by calculations, tests or analogies drawn therefrom, does not exceed the more restrictive of the permissible deflection of attached distributing or resisting elements or the drift limits of Section 1617.3.

**2305.3.2 Deflection.** Permissible deflection shall be that deflection up to which the shear wall and any attached distributing or resisting element will maintain its structural integrity under design load conditions, i.e., continue to support design loads without danger to occupants of the structure.

The deflection ( $\Delta$ ) of a blocked wood structural panel shear wall uniformly fastened throughout is permitted to be calculated by the use of the following formula:

**(Equation 23-2 attached to end of document)**

**2305.3.3 Shear wall aspect ratios.** Size and shape of shear walls and shear wall

segments within shear walls containing openings shall be limited as set forth in Table 2305.3.3.

**TABLE 2305.3.3**  
**MAXIMUM SHEAR WALL ASPECT RATIOS**  
**(Table 2305.3.3 attached to end of document)**

**2305.3.4 Shear wall height definition.** The height of a shear wall shall be defined as:

1. The maximum clear height from top of foundation to bottom of diaphragm framing above; or
2. The maximum clear height from top of diaphragm to bottom of diaphragm framing above [see Figure 2305.3.4(a)].

**FIGURE 2305.3.4**  
**GENERAL DEFINITION OF SHEAR WALL HEIGHT, WIDTH AND HEIGHT-TO-WIDTH RATIO**  
**(Figure 2305.3.4 attached to end of document)**

**2305.3.5 Shear wall width definition.** The width of a shear wall shall be defined as the sheathed dimension of the shear wall in the direction of application of force [see Figure 2305.3.4(a)].

**2305.3.5.1 Shear wall segment width definition.** The width of full-height sheathing adjacent to unrestrained openings in a shear wall.

**2305.3.6 Overturning restraint.** Where the dead load stabilizing moment in accordance with Chapter 16 allowable stress design load combinations is not sufficient to prevent uplift due to overturning moments on the wall, an anchoring device shall be provided. Anchoring devices shall maintain a continuous load path to the foundation.

**2305.3.7 Shear walls with openings.** The provisions of this section shall apply to the design of shear walls with openings. Where framing and connections around the openings are designed for force transfer around the openings, the provisions of Section 2305.3.7.1 shall apply. Where framing and connections around the openings are not designed for force transfer around the openings, the provisions of Section 2305.3.7.2 shall apply.

**2305.3.7.1 Force transfer around openings.** Where shear walls with openings are designed for force transfer around the openings, the limitations of Table 2305.3.3 shall apply to the overall shear wall including openings and to each wall pier at the side of an opening. The height of a wall pier shall be defined as the clear height of the pier at the side of an opening. The width of a wall pier shall be defined as the sheathed width of the pier at the side of an opening. Design for

force transfer shall be based on a rational analysis. Detailing of boundary elements around the opening shall be provided in accordance with the provisions of this section [see Figure 2305.3.4(b)].

**2305.3.7.2 Perforated shear walls.** The provisions of Section 2305.3.7.2 shall be permitted to be used for the design of perforated shear walls.

**2305.3.7.2.1 Limitations.** The following limitations shall apply to the use of Section 2305.3.7.2:

1. A perforated shear wall segment shall be located at each end of a perforated shear wall. Openings shall be permitted to occur beyond the ends of the perforated shear wall; however, the width of such openings shall not be included in the width of the perforated shear wall.
2. The allowable shear set forth in Table 2306.4.1 shall not exceed 490 plf (7150 N/m).
3. Where out-of-plane offsets occur, portions of the wall on each side of the offset shall be considered as separate perforated shear walls.
4. Collectors for shear transfer shall be provided through the full length of the perforated shear wall.
5. A perforated shear wall shall have uniform top of wall and bottom of wall elevations. Perforated shear walls not having uniform elevations shall be designed by other methods.
6. Perforated shear wall height,  $h$ , shall not exceed 20 feet (6096 mm).

**2305.3.7.2.2 Perforated shear wall resistance.** The resistance of a perforated shear wall shall be calculated in accordance with the following:

1. The percent of full-height sheathing shall be calculated as the sum of the widths of perforated shear wall segments divided by the total width of the perforated shear wall including openings.
2. The maximum opening height shall be taken as the maximum opening clear height. Where areas above and below an opening remain unsheathed, the height of opening shall be defined as the height of the wall.
3. The adjusted shear resistance shall be calculated by multiplying the unadjusted shear resistance by the shear resistance adjustment factors of Table 2305.3.7.2. For intermediate percentages of full-height sheathing, the values in Table 2305.3.7.2 are permitted to be

interpolated.

4. The perforated shear wall resistance shall be equal to the adjusted shear resistance times the sum of the widths of the perforated shear wall segments.

**2305.3.7.2.3 Anchorage and load path.** Design of perforated shear wall anchorage and load path shall conform to the requirements of Sections 2305.3.7.2.4 through 2305.3.7.2.8, or shall be calculated using principles of mechanics. Except as modified by these sections, wall framing, sheathing, sheathing attachment and fastener schedules shall conform to the requirements of Section 2305.2.4 and Table 2306.4.1.

**2305.3.7.2.4 Uplift anchorage at perforated shear wall ends.** Anchorage for uplift forces due to overturning shall be provided at each end of the perforated shear wall. The uplift anchorage shall conform to the requirements of Section 2305.3.6 except that for each story the minimum tension chord uplift force,  $T$ , shall be calculated in accordance with the following:

**(Equation 23-3 attached to end of document)**

**2305.3.7.2.5 Anchorage for in-plane shear.** The unit shear force,  $v$ , transmitted into the top of a perforated shear wall, out of the base of the perforated shear wall at full-height sheathing and into collectors (drag struts) connecting shear wall segments, shall be calculated in accordance with the following:

**(Equation 23-4 attached to end of document)**

**2305.3.7.2.6 Uplift anchorage between perforated shear wall ends.** In addition to the requirements of Section 2305.3.7.2.4, perforated shear wall bottom plates at full-height sheathing shall be anchored for a uniform uplift force,  $t$ , equal to the unit shear force,  $v$ , determined in Section 2305.3.7.2.5.

**TABLE 2305.3.7.2**  
**SHEAR RESISTANCE ADJUSTMENT FACTOR,  $C_o$**   
**(Table 2305.3.7.2 attached to end of document)**

**2305.3.7.2.7 Compression chords.** Each end of each perforated shear wall segment shall be designed for a compression chord force,  $C$ , equal to the tension chord uplift force,  $T$ , calculated in Section 2305.3.7.2.4.

**2305.3.7.2.8 Load path.** A load path to the foundation shall be provided for each uplift force,  $T$  and  $t$ , for each shear force,  $V$  and  $v$ , and for each compression chord force,  $C$ . Elements resisting shear wall forces contributed by multiple stories shall be designed for the sum of forces contributed by each

story.

**2305.3.7.2.9 Deflection of shear walls with openings.** The controlling deflection of a blocked shear wall with openings uniformly nailed throughout shall be taken as the maximum individual deflection of the shear wall segments calculated in accordance with Section 2305.3.2, divided by the appropriate shear resistance adjustment factors of Table 2305.3.7.2.

**2305.3.8 Summing shear capacities.** The shear values for shear panels of different capacities applied to the same side of the wall are not cumulative except as allowed in Table 2306.4.1.

The shear values for material of the same type and capacity applied to both faces of the same wall are cumulative. Where the material capacities are not equal, the allowable shear shall be either two times the smaller shear capacity or the capacity of the stronger side, whichever is greater.

Summing shear capacities of dissimilar materials applied to opposite faces or to the same wall line is not allowed.

**Exception:** For wind design, the allowable shear capacity of shear wall segments sheathed with a combination of wood structural panels and gypsum wallboard on opposite faces, fiberboard structural sheathing and gypsum wall board on opposite faces or hardboard panel siding and gypsum wallboard on opposite faces shall equal the sum of the sheathing capacities of each face separately.

**2305.3.9 Adhesives.** Adhesive attachment of shear wall sheathing is not permitted as a substitute for mechanical fasteners, and shall not be used in shear wall strength calculations alone, or in combination with mechanical fasteners in Seismic Design Category D.

**2305.3.10 Sill plate size and anchorage in Seismic Design Category D.** Two-inch (51 mm) nominal wood sill plates for shear walls shall include steel plate washers, a minimum of  $\frac{3}{16}$  inch by 2 inches by 2 inches (4.76 mm by 51 mm by 51 mm) in size, between the sill plate and nut. Sill plates resisting a design load greater than 490 plf (LRFD) (7154 N/m) or 350 plf (ASD) (5110 N/m) shall not be less than a 3-inch (76 mm) nominal member. Where a single 3-inch (76 mm) nominal sill plate is used, 2-20d box end nails shall be substituted for 2-16d common end nails found in Line 8 of Table 2304.9.1.

**Exception:** In shear walls where the design load is less than 840 plf (LRFD) (12 264 N/m) or 600 plf (ASD) (8760 N/m), the sill plate is permitted to be a 2-inch (51mm) nominal member if the sill plate is anchored by two times the number of bolts required by design and  $\frac{3}{16}$  inch by 2 inch by 2 inch (4.76 mm by 51 mm by 51 mm) plate washers are used.

**SECTION BC 2306**  
**ALLOWABLE STRESS DESIGN**

**2306.1 Allowable stress design.** The structural analysis and construction of wood elements in structures using allowable design methods shall be in accordance with the following applicable standards:

**American Forest & Paper Association.**

NDS National Design Specification for Wood Construction

**American Institute of Timber Construction.**

<u>AITC 104</u>	<u>Typical Construction Details</u>
<u>AITC 110</u>	<u>Standard Appearance Grades for Structural Glued Laminated Timber</u>
<u>AITC 112</u>	<u>Standard for Tongue-and-Groove Heavy Timber Roof Decking</u>
<u>AITC 113</u>	<u>Standard for Dimensions of Structural Glued Laminated Timber</u>
<u>AITC 117</u>	<u>Standard Specifications for Structural Glued Laminated Timber of Softwood Species</u>
<u>AITC 119</u>	<u>Structural Standard Specifications for Glued Laminated Timber of Hardwood Species</u>
<u>AITC A190.1</u>	<u>Structural Glued Laminated Timber</u>
<u>AITC 200</u>	<u>Inspection Manual</u>
<u>AITC 500</u>	<u>Determination of Design Values for Structural Glued Laminated Timber</u>

**Truss Plate Institute, Inc.**

TPI 1 National Design Standard for Metal Plate Connected Wood Truss Construction

**American Society of Agricultural Engineers.**

ASAE EP 484.2 Diaphragm Design of Metal-Clad, Post-Frame Rectangular Buildings

ASAE EP 486.1 Shallow Post Foundation Design

ASAE 559 Design Requirements and Bending Properties for Mechanically Laminated Columns

**APA—The Engineered Wood Association.**

Plywood Design Specification

Plywood Design Specification Supplement 1 - Design & Fabrication of Plywood Curved Panels.

Plywood Design Specification Supplement 2 -  
Design & Fabrication of Glued Plywood-Lumber Beams.

Plywood Design Specification Supplement 3 -  
Design & Fabrication of Plywood Stressed-Skin Panels.

Plywood Design Specification Supplement 4 -  
Design & Fabrication of Plywood Sandwich Panels.

Plywood Design Specification Supplement 5 -  
Design & Fabrication of All-Plywood Beams.

<u>EWS T300</u>	<u>Glulam Connection Details</u>
<u>EWS S560</u>	<u>Field Notching and Drilling of Glued Laminated Timber Beams</u>
<u>EWS S475</u>	<u>Glued Laminated Beam Design Tables</u>
<u>EWS X450</u>	<u>Glulam in Residential Construction</u>
<u>EWS X440</u>	<u>Product and Application Guide: Glulam</u>
<u>EWS R540</u>	<u>Builders Tips: Proper Storage and Handling of Glulam Beams</u>

**2306.1.1 Joists and rafters.** The design of rafter spans is permitted to be in accordance with the *AF&PA Span Tables for Joists and Rafters*.

**2306.1.2 Plank and beam flooring.** The design of plank and beam flooring is permitted to be in accordance with the *AF&PA Wood Construction Data No. 4*.

**2306.1.3 Treated wood stress adjustments.** The allowable unit stresses for preservative-treated wood need no adjustment for treatment, but are subject to other adjustments. The allowable unit stresses for fire-retardant-treated wood, including fastener values, shall be developed from an approved method of investigation that considers the effects of anticipated temperature and humidity to which the fire-retardant-treated wood will be subjected, the type of treatment and the redrying process. Other adjustments are applicable except that the impact load duration shall not apply.

## **2306.2 Wind provisions for walls.**

**2306.2.1 Wall stud bending stress increase.** The NDS fiber stress in bending ( $F_b$ ) design values for wood studs resisting wind shall be increased by the factors in Table 2306.2.1, in lieu of the 1.15 repetitive member factor, to take into consideration the load sharing and composite actions provided by the wood structural panels as defined in Section 2302.1, where the studs are designed for bending in accordance with Section 1609.6 spaced no more than 16 inches (406 mm) o.c, covered on the inside with a minimum of 1/2-inch (12.7 mm) gypsum board fastened in accordance with Table 2306.4.5, and sheathed on the exterior with a minimum of 3/8-inch (9.5 mm) wood structural panel sheathing that is attached to the studs using a minimum of 8d



common nails spaced a maximum of 6 inches o.c. (152 mm) at panel edges and 12 inches o.c. (305 mm) in the field of the panels.

**TABLE 2306.2.1**  
**WALL STUD BENDING STRESS INCREASE FACTORS**  
**(Table 2306.1 attached to end of document)**

**2306.3 Wood diaphragms.**

**2306.3.1 Shear capacities modifications.** The allowable shear capacities in Table 2306.3.1 for horizontal wood structural panel diaphragms shall be increased 40 percent for wind design.

**TABLE 2306.3.1**  
**RECOMMENDED SHEAR (POUNDS PER FOOT) FOR WOOD STRUCTURAL**  
**PANEL DIAPHRAGMS WITH FRAMING OF DOUGLAS-FIR-LARCH, OR**  
**SOUTHERN PINE<sup>a</sup> FOR WIND OR SEISMIC LOADING**  
**(Table 2306.3.1 attached to end of document)**

**2306.3.2 Wood structural panel diaphragms.** Structural panel diaphragms with wood structural panels are permitted to be used to resist horizontal forces not exceeding those set forth in Table 2306.3.1 or 2306.3.2 or calculated by principles of mechanics without limitations by using values for fastener strength in the NDS structural design properties for wood structural panels based on DOC PS-1 and DOC PS-2 or plywood design properties given in the APA Plywood Design Specification.

**TABLE 2306.3.2**  
**ALLOWABLE SHEAR IN POUNDS PER FOOT FOR HORIZONTAL**  
**BLOCKED DIAPHRAGMS UTILIZING MULTIPLE ROWS OF FASTENERS**  
**(HIGH LOAD DIAPHRAGMS) WITH FRAMING OF DOUGLAS FIR, LARCH**  
**OR SOUTHERN PINE<sup>a</sup> FOR WIND OR SEISMIC LOADING<sup>b</sup>**  
**(Table 2306.3.2 attached to end of document)**

**2306.3.3 Diagonally sheathed lumber diaphragms.** Diagonally sheathed lumber diaphragms shall be nailed in accordance with Table 2306.3.3.

**TABLE 2306.3.3**  
**DIAGONALLY SHEATHED LUMBER DIAPHRAGM NAILING SCHEDULE**  
**(Table 2306.3.3 attached to end of document)**

**2306.3.4 Single diagonally sheathed lumber diaphragms.** Single diagonally sheathed lumber diaphragms shall be constructed of minimum 1-inch (25 mm) thick nominal sheathing boards laid at an angle of approximately 45 degrees (0.78 rad) to the supports. The shear capacity for single diagonally sheathed lumber diaphragms of southern pine or Douglas fir-larch shall not exceed 300 plf (4378 N/m) of width. The shear capacities shall be adjusted by reduction factors of 0.82 for framing members of

species with a specific gravity equal to or greater than 0.42 but less than 0.49 and 0.65 for species with a specific gravity of less than 0.42, as contained in the NDS.

**2306.3.4.1 End joints.** End joints in adjacent boards shall be separated by at least one stud or joist space and there shall be at least two boards between joints on the same support.

**2306.3.4.2 Single diagonally sheathed lumber diaphragms.** Single diagonally sheathed lumber diaphragms made up of 2-inch (51 mm) nominal diagonal lumber sheathing fastened with 16d nails shall be designed with the same shear capacities as shear panels using 1-inch (25 mm) boards fastened with 8d nails, provided there are not splices in adjacent boards on the same support and the supports are not less than 4 inch (102 mm) nominal depth or 3 inch (76 mm) nominal thickness.

**2306.3.5 Double diagonally sheathed lumber diaphragms.** Double diagonally sheathed lumber diaphragms shall be constructed of two layers of diagonal sheathing boards at 90 degrees (1.57 rad) to each other on the same face of the supporting members. Each chord shall be considered as a beam with uniform load per foot equal to 50 percent of the unit shear due to diaphragm action. The load shall be assumed as acting normal to the chord in the plan of the diaphragm in either direction. The span of the chord or portion thereof shall be the distance between framing members of the diaphragm, such as the joists, studs and blocking that serve to transfer the assumed load to the sheathing. The shear capacity of double diagonally sheathed diaphragms of Southern pine or Douglas fir-larch shall not exceed 600 plf (8756 kN/m) of width. The shear capacity shall be adjusted by reduction factors of 0.82 for framing members of species with a specific gravity equal to or greater than 0.42 but less than 0.49 and 0.65 for species with a specific gravity of less than 0.42, as contained in the NDS. Nailing of diagonally sheathed lumber diaphragms shall be in accordance with Table 2306.3.3.

**2306.3.6 Gypsum board diaphragm ceilings.** Gypsum board diaphragm ceilings shall be in accordance with Section 2508.5.

**2306.4 Shear walls.** Panel sheathing joints in shear walls shall occur over studs or blocking. Adjacent panel sheathing joints shall occur over and be nailed to common framing members (see Section 2305.3.1 for limitations on shear wall bracing materials).

**2306.4.1 Wood structural panel shear walls.** The allowable shear capacities for wood structural panel shear walls shall be in accordance with Table 2306.4.1. These capacities are permitted to be increased 40 percent for wind design. Shear walls are permitted to be calculated by principles of mechanics without limitations by using values for nail strength given in the NDS and wood structural panel design properties given in the APA/PDS.

**TABLE 2306.4.1**

**ALLOWABLE SHEAR (POUNDS PER FOOT) FOR WOOD STRUCTURAL  
PANEL SHEAR WALLS WITH FRAMING OF DOUGLAS-FIR-LARCH, OR  
SOUTHERN PINE<sup>a</sup> FOR WIND OR SEISMIC LOADING<sup>b, h, i, j</sup>**

**(Table 2306.4.1 attached to end of document)**

**2306.4.2 Lumber sheathed shear walls.** Single and double diagonally sheathed lumber diaphragms are permitted using the construction and allowable load provisions of Sections 2306.3.4 and 2306.3.5.

**2306.4.3 Particleboard shear walls.** The design shear capacity of particleboard shear walls shall be in accordance with Table 2306.4.3. Shear panels shall be constructed with particleboard sheets not less than 4 feet by 8 feet (1219 mm by 2438 mm), except at boundaries and changes in framing. Particleboard panels shall be designed to resist shear only, and chords, collector members and boundary elements shall be connected at all corners. Panel edges shall be backed with 2-inch (51 mm) nominal or wider framing. Sheets are permitted to be installed either horizontally or vertically. For  $\frac{3}{8}$ -inch (9.5 mm) particleboard sheets installed with the long dimension parallel to the studs spaced 24 inches (610 mm) o.c, nails shall be spaced at 6 inches (152 mm) o.c. along intermediate framing members. For all other conditions, nails of the same size shall be spaced at 12 inches (305 mm) o.c. along intermediate framing members. Particleboard panels less than 12 inches (305 mm) wide shall be blocked. Particleboard shall not be used to resist seismic forces in structures in Seismic Design Category D.

**TABLE 2306.4.3**

**ALLOWABLE SHEAR FOR PARTICLEBOARD SHEAR WALL SHEATHING**

**(Table 2306.4.3 attached to end of document)**

**2306.4.4 Fiberboard shear walls.** The design shear capacity of fiberboard shear walls shall be in accordance with Table 2308.9.3(4). The fiberboard sheathing shall be applied vertically or horizontally to wood studs not less than 2 inch (51 mm) nominal thickness spaced 16 inches (406 mm) o.c. Blocking not less than 2 inch (51 mm) nominal in thickness shall be provided at horizontal joints. Fiberboard shall not be used to resist seismic forces in structures in Seismic Design Category D.

**2306.4.5 Shear walls sheathed with other materials.** Shear capacities for walls sheathed with lath and plaster, and gypsum board shall be in accordance with Table 2306.4.5. Shear walls sheathed with lath, plaster and gypsum board shall be constructed in accordance with Chapter 25 and Section 2306.4.5.1. Walls resisting seismic loads shall be subject to the limitations in Section 1617.6.

**2306.4.5.1 Application of gypsum board or lath and plaster to wood framing.**

**2306.4.5.1.1 Joint staggering.** End joints of adjacent courses of gypsum board shall not occur over the same stud.

**2306.4.5.1.2 Blocking.** Where required in Table 2306.4.5, wood blocking having the same cross-sectional dimensions as the studs shall be provided at joints that are perpendicular to the studs.

**2306.4.5.1.3 Nailing.** Studs, top and bottom plates and blocking shall be nailed in accordance with Table 2304.9.1.

**2306.4.5.1.4 Fasteners.** The size and spacing of nails shall be set forth in Table 2306.4.5. Nails shall be spaced not less than  $\frac{3}{8}$  inch (9.5 mm) from edges and ends of gypsum boards or sides of studs, blocking and top and bottom plates.

**2306.4.5.1.5 Gypsum lath.** Gypsum lath shall be applied perpendicular to the studs. Maximum allowable shear values shall be as set forth in Table 2306.4.5.

**2306.4.5.1.6 Gypsum sheathing.** Four-foot-wide (1219 mm) pieces of gypsum sheathing shall be applied parallel or perpendicular to studs. Two-foot-wide (610 mm) pieces of gypsum sheathing shall be applied perpendicular to the studs. Maximum allowable shear values shall be as set forth in Table 2306.4.5.

**2306.4.5.1.7 Other gypsum boards.** Gypsum board shall be applied parallel or perpendicular to studs. Maximum allowable shear values shall be as set forth in Table 2306.4.5.

**TABLE 2306.4.5**  
**ALLOWABLE SHEAR FOR WIND OR SEISMIC FORCES FOR SHEAR**  
**WALLS OF LATH AND PLASTER OR GYPSUM BOARD WOOD FRAMED**  
**WALL ASSEMBLIES**  
**(Table 2306.4.5 attached to end of document)**

**SECTION BC 2307**  
**LOAD AND RESISTANCE FACTOR DESIGN**

**2307.1 Load and resistance factor design (LRFD).** The structural analysis and construction of wood elements and structures using load and resistance factor design (LRFD) methods shall be in accordance with ASCE 16.

**SECTION BC 2308**  
**CONVENTIONAL LIGHT-FRAME CONSTRUCTION**

**2308.1 General.** The requirements of this section are intended for conventional light-frame construction. Other methods are permitted to be used provided a satisfactory design is submitted showing compliance with other provisions of this code. Interior non-load-bearing partitions, ceilings and curtain walls of conventional light-frame

construction are not subject to the limitations of this section. Alternatively, compliance with the following standard shall be permitted subject to the limitations therein and the limitations of this code: *American Forest and Paper Association (AF&PA) Wood Frame Construction Manual for One- and Two-Family Dwellings (WCFM)*.

**2308.2 Limitations.** Buildings are permitted to be constructed in accordance with the provisions of conventional light-frame construction, subject to the following limitations, and to further limitations of Sections 2308.11 and 2308.12.

1. Buildings shall be limited to a maximum of three stories above grade. For the purposes of this section, for buildings in Seismic Design Category D as determined in Section 1616, cripple stud walls shall be considered to be a story.

**Exception:** Solid blocked cripple walls not exceeding 14 inches (356 mm) in height need not be considered a story.

2. Bearing wall floor-to-floor heights shall not exceed 10 feet (3048 mm).
3. Loads as determined in Chapter 16 shall not exceed the following:
  - 3.1. Average dead loads shall not exceed 15 psf (718 N/m<sup>2</sup>) for roofs and exterior walls, floors and partitions.
  - 3.2. Live loads shall not exceed 40 psf (1916 N/m<sup>2</sup>) for floors.
  - 3.3. Ground snow loads shall not exceed 50 psf (2395 N/m<sup>2</sup>).
4. Wind speeds shall not exceed 110 miles per hour (mph) (48.4 m/s) (3-second gust) for buildings in Exposure Category A or B.
5. Roof trusses and rafters shall not span more than 40 feet (12 192 mm) between points of vertical support.
6. The use of the provisions for conventional light-frame construction in this section shall not be permitted for buildings in Seismic Design Category B, C, or D for Seismic Use Group III, as determined in Section 1616.
7. Conventional light-frame construction is limited in irregular structures in Seismic Design Category D, as specified in Section 2308.12.6.

**2308.2.1 Basic wind speed greater than 100 mph (3-second gust).** Where the basic wind speed exceeds 100 mph (3-second gust), the provisions of either the *AF&PA Wood Frame Construction Manual for One- and Two-Family Dwellings (WCFM)*, or the *SBCCI Standard for Hurricane-Resistant Residential Construction (SSTD 10)*, are permitted to be used.

**2308.2.2 Buildings in Seismic Design Category B, C, or D.** Buildings of conventional light-frame construction in Seismic Design Category B or C, as determined in Section 1616, shall comply with the additional requirements in Section 2308.11.

**Exceptions:**

1. Detached one- and two-family dwellings in Seismic Design Category B.
2. Detached one- and two-family dwellings in Seismic Design Category C where masonry veneer is limited to the first two stories above grade.

Buildings of conventional light-frame construction in Seismic Design Category D, as determined in Section 1616, shall comply with the additional requirements in Section 2308.12.

**2308.3 Braced wall lines.** Buildings shall be provided with exterior and interior braced wall lines as described in Section 2308.9.3 and installed in accordance with Sections 2308.3.1 through 2308.3.4.

**2308.3.1 Spacing.** Spacing of braced wall lines shall not exceed 35 feet (10 668 mm) o.c. in both the longitudinal and transverse directions in each story.

**2308.3.2 Braced wall panel connections.** Forces shall be transferred from the roofs and floors to braced wall panels and from the braced wall panels in upper stories to the braced wall panels in the story below by the following:

1. Braced wall panel top and bottom plates shall be fastened to joists, rafters or full-depth blocking. Braced wall panels shall be extended and fastened to roof framing at intervals not to exceed 50 feet (15 240 mm) between parallel braced wall lines.

**Exception:** Where roof trusses are used, lateral forces shall be transferred from the roof diaphragm to the braced wall by blocking of the ends of the trusses or by other approved methods.

2. Bottom plate fastening to joist or blocking below shall be with not less than 3-16d nails at 16 inches (406 mm) o.c.
3. Blocking shall be nailed to the top plate below with not less than 3-8d toenails per block.
4. Joists parallel to the top plates shall be nailed to the top plate with not less than 8d toenails at 6 inches (152 mm) o.c.

In addition, top plate laps shall be nailed with not less than 8-16d face nails on

each side of each break in the top plate.

**2308.3.3 Sill anchorage.** Where foundations are required by Section 2308.3.4, braced wall line sills shall be anchored to concrete or masonry foundations. Such anchorage shall conform to the requirements of Section 2308.6 except that such anchors shall be spaced at not more than 4 feet (1219 mm) o.c. for structures over two stories in height. The anchors shall be distributed along the length of the braced wall line. Other anchorage devices having equivalent capacity are permitted.

**2308.3.3.1 Anchorage to all-wood foundations.** Where all-wood foundations are used, the force transfer from the braced wall lines shall be determined based on calculation and shall have a capacity greater than or equal to the connections required by Section 2308.3.3.

**2308.3.4 Braced wall line support.** Braced wall lines shall be supported by continuous foundations.

**Exception:** For structures with maximum plan dimensions not over 50 feet (15 240 mm), continuous foundations are required at exterior walls only.

**2308.4 Design of portions.** Where a building of otherwise conventional construction contains non-conventional structural elements, those elements shall be designed to resist the forces specified in Chapter 16. The extent of such design need only demonstrate compliance of non-conventional elements with other applicable provisions of this code, and shall be compatible with the performance of the conventional framed system.

**2308.5 Connections and fasteners.** Connections and fasteners used in conventional light-frame construction shall comply with the requirements of Section 2304.9.

**2308.6 Foundation plates or sills.** Foundations and footings shall be as specified in Chapter 18. Foundation plates or sills resting on concrete or masonry foundations shall comply with Section 2304.3.1. Foundation plates or sills shall be bolted or anchored to the foundation with not less than ½-inch-diameter (12.7 mm) steel bolts or approved anchors. Bolts shall be embedded at least 7 inches (178 mm) into concrete or masonry, and spaced not more than 6 feet (1829 mm) apart. There shall be a minimum of two bolts or anchor straps per piece with one bolt or anchor strap located not more than 12 inches (305 mm) or less than 4 inches (102 mm) from each end of each piece. A properly sized nut and washer shall be tightened on each bolt to the plate.

**2308.7 Girders.** Girders for single-story construction or girders supporting loads from a single floor shall not be less than 4 inches by 6 inches (102 mm by 152 mm) for spans 6 feet (1829 mm) or less, provided that girders are spaced not more than 8 feet (2438 mm) o.c. Spans for built-up 2-inch (51 mm) girders shall be in accordance with Table 2308.9.5 or 2308.9.6. Other girders shall be designed to support the loads specified in this code. Girder end joints shall occur over supports.

Where a girder is spliced over a support, an adequate tie shall be provided. The ends of beams or girders supported on masonry or concrete shall not have less than 4 inches (102 mm) of bearing.

**2308.8 Floor joists.** Spans for floor joists shall be in accordance with Table 2308.8(1) or 2308.8(2). For other grades and or species, refer to the *AF&PA Span Tables for Joists and Rafters.*

**TABLE 2308.8(1)**  
**FLOOR JOIST SPANS FOR COMMON LUMBER SPECIES**  
**(Table 2308.8 (1) attached to end of document)**

**TABLE 2308.8(2)**  
**FLOOR JOIST SPANS FOR COMMON LUMBER SPECIES**  
**(Table 2308.8 (2) attached to end of document)**

**2308.8.1 Bearing.** Except where supported on a 1-inch by 4-inch (25.4 mm by 102 mm) ribbon strip and nailed to the adjoining stud, the ends of each joist shall not have less than 1½ inches (38 mm) of bearing on wood or metal, or less than 4 inches (102 mm) on masonry.

**2308.8.2 Framing details.** Joists shall be supported laterally at the ends and at each support by solid blocking except where the ends of the joists are nailed to a header, band or rim joist or to an adjoining stud or by other means. Solid blocking shall not be less than 2 inches (51 mm) in thickness and the full depth of the joist. Notches on the ends of joists shall not exceed one-fourth the joist depth. Holes bored in joists shall not be within 2 inches (51 mm) of the top or bottom of the joist, and the diameter of any such hole shall not exceed one-third the depth of the joist. Notches in the top or bottom of joists shall not exceed one-sixth the depth and shall not be located in the middle third of the span.

Joist framing from opposite sides of a beam, girder or partition shall be lapped at least 3 inches (76 mm) or the opposing joists shall be tied together in an approved manner.

Joists framing into the side of a wood girder shall be supported by framing anchors or on ledger strips not less than 2 inches by 2 inches (51 mm by 51 mm).

**2308.8.2.1 Engineered wood products.** Cuts, notches and holes bored in trusses, laminated veneer lumber, glue-laminated members or I-joists are not permitted unless the effects of such penetrations are specifically considered in the design of the member.

**2308.8.3 Framing around openings.** Trimmer and header joists shall be doubled, or of lumber of equivalent cross section, where the span of the header exceeds 3 feet (914 mm). The ends of header joists more than 6 feet (1829 mm) long shall be



supported by framing anchors or joist hangers unless bearing on a beam, partition or wall. Tail joists over 12 feet (3658 mm) long shall be supported at the header by framing anchors or on ledger strips not less than 2 inches by 2 inches (51 mm by 51 mm).

**2308.8.4 Supporting bearing partitions.** Bearing partitions parallel to joists shall be supported on beams, girders, doubled joists, walls or other bearing partitions. Bearing partitions perpendicular to joists shall not be offset from supporting girders, walls or partitions more than the joist depth unless such joists are of sufficient size to carry the additional load.

**2308.8.5 Lateral support.** Floor, attic and roof framing with a nominal depth-to-thickness ratio greater than or equal to 5:1 shall have one edge held in line for the entire span. Where the nominal depth-to-thickness ratio of the framing member exceeds 6:1, there shall be one line of bridging for each 8 feet (2438 mm) of span, unless both edges of the member are held in line. The bridging shall consist of not less than 1-inch by 3-inch (25 mm by 76 mm) lumber, double nailed at each end, of equivalent metal bracing of equal rigidity, full-depth solid blocking or other approved means. A line of bridging shall also be required at supports where equivalent lateral support is not otherwise provided.

**2308.8.6 Structural floor sheathing.** Structural floor sheathing shall comply with the provisions of Section 2304.7.1.

**2308.8.7 Under-floor ventilation.** For under-floor ventilation, see Section 1203.3.

## **2308.9 Wall framing.**

**2308.9.1 Size, height and spacing.** The size, height and spacing of studs shall be in accordance with Table 2308.9.1 except that utility-grade studs shall not be spaced more than 16 inches (406 mm) o.c., or support more than a roof and ceiling, or exceed 8 feet (2438 mm) in height for exterior walls and load-bearing walls or 10 feet (3048 mm) for interior non-load-bearing walls.

**TABLE 2308.9.1**  
**SIZE, HEIGHT AND SPACING OF WOOD STUDS**  
**(Table 2308.9.1 attached to end of document)**

**2308.9.2 Framing details.** Studs shall be placed with their wide dimension perpendicular to the wall. Not less than three studs shall be installed at each corner of an exterior wall.

**Exception:** At corners, two studs are permitted, provided wood spacers or backup cleats of 3/8-inch-thick (9.5 mm) wood structural panel, 3/8-inch (9.5 mm) Type M “Exterior Glue” particleboard, 1-inch-thick (25 mm) lumber or other approved devices that will serve as an adequate backing for the attachment of facing

materials are used. Where fire-resistance ratings or shear values are involved, wood spacers, backup cleats or other devices shall not be used unless specifically approved for such use.

**2308.9.2.1 Top plates.** Bearing and exterior wall studs shall be capped with double top plates installed to provide overlapping at corners and at intersections with other partitions. End joints in double top plates shall be offset at least 48 inches (1219 mm), and shall be nailed with not less than eight 16d face nails on each side of the joint. Plates shall be a nominal 2 inches (51 mm) in depth and have a width at least equal to the width of the studs.

**Exception:** A single top plate is permitted, provided the plate is adequately tied at joints, corners and intersecting walls by at least the equivalent of 3-inch by 6-inch (76 mm by 152 mm) by 0.036-inch-thick (0.914 mm) galvanized steel that is nailed to each wall or segment of wall by six 8d nails or equivalent, provided the rafters, joists or trusses are centered over the studs with a tolerance of no more than 1 inch (25 mm).

**2308.9.2.2 Top plates for studs spaced at 24 inches (610 mm).** Where bearing studs are spaced at 24-inch (610 mm) intervals and top plates are less than two 2-inch by 6-inch (51 mm by 152 mm) or two 3-inch by 4-inch (76 mm by 102 mm) members and where the floor joists, floor trusses or roof trusses that they support are spaced at more than 16-inch (406 mm) intervals, such joists or trusses shall bear within 5 inches (127 mm) of the studs beneath or a third plate shall be installed.

**2308.9.2.3 Nonbearing walls and partitions.** In non-bearing walls and partitions, studs shall be spaced not more than 28 inches (711 mm) o.c. and are permitted to be set with the long dimension parallel to the wall. Interior nonbearing partitions shall be capped with no less than a single top plate installed to provide overlapping at corners and at intersections with other walls and partitions. The plate shall be continuously tied at joints by solid blocking at least 16 inches (406 mm) in length and equal in size to the plate or by ½-inch by 1½-inch (12.7 mm by 38 mm) metal ties with spliced sections fastened with two 16d nails on each side of the joint.

**2308.9.2.4 Plates or sills.** Studs shall have full bearing on a plate or sill not less than 2 inches (51 mm) in thickness having a width not less than that of the wall studs.

**2308.9.3 Bracing.** Braced wall lines shall consist of braced wall panels that meet the requirements for location, type and amount of bracing as shown in Figure 2308.9.3, specified in Table 2308.9.3(1), and are in line or offset from each other by not more than 4 feet (1219 mm). Braced wall panels shall start not more than 8 feet (2438 mm) from each end of a braced wall line. A designed collector shall be provided if the bracing begins more than 12.5 feet (3810 mm) from an end of a braced wall line.

Braced wall panels shall be clearly indicated on the plans. Construction of braced wall panels shall be by one of the following methods:

1. Nominal 1-inch by 4-inch (25 mm by 102 mm) continuous diagonal braces let into top and bottom plates and intervening studs, placed at an angle not more than 60 degrees (1.0 rad) or less than 45 degrees (0.79 rad) from the horizontal and attached to the framing in conformance with Table 2304.9.1.
2. Wood boards of  $\frac{5}{8}$ -inch (15.9 mm) net minimum thickness applied diagonally on studs spaced not over 24 inches (610 mm) o.c.
3. Wood structural panel sheathing with a thickness not less than  $\frac{5}{16}$  inch (7.9 mm) for a 16-inch (406 mm) stud spacing and not less than  $\frac{3}{8}$  inch (9.5 mm) for a 24-inch (610 mm) stud spacing in accordance with Tables 2308.9.3(2) and 2308.9.3(3).
4. Fiberboard sheathing panels not less than  $\frac{1}{2}$  inch (12.7 mm) thick applied vertically or horizontally on studs spaced not over 16 inches (406 mm) o.c. where installed with fasteners in accordance with Section 2306.4.4 and Table 2308.9.3(4).
5. Gypsum board [sheathing  $\frac{1}{2}$  inch (12.7 mm) thick by 4 feet (1219 mm) wide wallboard or veneer base] on studs spaced not over 24 inches (610 mm) o.c. and nailed at 7 inches (178 mm) o.c. with nails as required by Table 2306.4.5.
6. Particleboard wall sheathing panels where installed in accordance with Table 2308.9.3(5).
7. Portland cement plaster on studs spaced 16 inches (406 mm) o.c. installed in accordance with Section 2510.
8. Hardboard panel siding where installed in accordance with Section 2303.1.6 and Table 2308.9.3(6).

For cripple wall bracing, see Section 2308.9.4.1. For Methods 2, 3, 4, 6, 7 and 8, each panel must be at least 48 inches (1219 mm) in length, covering three stud spaces where studs are spaced 16 inches (406 mm) apart and covering two stud spaces where studs are spaced 24 inches (610 mm) apart.

For Method 5, each panel must be at least 96 inches (2438 mm) in length where applied to one face of a panel and 48 inches (1219 mm) where applied to both faces.

All vertical joints of panel sheathing shall occur over studs and adjacent panel joints shall be nailed to common framing members. Horizontal joints shall occur over blocking or other framing equal in size to the studding except where waived by the installation requirements for the specific sheathing materials.

Sole plates shall be nailed to the floor framing and top plates shall be connected to the framing above in accordance with Section 2308.3.2. Where joists are perpendicular to braced wall lines above, blocking shall be provided under and in line with the braced wall panels.

**2308.9.3.1 Alternative bracing.** Any bracing required by Section 2308.9.3 is permitted to be replaced by the following:

1. In one-story buildings, each panel shall have a length of not less than 2 feet 8 inches (813 mm) and a height of not more than 10 feet (3048 mm). Each panel shall be sheathed on one face with 3/8-inch-minimum-thickness (9.5 mm) wood structural panel sheathing nailed with 8d common or galvanized box nails in accordance with Table 2304.9.1 and blocked at wood structural panel edges. Two anchor bolts installed in accordance with Section 2308.6 shall be provided in each panel. Anchor bolts shall be placed at each panel outside quarter points. Each panel end stud shall have a tie-down device fastened to the foundation, capable of providing an approved uplift capacity of not less than 1,800 pounds (8006 N). The tie-down device shall be installed in accordance with the manufacturer's recommendations. The panels shall be supported directly on a foundation or on floor framing supported directly on a foundation that is continuous across the entire length of the braced wall line. This foundation shall be reinforced with not less than one No. 4 bar top and bottom.

Where the continuous foundation is required to have a depth greater than 12 inches (305 mm), a minimum 12-inch by 12-inch (305 mm by 305 mm) continuous footing or turned down slab edge is permitted at door openings in the braced wall line. This continuous footing or turned down slab edge shall be reinforced with not less than one No. 4 bar top and bottom. This reinforcement shall be lapped 15 inches (381 mm) with the reinforcement required in the continuous foundation located directly under the braced wall line.

2. In the first story of two-story buildings, each wall panel shall be braced in accordance with Section 2308.9.3.1, Item 1, except that the wood structural panel sheathing shall be provided on both faces, three anchor bolts shall be placed at one-quarter points, and tie-down device uplift capacity shall not be less than 3,000 pounds (13 344 N).

**FIGURE 2308.9.3**  
**BASIC COMPONENTS OF THE LATERAL BRACING SYSTEM**  
**(Figure 2308.9.3 attached to end of document)**

**TABLE 2308.9.3(1)**  
**BRACED WALL PANELS<sup>a</sup>**

(Table 2308.9.3 (1) attached to end of document)

TABLE 2308.9.3(2)

EXPOSED PLYWOOD PANEL SIDING

(Table 2308.9.3(2) attached to end of document)

TABLE 2308.9.3(3)

WOOD STRUCTURAL PANEL WALL SHEATHING<sup>b</sup>

(Table 2308.9.3 (3) attached to end of document)

TABLE 2308.9.3(4)

ALLOWABLE SHEAR VALUES (plf) FOR WIND OR SEISMIC LOADING ON  
VERTICAL DIAPHRAGMS OF FIBERBOARD SHEATHING BOARD  
CONSTRUCTION FOR TYPE V CONSTRUCTION ONLY<sup>a, b, c, d, e, f, g, h</sup>

(Table 2308.9.3 (4) attached to end of document)

TABLE 2308.9.3(5)

ALLOWABLE SPANS FOR PARTICLEBOARD WALL SHEATHING

(Table 2308.9.3(5) attached to end of document)

TABLE 2308.9.3(6)

HARDBOARD SIDING

(Table 2308.9.3 (6) attached to end of document)

**2308.9.4 Cripple walls.** Foundation cripple walls shall be framed of studs not less in size than the studding above with a minimum length of 14 inches (356 mm), or shall be framed of solid blocking. Where exceeding 4 feet (1219 mm) in height, such walls shall be framed of studs having the size required for an additional story.

**2308.9.4.1 Bracing.** For the purposes of this section, cripple walls having a stud height exceeding 14 inches (356 mm) shall be considered a story and shall be braced in accordance with Table 2308.9.3(1) for Seismic Design Category B or C. See Section 2308.12.4 for Seismic Design Category D.

**2308.9.4.2 Nailing of bracing.** Spacing of edge nailing for required wall bracing shall not exceed 6 inches (152 mm) o.c. along the foundation plate and the top plate of the cripple wall. Nail size, nail spacing for field nailing and more restrictive boundary nailing requirements shall be as required elsewhere in the code for the specific bracing material used.

**2308.9.5 Openings in exterior walls.**

**2308.9.5.1 Headers.** Headers shall be provided over each opening in exterior-bearing walls. The spans in Table 2308.9.5 are permitted to be used for one- and two-family dwellings. Headers for other buildings shall be designed in accordance with Section 2301.2.1 or 2301.2.2. Headers shall be of two pieces of nominal 2-

inch (51 mm) framing lumber set on edge as permitted by Table 2308.9.5 and nailed together in accordance with Table 2304.9.1 or of solid lumber of equivalent size.

**2308.9.5.2 Header support.** Wall studs shall support the ends of the header in accordance with Table 2308.9.5. Each end of a lintel or header shall have a length of bearing of not less than 1½ inches (38 mm) for the full width of the lintel.

**TABLE 2308.9.5**  
**HEADER AND GIRDER SPANS<sup>a</sup> FOR EXTERIOR BEARING WALLS**  
**(Table 2308.9.5 attached to end of document)**

**2308.9.6 Openings in interior bearing partitions.** Headers shall be provided over each opening in interior bearing partitions as required in Section 2308.9.5. The spans in Table 2308.9.6 are permitted to be used for one- and two-family dwellings. Wall studs shall support the ends of the header in accordance with Table 2308.9.5 or 2308.9.6 as appropriate.

**TABLE 2308.9.6**  
**HEADER AND GIRDER SPANS<sup>a</sup> FOR INTERIOR BEARING WALLS**  
**(Table 2308.9.6 attached to end of document)**

**2308.9.7 Openings in interior nonbearing partitions.** Openings in nonbearing partitions are permitted to be framed with single studs and headers. Each end of a lintel or header shall have a length of bearing of not less than 1½ inches (38 mm) for the full width of the lintel.

**2308.9.8 Pipes in walls.** Stud partitions containing plumbing, heating or other pipes shall be so framed and the joists underneath so spaced as to give proper clearance for the piping. Where a partition containing such piping runs parallel to the floor joists, the joists underneath such partitions shall be doubled and spaced to permit the passage of such pipes and shall be bridged. Where plumbing, heating or other pipes are placed in or partly in a partition, necessitating the cutting of the soles or plates, a metal tie not less than 0.058 inch (1.47 mm) (16 galvanized gage) and 1½ inches (38 mm) wide shall be fastened to each plate across and to each side of the opening with not less than six 16d nails.

**2308.9.9 Bridging.** Unless covered by interior or exterior wall coverings or sheathing meeting the minimum requirements of this code, stud partitions or walls with studs having a height-to-least-thickness ratio exceeding 50 shall have bridging not less than 2 inches (51 mm) in thickness and of the same width as the studs fitted snugly and nailed thereto to provide adequate lateral support. Bridging shall be placed in every stud cavity and at a frequency such that no stud so braced shall have a height-to-least-thickness ratio exceeding 50 with the height of the stud measured between horizontal framing and bridging or between bridging, whichever is greater.

**2308.9.10 Cutting and notching.** In exterior walls and bearing partitions, any wood stud is permitted to be cut or notched to a depth not exceeding 25 percent of its width. Cutting or notching of studs to a depth not greater than 40 percent of the width of the stud is permitted in nonbearing partitions supporting no loads other than the weight of the partition.

**2308.9.11 Bored holes.** A hole not greater in diameter than 40 percent of the stud width is permitted to be bored in any wood stud. Bored holes not greater than 60 percent of the width of the stud are permitted in nonbearing partitions or in any wall where each bored stud is doubled, provided not more than two such successive doubled studs are so bored.

In no case shall the edge of the bored hole be nearer than  $\frac{5}{8}$  inch (15.9 mm) to the edge of the stud.

Bored holes shall not be located at the same section of stud as a cut or notch.

**2308.10 Roof and ceiling framing.** The framing details required in this section apply to roofs having a minimum slope of three units vertical in 12 units horizontal (25-percent slope) or greater. Where the roof slope is less than three units vertical in 12 units horizontal (25-percent slope), members supporting rafters and ceiling joists such as ridge board, hips and valleys shall be designed as beams.

**2308.10.1 Wind uplift.** Roof assemblies shall have rafter and truss ties to the wall below. Resultant uplift loads shall be transferred to the foundation using a continuous load path. The rafter or truss to wall connection shall comply with Tables 2304.9.1 and 2308.10.1.

**TABLE 2308.10.1**  
**REQUIRED RATING OF APPROVED UPLIFT CONNECTORS (pounds)<sup>a,b,c,e,f,g,h</sup>**  
**(Table 2308.10.1 attached to end of document)**

**2308.10.2 Ceiling joist spans.** Allowable spans for ceiling joists shall be in accordance with Table 2308.10.2(1) or 2308.10.2(2). For other grades and species, refer to the *AF&PA Span Tables for Joists and Rafters*.

**TABLE 2308.10.2(1)**  
**CEILING JOIST SPANS FOR COMMON LUMBER SPECIES**  
**(Table 2308.10.2(1) attached to end of document)**

**TABLE 2308.10.2(2)**  
**CEILING JOIST SPANS FOR COMMON LUMBER SPECIES**  
**(Table 2308.10.2(2) attached to end of document)**

**2308.10.3 Rafter spans.** Allowable spans for rafters shall be in accordance with Table 2308.10.3(1), 2308.10.3(2), 2308.10.3(3), 2308.10.3(4), 2308.10.3(5) or

2308.10.3(6). For other grades and species, refer to the *AF&PA Span Tables for Joists and Rafters*.

**TABLE 2308.10.3(1)**  
**RAFTER SPANS FOR COMMON LUMBER SPECIES**  
**(Table 2308.10.3(1) attached to end of document)**

**TABLE 2308.10.3(2)**  
**RAFTER SPANS FOR COMMON LUMBER SPECIES**  
**(Table 2308.10.3(2) attached to end of document)**

**TABLE 2308.10.3(3)**  
**RAFTER SPANS FOR COMMON LUMBER SPECIES**  
**(Table 2308.10.3(3) attached to end of document)**

**TABLE 2308.10.3(4)**  
**RAFTER SPANS FOR COMMON LUMBER SPECIES**  
**(Table 2308.10.3(4) attached to end of document)**

**TABLE 2308.10.3(5)**  
**RAFTER SPANS FOR COMMON LUMBER SPECIES**  
**(Table 2308.10.3(5) attached to end of document)**

**TABLE 2308.10.3(6)**  
**RAFTER SPANS FOR COMMON LUMBER SPECIES**  
**(Table 2308.10.3(6) attached to end of document)**

**2308.10.4 Ceiling joist and rafter framing.** Rafters shall be framed directly opposite each other at the ridge. There shall be a ridge board at least 1-inch (25 mm) nominal thickness at ridges and not less in depth than the cut end of the rafter. At valleys and hips, there shall be a single valley or hip rafter not less than 2-inch (51 mm) nominal thickness and not less in depth than the cut end of the rafter.

**2308.10.4.1 Ceiling joist and rafter connections.** Ceilings joists and rafters shall be nailed to each other and the assembly shall be nailed to the top wall plate in accordance with Tables 2304.9.1 and 2308.10.1. Ceiling joists shall be continuous or securely joined where they meet over interior partitions and fastened to adjacent rafters in accordance with Tables 2308.10.4.1 and 2304.9.1 to provide a continuous rafter tie across the building where such joists are parallel to the rafters. Ceiling joists shall have a bearing surface of not less than 1½ inches (38 mm) on the top plate at each end.

Where ceiling joists are not parallel to rafters, an equivalent rafter tie shall be installed in a manner to provide a continuous tie across the building, at a spacing of not more than 4 feet (1219 mm) o.c. The connections shall be in accordance with Tables 2308.10.4.1 and 2304.9.1, or connections of equivalent capacities



shall be provided. Where ceiling joists or rafter ties are not provided at the top of the rafter support walls, the ridge formed by these rafters shall also be supported by a girder conforming to Section 2308.4.

Rafter ties shall be spaced not more than 4 feet (1219 mm) o.c. Rafter tie connections shall be based on the equivalent rafter spacing in Table 2308.10.4.1. Where rafter ties are spaced at 32 inches (813 mm) o.c., the number of 16d common nails shall be two times the number specified for rafters spaced 16 inches (406 mm) o.c., with a minimum of 4-16d common nails where no snow loads are indicated. Where rafter ties are spaced at 48 inches (1219 mm) o.c., the number of 16d common nails shall be two times the number specified for rafters spaced 24 inches (610 mm) o.c., with a minimum of 6-16d common nails where no snow loads are indicated. Rafter/ceiling joist connections and rafter/tie connections shall be of sufficient size and number to prevent splitting from nailing.

**TABLE 2308.10.4.1**  
**RAFTER TIE CONNECTIONS<sup>g</sup>**  
**(Table 2308.10.4.1 attached to end of document)**

**2308.10.4.2 Notches and holes.** Notching at the ends of rafters or ceiling joists shall not exceed one-fourth the depth. Notches in the top or bottom of the rafter or ceiling joist shall not exceed one-sixth the depth and shall not be located in the middle one-third of the span, except that a notch not exceeding one-third of the depth is permitted in the top of the rafter or ceiling joist not further from the face of the support than the depth of the member.

Holes bored in rafters or ceiling joists shall not be within 2 inches (51 mm) of the top and bottom and their diameter shall not exceed one-third the depth of the member.

**2308.10.4.3 Framing around openings.** Trimmer and header rafters shall be doubled, or of lumber of equivalent cross section, where the span of the header exceeds 4 feet (1219 mm). The ends of header rafters more than 6 feet (1829 mm) long shall be supported by framing anchors or rafter hangers unless bearing on a beam, partition or wall.

**2308.10.5 Purlins.** Purlins to support roof loads are permitted to be installed to reduce the span of rafters within allowable limits and shall be supported by struts to bearing walls. The maximum span of 2-inch by 4-inch (51 mm by 102 mm) purlins shall be 4 feet (1219 mm). The maximum span of the 2-inch by 6-inch (51 mm by 152 mm) purlin shall be 6 feet (1829 mm), but in no case shall the purlin be smaller than the supported rafter. Struts shall not be smaller than 2-inch by 4-inch (51 mm by 102 mm) members. The unbraced length of struts shall not exceed 8 feet (2438 mm) and the minimum slope of the struts shall not be less than 45 degrees (0.79 rad) from the horizontal.

**2308.10.6 Blocking.** Roof rafters and ceiling joists shall be supported laterally to prevent rotation and lateral displacement in accordance with the provisions of Section 2308.8.5.

**2308.10.7 Wood trusses.**

**2308.10.7.1 Design.** Wood trusses shall be designed in accordance with the requirements of this chapter and accepted engineering practice. Members are permitted to be joined by nails, glue, bolts, timber connectors, metal connector plates or other approved framing devices.

**2308.10.7.2 Bracing.** The bracing of wood trusses shall comply with their appropriate engineered design.

**2308.10.7.3 Alterations to trusses.** Truss members and components shall not be cut, notched, drilled, spliced or otherwise altered in any way without written concurrence and approval of a registered design professional. Alterations resulting in the addition of loads to any member (e.g., HVAC equipment, water heater) shall not be permitted without verification that the truss is capable of supporting such additional loading.

**2308.10.8 Roof sheathing.** Roof sheathing shall be in accordance with Tables 2304.7(3) and 2304.7(5) for wood structural panels, and Tables 2304.7(1) and 2304.7(2) for lumber and shall comply with Section 2304.7.2.

**2308.10.8.1 Joints.** Joints in lumber sheathing shall occur over supports unless approved end-matched lumber is used, in which case each piece shall bear on at least two supports.

**2308.10.9 Roof planking.** Planking shall be designed in accordance with the general provisions of this code. In lieu of such design, 2-inch (51 mm) tongue-and groove planking is permitted in accordance with Table 2308.10.9. Joints in such planking are permitted to be randomly spaced, provided the system is applied to not less than three continuous spans, planks are center matched and end matched or splined, each plank bears on at least one support, and joints are separated by at least 24 inches (610 mm) in adjacent pieces.

**TABLE 2308.10.9**

**ALLOWABLE SPANS FOR 2-INCH TONGUE-AND-GROOVE DECKING**

**(Table 2308.10.9 attached to end of document)**

**2308.10.10 Attic ventilation.** For attic ventilation, see Section 1203.2.

**2308.11 Additional requirements for conventional light-frame construction in Seismic Design Category B or C.** Structures of conventional light-frame construction in

Seismic Design Category B or C, as determined in Section 1616, shall comply with Sections 2308.11.1 through 2308.11.3, in addition to the provisions of Sections 2308.1 through 2308.10.

**2308.11.1 Number of stories.** Structures of conventional light-frame construction shall not exceed two stories in height in Seismic Design Category C.

**Exception:** Detached one- and two-family dwellings are permitted to be three stories in height in Seismic Design Category C.

**2308.11.2 Concrete or masonry.** Concrete or masonry walls, or masonry veneer shall not extend above the basement.

**Exceptions:**

1. Masonry veneer is permitted to be used in the first two stories above grade or the first three stories above grade where the lowest story has concrete or masonry walls in Seismic Design Category B, provided that structural use panel wall bracing is used, and the length of bracing provided is 1.5 times the required length as determined in Table 2308.9.3(1).
2. Masonry veneer is permitted to be used in the first story above grade or the first two stories above grade where the lowest story has concrete or masonry walls in Seismic Design Category B or C.
3. Masonry veneer is permitted to be used in the first two stories above grade in Seismic Design Categories Band C provided the following criteria are met:
  - 3.1. Type of brace per Section 2308.9.3 shall be Method 3 and the allowable shear capacity in accordance with Table 2306.4.1 shall be a minimum of 350 plf (5108 N/m) (ASD).
  - 3.2. The bracing of the top story shall be located at each end and at least every 25 feet (7620 mm) o.c. but not less than 40 percent of the braced wall line. The bracing of the first story shall be located at each end and at least every 25 feet (7620 mm) o.c. but not less than 35 percent of the braced wall line.
  - 3.3. Hold-down connectors shall be provided at the ends of braced walls for the second floor to first floor wall assembly with an allowable design of 2,000 pounds (907.0 kg). Hold-down connectors shall be provided at the ends of each wall segment of the braced walls for the first floor to foundation with an allowable design of 3,900 pounds (1768 kg). In all cases, the hold-down connector force shall be transferred to the foundation.

3.4. Cripple walls shall not be permitted.

**2308.11.3 Framing and connection details.** Framing and connection details shall conform to Sections 2308.11.3.1 through 2308.11.3.3.

**2308.11.3.1 Anchorage.** Braced wall lines shall be anchored in accordance with Section 2308.6 at foundations.

**2308.11.3.2 Stepped footings.** Where the height of a required braced wall panel extending from foundation to floor above varies more than 4 feet (1219 mm), the following construction shall be used:

1. Where the bottom of the footing is stepped and the lowest floor framing rests directly on a sill bolted to the footings, the sill shall be anchored as required in Section 2308.3.3.
2. Where the lowest floor framing rests directly on a sill bolted to a footing not less than 8 feet (2438 mm) in length along a line of bracing, the line shall be considered to be braced. The double plate of the cripple stud wall beyond the segment of footing extending to the lowest framed floor shall be spliced to the sill plate with metal ties, one on each side of the sill and plate. The metal ties shall not be less than 0.058 inch [1.47 mm (16 galvanized gage)] by 1.5 inches (38 mm) wide by 48 inches (1219 mm) with eight 16d common nails on each side of the splice location (see Figure 2308.11.3.2). The metal tie shall have a minimum yield of 33,000 pounds per square inch (psi) (227 Mpa).
3. Where cripple walls occur between the top of the footing and the lowest floor framing, the bracing requirements for a story shall apply.

**FIGURE 2308.11.3.2**  
**STEPPED FOOTING CONNECTION DETAILS**  
**(Figure 2308.11.3.2 attached to end of document)**

**2308.11.3.3 Openings in horizontal diaphragms.** Openings in horizontal diaphragms with a dimension perpendicular to the joist that is greater than 4 feet (1.2 m) shall be constructed in accordance with the following:

1. Blocking shall be provided beyond headers.
2. Metal ties not less than 0.058 inch [1.47 mm (16 galvanized gage)] by 1.5 inches (38 mm) wide with eight 16d common nails on each side of the header-joist intersection shall be provided (see Figure 2308.11.3.3). The metal ties shall have a minimum yield of 33,000 psi (227 Mpa).

**FIGURE 2308.11.3.3**  
**OPENINGS IN HORIZONTAL DIAPHRAGMS**  
**(Figure 2308.11.3.3 attached to end of document)**

**2308.12 Additional requirements for conventional light-frame construction in Seismic Design Category D.** Structures of conventional light-frame construction in Seismic Design Category D, as determined in Section 1616, shall conform to Sections 2308.12.1 through 2308.12.8, in addition to the requirements for Seismic Design Category B or C in Section 2308.11.

**2308.12.1 Number of stories.** Structures of conventional light-frame construction shall not exceed one story in height in Seismic Design Category D.

**Exception:** Detached one- and two-family dwellings are permitted to be two stories high in Seismic Design Category D.

**2308.12.2 Concrete or masonry.** Concrete or masonry walls, or masonry veneer shall not extend above the basement.

**Exception:** Masonry veneer is permitted to be used in the first story above grade in Seismic Design Category D provided the following criteria are met:

- 1. Type of brace in accordance with Section 2308.9.3 shall be Method 3 and the allowable shear capacity in accordance with Table 2306.4.1 shall be a minimum of 350 plf (5108 N/m) (ASD).**
- 2. The bracing of the first story shall be located at each end and at least every 25 feet (7620 mm) o.c. but not less than 45 percent of the braced wall line.**
- 3. Hold-down connectors shall be provided at the ends of braced walls for the first floor to foundation with an allowable design of 2,100 pounds (1768 kg).**
- 4. Cripple walls shall not be permitted.**

**2308.12.3 Braced wall line spacing.** Spacing between interior and exterior braced wall lines shall not exceed 25 feet (7620 mm).

**2308.12.4 Braced wall line sheathing.** Braced wall lines shall be braced by one of the types of sheathing prescribed by Table 2308.12.4 as shown in Figure 2308.9.3. The sum of lengths of braced wall panels at each braced wall line shall conform to Table 2308.12.4. Braced wall panels shall be distributed along the length of the braced wall line and start at not more than 8 feet (2438 mm) from each end of the braced wall line. A designed collector shall be provided where the bracing begins more than 8 feet (2438 mm) from each end of a braced wall line. Panel sheathing joints shall occur over studs or blocking. Sheathing shall be fastened to studs and top

and bottom plates and at panel edges occurring over blocking. Wall framing to which sheathing used for bracing is applied shall be nominal 2 inch wide (actual 1½ inch, 38 mm) or larger members.

Cripple walls having a stud height exceeding 14 inches (356 mm) shall be considered a story for the purpose of this section and shall be braced as required for braced wall lines in accordance with Table 2308.12.4. Where interior braced wall lines occur without a continuous foundation below, the length of parallel exterior cripple wall bracing shall be one and one-half times the lengths required by Table 2308.12.4. Where the cripple wall sheathing type used is Type S-W, and this additional length of bracing cannot be provided, the capacity of Type S-W sheathing shall be increased by reducing the spacing of fasteners along the perimeter of each piece of sheathing to 4 inches (102 mm) o.c.

**TABLE 2308.12.4**  
**WALL BRACING IN SEISMIC DESIGN CATEGORIES D AND E**  
**(Table 2308.12.4 attached to end of document)**

**2308.12.5 Attachment of sheathing.** Fastening of braced wall panel sheathing shall not be less than that prescribed in Table 2308.12.4 or 2304.9.1. Wall sheathing shall not be attached to framing members by adhesives.

**2308.12.6 Irregular structures.** Conventional light-frame construction shall not be used in irregular portions of structures in Seismic Design Category D. Such irregular portions of structures shall be designed to resist the forces specified in Chapter 16 to the extent such irregular features affect the performance of the conventional framing system. A portion of a structure shall be considered to be irregular where at least one of the conditions described in Items 1 through 6 below is present.

1. Where exterior braced wall panels are not in one plane vertically from the foundation to the uppermost story in which they are required, the structure shall be considered to be irregular [see Figure 2308.12.6(1)].

**Exception:** Floors with cantilevers or setbacks not exceeding four times the nominal depth of the floor joists [see Figure 2308.12.6(2)] are permitted to support braced wall panels provided:

1. Floor joists are 2 inches by 10 inches (51 mm by 254 mm) or larger and spaced not more than 16 inches (406 mm) o.c.
2. The ratio of the back span to the cantilever is at least 2:1.
3. Floor joists at ends of braced wall panels are doubled.
4. A continuous rim joist is connected to the ends of cantilevered joists. The rim joist is permitted to be spliced using a metal tie not

less than 0.058 inch (1.47 mm) (16 galvanized gage) and 1½ inches (38 mm) wide fastened with six 16d common nails on each side. The metal tie shall have a minimum yield of 33,000 psi (227 Mpa).

5. Joists at setbacks or the end of cantilevered joists shall not carry gravity loads from more than a single story having uniform wall and roof loads, nor carry the reactions from headers having a span of 8 feet (2438 mm) or more.
2. Where a section of floor or roof is not laterally supported by braced wall lines on all edges, the structure shall be considered to be irregular [see Figure 2308.12.6(3)].

**Exception:** Portions of roofs or floors that do not support braced wall panels above are permitted to extend up to 6 feet (1829 mm) beyond a braced wall line [see Figure 2308.12.6(4)].

3. Where the end of a required braced wall panel extends more than 1 foot (305 mm) over an opening in the wall below, the structure shall be considered to be irregular. This requirement is applicable to braced wall panels offset in plane and to braced wall panels offset out of plane as permitted by the exception to Item 1 above in this section [see Figure 2308.12.6(5)].

**Exception:** Braced wall panels are permitted to extend over an opening not more than 8 feet (2438 mm) in width where the header is a 4-inch by 12-inch (102 mm by 305 mm) or larger member.

4. Where portions of a floor level are vertically offset such that the framing members on either side of the offset cannot be lapped or tied together in an approved manner, the structure shall be considered to be irregular [see Figure 2308.12.6(6)].

**Exception:** Framing supported directly by foundations need not be lapped or tied directly together.

5. Where braced wall lines are not perpendicular to each other, the structure shall be considered to be irregular [see Figure 2308.12.6(7)].
6. Where openings in floor and roof diaphragms having a maximum dimension greater than 50 percent of the distance between lines of bracing or an area greater than 25 percent of the area between orthogonal pairs of braced wall lines are present, the structure shall be considered to be irregular [see Figure 2308.12.6(8)].

**FIGURE 2308.12.6(1)**

**BRACED WALL PANELS OUT OF PLANE**  
**(Figure 2308.12.6 (1) attached to end of document)**

**FIGURE 2308.12.6(2)**  
**BRACED WALL PANELS SUPPORTED BY CANTILEVER OR SET BACK**  
**(Figure 2308.12.6(2) attached to end of document)**

**FIGURE 2308.12.6(3)**  
**FLOOR OR ROOF NOT SUPPORTED ON ALL EDGES**  
**(Figure 2308.12.6(3) attached to end of document)**

**FIGURE 2308.12.6(4)**  
**ROOF OR FLOOR EXTENSION BEYOND BRACED WALL LINE**  
**(Figure 2308.12.6(4) attached to end of document)**

**FIGURE 2308.12.6(5)**  
**BRACED WALL PANEL EXTENSION OVER OPENING**  
**(Figure 2308.12.6(5) attached to end of document)**

**FIGURE 2308.12.6(6)**  
**PORTIONS OF FLOOR LEVEL OFFSET VERTICALLY**  
**(Figure 2308.12.6(6) attached to end of document)**

**FIGURE 2308.12.6(7)**  
**BRACED WALL LINES NOT PERPENDICULAR**  
**(Figure 2308.12.6(7) attached to end of document)**

**FIGURE 2308.12.6(8)**  
**OPENING LIMITATIONS FOR FLOOR AND ROOF DIAPHRAGMS**  
**(Figure 2308.12.6(8) attached to end of document)**

**2308.12.7 Exit facilities.** Exterior exit balconies, stairs and similar exit facilities shall be positively anchored to the primary structure at not over 8 feet (2438 mm) o.c. or shall be designed for lateral forces. Such attachment shall not be accomplished by use of toenails or nails subject to withdrawal.

**2308.12.8 Steel plate washers.** Steel plate washers shall be placed between the foundation sill plate and the nut. Such washers shall be a minimum of  $\frac{3}{16}$  inch by 2 inches by 2 inches (4.76 mm by 51 mm by 51 mm) in size.



$$\Delta = \frac{5vL^3}{8EAb} + \frac{vL}{4Gt} + 0.188Le_n + \frac{\Sigma(\Delta_c X)}{2b} \quad (\text{Equation 23-1})$$

$$\text{For SI: } \Delta = \frac{0.052L^3}{EAb} + \frac{vL}{4Gt} + \frac{Le_n}{1627} + \frac{\Sigma(\Delta_c X)}{2b}$$

where:

- $A$  = Area of chord cross section, in square inches (mm<sup>2</sup>).
- $b$  = Diaphragm width, in feet (mm).
- $E$  = Elastic modulus of chords, in pounds per square inch (N/mm<sup>2</sup>).
- $e_n$  = Nail deformation, in inches (mm).
- $G$  = Modulus of rigidity of wood structural panel, in pounds per square inch (N/mm<sup>2</sup>).
- $L$  = Diaphragm length, in feet (mm).
- $t$  = Effective thickness of wood structural panel for shear, in inches (mm).
- $v$  = Maximum shear due to design loads in the direction under consideration, in pounds per linear foot (plf) (N/mm).
- $\Delta$  = The calculated deflection, in inches (mm).
- $\Sigma(\Delta_c X)$  = Sum of individual chord-splice values on both sides of the diaphragm, each multiplied by its distance to the nearest support.

$$\Delta = \frac{8vh^3}{EAb} + \frac{vh}{Gt} + 0.75he_n + d_a \quad (\text{Equation 23-2})$$

$$\text{For SI: } \Delta = \frac{vh^3}{3EAb} + \frac{vh}{Gt} + \frac{he_n}{406.7} + d_a$$

where:

- $A$  = Area of boundary element cross section in square inches (mm<sup>2</sup>) (vertical member at shear wall boundary).
- $b$  = Wall width, in feet (mm).
- $d_a$  = Deflection due to anchorage details (rotation and slip at tie-down bolts).
- $E$  = Elastic modulus of boundary element (vertical member at shear wall boundary), in pounds per square inch (N/mm<sup>2</sup>).
- $e_n$  = Deformation of mechanically fastened connections, in inches (mm<sup>2</sup>).
- $G$  = Modulus of rigidity of wood structural panel, in pounds per square inch (N/mm<sup>2</sup>).
- $h$  = Wall height, in feet (mm).
- $t$  = Effective thickness of wood structural panel for shear, in inches (mm).
- $v$  = Maximum shear due to design loads at the top of the wall, in pounds per linear foot (N/mm).
- $\Delta$  = The calculated deflection, in inches (mm).

$$T = \frac{Vh}{C_o \Sigma L_i} \quad \text{(Equation 23-3)}$$

where:

$T$  = Tension chord uplift force, pounds (N).

$V$  = Shear force in perforated shear wall, pounds (N).

$h$  = Shear wall height, feet (mm).

$C_o$  = Shear resistance adjustment factor from Table 2305.3.7.2.

$\Sigma L_i$  = Sum of widths of perforated shear wall segments, feet (mm).

$$v = \frac{V}{C_o \Sigma L_i} \quad \text{(Equation 23-4)}$$

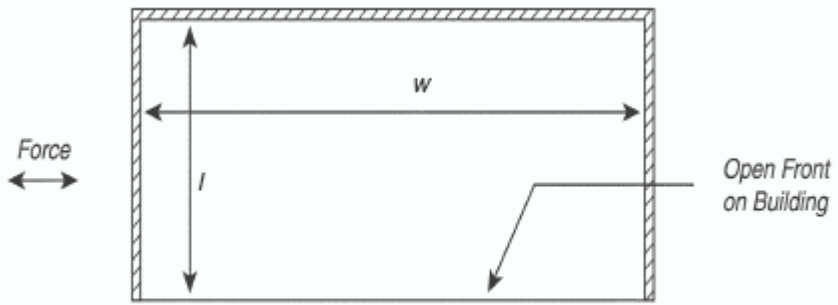
where:

$v$  = Unit shear force, pounds per lineal feet (N/m).

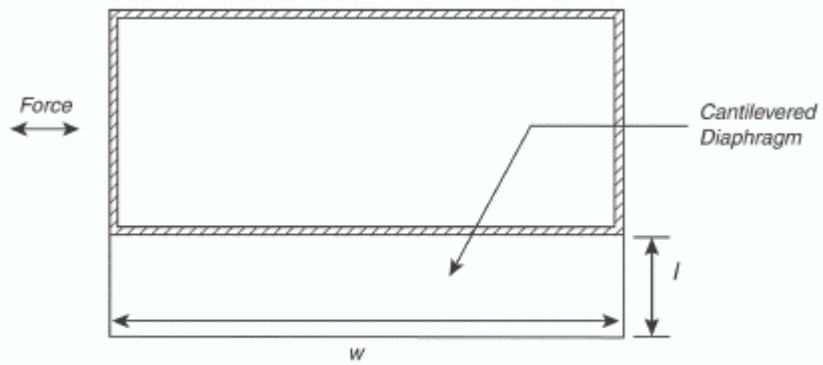
$V$  = Shear force in perforated shear wall, pounds (N).

$C_o$  = Shear resistance adjustment factor from Table 2305.3.7.2.

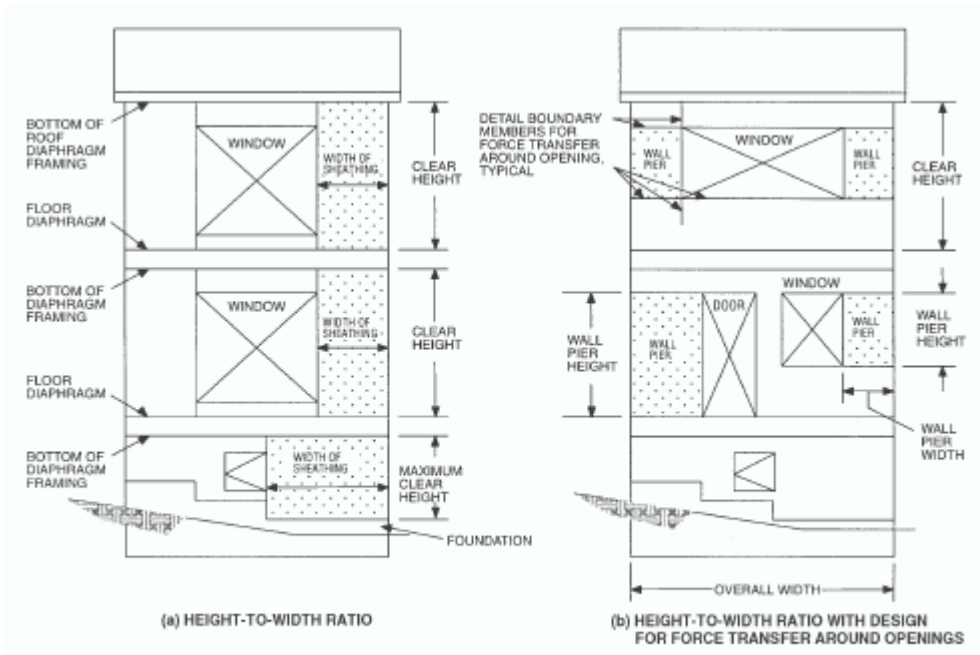
$\Sigma L_i$  = Sum of widths of perforated shear wall segments, feet (mm).



**FIGURE 2305.2.5(1)**  
**DIAPHRAGM LENGTH AND WIDTH FOR PLAN VIEW OF OPEN FRONT BUILDING**

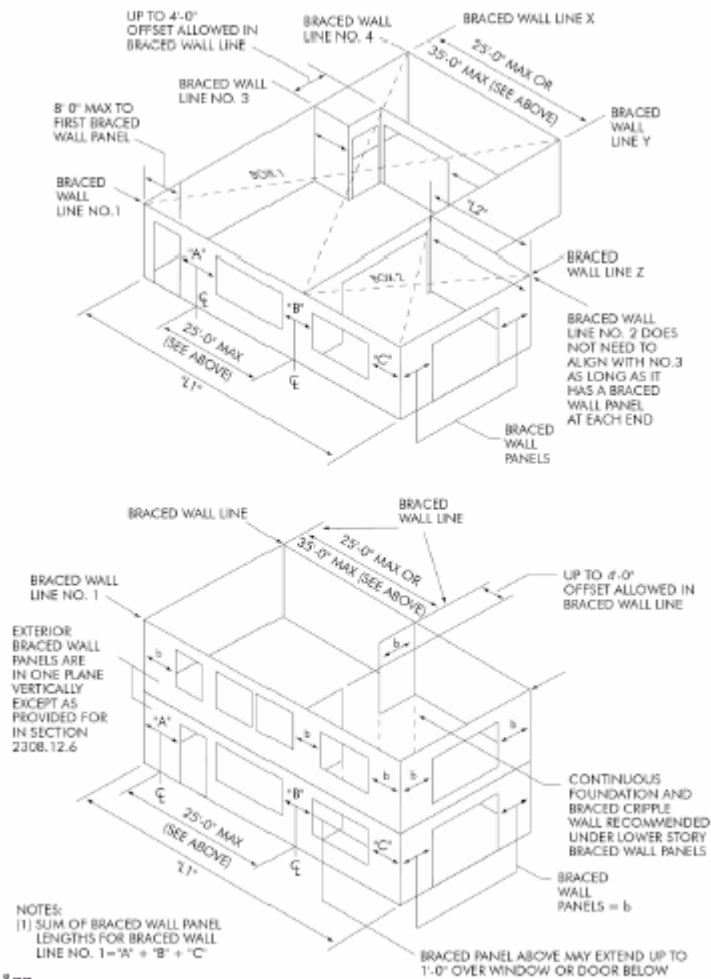


**FIGURE 2305.2.5(2)**  
**DIAPHRAGM LENGTH AND WIDTH FOR PLAN VIEW OF CANTILEVERED DIAPHRAGM**



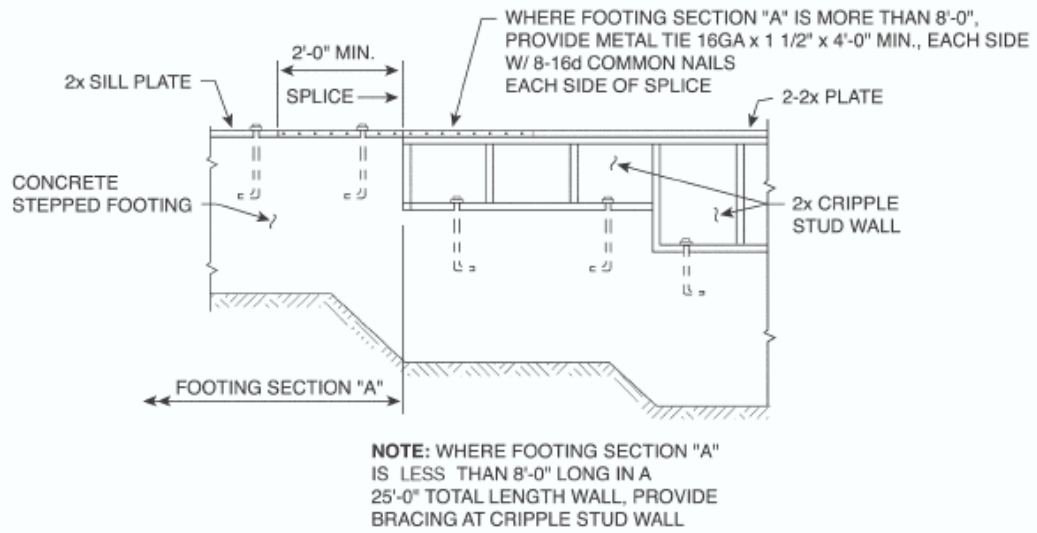
**FIGURE 2305.3.4**  
**GENERAL DEFINITION OF SHEAR WALL HEIGHT, WIDTH AND HEIGHT-TO-WIDTH RATIO**

SEISMIC DESIGN CATEGORY	MAXIMUM WALL SPACING (feet)	REQUIRED BRACING LENGTH, b
B, and C	35'-0"	Table 2308.9.3(1) and Section 2308.9.3
D and E	25'-0"	Table 2308.12.4



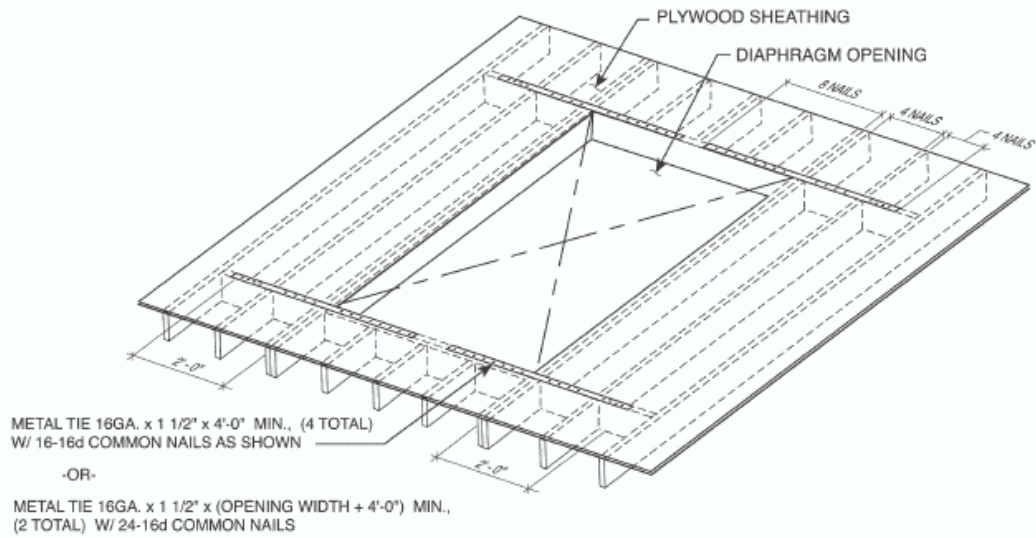
For SI: 1 ft = 304.8 mm

FIGURE 2308.9.3  
 BASIC COMPONENTS OF THE LATERAL BRACING SYSTEM



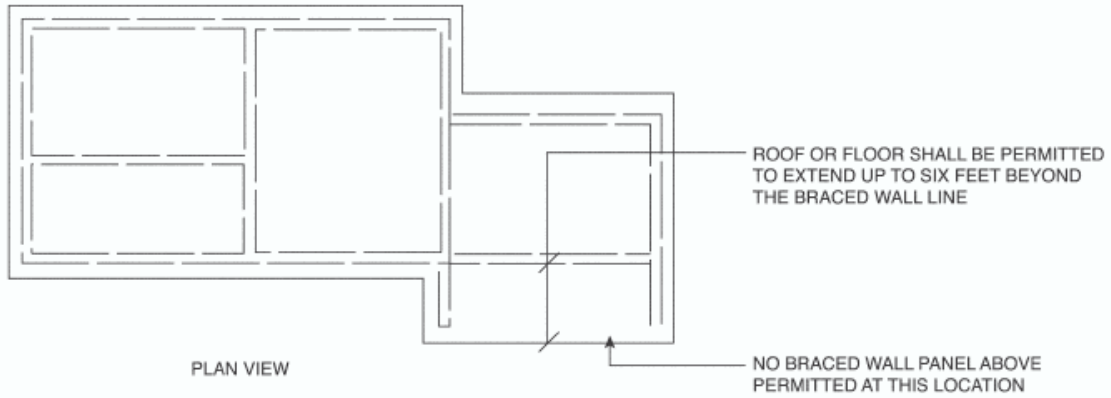
For SI: 1 inch = 25.4 mm, 1 foot = 304.8 mm.

**FIGURE 2308.11.3.2**  
**STEPPED FOOTING CONNECTION DETAILS**

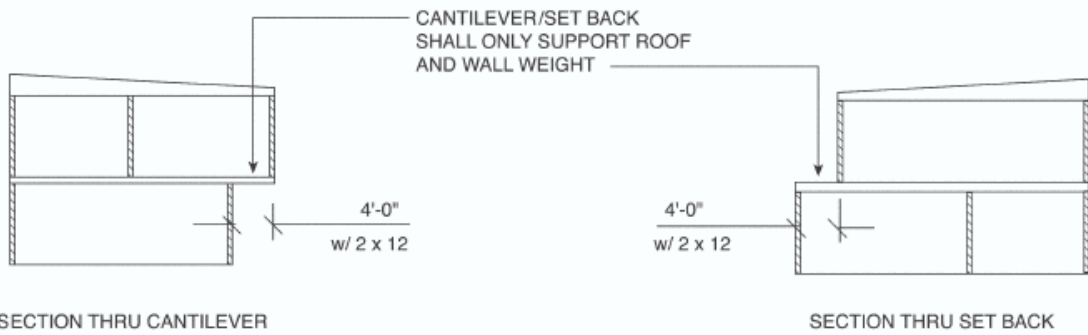


For SI: 1 inch = 25.4 mm, 1 foot = 304.8 mm.

**FIGURE 2308.11.3.3**  
**OPENINGS IN HORIZONTAL DIAPHRAGMS**

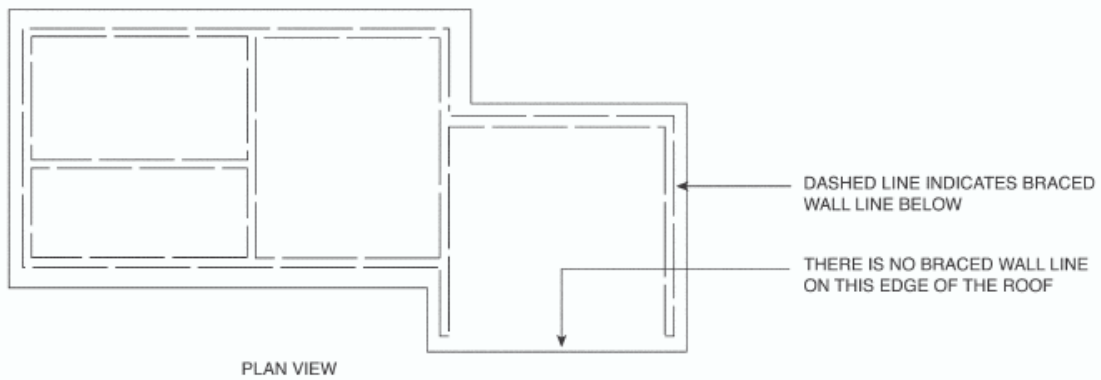


**FIGURE 2308.12.6(1)  
BRACED WALL PANELS OUT OF PLANE**

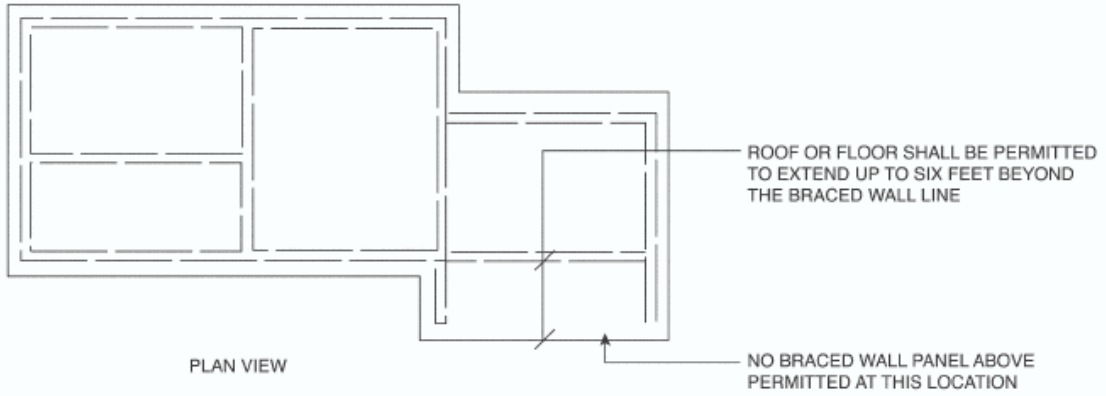


For SI: 1 foot = 304.8 mm.

**FIGURE 2308.12.6(2)  
BRACED WALL PANELS SUPPORTED BY CANTILEVER OR SET BACK**

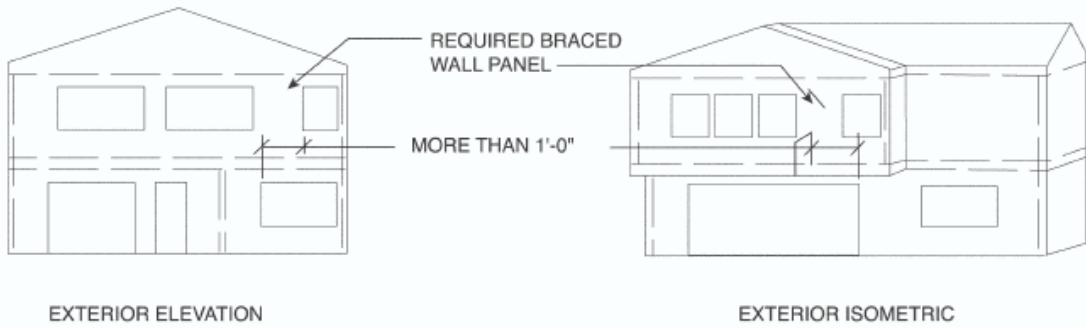


**FIGURE 2308.12.6(3)  
FLOOR OR ROOF NOT SUPPORTED ON ALL EDGES**



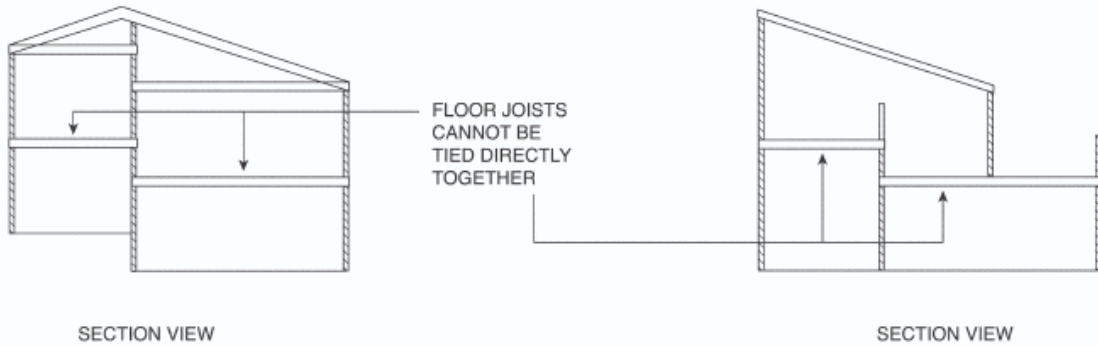
For SI: 1 foot = 304.8 mm.

**FIGURE 2308.12.6(4)  
ROOF OR FLOOR EXTENSION BEYOND BRACED WALL LINE**



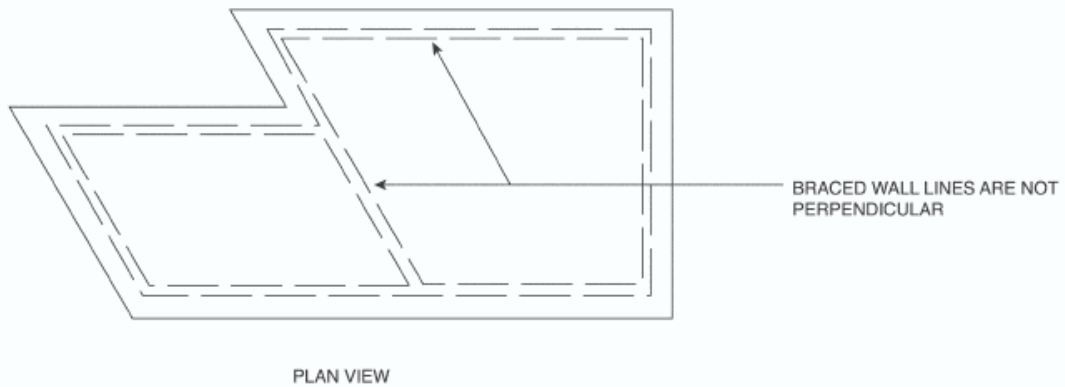
For SI: 1 foot = 304.8 mm.

**FIGURE 2308.12.6(5)  
BRACED WALL PANEL EXTENSION OVER OPENING**



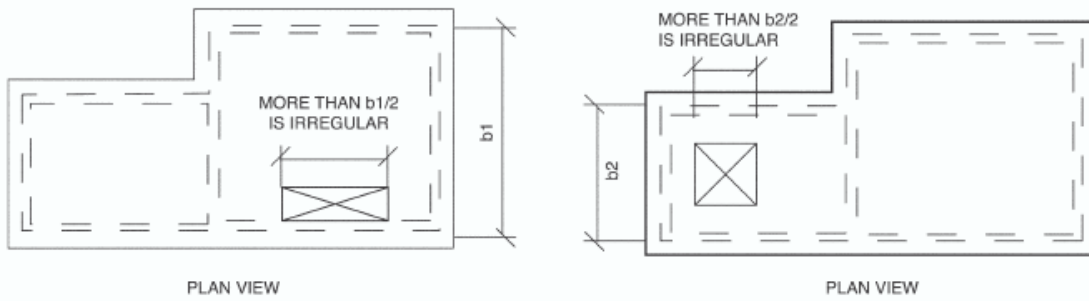
**FIGURE 2308.12.6(6)  
PORTIONS OF FLOOR LEVEL OFFSET VERTICALLY**





PLAN VIEW

FIGURE 2308.12.6(7)  
BRACED WALL LINES NOT PERPENDICULAR



PLAN VIEW

PLAN VIEW

FIGURE 2308.12.6(8)  
OPENING LIMITATIONS FOR FLOOR AND ROOF DIAPHRAGMS

**TABLE 2304.6  
MINIMUM THICKNESS OF WALL SHEATHING**

SHEATHING TYPE	MINIMUM THICKNESS	MAXIMUM WALL STUD SPACING
Wood boards	$\frac{5}{8}$ inch	24 inches on center
Fiberboard	$\frac{1}{2}$ inch	16 inches on center
Wood structural panel	In accordance with Tables 2308.9.3(2) and 2308.9.3(3)	—
M-S “Exterior Glue” and M-2 “Exterior Glue” Particleboard	In accordance with Tables 2306.4.3 and 2308.9.3(5)	—
Gypsum sheathing	$\frac{1}{2}$ inch	16 inches on center
Gypsum wallboard	$\frac{1}{2}$ inch	24 inches on center
Reinforced cement mortar	1 inch	24 inches on center

For SI: 1 inch = 25.4 mm.

**TABLE 2304.7(1)  
ALLOWABLE SPANS FOR LUMBER FLOOR AND ROOF SHEATHING<sup>a,b</sup>**

SPAN (inches)	MINIMUM NET THICKNESS (inches) OF LUMBER PLACED			
	Perpendicular to supports		Diagonally to supports	
	Surfaced dry <sup>c</sup>	Surfaced unseasoned	Surfaced dry <sup>c</sup>	Surfaced unseasoned
<b>Floors</b>				
24	$\frac{3}{4}$	$\frac{25}{32}$	$\frac{3}{4}$	$\frac{25}{32}$
16	$\frac{5}{8}$	$\frac{11}{16}$	$\frac{5}{8}$	$\frac{11}{16}$
<b>Roofs</b>				
24	$\frac{5}{8}$	$\frac{11}{16}$	$\frac{3}{4}$	$\frac{25}{32}$

For SI: 1 inch = 25.4 mm.

- Installation details shall conform to Sections 2304.6.1 and 2304.6.2 for floor and roof sheathing, respectively.
- Floor or roof sheathing conforming with this table shall be deemed to meet the design criteria of Section 2304.6.
- Maximum 19-percent moisture content.

**TABLE 2304.7(2)  
SHEATHING LUMBER, MINIMUM GRADE REQUIREMENTS: BOARD GRADE**

SOLID FLOOR OR ROOF SHEATHING	SPACED ROOF SHEATHING	GRADING RULES
Utility	Standard	NLGA, WCLIB, WWPA
4 common or utility	3 common or standard	NLGA, WCLIB, WWPA, NSLB or NELMA
No. 3	No. 2	SPIB
Merchantable	Construction common	RIS

**TABLE 2304.7(3)  
ALLOWABLE SPANS AND LOADS FOR WOOD STRUCTURAL PANEL SHEATHING AND  
SINGLE-FLOOR GRADES CONTINUOUS OVER TWO OR MORE SPANS WITH  
STRENGTH AXIS PERPENDICULAR TO SUPPORTS<sup>a,b</sup>**

SHEATHING GRADES		ROOF <sup>c</sup>				FLOOR <sup>d</sup>
Panel span rating roof/floor span	Panel thickness (inches)	Maximum span (inches)		Load <sup>e</sup> (psf)		Maximum span (inches)
		With edge support <sup>f</sup>	Without edge support	Total load	Live load	
12/0	$5/16$	12	12	40	30	0
16/0	$5/16, 3/8$	16	16	40	30	0
20/0	$5/16, 3/8$	20	20	40	30	0
24/0	$3/8, 7/16, 1/2$	24	20 <sup>g</sup>	40	30	0
24/16	$7/16, 1/2$	24	24	50	40	16
32/16	$15/32, 1/2, 5/8$	32	28	40	30	16 <sup>h</sup>
40/20	$19/32, 5/8, 3/4, 7/8$	40	32	40	30	20 <sup>h,j</sup>
48/24	$23/32, 3/4, 7/8$	48	36	45	35	24
54/32	$7/8, 1$	54	40	45	35	32
60/32	$7/8, 1, 1 1/8$	60	48	45	35	32
SINGLE FLOOR GRADES		ROOF <sup>c</sup>				FLOOR <sup>d</sup>
Panel span rating	Panel thickness (inches)	Maximum span (inches)		Load <sup>e</sup> (psf)		Maximum span (inches)
		With edge support <sup>f</sup>	Without edge support	Total load	Live load	
16 o.c.	$1/2, 19/32, 5/8$	24	24	50	40	16 <sup>h</sup>
20 o.c.	$19/32, 5/8, 3/4$	32	32	40	30	20 <sup>h,j</sup>
24 o.c.	$23/32, 3/4$	48	36	35	25	24
32 o.c.	$7/8, 1$	48	40	50	40	32
48 o.c.	$1 3/32, 1 1/8$	60	48	50	40	48

For SI: 1 inch = 25.4 mm, 1 pound per square foot = 0.0479 kN/m<sup>2</sup>.

- a. Applies to panels 24 inches or wider.
- b. Floor and roof sheathing conforming with this table shall be deemed to meet the design criteria of Section 2304.7.
- c. Uniform load deflection limitations  $1/180$  of span under live load plus dead load,  $1/240$  under live load only.
- d. Panel edges shall have approved tongue-and-groove joints or shall be supported with blocking unless  $1/4$ -inch minimum thickness underlayment or  $1 1/2$  inches of approved cellular or lightweight concrete is placed over the subfloor, or finish floor is  $3/4$ -inch wood strip. Allowable uniform load based on deflection of  $1/360$  of span is 100 pounds per square foot except the span rating of 48 inches on center is based on a total load of 65 pounds per square foot.
- e. Allowable load at maximum span.
- f. Tongue-and-groove edges, panel edge clips (one midway between each support, except two equally spaced between supports 48 inches on center), lumber blocking or other. Only lumber blocking shall satisfy blocked diaphragm requirements.
- g. For  $1/2$ -inch panel, maximum span shall be 24 inches.
- h. Span is permitted to be 24 inches on center where  $3/4$ -inch wood strip flooring is installed at right angles to joist.
- i. Span is permitted to be 24 inches on center for floors where  $1 1/2$  inches of cellular or lightweight concrete is applied over the panels.

**TABLE 2304.7(4)**  
**ALLOWABLE SPAN FOR WOOD STRUCTURAL PANEL COMBINATION SUBFLOOR-UNDERLAYMENT (SINGLE FLOOR)<sup>a,b</sup>**  
**(Panels Continuous Over Two or More Spans and Strength Axis Perpendicular to Supports)**

IDENTIFICATION	MAXIMUM SPACING OF JOISTS (inches)				
	16	20	24	32	48
Species group <sup>c</sup>	Thickness (inches)				
1	1/2	5/8	3/4	—	—
2, 3	5/8	3/4	7/8	—	—
4	3/4	7/8	1	—	—
Single floor span rating <sup>d</sup>	16 o.c.	20 o.c.	24 o.c.	32 o.c.	48 o.c.

For SI: 1 inch = 25.4 mm, 1 pound per square foot = 0.0479 kN/m<sup>2</sup>.

- Spans limited to value shown because of possible effects of concentrated loads. Allowable uniform loads based on deflection of  $1/360$  of span is 100 pounds per square foot except allowable total uniform load for  $1 1/2$ -inch wood structural panels over joists spaced 48 inches on center is 65 pounds per square foot. Panel edges shall have approved tongue-and-groove joints or shall be supported with blocking, unless  $1/4$ -inch minimum thickness underlayment or  $1 1/2$  inches of approved cellular or lightweight concrete is placed over the subfloor, or finish floor is  $3/4$ -inch wood strip.
- Floor panels conforming with this table shall be deemed to meet the design criteria of Section 2304.7.
- Applicable to all grades of sanded exterior-type plywood. See DOC PS 1 for plywood species groups.
- Applicable to Underlayment grade, C-C (Plugged) plywood, and Single Floor grade wood structural panels.

**TABLE 2304.7(5)**  
**ALLOWABLE LOAD (PSF) FOR WOOD STRUCTURAL PANEL ROOF SHEATHING CONTINUOUS OVER**  
**TWO OR MORE SPANS AND STRENGTH AXIS PARALLEL TO SUPPORTS**  
**(Plywood Structural Panels Are Five-Ply, Five-Layer Unless Otherwise Noted)<sup>a,b</sup>**

PANEL GRADE	THICKNESS (inch)	MAXIMUM SPAN (inches)	LOAD AT MAXIMUM SPAN (psf)	
			Live	Total
Structural I sheathing	7/16	24	20	30
	15/32	24	35 <sup>c</sup>	45 <sup>c</sup>
	1/2	24	40 <sup>c</sup>	50 <sup>c</sup>
	19/32, 5/8	24	70	80
	25/32, 3/4	24	90	100
Sheathing, other grades covered in DOC PS 1 or DOC PS 2	7/16	16	40	50
	15/32	24	20	25
	1/2	24	25	30
	19/32	24	40 <sup>c</sup>	50 <sup>c</sup>
	5/8	24	45 <sup>c</sup>	55 <sup>c</sup>
	25/32, 3/4	24	60 <sup>c</sup>	65 <sup>c</sup>

For SI: 1 inch = 25.4 mm, 1 pound per square foot = 0.0479 kN/m<sup>2</sup>.

- Roof sheathing conforming with this table shall be deemed to meet the design criteria of Section 2304.7.
- Uniform load deflection limitations  $1/180$  of span under live load plus dead load,  $1/240$  under live load only. Edges shall be blocked with lumber or other approved type of edge supports.
- For composite and four-ply plywood structural panel, load shall be reduced by 15 pounds per square foot.

**TABLE 2304.9.1  
FASTENING SCHEDULE**

CONNECTION	FASTENING <sup>a,m</sup>	LOCATION
1. Joist to sill or girder	3 - 8d common 3 - 3" × 0.131" nails 3 - 3" 14 gage staples	toenail
2. Bridging to joist	2 - 8d common 2 - 3" × 0.131" nails 2 - 3" 14 gage staples	toenail each end
3. 1" × 6" subfloor or less to each joist	2 - 8d common	face nail
4. Wider than 1" × 6" subfloor to each joist	3 - 8d common	face nail
5. 2" subfloor to joist or girder	2 - 16d common	blind and face nail
6. Sole plate to joist or blocking	16d at 16" o.c. 3" × 0.131" nails at 8" o.c. 3" 14 gage staples at 12" o.c.	typical face nail
Sole plate to joist or blocking at braced wall panel	3 - 16d at 16" 4 - 3" × 0.131" nails at 16" 4 - 3" 14 gage staples per 16"	braced wall panels
7. Top plate to stud	2 - 16d common 3 - 3" × 0.131" nails 3 - 3" 14 gage staples	end nail
8. Stud to sole plate	4 - 8d common 4 - 3" × 0.131" nails 3 - 3" 14 gage staples 2 - 16d common 3 - 3" × 0.131" nails 3 - 3" 14 gage staples	toenail  end nail
9. Double studs	16d at 24" o.c. 3" × 0.131" nail at 8" o.c. 3" 14 gage staple at 8" o.c.	face nail
10. Double top plates	16d at 16" o.c. 3" × 0.131" nail at 12" o.c. 3" 14 gage staple at 12" o.c.	typical face nail
Double top plates	8-16d common 12 - 3" × 0.131" nails 12 - 3" 14 gage staples typical face nail	lap splice
11. Blocking between joists or rafters to top plate	3 - 8d common 3 - 3" × 0.131" nails 3 - 3" 14 gage staples	toenail
12. Rim joist to top plate	8d at 6" (152 mm) o.c. 3" × 0.131" nail at 6" o.c. 3" 14 gage staple at 6" o.c.	toenail
13. Top plates, laps and intersections	2 - 16d common 3 - 3" × 0.131" nails 3 - 3" 14 gage staples	face nail
14. Continuous header, two pieces	16d common	16" o.c. along edge
15. Ceiling joists to plate	3 - 8d common 5 - 3" × 0.131" nails 5 - 3" 14 gage staples	toenail
16. Continuous header to stud	4 - 8d common	toenail

*(continued)*

**TABLE 2304.9.1—continued  
FASTENING SCHEDULE**

CONNECTION	FASTENING <sup>a,m</sup>	LOCATION
17. Ceiling joists, laps over partitions (see Section 2308.10.4.1, Table 2308.10.4.1)	3 - 16d common minimum, Table 2308.10.4.1 4 - 3" × 0.131" nails 4 - 3" 14 gage staples	face nail
18. Ceiling joists to parallel rafters (see Section 2308.10.4.1, Table 2308.10.4.1)	3 - 16d common minimum, Table 2308.10.4.1 4 - 3" × 0.131" nails 4 - 3" 14 gage staples	face nail
19. Rafter to plate (see Section 2308.10.1, Table 2308.10.1)	3 - 8d common 3 - 3" × 0.131" nails 3 - 3" 14 gage staples	toenail
20. 1" diagonal brace to each stud and plate	2 - 8d common 2 - 3" × 0.131" nails 2 - 3" 14 gage staples face nail	face nail
21. 1" × 8" sheathing to each bearing wall	2 - 8d common	face nail
22. Wider than 1" × 8" sheathing to each bearing	3 - 8d common	face nail
23. Built-up corner studs	16d common 3" × 0.131" nails 3" 14 gage staples	24" o.c. 16" o.c. 16" o.c.
24. Built-up girder and beams	20d common 32" o.c. 3" × 0.131" nail at 24" o.c. 3" 14 gage staple at 24" o.c.  2 - 20d common 3 - 3" × 0.131" nails 3 - 3" 14 gage staples	face nail at top and bottom staggered on opposite sides  face nail at ends and at each splice
25. 2" planks	16d common	at each bearing
26. Collar tie to rafter	3 - 10d common 4 - 3" × 0.131" nails 4 - 3" 14 gage staples face nail	face nail
27. Jack rafter to hip	3 - 10d common 4 - 3" × 0.131" nails 4 - 3" 14 gage staples  2 - 16d common 3 - 3" × 0.131" nails 3 - 3" 14 gage staples	toenail  face nail
28. Roof rafter to 2-by ridge beam	2 - 16d common 3 - 3" × 0.131" nails 3 - 3" 14 gage staples  2 - 16d common 3 - 3" × 0.131" nails 3 - 3" 14 gage staples	toenail  face nail
29. Joist to band joist	3 - 16d common 5 - 3" × 0.131" nails 5 - 3" 14 gage staples	face nail

(continued)

TABLE 2304.9.1—continued  
FASTENING SCHEDULE

CONNECTION	FASTENING <sup>a,m</sup>	LOCATION
30. Ledger strip	3 - 16d common 4 - 3" × 0.131" nails 4 - 3" 14 gage staples	face nail
31. Wood structural panels and particleboard: <sup>b</sup> Subfloor, roof and wall sheathing (to framing):	1/2" and less 6d <sup>c,l</sup> 2 3/8" × 0.113" nail <sup>n</sup> 1 3/4" 16 gage <sup>o</sup> 19/32" to 3/4" 8d <sup>d</sup> or 6d <sup>f</sup> 2 3/8" × 0.113" nail <sup>p</sup> 2" 16 gage <sup>p</sup> 7/8" to 1" 8d <sup>e</sup>	
Single Floor (combination subfloor-underlayment to framing):	1 1/8" to 1 1/4" 10d <sup>d</sup> or 8d <sup>f</sup> 3/4" and less 6d <sup>f</sup> 7/8" to 1" 8d <sup>f</sup> 1 1/8" to 1 1/4" 10d <sup>d</sup> or 8d <sup>f</sup>	
32. Panel siding (to framing)	1/2" or less 6d <sup>f</sup> 3/8" 8d <sup>f</sup>	
33. Fiberboard sheathing: <sup>g</sup>	1/2" No. 11 gage roofing nail <sup>h</sup> 6d common nail No. 16 gage staple <sup>i</sup> 25/32" No. 11 gage roofing nail <sup>h</sup> 8d common nail No. 16 gage staple <sup>i</sup>	
34. Interior paneling	1/4" 4d <sup>j</sup> 3/8" 6d <sup>k</sup>	

For SI: 1 inch = 25.4 mm.

- a. Common or box nails are permitted to be used except where otherwise stated.
- b. Nails spaced at 6 inches on center at edges, 12 inches at intermediate supports except 6 inches at supports where spans are 48 inches or more. For nailing of wood structural panel and particleboard diaphragms and shear walls, refer to Section 2305. Nails for wall sheathing are permitted to be common, box or casing.
- c. Common or deformed shank.
- d. Common.
- e. Deformed shank.
- f. Corrosion-resistant siding or casing nail.
- g. Fasteners spaced 3 inches on center at exterior edges and 6 inches on center at intermediate supports.
- h. Corrosion-resistant roofing nails with 7/16-inch-diameter head and 1 1/2-inch length for 1/2-inch sheathing and 1 3/4-inch length for 25/32-inch sheathing.
- i. Corrosion-resistant staples with nominal 7/16-inch crown and 1 1/8-inch length for 1/2-inch sheathing and 1 1/2-inch length for 25/32-inch sheathing. Panel supports at 16 inches (20 inches if strength axis in the long direction of the panel, unless otherwise marked).
- j. Casing or finish nails spaced 6 inches on panel edges, 12 inches at intermediate supports.
- k. Panel supports at 24 inches. Casing or finish nails spaced 6 inches on panel edges, 12 inches at intermediate supports.
- l. For roof sheathing applications, 8d nails are the minimum required for wood structural panels.
- m. Staples shall have a minimum crown width of 7/16 inch.
- n. For roof sheathing applications, fasteners spaced 4 inches on center at edges, 8 inches at intermediate supports.
- o. Fasteners spaced 4 inches on center at edges, 8 inches at intermediate supports for subfloor and wall sheathing and 3 inches on center at edges, 6 inches at intermediate supports for roof sheathing.
- p. Fasteners spaced 4 inches on center at edges, 8 inches at intermediate supports.

**TABLE 2305.2.3  
MAXIMUM DIAPHRAGM DIMENSION RATIOS  
HORIZONTAL AND SLOPED DIAPHRAGM**

TYPE	MAXIMUM LENGTH - WIDTH RATIO
Wood structural panel, nailed all edges	4:1
Wood structural panel, blocking omitted at intermediate joints	3:1
Diagonal sheathing, single	3:1
Diagonal sheathing, double	4:1

**TABLE 2305.3.3  
MAXIMUM SHEAR WALL ASPECT RATIOS**

TYPE	MAXIMUM HEIGHT - WIDTH RATIO
Wood structural panels or particleboard, nailed edges	For other than seismic: 3 <sup>1</sup> / <sub>2</sub> :1 For seismic: 2:1 <sup>a</sup>
Diagonal sheathing, single	2:1
Fiberboard	1 <sup>1</sup> / <sub>2</sub> :1
Gypsum board, gypsum lath, cement plaster	1 <sup>1</sup> / <sub>2</sub> :1 <sup>b</sup>

- a. For design to resist seismic forces, shear wall aspect ratios greater than 2:1, but not exceeding 3<sup>1</sup>/<sub>2</sub>:1, are permitted provided the factored shear resistance values in Table 2306.4.1 are multiplied by 2w/h.
- b. Ratio shown is for unblocked construction. Aspect ratio is permitted to be 2:1 where the wall is installed as blocked construction in accordance with Section 2306.4.5.1.2.

**TABLE 2305.3.7.2  
SHEAR RESISTANCE ADJUSTMENT FACTOR, C<sub>o</sub>**

WALL HEIGHT, H	MAXIMUM OPENING HEIGHT <sup>a</sup>				
	H/3	H/2	2H/3	5H/6	H
8' wall	2'-8"	4'-0"	5'-4"	6'-8"	8'-0"
10' wall	3'-4"	5'-0"	6'-8"	8'-4"	10'-0"
<b>Percent full-height sheathing<sup>b</sup></b>	<b>Shear resistance adjustment factor</b>				
10%	1.00	0.69	0.53	0.43	0.36
20%	1.00	0.71	0.56	0.45	0.38
30%	1.00	0.74	0.59	0.49	0.42
40%	1.00	0.77	0.63	0.53	0.45
50%	1.00	0.80	0.67	0.57	0.50
60%	1.00	0.83	0.71	0.63	0.56
70%	1.00	0.87	0.77	0.69	0.63
80%	1.00	0.91	0.83	0.77	0.71
90%	1.00	0.95	0.91	0.87	0.83
100%	1.00	1.00	1.00	1.00	1.00

For SI: 1 inch = 25.4 mm, 1 foot = 304.8 mm.

a. See Section 2305.3.7.2.2, Item 2.

b. See Section 2305.3.7.2.2, Item 1.



**TABLE 2306.2.1**  
**WALL STUD BENDING STRESS INCREASE FACTORS**

<b>STUD SIZE</b>	<b>SYSTEM FACTOR</b>
2 × 4	1.5
2 × 6	1.4
2 × 8	1.3
2 × 10	1.2
2 × 12	1.15

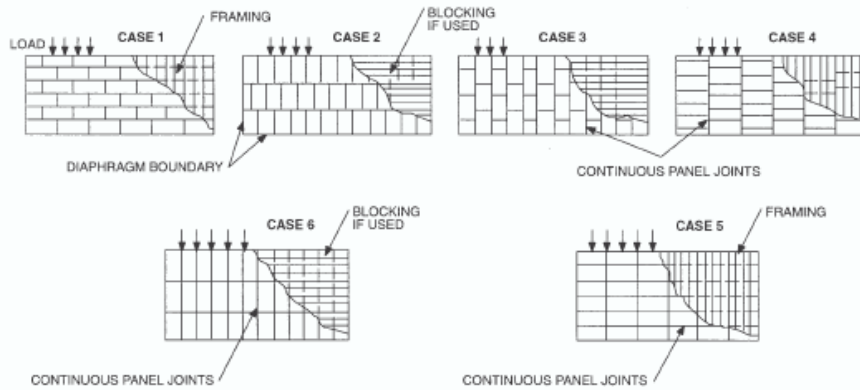
TABLE 2306.3.1  
**RECOMMENDED SHEAR (POUNDS PER FOOT) FOR WOOD STRUCTURAL PANEL DIAPHRAGMS WITH FRAMING OF DOUGLAS-FIR-LARCH, OR SOUTHERN PINE<sup>a</sup> FOR WIND OR SEISMIC LOADING**

PANEL GRADE	COMMON NAIL SIZE OR STAPLE LENGTH AND GAGE	MINIMUM FASTENER PENETRATION IN FRAMING (inches)	MINIMUM NOMINAL PANEL THICKNESS (inch)	MINIMUM NOMINAL WIDTH OF FRAMING MEMBER (inches)	BLOCKED DIAPHRAGMS						UNBLOCKED DIAPHRAGMS	
					Fastener spacing (inches) at diaphragm boundaries (all cases) at continuous panel edges parallel to load (Cases 3, 4), and at all panel edges (Cases 5 and 6) <sup>b</sup>						Fasteners spaced 6" max. At supported edges <sup>b</sup>	All other configurations (Cases 2, 3, 4, 5 and 6)
					6	4	2 1/2 <sup>c</sup>	2 <sup>c</sup>	Fastener spacing (inches) at other panel edges (Cases 1, 2, 3 and 4) <sup>b</sup>			
					6	4	6	4	3			
Structural I Grades	6d <sup>e</sup>	1 1/4	5/16	2	185	250	375	420	420	165	125	
	1 1/2 16 Gage	1		3	210	280	420	475	475	185	140	
	8d	1 3/8	3/8	2	155	205	310	350	350	135	105	
	1 1/2 16 Gage	1		3	175	230	345	390	390	155	115	
	10d <sup>d</sup>	1 1/2	15/32	2	270	360	530	600	600	240	180	
	1 1/2 16 Gage	1		3	300	400	600	675	675	265	200	
	6d <sup>e</sup>	1 1/4	5/16	2	175	235	350	400	400	155	115	
	1 1/2 16 Gage	1		3	200	265	395	450	450	175	130	
	8d	1 3/8	3/8	2	320	425	640	730	730	285	215	
	1 1/2 16 Gage	1		3	360	480	720	820	820	320	240	
	10d <sup>d</sup>	1 1/2	15/32	2	175	235	350	400	400	155	120	
	1 1/2 16 Gage	1		3	200	265	395	450	450	175	130	
6d <sup>e</sup>	1 1/4	5/16	2	170	225	335	380	380	150	110		
1 1/2 16 Gage	1		3	190	250	380	430	430	170	125		
8d	1 3/8	3/8	2	140	185	275	315	315	125	90		
1 1/2 16 Gage	1		3	155	205	310	350	350	140	105		
10d <sup>d</sup>	1 1/2	15/32	2	185	250	375	420	420	165	125		
1 1/2 16 Gage	1		3	210	280	420	475	475	185	140		
6d <sup>e</sup>	1 1/4	5/16	2	240	320	480	545	545	215	160		
1 1/2 16 Gage	1		3	270	360	540	610	610	240	180		

TABLE 2306.3.1—continued  
 RECOMMENDED SHEAR (POUNDS PER FOOT) FOR WOOD STRUCTURAL PANEL DIAPHRAGMS WITH  
 FRAMING OF DOUGLAS-FIR-LARCH, OR SOUTHERN PINE<sup>a</sup> FOR WIND OR SEISMIC LOADING

PANEL GRADE	COMMON NAIL SIZE OR STAPLE <sup>c</sup> LENGTH AND GAGE	MINIMUM FASTENER PENETRATION IN FRAMING (inches)	MINIMUM NOMINAL PANEL THICKNESS (inch)	MINIMUM NOMINAL WIDTH OF FRAMING MEMBER (inches)	BLOCKED DIAPHRAGMS					UNBLOCKED DIAPHRAGMS		
					Fastener spacing (inches) at diaphragm boundaries (all cases) at continuous panel edges parallel to load (Cases 3, 4), and at all panel edges (Cases 5 and 6) <sup>b</sup>					Fasteners spaced 6" max. at supported edges <sup>b</sup>		
					6	4	2 1/2 <sup>c</sup>	2 <sup>c</sup>	Fastener spacing (inches) at other panel edges (Cases 1, 2, 3 and 4) <sup>b</sup>		Case 1 (No unblocked edges or continuous joints parallel to load)	All other configurations (Cases 2, 3, 4, 5 and 6)
Sheathing, single floor and other grades covered in DOC PS 1 and PS 2 (continued)	1 1/2 16 Gage	1	3/8	2	6	4	2 1/2 <sup>c</sup>	2 <sup>c</sup>	6	4	Case 1 (No unblocked edges or continuous joints parallel to load)	All other configurations (Cases 2, 3, 4, 5 and 6)
					6	210	315	360	360	140	105	
	8d	1 3/8	7/16	3	6	4	2 1/2 <sup>c</sup>	2 <sup>c</sup>	6	4	Case 1 (No unblocked edges or continuous joints parallel to load)	All other configurations (Cases 2, 3, 4, 5 and 6)
					6	235	355	400	400	160	120	
	1 1/2 16 Gage	1	15/32	2	6	4	2 1/2 <sup>c</sup>	2 <sup>c</sup>	6	4	Case 1 (No unblocked edges or continuous joints parallel to load)	All other configurations (Cases 2, 3, 4, 5 and 6)
					6	340	505	575	575	230	170	
	8d	1 3/8	7/16	3	6	4	2 1/2 <sup>c</sup>	2 <sup>c</sup>	6	4	Case 1 (No unblocked edges or continuous joints parallel to load)	All other configurations (Cases 2, 3, 4, 5 and 6)
					6	380	570	645	645	255	190	
	1 1/2 16 Gage	1	15/32	2	6	4	2 1/2 <sup>c</sup>	2 <sup>c</sup>	6	4	Case 1 (No unblocked edges or continuous joints parallel to load)	All other configurations (Cases 2, 3, 4, 5 and 6)
					6	225	335	380	380	150	110	
	8d	1 3/8	7/16	3	6	4	2 1/2 <sup>c</sup>	2 <sup>c</sup>	6	4	Case 1 (No unblocked edges or continuous joints parallel to load)	All other configurations (Cases 2, 3, 4, 5 and 6)
					6	250	375	425	425	165	125	
10d <sup>d</sup>	1 1/2	15/32	2	6	4	2 1/2 <sup>c</sup>	2 <sup>c</sup>	6	4	Case 1 (No unblocked edges or continuous joints parallel to load)	All other configurations (Cases 2, 3, 4, 5 and 6)	
				6	360	530	600	600	240	180		
1 1/2 16 Gage	1	19/32	3	6	4	2 1/2 <sup>c</sup>	2 <sup>c</sup>	6	4	Case 1 (No unblocked edges or continuous joints parallel to load)	All other configurations (Cases 2, 3, 4, 5 and 6)	
				6	400	600	675	675	265	200		
10d <sup>d</sup>	1 1/2	15/32	2	6	4	2 1/2 <sup>c</sup>	2 <sup>c</sup>	6	4	Case 1 (No unblocked edges or continuous joints parallel to load)	All other configurations (Cases 2, 3, 4, 5 and 6)	
				6	385	575	655	655	255	190		
1 1/2 16 Gage	1	19/32	3	6	4	2 1/2 <sup>c</sup>	2 <sup>c</sup>	6	4	Case 1 (No unblocked edges or continuous joints parallel to load)	All other configurations (Cases 2, 3, 4, 5 and 6)	
				6	430	650	735	735	290	215		
10d <sup>d</sup>	1 1/2	15/32	2	6	4	2 1/2 <sup>c</sup>	2 <sup>c</sup>	6	4	Case 1 (No unblocked edges or continuous joints parallel to load)	All other configurations (Cases 2, 3, 4, 5 and 6)	
				6	210	315	360	360	140	105		
1 3/4 16 Gage	1	19/32	3	6	4	2 1/2 <sup>c</sup>	2 <sup>c</sup>	6	4	Case 1 (No unblocked edges or continuous joints parallel to load)	All other configurations (Cases 2, 3, 4, 5 and 6)	
				6	235	355	405	405	160	120		
1 1/2 16 Gage	1 1/2	15/32	2	6	4	2 1/2 <sup>c</sup>	2 <sup>c</sup>	6	4	Case 1 (No unblocked edges or continuous joints parallel to load)	All other configurations (Cases 2, 3, 4, 5 and 6)	
				6	425	640	730	730	285	215		
1 3/4 16 Gage	1	19/32	3	6	4	2 1/2 <sup>c</sup>	2 <sup>c</sup>	6	4	Case 1 (No unblocked edges or continuous joints parallel to load)	All other configurations (Cases 2, 3, 4, 5 and 6)	
				6	480	720	820	820	320	240		
1 1/2 16 Gage	1 1/2	15/32	2	6	4	2 1/2 <sup>c</sup>	2 <sup>c</sup>	6	4	Case 1 (No unblocked edges or continuous joints parallel to load)	All other configurations (Cases 2, 3, 4, 5 and 6)	
				6	235	350	400	400	155	115		
1 3/4 16 Gage	1	19/32	3	6	4	2 1/2 <sup>c</sup>	2 <sup>c</sup>	6	4	Case 1 (No unblocked edges or continuous joints parallel to load)	All other configurations (Cases 2, 3, 4, 5 and 6)	
				6	265	395	450	450	175	130		

**TABLE 2306.3.1—continued**  
**RECOMMENDED SHEAR (POUNDS PER FOOT) FOR WOOD STRUCTURAL**  
**PANEL DIAPHRAGMS WITH FRAMING OF DOUGLAS-FIR-LARCH,**  
**OR SOUTHERN PINE<sup>8</sup> FOR WIND OR SEISMIC LOADING**



For SI: 1 inch = 25.4 mm, 1 pound per foot = 14.5939 N/m.

- a. For framing of other species: (1) Find specific gravity for species of lumber in AFPA National Design Specification. (2) For staples find shear value from table above for Structural I panels (regardless of actual grade) and multiply value by 0.82 for species with specific gravity of 0.42 or greater, or 0.65 for all other species. (3) For nails find shear value from table above for nail size for actual grade and multiply value by the following adjustment factor: Specific Gravity Adjustment Factor =  $[1 - (0.5 - SG)]$ , where SG = Specific Gravity of the framing lumber. This adjustment factor shall not be greater than 1.
- b. Space fasteners maximum 12 inches o.c. along intermediate framing members (6 inches o.c. where supports are spaced 48 inches o.c.).
- c. Framing at adjoining panel edges shall be 3 inches nominal or wider, and nails shall be staggered where nails are spaced 2 inches o.c. or  $2\frac{1}{2}$  inches o.c.
- d. Framing at adjoining panel edges shall be 3 inches nominal or wider, and nails shall be staggered where both of the following conditions are met: (1) 10d nails having penetration into framing of more than  $1\frac{1}{2}$  inches and (2) nails are spaced 3 inches o.c. or less.
- e. 8d is recommended minimum for roofs due to negative pressures of high winds.
- f. Staples shall have a minimum crown width of  $\frac{7}{16}$  inch.

**TABLE 2306.3.2  
ALLOWABLE SHEAR IN POUNDS PER FOOT FOR HORIZONTAL BLOCKED DIAPHRAGMS  
UTILIZING MULTIPLE ROWS OF FASTENERS (HIGH LOAD DIAPHRAGMS) WITH FRAMING OF DOUGLASS FIR,  
LARCH OR SOUTHERN PINE<sup>a</sup> FOR WIND OR SEISMIC LOADING<sup>b</sup>**

PANEL GRADE <sup>c</sup>	FASTENER AND SIZE	MINIMUM NAIL PENETRATION IN FRAMING (inches)	MINIMUM NOMINAL PANEL THICKNESS (inch)	MINIMUM NOMINAL WIDTH OF FRAMING MEMBER <sup>a</sup> (inches)	LINES OF FASTENERS	BLOCKED DIAPHRAGMS					
						Cases 1 and 2 <sup>d</sup>					
						Fastener Spacing Per Line at Boundaries (inches)					
						4		2 1/2		2	
						Fastener Spacing Per Line at Other Panel Edges (inches)					
						6	4	4	3	3	2
Structural I grades	10d common nails	1 1/2	15/32	3	2	605	815	875	1,150	—	—
				4	2	700	915	1,005	1,290	—	—
				4	3	875	1,220	1,285	1,395	—	—
			19/32	3	2	670	880	965	1,255	—	—
				4	2	780	990	1,110	1,440	—	—
				4	3	965	1,320	1,405	1,790	—	—
23/32	3	2	730	955	1,050	1,365	—	—			
	4	2	855	1,070	1,210	1,565	—	—			
	4	3	1,050	1,430	1,525	1,800	—	—			
	14 gage staples	2	15/32	3	2	600	600	860	960	1,060	1,200
				4	3	860	900	1,160	1,295	1,295	1,400
			19/32	3	2	600	600	875	960	1,075	1,200
				4	3	875	900	1,175	1,440	1,475	1,795
Sheathing single floor and other grades covered in DOC PS 1 and PS 2	10d common nails	1 1/2	15/32	3	2	525	725	765	1,010	—	—
				4	2	605	815	875	1,105	—	—
				4	3	765	1,085	1,130	1,195	—	—
			19/32	3	2	650	860	935	1,225	—	—
				4	2	755	965	1,080	1,370	—	—
				4	3	935	1,290	1,365	1,485	—	—
	23/32	3	2	710	935	1,020	1,335	—	—		
		4	2	825	1,050	1,175	1,445	—	—		
		4	3	1,020	1,400	1,480	1,565	—	—		
	14 gage staples	2	15/32	3	2	540	540	735	865	915	1,080
				4	3	735	810	1,005	1,105	1,105	1,195
				19/32	3	2	600	600	865	960	1,065
4			3	865	900	1,130	1,430	1,370	1,485		
23/32			4	3	865	900	1,130	1,490	1,430	1,545	

For SI: 1 inch = 25.4 mm.

- For framing of the other species: (1) Find specific gravity for species of framing lumber in AFPA National Design Specification, (2) Find shear value from table above for nail size of actual grade, and (3) Multiply value by the following adjustment factor =  $[1 - 0.5 - SG]$ , where  $SG$  = Specific gravity of the framing lumber. This adjustment factor shall not be greater than 1.
- Fastening along intermediate framing members: Space nails 12 inches on center, except 6 inches on center for spans greater than 32 inches.
- Panels conforming to PS 1 or PS 2.
- This table gives shear values for Cases 1 and 2 as shown in Table 2306.3.1. The values shown are applicable to Cases 3, 4, 5 and 6 as shown in Table 2306.3.1, providing fasteners at all continuous panel edges are spaced in accordance with the boundary fastener spacing.
- The minimum depth of framing members shall be 3 inches.

**TABLE 2306.3.3  
DIAGONALLY SHEATHED LUMBER DIAPHRAGM NAILING SCHEDULE**

SHEATHING NOMINAL DIMENSION	NAILING TO INTERMEDIATE AND END-BEARING STUDS		NAILING AT THE SHEAR PANEL BOUNDARIES	
	Type, size and number of nails per board			
	Common nails	Box nails	Common nails	Box nails
1 x 6	2 - 8d	3 - 8d	3 - 8d	5 - 8d
1 x 8	3 - 8d	4 - 8d	4 - 8d	6 - 8d
2 x 6	2 - 16d	3 - 16d	3 - 16d	5 - 16d
2 x 8	3 - 16d	4 - 16d	4 - 16d	6 - 16d

**TABLE 2306.4.1  
ALLOWABLE SHEAR (POUNDS PER FOOT) FOR WOOD STRUCTURAL PANEL SHEAR WALLS WITH FRAMING OF DOUGLAS-FIR-LARCH, OR SOUTHERN PINE<sup>a</sup> FOR WIND OR SEISMIC LOADING<sup>b, c, h, i</sup>**

PANEL GRADE	MINIMUM NOMINAL PANEL THICKNESS (inch)	MINIMUM FASTENER PENETRATION IN FRAMING (inches)	PANELS APPLIED DIRECT TO FRAMING						PANELS APPLIED OVER 1/2" OR 3/8" GYPSUM SHEATHING								
			NAIL (common or galvanized box) or staple size <sup>d</sup>			Fastener spacing at panel edges (inches)			NAIL (common or galvanized box) or staple size <sup>d</sup>			Fastener spacing at panel edges (inches)					
			6	4	3	2"	3	2"	6	4	3	2"	3	2"			
Structural I Sheathing	5/16	1 1/4	6d	200	300	390	510	8d	200	300	390	510	8d	200	300	390	510
			1 1/2, 1.6 Gage	165	245	325	415	2.16 Gage	125	185	245	315	2.16 Gage	125	185	245	315
	3/8	1 3/8	8d	230 <sup>d</sup>	360 <sup>d</sup>	460 <sup>d</sup>	610 <sup>d</sup>	10d	280	430	550 <sup>f</sup>	730	10d	280	430	550 <sup>f</sup>	730
			1 1/2, 1.6 Gage	155	235	315	400	2.16 Gage	155	235	310	400	2.16 Gage	155	235	310	400
	7/16	1 3/8	8d	255 <sup>d</sup>	395 <sup>d</sup>	505 <sup>d</sup>	670 <sup>d</sup>	10d	280	430	550 <sup>f</sup>	730	10d	280	430	550 <sup>f</sup>	730
			1 1/2, 1.6 Gage	170	260	345	440	2.16 Gage	155	235	310	400	2.16 Gage	155	235	310	400
	15/32	1 3/8	8d	280	430	550	730	10d	280	430	550 <sup>f</sup>	730	10d	280	430	550 <sup>f</sup>	730
			1 1/2, 1.6 Gage	185	280	375	475	2.16 Gage	155	235	300	400	2.16 Gage	155	235	300	400
	5/16 or 1/4 <sup>e</sup>	1 1/2	10d	340	510	665 <sup>f</sup>	870	10d	340	510	665 <sup>f</sup>	870	10d	340	510	665 <sup>f</sup>	870
			1 1/2, 1.6 Gage	180	270	350	450	2.16 Gage	180	270	350	450	2.16 Gage	180	270	350	450
3/8	1 1/4	6d	145	220	295	375	2.16 Gage	110	165	220	285	2.16 Gage	110	165	220	285	
		1 1/2, 1.6 Gage	200	300	390	510	8d	200	300	390	510	8d	200	300	390	510	
7/16	1 3/8	8d	220 <sup>d</sup>	320 <sup>d</sup>	410 <sup>d</sup>	530 <sup>d</sup>	10d	260	380	490 <sup>f</sup>	640	10d	260	380	490 <sup>f</sup>	640	
		1 1/2, 1.6 Gage	140	210	280	360	2.16 Gage	140	210	280	360	2.16 Gage	140	210	280	360	
Sheathing, plywood siding <sup>g</sup> except Group 5 Species	15/32	1 1/2	8d	240 <sup>d</sup>	350 <sup>d</sup>	450 <sup>d</sup>	585 <sup>d</sup>	10d	260	380	490 <sup>f</sup>	640	10d	260	380	490 <sup>f</sup>	640
			1 1/2, 1.6 Gage	155	230	310	395	2.16 Gage	140	210	280	360	2.16 Gage	140	210	280	360
19/32	1 1/2	10d	310	460	600 <sup>f</sup>	770	10d	310	460	600 <sup>f</sup>	770	10d	310	460	600 <sup>f</sup>	770	
		1 1/2, 1.6 Gage	170	255	335	430	2.16 Gage	140	210	280	360	2.16 Gage	140	210	280	360	
Galvanized nails shall be (1) clipped or (2) unclipped	3/8	1 3/8	10d	340	510	665 <sup>f</sup>	870	10d	340	510	665 <sup>f</sup>	870	10d	340	510	665 <sup>f</sup>	870
			1 1/2, 1.6 Gage	185	280	375	475	2.16 Gage	155	235	310	400	2.16 Gage	155	235	310	400
Galvanized nails shall be (1) clipped or (2) unclipped	3/8	1 3/8	10d	140	210	275	360	10d	140	210	275	360	10d	140	210	275	360
			1 1/2, 1.6 Gage	160	240	310	410	2.16 Gage	160	240	310	410	2.16 Gage	160	240	310	410

For SI: 1 inch = 25.4 mm, 1 pound per foot = 14.99 N/m.  
a. For framing of other species: (1) Find specific gravity for species of lumber in AF&PA National Design Specification. (2) For all species find shear value from table above for Structural I panels (regardless of actual grade) and multiply value by 0.82 for species with specific gravity of 0.42 or greater, or 0.65 for all other species. (3) For nail shear values from table above for actual grade and multiply value by the following adjustment factor: Specific Gravity Adjustment Factor = [1 - (0.5 - SG)].  
b. Panel edges backed with 2-inch nominal crown stud framing. Install panels either horizontally or vertically. Space fasteners maximum 6 inches on center along intermediate framing members for 3/8-inch and 1/2-inch panels in studded on studs spaced 24 inches on center. For other conditions and panel thickness, space fasteners maximum 12 inches on center on intermediate supports.  
c. 3/4-inch panel thickness or siding with a span rating of 16 inches on center is the minimum recommended where applied direct to framing as exterior siding.  
d. Shears are permitted to be increased to values shown for 3/8-inch sheathing with same nailing provided: (a) studs are spaced a maximum of 16 inches on center, or (b) if panels are applied with long dimension across studs.  
e. Framing at adjoining panel edges shall be 3 inches nominal or wider, and nails shall be staggered where nails are spaced 2 inches on center.  
f. Framing at adjoining panel edges shall be 3 inches nominal or wider, and nails shall be staggered where both of the following conditions are met: (1) 10d nails having penetrations into framing of more than 1 1/2 inches and (2) nails are spaced 3 inches on center.  
g. Values apply to all-veneer plywood. Thickness at point of fastener on panel edges governs shear values.  
h. Where panels are applied on both faces of a wall and nailing is less than 6 inches on center, on either side, panel joints shall be offset to fall on different framing members. Or, framing shall be 3 inches nominal thicker and nails on each side shall be staggered.  
i. In Seismic Design Category D, E, or F, where shear design values exceed 400 pounds per linear foot (LRFD) or 350 pounds per linear foot (ASD), all framing members meeting edge in abutting panels shall not be less than a single 3-inch nominal member. Plywood joint and all plate nailing shall be staggered in all cases. See Section 2305.5.10 for all plate side and anchorage requirements.  
j. Galvanized nails shall be (1) clipped or (2) unclipped.  
k. Staples shall have a minimum crown width of 7/16 inch.

**TABLE 2306.4.3  
ALLOWABLE SHEAR FOR PARTICLEBOARD SHEAR WALL SHEATHING**

PANEL GRADE	MINIMUM NOMINAL PANEL THICKNESS (inch)	MINIMUM NAIL PENETRATION IN FRAMING (inches)	PANELS APPLIED DIRECT TO FRAMING				
			Nail size (common or galvanized box)	Allowable shear (pounds per foot) nail spacing at panel edges (inches) <sup>a</sup>			
				6	4	3	2
M-S "Exterior Glue" and M-2 "Exterior Glue"	$\frac{3}{8}$	$1\frac{1}{2}$	6d	120	180	230	300
	$\frac{3}{8}$	$1\frac{1}{2}$	8d	130	190	240	315
	$\frac{1}{2}$			140	210	270	350
	$\frac{1}{2}$	$1\frac{5}{8}$	10d	185	275	360	460
	$\frac{5}{8}$			200	305	395	520

For SI: 1 inch = 25.4 mm, 1 pound per foot = 14.5939 N/m.

a. Values are not permitted in Seismic Design Category D, E or F.

**TABLE 2306.4.5  
ALLOWABLE SHEAR FOR WIND OR SEISMIC FORCES FOR SHEAR WALLS OF LATH  
AND PLASTER OR GYPSUM BOARD WOOD FRAMED WALL ASSEMBLIES**

TYPE OF MATERIAL	THICKNESS OF MATERIAL	WALL CONSTRUCTION	FASTENER SPACING <sup>b</sup> MAXIMUM (inches)	SHEAR VALUE <sup>a,g</sup> (plf)	MINIMUM FASTENER SIZE <sup>c,d,i,k</sup>
1. Expanded metal or woven wire lath and portland cement plaster	7/8"	Unblocked	6	180	No. 11 gage 1 1/2" long, 7/16" head 16 Ga. Galv. Staple, 7/8" legs
2. Gypsum lath, plain or perforated	3/8" lath and 1/2" plaster	Unblocked	5	100	No. 13 gage, 1 1/8" long, 19/64" head, plasterboard nail 16 Ga. Galv. Staple, 1 1/8" long 0.120" Nail, min. 3/8" head, 1 1/4" long
3. Gypsum sheathing	1/2" x 2' x 8'	Unblocked	4	75	No. 11 gage, 1 3/4" long, 7/16" head, diamond-point, galvanized 16 Ga. Galv. Staple, 1 3/4" long
	1/2" x 4'	Blocked <sup>f</sup> Unblocked	4 7	175 100	
	5/8" x 4'	Blocked	4" edge/ 7" field	200	6d galvanized 0.120" Nail, min. 3/8" head, 1 3/4" long
4. Gypsum board, gypsum veneer base, or water-resistant gypsum backing board	1/2"	Unblocked <sup>f</sup>	7	75	5d cooler or wallboard 0.120" Nail, min. 3/8" head, 1 1/2" long 16 Gage Staple, 1 1/2" long
		Unblocked <sup>f</sup>	4	110	
		Unblocked	7	100	
		Unblocked	4	125	
		Blocked <sup>g</sup>	7	125	
		Blocked <sup>g</sup>	4	150	
		Unblocked	8/12 <sup>h</sup>	60	No. 6-1 1/4" screws <sup>i</sup>
		Blocked <sup>g</sup>	4/16 <sup>h</sup>	160	
		Blocked <sup>g</sup>	4/12 <sup>h</sup>	155	
		Blocked <sup>f, g</sup>	8/12 <sup>h</sup>	70	
	Blocked <sup>g</sup>	6/12 <sup>h</sup>	90		
	5/8"	Unblocked <sup>f</sup>	7	115	6d cooler or wallboard 0.120" Nail, min. 3/8" head, 1 3/4" long 16 Gage Staple, 1 1/2" legs, 1 5/8" long
			4	145	
		Blocked <sup>g</sup>	7	145	
4			175		
Blocked <sup>g</sup> Two-ply		Base ply: 9 Face ply: 7	250	Base ply—6d cooler or wallboard 1 3/4" x 0.120" Nail, min. 3/8" head 1 5/8" 16 Ga. Galv. Staple Face ply—8d cooler or wallboard 0.120" Nail, min. 3/8" head, 2 3/8" long 15 Ga. Galv. Staple, 2 1/4" long	
Unblocked		8/12 <sup>h</sup>	70	No. 6-1 1/4" screws <sup>i</sup>	
Blocked <sup>g</sup>	8/12 <sup>h</sup>	90			

For SI: 1 inch = 25.4 mm, 1 foot = 304.8 mm, 1 pound per foot = 14.5939 N/m.

- These shear walls shall not be used to resist loads imposed by masonry or concrete construction (see Section 2305.1.5). Values shown are for short-term loading due to wind or seismic loading in Seismic Design Categories A, B and C. Walls resisting seismic loads shall be subject to the limitations in Section 1617.6. Values shown shall be reduced 25 percent for normal loading.
- Applies to nailing at studs, top and bottom plates and blocking.
- Alternate nails are permitted to be used if their dimensions are not less than the specified dimensions. Drywall screws are permitted to be substituted for the 5d, 6d (cooler) nails listed above. 1 1/4 inches Type S or W, No. 6 for 6d (cooler) nails.
- For properties of cooler nails, see ASTM C 514.
- Except as noted, shear values are based on a maximum framing spacing of 16 inches on center.
- Maximum framing spacing of 24 inches on center.
- All edges are blocked, and edge nailing is provided at all supports and all panel edges.
- First number denotes fastener spacing at the edges; second number denotes fastener spacing in the field.
- Screws are Type W or S.
- Staples shall have a minimum crown width of 7/16 inch, measured outside the legs.
- Staples for the attachment of gypsum lath and woven-wire lath shall have a minimum crown width of 3/4 inch, measured outside the legs.



TABLE 2308.8(1)  
**FLOOR JOIST SPANS FOR COMMON LUMBER SPECIES**  
 (Residential Sleeping Areas, Live Load = 30 psf, L/Δ = 360)

JOIST SPACING (inches)	SPECIES AND GRADE	DEAD LOAD = 10 psf					DEAD LOAD = 20 psf							
		2x6	2x8	2x10	2x12	2x6	2x8	2x10	2x12					
		(ft. - in.)	(ft. - in.)	(ft. - in.)	(ft. - in.)	(ft. - in.)	(ft. - in.)	(ft. - in.)	(ft. - in.)					
		Maximum floor joist spans												
12	Douglas Fir-Larch	12-6	16-6	21-0	25-7	12-6	16-6	21-0	25-7	12-6	16-6	21-0	25-7	
	Douglas Fir-Larch	#1	12-0	15-10	20-3	24-8	12-0	15-7	19-0	22-0	12-0	15-7	19-0	22-0
	Douglas Fir-Larch	#2	11-10	15-7	19-10	23-0	11-6	14-7	17-9	20-7	11-6	14-7	17-9	20-7
	Douglas Fir-Larch	#3	9-8	12-4	15-0	17-5	8-8	11-0	13-5	15-7	8-8	11-0	13-5	15-7
	Hem-Fir	SS	11-10	15-7	19-10	24-2	11-10	15-7	19-10	24-2	11-10	15-7	19-10	24-2
	Hem-Fir	#1	11-7	15-3	19-5	23-7	11-7	15-2	18-6	21-6	11-7	15-2	18-6	21-6
	Hem-Fir	#2	11-0	14-6	18-6	22-6	11-0	14-4	17-6	20-4	11-0	14-4	17-6	20-4
	Hem-Fir	#3	9-8	12-4	15-0	17-5	8-8	11-0	13-5	15-7	8-8	11-0	13-5	15-7
	Southern Pine	SS	12-3	16-2	20-8	25-1	12-3	16-2	20-8	25-1	12-3	16-2	20-8	25-1
	Southern Pine	#1	12-0	15-10	20-3	24-8	12-0	15-10	20-3	24-8	12-0	15-10	20-3	24-8
	Southern Pine	#2	11-10	15-7	19-10	24-2	11-10	15-7	19-10	24-2	11-10	15-7	19-10	24-2
	Southern Pine	#3	10-5	13-3	15-8	18-8	9-4	11-11	14-0	16-8	9-4	11-11	14-0	16-8
16	Spruce-Pine-Fir	SS	11-7	15-3	19-5	23-7	11-7	15-3	19-5	23-7	11-7	15-3	19-5	23-7
	Spruce-Pine-Fir	#1	11-3	14-11	19-0	23-0	11-3	14-7	17-9	20-7	11-3	14-7	17-9	20-7
	Spruce-Pine-Fir	#2	11-3	14-11	19-0	23-0	11-3	14-7	17-9	20-7	11-3	14-7	17-9	20-7
	Spruce-Pine-Fir	#3	9-8	12-4	15-0	17-5	8-8	11-0	13-5	15-7	8-8	11-0	13-5	15-7
	Douglas Fir-Larch	SS	11-4	15-0	19-1	23-3	11-4	15-0	19-1	23-0	11-4	15-0	19-1	23-0
	Douglas Fir-Larch	#1	10-11	14-5	18-5	21-4	10-8	13-6	16-5	19-1	10-8	13-6	16-5	19-1
	Douglas Fir-Larch	#2	10-9	14-1	17-2	19-11	9-11	12-7	15-5	17-10	9-11	12-7	15-5	17-10
	Douglas Fir-Larch	#3	8-5	10-8	13-0	15-1	7-6	9-6	11-8	13-6	7-6	9-6	11-8	13-6
	Hem-Fir	SS	10-9	14-2	18-0	21-11	10-9	14-2	18-0	21-11	10-9	14-2	18-0	21-11
	Hem-Fir	#1	10-6	13-10	17-8	20-9	10-4	13-1	16-0	18-7	10-4	13-1	16-0	18-7
	Hem-Fir	#2	10-0	13-2	16-10	19-8	9-10	12-5	15-2	17-7	9-10	12-5	15-2	17-7
	Hem-Fir	#3	8-5	10-8	13-0	15-1	7-6	9-6	11-8	13-6	7-6	9-6	11-8	13-6
16	Southern Pine	SS	11-2	14-8	18-9	22-10	11-2	14-8	18-9	22-10	11-2	14-8	18-9	22-10
	Southern Pine	#1	10-11	14-5	18-5	22-5	10-11	14-5	17-11	21-4	10-11	14-5	17-11	21-4
	Southern Pine	#2	10-9	14-2	18-0	21-1	10-5	13-6	16-1	18-10	10-5	13-6	16-1	18-10
	Southern Pine	#3	9-0	11-6	13-7	16-2	8-1	10-3	12-2	14-6	8-1	10-3	12-2	14-6
	Spruce-Pine-Fir	SS	10-6	13-10	17-8	21-6	10-6	13-10	17-8	21-4	10-6	13-10	17-8	21-4
	Spruce-Pine-Fir	#1	10-3	13-6	17-2	19-11	9-11	12-7	15-5	17-10	9-11	12-7	15-5	17-10
	Spruce-Pine-Fir	#2	10-3	13-6	17-2	19-11	9-11	12-7	15-5	17-10	9-11	12-7	15-5	17-10
	Spruce-Pine-Fir	#3	8-5	10-8	13-0	15-1	7-6	9-6	11-8	13-6	7-6	9-6	11-8	13-6

(continued)

TABLE 2308.8(1)—continued  
**FLOOR JOIST SPANS FOR COMMON LUMBER SPECIES**  
 (Residential Sleeping Areas, Live Load = 30 psf, L/Δ = 360)

JOIST SPACING (inches)	SPECIES AND GRADE	DEAD LOAD = 10 psf				DEAD LOAD = 20 psf			
		2x6	2x8	2x10	2x12	2x6	2x8	2x10	2x12
		(ft. - in.)	(ft. - in.)	(ft. - in.)	(ft. - in.)	(ft. - in.)	(ft. - in.)	(ft. - in.)	(ft. - in.)
19.2	Douglas Fir-Larch	10-8	14-1	18-0	21-10	10-8	14-1	18-0	21-0
	Douglas Fir-Larch #1	10-4	13-7	16-9	19-6	9-8	12-4	15-0	17-5
	Douglas Fir-Larch #2	10-1	12-10	15-8	18-3	9-1	11-6	14-1	16-3
	Douglas Fir-Larch #3	7-8	9-9	11-10	13-9	6-10	8-8	10-7	12-4
	Hem-Fir	10-1	13-4	17-0	20-8	10-1	13-4	17-0	20-7
	Hem-Fir #1	9-10	13-0	16-4	19-0	9-6	12-0	14-8	17-0
	Hem-Fir #2	9-5	12-5	15-6	17-1	8-11	11-4	13-10	16-1
	Hem-Fir #3	7-8	9-9	11-10	13-9	6-10	8-8	10-7	12-4
	Southern Pine	10-6	13-10	17-8	21-6	10-6	13-10	17-8	21-6
	Southern Pine #1	10-4	13-7	17-4	21-1	10-4	13-7	16-4	19-6
	Southern Pine #2	10-1	13-4	16-5	19-3	9-6	12-4	14-8	17-2
	Southern Pine #3	8-3	10-6	12-5	14-9	7-4	9-5	11-1	13-2
	Spruce-Pine-Fir	9-10	13-0	16-7	20-2	9-10	13-0	16-7	19-6
	Spruce-Pine-Fir #1	9-8	12-9	15-8	18-3	9-1	11-6	14-1	16-3
	Spruce-Pine-Fir #2	9-8	12-9	15-8	18-3	9-1	11-6	14-1	16-3
Spruce-Pine-Fir #3	7-8	9-9	11-10	13-9	6-10	8-8	10-7	12-4	
24	Douglas Fir-Larch	9-11	13-1	16-8	20-3	9-11	13-1	16-2	18-9
	Douglas Fir-Larch #1	9-7	12-4	15-0	17-5	8-8	11-0	13-5	15-7
	Douglas Fir-Larch #2	9-1	11-6	14-1	16-3	8-1	10-3	12-7	14-7
	Douglas Fir-Larch #3	6-10	8-8	10-7	12-4	6-2	7-9	9-6	11-0
	Hem-Fir	9-4	12-4	15-9	19-2	9-4	12-4	15-9	18-5
	Hem-Fir #1	9-2	12-0	14-8	17-0	8-6	10-9	13-1	15-2
	Hem-Fir #2	8-9	11-4	13-10	16-1	8-0	10-2	12-5	14-4
	Hem-Fir #3	6-10	8-8	10-7	12-4	6-2	7-9	9-6	11-0
	Southern Pine	9-9	12-10	16-5	19-11	9-9	12-10	16-5	19-11
	Southern Pine #1	9-7	12-7	16-1	19-6	9-7	12-4	14-7	17-5
	Southern Pine #2	9-4	12-4	14-8	17-2	8-6	11-0	13-1	15-5
	Southern Pine #3	7-4	9-5	11-1	13-2	6-7	8-5	9-11	11-10
	Spruce-Pine-Fir	9-2	12-1	15-5	18-9	9-2	12-1	15-0	17-5
	Spruce-Pine-Fir #1	8-11	11-6	14-1	16-3	8-1	10-3	12-7	14-7
	Spruce-Pine-Fir #2	8-11	11-6	14-1	16-3	8-1	10-3	12-7	14-7
Spruce-Pine-Fir #3	6-10	8-8	10-7	12-4	6-2	7-9	9-6	11-0	

Check sources for availability of lumber in lengths greater than 20 feet.  
 For SI: 1 inch = 25.4 mm, 1 foot = 304.8 mm, 1 pound per square foot = 47.8 N/m<sup>2</sup>.

TABLE 2308.8(2)  
**FLOOR JOIST SPANS FOR COMMON LUMBER SPECIES**  
 (Residential Living Areas, Live Load = 40 psf,  $L/\Delta = 360$ )

JOIST SPACING (inches)	DEAD LOAD = 10 psf				DEAD LOAD = 20 psf				
	2x6	2x8	2x10	2x12	2x6	2x8	2x10	2x12	
	Maximum floor joist spans (ft. - in.)								
SPECIES AND GRADE	(ft. - in.)	(ft. - in.)	(ft. - in.)	(ft. - in.)	(ft. - in.)	(ft. - in.)	(ft. - in.)	(ft. - in.)	
12	Douglas Fir-Larch SS	11-4	15-0	19-1	23-3	11-4	15-0	19-1	23-3
	Douglas Fir-Larch #1	10-11	14-5	18-5	22-0	10-11	14-2	17-4	20-1
	Douglas Fir-Larch #2	10-9	14-2	17-9	20-7	10-6	13-3	16-3	18-10
	Douglas Fir-Larch #3	8-8	11-0	13-5	15-7	7-11	10-0	12-3	14-3
	Hem-Fir SS	10-9	14-2	18-0	21-11	10-9	14-2	18-0	21-11
	Hem-Fir #1	10-6	13-10	17-8	21-6	10-6	13-10	16-11	19-7
	Hem-Fir #2	10-0	13-2	16-10	20-4	10-0	13-1	16-0	18-6
	Hem-Fir #3	8-8	11-0	13-5	15-7	7-11	10-0	12-3	14-3
	Southern Pine SS	11-2	14-8	18-9	22-10	11-2	14-8	18-9	22-10
	Southern Pine #1	10-11	14-5	18-5	22-5	10-11	14-5	18-5	22-5
	Southern Pine #2	10-9	14-2	18-0	21-9	10-9	14-2	16-11	19-10
	Southern Pine #3	9-4	11-11	14-0	16-8	8-6	10-10	12-10	15-3
16	Spruce-Pine-Fir SS	10-6	13-10	17-8	21-6	10-6	13-10	17-8	21-6
	Spruce-Pine-Fir #1	10-3	13-6	17-3	20-7	10-3	13-3	16-3	18-10
	Spruce-Pine-Fir #2	10-3	13-6	17-3	20-7	10-3	13-3	16-3	18-10
	Spruce-Pine-Fir #3	8-8	11-0	13-5	15-7	7-11	10-0	12-3	14-3
	Douglas Fir-Larch SS	10-4	13-7	17-4	21-1	10-4	13-7	17-4	21-0
	Douglas Fir-Larch #1	9-11	13-1	16-5	19-1	9-8	12-4	15-0	17-5
	Douglas Fir-Larch #2	9-9	12-7	15-5	17-10	9-1	11-6	14-1	16-3
	Douglas Fir-Larch #3	7-6	9-6	11-8	13-6	6-10	8-8	10-7	12-4
	Hem-Fir SS	9-9	12-10	16-5	19-11	9-9	12-10	16-5	19-11
	Hem-Fir #1	9-6	12-7	16-0	18-7	9-6	12-0	14-8	17-0
	Hem-Fir #2	9-1	12-0	15-2	17-7	8-11	11-4	13-10	16-1
	Hem-Fir #3	7-6	9-6	11-8	13-6	6-10	8-8	10-7	12-4
16	Southern Pine SS	10-2	13-4	17-0	20-9	10-2	13-4	17-0	20-9
	Southern Pine #1	9-11	13-1	16-9	20-4	9-11	13-1	16-4	19-6
	Southern Pine #2	9-9	12-10	16-1	18-10	9-6	12-4	14-8	17-2
	Southern Pine #3	8-1	10-3	12-2	14-6	7-4	9-5	11-1	13-2
	Spruce-Pine-Fir SS	9-6	12-7	16-0	19-6	9-6	12-7	16-0	19-6
	Spruce-Pine-Fir #1	9-4	12-3	15-5	17-10	9-1	11-6	14-1	16-3
Spruce-Pine-Fir #2	9-4	12-3	15-5	17-10	9-1	11-6	14-1	16-3	
Spruce-Pine-Fir #3	7-6	9-6	11-8	13-6	6-10	8-8	10-7	12-4	

TABLE 2308.8(2)—continued  
**FLOOR JOIST SPANS FOR COMMON LUMBER SPECIES**  
 (Residential Living Areas, Live Load = 40 psf, U<sub>L</sub> = 360)

JOIST SPACING (inches)	SPECIES AND GRADE	DEAD LOAD = 10 psf						DEAD LOAD = 20 psf									
		2x6		2x8		2x10		2x6		2x8		2x10		2x12			
		(ft. - in.)	(ft. - in.)	(ft. - in.)	(ft. - in.)	(ft. - in.)	(ft. - in.)	(ft. - in.)	(ft. - in.)	(ft. - in.)	(ft. - in.)	(ft. - in.)	(ft. - in.)	(ft. - in.)	(ft. - in.)		
19.2	Douglas Fir-Larch	SS	9-8	12-10	16-4	19-10	9-8	12-10	16-4	19-2	12-10	16-4	19-2	12-10	16-4	19-2	
	Douglas Fir-Larch	#1	9-4	12-4	15-0	17-5	8-10	11-3	13-8	15-11	11-3	13-8	15-11	11-3	13-8	15-11	
	Douglas Fir-Larch	#2	9-1	11-6	14-1	16-3	8-3	10-6	12-10	14-10	10-6	12-10	14-10	10-6	12-10	14-10	
	Douglas Fir-Larch	#3	6-10	8-8	10-7	12-4	6-3	7-11	9-8	11-3	7-11	9-8	11-3	7-11	9-8	11-3	
	Hem-Fir	SS	9-2	12-1	15-5	18-9	9-2	12-1	15-5	18-9	12-1	15-5	18-9	12-1	15-5	18-9	
	Hem-Fir	#1	9-0	11-10	14-8	17-0	8-8	10-11	13-4	15-6	10-11	13-4	15-6	10-11	13-4	15-6	
	Hem-Fir	#2	8-7	11-3	13-10	16-1	8-2	10-4	12-8	14-8	10-4	12-8	14-8	10-4	12-8	14-8	
	Hem-Fir	#3	6-10	8-8	10-7	12-4	6-3	7-11	9-8	11-3	7-11	9-8	11-3	7-11	9-8	11-3	
	Southern Pine	SS	9-6	12-7	16-0	19-6	9-6	12-7	16-0	19-6	12-7	16-0	19-6	12-7	16-0	19-6	
	Southern Pine	#1	9-4	12-4	15-9	19-2	9-4	12-4	14-11	17-9	12-4	14-11	17-9	12-4	14-11	17-9	
	Southern Pine	#2	9-2	12-1	14-8	17-2	8-8	11-3	13-5	15-8	11-3	13-5	15-8	11-3	13-5	15-8	
	Southern Pine	#3	7-4	9-5	11-1	13-2	6-9	8-7	10-1	12-1	8-7	10-1	12-1	8-7	10-1	12-1	
	Spruce-Pine-Fir	SS	9-0	11-10	15-1	18-4	9-0	11-10	15-1	18-4	11-10	15-1	18-4	11-10	15-1	18-4	
	Spruce-Pine-Fir	#1	8-9	11-6	14-1	16-3	8-3	10-6	12-10	14-10	10-6	12-10	14-10	10-6	12-10	14-10	
	Spruce-Pine-Fir	#2	8-9	11-6	14-1	16-3	8-3	10-6	12-10	14-10	10-6	12-10	14-10	10-6	12-10	14-10	
	Spruce-Pine-Fir	#3	6-10	8-8	10-7	12-4	6-3	7-11	9-8	11-3	7-11	9-8	11-3	7-11	9-8	11-3	
	24	Douglas Fir-Larch	SS	9-0	11-11	15-2	18-5	9-0	11-11	14-9	17-1	11-11	14-9	17-1	11-11	14-9	17-1
		Douglas Fir-Larch	#1	8-8	11-0	13-5	15-7	7-11	10-0	12-3	14-3	10-0	12-3	14-3	10-0	12-3	14-3
Douglas Fir-Larch		#2	8-1	10-3	12-7	14-7	7-5	9-5	11-6	13-4	9-5	11-6	13-4	9-5	11-6	13-4	
Douglas Fir-Larch		#3	6-2	7-9	9-6	11-0	5-7	7-1	8-8	10-1	7-1	8-8	10-1	7-1	8-8	10-1	
Hem-Fir		SS	8-6	11-3	14-4	17-5	8-6	11-3	14-4	16-10 <sup>a</sup>	11-3	14-4	16-10 <sup>a</sup>	11-3	14-4	16-10 <sup>a</sup>	
Hem-Fir		#1	8-4	10-9	13-1	15-2	7-9	9-9	11-11	13-10	9-9	11-11	13-10	9-9	11-11	13-10	
Hem-Fir		#2	7-11	10-2	12-5	14-4	7-4	9-3	11-4	13-1	9-3	11-4	13-1	9-3	11-4	13-1	
Hem-Fir		#3	6-2	7-9	9-6	11-0	5-7	7-1	8-8	10-1	7-1	8-8	10-1	7-1	8-8	10-1	
Southern Pine		SS	8-10	11-8	14-11	18-1	8-10	11-8	14-11	18-1	11-8	14-11	18-1	11-8	14-11	18-1	
Southern Pine		#1	8-8	11-5	14-7	17-5	8-8	11-3	13-4	15-11	11-3	13-4	15-11	11-3	13-4	15-11	
Southern Pine		#2	8-6	11-0	13-1	15-5	7-9	10-0	12-0	14-0	10-0	12-0	14-0	10-0	12-0	14-0	
Southern Pine		#3	6-7	8-5	9-11	11-10	6-0	7-8	9-1	10-9	7-8	9-1	10-9	7-8	9-1	10-9	
Spruce-Pine-Fir		SS	8-4	11-0	14-0	17-0	8-4	11-0	13-8	15-11	11-0	13-8	15-11	11-0	13-8	15-11	
Spruce-Pine-Fir		#1	8-1	10-3	12-7	14-7	7-5	9-5	11-6	13-4	9-5	11-6	13-4	9-5	11-6	13-4	
Spruce-Pine-Fir		#2	8-1	10-3	12-7	14-7	7-5	9-5	11-6	13-4	9-5	11-6	13-4	9-5	11-6	13-4	
Spruce-Pine-Fir		#3	6-2	7-9	9-6	11-0	5-7	7-1	8-8	10-1	7-1	8-8	10-1	7-1	8-8	10-1	

Check sources for availability of lumber in lengths greater than 20 feet.

For SI: 1 inch = 25.4 mm, 1 foot = 304.8 mm, 1 pound per square foot = 47.8 N/m<sup>2</sup>.

a. End bearing length shall be increased to 2 inches.

**TABLE 2308.9.1  
SIZE, HEIGHT AND SPACING OF WOOD STUDS**

STUD SIZE (inches)	BEARING WALLS				NONBEARING WALLS	
	Laterally unsupported stud height <sup>a</sup> (feet)	Supporting roof and ceiling only	Supporting one floor, roof and ceiling	Supporting two floors, roof and ceiling	Laterally unsupported stud height <sup>a</sup> (feet)	Spacing (inches)
2 × 3 <sup>b</sup>	—	—	—	—	10	16
2 × 4	10	24	16	—	14	24
3 × 4	10	24	24	16	14	24
2 × 5	10	24	24	—	16	24
2 × 6	10	24	24	16	20	24

For SI: 1 inch = 25.4 mm, 1 foot = 304.8 mm.

a. Listed heights are distances between points of lateral support placed perpendicular to the plane of the wall. Increases in unsupported height are permitted where justified by an analysis.

b. Shall not be used in exterior walls.

**TABLE 2308.9.3(1)  
BRACED WALL PANELS<sup>a</sup>**

SEISMIC DESIGN CATEGORY	CONDITION	CONSTRUCTION METHODS <sup>b,c</sup>								BRACED PANEL LOCATION AND LENGTH <sup>d</sup>
		1	2	3	4	5	6	7	8	
<b>B</b>	One story, top of two or three story	X	X	X	X	X	X	X	X	Each end and not more than 25 feet on center
	First story of two story or second story of three story	X	X	X	X	X	X	X	X	
	First story of three story	-	X	X	X	X <sup>e</sup>	X	X	X	
<b>C</b>	One story, top of two or three story	-	X	X	X	X	X	X	X	Each end and not more than 25 feet on center
	First story of two story or second story of three story	-	X	X	X	X <sup>e</sup>	X	X	X	Each end and not more than 25 feet on center but total length shall not be less than 25% of building length <sup>f</sup>
	First story of three story	-	X	X	X	X <sup>e</sup>	X	X	X	Each end and not more than 25 feet on center but total length shall not be less than 40% of building length <sup>f</sup>

For SI: 1 inch = 25.4 mm, 1 foot = 304.8 mm.

a. This table specifies minimum requirements for braced panels that form interior or exterior braced wall lines.

b. See Section 2308.9.3 for full description.

c. See Section 2308.9.3.1 for alternative braced panel requirement.

d. Building length is the dimension parallel to the braced wall length.

e. Gypsum wallboard applied to framing supports that are spaced at 16 inches on center.

f. The required lengths shall be doubled for gypsum board applied to only one face of a braced wall panel.

**TABLE 2308.9.3(2)**  
**EXPOSED PLYWOOD PANEL SIDING**

MINIMUM THICKNESS <sup>a</sup> (inch)	MINIMUM NUMBER OF PLYS	STUD SPACING (inches) Plywood siding applied directly to studs or over sheathing
$\frac{3}{8}$	3	16 <sup>b</sup>
$\frac{1}{2}$	4	24

For SI: 1 inch = 25.4 mm.

a. Thickness of grooved panels is measured at bottom of grooves.

b. Spans are permitted to be 24 inches if plywood siding applied with face grain perpendicular to studs or over one of the following: (1) 1-inch board sheathing, (2)  $\frac{7}{16}$ -inch wood structural panel sheathing or (3)  $\frac{3}{8}$ -inch wood structural panel sheathing with strength axis (which is the long direction of the panel unless otherwise marked) of sheathing perpendicular to studs.

**TABLE 2308.9.3(3)**  
**WOOD STRUCTURAL PANEL WALL SHEATHING<sup>b</sup>**  
 (Not Exposed to the Weather, Strength Axis Parallel or Perpendicular to Studs Except as Indicated Below)

MINIMUM THICKNESS (inch)	PANEL SPAN RATING	STUD SPACING (inches)		
		Siding nailed to studs	Nailable sheathing	
			Sheathing parallel to studs	Sheathing perpendicular to studs
$\frac{5}{16}$	12/0, 16/0, 20/0 Wall-16" o.c.	16	—	16
$\frac{3}{8}, \frac{15}{32}, \frac{1}{2}$	16/0, 20/0, 24/0, 32/16 Wall-24" o.c.	24	16	24
$\frac{7}{16}, \frac{15}{32}, \frac{1}{2}$	24/0, 24/16, 32/16 Wall-24" o.c.	24	24 <sup>a</sup>	24

For SI: 1 inch = 25.4 mm.

a. Plywood shall consist of four or more plies.

b. Blocking of horizontal joints shall not be required except as specified in Sections 2306.4 and 2308.12.4.

**TABLE 2308.9.3(4)**  
**ALLOWABLE SHEAR VALUES (plf) FOR WIND OR SEISMIC LOADING ON**  
**VERTICAL DIAPHRAGMS OF FIBERBOARD SHEATHING BOARD CONSTRUCTION**  
**FOR TYPE V CONSTRUCTION ONLY<sup>a, b, c, d, e, f, g, h</sup>**

THICKNESS AND GRADE	FASTENER SIZE	SHEAR VALUE (pounds per linear foot) 3-INCH NAIL SPACING AROUND PERIMETER AND 6-INCH AT INTERMEDIATE POINTS
$\frac{1}{2}$ " Structural	No. 11 gage galvanized roofing nail $1\frac{1}{2}$ " long, $\frac{7}{16}$ " head	125 <sup>a</sup>
$\frac{25}{32}$ " Structural	No. 11 gage galvanized roofing nail $1\frac{3}{4}$ " long, $\frac{7}{16}$ " head	175 <sup>a</sup>

For SI: 1 inch = 25.4 mm, 1 pound per foot = 14.5939 N/m.

a. Fiberboard sheathing diaphragms shall not be used to brace concrete or masonry walls.

b. Panel edges shall be backed with 2 inch or wider framing of Douglas fir-larch or Southern pine.

c. Fiberboard sheathing on one side only.

d. Fiberboard panels are installed with their long dimension parallel or perpendicular to studs.

e. Fasteners shall be spaced 6 inches on center along intermediate framing members.

f. For framing of other species: (1) Find specific gravity for species of lumber in AF&PA National Design Specification, and (2) Multiply the shear value from the above table by 0.82 for species with specific gravity of 0.42 or greater, or 0.65 for all other species.

g. The same values can be applied when staples are used as described in Table 2304.9.1.

h. Values are not permitted in Seismic Design Category D, E or F.

**TABLE 2308.9.3(5)**  
**ALLOWABLE SPANS FOR PARTICLEBOARD WALL SHEATHING**  
 (Not Exposed to the Weather, Long Dimension of the Panel Parallel or Perpendicular to Studs)

GRADE	THICKNESS (inch)	STUD SPACING (inches)	
		Siding nailed to studs	Sheathing under coverings specified in Section 2308.9.3 parallel or perpendicular to studs
M-S "Exterior Glue" and M-2 "Exterior Glue"	$\frac{3}{8}$	16	—
	$\frac{1}{2}$	16	16

For SI: 1 inch = 25.4 mm.

**TABLE 2308.9.3(6)  
HARDBOARD SIDING**

SIDING	MINIMUM NOMINAL THICKNESS (inch)	2 x 4 FRAMING MAXIMUM SPACING	NAIL SIZE <sup>a,b,d</sup>	NAIL SPACING	
				General	Bracing panels <sup>e</sup>
<b>1. Lap siding</b>					
Direct to studs	3/8	16" o.c.	8d	16" o.c.	Not applicable
Over sheathing	3/8	16" o.c.	10d	16" o.c.	Not applicable
<b>2. Square edge panel siding</b>					
Direct to studs	3/8	24" o.c.	6d	6" o.c. edges; 12" o.c. at intermediate supports	4" o.c. edges; 8" o.c. at intermediate supports
Over sheathing	3/8	24" o.c.	8d	6" o.c. edges; 12" o.c. at intermediate supports	4" o.c. edges; 8" o.c. at intermediate supports
<b>3. Shiplap edge panel siding</b>					
Direct to studs	3/8	16" o.c.	6d	6" o.c. edges; 12" o.c. at intermediate supports	4" o.c. edges; 8" o.c. at intermediate supports
Over sheathing	3/8	16" o.c.	8d	6" o.c. edges; 12" o.c. At intermediate supports	4" o.c. edges; 8" o.c. at intermediate supports

For SI: 1 inch = 25.4 mm.

a. Nails shall be corrosion resistant.

b. Minimum acceptable nail dimensions:

	Panel Siding (inch)	Lap Siding (inch)
Shank diameter	0.092	0.099
Head diameter	0.225	0.240

c. Where used to comply with Section 2308.9.3.

d. Nail length must accommodate the sheathing and penetrate framing 1 1/2 inches.



**TABLE 2308.9.5  
 HEADER AND GIRDER SPANS<sup>a</sup> FOR EXTERIOR BEARING WALLS  
 (Maximum Spans for Douglas Fir-Larch, Hem-Fir, Southern Pine and Spruce-Pine-Fir<sup>b</sup> and Required Number of Jack Studs)**

HEADERS SUPPORTING	SIZE	GROUND SNOW LOAD (psf) <sup>c</sup>											
		20				30				50			
		Building width <sup>c</sup> (feet)											
Span	N <sub>u</sub> <sup>d</sup>	Span	N <sub>u</sub> <sup>d</sup>	Span	N <sub>u</sub> <sup>d</sup>	Span	N <sub>u</sub> <sup>d</sup>	Span	N <sub>u</sub> <sup>d</sup>	Span	N <sub>u</sub> <sup>d</sup>	Span	N <sub>u</sub> <sup>d</sup>
Roof & Ceiling	2-2 x 4	3-6	1	3-2	1	2-10	1	3-2	1	2-9	1	2-6	1
	2-2 x 6	5-5	1	4-8	1	4-2	1	4-8	1	4-1	1	3-8	2
	2-2 x 8	6-10	1	5-11	2	5-4	2	5-11	2	5-2	2	4-7	2
	2-2 x 10	8-5	2	7-3	2	6-6	2	7-3	2	6-3	2	5-7	2
	2-2 x 12	9-9	2	8-5	2	7-6	2	8-5	2	7-3	2	6-6	2
	3-2 x 8	8-4	1	7-5	1	6-8	1	7-5	1	6-5	2	5-9	2
	3-2 x 10	10-6	1	9-1	2	8-2	2	9-1	2	7-10	2	7-0	2
	3-2 x 12	12-2	2	10-7	2	9-5	2	10-7	2	9-2	2	8-2	2
	4-2 x 8	9-2	1	8-4	1	7-8	1	8-4	1	7-5	1	6-8	1
	4-2 x 10	11-8	1	10-6	1	9-5	2	10-6	1	9-1	2	8-2	2
	4-2 x 12	14-1	1	12-2	2	10-11	2	12-2	2	10-7	2	9-5	2
	2-2 x 4	3-1	1	2-9	1	2-5	1	2-9	1	2-5	1	2-2	1
	2-2 x 6	4-6	1	4-0	1	3-7	2	4-1	1	3-7	2	3-3	2
	2-2 x 8	5-9	2	5-0	2	4-6	2	5-2	2	4-6	2	4-1	2
	2-2 x 10	7-0	2	6-2	2	5-6	2	6-4	2	5-6	2	5-0	2
2-2 x 12	8-1	2	7-1	2	6-5	2	7-4	2	6-5	2	5-9	3	
Roof Ceiling & 1 Center-Bearing Floor	3-2 x 8	7-2	1	6-3	2	5-8	2	6-5	2	5-8	2	5-1	2
	3-2 x 10	8-9	2	7-8	2	6-11	2	7-11	2	6-11	2	6-3	2
	3-2 x 12	10-2	2	8-11	2	8-0	2	9-2	2	8-0	2	7-3	2
	4-2 x 8	8-1	1	7-3	1	6-7	1	7-5	1	6-6	1	5-11	2
	4-2 x 10	10-1	1	8-10	2	8-0	2	9-1	2	8-0	2	7-2	2
	4-2 x 12	11-9	2	10-3	2	9-3	2	10-7	2	9-3	2	8-4	2
	2-2 x 4	2-8	1	2-4	1	2-1	1	2-7	1	2-3	1	2-0	1
	2-2 x 6	3-11	1	3-5	2	3-0	2	3-10	2	3-4	2	3-0	2
	2-2 x 8	5-0	2	4-4	2	3-10	2	4-10	2	4-2	2	3-9	2
	2-2 x 10	6-1	2	5-3	2	4-8	2	5-11	2	5-1	2	4-7	3
	2-2 x 12	7-1	2	6-1	3	5-5	3	6-10	2	5-11	3	5-4	3
	3-2 x 8	6-3	2	5-5	2	4-10	2	6-1	2	5-3	2	4-8	2
	3-2 x 10	7-7	2	6-7	2	5-11	2	7-5	2	6-5	2	5-9	2
	3-2 x 12	8-10	2	7-8	2	6-10	2	8-7	2	7-5	2	6-8	2
	4-2 x 8	7-2	1	6-3	2	5-7	2	7-0	1	6-1	2	5-5	2
4-2 x 10	8-9	2	7-7	2	6-10	2	8-7	2	7-5	2	6-7	2	
4-2 x 12	10-2	2	8-10	2	7-11	2	9-11	2	8-7	2	7-8	2	

**TABLE 2308.9.5—continued**  
**HEADER AND GIRDER SPANS<sup>a</sup> FOR EXTERIOR BEARING WALLS**  
**(Maximum Spans for Douglas Fir-Larch, Hem-Fir, Southern Pine and Spruce-Pine-Fir<sup>b</sup> and Required Number of Jack Studs)**

HEADERS SUPPORTING	SIZE	GROUND SNOW LOAD (psf) <sup>c</sup>															
		30				50				50							
		Building width <sup>c</sup> (feet)															
20			28			36			20			28			36		
Span	NJ <sup>d</sup>	Span	NJ <sup>d</sup>	Span	NJ <sup>d</sup>	Span	NJ <sup>d</sup>	Span	NJ <sup>d</sup>	Span	NJ <sup>d</sup>	Span	NJ <sup>d</sup>	Span	NJ <sup>d</sup>	Span	NJ <sup>d</sup>
Roof Ceiling & 2 Center-Bearing Floors	2-2 x 4	2-7	1	2-3	1	2-0	1	2-6	1	2-2	1	1-11	1	1-11	1	1-11	1
	2-2 x 6	3-9	2	3-3	2	2-11	2	3-8	2	3-2	2	2-10	2	2-10	2	2-10	2
	2-2 x 8	4-9	2	4-2	2	3-9	2	4-7	2	4-0	2	3-8	2	3-8	2	3-8	2
	2-2 x 10	5-9	2	5-1	2	4-7	2	5-8	2	4-11	2	4-5	2	4-5	2	4-5	2
	2-2 x 12	6-8	2	5-10	3	5-3	3	6-6	2	5-9	2	5-2	2	5-2	2	5-2	2
	3-2 x 8	5-11	2	5-2	2	4-8	2	5-9	2	5-1	2	4-7	2	4-7	2	4-7	2
	3-2 x 10	7-3	2	6-4	2	5-8	2	7-1	2	6-2	2	5-7	2	5-7	2	5-7	2
	3-2 x 12	8-5	2	7-4	2	6-7	2	8-2	2	7-2	2	6-5	2	6-5	2	6-5	2
	4-2 x 8	6-10	1	6-0	2	5-5	2	6-8	1	5-10	2	5-3	2	5-3	2	5-3	2
	4-2 x 10	8-4	2	7-4	2	6-7	2	8-2	2	7-2	2	6-5	2	6-5	2	6-5	2
	4-2 x 12	9-8	2	8-6	2	7-8	2	9-5	2	8-3	2	7-5	2	7-5	2	7-5	2
	2-2 x 4	2-1	1	1-8	1	1-6	1	2-0	1	1-8	1	1-5	1	1-5	1	1-5	1
	2-2 x 6	3-1	2	2-8	2	2-4	2	3-0	2	2-7	2	2-3	2	2-3	2	2-3	2
	2-2 x 8	3-10	2	3-4	2	3-0	2	3-10	2	3-4	2	2-11	2	2-11	2	2-11	2
	2-2 x 10	4-9	2	4-1	2	3-8	2	4-8	2	4-0	2	3-7	2	3-7	2	3-7	2
2-2 x 12	5-6	3	4-9	3	4-3	3	5-5	3	4-8	3	4-2	3	4-2	3	4-2	3	
3-2 x 8	4-10	2	4-2	2	3-9	2	4-9	2	4-1	2	3-8	2	3-8	2	3-8	2	
3-2 x 10	5-11	2	5-1	2	4-7	2	5-10	2	5-0	2	4-6	2	4-6	2	4-6	2	
3-2 x 12	6-10	2	5-11	3	5-4	3	6-9	2	5-10	2	5-3	3	5-3	3	5-3	3	
4-2 x 8	5-7	2	4-10	2	4-4	2	5-6	2	4-9	2	4-3	2	4-3	2	4-3	2	
4-2 x 10	6-10	2	5-11	2	5-3	2	6-9	2	5-10	2	5-2	2	5-2	2	5-2	2	
4-2 x 12	7-11	2	6-10	2	6-2	2	7-9	2	6-9	2	6-0	2	6-0	2	6-0	2	

For SI: 1 inch = 25.4 mm, 1 foot = 304.8 mm, 1 pound per square foot = 47.8 N/m<sup>2</sup>.

a. Spans are given in feet and inches (ft-in).

b. Tabulated values are for No. 2 grade lumber.

c. Building width is measured perpendicular to the ridge. For widths between those shown, spans are permitted to be interpolated.

d. NJ - Number of jack studs required to support each end. Where the number of required jack studs equals one, the header is permitted to be supported by an approved framing anchor attached to the full-height wall stud and to the header.

e. Use 30 pounds per square foot ground snow load for cases in which ground snow load is less than 30 pounds per square foot and the roof live load is equal to or less than 20 pounds per square foot.

**TABLE 2308.9.6**  
**HEADER AND GIRDER SPANS<sup>a</sup> FOR INTERIOR BEARING WALLS**  
**(Maximum Spans for Douglas Fir-Larch, Hem-Fir, Southern Pine and Spruce-Pine-Fir<sup>b</sup> and Required Number of Jack Studs)**

HEADERS AND GIRDERS SUPPORTING	SIZE	BUILDING WIDTH <sup>c</sup> (feet)					
		20		28		36	
		Span	NJ <sup>d</sup>	Span	NJ <sup>d</sup>	Span	NJ <sup>d</sup>
One Floor Only	2-2 x 4	3-1	1	2-8	1	2-5	1
	2-2 x 6	4-6	1	3-11	1	3-6	1
	2-2 x 8	5-9	1	5-0	2	4-5	2
	2-2 x 10	7-0	2	6-1	2	5-5	2
	2-2 x 12	8-1	2	7-0	2	6-3	2
	3-2 x 8	7-2	1	6-3	1	5-7	2
	3-2 x 10	8-9	1	7-7	2	6-9	2
	3-2 x 12	10-2	2	8-10	2	7-10	2
	4-2 x 8	9-0	1	7-8	1	6-9	1
	4-2 x 10	10-1	1	8-9	1	7-10	2
	4-2 x 12	11-9	1	10-2	2	9-1	2
Two Floors	2-2 x 4	2-2	1	1-10	1	1-7	1
	2-2 x 6	3-2	2	2-9	2	2-5	2
	2-2 x 8	4-1	2	3-6	2	3-2	2
	2-2 x 10	4-11	2	4-3	2	3-10	3
	2-2 x 12	5-9	2	5-0	3	4-5	3
	3-2 x 8	5-1	2	4-5	2	3-11	2
	3-2 x 10	6-2	2	5-4	2	4-10	2
	3-2 x 12	7-2	2	6-3	2	5-7	3
	4-2 x 8	6-1	1	5-3	2	4-8	2
	4-2 x 10	7-2	2	6-2	2	5-6	2
	4-2 x 12	8-4	2	7-2	2	6-5	2

For SI: 1 inch = 25.4 mm, 1 foot = 304.8 mm.

a. Spans are given in feet and inches (ft-in).

b. Tabulated values are for No. 2 grade lumber.

c. Building width is measured perpendicular to the ridge. For widths between those shown, spans are permitted to be interpolated.

d. NJ - Number of jack studs required to support each end. Where the number of required jack studs equals one, the headers are permitted to be supported by an approved framing anchor attached to the full-height wall stud and to the header.

**TABLE 2308.10.1  
REQUIRED RATING OF APPROVED UPLIFT CONNECTORS (pounds)<sup>a,b,c,e,f,g,h</sup>**

BASIC WIND SPEED (3-second gust)	ROOF SPAN (feet)							OVERHANGS (pounds/feet) <sup>d</sup>
	12	20	24	28	32	36	40	
100	-131	-281	-262	-305	-349	-393	-436	-53.36
110	-175	-292	-351	-409	-467	-526	-584	-64.56

For SI: 1 inch = 25.4 mm, 1 foot = 304.8 mm, 1 mile per hour = 1.61 km/hr, 1 pound = 0.454 Kg, 1 pound/foot = 14.5939 N/m.

- a. The uplift connection requirements are based on a 30-foot mean roof height located in Exposure B. For Exposure C or D and for other mean roof heights, multiply the above loads by the adjustment coefficients in Table 1609.6.2.1(4).
- b. The uplift connection requirements are based on the framing being spaced 24 inches on center. Multiply by 0.67 for framing spaced 16 inches on center and multiply by 0.5 for framing spaced 12 inches on center.
- c. The uplift connection requirements include an allowance for 10 pounds of dead load.
- d. The uplift connection requirements do not account for the effects of overhangs. The magnitude of the above loads shall be increased by adding the overhang loads found in the table. The overhang loads are also based on framing spaced 24 inches on center. The overhang loads given shall be multiplied by the overhang projection and added to the roof uplift value in the table.
- e. The uplift connection requirements are based upon wind loading on end zones as defined in Section 1609.6.3. Connection loads for connections located a distance of 20 percent of the least horizontal dimension of the building from the corner of the building are permitted to be reduced by multiplying the table connection value by 0.7 and multiplying the overhang load by 0.8.
- f. For wall-to-wall and wall-to-foundation connections, the capacity of the uplift connector is permitted to be reduced by 100 pounds for each full wall above. (For example, if a 500-pound rated connector is used on the roof framing, a 400-pound rated connector is permitted at the next floor level down.)
- g. Interpolation is permitted for intermediate values of basic wind speeds and roof spans.
- h. The rated capacity of approved tie-down devices is permitted to include up to a 60-percent increase for wind effects where allowed by material specifications.

TABLE 2308.10.2(1)  
**CEILING JOIST SPANS FOR COMMON LUMBER SPECIES**  
(Uninhabitable Attics Without Storage, Live Load = 10 pounds psf, L/Δ = 240)

CEILING JOIST SPACING (inches)	SPECIES AND GRADE	DEAD LOAD = 5 pounds per square foot			
		2 x 4 (ft. - in.)	2 x 6 (ft. - in.)	2 x 8 (ft. - in.)	2 x 10 (ft. - in.)
12	Douglas Fir-Larch SS	13-2	20-8	Note a	Note a
	Douglas Fir-Larch #1	12-8	19-11	Note a	Note a
	Douglas Fir-Larch #2	12-5	19-6	25-8	Note a
	Douglas Fir-Larch #3	10-10	15-10	20-1	24-6
	Hem-Fir SS	12-5	19-6	25-8	Note a
	Hem-Fir #1	12-2	19-1	25-2	Note a
	Hem-Fir #2	11-7	18-2	24-0	Note a
	Hem-Fir #3	10-10	15-10	20-1	24-6
	Southern Pine SS	12-11	20-3	Note a	Note a
	Southern Pine #1	12-8	19-11	Note a	Note a
	Southern Pine #2	12-5	19-6	25-8	Note a
	Southern Pine #3	11-6	17-0	21-8	25-7
	Spruce-Pine-Fir SS	12-2	19-1	25-2	Note a
	Spruce-Pine-Fir #1	11-10	18-8	24-7	Note a
	Spruce-Pine-Fir #2	11-10	18-8	24-7	Note a
	Spruce-Pine-Fir #3	10-10	15-10	20-1	24-6
16	Douglas Fir-Larch SS	11-11	18-9	24-8	Note a
	Douglas Fir-Larch #1	11-6	18-1	23-10	Note a
	Douglas Fir-Larch #2	11-3	17-8	23-0	Note a
	Douglas Fir-Larch #3	9-5	13-9	17-5	21-3
	Hem-Fir SS	11-3	17-8	23-4	Note a
	Hem-Fir #1	11-0	17-4	22-10	Note a
	Hem-Fir #2	10-6	16-6	21-9	Note a
	Hem-Fir #3	9-5	13-9	17-5	21-3
	Southern Pine SS	11-9	18-5	24-3	Note a
	Southern Pine #1	11-6	18-1	23-1	Note a
	Southern Pine #2	11-3	17-8	23-4	Note a
	Southern Pine #3	10-0	14-9	18-9	22-2
	Spruce-Pine-Fir SS	11-0	17-4	22-10	Note a
	Spruce-Pine-Fir #1	10-9	16-11	22-4	Note a
	Spruce-Pine-Fir #2	10-9	16-11	22-4	Note a
	Spruce-Pine-Fir #3	9-5	13-9	17-5	21-3

(continued)

TABLE 2308.10.2(1)—continued  
**CEILING JOIST SPANS FOR COMMON LUMBER SPECIES**  
(Uninhabitable Attics Without Storage, Live Load = 10 pounds psf,  $L/\Delta = 240$ )

CEILING JOIST SPACING (Inches)	SPECIES AND GRADE	DEAD LOAD = 5 pounds per square foot				
		2 x 4	2 x 6	2 x 8	2 x 10	
		(ft. - in.)	(ft. - in.)	(ft. - in.)	(ft. - in.)	
19.2	Douglas Fir-Larch SS	11-3	17-8	23-3	Note a	
	Douglas Fir-Larch #1	10-10	17-0	22-5	Note a	
	Douglas Fir-Larch #2	10-7	16-7	21-0	25-8	
	Douglas Fir-Larch #3	8-7	12-6	15-10	19-5	
	Hem-Fir SS	10-7	16-8	21-11	Note a	
	Hem-Fir #1	10-4	16-4	21-6	Note a	
	Hem-Fir #2	9-11	15-7	20-6	25-3	
	Hem-Fir #3	8-7	12-6	15-10	19-5	
	Southern Pine SS	11-0	17-4	22-10	Note a	
	Southern Pine #1	10-10	17-0	22-5	Note a	
	Southern Pine #2	10-7	16-8	21-11	Note a	
	Southern Pine #3	9-1	13-6	17-2	20-3	
	Spruce-Pine-Fir SS	10-4	16-4	21-6	Note a	
	Spruce-Pine-Fir #1	10-2	15-11	21-0	25-8	
	Spruce-Pine-Fir #2	10-2	15-11	21-0	25-8	
	Spruce-Pine-Fir #3	8-7	12-6	15-10	19-5	
	24	Douglas Fir-Larch SS	10-5	16-4	21-7	Note a
		Douglas Fir-Larch #1	10-0	15-9	20-1	24-6
		Douglas Fir-Larch #2	9-10	14-10	18-9	22-11
Douglas Fir-Larch #3		7-8	11-2	14-2	17-4	
Hem-Fir SS		9-10	15-6	20-5	Note a	
Hem-Fir #1		9-8	15-2	19-7	23-11	
Hem-Fir #2		9-2	14-5	18-6	22-7	
Hem-Fir #3		7-8	11-2	14-2	17-4	
Southern Pine SS		10-3	16-1	21-2	Note a	
Southern Pine #1		10-0	15-9	20-10	Note a	
Southern Pine #2		9-10	15-6	20-1	23-11	
Southern Pine #3		8-2	12-0	15-4	18-1	
Spruce-Pine-Fir SS		9-8	15-2	19-11	25-5	
Spruce-Pine-Fir #1		9-5	14-9	18-9	22-11	
Spruce-Pine-Fir #2		9-5	14-9	18-9	22-11	
Spruce-Pine-Fir #3		7-8	11-2	14-2	17-4	

For SI: 1 inch = 25.4 mm, 1 foot = 304.8 mm, 1 pound per square foot = 47.8 N/m<sup>2</sup>.

a. Span exceeds 26 feet in length. Check sources for availability of lumber in lengths greater than 20 feet.

TABLE 2008.10.2(2)  
**CEILING JOIST SPANS FOR COMMON LUMBER SPECIES**  
(Uninhabitable Attics With Limited Storage, Live Load = 20 pounds per square foot,  $L/\Delta = 240$ )

CEILING JOIST SPACING (Inches)	SPECIES AND GRADE	DEAD LOAD = 10 pounds per square foot			
		2 x 4 (ft. - in.)	2 x 6 (ft. - in.)	2 x 8 (ft. - in.)	2 x 10 (ft. - in.)
12	Douglas Fir-Larch SS	10-5	16-4	21-7	Note a
	Douglas Fir-Larch #1	10-0	15-9	20-1	24-6
	Douglas Fir-Larch #2	9-10	14-10	18-9	22-11
	Douglas Fir-Larch #3	7-8	11-2	14-2	17-4
	Hem-Fir SS	9-10	15-6	20-5	Note a
	Hem-Fir #1	9-8	15-2	19-7	23-11
	Hem-Fir #2	9-2	14-5	18-6	22-7
	Hem-Fir #3	7-8	11-2	14-2	17-4
	Southern Pine SS	10-3	16-1	21-2	Note a
	Southern Pine #1	10-0	15-9	20-10	Note a
	Southern Pine #2	9-10	15-6	20-1	23-11
	Southern Pine #3	8-2	12-0	15-4	18-1
	Spruce-Pine-Fir SS	9-8	15-2	19-11	25-5
	Spruce-Pine-Fir #1	9-5	14-9	18-9	22-11
	Spruce-Pine-Fir #2	9-5	14-9	18-9	22-11
	Spruce-Pine-Fir #3	7-8	11-2	14-2	17-4
	16	Douglas Fir-Larch SS	9-6	14-11	19-7
Douglas Fir-Larch #1		9-1	13-9	17-5	21-3
Douglas Fir-Larch #2		8-9	12-10	16-3	19-10
Douglas Fir-Larch #3		6-8	9-8	12-4	15-0
Hem-Fir SS		8-11	14-1	18-6	23-8
Hem-Fir #1		8-9	13-5	16-10	20-8
Hem-Fir #2		8-4	12-8	16-0	19-7
Hem-Fir #3		6-8	9-8	12-4	15-0
Southern Pine SS		9-4	14-7	19-3	24-7
Southern Pine #1		9-1	14-4	18-11	23-1
Southern Pine #2		8-11	13-6	17-5	20-9
Southern Pine #3		7-1	10-5	13-3	15-8
Spruce-Pine-Fir SS		8-9	13-9	18-1	23-1
Spruce-Pine-Fir #1		8-7	12-10	16-3	19-10
Spruce-Pine-Fir #2		8-7	12-10	16-3	19-10
Spruce-Pine-Fir #3		6-8	9-8	12-4	15-0

(continued)

TABLE 2308.10.2(2)—continued  
 CEILING JOIST SPANS FOR COMMON LUMBER SPECIES  
 (Uninhabitable Attics With Limited Storage, Live Load = 20 pounds per square foot,  $L/\Delta = 240$ )

CEILING JOIST SPACING (inches)	SPECIES AND GRADE	DEAD LOAD = 10 pounds per square foot			
		2 x 4 (ft. - in.)	2 x 6 (ft. - in.)	2 x 8 (ft. - in.)	2 x 10 (ft. - in.)
19.2	Douglas Fir-Larch SS	8-11	14-0	18-5	23-4
	Douglas Fir-Larch #1	8-7	12-6	15-10	19-5
	Douglas Fir-Larch #2	8-0	11-9	14-10	18-2
	Douglas Fir-Larch #3	6-1	8-10	11-3	13-8
	Hem-Fir SS	8-5	13-3	17-5	22-3
	Hem-Fir #1	8-3	12-3	15-6	18-11
	Hem-Fir #2	7-10	11-7	14-8	17-10
	Hem-Fir #3	6-1	8-10	11-3	13-8
	Southern Pine SS	8-9	13-9	18-1	23-1
	Southern Pine #1	8-7	13-6	17-9	21-1
	Southern Pine #2	8-5	12-3	15-10	18-11
	Southern Pine #3	6-5	9-6	12-1	14-4
	Spruce-Pine-Fir SS	8-3	12-11	17-1	21-8
	Spruce-Pine-Fir #1	8-0	11-9	14-10	18-2
	Spruce-Pine-Fir #2	8-0	11-9	14-10	18-2
	Spruce-Pine-Fir #3	6-1	8-10	11-3	13-8
	Douglas Fir-Larch SS	8-3	13-0	17-1	20-11
	Douglas Fir-Larch #1	7-8	11-2	14-2	17-4
	Douglas Fir-Larch #2	7-2	10-6	13-3	16-3
	Douglas Fir-Larch #3	5-5	7-11	10-0	12-3
24	Hem-Fir SS	7-10	12-3	16-2	20-6
	Hem-Fir #1	7-6	10-11	13-10	16-11
	Hem-Fir #2	7-1	10-4	13-1	16-0
	Hem-Fir #3	5-5	7-11	10-0	12-3
	Southern Pine SS	8-1	12-9	16-10	21-6
	Southern Pine #1	8-0	12-6	15-10	18-10
	Southern Pine #2	7-8	11-0	14-2	16-11
	Southern Pine #3	5-9	8-6	10-10	12-10
	Spruce-Pine-Fir SS	7-8	12-0	15-10	19-5
	Spruce-Pine-Fir #1	7-2	10-6	13-3	16-3
	Spruce-Pine-Fir #2	7-2	10-6	13-3	16-3
	Spruce-Pine-Fir #3	5-5	7-11	10-0	12-3

For SI: 1 inch = 25.4 mm, 1 foot = 304.8 mm, 1 pound per square foot = 47.8 N/m<sup>2</sup>.

a. Span exceeds 26 feet in length. Check sources for availability of lumber in lengths greater than 20 feet.



TABLE 2308.10.3(1)  
**RAFTER SPANS FOR COMMON LUMBER SPECIES**  
 (Roof Live Load = 20 pounds per square foot, Ceiling Not Attached to Rafters, L/Δ = 180)

RAFTER SPACING (Inches)	DEAD LOAD = 10 pounds per square foot										DEAD LOAD = 20 pounds per square foot									
	2 x 4		2 x 6		2 x 8		2 x 10		2 x 12		2 x 4		2 x 6		2 x 8		2 x 10		2 x 12	
	(ft. - in.)	(ft. - in.)	(ft. - in.)	(ft. - in.)	(ft. - in.)	(ft. - in.)	(ft. - in.)	(ft. - in.)	(ft. - in.)	(ft. - in.)	(ft. - in.)	(ft. - in.)	(ft. - in.)	(ft. - in.)	(ft. - in.)	(ft. - in.)	(ft. - in.)	(ft. - in.)	(ft. - in.)	(ft. - in.)
	SPECIES AND GRADE																			
	Douglas Fir-Larch	SS	11-6	18-0	23-9	23-9	Note a	Note a	Note a	11-6	18-0	23-5	23-5	Note a	Note a	11-6	18-0	23-5	23-5	Note a
	Douglas Fir-Larch	#1	11-1	17-4	22-5	22-5	Note a	Note a	Note a	10-6	15-4	19-5	19-5	Note a	Note a	10-6	15-4	19-5	19-5	Note a
	Douglas Fir-Larch	#2	10-10	16-7	21-0	25-8	25-8	Note a	Note a	9-10	14-4	18-2	18-2	Note a	Note a	9-10	14-4	18-2	18-2	Note a
	Douglas Fir-Larch	#3	8-7	12-6	15-10	19-5	19-5	Note a	Note a	7-5	10-10	13-9	13-9	Note a	Note a	7-5	10-10	13-9	13-9	Note a
	He m-Fir	SS	10-10	17-0	22-5	22-5	Note a	Note a	Note a	10-10	17-0	22-5	22-5	Note a	Note a	10-10	17-0	22-5	22-5	Note a
	He m-Fir	#1	10-7	16-8	21-10	25-3	25-3	Note a	Note a	10-3	14-11	18-11	18-11	Note a	Note a	10-3	14-11	18-11	18-11	Note a
	He m-Fir	#2	10-1	15-11	20-8	25-3	25-3	Note a	Note a	9-8	14-2	17-11	17-11	Note a	Note a	9-8	14-2	17-11	17-11	Note a
	He m-Fir	#3	8-7	12-6	15-10	19-5	19-5	Note a	Note a	7-5	10-10	13-9	13-9	Note a	Note a	7-5	10-10	13-9	13-9	Note a
12	Southern Pine	SS	11-3	17-8	23-4	23-4	Note a	Note a	Note a	11-3	17-8	23-4	23-4	Note a	Note a	11-3	17-8	23-4	23-4	Note a
	Southern Pine	#1	11-1	17-4	22-11	22-11	Note a	Note a	Note a	11-1	17-3	21-9	21-9	Note a	Note a	11-1	17-3	21-9	21-9	Note a
	Southern Pine	#2	10-10	17-0	22-5	22-5	Note a	Note a	Note a	10-6	15-1	19-5	19-5	Note a	Note a	10-6	15-1	19-5	19-5	Note a
	Southern Pine	#3	9-1	13-6	17-2	20-3	20-3	Note a	Note a	7-11	11-8	14-10	14-10	Note a	Note a	7-11	11-8	14-10	14-10	Note a
	Spruce-Pine-Fir	SS	10-7	16-8	21-11	25-8	25-8	Note a	Note a	10-7	16-8	21-9	21-9	Note a	Note a	10-7	16-8	21-9	21-9	Note a
	Spruce-Pine-Fir	#1	10-4	16-3	21-0	25-8	25-8	Note a	Note a	9-10	14-4	18-2	18-2	Note a	Note a	9-10	14-4	18-2	18-2	Note a
	Spruce-Pine-Fir	#2	10-4	16-3	21-0	25-8	25-8	Note a	Note a	9-10	14-4	18-2	18-2	Note a	Note a	9-10	14-4	18-2	18-2	Note a
	Spruce-Pine-Fir	#3	8-7	12-6	15-10	19-5	19-5	Note a	Note a	7-5	10-10	13-9	13-9	Note a	Note a	7-5	10-10	13-9	13-9	Note a
	Douglas Fir-Larch	SS	10-5	16-4	21-7	23-9	23-9	Note a	Note a	10-5	16-0	20-3	20-3	Note a	Note a	10-5	16-0	20-3	20-3	Note a
	Douglas Fir-Larch	#1	10-0	15-4	19-5	23-9	23-9	Note a	Note a	9-1	13-3	16-10	16-10	Note a	Note a	9-1	13-3	16-10	16-10	Note a
	Douglas Fir-Larch	#2	9-10	14-4	18-2	22-3	22-3	Note a	Note a	8-6	12-5	15-9	15-9	Note a	Note a	8-6	12-5	15-9	15-9	Note a
	Douglas Fir-Larch	#3	7-5	10-10	13-9	16-9	16-9	Note a	Note a	6-5	9-5	11-11	11-11	Note a	Note a	6-5	9-5	11-11	11-11	Note a
	He m-Fir	SS	9-10	15-6	20-5	20-5	Note a	Note a	Note a	9-10	15-6	19-11	19-11	Note a	Note a	9-10	15-6	19-11	19-11	Note a
	He m-Fir	#1	9-8	14-11	18-11	23-2	23-2	Note a	Note a	8-10	12-11	16-5	16-5	Note a	Note a	8-10	12-11	16-5	16-5	Note a
	He m-Fir	#2	9-2	14-2	17-11	21-11	21-11	Note a	Note a	8-5	12-3	15-6	15-6	Note a	Note a	8-5	12-3	15-6	15-6	Note a
	He m-Fir	#3	7-5	10-10	13-9	16-9	16-9	Note a	Note a	6-5	9-5	11-11	11-11	Note a	Note a	6-5	9-5	11-11	11-11	Note a
	Southern Pine	SS	10-3	16-1	21-2	25-10	25-10	Note a	Note a	10-3	16-1	21-2	21-2	Note a	Note a	10-3	16-1	21-2	21-2	Note a
	Southern Pine	#1	10-0	15-9	20-10	25-10	25-10	Note a	Note a	10-0	15-0	18-10	18-10	Note a	Note a	10-0	15-0	18-10	18-10	Note a
	Southern Pine	#2	9-10	15-1	19-5	23-2	23-2	Note a	Note a	9-1	13-0	16-10	16-10	Note a	Note a	9-1	13-0	16-10	16-10	Note a
	Southern Pine	#3	7-11	11-8	14-10	17-6	17-6	Note a	Note a	6-10	10-1	12-10	12-10	Note a	Note a	6-10	10-1	12-10	12-10	Note a
	Spruce-Pine-Fir	SS	9-8	15-2	19-11	25-5	25-5	Note a	Note a	9-8	14-10	18-10	18-10	Note a	Note a	9-8	14-10	18-10	18-10	Note a
	Spruce-Pine-Fir	#1	9-5	14-4	18-2	22-3	22-3	Note a	Note a	8-6	12-5	15-9	15-9	Note a	Note a	8-6	12-5	15-9	15-9	Note a
	Spruce-Pine-Fir	#2	9-5	14-4	18-2	22-3	22-3	Note a	Note a	8-6	12-5	15-9	15-9	Note a	Note a	8-6	12-5	15-9	15-9	Note a
	Spruce-Pine-Fir	#3	7-5	10-10	13-9	16-9	16-9	Note a	Note a	6-5	9-5	11-11	11-11	Note a	Note a	6-5	9-5	11-11	11-11	Note a

(continued)

TABLE 2308.10.3(1)—continued  
**RAFTER SPANS FOR COMMON LUMBER SPECIES**  
 (Roof Live Load = 20 pounds per square foot, Ceiling Not Attached to Rafters,  $L/\Delta = 180$ )

RAFTER SPACING (inches)	SPECIES AND GRADE	DEAD LOAD = 10 pounds per square foot						DEAD LOAD = 20 pounds per square foot					
		2 x 4	2 x 6	2 x 8	2 x 10	2 x 12	2 x 4	2 x 6	2 x 8	2 x 10	2 x 12		
		(ft. - in.)	(ft. - in.)	(ft. - in.)	(ft. - in.)	(ft. - in.)	(ft. - in.)	(ft. - in.)	(ft. - in.)	(ft. - in.)	(ft. - in.)	(ft. - in.)	
19.2	Douglas Fir-Larch	SS	9-10	15-5	20-4	25-11	Note a	9-10	14-7	18-6	22-7	Note a	
	Douglas Fir-Larch	#1	9-5	14-0	17-9	21-8	25-2	8-4	12-2	15-4	18-9	21-9	
	Douglas Fir-Larch	#2	8-11	13-1	16-7	20-3	23-6	7-9	11-4	14-4	17-7	20-4	
	Douglas Fir-Larch	#3	6-9	9-11	12-7	15-4	17-9	5-10	8-7	10-10	13-3	15-5	
	Hem-Fir	SS	9-3	14-7	19-2	24-6	Note a	9-3	14-4	18-2	22-3	25-9	
	Hem-Fir	#1	9-1	13-8	17-4	21-1	24-6	8-1	11-10	15-0	18-4	21-3	
	Hem-Fir	#2	8-8	12-11	16-4	20-0	23-2	7-8	11-2	14-2	17-4	20-1	
	Hem-Fir	#3	6-9	9-11	12-7	15-4	17-9	5-10	8-7	10-10	13-3	15-5	
	Southern Pine	SS	9-8	15-2	19-11	25-5	Note a	9-8	15-2	19-11	25-5	Note a	
	Southern Pine	#1	9-5	14-10	19-7	23-7	Note a	9-3	13-8	17-2	20-5	24-4	
	Southern Pine	#2	9-3	13-9	17-9	21-2	24-10	8-4	11-11	15-4	18-4	21-6	
	Southern Pine	#3	7-3	10-8	13-7	16-0	19-1	6-3	9-3	11-9	13-10	16-6	
	Spruce-Pine-Fir	SS	9-1	14-3	18-9	23-11	Note a	9-1	13-7	17-2	21-0	24-4	
	Spruce-Pine-Fir	#1	8-10	13-1	16-7	20-3	23-6	7-9	11-4	14-4	17-7	20-4	
	Spruce-Pine-Fir	#2	8-10	13-1	16-7	20-3	23-6	7-9	11-4	14-4	17-7	20-4	
	Spruce-Pine-Fir	#3	6-9	9-11	12-7	15-4	17-9	5-10	8-7	10-10	13-3	15-5	
	24	Douglas Fir-Larch	SS	9-1	14-4	18-10	23-4	Note b	8-11	13-1	16-7	20-3	23-5
		Douglas Fir-Larch	#1	8-7	12-6	15-10	19-5	22-6	7-5	10-10	13-9	16-9	19-6
		Douglas Fir-Larch	#2	8-0	11-9	14-10	18-2	21-0	6-11	10-2	12-10	15-8	18-3
Douglas Fir-Larch		#3	6-1	8-10	11-3	13-8	15-11	5-3	7-8	9-9	11-10	13-9	
Hem-Fir		SS	8-7	13-6	17-10	22-9	Note b	8-7	12-10	16-3	19-10	23-0	
Hem-Fir		#1	8-4	12-3	15-6	18-11	21-11	7-3	10-7	13-5	16-4	19-0	
Hem-Fir		#2	7-11	11-7	14-8	17-10	20-9	6-10	10-0	12-8	15-6	17-11	
Hem-Fir		#3	6-1	8-10	11-3	13-8	15-11	5-3	7-8	9-9	11-10	13-9	
Southern Pine		SS	8-11	14-1	18-6	23-8	Note b	8-11	14-1	18-6	22-11	Note a	
Southern Pine		#1	8-9	13-9	17-9	21-1	25-2	8-3	12-3	15-4	18-3	21-9	
Southern Pine		#2	8-7	12-3	15-10	18-11	22-2	7-5	10-8	13-9	16-5	19-3	
Southern Pine		#3	6-5	9-6	12-1	14-4	17-1	5-7	8-3	10-6	12-5	14-9	
Spruce-Pine-Fir		SS	8-5	13-3	17-5	21-8	25-2	8-4	12-2	15-4	18-9	21-9	
Spruce-Pine-Fir		#1	8-0	11-9	14-10	18-2	21-0	6-11	10-2	12-10	15-8	18-3	
Spruce-Pine-Fir		#2	8-0	11-9	14-10	18-2	21-0	6-11	10-2	12-10	15-8	18-3	
Spruce-Pine-Fir		#3	6-1	8-10	11-3	13-8	15-11	5-3	7-8	9-9	11-10	13-9	

For SI: 1 inch = 25.4 mm, 1 foot = 304.8 mm, 1 pound per square foot = 47.9 N/m<sup>2</sup>.  
 a. Span exceeds 2.6 feet in length. Check sources for availability of lumber in lengths greater than 20 feet.

TABLE 2308.10.3(2)  
**RAFTER SPANS FOR COMMON LUMBER SPECIES**  
 (Roof Live Load = 20 pounds per square foot, Ceiling Not Attached to Rafters,  $L/\Delta = 240$ )

RAFTER SPACING (inches)	SPECIES AND GRADE	DEAD LOAD = 10 pounds per square foot								DEAD LOAD = 20 pounds per square foot										
		2 x 4	2 x 6	2 x 8	2 x 10	2 x 12	2 x 4	2 x 6	2 x 8	2 x 10	2 x 12	2 x 4	2 x 6	2 x 8	2 x 10	2 x 12				
		(ft. - in.)	(ft. - in.)	(ft. - in.)	(ft. - in.)	(ft. - in.)	(ft. - in.)	(ft. - in.)	(ft. - in.)	(ft. - in.)	(ft. - in.)	(ft. - in.)	(ft. - in.)	(ft. - in.)	(ft. - in.)	(ft. - in.)	(ft. - in.)			
12	Douglas Fir-Larch	10-5	16-4	21-7	Note a	Note a	10-5	16-4	21-7	Note a	10-5	16-4	21-7	Note a	10-5	16-4	21-7	Note a		
	Douglas Fir-Larch	#1	10-0	15-9	20-10	Note a	10-0	15-4	19-5	23-9	Note a	10-0	15-4	19-5	23-9	Note a	10-0	15-4	19-5	
	Douglas Fir-Larch	#2	9-10	15-6	20-5	25-8	Note a	9-10	14-4	18-2	22-3	Note a	9-10	14-4	18-2	22-3	Note a	9-10	14-4	18-2
	Douglas Fir-Larch	#3	8-7	12-6	15-10	19-5	22-6	Note a	8-7	13-9	16-9	Note a	8-7	13-9	16-9	Note a	8-7	13-9	16-9	Note a
	Hem-Fir	SS	9-10	15-6	20-5	Note a	Note a	9-10	15-6	20-5	Note a	9-10	15-6	20-5	Note a	9-10	15-6	20-5	Note a	9-10
	Hem-Fir	#1	9-8	15-2	19-11	25-5	Note a	9-8	14-11	18-11	23-2	Note a	9-8	14-11	18-11	23-2	Note a	9-8	14-11	18-11
	Hem-Fir	#2	9-2	14-5	19-0	24-3	Note a	9-2	14-2	17-11	21-11	Note a	9-2	14-2	17-11	21-11	Note a	9-2	14-2	17-11
	Hem-Fir	#3	8-7	12-6	15-10	19-5	22-6	Note a	8-7	13-9	16-9	Note a	8-7	13-9	16-9	Note a	8-7	13-9	16-9	Note a
	Southern Pine	SS	10-3	16-1	21-2	Note a	Note a	10-3	16-1	21-2	Note a	10-3	16-1	21-2	Note a	10-3	16-1	21-2	Note a	10-3
	Southern Pine	#1	10-0	15-9	20-10	Note a	Note a	10-0	15-9	20-10	Note a	10-0	15-9	20-10	Note a	10-0	15-9	20-10	Note a	10-0
	Southern Pine	#2	9-10	15-6	20-5	Note a	Note a	9-10	15-1	19-5	23-2	Note a	9-10	15-1	19-5	23-2	Note a	9-10	15-1	19-5
	Southern Pine	#3	9-1	13-6	17-2	20-3	24-1	Note a	9-1	11-8	14-10	Note a	9-1	11-8	14-10	Note a	9-1	11-8	14-10	Note a
	Spruce-Pine-Fir	SS	9-8	15-2	19-11	25-5	Note a	9-8	15-2	19-11	25-5	Note a	9-8	15-2	19-11	25-5	Note a	9-8	15-2	19-11
Spruce-Pine-Fir	#1	9-5	14-9	19-6	24-10	Note a	9-5	14-4	18-2	22-3	Note a	9-5	14-4	18-2	22-3	Note a	9-5	14-4	18-2	
Spruce-Pine-Fir	#2	9-5	14-9	19-6	24-10	Note a	9-5	14-4	18-2	22-3	Note a	9-5	14-4	18-2	22-3	Note a	9-5	14-4	18-2	
Spruce-Pine-Fir	#3	8-7	12-6	15-10	19-5	22-6	Note a	8-7	13-9	16-9	Note a	8-7	13-9	16-9	Note a	8-7	13-9	16-9	Note a	
16	Douglas Fir-Larch	SS	9-6	14-11	19-7	25-0	Note a	9-6	14-11	19-7	Note a	9-6	14-11	19-7	Note a	9-6	14-11	19-7	Note a	
	Douglas Fir-Larch	#1	9-1	14-4	18-11	23-9	Note a	9-1	13-3	16-10	Note a	9-1	13-3	16-10	Note a	9-1	13-3	16-10	Note a	
	Douglas Fir-Larch	#2	8-11	14-1	18-2	22-3	25-9	Note a	8-6	12-5	15-9	Note a	8-6	12-5	15-9	Note a	8-6	12-5	15-9	
	Douglas Fir-Larch	#3	7-5	10-10	13-9	16-9	19-6	Note a	6-5	9-5	11-11	Note a	6-5	9-5	11-11	Note a	6-5	9-5	11-11	
	Hem-Fir	SS	8-11	14-1	18-6	23-8	Note a	8-11	14-1	18-6	23-8	Note a	8-11	14-1	18-6	23-8	Note a	8-11	14-1	18-6
	Hem-Fir	#1	8-9	13-9	18-1	23-1	Note a	8-9	12-11	16-5	20-0	Note a	8-9	12-11	16-5	20-0	Note a	8-9	12-11	16-5
	Hem-Fir	#2	8-4	13-1	17-3	21-11	25-5	Note a	8-4	12-3	15-6	Note a	8-4	12-3	15-6	Note a	8-4	12-3	15-6	
	Hem-Fir	#3	7-5	10-10	13-9	16-9	19-6	Note a	6-5	9-5	11-11	Note a	6-5	9-5	11-11	Note a	6-5	9-5	11-11	
	Southern Pine	SS	9-4	14-7	19-3	24-7	Note a	9-4	14-7	19-3	24-7	Note a	9-4	14-7	19-3	24-7	Note a	9-4	14-7	19-3
	Southern Pine	#1	9-1	14-4	18-11	24-1	Note a	9-1	14-4	18-10	22-4	Note a	9-1	14-4	18-10	22-4	Note a	9-1	14-4	18-10
	Southern Pine	#2	8-11	14-1	18-6	23-2	Note a	8-11	13-0	16-10	20-1	Note a	8-11	13-0	16-10	20-1	Note a	8-11	13-0	16-10
	Southern Pine	#3	7-11	11-8	14-10	17-6	20-11	Note a	6-10	10-1	12-10	Note a	6-10	10-1	12-10	Note a	6-10	10-1	12-10	
	Spruce-Pine-Fir	SS	8-9	13-9	18-1	23-1	Note a	8-9	13-9	18-1	23-0	Note a	8-9	13-9	18-1	23-0	Note a	8-9	13-9	18-1
Spruce-Pine-Fir	#1	8-7	13-5	17-9	22-3	25-9	Note a	8-6	12-5	15-9	Note a	8-6	12-5	15-9	Note a	8-6	12-5	15-9		
Spruce-Pine-Fir	#2	8-7	13-5	17-9	22-3	25-9	Note a	8-6	12-5	15-9	Note a	8-6	12-5	15-9	Note a	8-6	12-5	15-9		
Spruce-Pine-Fir	#3	7-5	10-10	13-9	16-9	19-6	Note a	6-5	9-5	11-11	Note a	6-5	9-5	11-11	Note a	6-5	9-5	11-11		

(continued)

TABLE 2308.10.3(2)—continued  
**RAFTER SPANS FOR COMMON LUMBER SPECIES**  
 (Roof Live Load = 20 pounds per square foot, Ceiling Not Attached to Rafters,  $L/\Delta = 240$ )

RAFTER SPACING (inches)	SPECIES AND GRADE	DEAD LOAD = 10 pounds per square foot						DEAD LOAD = 20 pounds per square foot					
		2 x 4	2 x 6	2 x 8	2 x 10	2 x 12	2 x 4	2 x 6	2 x 8	2 x 10	2 x 12		
		(ft. - in.)	(ft. - in.)	(ft. - in.)	(ft. - in.)	(ft. - in.)	(ft. - in.)	(ft. - in.)	(ft. - in.)	(ft. - in.)	(ft. - in.)		
19.2	Douglas Fir-Larch	SS	8-11	14-0	18-5	23-7	Note a	8-11	14-0	18-5	22-7	Note a	
	Douglas Fir-Larch	#1	8-7	13-6	17-9	21-8	25-2	8-4	12-2	15-4	18-9	21-9	
	Douglas Fir-Larch	#2	8-5	13-1	16-7	20-3	23-6	7-9	11-4	14-4	17-7	20-4	
	Douglas Fir-Larch	#3	6-9	9-11	12-7	15-4	17-9	5-10	8-7	10-10	13-3	15-5	
	Hem-Fir	SS	8-5	13-3	17-5	22-3	Note a	8-5	13-3	17-5	22-3	25-9	
	Hem-Fir	#1	8-3	12-11	17-1	21-1	24-6	8-1	11-10	15-0	18-4	21-3	
	Hem-Fir	#2	7-10	12-4	16-3	20-0	23-2	7-8	11-2	14-2	17-4	20-1	
	Hem-Fir	#3	6-9	9-11	12-7	15-4	17-9	5-10	8-7	10-10	13-3	15-5	
	Southern Pine	SS	8-9	13-9	18-1	23-1	Note a	8-9	13-9	18-1	23-1	Note a	
	Southern Pine	#1	8-7	13-6	17-9	22-8	Note a	8-7	13-6	17-2	20-5	24-4	
	Southern Pine	#2	8-5	13-3	17-5	21-2	24-10	8-4	11-11	15-4	18-4	21-6	
	Southern Pine	#3	7-3	10-8	13-7	16-0	19-1	6-3	9-3	11-9	13-10	16-6	
	Spruce-Pine-Fir	SS	8-3	12-11	17-1	21-9	Note a	8-3	12-11	17-1	21-0	24-4	
	Spruce-Pine-Fir	#1	8-1	12-8	16-7	20-3	23-6	7-9	11-4	14-4	17-7	20-4	
	Spruce-Pine-Fir	#2	8-1	12-8	16-7	20-3	23-6	7-9	11-4	14-4	17-7	20-4	
	Spruce-Pine-Fir	#3	6-9	9-11	12-7	15-4	17-9	5-10	8-7	10-10	13-3	15-5	
	24	Douglas Fir-Larch	SS	8-3	13-0	17-2	21-10	Note a	8-3	13-0	16-7	20-3	23-5
		Douglas Fir-Larch	#1	8-0	12-6	15-10	19-5	22-6	7-5	10-10	13-9	16-9	19-6
		Douglas Fir-Larch	#2	7-10	11-9	14-10	18-2	21-0	6-11	10-2	12-10	15-8	18-3
Douglas Fir-Larch		#3	6-1	8-10	11-3	13-8	15-11	5-3	7-8	9-9	11-10	13-9	
Hem-Fir		SS	7-10	12-3	16-2	20-8	25-1	7-10	12-3	16-2	19-10	23-0	
Hem-Fir		#1	7-8	12-0	15-6	18-11	21-11	7-3	10-7	13-5	16-4	19-0	
Hem-Fir		#2	7-3	11-5	14-8	17-10	20-9	6-10	10-0	12-8	15-6	17-11	
Hem-Fir		#3	6-1	8-10	11-3	13-8	15-11	5-3	7-8	9-9	11-10	13-9	
Southern Pine		SS	8-1	12-9	16-10	21-6	Note a	8-1	12-9	16-10	21-6	Note a	
Southern Pine		#1	8-0	12-6	16-6	21-1	25-2	8-0	12-3	15-4	18-3	21-9	
Southern Pine		#2	7-10	12-3	15-10	18-11	22-2	7-5	10-8	13-9	16-5	19-3	
Southern Pine		#3	6-5	9-6	12-1	14-4	17-1	5-7	8-3	10-6	12-5	14-9	
Spruce-Pine-Fir		SS	7-8	12-0	15-10	20-2	24-7	7-8	12-0	15-4	18-9	21-9	
Spruce-Pine-Fir		#1	7-6	11-9	14-10	18-2	21-0	6-11	10-2	12-10	15-8	18-3	
Spruce-Pine-Fir		#2	7-6	11-9	14-10	18-2	21-0	6-11	10-2	12-10	15-8	18-3	
Spruce-Pine-Fir		#3	6-1	8-10	11-3	13-8	15-11	5-3	7-8	9-9	11-10	13-9	

For SI: 1 inch = 25.4 mm, 1 foot = 304.8 mm, 1 pound per square foot = 47.9 N/m<sup>2</sup>.  
 a. Span exceeds 26 feet in length. Check sources for availability of lumber in lengths greater than 20 feet.

TABLE 2308.10.3(3)  
**RAFTER SPANS FOR COMMON LUMBER SPECIES**  
 (Ground Snow Load = 30 pounds per square foot, Ceiling Not Attached to Rafters, L/Δ = 180)

RAFTER SPACING (inches)	SPECIES AND GRADE	DEAD LOAD = 10 pounds per square foot						DEAD LOAD = 20 pounds per square foot					
		2 x 4	2 x 6	2 x 8	2 x 10	2 x 12	2 x 4	2 x 6	2 x 8	2 x 10	2 x 12		
		(ft. - in.)	(ft. - in.)	(ft. - in.)	(ft. - in.)	(ft. - in.)	(ft. - in.)	(ft. - in.)	(ft. - in.)	(ft. - in.)	(ft. - in.)	(ft. - in.)	
12	Douglas Fir-Larch SS #1	10-0	15-9	20-9	Note a	Note a	10-0	15-9	20-1	24-6	Note a		
	Douglas Fir-Larch #2	9-8	14-9	18-8	22-9	Note a	9-0	13-2	16-8	20-4	23-7		
	Douglas Fir-Larch #3	9-5	13-9	17-5	21-4	24-8	8-5	12-4	15-7	19-1	22-1		
	Douglas Fir-Larch Hem-Fir SS	7-1	10-5	13-2	16-1	18-8	6-4	9-4	11-9	14-5	16-8		
	Hem-Fir #1	9-6	14-10	19-7	25-0	Note a	9-6	14-10	19-7	24-1	Note a		
	Hem-Fir #2	9-3	14-4	18-2	22-2	25-9	8-9	12-10	16-3	19-10	23-0		
	Hem-Fir #3	8-10	13-7	17-2	21-0	24-4	8-4	12-2	15-4	18-9	21-9		
	Hem-Fir Southern Pine SS	9-10	15-6	20-5	Note a	Note a	9-10	15-6	20-5	Note a	Note a		
	Southern Pine #1	9-8	15-2	20-0	24-9	Note a	9-8	14-10	18-8	22-2	Note a		
	Southern Pine #2	9-6	14-5	18-8	22-3	Note a	9-0	12-11	16-8	19-11	23-4		
	Southern Pine #3	7-7	11-2	14-3	16-10	20-0	6-9	10-0	12-9	15-1	17-11		
	Spruce-Pine-Fir SS	9-3	14-7	19-2	24-6	Note a	9-3	14-7	18-8	22-9	Note a		
	Spruce-Pine-Fir #1	9-1	13-9	17-5	21-4	24-8	8-5	12-4	15-7	19-1	22-1		
	Spruce-Pine-Fir #2	9-1	13-9	17-5	21-4	24-8	8-5	12-4	15-7	19-1	22-1		
	Spruce-Pine-Fir #3	7-1	10-5	13-2	16-1	18-8	6-4	9-4	11-9	14-5	16-8		
	16	Douglas Fir-Larch SS	9-1	14-4	18-10	23-9	Note a	9-1	13-9	17-5	21-3	24-8	
Douglas Fir-Larch #1		8-9	12-9	16-2	19-9	22-10	7-10	11-5	14-5	17-8	20-5		
Douglas Fir-Larch #2		8-2	11-11	15-1	18-5	21-5	7-3	10-8	13-6	16-6	19-2		
Douglas Fir-Larch #3		6-2	9-0	11-5	13-11	16-2	5-6	8-1	10-3	12-6	14-6		
Hem-Fir SS		8-7	13-6	17-10	22-9	Note a	8-7	13-6	17-1	20-10	24-2		
Hem-Fir #1		8-5	12-5	15-9	19-3	22-3	7-7	11-1	14-1	17-2	19-11		
Hem-Fir #2		8-0	11-9	14-11	18-2	21-1	7-2	10-6	13-4	16-3	18-10		
Hem-Fir #3		6-2	9-0	11-5	13-11	16-2	5-6	8-1	10-3	12-6	14-6		
Southern Pine SS		8-11	14-1	18-6	23-8	Note a	8-11	14-1	18-6	23-8	Note a		
Southern Pine #1		8-9	13-9	18-1	21-5	25-7	8-8	12-10	16-2	19-2	22-10		
Southern Pine #2		8-7	12-6	16-2	19-3	22-7	7-10	11-2	14-5	17-3	20-2		
Southern Pine #3		6-7	9-8	12-4	14-7	17-4	5-10	8-8	11-0	13-0	15-6		
Spruce-Pine-Fir SS		8-5	13-3	17-5	22-1	25-7	8-5	12-9	16-2	19-9	22-10		
Spruce-Pine-Fir #1		8-2	11-11	15-1	18-5	21-5	7-3	10-8	13-6	16-6	19-2		
Spruce-Pine-Fir #2		8-2	11-11	15-1	18-5	21-5	7-3	10-8	13-6	16-6	19-2		
Spruce-Pine-Fir #3		6-2	9-0	11-5	13-11	16-2	5-6	8-1	10-3	12-6	14-6		

(continued)

TABLE 2308.10.3(3)—continued  
**RAFTER SPANS FOR COMMON LUMBER SPECIES**  
 (Ground Snow Load = 30 pounds per square foot, Ceiling Not Attached to Rafters,  $L/\Delta = 180$ )

RAFTER SPACING (inches)	SPECIES AND GRADE	DEAD LOAD = 10 pounds per square foot						DEAD LOAD = 20 pounds per square foot					
		2 x 4	2 x 6	2 x 8	2 x 10	2 x 12	2 x 4	2 x 6	2 x 8	2 x 10	2 x 12		
		(ft. - in.)	(ft. - in.)	(ft. - in.)	(ft. - in.)	(ft. - in.)	(ft. - in.)	(ft. - in.)	(ft. - in.)	(ft. - in.)	(ft. - in.)		
19.2	Douglas Fir-Larch #1	8-7	13-6	17-9	21-8	25-2	8-7	12-6	15-10	19-5	22-6		
	Douglas Fir-Larch #2	7-5	10-11	13-9	16-10	19-6	6-8	9-9	12-4	15-1	17-6		
	Douglas Fir-Larch #3	5-7	8-3	10-5	12-9	14-9	5-0	7-4	9-4	11-5	13-2		
	Hem-Fir #1	8-1	12-9	16-9	21-4	24-8	8-1	12-4	15-7	19-1	22-1		
	Hem-Fir #2	7-9	11-4	14-4	17-7	20-4	6-11	10-2	12-10	15-8	18-2		
	Hem-Fir #3	5-7	8-3	10-5	12-9	14-9	5-0	7-4	9-4	11-5	13-2		
	Southern Pine	8-5	13-3	17-5	22-3	Note a	8-5	13-3	17-5	22-0	25-9		
	Southern Pine #1	8-3	13-0	16-6	19-7	23-4	7-11	11-9	14-9	17-6	20-11		
	Southern Pine #2	7-11	11-5	14-9	17-7	20-7	7-1	10-2	13-2	15-9	18-5		
	Southern Pine #3	6-0	8-10	11-3	13-4	15-10	5-4	7-11	10-1	11-11	14-2		
	Spruce-Pine-Fir	7-11	12-5	16-5	20-2	23-4	7-11	11-8	14-9	18-0	20-11		
	Spruce-Pine-Fir #1	7-5	10-11	13-9	16-10	19-6	6-8	9-9	12-4	15-1	17-6		
	Spruce-Pine-Fir #2	7-5	10-11	13-9	16-10	19-6	6-8	9-9	12-4	15-1	17-6		
	Spruce-Pine-Fir #3	5-7	8-3	10-5	12-9	14-9	5-0	7-4	9-4	11-5	13-2		
	Douglas Fir-Larch	7-11	12-6	15-10	19-5	22-6	7-8	11-3	14-2	17-4	20-1		
	Douglas Fir-Larch #1	7-1	10-5	13-2	16-1	18-8	6-4	9-4	11-9	14-5	16-8		
	Douglas Fir-Larch #2	6-8	9-9	12-4	15-1	17-6	5-11	8-8	11-0	13-6	15-7		
	Douglas Fir-Larch #3	5-0	7-4	9-4	11-5	13-2	4-6	6-7	8-4	10-2	11-10		
	Hem-Fir	7-6	11-10	15-7	19-1	22-1	7-6	11-0	13-11	17-0	19-9		
Hem-Fir #1	6-11	10-2	12-10	15-8	18-2	6-2	9-1	11-6	14-0	16-3			
Hem-Fir #2	6-7	9-7	12-2	14-10	17-3	5-10	8-7	10-10	13-3	15-5			
Hem-Fir #3	5-0	7-4	9-4	11-5	13-2	4-6	6-7	8-4	10-2	11-10			
Southern Pine	7-10	12-3	16-2	20-8	25-1	7-10	12-3	16-2	19-8	23-0			
Southern Pine #1	7-8	11-9	14-9	17-6	20-11	7-1	10-6	13-2	15-8	18-8			
Southern Pine #2	7-1	10-2	13-2	15-9	18-5	6-4	9-2	11-9	14-1	16-6			
Southern Pine #3	5-4	7-11	10-1	11-11	14-2	4-9	7-1	9-0	10-8	12-8			
Spruce-Pine-Fir	7-4	11-7	14-9	18-0	20-11	7-1	10-5	13-2	16-1	18-8			
Spruce-Pine-Fir #1	6-8	9-9	12-4	15-1	17-6	5-11	8-8	11-0	13-6	15-7			
Spruce-Pine-Fir #2	6-8	9-9	12-4	15-1	17-6	5-11	8-8	11-0	13-6	15-7			
Spruce-Pine-Fir #3	5-0	7-4	9-4	11-5	13-2	4-6	6-7	8-4	10-2	11-10			

For SI: 1 inch = 25.4 mm, 1 foot = 304.8 mm, 1 pound per square foot = 47.9 N/m<sup>2</sup>.  
 a. Span exceeds 26 feet in length. Check sources for availability of lumber in lengths greater than 20 feet.

TABLE 2308.10.3(4)  
**RAFTER SPANS FOR COMMON LUMBER SPECIES**  
 (Ground Snow Load = 50 pounds per square foot, Ceiling Not Attached to Rafters, L/A = 180)

RAFTER SPACING (inches)	SPECIES AND GRADE	DEAD LOAD = 10 pounds per square foot						DEAD LOAD = 20 pounds per square foot										
		2 x 4	2 x 6	2 x 8	2 x 10	2 x 12	2 x 4	2 x 6	2 x 8	2 x 10	2 x 12	2 x 4	2 x 6	2 x 8	2 x 10	2 x 12		
		(ft. - in.)	(ft. - in.)	(ft. - in.)	(ft. - in.)	(ft. - in.)	(ft. - in.)	(ft. - in.)	(ft. - in.)	(ft. - in.)	(ft. - in.)	(ft. - in.)	(ft. - in.)	(ft. - in.)	(ft. - in.)	(ft. - in.)	(ft. - in.)	
12	Douglas Fir-Larch	SS	8-5	13-3	17-6	22-4	26-0	8-5	13-3	17-0	20-9	24-10	8-5	13-3	17-0	20-9	24-10	
	Douglas Fir-Larch	#1	8-2	12-0	15-3	18-7	21-7	7-7	11-2	14-1	17-3	20-0	7-7	11-2	14-1	17-3	20-0	
	Douglas Fir-Larch	#2	7-8	11-3	14-3	17-5	20-2	7-1	10-5	13-2	16-1	18-8	7-1	10-5	13-2	16-1	18-8	
	Douglas Fir-Larch	#3	5-10	8-6	10-9	13-2	15-3	5-5	7-10	10-0	12-2	14-1	5-5	7-10	10-0	12-2	14-1	
	He m-Fir	SS	8-0	12-6	16-6	21-1	25-6	8-0	12-6	16-6	20-4	23-7	8-0	12-6	16-6	20-4	23-7	
	He m-Fir	#1	7-10	11-9	14-10	18-1	21-0	7-5	10-10	13-9	16-9	19-5	7-5	10-10	13-9	16-9	19-5	
	He m-Fir	#2	7-5	11-1	14-0	17-2	19-11	7-0	10-3	13-0	15-10	18-5	7-0	10-3	13-0	15-10	18-5	
	He m-Fir	#3	5-10	8-6	10-9	13-2	15-3	5-5	7-10	10-0	12-2	14-1	5-5	7-10	10-0	12-2	14-1	
	Southern Pine	SS	8-4	13-0	17-2	21-11	Note a	8-4	13-0	17-2	21-11	Note a	8-4	13-0	17-2	21-11	Note a	
	Southern Pine	#1	8-2	12-10	16-10	20-3	24-1	8-2	12-6	15-9	18-9	22-4	8-2	12-6	15-9	18-9	22-4	
	Southern Pine	#2	8-0	11-9	15-3	18-2	21-3	7-7	10-11	14-1	16-10	19-9	7-7	10-11	14-1	16-10	19-9	
	Southern Pine	#3	6-2	9-2	11-8	13-9	16-4	5-9	8-5	10-9	12-9	15-2	5-9	8-5	10-9	12-9	15-2	
	Spruce-Pine-Fir	SS	7-10	12-3	16-2	20-8	24-1	7-10	12-3	15-9	19-3	22-4	7-10	12-3	15-9	19-3	22-4	
	Spruce-Pine-Fir	#1	7-8	11-3	14-3	17-5	20-2	7-1	10-5	13-2	16-1	18-8	7-1	10-5	13-2	16-1	18-8	
	Spruce-Pine-Fir	#2	7-8	11-3	14-3	17-5	20-2	7-1	10-5	13-2	16-1	18-8	7-1	10-5	13-2	16-1	18-8	
	Spruce-Pine-Fir	#3	5-10	8-6	10-9	13-2	15-3	5-5	7-10	10-0	12-2	14-1	5-5	7-10	10-0	12-2	14-1	
	16	Douglas Fir-Larch	SS	7-8	12-1	15-10	19-5	22-6	7-8	11-7	14-8	17-11	20-10	7-8	11-7	14-8	17-11	20-10
		Douglas Fir-Larch	#1	7-1	10-5	13-2	16-1	18-8	6-7	9-8	12-2	14-11	17-3	6-7	9-8	12-2	14-11	17-3
Douglas Fir-Larch		#2	6-8	9-9	12-4	15-1	17-6	6-2	9-0	11-5	13-11	16-2	6-2	9-0	11-5	13-11	16-2	
Douglas Fir-Larch		#3	5-0	7-4	9-4	11-5	13-2	4-8	6-10	8-8	10-6	12-3	4-8	6-10	8-8	10-6	12-3	
He m-Fir		SS	7-3	11-5	15-0	19-1	22-1	7-3	11-5	14-5	17-8	20-5	7-3	11-5	14-5	17-8	20-5	
He m-Fir		#1	6-11	10-2	12-10	15-8	18-2	6-5	9-5	11-11	14-6	16-10	6-5	9-5	11-11	14-6	16-10	
He m-Fir		#2	6-7	9-7	12-2	14-10	17-3	6-1	8-11	11-3	13-9	15-11	6-1	8-11	11-3	13-9	15-11	
He m-Fir		#3	5-0	7-4	9-4	11-5	13-2	4-8	6-10	8-8	10-6	12-3	4-8	6-10	8-8	10-6	12-3	
Southern Pine		SS	7-6	11-10	15-7	19-11	24-3	7-6	11-10	15-7	19-11	23-10	7-6	11-10	15-7	19-11	23-10	
Southern Pine		#1	7-5	11-7	14-9	17-6	20-11	7-4	10-10	13-8	16-2	19-4	7-4	10-10	13-8	16-2	19-4	
Southern Pine		#2	7-1	10-2	13-2	15-9	18-5	6-7	9-5	12-2	14-7	17-1	6-7	9-5	12-2	14-7	17-1	
Southern Pine		#3	5-4	7-11	10-1	11-11	14-2	4-11	7-4	9-4	11-0	13-1	4-11	7-4	9-4	11-0	13-1	
Spruce-Pine-Fir		SS	7-1	11-2	14-8	18-0	20-11	7-1	10-9	13-8	16-8	19-4	7-1	10-9	13-8	16-8	19-4	
Spruce-Pine-Fir		#1	6-8	9-9	12-4	15-1	17-6	6-2	9-0	11-5	13-11	16-2	6-2	9-0	11-5	13-11	16-2	
Spruce-Pine-Fir		#2	6-8	9-9	12-4	15-1	17-6	6-2	9-0	11-5	13-11	16-2	6-2	9-0	11-5	13-11	16-2	
Spruce-Pine-Fir		#3	5-0	7-4	9-4	11-5	13-2	4-8	6-10	8-8	10-6	12-3	4-8	6-10	8-8	10-6	12-3	

(continued)

TABLE 2308.10.3(4)—continued  
**RAFTER SPANS FOR COMMON LUMBER SPECIES**  
 (Ground Snow Load = 50 pounds per square foot, Ceiling Not Attached to Rafters,  $L/\Delta = 180$ )

RAFTER SPACING (inches)	DEAD LOAD = 10 pounds per square foot										DEAD LOAD = 20 pounds per square foot									
	2 x 4		2 x 6		2 x 8		2 x 10		2 x 12		2 x 4		2 x 6		2 x 8		2 x 10		2 x 12	
	(ft. - in.)	(ft. - in.)	(ft. - in.)	(ft. - in.)	(ft. - in.)	(ft. - in.)	(ft. - in.)	(ft. - in.)	(ft. - in.)	(ft. - in.)	(ft. - in.)	(ft. - in.)	(ft. - in.)	(ft. - in.)	(ft. - in.)	(ft. - in.)	(ft. - in.)	(ft. - in.)	(ft. - in.)	(ft. - in.)
	SPECIES AND GRADE																			
	Douglas Fir-Larch	SS	7-3	11-4	14-6	17-8	20-6	7-3	10-7	13-5	16-5	19-0								
	Douglas Fir-Larch	#1	6-6	9-6	12-0	14-8	17-1	6-0	8-10	11-2	13-7	15-9								
	Douglas Fir-Larch	#2	6-1	8-11	11-3	13-9	15-11	5-7	8-3	10-5	12-9	14-9								
	Douglas Fir-Larch	#3	4-7	6-9	8-6	10-5	12-1	4-3	6-3	7-11	9-7	11-2								
	Hem-Fir	SS	6-10	10-9	14-2	17-5	20-2	6-10	10-5	13-2	16-1	18-8								
	Hem-Fir	#1	6-4	9-3	11-9	14-4	16-7	5-10	8-7	10-10	13-3	15-5								
	Hem-Fir	#2	6-0	8-9	11-1	13-7	15-9	5-7	8-1	10-3	12-7	14-7								
	Hem-Fir	#3	4-7	6-9	8-6	10-5	12-1	4-3	6-3	7-11	9-7	11-2								
19.2	Southern Pine	SS	7-1	11-2	14-8	18-9	22-10	7-1	11-2	14-8	18-7	21-9								
	Southern Pine	#1	7-0	10-8	13-5	16-0	19-1	6-8	9-11	12-5	14-10	17-8								
	Southern Pine	#2	6-6	9-4	12-0	14-4	16-10	6-0	8-8	11-2	13-4	15-7								
	Southern Pine	#3	4-11	7-3	9-2	10-10	12-11	4-6	6-8	8-6	10-1	12-0								
	Spruce-Pine-Fir	SS	6-8	10-6	13-5	16-5	19-1	6-8	9-10	12-5	15-3	17-8								
	Spruce-Pine-Fir	#1	6-1	8-11	11-3	13-9	15-11	5-7	8-3	10-5	12-9	14-9								
	Spruce-Pine-Fir	#2	6-1	8-11	11-3	13-9	15-11	5-7	8-3	10-5	12-9	14-9								
	Spruce-Pine-Fir	#3	4-7	6-9	8-6	10-5	12-1	4-3	6-3	7-11	9-7	11-2								
	Douglas Fir-Larch	SS	6-8	10-3	13-0	15-10	18-4	6-6	9-6	12-0	14-8	17-0								
	Douglas Fir-Larch	#1	5-10	8-6	10-9	13-2	15-3	5-5	7-10	10-0	12-2	14-1								
	Douglas Fir-Larch	#2	5-5	7-11	10-1	12-4	14-3	5-0	7-4	9-4	11-5	13-2								
	Douglas Fir-Larch	#3	4-1	6-0	7-7	9-4	10-9	3-10	5-7	7-1	8-7	10-0								
	Hem-Fir	SS	6-4	9-11	12-9	15-7	18-0	6-4	9-4	11-9	14-5	16-8								
	Hem-Fir	#1	5-8	8-3	10-6	12-10	14-10	5-3	7-8	9-9	11-10	13-9								
	Hem-Fir	#2	5-4	7-10	9-11	12-1	14-1	4-11	7-3	9-2	11-3	13-0								
	Hem-Fir	#3	4-1	6-0	7-7	9-4	10-9	3-10	5-7	7-1	8-7	10-0								
24	Southern Pine	SS	6-7	10-4	13-8	17-5	21-0	6-7	10-4	13-8	16-7	19-5								
	Southern Pine	#1	6-5	9-7	12-0	14-4	17-1	6-0	8-10	11-2	13-3	15-9								
	Southern Pine	#2	5-10	8-4	10-9	12-10	15-1	5-5	7-9	10-0	11-11	13-11								
	Southern Pine	#3	4-4	6-5	8-3	9-9	11-7	4-1	6-0	7-7	9-0	10-8								
	Spruce-Pine-Fir	SS	6-2	9-6	12-0	14-8	17-1	6-0	8-10	11-2	13-7	15-9								
	Spruce-Pine-Fir	#1	5-5	7-11	10-1	12-4	14-3	5-0	7-4	9-4	11-5	13-2								
	Spruce-Pine-Fir	#2	5-5	7-11	10-1	12-4	14-3	5-0	7-4	9-4	11-5	13-2								
	Spruce-Pine-Fir	#3	4-1	6-0	7-7	9-4	10-9	3-10	5-7	7-1	8-7	10-0								

For SI: 1 inch = 25.4 mm, 1 foot = 304.8 mm, 1 pound per square foot = 47.9 N/m<sup>2</sup>.

a. Span exceeds 26 feet in length. Check sources for availability of lumber in lengths greater than 20 feet.



TABLE 2308.10.3(5)  
**RAFTER SPANS FOR COMMON LUMBER SPECIES**  
 (Ground Snow Load = 30 pounds per square foot, Ceiling Attached to Rafters, L/Δ = 240)

RAFTER SPACING (inches)	DEAD LOAD = 10 pounds per square foot						DEAD LOAD = 20 pounds per square foot					
	2 x 4	2 x 6	2 x 8	2 x 10	2 x 12	2 x 12	2 x 4	2 x 6	2 x 8	2 x 10	2 x 12	
	(ft. - in.)	(ft. - in.)	(ft. - in.)	(ft. - in.)	(ft. - in.)	(ft. - in.)	(ft. - in.)	(ft. - in.)	(ft. - in.)	(ft. - in.)	(ft. - in.)	
	Maximum rafter spans											
	(ft. - in.)	(ft. - in.)	(ft. - in.)	(ft. - in.)	(ft. - in.)	(ft. - in.)	(ft. - in.)	(ft. - in.)	(ft. - in.)	(ft. - in.)	(ft. - in.)	(ft. - in.)
12	Douglas Fir-Larch	SS	9-1	14-4	18-10	24-1	Note a	9-1	14-4	18-10	24-1	Note a
	Douglas Fir-Larch	#1	8-9	13-9	18-2	22-9	Note a	8-9	13-2	16-8	20-4	23-7
	Douglas Fir-Larch	#2	8-7	13-6	17-5	21-4	24-8	8-5	12-4	15-7	19-1	22-1
	Douglas Fir-Larch	#3	7-1	10-5	13-2	16-1	18-8	6-4	9-4	11-9	14-5	16-8
	Hem-Fir	SS	8-7	13-6	17-10	22-9	Note a	8-7	13-6	17-10	22-9	Note a
	Hem-Fir	#1	8-5	13-3	17-5	22-2	25-9	8-5	12-10	16-3	19-10	23-0
	Hem-Fir	#2	8-0	12-7	16-7	21-0	24-4	8-0	12-2	15-4	18-9	21-9
	Hem-Fir	#3	7-1	10-5	13-2	16-1	18-8	6-4	9-4	11-9	14-5	16-8
	Southern Pine	SS	8-11	14-1	18-6	23-8	Note a	8-11	14-1	18-6	23-8	Note a
	Southern Pine	#1	8-9	13-9	18-2	23-2	Note a	8-9	13-9	18-2	22-2	Note a
	Southern Pine	#2	8-7	13-6	17-10	22-3	Note a	8-7	12-11	16-8	19-11	23-4
	Southern Pine	#3	7-7	11-2	14-3	16-10	20-0	6-9	10-0	12-9	15-1	17-11
	Spruce-Pine-Fir	SS	8-5	13-3	17-5	22-3	Note a	8-5	13-3	17-5	22-3	Note a
	Spruce-Pine-Fir	#1	8-3	12-11	17-0	21-4	24-8	8-3	12-4	15-7	19-1	22-1
	Spruce-Pine-Fir	#2	8-3	12-11	17-0	21-4	24-8	8-3	12-4	15-7	19-1	22-1
	Spruce-Pine-Fir	#3	7-1	10-5	13-2	16-1	18-8	6-4	9-4	11-9	14-5	16-8
Douglas Fir-Larch	SS	8-3	13-0	17-2	21-10	Note a	8-3	13-0	17-2	21-3	24-8	
Douglas Fir-Larch	#1	8-0	12-6	16-2	19-9	22-10	7-10	11-5	14-5	17-8	20-5	
Douglas Fir-Larch	#2	7-10	11-11	15-1	18-5	21-5	7-3	10-8	13-6	16-6	19-2	
Douglas Fir-Larch	#3	6-2	9-0	11-5	13-11	16-2	5-6	8-1	10-3	12-6	14-6	
Hem-Fir	SS	7-10	12-3	16-2	20-8	25-1	7-10	12-3	16-2	20-8	24-2	
Hem-Fir	#1	7-8	12-0	15-9	19-3	22-3	7-7	11-1	14-1	17-2	19-11	
Hem-Fir	#2	7-3	11-5	14-11	18-2	21-1	7-2	10-6	13-4	16-3	18-10	
Hem-Fir	#3	6-2	9-0	11-5	13-11	16-2	5-6	8-1	10-3	12-6	14-6	
Southern Pine	SS	8-1	12-9	16-10	21-6	Note a	8-1	12-9	16-10	21-6	Note a	
Southern Pine	#1	8-0	12-6	16-6	21-1	25-7	8-0	12-6	16-2	19-2	22-10	
Southern Pine	#2	7-10	12-3	16-2	19-3	22-7	7-10	11-2	14-5	17-3	20-2	
Southern Pine	#3	6-7	9-8	12-4	14-7	17-4	5-10	8-8	11-0	13-0	15-6	
Spruce-Pine-Fir	SS	7-8	12-0	15-10	20-2	24-7	7-8	12-0	15-10	19-9	22-10	
Spruce-Pine-Fir	#1	7-6	11-9	15-1	18-5	21-5	7-3	10-8	13-6	16-6	19-2	
Spruce-Pine-Fir	#2	7-6	11-9	15-1	18-5	21-5	7-3	10-8	13-6	16-6	19-2	
Spruce-Pine-Fir	#3	6-2	9-0	11-5	13-11	16-2	5-6	8-1	10-3	12-6	14-6	

(continued)

TABLE 2308.10.3(5)—continued  
**RAFTER SPANS FOR COMMON LUMBER SPECIES**  
 (Ground Snow Load = 30 pounds per square foot, Ceiling Attached to Rafters,  $L/\Delta = 240$ )

RAFTER SPACING (inches)	SPECIES AND GRADE	DEAD LOAD = 10 pounds per square foot						DEAD LOAD = 20 pounds per square foot					
		2 x 4	2 x 6	2 x 8	2 x 10	2 x 12	2 x 4	2 x 6	2 x 8	2 x 10	2 x 12		
		(ft. - in.)	(ft. - in.)	(ft. - in.)	(ft. - in.)	(ft. - in.)	(ft. - in.)	(ft. - in.)	(ft. - in.)	(ft. - in.)	(ft. - in.)		
19.2	Douglas Fir-Larch SS	7-9	12-3	16-1	20-7	25-0	7-9	12-3	15-10	19-5	22-6		
	Douglas Fir-Larch #1	7-6	11-8	14-9	18-0	20-11	7-1	10-5	13-2	16-1	18-8		
	Douglas Fir-Larch #2	7-4	10-11	13-9	16-10	19-6	6-8	9-9	12-4	15-1	17-6		
	Douglas Fir-Larch #3	5-7	8-3	10-5	12-9	14-9	5-0	7-4	9-4	11-5	13-2		
	Hem-Fir SS	7-4	11-7	15-3	19-5	23-7	7-4	11-7	15-3	19-1	22-1		
	Hem-Fir #1	7-2	11-4	14-4	17-7	20-4	6-11	10-2	12-10	15-8	18-2		
	Hem-Fir #2	6-10	10-9	13-7	16-7	19-3	6-7	9-7	12-2	14-10	17-3		
	Hem-Fir #3	5-7	8-3	10-5	12-9	14-9	5-0	7-4	9-4	11-5	13-2		
	Southern Pine SS	7-8	12-0	15-10	20-2	24-7	7-8	12-0	15-10	20-2	24-7		
	Southern Pine #1	7-6	11-9	15-6	19-7	23-4	7-6	11-9	14-9	17-6	20-11		
	Southern Pine #2	7-4	11-5	14-9	17-7	20-7	7-1	10-2	13-2	15-9	18-5		
	Southern Pine #3	6-0	8-10	11-3	13-4	15-10	5-4	7-11	10-1	11-11	14-2		
	Spruce-Pine-Fir SS	7-2	11-4	14-11	19-0	23-1	7-2	11-4	14-9	18-0	20-11		
	Spruce-Pine-Fir #1	7-0	10-11	13-9	16-10	19-6	6-8	9-9	12-4	15-1	17-6		
	Spruce-Pine-Fir #2	7-0	10-11	13-9	16-10	19-6	6-8	9-9	12-4	15-1	17-6		
	Spruce-Pine-Fir #3	5-7	8-3	10-5	12-9	14-9	5-0	7-4	9-4	11-5	13-2		
	24	Douglas Fir-Larch SS	7-3	11-4	15-0	19-1	22-6	7-3	11-3	14-2	17-4	20-1	
		Douglas Fir-Larch #1	7-0	10-5	13-2	16-1	18-8	6-4	9-4	11-9	14-5	16-8	
		Douglas Fir-Larch #2	6-8	9-9	12-4	15-1	17-6	5-11	8-8	11-0	13-6	15-7	
Douglas Fir-Larch #3		5-0	7-4	9-4	11-5	13-2	4-6	6-7	8-4	10-2	11-10		
Hem-Fir SS		6-10	10-9	14-2	18-0	21-11	6-10	10-9	13-11	17-0	19-9		
Hem-Fir #1		6-8	10-2	12-10	15-8	18-2	6-2	9-1	11-6	14-0	16-3		
Hem-Fir #2		6-4	9-7	12-2	14-10	17-3	5-10	8-7	10-10	13-3	15-5		
Hem-Fir #3		5-0	7-4	9-4	11-5	13-2	4-6	6-7	8-4	10-2	11-10		
Southern Pine SS		7-1	11-2	14-8	18-9	22-10	7-1	11-2	14-8	18-9	22-10		
Southern Pine #1		7-0	10-11	14-5	17-6	20-11	7-0	10-6	13-2	15-8	18-8		
Southern Pine #2		6-10	10-2	13-2	15-9	18-5	6-4	9-2	11-9	14-1	16-6		
Southern Pine #3		5-4	7-11	10-1	11-11	14-2	4-9	7-1	9-0	10-8	12-8		
Spruce-Pine-Fir SS		6-8	10-6	13-10	17-8	20-11	6-8	10-5	13-2	16-1	18-8		
Spruce-Pine-Fir #1		6-6	9-9	12-4	15-1	17-6	5-11	8-8	11-0	13-6	15-7		
Spruce-Pine-Fir #2		6-6	9-9	12-4	15-1	17-6	5-11	8-8	11-0	13-6	15-7		
Spruce-Pine-Fir #3		5-0	7-4	9-4	11-5	13-2	4-6	6-7	8-4	10-2	11-10		

For SI: 1 inch = 25.4 mm, 1 foot = 304.8 mm, 1 pound per square foot = 47.9 N/m<sup>2</sup>.  
 a. Span exceeds 26 feet in length. Check sources for availability of lumber in lengths greater than 20 feet.

TABLE 2308.10.3(6)  
**RAFTER SPANS FOR COMMON LUMBER SPECIES**  
 (Ground Snow Load = 50 pounds per square foot, Ceiling Attached to Rafters,  $L/\Delta = 240$ )

RAFTER SPACING (inches)	SPECIES AND GRADE	DEAD LOAD = 10 pounds per square foot					DEAD LOAD = 20 pounds per square foot				
		2 x 4	2 x 6	2 x 8	2 x 10	2 x 12	2 x 4	2 x 6	2 x 8	2 x 10	2 x 12
		(ft. - in.)	(ft. - in.)	(ft. - in.)	(ft. - in.)	(ft. - in.)	(ft. - in.)	(ft. - in.)	(ft. - in.)	(ft. - in.)	(ft. - in.)
12	Douglas Fir-Larch SS	7-8	12-1	15-11	20-3	24-8	7-8	12-1	15-11	20-3	24-0
	Douglas Fir-Larch #1	7-5	11-7	15-3	18-7	21-7	7-5	11-2	14-1	17-3	20-0
	Douglas Fir-Larch #2	7-3	11-3	14-3	17-5	20-2	7-1	10-5	13-2	16-1	18-8
	Douglas Fir-Larch #3	5-10	8-6	10-9	13-2	15-3	5-5	7-10	10-0	12-2	14-1
	Hem-Fir SS	7-3	11-5	15-0	19-2	23-4	7-3	11-5	15-0	19-2	23-4
	Hem-Fir #1	7-1	11-2	14-8	18-1	21-0	7-1	10-10	13-9	16-9	19-5
	Hem-Fir #2	6-9	10-8	14-0	17-2	19-11	6-9	10-3	13-0	15-10	18-5
	Hem-Fir #3	5-10	8-6	10-9	13-2	15-3	5-5	7-10	10-0	12-2	14-1
	Southern Pine SS	7-6	11-0	15-7	19-11	24-3	7-6	11-10	15-7	19-11	24-3
	Southern Pine #1	7-5	11-7	15-4	19-7	23-9	7-5	11-7	15-4	18-9	22-4
	Southern Pine #2	7-3	11-5	15-0	18-2	21-3	7-3	10-11	14-1	16-10	19-9
	Southern Pine #3	6-2	9-2	11-8	13-9	16-4	5-9	8-5	10-9	12-9	15-2
16	Spruce-Pine-Fir SS	7-1	11-2	14-8	18-9	22-10	7-1	11-2	14-8	18-9	22-4
	Spruce-Pine-Fir #1	6-11	10-11	14-3	17-5	20-2	6-11	10-5	13-2	16-1	18-8
	Spruce-Pine-Fir #2	6-11	10-11	14-3	17-5	20-2	6-11	10-5	13-2	16-1	18-8
	Spruce-Pine-Fir #3	5-10	8-6	10-9	13-2	15-3	5-5	7-10	10-0	12-2	14-1
	Douglas Fir-Larch SS	7-0	11-0	14-5	18-5	22-5	7-0	11-0	14-5	17-11	20-10
	Douglas Fir-Larch #1	6-9	10-5	13-2	16-1	18-8	6-7	9-8	12-2	14-11	17-3
	Douglas Fir-Larch #2	6-7	9-9	12-4	15-1	17-6	6-2	9-0	11-5	13-11	16-2
	Douglas Fir-Larch #3	5-0	7-4	9-4	11-5	13-2	4-8	6-10	8-8	10-6	12-3
	Hem-Fir SS	6-7	10-4	13-8	17-5	21-2	6-7	10-4	13-8	17-5	20-5
	Hem-Fir #1	6-5	10-2	12-10	15-8	18-2	6-5	9-5	11-11	14-6	16-10
	Hem-Fir #2	6-2	9-7	12-2	14-10	17-3	6-1	8-11	11-3	13-9	15-11
	Hem-Fir #3	5-0	7-4	9-4	11-5	13-2	4-8	6-10	8-8	10-6	12-3
16	Southern Pine SS	6-10	10-9	14-2	18-1	22-0	6-10	10-9	14-2	18-1	22-0
	Southern Pine #1	6-9	10-7	13-11	17-6	20-11	6-9	10-7	13-8	16-2	19-4
	Southern Pine #2	6-7	10-2	13-2	15-9	18-5	6-7	9-5	12-2	14-7	17-1
	Southern Pine #3	5-4	7-11	10-1	11-11	14-2	4-11	7-4	9-4	11-0	13-1
	Spruce-Pine-Fir SS	6-5	10-2	13-4	17-0	20-9	6-5	10-2	13-4	16-8	19-4
	Spruce-Pine-Fir #1	6-4	9-9	12-4	15-1	17-6	6-2	9-0	11-5	13-11	16-2
	Spruce-Pine-Fir #2	6-4	9-9	12-4	15-1	17-6	6-2	9-0	11-5	13-11	16-2
	Spruce-Pine-Fir #3	5-0	7-4	9-4	11-5	13-2	4-8	6-10	8-8	10-6	12-3

(continued)

TABLE 2308.10.3(6)—continued  
**RAFTER SPANS FOR COMMON LUMBER SPECIES**  
 (Ground Snow Load = 50 pounds per square foot, Ceiling Attached to Rafters,  $L/\Delta = 240$ )

RAFTER SPACING (inches)	SPECIES AND GRADE	DEAD LOAD = 10 pounds per square foot						DEAD LOAD = 20 pounds per square foot					
		2 x 4	2 x 6	2 x 8	2 x 10	2 x 12	2 x 4	2 x 6	2 x 8	2 x 10	2 x 12		
		(ft. - in.)	(ft. - in.)	(ft. - in.)	(ft. - in.)	(ft. - in.)	(ft. - in.)	(ft. - in.)	(ft. - in.)	(ft. - in.)	(ft. - in.)		
19.2	Douglas Fir-Larch	SS	6-7	10-4	13-7	17-4	20-6	6-7	10-4	13-5	16-5	19-0	
	Douglas Fir-Larch	#1	6-4	9-6	12-0	14-8	17-1	6-0	8-10	11-2	13-7	15-9	
	Douglas Fir-Larch	#2	6-1	8-11	11-3	13-9	15-11	5-7	8-3	10-5	12-9	14-9	
	Douglas Fir-Larch	#3	4-7	6-9	8-6	10-5	12-1	4-3	6-3	7-11	9-7	11-2	
	Hem-Fir	SS	6-2	9-9	12-10	16-5	19-11	6-2	9-9	12-10	16-1	18-8	
	Hem-Fir	#1	6-1	9-3	11-9	14-4	16-7	5-10	8-7	10-10	13-3	15-5	
	Hem-Fir	#2	5-9	8-9	11-1	13-7	15-9	5-7	8-1	10-3	12-7	14-7	
	Hem-Fir	#3	4-7	6-9	8-6	10-5	12-1	4-3	6-3	7-11	9-7	11-2	
	Southern Pine	SS	6-5	10-2	13-4	17-0	20-9	6-5	10-2	13-4	17-0	20-9	
	Southern Pine	#1	6-4	9-11	13-1	16-0	19-1	6-4	9-11	12-5	14-10	17-8	
	Southern Pine	#2	6-2	9-4	12-0	14-4	16-10	6-0	8-8	11-2	13-4	15-7	
	Southern Pine	#3	4-11	7-3	9-2	10-10	12-11	4-6	6-8	8-6	10-1	12-0	
	Spruce-Pine-Fir	SS	6-1	9-6	12-7	16-0	19-1	6-1	9-6	12-5	15-3	17-8	
	Spruce-Pine-Fir	#1	5-11	8-11	11-3	13-9	15-11	5-7	8-3	10-5	12-9	14-9	
	Spruce-Pine-Fir	#2	5-11	8-11	11-3	13-9	15-11	5-7	8-3	10-5	12-9	14-9	
	Spruce-Pine-Fir	#3	4-7	6-9	8-6	10-5	12-1	4-3	6-3	7-11	9-7	11-2	
	24	Douglas Fir-Larch	SS	6-1	9-7	12-7	15-10	18-4	6-1	9-6	12-0	14-8	17-0
		Douglas Fir-Larch	#1	5-10	8-6	10-9	13-2	15-3	5-5	7-10	10-0	12-2	14-1
Douglas Fir-Larch		#2	5-5	7-11	10-1	12-4	14-3	5-0	7-4	9-4	11-5	13-2	
Douglas Fir-Larch		#3	4-1	6-0	7-7	9-4	10-9	3-10	5-7	7-1	8-7	10-0	
Hem-Fir		SS	5-9	9-1	11-11	15-12	18-0	5-9	9-1	11-9	14-5	16-8	
Hem-Fir		#1	5-8	8-3	10-6	12-10	14-10	5-3	7-8	9-9	11-10	13-9	
Hem-Fir		#2	5-4	7-10	9-11	12-1	14-1	4-11	7-3	9-2	11-3	13-0	
Hem-Fir		#3	4-1	6-0	7-7	9-4	10-9	3-10	5-7	7-1	8-7	10-0	
Southern Pine		SS	6-0	9-5	12-5	15-10	19-3	6-0	9-5	12-5	15-10	19-3	
Southern Pine		#1	5-10	9-3	12-0	14-4	17-1	5-10	8-10	11-2	13-3	15-9	
Southern Pine		#2	5-9	8-4	10-9	12-10	15-1	5-5	7-9	10-0	11-11	13-11	
Southern Pine		#3	4-4	6-5	8-3	9-9	11-7	4-1	6-0	7-7	9-0	10-8	
Spruce-Pine-Fir		SS	5-8	8-10	11-8	14-8	17-1	5-8	8-10	11-2	13-7	15-9	
Spruce-Pine-Fir		#1	5-5	7-11	10-1	12-4	14-3	5-0	7-4	9-4	11-5	13-2	
Spruce-Pine-Fir		#2	5-5	7-11	10-1	12-4	14-3	5-0	7-4	9-4	11-5	13-2	
Spruce-Pine-Fir		#3	4-1	6-0	7-7	9-4	10-9	3-10	5-7	7-1	8-7	10-0	

For SI: 1 inch = 25.4 mm, 1 foot = 304.8 mm, 1 pound per square foot = 47.9 N/m<sup>2</sup>.

**TABLE 2308.10.4.1  
RAFTER TIE CONNECTIONS<sup>g</sup>**

RAFTER SLOPE	TIE SPACING (inches)	GROUND SNOW LOAD (pound per square foot)											
		NO SNOW LOAD				30 pounds per square foot				50 pounds per square foot			
		Roof span (feet)											
		12	20	28	36	12	20	28	36	12	20	28	36
Required number of 16d common nails <sup>a,b</sup> per connection <sup>c,d,e,f</sup>													
3:12	12	4	6	8	10	4	6	8	11	5	8	12	15
	16	5	7	10	13	5	8	11	14	6	11	15	20
	24	7	11	15	19	7	11	16	21	9	16	23	30
	32	10	14	19	25	10	16	22	28	12	27	30	40
	48	14	21	29	37	14	32	36	42	18	32	46	60
4:12	12	3	4	5	6	3	5	6	8	4	6	9	11
	16	3	5	7	8	4	6	8	11	5	8	12	15
	24	4	7	10	12	5	9	12	16	7	12	17	22
	32	6	9	13	16	8	12	16	22	10	16	24	30
	48	8	14	19	24	10	18	24	32	14	24	34	44
5:12	12	3	3	4	5	3	4	5	7	3	5	7	9
	16	3	4	5	7	3	5	7	9	4	7	9	12
	24	4	6	8	10	4	7	10	13	6	10	14	18
	32	5	8	10	13	6	10	14	18	8	14	18	24
	48	7	11	15	20	8	14	20	26	12	20	28	36
7:12	12	3	3	3	4	3	3	4	5	3	4	5	7
	16	3	3	4	5	3	4	5	6	3	5	7	9
	24	3	4	6	7	3	5	7	9	4	7	10	13
	32	4	6	8	10	4	8	10	12	6	10	14	18
	48	5	8	11	14	6	10	14	18	9	14	20	26
9:12	12	3	3	3	3	3	3	3	4	3	3	4	5
	16	3	3	3	4	3	3	4	5	3	4	5	7
	24	3	3	5	6	3	4	6	7	3	6	8	10
	32	3	4	6	8	4	6	8	10	5	8	10	14
	48	4	6	9	11	5	8	12	14	7	12	16	20
12:12	12	3	3	3	3	3	3	3	3	3	3	3	4
	16	3	3	3	3	3	3	3	4	3	3	4	5
	24	3	3	3	4	3	3	4	6	3	4	6	8
	32	3	3	4	5	3	5	6	8	4	6	8	10
	48	3	4	6	7	4	7	8	12	6	8	12	16

For SI: 1 inch = 25.4 mm, 1 foot = 304.8 mm, 1 pound per square foot = 47.8 N/m<sup>2</sup>.

- a. 40d box or 16d sinker box nails are permitted to be substituted for 16d common nails.
- b. Nailing requirements are permitted to be reduced 25 percent if nails are clinched.
- c. Rafter tie heel joint connections are not required where the ridge is supported by a load-bearing wall, header or ridge beam.
- d. When intermediate support of the rafter is provided by vertical struts or purlins to a load-bearing wall, the tabulated heel joint connection requirements are permitted to be reduced proportionally to the reduction in span.
- e. Equivalent nailing patterns are required for ceiling joist to ceiling joist lap splices.
- f. Connected members shall be of sufficient size to prevent splitting due to nailing.
- g. For snow loads less than 30 pounds per square foot, the required number of nails is permitted to be reduced by multiplying by the ratio of actual snow load plus 10 divided by 40, but not less than the number required for no snow load.

**TABLE 2308.10.9  
ALLOWABLE SPANS FOR 2-INCH TONGUE-AND-GROOVE DECKING**

<b>SPAN<sup>a</sup> (feet)</b>	<b>LIVE LOAD (pound per square foot)</b>	<b>DEFLECTION LIMIT</b>	<b>BENDING STRESS (f) (pound per square inch)</b>	<b>MODULUS OF ELASTICITY (E) (pound per square inch)</b>
<b>Roofs</b>				
4	20	1/240 1/360	160	170,000 256,000
	30	1/240 1/360	210	256,000 384,000
	40	1/240 1/360	270	340,000 512,000
4.5	20	1/240 1/360	200	242,000 305,000
	30	1/240 1/360	270	363,000 405,000
	40	1/240 1/360	350	484,000 725,000
5.0	20	1/240 1/360	250	332,000 500,000
	30	1/240 1/360	330	495,000 742,000
	40	1/240 1/360	420	660,000 1,000,000
5.5	20	1/240 1/360	300	442,000 660,000
	30	1/240 1/360	400	662,000 998,000
	40	1/240 1/360	500	884,000 1,330,000
6.0	20	1/240 1/360	360	575,000 862,000
	30	1/240 1/360	480	862,000 1,295,000
	40	1/240 1/360	600	1,150,000 1,730,000
6.5	20	1/240 1/360	420	595,000 892,000
	30	1/240 1/360	560	892,000 1,340,000
	40	1/240 1/360	700	1,190,000 1,730,000
7.0	20	1/240 1/360	490	910,000 1,360,000
	30	1/240 1/360	650	1,370,000 2,000,000
	40	1/240 1/360	810	1,820,000 2,725,000

*(continued)*

**TABLE 2308.10.9—continued**  
**ALLOWABLE SPANS FOR 2-INCH TONGUE-AND-GROOVE DECKING**

SPAN <sup>a</sup> (feet)	LIVE LOAD (pound per square foot)	DEFLECTION LIMIT	BENDING STRESS ( <i>f</i> ) (pound per square inch)	MODULUS OF ELASTICITY ( <i>E</i> ) (pound per square inch)
<b>Roofs</b>				
7.5	20	1/240	560	1,125,000
		1/360		1,685,000
	30	750	1,685,000	
8.0	20	1/240	640	2,250,000
		1/360		3,380,000
	30	850	2,040,000	
<b>Floors</b>				
4	40	1/360	840	1,000,000
4.5			950	1,300,000
5.0			1,060	1,600,000

For SI: 1 inch = 25.4 mm, 1 foot = 304.8 mm, 1 pound per square foot = 0.0479 kN/m<sup>2</sup>, 1 pound per square inch = 0.00689 N/mm<sup>2</sup>.

a. Spans are based on simple beam action with 10 pounds per square foot dead load and provisions for a 300-pound concentrated load on a 12-inch width of decking. Random layup is permitted in accordance with the provisions of Section 2308.10.9. Lumber thickness is 1½ inches nominal.

**TABLE 2308.12.4**  
**WALL BRACING IN SEISMIC DESIGN CATEGORIES D AND E**  
(Minimum Length of Wall Bracing per each 25 Linear Feet of Braced Wall Line<sup>a</sup>)

STORY LOCATION	SHEATHING TYPE <sup>b</sup>	0.50 ≤ S <sub>DS</sub> < 0.75	0.75 ≤ S <sub>DS</sub> ≤ 1.00	1.00 ≤ S <sub>DS</sub>
Top or only story	G-P <sup>d</sup>	14 feet 8 inches <sup>c</sup>	18 feet 8 inches <sup>c</sup>	25 feet 0 inches <sup>c</sup>
	S-W	8 feet 0 inches <sup>c</sup>	9 feet 4 inches <sup>c</sup>	12 feet 0 inches <sup>c</sup>
Story below top story	G-P <sup>d</sup>	NP	NP	NP
	S-W	13 feet 4 inches <sup>c</sup>	17 feet 4 inches <sup>c</sup>	21 feet 4 inches <sup>c</sup>
Bottom story of three stories	G-P <sup>d</sup>	Conventional construction not permitted; conformance with Section 2301.2.1 or 2301.2.2 is required.		
	S-W			

For SI: 1 inch = 25.4 mm, 1 foot = 304.8 mm.

a. Minimum length of panel bracing of one face of wall for S-W sheathing or both faces of wall for G-P sheathing; *h/w* ratio shall not exceed 2:1. For S-W panel bracing of the same material on two faces of the wall, the minimum length is permitted to be one-half the tabulated value but the *h/w* ratio shall not exceed 2:1 and design for uplift is required.

b. G-P = gypsum board, fiberboard, particleboard, lath and plaster, or gypsum sheathing boards; S-W = wood structural panels and diagonal wood sheathing. NP = not permitted.

c. Applies to one- and two-family detached dwellings only.

d. Nailing as specified below shall occur at all panel edges at studs, at top and bottom plates, and, where occurring, at blocking:

For ½-inch gypsum board, 5d (0.113 inch diameter) cooler nails at 7 inches on center;

For ⅝-inch gypsum board, No. 11 gage (0.120 inch diameter) at 7 inches on center;

For gypsum sheathing board, 1¾ inches long by ⅞-inch head, diamond point galvanized nails at 4 inches on center;

For gypsum lath, No. 13 gage (0.092 inch) by 1⅞ inches long, 19/64-inch head, plasterboard at 5 inches on center;

For portland cement plaster, No. 11 gage (0.120 inch) by 1½ inches long, 7/16-inch head at 6 inches on center;

For fiberboard and particleboard, No. 11 gage (0.120 inch) by 1½ inches long, 7/16-inch head, galvanized nails at 3 inches on center.

**CHAPTER 24**  
**GLASS AND GLAZING**

**SECTION BC 2401**  
**GENERAL**

**2401.1 Scope.** The provisions of this chapter shall govern the materials, design, construction and quality of glass, light transmitting ceramic and light-transmitting plastic panels for exterior and interior use in both vertical and sloped applications in buildings and structures.

**2401.2 Glazing replacement.** The installation of replacement glass shall be as required for new installations.

**SECTION BC 2402**  
**DEFINITIONS**

**2402.1 Definitions.** The following words and terms shall, for the purposes of this chapter and as used elsewhere in this code, have the meanings shown herein.

**DALLE GLASS.** A decorative composite glazing material made of individual pieces of glass that are embedded in a cast matrix of concrete or epoxy.

**DECORATIVE GLASS.** A carved, leaded or Dalle glass or glazing material whose purpose is decorative or artistic, not functional; whose coloring, texture or other design qualities or components cannot be removed without destroying the glazing material and whose surface, or assembly into which it is incorporated, is divided into segments.

**SECTION BC 2403**  
**GENERAL REQUIREMENTS FOR GLASS**

**2403.1 Identification.** Each pane shall bear the manufacturer's label designating the type and thickness of the glass or glazing material. The identification shall not be omitted unless approved and an affidavit is furnished by the glazing contractor certifying that each light is glazed in accordance with approved construction documents that comply with the provisions of this chapter. Safety glazing shall be identified in accordance with Section 2406.2.

Each pane of tempered glass, except tempered spandrel glass, shall be permanently identified by the manufacturer. The identification label shall be acid etched, sand blasted, ceramic fired, embossed or shall be of a type that once applied cannot be removed without being destroyed. Tempered spandrel glass shall be provided with a removable paper marking by the manufacturer.

**2403.2 Glass supports.** Where one or more sides of any pane of glass are not firmly supported, or are subjected to unusual load conditions, detailed construction documents,



detailed shop drawings and analysis or test data assuring safe performance for the specific installation shall be prepared by an architect or engineer.

**2403.3 Framing.** To be considered firmly supported, the framing members for each individual pane of glass shall be designed so the deflection of the edge of the glass perpendicular to the glass pane shall not exceed  $\frac{1}{175}$  of the glass edge length or  $\frac{3}{4}$  inch (19.1 mm), whichever is less, when subjected to the larger of the positive or negative load where loads are combined as specified in Section 1605.

**2403.4 Interior glazed areas.** Where interior glazing is installed adjacent to a walking surface, the differential deflection of two adjacent unsupported edges shall not be greater than the thickness of the panels when a force of 50 pounds per linear foot (plf) (730 N/m) is applied horizontally to one panel at any point up to 42 inches (1067 mm) above the walking surface.

**2403.5 Louvered windows or jalousies.** Float, wired and patterned glass in louvered windows and jalousies shall be no thinner than nominal  $\frac{3}{16}$  inch (4.8 mm) and no longer than 48 inches (1219 mm). Exposed glass edges shall be smooth.

Wired glass with wire exposed on longitudinal edges shall not be used in louvered windows or jalousies.

Where other glass types are used, the design shall be submitted to the Department for approval.

**2403.6 Protection of glass panels.** Glass panels installed in areas where they will be subject to unusual conditions of construction damage, such as spatter from welds or locations near materials hoists, shall be protected by a hardboard covering or its equivalent during the period that such work is in progress.

**SECTION BC 2404**  
**WIND, SNOW, SEISMIC**  
**AND DEAD LOADS ON GLASS**

**2404.1 Vertical glass.** Glass sloped 15 degrees (0.26 rad) or less from vertical in windows, curtain and window walls, doors and other exterior applications shall be designed to resist the wind loads in Section 1609 for components and cladding. Glass in glazed curtain walls, glazed storefronts and glazed partitions shall meet the seismic requirements of ASCE 7, Section 9.6.2.10. Glazing firmly supported on all four edges is permitted to be designed by the following provisions. Where the glass is not firmly supported on all four edges, analysis or test data ensuring safe performance for the specific installation shall be prepared by an approved agency or special inspector. The design of vertical glazing shall be based on the following equation:

**(Equation 24-1 attached to end of document)**

(Equation 24-2 attached to end of document)

FIGURE 2404(1)<sup>a,b,c,d,e,f</sup>

MAXIMUM ALLOWABLE LOAD FOR VERTICAL AND SLOPED  
RECTANGULAR GLASS SUPPORTED ON ALL EDGES

(Figure 2404(1) attached to end of document)

FIGURE 2404(2)<sup>a,b,c,d,e,f</sup>

MAXIMUM ALLOWABLE LOAD FOR VERTICAL AND SLOPED  
RECTANGULAR GLASS SUPPORTED ON ALL EDGES

(Figure 2404(2) attached to end of document)

FIGURE 2404(3)<sup>a,b,c,d,e,f</sup>

MAXIMUM ALLOWABLE LOAD FOR VERTICAL AND SLOPED  
RECTANGULAR GLASS SUPPORTED ON ALL EDGES

(Figure 2404(3) attached to end of document)

FIGURE 2404(4)<sup>a,b,c,d,e,f</sup>

MAXIMUM ALLOWABLE LOAD FOR VERTICAL AND SLOPED  
RECTANGULAR GLASS SUPPORTED ON ALL EDGES

(Figure 2404(4) attached to end of document)

FIGURE 2404(5)<sup>a,b,c,d,e,f</sup>

MAXIMUM ALLOWABLE LOAD FOR VERTICAL AND SLOPED  
RECTANGULAR GLASS SUPPORTED ON ALL EDGES

(Figure 2404(5) attached to end of document)

FIGURE 2404(6)<sup>a,b,c,d,e,f</sup>

MAXIMUM ALLOWABLE LOAD FOR VERTICAL AND SLOPED  
RECTANGULAR GLASS SUPPORTED ON ALL EDGES

(Figure 2404(6) attached to end of document)

FIGURE 2404(7)<sup>a,b,c,d,e,f</sup>

MAXIMUM ALLOWABLE LOAD FOR VERTICAL AND SLOPED  
RECTANGULAR GLASS SUPPORTED ON ALL EDGES

(Figure 2404(7) attached to end of document)

FIGURE 2404(8)<sup>a,b,c,d,e,f</sup>

MAXIMUM ALLOWABLE LOAD FOR VERTICAL AND SLOPED  
RECTANGULAR GLASS SUPPORTED ON ALL EDGES

(Figure 2404(8) attached to end of document)

FIGURE 2404(9)<sup>a,b,c,d,e,f</sup>

MAXIMUM ALLOWABLE LOAD FOR VERTICAL AND SLOPED  
RECTANGULAR GLASS SUPPORTED ON ALL EDGES

(Figure 2404(9) attached to end of document)

**FIGURE 2404(10)<sup>a,b,c,d,e,f</sup>**  
**MAXIMUM ALLOWABLE LOAD FOR VERTICAL AND SLOPED**  
**RECTANGULAR GLASS SUPPORTED ON ALL EDGES**  
**(Figure 2404(10) attached to end of document)**

**FIGURE 2404(11)<sup>a,b,c,d,e,f</sup>**  
**MAXIMUM ALLOWABLE LOAD FOR VERTICAL AND SLOPED**  
**RECTANGULAR GLASS SUPPORTED ON ALL EDGES**  
**(Figure 2404(11) attached to end of document)**

**FIGURE 2404(12)<sup>a,b,c,d,e,f</sup>**  
**MAXIMUM ALLOWABLE LOAD FOR VERTICAL AND SLOPED**  
**RECTANGULAR GLASS SUPPORTED ON ALL EDGES**  
**(Figure 2404(12) attached to end of document)**

**TABLE 2404.1**  
**c<sub>1</sub> FACTORS FOR VERTICAL AND SLOPED GLASS<sup>a</sup>**  
**[For use with Figures 2404(1) through 2404(12)] (NOTE: Brackets in this instance**  
**and any following similar instances do not denote deletion)**  
**(Table 2404.1 attached to end of document)**

**2404.2 Sloped glass.** Glass sloped more than 15 degrees (0.26 rad) from vertical in skylights, sunrooms, sloped roofs and other exterior applications shall be designed to resist the most critical of the following combinations of loads.

**(Equation 24-3 attached to end of document)**

**(Equation 24-4 attached to end of document)**

**(Equation 24-5 attached to end of document)**

**Exception:** Unit skylights shall be designed in accordance with Section 2405.5. The design of sloped glazing shall be based on the following equation:

**(Equation 24-6 attached to end of document)**

**(Equation 24-7 attached to end of document)**

**TABLE 2404.2**  
**°2 FACTORS FOR SLOPED GLASS<sup>a</sup>**  
**[For use with Figures 2404(1) through 2404(12)]**  
**(Table 2404.2 attached to end of document)**

**SECTION BC 2405**  
**SLOPED GLAZING AND SKYLIGHTS**

**2405.1 Scope.** This section applies to the installation of glass and other transparent, translucent or opaque glazing material installed at a slope more than 15 degrees (0.26 rad) from the vertical plane, including glazing materials in skylights, roofs and sloped walls.

**2405.2 Allowable glazing materials and limitations.** Sloped glazing shall be any of the following materials, subject to the listed limitations:

1. For monolithic glazing systems, the glazing material of the single light or layer shall be laminated glass with a minimum 30-mil (0.76 mm) polyvinyl butyral (or equivalent) interlayer, wired glass, light-transmitting plastic materials meeting the requirements of Section 2607, heat-strengthened glass or fully tempered glass.
2. For multiple-layer glazing systems, each light or layer shall consist of any of the glazing materials specified in Item 1 above. Annealed glass is permitted to be used as specified within Exceptions 2 and 3 of Section 2405.3. For additional requirements for plastic skylights, see Section 2610. Glass-block construction shall conform to the requirements of Section 2101.2.5.

**2405.3 Screening.** Where used in monolithic glazing systems, heat-strengthened glass and fully tempered glass shall have screens installed below the glazing material. The screens and their fastenings shall: (1) be capable of supporting twice the weight of the glazing; (2) be firmly and substantially fastened to the framing members and (3) be installed within 4 inches (102 mm) of the glass. The screens shall be constructed of a noncombustible material not thinner than No. 12 B&S gage (0.0808 inch) with mesh not larger than 1 inch by 1 inch (25 mm by 25 mm). In a corrosive atmosphere, structurally equivalent noncorrosive screen materials shall be used. Heat-strengthened glass, fully tempered glass and wired glass, when used in multiple-layer glazing systems as the bottom glass layer over the walking surface, shall be equipped with screening that conforms to the requirements for monolithic glazing systems.

**Exception:** In monolithic and multiple-layer sloped glazing systems, the following applies:

1. Fully tempered glass installed without protective screens where glazed between intervening floors at a slope of 30 degrees (0.52 rad) or less from the vertical plane shall have the highest point of the glass 10 feet (3048 mm) or less above the walking surface.
2. Screens are not required below any glazing material, including annealed glass, where the walking surface below the glazing material is permanently protected from the risk of falling glass or the area below the glazing material is not a walking surface.

3. Any glazing material, including annealed glass, is permitted to be installed without screens in the sloped glazing systems of commercial or detached noncombustible greenhouses used exclusively for growing plants and not open to the public, provided that the height of the greenhouse at the ridge does not exceed 30 feet (9144 mm) above grade.
4. Screens shall not be required within individual dwelling units in Groups R-2 and R-3 where fully tempered glass is used as single glazing or as both panes in an insulating glass unit, and the following conditions are met:
  - 4.1. Each pane of the glass is 16 square feet (1.5 m<sup>2</sup>) or less in area.
  - 4.2. The highest point of the glass is 12 feet (3658 mm) or less above any walking surface or other accessible area.
  - 4.3. The glass thickness is <sup>3</sup>/<sub>16</sub> inch (4.8 mm) or less.
5. Screens shall not be required for laminated glass with a 15-mil (0.38 mm) polyvinyl butyral (or equivalent) interlayer used within individual dwelling units in Groups R-2 and R-3 within the following limits:
  - 5.1. Each pane of glass is 16 square feet (1.5m<sup>2</sup>) or less in area.
  - 5.2. The highest point of the glass is 12 feet (3658 mm) or less above a walking surface or other accessible area.

**2405.4 Framing.** In Type I and II construction, sloped glazing and skylight frames shall be constructed of noncombustible materials. In structures where acid fumes deleterious to metal are incidental to the use of the buildings, approved pressure-treated wood or other approved noncorrosive materials are permitted to be used for sash and frames. Framing supporting sloped glazing and skylights shall be designed to resist the tributary roof loads in Chapter 16. Skylights set at an angle of less than 45 degrees (0.79 rad) from the horizontal plane shall be mounted at least 4 inches (102 mm) above the plane of the roof on a curb constructed as required for the frame. Skylights shall not be installed in the plane of the roof where the roof pitch is less than 45 degrees (0.79 rad) from the horizontal.

**Exception:** Installation of a skylight without a curb shall be permitted on roofs with a minimum slope of 14 degrees (three units vertical in 12 units horizontal) in Group R-3 occupancies. All unit skylights installed in a roof with a pitch flatter than 14 degrees (0.24 rad) shall be mounted at least 4 inches (102 mm) above the plane of the roof on a curb constructed as required for the frame unless otherwise specified in the manufacturer's installation instructions.

**2405.5 Unit skylights.** Unit skylights shall be tested and labeled as complying with 101/I.S.2/NAFS Voluntary Performance Specification for Windows, Skylights and Glass. The label shall state the name of the manufacturer, the approved agency, the product designation and the performance grade rating as specified in 101/I.S.2/NAFS. If the product manufacturer has chosen to have the performance grade of the skylight rated separately for positive and negative design pressure, then the label shall state both performance grade ratings as specified in 101/I.S.2/NAFS and the skylight shall comply with Section 2405.5.2. If the skylight is not rated separately for positive and negative pressure, then the performance grade rating shown on the label shall be the performance grade rating determined in accordance with 101/I.S.2/NAFS for both positive and negative design pressure, and the skylight shall conform to Section 2405.5.1.

**2405.5.1 Unit skylights rated for the same performance grade for both positive and negative design pressure.** The design of unit skylights shall be based on the following equation:

**(Equation 24-8 attached to end of document)**

**2405.5.2 Unit skylights rated for separate performance grades for positive and negative design pressure.** The design of unit skylights rated for performance grade for both positive and negative design pressures shall be based on the following equations:

**(Equation 24-9 attached to end of document)**

**(Equation 24-10 attached to end of document)**

## **SECTION BC 2406** **SAFETY GLAZING**

**2406.1 Human impact loads.** Individual glazed areas, including glass mirrors, in hazardous locations as defined in Section 2406.3 shall comply with Sections 2406.1.1 through 2406.1.5.

**2406.1.1 CPSC 16 CFR 1201.** Except as provided in Sections 2406.1.2 through 2406.1.5, all glazing shall pass the test requirements of CPSC 16 CFR 1201, listed in Chapter 35. Glazing shall comply with the CPSC 16 CFR, Part 1201 criteria, for Category I or II as indicated in Table 2406.1.

**2406.1.2 Wired glass.** In other than Group E, wired glass installed in fire doors, fire windows and view panels in fire-resistant walls shall comply with ANSI Z97.1.

**2406.1.3 Plastic glazing.** Plastic glazing shall meet the weathering requirements of ANSI Z97.1.

**2406.1.4 Glass block.** Glass-block walls shall comply with Section 2101.2.5.

**2406.1.5 Louvered windows and jalousies.** Louvered windows and jalousies shall comply with Section 2403.5.

**TABLE 2406.1**  
**MINIMUM CATEGORY CLASSIFICATION OF GLAZING**  
**(Table 2406.1 attached to end of document)**

**2406.2 Identification of safety glazing.** Except as indicated in Section 2406.1.2, each pane of safety glazing installed in hazardous locations shall be identified by a label specifying the labeler, whether the manufacturer or installer, and the safety glazing standard with which it complies, as well as the information specified in Section 2403.1. The label shall be acid etched, sand blasted, ceramic fired or an embossed mark, or shall be of a type that once applied cannot be removed without being destroyed.

**Exceptions:**

1. For other than tempered glass, labels are not required, provided the Department approves the use of a certificate, affidavit or other evidence confirming compliance with this code.
2. Tempered spandrel glass is permitted to be identified by the manufacturer with a removable paper label.

**2406.2.1 Multilight assemblies.** Multilight glazed assemblies having individual lights not exceeding 1 square foot (0.09 square meter) in exposed area shall have at least one light in the assembly marked as indicated in Section 2406.2. Other lights in the assembly shall be marked “CPSC 16 CFR 1201” or “ANSI Z97.1,” as appropriate.

**2406.3 Hazardous locations.** The following shall be considered specific hazardous locations requiring safety glazing materials:

1. Glazing in swinging doors except jalousies (see Section 2406.3.1).
2. Glazing in fixed and sliding panels of sliding door assemblies and panels in sliding and bifold closet door assemblies.
3. Glazing in storm doors.
4. Glazing in unframed swinging doors.
5. Glazing in doors and enclosures for hot tubs, whirlpools, saunas, steam rooms, bathtubs and showers. Glazing in any portion of a building wall enclosing these compartments where the bottom exposed edge of the glazing is less than 60 inches (1524 mm) above a standing surface.

6. Glazing in an individual fixed or operable panel adjacent to a door where the nearest exposed edge of the glazing is within a 24-inch (610 mm) arc of either vertical edge of the door in a closed position and where the bottom exposed edge of the glazing is less than 60 inches (1524 mm) above the walking surface.

**Exceptions:**

1. Panels where there is an intervening wall or other permanent barrier between the door and glazing.
2. Where access through the door is to a closet or storage area 3 feet (914 mm) or less in depth. Glazing in this application shall comply with Section 2406.3, Item 7.
3. Glazing in walls perpendicular to the plane of the door in a closed position, other than the wall towards which the door swings when opened within dwelling units in Group R-2 or R-3.

7. Glazing in an individual fixed or operable panel, other than in those locations described in preceding Items 5 and 6, which meets all of the following conditions:

7.1. Exposed area of an individual pane greater than 9 square feet (0.84 m<sup>2</sup>);

7.2. Exposed bottom edge less than 18 inches (457 mm) above the floor;

7.3. Exposed top edge greater than 36 inches (914 mm) above the floor; and

7.4. One or more walking surface(s) within 36 inches (914 mm) horizontally of the plane of the glazing.

**Exception:** Safety glazing for Item 7 is not required for the following installations:

1. A horizontal protective bar 1½ inches (38 mm) or more in height, capable of withstanding a horizontal load of 50 pounds p/f (730 N/m) without contacting the glass, is installed on the accessible sides of the glazing 34 inches to 38 inches (864 mm to 965 mm) above the floor.
2. The outboard pane in insulating glass units or multiple glazing where the bottom exposed edge of the glass is 25 feet (7620 mm) or more above any grade, roof, walking surface or other horizontal or sloped (within 45 degrees of horizontal) (0.78 rad) surface adjacent to the glass exterior.

8. Glazing in guards and railings, including structural baluster panels and nonstructural in-fill panels, regardless of area or height above a walking surface.



9. Glazing in walls and fences enclosing indoor and outdoor swimming pools, hot tubs and spas where all of the following conditions are present:

9.1. The bottom edge of the glazing on the pool or spa side is less than 60 inches (1524 mm) above a walking surface on the pool or spa side of the glazing; and

9.2. The glazing is within 60 inches (1524 mm) horizontally of the water's edge of a swimming pool or spa.

10. Glazing adjacent to stairways, landings and ramps within 36 inches (914 mm) horizontally of a walking surface; when the exposed surface of the glass is less than 60 inches (1524 mm) above the plane of the adjacent walking surface.

11. Glazing adjacent to stairways within 60 inches (1524 mm) horizontally of the bottom tread of a stairway in any direction when the exposed surface of the glass is less than 60 inches (1524 mm) above the nose of the tread.

**Exception:** Safety glazing for Item 10 or 11 is not required for the following installations where:

1. The side of a stairway, landing or ramp which has a guardrail or handrail, including balusters or in-fill panels, complying with the provisions of Sections 1012 and 1607.7; and

2. The plane of the glass is greater than 18 inches (457 mm) from the railing.

**2406.3.1 Exceptions:** The following products, materials and uses shall not be considered specific hazardous locations:

1. Openings in doors through which a 3-inch (76 mm) sphere is unable to pass.

2. Decorative glass in Section 2406.3, Item 1, 6 or 7.

3. Glazing materials used as curved glazed panels in revolving doors.

4. Commercial refrigerated cabinet glazed doors.

5. Glass-block panels complying with Section 2101.2.5.

6. Louvered windows and jalousies complying with the requirements of Section 2403.5.

7. Mirrors and other glass panels mounted or hung on a surface that provides a continuous backing support.

**2406.4 Fire department access panels.** Fire department glass access panels shall be of tempered glass. For insulating glass units, all panes shall be tempered glass.

### **SECTION BC 2407** **GLASS IN HANDRAILS AND GUARDS**

**2407.1 Materials.** Glass used as structural balustrade panels in railings shall be constructed of either single fully tempered glass, laminated fully tempered glass or laminated heat-strengthened glass. Glazing in railing in-fill panels shall be of an approved safety glazing material that conforms to the provisions of Section 2406.1.1. For all glazing types, the minimum nominal thickness shall be ¼ inch (6.4 mm). Fully tempered glass and laminated glass shall comply with Category II of CPSC 16 CFR 1201, listed in Chapter 35.

**2407.1.1 Loads.** The panels and their support system shall be designed to withstand the loads specified in Section 1607.7. A safety factor of four shall be used.

**2407.1.2 Support.** Each handrail or guard section shall be supported by a minimum of three glass balusters or shall be otherwise supported to remain in place should one baluster panel fail. Glass balusters shall not be installed without an attached handrail or guard.

**2407.1.3 Parking garages.** Glazing materials shall not be installed in railings in parking garages except for pedestrian areas not exposed to impact from vehicles.

### **SECTION BC 2408** **GLAZING IN ATHLETIC FACILITIES**

**2408.1 General.** Glazing in athletic facilities and similar uses subject to impact loads, which forms whole or partial wall sections or which is used as a door or part of a door, shall comply with this section.

#### **2408.2 Racquetball and squash courts.**

**2408.2.1 Testing.** Test methods and loads for individual glazed areas in racquetball and squash courts subject to impact loads shall conform to those of CPSC 16 CFR, Part 1201, listed in Chapter 35, with impacts being applied at a height of 59 inches (1499 mm) above the playing surface to an actual or simulated glass wall installation with fixtures, fittings and methods of assembly identical to those used in practice.

Glass walls shall comply with the following conditions:

1. A glass wall in a racquetball or squash court, or similar use subject to impact loads, shall remain intact following a test impact.
2. The deflection of such walls shall not be greater than 1½ inches (38 mm) at the point of impact for a drop height of 48 inches (1219 mm).

Glass doors shall comply with the following conditions:

1. Glass doors shall remain intact following a test impact at the prescribed height in the center of the door.
2. The relative deflection between the edge of a glass door and the adjacent wall shall not exceed the thickness of the wall plus ½ inch (12.7 mm) for a drop height of 48 inches (1219 mm).

**2408.3 Gymnasium and basketball courts.** Glazing in multipurpose gymnasiums, basketball courts and similar athletic facilities subject to human impact loads shall comply with Category II of CPSC 16 CFR 1201, listed in Chapter 35.

## **SECTION BC 2409** **GLASS IN FLOORS AND SIDEWALKS**

**2409.1 General.** Glass installed in the walking surface of floors, landings, stairwells and similar locations shall comply with Sections 2409.2 through 2409.4.

**2409.2 Design load.** The design for glass used in floors, landings, stair treads and similar locations shall be determined as indicated in Section 2409.4 based on the load that produces the greater stresses from the following:

1. The uniformly distributed unit load ( $F_u$ ) from Section 1607;
2. The concentrated load ( $F_c$ ) from Table 1607.1; or
3. The actual load ( $F_d$ ) produced by the intended use.

The dead load ( $D$ ) for glass in psf ( $\text{kN/m}^2$ ) shall be taken as the total thickness of the glass plies in inches by 13 (For SI: glass plies in mm by 0.0245). Load reductions allowed by Section 1607.9 are not permitted.

**2409.3 Laminated glass.** Laminated glass having a minimum of two plies shall be used. The glass shall be capable of supporting the total design load, as indicated in Section 2409.4, with any one ply broken.

**2409.4 Design formula.** Glass in floors and sidewalks shall be designed to resist the most critical of the following combinations of loads:

**(Equation 24-11 attached to end of document)**

**(Equation 24-12 attached to end of document)**

**(Equation 24-13 attached to end of document)**

**(Equation 24-14 attached to end of document)**

**(Equation 24-15 attached to end of document)**

$$F_{gw} \leq F_{ga} \quad (\text{Equation 24-1})$$

where:

$F_{gw}$  is the wind load on the glass computed in accordance with Section 1609 and  $F_{ga}$  is the maximum allowable load on the glass computed by the following formula:

$$F_{ga} = c_1 F_{ge} \quad (\text{Equation 24-2})$$

where:

$F_{ge}$  = Maximum allowable equivalent load, pounds per square foot (psf) (kN/m<sup>2</sup>) determined from Figures 2404(1) through 2404(12) for the applicable glass dimensions and thickness.

$c_1$  = Factor determined from Table 2404.1 based on glass type.

$$F_g = W_o - D \quad (\text{Equation 24-3})$$

$$F_g = W_i + D + 0.5 S \quad (\text{Equation 24-4})$$

$$F_g = 0.5 W_i + D + S \quad (\text{Equation 24-5})$$

where:

$D$  = Glass dead load (psf)  
For glass sloped 30 degrees (0.52 rad) or less from horizontal,

$$D = 13 t_g \quad (\text{For SI: } 0.0245 t_g)$$

For glass sloped more than 30 degrees (0.52 rad) from horizontal,

$$D = 13 t_g \cos \theta \quad (\text{For SI: } 0.0245 t_g \cos \theta).$$

$F_g$  = Total load, psf (kN/m<sup>2</sup>) on glass.

$S$  = Snow load, psf (kN/m<sup>2</sup>) as determined in Section 1608.

$t_g$  = Total glass thickness, inches (mm) of glass panes and plies.

$W_i$  = Inward wind force, psf (kN/m<sup>2</sup>) as calculated in Section 1609.

$W_o$  = Outward wind force, psf (kN/m<sup>2</sup>) as calculated in Section 1609.

$\theta$  = Angle of slope from horizontal.

**Exception:** Unit skylights shall be designed in accordance with Section 2405.5.

The design of sloped glazing shall be based on the following equation:

$$F_g \leq F_{ga} \quad (\text{Equation 24-6})$$

where  $F_g$  is the maximum load on the glass determined from Equations 24-3 through 24-5, and  $F_{ga}$  is the maximum allowable load on the glass.

If  $F_g$  is determined by Equation 24-3 or 24-4 above,  $F_{ga}$  shall be computed as for vertical glazing in Section 2404.1. If  $F_g$  is determined by Equation 24-5 above,  $F_{ga}$  shall be computed by the following equation:

$$F_{ga} = c_2 F_{ge} \quad (\text{Equation 24-7})$$

where:

$F_{ge}$  = Maximum allowable equivalent load (psf) determined from Figures 2404(1) through 2404(12) for the applicable glass dimensions and thickness.

$c_2$  = Factor determined from Table 2404.2 based on glass type.

$$F_g \leq PG \quad (\text{Equation 24-8})$$

where:

$F_g$  is the maximum load on the skylight determined from Equations 24-3 through 24-5 in Section 2404.2.

$PG$  is the performance grade rating of the skylight.

$$F_{gi} \leq PG_{Pos} \quad (\text{Equation 24-9})$$

$$F_{go} \leq PG_{Neg} \quad (\text{Equation 24-10})$$

where:

$PG_{Pos}$  is the performance grade rating of the skylight under positive design pressure,

$PG_{Neg}$  is the performance grade rating of the skylight under negative design pressure, and

$F_{gi}$  and  $F_{go}$  are determined in accordance with the following:

If  $W_o \geq D$ , where  $W_o$  is the outward wind force, psf (kN/m<sup>2</sup>) as calculated in Section 1609 and  $D$  is the dead weight of the glazing, psf (kN/m<sup>2</sup>) as determined in Section 2404.2 for glass, or by the weight of the plastic, psf (kN/m<sup>2</sup>) for plastic glazing.

$F_{gi}$  is the maximum load on the skylight determined from Equations 24-4 and 24-5 in Section 2404.2,

$F_{go}$  is the maximum load on the skylight determined from Equation 24-3.

If  $W_o < D$ , where  $W_o$  is the outward wind force, psf (kN/m<sup>2</sup>) as calculated in Section 1609 and  $D$  is the dead weight of the glazing, psf (kN/m<sup>2</sup>) as determined in Section 2404.2 for glass, or by the weight of the plastic for plastic glazing.

$F_{gi}$  is the maximum load on the skylight determined from Equations 24-3 through 24-5 in Section 2404.2,

$$F_{go} = 0.$$

$$F_g = 2 F_u + D \quad \text{(Equation 24-11)}$$

$$F_g = (8F_c/A) + D \quad \text{(Equation 24-12)}$$

$$F_g = F_a + D \quad \text{(Equation 24-13)}$$

where:

$A$  = Area of rectangular glass, ft<sup>2</sup> (m<sup>2</sup>).

$D$  = Glass dead load (psf) = 13  $t_g$  (for SI: 0.0245  $t_g$ , kN/m<sup>2</sup>).

$t_g$  = Total glass thickness, inches (mm).

$F_a$  = Actual intended use load, psf (kN/m<sup>2</sup>).

$F_c$  = Concentrated load, pounds (kN).

$F_g$  = Total load, psf (kN/m<sup>2</sup>) on glass.

$F_u$  = Uniformly distributed load, psf (kN/m<sup>2</sup>).

The design of the glazing shall be based on

$$F_g \leq F_{ga} \quad \text{(Equation 24-14)}$$

where  $F_g$  is the maximum load on the glass determined from the load combinations above, and  $F_{ga}$  is the maximum allowable load on the glass, computed by the following formula:

$$F_{ga} = 0.67 c_2 F_{ge} \quad \text{(Equation 24-15)}$$

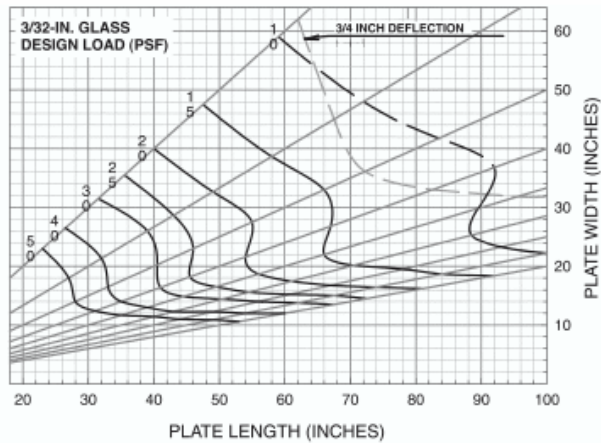
where:

$F_{ge}$  = Maximum allowable equivalent load, psf (kN/m<sup>2</sup>), determined from Figures 2404(1) through 2404(12) for the applicable glass dimensions and thickness; and

$c_2$  = Factor determined from Table 2404.2 based on glass type.

The factor,  $c_2$ , for laminated glass found in Table 2404.2 shall apply to two-ply laminates only. The value of  $F_a$  shall be doubled for dynamic applications.



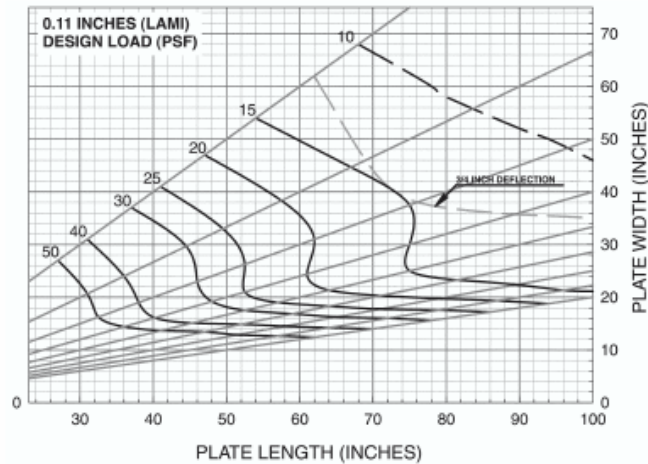


For SI: 1 inch = 25.4 mm, 1 pound per square foot = 0.0479 kPa.

**FIGURE 2404(1)<sup>a, b, c, d, e, f</sup>  
MAXIMUM ALLOWABLE LOAD FOR VERTICAL AND SLOPED  
RECTANGULAR GLASS SUPPORTED ON ALL EDGES**

**NOTES:**

- a. In each graph, the vertical axis is the lesser dimension; the horizontal axis is the greater dimension.
- b. The diagonal number on each graph shows the equivalent design load in psf.
- c. The dashed lines indicate glass that has deflection in excess of  $\frac{3}{4}$  inch.
- d. Interpolation between lines is permitted. Extrapolation is not allowed.
- e. For laminated glass, the applicable glass thickness is the total glass thickness.
- f. For insulating glass panes, the applicable glass thickness is the thickness of one pane.

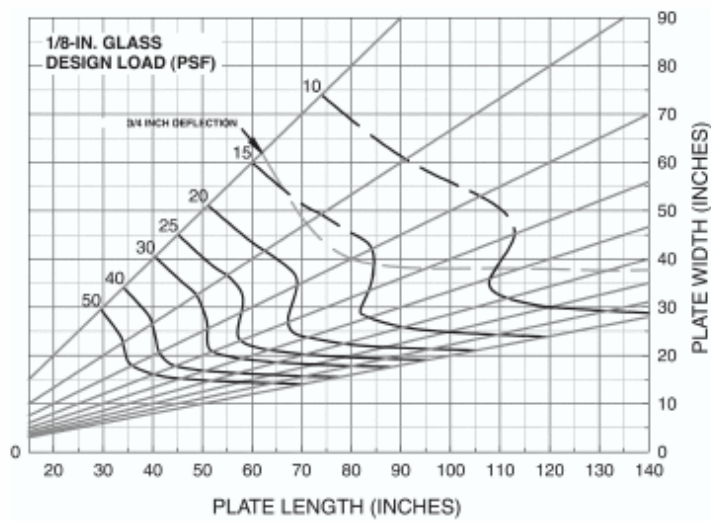


For SI: 1 inch = 25.4 mm, 1 pound per square foot = 0.0479 kPa.

**FIGURE 2404(2)<sup>a, b, c, d, e, f</sup>  
MAXIMUM ALLOWABLE LOAD FOR VERTICAL AND SLOPED  
RECTANGULAR GLASS SUPPORTED ON ALL EDGES**

**NOTES:**

- a. In each graph, the vertical axis is the lesser dimension; the horizontal axis is the greater dimension.
- b. The diagonal number on each graph shows the equivalent design load in psf.
- c. The dashed lines indicate glass that has deflection in excess of  $\frac{3}{4}$  inch.
- d. Interpolation between lines is permitted. Extrapolation is not allowed.
- e. For laminated glass, the applicable glass thickness is the total glass thickness.
- f. For insulating glass panes, the applicable glass thickness is the thickness of one pane.

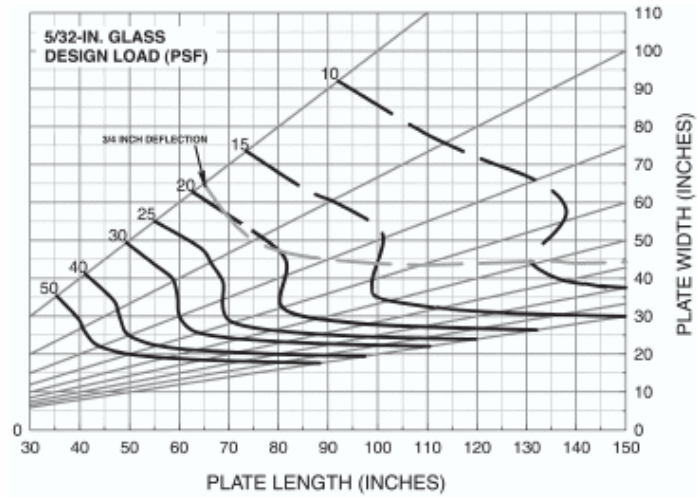


For SI: 1 inch = 25.4 mm, 1 pound per square foot = 0.0479 kPa.

**FIGURE 2404(3)<sup>a, b, c, d, e, f</sup>**  
**MAXIMUM ALLOWABLE LOAD FOR VERTICAL AND SLOPED**  
**RECTANGULAR GLASS SUPPORTED ON ALL EDGES**

**NOTES:**

- a. In each graph, the vertical axis is the lesser dimension; the horizontal axis is the greater dimension.
- b. The diagonal number on each graph shows the equivalent design load in psf.
- c. The dashed lines indicate glass that has deflection in excess of  $\frac{3}{4}$  inch.
- d. Interpolation between lines is permitted. Extrapolation is not allowed.
- e. For laminated glass, the applicable glass thickness is the total glass thickness.
- f. For insulating glass panes, the applicable glass thickness is the thickness of one pane.

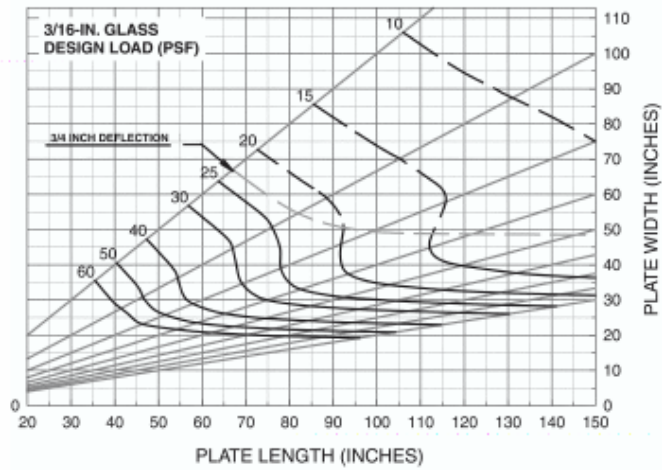


For SI: 1 inch = 25.4 mm, 1 pound per square foot = 0.0479 kPa.

**FIGURE 2404(4)<sup>a, b, c, d, e, f</sup>**  
**MAXIMUM ALLOWABLE LOAD FOR VERTICAL AND SLOPED**  
**RECTANGULAR GLASS SUPPORTED ON ALL EDGES**

**NOTES:**

- a. In each graph, the vertical axis is the lesser dimension; the horizontal axis is the greater dimension.
- b. The diagonal number on each graph shows the equivalent design load in psf.
- c. The dashed lines indicate glass that has deflection in excess of  $3/4$  inch.
- d. Interpolation between lines is permitted. Extrapolation is not allowed.
- e. For laminated glass, the applicable glass thickness is the total glass thickness.
- f. For insulating glass panes, the applicable glass thickness is the thickness of one pane.

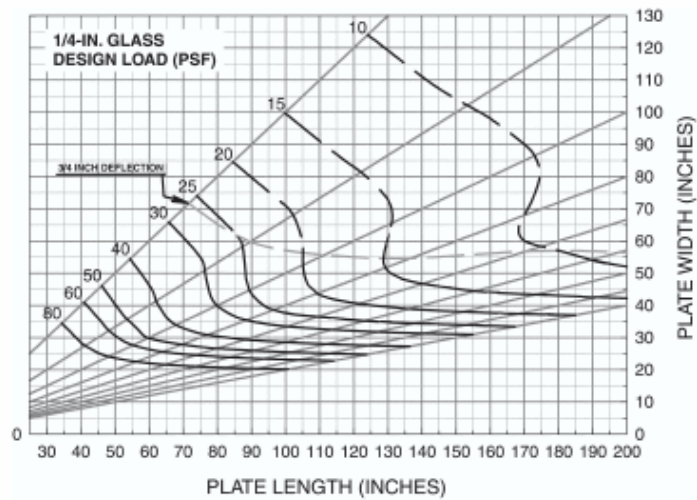


For SI: 1 inch = 25.4 mm, 1 pound per square foot = 0.0479 kPa.

**FIGURE 2404(5)<sup>a, b, c, d, e, f</sup>**  
**MAXIMUM ALLOWABLE LOAD FOR VERTICAL AND SLOPED**  
**RECTANGULAR GLASS SUPPORTED ON ALL EDGES**

**NOTES:**

- In each graph, the vertical axis is the lesser dimension; the horizontal axis is the greater dimension.
- The diagonal number on each graph shows the equivalent design load in psf.
- The dashed lines indicate glass that has deflection in excess of  $\frac{3}{4}$  inch.
- Interpolation between lines is permitted. Extrapolation is not allowed.
- For laminated glass, the applicable glass thickness is the total glass thickness.
- For insulating glass panes, the applicable glass thickness is the thickness of one pane.



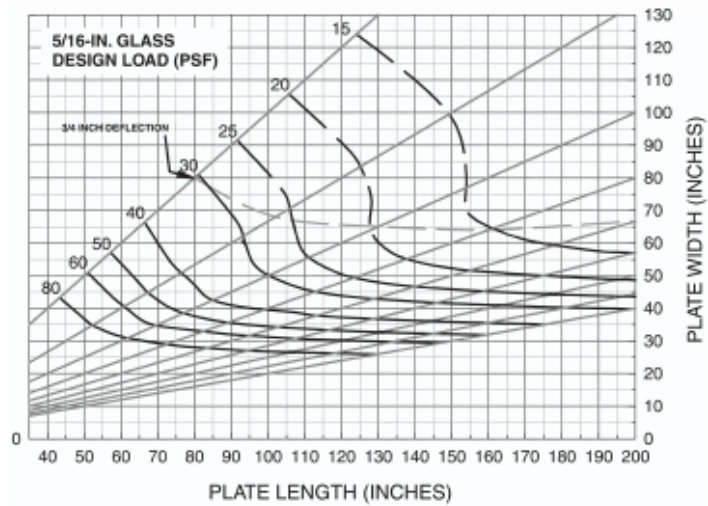
For SI: 1 inch = 25.4 mm, 1 pound per square foot = 0.0479 kPa.

**FIGURE 2404(6)<sup>a, b, c, d, e, f</sup>**  
**MAXIMUM ALLOWABLE LOAD FOR VERTICAL AND SLOPED**  
**RECTANGULAR GLASS SUPPORTED ON ALL EDGES**

**NOTES:**

- a. In each graph, the vertical axis is the lesser dimension; the horizontal axis is the greater dimension.
- b. The diagonal number on each graph shows the equivalent design load in psf.
- c. The dashed lines indicate glass that has deflection in excess of  $3/4$  inch.
- d. Interpolation between lines is permitted. Extrapolation is not allowed.
- e. For laminated glass, the applicable glass thickness is the total glass thickness.
- f. For insulating glass panes, the applicable glass thickness is the thickness of one pane.

**GLASS AND GLAZING**

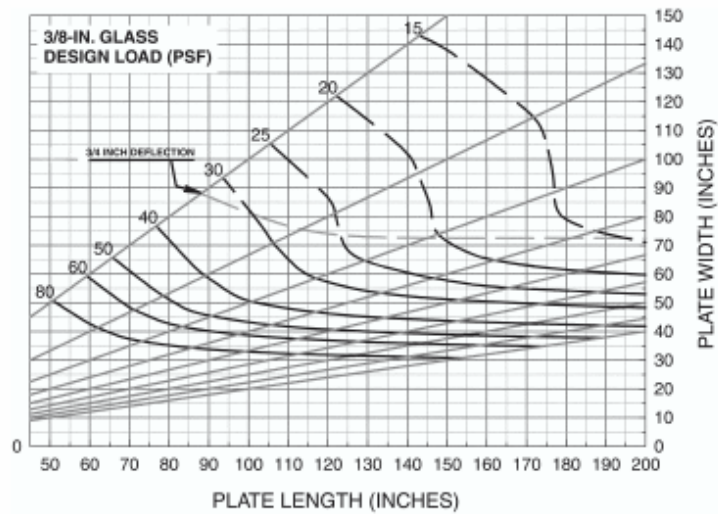


For SI: 1 inch = 25.4 mm, 1 pound per square foot = 0.0479 kPa.

**FIGURE 2404(7)<sup>a, b, c, d, e, f</sup>**  
**MAXIMUM ALLOWABLE LOAD FOR VERTICAL AND SLOPED**  
**RECTANGULAR GLASS SUPPORTED ON ALL EDGES**

**NOTES:**

- a. In each graph, the vertical axis is the lesser dimension; the horizontal axis is the greater dimension.
- b. The diagonal number on each graph shows the equivalent design load in psf.
- c. The dashed lines indicate glass that has deflection in excess of  $\frac{3}{4}$  inch.
- d. Interpolation between lines is permitted. Extrapolation is not allowed.
- e. For laminated glass, the applicable glass thickness is the total glass thickness.
- f. For insulating glass panes, the applicable glass thickness is the thickness of one pane.

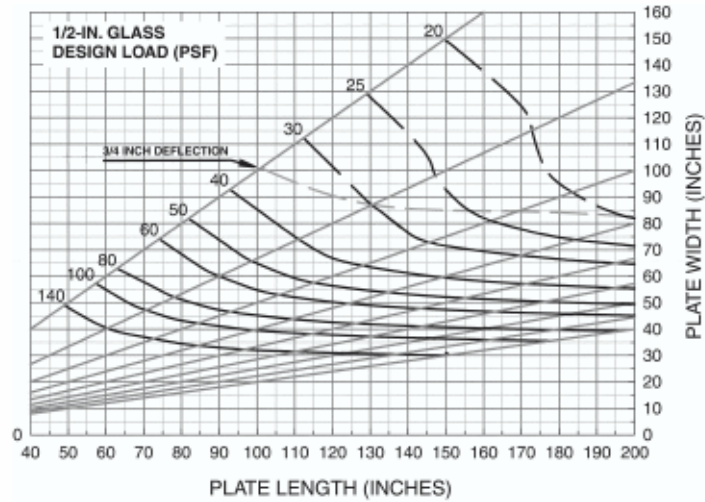


For SI: 1 inch = 25.4 mm, 1 pound per square foot = 0.0479 kPa.

**FIGURE 2404(8)<sup>a, b, c, d, e, f</sup>**  
**MAXIMUM ALLOWABLE LOAD FOR VERTICAL AND SLOPED**  
**RECTANGULAR GLASS SUPPORTED ON ALL EDGES**

**NOTES:**

- a. In each graph, the vertical axis is the lesser dimension; the horizontal axis is the greater dimension.
- b. The diagonal number on each graph shows the equivalent design load in psf.
- c. The dashed lines indicate glass that has deflection in excess of  $\frac{3}{4}$  inch.
- d. Interpolation between lines is permitted. Extrapolation is not allowed.
- e. For laminated glass, the applicable glass thickness is the total glass thickness.
- f. For insulating glass panes, the applicable glass thickness is the thickness of one pane.



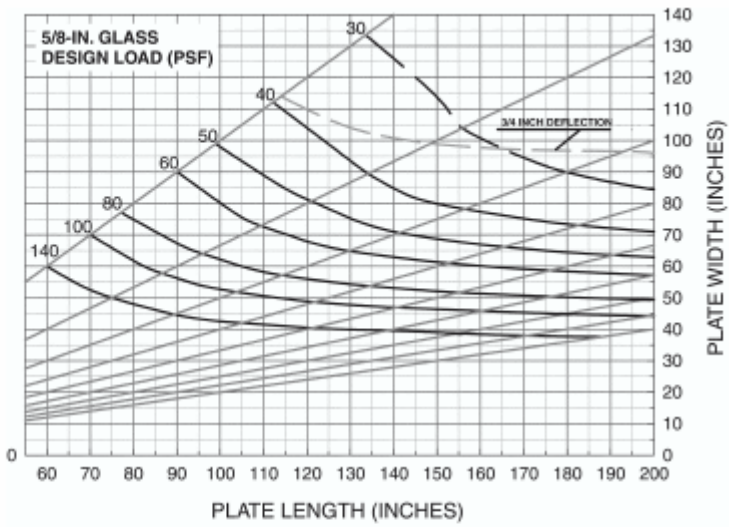
For SI: 1 inch = 25.4 mm, 1 pound per square foot = 0.0479 kPa.

**FIGURE 2404(9)<sup>a, b, c, d, e, f</sup>**  
**MAXIMUM ALLOWABLE LOAD FOR VERTICAL AND SLOPED**  
**RECTANGULAR GLASS SUPPORTED ON ALL EDGES**

**NOTES:**

- a. In each graph, the vertical axis is the lesser dimension; the horizontal axis is the greater dimension.
- b. The diagonal number on each graph shows the equivalent design load in psf.
- c. The dashed lines indicate glass that has deflection in excess of  $\frac{3}{4}$  inch.
- d. Interpolation between lines is permitted. Extrapolation is not allowed.
- e. For laminated glass, the applicable glass thickness is the total glass thickness.
- f. For insulating glass panes, the applicable glass thickness is the thickness of one pane.



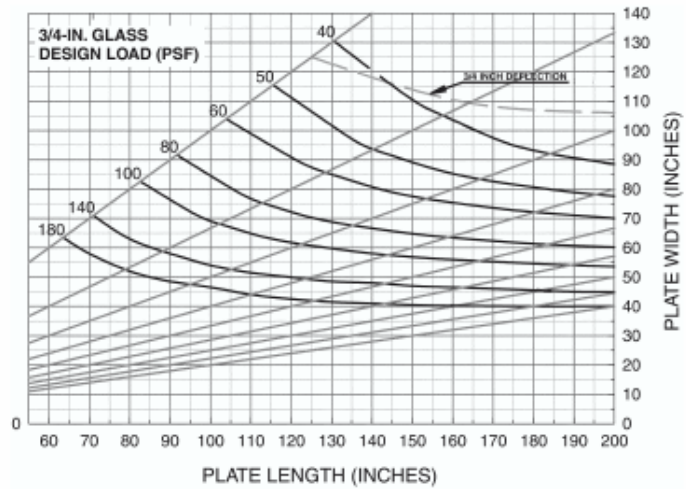


For SI: 1 inch = 25.4 mm, 1 pound per square foot = 0.0479 kPa.

**FIGURE 2404(10)<sup>a, b, c, d, e, f</sup>**  
**MAXIMUM ALLOWABLE LOAD FOR VERTICAL AND SLOPED**  
**RECTANGULAR GLASS SUPPORTED ON ALL EDGES**

**NOTES:**

- In each graph, the vertical axis is the lesser dimension; the horizontal axis is the greater dimension.
- The diagonal number on each graph shows the equivalent design load in psf.
- The dashed lines indicate glass that has deflection in excess of  $\frac{3}{4}$  inch.
- Interpolation between lines is permitted. Extrapolation is not allowed.
- For laminated glass, the applicable glass thickness is the total glass thickness.
- For insulating glass panes, the applicable glass thickness is the thickness of one pane.

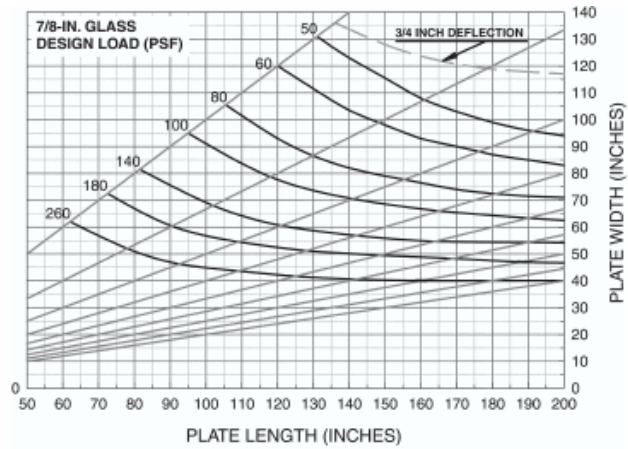


For SI: 1 inch = 25.4 mm, 1 pound per square foot = 0.0479 kPa.

**FIGURE 2404(11)<sup>a, b, c, d, e, f</sup>**  
**MAXIMUM ALLOWABLE LOAD FOR VERTICAL AND SLOPED**  
**RECTANGULAR GLASS SUPPORTED ON ALL EDGES**

**NOTES:**

- a. In each graph, the vertical axis is the lesser dimension; the horizontal axis is the greater dimension.
- b. The diagonal number on each graph shows the equivalent design load in psf.
- c. The dashed lines indicate glass that has deflection in excess of  $3/4$  inch.
- d. Interpolation between lines is permitted. Extrapolation is not allowed.
- e. For laminated glass, the applicable glass thickness is the total glass thickness.
- f. For insulating glass panes, the applicable glass thickness is the thickness of one pane.



For SI: 1 inch = 25.4 mm, 1 pound per square foot = 0.0479 kPa.

**FIGURE 2404(12)<sup>a, b, c, d, e, f</sup>**  
**MAXIMUM ALLOWABLE LOAD FOR VERTICAL AND SLOPED**  
**RECTANGULAR GLASS SUPPORTED ON ALL EDGES**

**NOTES:**

- In each graph, the vertical axis is the lesser dimension; the horizontal axis is the greater dimension.
- The diagonal number on each graph shows the equivalent design load in psf.
- The dashed lines indicate glass that has deflection in excess of  $3/4$  inch.
- Interpolation between lines is permitted. Extrapolation is not allowed.
- For laminated glass, the applicable glass thickness is the total glass thickness.
- For insulating glass panes, the applicable glass thickness is the thickness of one pane.

**TABLE 2404.1**  
**c<sub>1</sub> FACTORS FOR VERTICAL AND SLOPED GLASS<sup>a</sup>**  
**[For use with Figures 2404(1) through 2404(12)]**

GLASS TYPE	FACTOR
<b>Single Glass</b>	
Regular (annealed)	1.0
Heat strengthened	2.0
Fully tempered	4.0
Wired	0.50
Patterned <sup>c</sup>	1.0
Sandblasted <sup>d</sup>	0.50
Laminated—regular plies <sup>e</sup>	0.7/0.90 <sup>f</sup>
Laminated—heat-strengthened plies <sup>e</sup>	1.5/1.8 <sup>f</sup>
Laminated—fully tempered plies <sup>e</sup>	3.0/3.6 <sup>f</sup>
<b>Insulating Glass<sup>b</sup></b>	
Regular (annealed)	1.8
Heat strengthened	3.6
Fully tempered	7.2
Laminated—regular plies <sup>e</sup>	1.4/1.6 <sup>f</sup>
Laminated—heat-strengthened plies <sup>e</sup>	2.7/3.2 <sup>f</sup>
Laminated—fully tempered plies <sup>e</sup>	5.4/6.5 <sup>f</sup>

- a. Either Table 2404.1 or 2404.2 shall be appropriate for sloped glass depending on whether the snow or wind load is dominant (see Section 2404.2). For glass types (vertical or sloped) not included in the tables, refer to ASTM E 1300 for guidance.
- b. Values apply for insulating glass with identical panes.
- c. The value for patterned glass is based on the thinnest part of the pattern; interpolation between graphs is permitted.
- d. The value for sandblasted glass is for moderate levels of sandblasting.
- e. Values for laminated glass are based on the total thickness of the glass and apply for glass with two equal glass ply thicknesses.
- f. The lower value applies if, for any laminated glass pane, either the ratio of the long to short dimension is greater than 2.0 or the lesser dimension divided by the thickness of the pane is 150 or less; the higher value applies in all other cases.

**TABLE 2404.2**  
**c<sub>2</sub> FACTORS FOR SLOPED GLASS<sup>a</sup>**  
**[For use with Figures 2404(1) through 2404(12)]**

GLASS TYPE	FACTOR
<b>Single Glass</b>	
Regular (annealed)	0.6
Heat strengthened	1.6
Fully tempered	3.6
Wired	0.3
Patterned <sup>c</sup>	0.6
Laminated — regular plies <sup>d</sup>	0.3/0.45 <sup>e</sup>
Laminated — heat-strengthened plies <sup>d</sup>	0.8/1.2 <sup>e</sup>
Laminated — fully tempered plies <sup>d</sup>	1.8/2.7 <sup>e</sup>
<b>Insulating Glass<sup>b</sup></b>	
Regular (annealed)	1.1
Heat strengthened	2.9
Fully tempered	6.5
Laminated — regular plies <sup>d</sup>	0.54/0.81 <sup>e</sup>
Laminated — heat-strengthened plies <sup>d</sup>	1.4/2.2 <sup>e</sup>
Laminated — fully tempered plies <sup>d</sup>	3.3/4.9 <sup>e</sup>

- a. Either Table 2404.1 or 2404.2 shall be appropriate for sloped glass depending on whether the snow or wind load is dominant (see Section 2404.2). For glass types (vertical or sloped) not included in the tables, refer to ASTM E 1300 for guidance.
- b. Values apply for insulating glass with identical panes.
- c. The value for patterned glass is based on the thinnest part of the pattern; interpolation between graphs is permitted.
- d. Values for laminated glass are based on the total thickness of the glass and apply for glass with two equal glass ply thicknesses.
- e. The lower value applies where, for any laminated glass pane, either the ratio of the long to short dimension is greater than 2.0 or the lesser dimension divided by the thickness of the pane is 150 or less. The higher value applies in all other cases.

**TABLE 2406.1  
MINIMUM CATEGORY CLASSIFICATION OF GLAZING**

EXPOSED SURFACE AREA OF ONE SIDE OF ONE LITE	GLAZING IN STORM OR COMBINATION DOORS (Category class)	GLAZING IN DOORS (Category class)	GLAZED PANELS REGULATED BY ITEM 7 OF SECTION 2406.3 (Category class)	GLAZED PANELS REGULATED BY ITEM 6 OF SECTION 2406.3 (Category class)	DOORS AND ENCLOSURES REGULATED BY ITEM 5 OF SECTION 2406.3 (Category class)	SLIDING GLASS DOORS PATIO TYPE (Category class)
9 square feet or less	I	I	No requirement	I	II	II
More than 9 square feet	II	II	II	II	II	II

For SI: 1 square foot = 0.0929m<sup>2</sup>.

**CHAPTER 25**  
**GYPSUM BOARD AND PLASTER**

**SECTION BC 2501**  
**GENERAL**

**2501.1 Scope.**

**2501.1.1 General.** Provisions of this chapter shall govern the materials, design, construction and quality of gypsum board, lath, gypsum plaster and cement plaster.

**2501.1.2 Performance.** Lathing, plastering and gypsum board construction shall be done in the manner, and with the materials, specified in this chapter and referenced standards listed in Chapter 35. When fire protection is required, such construction shall also comply with the provisions of Chapter 7.

**2501.1.3 Other materials.** Other approved wall or ceiling coverings shall be permitted to be installed in accordance with the recommendations of the manufacturer and the approval of the commissioner.

**SECTION BC 2502**  
**DEFINITIONS**

**2502.1 Definitions.** The following words and terms shall, for the purposes of this chapter and as used elsewhere in this code, have the meanings shown herein.

**CEMENT PLASTER.** A mixture of portland or blended cement, portland cement or blended cement and hydrated lime, masonry cement or plastic cement and aggregate and other approved materials as specified in this code.

**EXTERIOR SURFACES.** Weather-exposed surfaces.

**GYPSUM BOARD.** Gypsum wallboard, gypsum sheathing, gypsum base for gypsum veneer plaster, exterior gypsum soffit board, predecorated gypsum board or water-resistant gypsum backing board complying with the standards listed in Tables 2506.2, 2507.2 and Chapter 35.

**GYPSUM PLASTER.** A mixture of calcined gypsum or calcined gypsum and lime and aggregate and other approved materials as specified in this code.

**GYPSUM VENEER PLASTER.** Gypsum plaster applied to an approved base in one or more coats normally not exceeding ¼ inch (6.4 mm) in total thickness.

**INTERIOR SURFACES.** Surfaces other than weather-exposed surfaces.

**WEATHER-EXPOSED SURFACES.** Surfaces of walls, ceilings, floors, roofs, soffits

and similar surfaces exposed to the weather except the following:

1. Ceilings and roof soffits enclosed by walls, fascia, bulkheads or beams that extend a minimum of 12 inches (305 mm) below such ceiling or roof soffits.
2. Walls or portions of walls beneath an unenclosed roof area, where located a horizontal distance from an open exterior opening equal to at least twice the height of the opening.
3. Ceiling and roof soffits located a minimum horizontal distance of 10 feet (3048 mm) from the outer edges of the ceiling or roof soffits.

**WIRE BACKING.** Horizontal strands of tautened wire attached to surfaces of vertical supports which, when covered with the building paper, provide a backing for cement plaster.

### **SECTION BC 2503** **RESERVED**

### **SECTION BC 2504** **VERTICAL AND HORIZONTAL ASSEMBLIES**

**2504.1 Scope.** The following requirements shall be met where construction involves gypsum board, lath and plaster in vertical and horizontal assemblies.

**2504.1.1 Wood framing.** Wood supports for lath or gypsum board, as well as wood stripping or furring, shall not be less than 2 inches (51 mm) nominal thickness in the least dimension.

**Exception:** The minimum nominal dimension of wood furring strips installed over solid backing shall not be less than 1 inch by 2 inches (25 mm by 51 mm).

**2504.1.2 Studless partitions.** The minimum thickness of vertically erected studless solid plaster partitions of  $\frac{3}{8}$ -inch (9.5 mm) and  $\frac{3}{4}$ -inch (19.1 mm) rib metal lath or  $\frac{1}{2}$ -inch-thick (12.7 mm) long-length gypsum lath and gypsum board partitions shall be 2 inches (51 mm).

### **SECTION BC 2505** **SHEAR WALL CONSTRUCTION**

**2505.1 Resistance to shear (wood framing).** Wood-framed shear walls sheathed with gypsum board, lath and plaster shall be designed and constructed in accordance with Section 2306.4 and are permitted to resist wind and seismic loads. Walls resisting seismic loads shall be subject to the limitations in Section 1617.6.



2505.2 Resistance to shear (steel framing). Cold-formed steel framed shear walls sheathed with gypsum board and constructed in accordance with the materials and provisions of Sections 2211.1, 2211.2, 2211.2.1 and 2211.2.2.3 are permitted to resist wind and seismic loads. Walls resisting seismic loads shall be subject to the limitations in Section 1617.6.

**SECTION BC 2506**  
**GYPSUM BOARD MATERIALS**

2506.1 General. Gypsum board materials and accessories shall be identified by the manufacturer's designation to indicate compliance with the appropriate standards referenced in this section and stored to protect such materials from the weather.

2506.2 Standards. Gypsum board materials shall conform to the appropriate standards listed in Table 2506.2 and Chapter 35 and, where required for fire protection, shall conform to the provisions of Chapter 7.

2506.2.1 Other materials. Metal suspension systems for acoustical and lay-in panel ceilings shall conform with Section 803.9.

**TABLE 2506.2**  
**GYPSUM BOARD MATERIALS AND ACCESSORIES**  
**(Table 2506.2 attached to end of document)**

**SECTION BC 2507**  
**LATHING AND PLASTERING**

2507.1 General. Lathing and plastering materials and accessories shall be marked by the manufacturer's designation to indicate compliance with the appropriate standards referenced in this section and stored in such a manner to protect them from the weather.

2507.2 Standards. Lathing and plastering materials shall conform to the standards listed in Table 2507.2 and Chapter 35 and, where required for fire protection, shall also conform to the provisions of Chapter 7.

**TABLE 2507.2**  
**LATH, PLASTERING MATERIALS AND ACCESSORIES**  
**(Table 2507.2 attached to end of document)**

**SECTION BC 2508**  
**GYPSUM CONSTRUCTION**

2508.1 General. Gypsum board and gypsum plaster construction shall be of the materials listed in Tables 2506.2 and 2507.2. These materials shall be assembled and installed in compliance with the appropriate standards listed in Tables 2508.1 and 2511.1, and Chapter 35.

**TABLE 2508.1**  
**INSTALLATION OF GYPSUM CONSTRUCTION**  
**(Table 2508.1 attached to end of document)**

**2508.2 Limitations.** Gypsum wallboard or gypsum plaster shall not be used in any exterior surface where such gypsum construction will be exposed directly to the weather. Gypsum wallboard shall not be used where there will be direct exposure to water or continuous high humidity conditions. Gypsum sheathing shall be installed on exterior surfaces in accordance with ASTM C 1280.

**2508.2.1 Weather protection.** Gypsum wallboard, gypsum lath or gypsum plaster shall not be installed until weather protection for the installation is provided.

**2508.3 Single-ply application.** Edges and ends of gypsum board shall occur on the framing members, except those edges and ends that are perpendicular to the framing members. Edges and ends of gypsum board shall be in moderate contact except in concealed spaces where fire-resistance-rated construction, shear resistance or diaphragm action is not required.

**2508.3.1 Floating angles.** Fasteners at the top and bottom plates of vertical assemblies, or the edges and ends of horizontal assemblies perpendicular to supports, and at the wall line are permitted to be omitted except on shear resisting elements or fire-resistance-rated assemblies. Fasteners shall be applied in such a manner as not to fracture the face paper with the fastener head.

**2508.4 Joint treatment.** Gypsum board fire-resistance-rated assemblies shall have joints and fasteners treated.

**Exception:** Joint and fastener treatment need not be provided where any of the following conditions occur:

1. Where the gypsum board is to receive a decorative finish such as wood paneling, battens, acoustical finishes or any similar application that would be equivalent to joint treatment.
2. On single-layer systems where joints occur over wood framing members.
3. Square edge or tongue-and-groove edge gypsum board (V-edge), gypsum backing board or gypsum sheathing.
4. On multilayer systems where the joints of adjacent layers are offset from one to another.
5. Assemblies tested without joint treatment.

**TABLE 2508.5**

**SHEAR CAPACITY FOR HORIZONTAL WOOD FRAMED GYPSUM BOARD  
DIAPHRAGM CEILING ASSEMBLIES  
(Table 2508.5 attached to end of document)**

**2508.5 Horizontal gypsum board diaphragm ceilings.** Gypsum board shall be permitted to be used on wood joists to create a horizontal diaphragm ceiling in accordance with Table 2508.5.

**2508.5.1 Diaphragm proportions.** The maximum allowable diaphragm proportions shall be 1<sup>1</sup>/<sub>2</sub>:1 between shear resisting elements. Rotation or cantilever conditions shall not be permitted.

**2508.5.2 Installation.** Gypsum board used in a horizontal diaphragm ceiling shall be installed perpendicular to ceiling framing members. End joints of adjacent courses of gypsum board shall not occur on the same joist.

**2508.5.3 Blocking of perimeter edges.** All perimeter edges shall be blocked using a wood member not less than 2-inch by 6-inch (51 mm by 152 mm) nominal dimension. Blocking material shall be installed flat over the top plate of the wall to provide a nailing surface not less than 2 inches (51 mm) in width for the attachment of the gypsum board.

**2508.5.4 Fasteners.** Fasteners used for the attachment of gypsum board to a horizontal diaphragm ceiling shall be as defined in Table 2508.5. Fasteners shall be spaced not more than 7 inches (178 mm) on center (o.c.) at all supports, including perimeter blocking, and not more than 3/8 inch (9.5 mm) from the edges and ends of the gypsum board.

**2508.5.5 Lateral force restrictions.** Gypsum board shall not be used in diaphragm ceilings to resist lateral forces imposed by masonry or concrete construction.

**SECTION BC 2509  
GYPSUM BOARD IN SHOWERS  
AND WATER CLOSETS**

**2509.1 Wet areas.** Showers and public toilet walls shall conform to Sections 1210.2 and 1210.3.

**2509.2 Base for tile.** When gypsum board is used as a base for tile or wall panels for tubs, shower or water closet compartment walls, water-resistant gypsum backing board shall be used as a substrate. Regular gypsum wallboard is permitted under tile or wall panels in other wall and ceiling areas when installed in accordance with GA-216 or ASTM C 840.

**2509.3 Limitations.** Water-resistant gypsum backing board shall not be used in the following locations:

1. Over a vapor retarder in shower or bathtub compartments.
2. Where there will be direct exposure to water or in areas subject to continuous high humidity.
3. On ceilings where frame spacing exceeds 12 inches (305 mm) o.c. for ½-inch-thick (12.7 mm) water-resistant gypsum backing board and more than 16 inches (406 mm) o.c. for ⅝-inch-thick (15.9 mm) water-resistant gypsum backing board.

**SECTION BC 2510**  
**LATHING AND FURRING FOR**  
**CEMENT PLASTER (STUCCO)**

**2510.1 General.** Exterior and interior cement plaster and lathing shall be done with the appropriate materials listed in Table 2507.2 and Chapter 35.

**2510.2 Weather protection.** Materials shall be stored in such a manner as to protect such materials from the weather.

**2510.3 Installation.** Installation of these materials shall be in compliance with ASTM C 926 and ASTM C 1063.

**2510.4 Corrosion resistance.** Metal lath and lath attachments shall be of corrosion-resistant material.

**2510.5 Backing.** Backing or a lath shall provide sufficient rigidity to permit plaster applications.

**2510.5.1 Support of lath.** Where lath on vertical surfaces extends between rafters or other similar projecting members, solid backing shall be installed to provide support for lath and attachments.

**2510.5.2 Use of gypsum backing board.**

**2510.5.2.1 Use of gypsum board as a backing board.** Gypsum lath or gypsum wallboard shall not be used as a backing for cement plaster.

**Exception:** Gypsum lath or gypsum wallboard is permitted, with a weather-resistant barrier, as a backing for self-furred metal lath or self-furred wire fabric lath and cement plaster where either of the following conditions occur:

1. On horizontal supports of ceilings or roof soffits.
2. On interior walls.

**2510.5.2.2 Use of gypsum sheathing backing.** Gypsum sheathing is permitted as a backing for metal or wire fabric lath and cement plaster on walls. A weather-resistant barrier shall be provided in accordance with Section 2510.6.

**2510.5.3 Backing not required.** Wire backing is not required under expanded metal lath or paperbacked wire fabric lath.

**2510.6 Weather-resistant barriers.** Weather-resistant barriers shall be installed as required in Section 1404.2 and, where applied over wood-based sheathing, shall include a weather-resistant vapor-permeable barrier with a performance at least equivalent to two layers of Grade D paper.

**2510.7 Preparation of masonry and concrete.** Surfaces shall be clean, free from efflorescence, sufficiently damp and rough for proper bond. If the surface is insufficiently rough, approved bonding agents or a portland cement dash bond coat mixed in proportions of not more than two parts volume of sand to one part volume of portland cement or plastic cement shall be applied. The dash bond coat shall be left undisturbed and shall be moist cured not less than 24 hours.

## **SECTION BC 2511** **INTERIOR PLASTER**

**2511.1 General.** Plastering gypsum plaster or cement plaster shall not be less than three coats where applied over metal lath or wire fabric lath and not less than two coats where applied over other bases permitted by this chapter.

**Exception:** Gypsum veneer plaster and cement plaster specifically designed and approved for one-coat applications.

### **TABLE 2511.1** **INSTALLATION OF PLASTER CONSTRUCTION** **(Table 2511.1 attached to end of document)**

**2511.1.1 Installation.** Installation of lathing and plaster materials shall conform with Table 2511.1 and Section 2507.

**2511.2 Limitations.** Plaster shall not be applied directly to fiber insulation board. Cement plaster shall not be applied directly to gypsum lath or gypsum plaster except as specified in Sections 2510.5.1 and 2510.5.2.

**2511.3 Grounds.** Where installed, grounds shall ensure the minimum thickness of plaster as set forth in ASTM C 842 and ASTM C 926. Plaster thickness shall be measured from the face of lath and other bases.

**2511.4 Interior masonry or concrete.** Condition of surfaces shall be as specified in Section 2510.7. Approved specially prepared gypsum plaster designed for application to

concrete surfaces or approved acoustical plaster is permitted. The total thickness of base coat plaster applied to concrete ceilings shall be as set forth in ASTM C 842 or ASTM C 926. Should ceiling surfaces require more than the maximum thickness permitted in ASTM C 842 or ASTM C 926, metal lath or wire fabric lath shall be installed on such surfaces before plastering.

**2511.5 Wet areas.** Showers and public toilet walls shall conform to Sections 1210.2 and 1210.3. When wood frame walls and partitions are covered on the interior with cement plaster or tile of similar material and are subject to water splash, the framing shall be protected with an approved moisture barrier.

## **SECTION BC 2512** **EXTERIOR PLASTER**

**2512.1 General.** Plastering with cement plaster shall not be less than three coats where applied over metal lath or wire fabric lath and not less than two coats where applied over masonry, concrete or gypsum board backing as specified in Section 2510.5. If the plaster surface is to be completely covered by veneer or other facing material, or is completely concealed by another wall, plaster application need be only two coats, provided the total thickness is as set forth in ASTM C 926.

**2512.1.1 On-grade floor slab.** On wood framed or steel stud construction with an on-grade concrete floor slab system, exterior plaster shall be applied in such a manner as to cover, but not to extend below, the lath and paper. The application of lath, paper and flashing or drip screeds shall comply with ASTM C 1063.

**2512.1.2 Weep screeds.** A minimum 0.019-inch (0.48 mm) (No. 26 galvanized sheet gage), corrosion-resistant weep screed with a minimum vertical attachment flange of  $3\frac{1}{2}$  inches (89 mm) shall be provided at or below the foundation plate line on exterior stud walls in accordance with ASTM C 926. The weep screed shall be placed a minimum of 4 inches (102 mm) above the earth or 2 inches (51 mm) above paved areas and be of a type that will allow trapped water to drain to the exterior of the building. The weather-resistant barrier shall lap the attachment flange. The exterior lath shall cover and terminate on the attachment flange of the weep screed.

**2512.2 Plasticity agents.** Only approved plasticity agents and approved amounts thereof shall be added to portland cement. When plastic cement or masonry cement is used, no additional lime or plasticizers shall be added. Hydrated lime or the equivalent amount of lime putty used as a plasticizer is permitted to be added to cement plaster or cement and lime plaster in an amount not to exceed that set forth in ASTM C 926.

**2512.3 Limitations.** Gypsum plaster shall not be used on exterior surfaces.

**2512.4 Cement plaster.** Plaster coats shall be protected from freezing for a period of not less than 24 hours after set has occurred. Plaster shall be applied when the ambient

temperature is higher than 40°F (4°C), unless provisions are made to keep cement plaster work above 40°F (4°C) during application and 48 hours thereafter.

**2512.5 Second-coat application.** The second coat shall be brought out to proper thickness, rodded and floated sufficiently rough to provide adequate bond for the finish coat. The second coat shall have no variation greater than ¼ inch (6.4 mm) in any direction under a 5-foot (1524 mm) straight edge.

**2512.6 Curing and interval.** First and second coats of cement plaster shall be applied and moist cured as set forth in ASTM C 926 and Table 2512.6.

**TABLE 2512.6**  
**CEMENT PLASTERS<sup>a</sup>**  
**(Table 2512.6 attached at end of document)**

**2512.7 Application to solid backings.** Where applied over gypsum backing as specified in Section 2510.5 or directly to unit masonry surfaces, the second coat is permitted to be applied as soon as the first coat has attained sufficient hardness.

**2512.8 Alternate method of application.** The second coat is permitted to be applied as soon as the first coat has attained sufficiently rigidity to receive the second coat.

**2512.8.1 Admixtures.** When using this method of application, calcium aluminate cement up to 15 percent of the weight of the portland cement is permitted to be added to the mix.

**2512.8.2 Curing.** Curing of the first coat is permitted to be omitted and the second coat shall be cured as set forth in ASTM C 926 and Table 2512.6.

**2512.9 Finish coats.** Cement plaster finish coats shall be applied over base coats that have been in place for the time periods set forth in ASTM C 926. The third or finish coat shall be applied with sufficient material and pressure to bond and to cover the brown coat and shall be of sufficient thickness to conceal the brown coat.

**SECTION BC 2513**  
**EXPOSED AGGREGATE PLASTER**

**2513.1 General.** Exposed natural or integrally colored aggregate is permitted to be partially embedded in a natural or colored bedding coat of cement plaster or gypsum plaster, subject to the provisions of this section.

**2513.2 Aggregate.** The aggregate shall be applied manually or mechanically and shall consist of marble chips, pebbles or similar durable, moderately hard (three or more on the Mohs hardness scale), nonreactive materials.

**2513.3 Bedding coat proportions.** The bedding coat for interior or exterior surfaces shall be composed of one-part portland cement, one-part Type S lime and a maximum of three parts of graded white or natural sand by volume. The bedding coat for interior surfaces shall be composed of 100 pounds (45.4 kg) of neat gypsum plaster and a maximum of 200 pounds (90.8 kg) of graded white sand. A factory-prepared bedding coat for interior or exterior use is permitted. The bedding coat for exterior surfaces shall have a minimum compressive strength of 1,000 pounds per square inch (psi) (6895 kPa).

**2513.4 Application.** The bedding coat is permitted to be applied directly over the first (scratch) coat of plaster, provided the ultimate overall thickness is a minimum of  $\frac{7}{8}$  inch (22 mm), including lath. Over concrete or masonry surfaces, the overall thickness shall be a minimum of  $\frac{1}{2}$  inch (12.7 mm).

**2513.5 Bases.** Exposed aggregate plaster is permitted to be applied over concrete, masonry, cement plaster base coats or gypsum plaster base coats installed in accordance with Section 2511 or 2512.

**2513.6 Preparation of masonry and concrete.** Masonry and concrete surfaces shall be prepared in accordance with the provisions of Section 2510.7.

**2513.7 Curing of base coats.** Cement plaster base coats shall be cured in accordance with ASTM C926. Cement plaster bedding coats shall retain sufficient moisture for hydration (hardening) for 24 hours minimum or, where necessary, shall be kept damp for 24 hours by light water spraying.



**TABLE 2506.2  
GYPSUM BOARD MATERIALS AND ACCESSORIES**

MATERIAL	STANDARD
Accessories for gypsum board	ASTM C 1047
Gypsum sheathing	ASTM C 79
Gypsum wallboard	ASTM C 36
Joint reinforcing tape and compound	ASTM C 474; C 475
Nails for gypsum boards	ASTM C 514, F 547, F 1667
Steel screws	ASTM C 954; C 1002
Steel studs, nonload bearing	ASTM C 645
Steel studs, load bearing	ASTM C 955
Water-resistant gypsum backing board	ASTM C 630
Exterior soffit board	ASTM C 931
Fiber-reinforced gypsum panels	ASTM C 1278
Gypsum backing board and gypsum shaftliner board	ASTM C 442
Gypsum ceiling board	ASTM C 1395
Standard specification for gypsum board	ASTM C 1396
Predecorated gypsum board	ASTM C 960
Adhesives for fastening gypsum wallboard	ASTM C 557
Testing gypsum and gypsum products	ASTM C 22; C 472; C 473
Glass mat gypsum substrate	ASTM C 1177
Glass mat gypsum backing panel	ASTM C 1178

**TABLE 2507.2  
LATH, PLASTERING MATERIALS AND ACCESSORIES**

MATERIAL	STANDARD
Accessories for gypsum veneer base	ASTM C 1047
Exterior plaster bonding compounds	ASTM C 932
Gypsum base for veneer plasters	ASTM C 588
Gypsum casting and molding plaster	ASTM C 59
Gypsum Keene's cement	ASTM C 61
Gypsum lath	ASTM C 37
Gypsum plaster	ASTM C 28
Gypsum veneer plaster	ASTM C 587
Interior bonding compounds, gypsum	ASTM C 631
Lime plasters	ASTM C 5; C 206
Masonry cement	ASTM C 91
Metal lath	ASTM C 847
Plaster aggregates	
Sand	ASTM C 35; C 897
Perlite	ASTM C 35
Vermiculite	ASTM C 35
Plastic cement	ASTM C 1328
Blended cement	ASTM C 595
Portland cement	ASTM C 150
Steel studs and track	ASTM C 645; C 955
Steel screws	ASTM C 1002; C 954
Welded wire lath	ASTM C 933
Woven wire plaster base	ASTM C 1032

**TABLE 2508.1  
INSTALLATION OF GYPSUM CONSTRUCTION**

MATERIAL	STANDARD
Gypsum sheathing	ASTM C 1280
Gypsum veneer base	ASTM C 844
Gypsum board	GA-216; ASTM C 840
Interior lathing and furring	ASTM C 841
Steel framing for gypsum boards	ASTM C 754; C 1007

**TABLE 2508.5  
SHEAR CAPACITY FOR HORIZONTAL WOOD FRAMED GYPSUM BOARD DIAPHRAGM CEILING ASSEMBLIES**

<b>MATERIAL</b>	<b>THICKNESS OF MATERIAL (MINIMUM) (inches)</b>	<b>SPACING OF FRAMING MEMBERS (MAXIMUM) (inches)</b>	<b>SHEAR VALUE<sup>a,b</sup> (plf of ceiling)</b>	<b>MINIMUM FASTENER SIZE</b>
Gypsum board	$\frac{1}{2}$	16 o.c.	90	5d cooler or wallboard nail; 1 $\frac{5}{8}$ -inch long; 0.086-inch shank; $\frac{15}{64}$ -inch head <sup>c</sup>
Gypsum board	$\frac{1}{2}$	24 o.c.	70	5d cooler or wallboard nail; 1 $\frac{5}{8}$ -inch long; 0.086-inch shank; $\frac{15}{64}$ -inch head <sup>c</sup>

For SI: 1 inch = 25.4 mm.

- a. Values are not cumulative with other horizontal diaphragm values and are for short-term loading due to wind or seismic loading. Values shall be reduced 25 percent for normal loading.
- b. Values shall be reduced 50 percent in Seismic Categories D, E and F.
- c. 1 $\frac{1}{4}$ -inch, No. 6 Type S or W screws are permitted to be substituted for the listed nails.

**TABLE 2511.1**  
**INSTALLATION OF PLASTER CONSTRUCTION**

<b>MATERIAL</b>	<b>STANDARD</b>
Gypsum plaster	ASTM C 842
Gypsum veneer plaster	ASTM C 843
Interior lathing and furring (gypsum plaster)	ASTM C 841
Lathing and furring (cement plaster)	ASTM C 1063
Portland cement plaster	ASTM C 926
Steel framing	ASTM C 754; C 1007

**TABLE 2512.6  
CEMENT PLASTERS<sup>a</sup>**

COAT	MINIMUM PERIOD MOIST CURING	MINIMUM INTERVAL BETWEEN COATS
First	48 hours <sup>a</sup>	48 hours <sup>b</sup>
Second	48 hours	7 days <sup>c</sup>
Finish	—	Note c

- a. The first two coats shall be as required for the first coats of exterior plaster, except that the moist-curing time period between the first and second coats shall not be less than 24 hours. Moist curing shall not be required where job and weather conditions are favorable to the retention of moisture in the cement plaster for the required time period.
- b. Twenty-four-hour minimum interval between coats of interior cement plaster. For alternate method of application, see Section 2512.8.
- c. Finish coat plaster is permitted to be applied to interior portland cement base coats after a 48-hour period.

**CHAPTER 26**  
**PLASTIC**

**SECTION BC 2601**  
**GENERAL**

**2601.1 Scope.** These provisions shall govern the materials, design, application, construction and installation of foam plastic, foam plastic insulation, plastic veneer, interior plastic finish and trim, and light-transmitting plastics. See Chapter 14 for requirements for exterior wall finish and trim.

**SECTION BC 2602**  
**DEFINITIONS**

**2602.1 General.** The following words and terms shall, for the purposes of this chapter and as used elsewhere in this code, have the meanings shown herein.

**FOAM PLASTIC INSULATION.** A plastic that is intentionally expanded by the use of a foaming agent to produce a reduced-density plastic containing voids consisting of open or closed cells distributed throughout the plastic for thermal insulating or acoustical purposes and that has a density less than 20 pounds per cubic foot (pcf) (320 kg/m<sup>3</sup>).

**LIGHT-DIFFUSING SYSTEM.** Construction consisting in whole or in part of lenses, panels, grids or baffles made with light-transmitting plastics positioned below independently mounted electrical light sources, skylights or light-transmitting plastic roof panels. Lenses, panels, grids and baffles that are part of an electrical fixture shall not be considered as a light-diffusing system.

**LIGHT-TRANSMITTING PLASTIC ROOF PANELS.** Structural plastic panels other than skylights that are fastened to structural members, or panels or sheathing, and that are used as light-transmitting media in the plane of the roof.

**LIGHT-TRANSMITTING PLASTIC WALL PANELS.** Plastic materials that are fastened to structural members, or to structural panels or sheathing, and that are used as light-transmitting media in exterior walls.

**PLASTIC, APPROVED.** Any thermoplastic, thermosetting or reinforced thermosetting plastic material that conforms to combustibility classifications specified in the section applicable to the application and plastic type.

**PLASTIC GLAZING.** Plastic materials that are glazed or set in frame or sash and not held by mechanical fasteners that pass through the glazing material.

**REINFORCED PLASTIC, GLASS FIBER.** Plastic reinforced with glass fiber having not less than 20 percent of glass fibers by weight.

**THERMOPLASTIC MATERIAL.** A plastic material that is capable of being repeatedly softened by increase of temperature and hardened by decrease of temperature.

**THERMOSETTING MATERIAL.** A plastic material that is capable of being changed into a substantially nonreformable product when cured.

## **SECTION BC 2603** **FOAM PLASTIC INSULATION**

**2603.1 General.** The provisions of this section shall govern the requirements and uses of foam plastic insulation in buildings and structures.

**2603.2 Labeling and identification.** Packages and containers of foam plastic insulation and foam plastic insulation components delivered to the job site shall bear the label of an approved agency showing the manufacturer's name, the product listing, product identification and information sufficient to determine that the end use will comply with the code requirements.

**2603.3 Surface-burning characteristics.** Unless otherwise indicated in this section, foam plastic insulation and foam plastic cores of manufactured assemblies shall have a flame spread index of not more than 75 and a smoke-developed index of not more than 450 where tested in the maximum thickness intended for use in accordance with ASTM E 84. Loose fill-type foam plastic insulation shall be tested as board stock for the flame spread index and smoke-developed index.

### **Exceptions:**

1. Foam plastic interior trim shall comply with the flame spread and smoke-developed indexes as provided for in Section 2604.2.
2. In cold storage buildings, ice plants, food plants, food processing rooms and similar areas, foam plastic insulation where tested in a thickness of 4 inches (102 mm) shall be permitted in a thickness up to 10 inches (254 mm) where the building is equipped throughout with an automatic fire sprinkler system in accordance with Section 903.3.1.1. The approved automatic sprinkler system shall be provided in both the room and that part of the building in which the room is located.
3. Foam plastic insulation that is a part of a Class A, B or C roof-covering assembly shall be exempt from the flame spread requirements of this section provided the assembly with the foam plastic insulation satisfactorily passes FM 4450 or UL 1256. The smoke-developed index shall not be limited for roof applications.
4. Foam plastic insulation greater than 4 inches (102 mm) in thickness shall have a maximum flame spread index of 75 and a smoke-developed index of 450

where tested at a minimum thickness of 4 inches (102 mm), provided the end use is approved in accordance with Section 2603.8 using the thickness and density intended for use.

5. Foam plastic interior signs in covered mall buildings shall not be required to comply with the flame spread and smoke-developed indexes of this section, provided the signs comply with Section 402.14.

**2603.4 Thermal barrier.** Except as provided for in Sections 2603.4.1 and 2603.8, foam plastic shall be separated from the interior of a building by an approved thermal barrier of 0.5-inch (12.7 mm) gypsum wallboard or equivalent thermal barrier material that will limit the average temperature rise of the unexposed surface to not more than 250°F (120°C) after 15 minutes of fire exposure, complying with the standard time-temperature curve of ASTM E 119. The thermal barrier shall be installed in such a manner that it will remain in place for 15 minutes based on FM 4880, UL 1040, NFPA 286 or UL 1715. Combustible concealed spaces shall comply with Section 717.

**2603.4.1 Thermal barrier not required.** The thermal barrier specified in Section 2603.4 is not required under the conditions set forth in Sections 2603.4.1.1 through 2603.4.1.13.

**2603.4.1.1 Masonry or concrete construction.** Foam plastic insulation in a masonry or concrete wall, floor or roof system shall be permitted without a thermal barrier provided that each face is covered by a minimum of 1 inch (25 mm) thickness of masonry or concrete.

**2603.4.1.2 Cooler and freezer walls.** Foam plastic installed in a maximum thickness of 10 inches (254 mm) in cooler and freezer walls shall be permitted without thermal barrier, provided that the walls:

1. Have a flame spread index of 25 or less and a smoke-developed index of not more than 450, where tested in a minimum 4-inch (102 mm) thickness.
2. Have flash ignition and self-ignition temperatures of not less than 600°F and 800°F (316°C and 427°C), respectively.
3. Have a covering of not less than 0.032-inch (0.8 mm) aluminum or corrosion-resistant steel having a base metal thickness not less than 0.0160 inch (0.4 mm) at any point.
4. Are protected by an automatic sprinkler system. Where the cooler or freezer is within a building, both the cooler or freezer and that part of the building in which it is located shall be sprinklered.

**2603.4.1.3 Walk-in coolers.** In nonsprinklered buildings, foam plastic having a thickness that does not exceed 4 inches (102 mm) and a maximum flame spread



index of 75 is permitted without thermal barrier in walk-in coolers or freezer units where the aggregate floor area does not exceed 400 square feet (37 m<sup>2</sup>) and the foam plastic is covered by a metal facing not less than 0.032-inch-thick (0.81 mm) aluminum or corrosion-resistant steel having a minimum base metal thickness of 0.016 inch (0.41 mm). A thickness of up to 10 inches (254 mm) is permitted where protected by a thermal barrier.

**2603.4.1.4 Exterior walls — one-story buildings.** For one-story buildings, foam plastic having a flame spread index of 25 or less, and a smoke-developed index of not more than 450, shall be permitted without thermal barriers in or on exterior walls in a thickness not more than 4 inches (102 mm) where the foam plastic is covered by a thickness of not less than 0.032-inch-thick (0.81 mm) aluminum or corrosion-resistant steel having a base metal thickness of 0.0160 inch (0.41 mm) and the building is equipped throughout with an automatic sprinkler system in accordance with Section 903.3.1.1.

**2603.4.1.5 Roofing.** In construction classes that permit wood sheathing, foam plastic insulation under a roof assembly or roof covering shall be permitted without a thermal barrier, provided that it is installed in accordance with the code and the manufacturer's instructions. It shall be separated from the interior of the building by wood structural panel sheathing not less than 0.47 inch (11.9 mm) in thickness bonded with exterior glue, with edges supported by blocking, tongue-and-groove joints or other approved type of edge support, or an equivalent material. A thermal barrier is not required for foam plastic insulation that is a part of a Class A, B or C roof-covering assembly, provided the assembly with the foam plastic insulation satisfactorily passes FM 4450 or UL 1256.

**2603.4.1.6 Attics and crawl spaces.** Within an attic or crawl space where entry is made only for service of utilities, foam plastic insulation shall be permitted without thermal barrier if protected against ignition by 1.5-inch-thick (38 mm) mineral fiber insulation; 0.25-inch-thick (6.4 mm) wood structural panel, particleboard or hardboard; 0.375-inch (9.5 mm) gypsum wallboard, corrosion-resistant steel having a base metal thickness of 0.016 inch (0.4 mm) or other approved material installed in such a manner that the foam plastic insulation is not exposed. The protective covering shall be consistent with the requirements for the type of construction.

**2603.4.1.7 Doors not required to have a fire protection rating.** Where pivoted or side-hinged doors are permitted without a fire protection rating, foam plastic insulation, having a flame spread index of 75 or less and a smoke-developed index of not more than 450, shall be permitted as a core material without a thermal barrier where the door facing is of metal having a minimum thickness of 0.032-inch (0.8 mm) aluminum or steel having a base metal thickness of not less than 0.016 inch (0.4 mm) at any point.

**2603.4.1.8 Exterior doors in buildings of Group R-2 or R-3.** In occupancies classified as Group R-2 or R-3, foam-filled exterior entrance doors to individual dwelling units that do not require a fire-resistance rating shall be permitted without a thermal barrier, provided that the doors are faced with wood or other approved materials.

**2603.4.1.9 Garage doors.** Where garage doors are permitted without a fire-resistance rating, foam plastic is permitted as a core material, provided that the door facing shall be metal having a minimum thickness of 0.032-inch (0.8 mm) aluminum or 0.010-inch (0.25 mm) steel or the facing shall be minimum 0.125-inch-thick (3.2 mm) wood. Garage doors having facings other than those described above shall be tested in accordance with, and meet the acceptance criteria of DASMA 107.

**2603.4.1.9.1 Garage doors in one- and two-family dwellings.** Garage doors using foam plastic insulation complying with Section 2603.3 in detached and attached garages associated with one- and two-family dwellings need not be provided with a thermal barrier.

**2603.4.1.10 Siding backer board.** Foam plastic insulation of not more than 2,000 British thermal units per square feet (Btu/sq. ft.) (22.7 MJ/m<sup>2</sup>) as determined by NFPA 259 shall be permitted as a siding backer board with a maximum thickness of 0.5 inch (12.7 mm) without a thermal barrier, provided it is separated from the interior of the building by not less than 2 inches (51 mm) of mineral fiber insulation or equivalent or where applied as insulation over existing wall construction.

**2603.4.1.11 Interior trim.** Foam plastic used as interior trim in accordance with Section 2604 shall be permitted without a thermal barrier.

**2603.4.1.12 Interior signs.** Foam plastic used for interior signs in covered mall buildings in accordance with Section 402.14 shall be permitted without a thermal barrier.

**2603.4.1.13 Type V construction.** Foam plastic spray applied to a sill plate and header of Type V construction is permitted without a thermal barrier, subject to all of the following:

1. The maximum thickness of the foam plastic shall be 3¼ inches (82.6 mm).
2. The density of the foam plastic shall be in the range of 1.5 to 2.0 pcf (24 to 32 kg/m<sup>3</sup>).
3. The foam plastic shall have a flame spread index of 25 or less and an accompanying smoke-developed index of 450 or less when tested in accordance with ASTM E84.

**2603.5 Exterior walls of buildings of any height.** Exterior walls of buildings of Type I, II, III or IV construction of any height shall comply with 2603.5.1 through 2603.5.7. Exterior walls of cold storage buildings required to be constructed of noncombustible materials, where the building is more than one story in height, shall also comply with the provisions of Sections 2603.5.1 through 2603.5.7. Exterior walls of buildings of Type V construction shall comply with Sections 2603.2, 2603.3 and 2603.4.

**2603.5.1 Fire-resistance-rated walls.** Where the wall is required to have a fire-resistance rating, data based on tests conducted in accordance with ASTM E 119 shall be provided to substantiate that the fire-resistance rating is maintained.

**2603.5.2 Reserved.**

**2603.5.3 Potential heat.** The potential heat of foam plastic insulation in any portion of the wall or panel shall not exceed the potential heat expressed in Btu per square foot ( $\text{mJ}/\text{m}^2$ ) of the foam plastic insulation contained in the wall assembly tested in accordance with Section 2603.5.5. The potential heat of the foam plastic insulation shall be determined by tests conducted in accordance with NFPA 259 and the results shall be expressed in Btu per square feet ( $\text{mJ}/\text{m}^2$ ).

**Exception:** One-story buildings complying with Section 2603.4.1.4.

**2603.5.4 Flame spread and smoke-developed indexes.** Foam plastic insulation, exterior coatings and facings shall be tested separately in the thickness intended for use, but not to exceed 4 inches (102 mm), and shall each have a flame spread index of 25 or less and a smoke-developed index of 450 or less as determined in accordance with ASTM E 84.

**Exception:** Prefabricated or factory-manufactured panels having minimum 0.020-inch (0.51 mm) aluminum facings and a total thickness of 0.25 inch (6.4 mm) or less are permitted to be tested as an assembly where the foam plastic core is not exposed in the course of construction.

**2603.5.5 Test standard.** The wall assembly shall be tested in accordance with and comply with the acceptance criteria of NFPA 285.

**Exception:** One-story buildings complying with Section 2603.4.1.4.

**2603.5.6 Label required.** The edge or face of each piece of foam plastic insulation shall bear the label of an approved agency. The label shall contain the manufacturer's or distributor's identification, model number, serial number or definitive information describing the product or materials' performance characteristics and approved agency's identification.

**2603.5.7 Ignition.** Exterior walls shall not exhibit sustained flaming where tested in accordance with NFPA 268. Where a material is intended to be installed in more than one thickness, tests of the minimum and maximum thickness intended for use shall be performed.

**Exception:** Assemblies protected on the outside with one of the following:

1. A thermal barrier complying with Section 2603.4.
2. A minimum 1-inch (25 mm) thickness of concrete or masonry.
3. Glass-fiber-reinforced concrete panels of a minimum thickness of 0.375 inch (9.5 mm).
4. Metal-faced panels having minimum 0.019-inch-thick (0.48 mm) aluminum or 0.016-inch thick (0.41 mm) corrosion-resistant steel outer facings.
5. A minimum 0.875-inch (22.2 mm) thickness of stucco complying with Section 2510.

**2603.6 Roofing assembly.** Foam plastic insulation meeting the requirements of Sections 2603.2, 2603.3 and 2603.4 shall be permitted as part of a roof-covering assembly, provided the assembly with the foam plastic insulation is a Class A, B or C roofing assembly where tested in accordance with ASTM E 108 or UL 790.

**2603.7 Plenums.** Foam plastic insulation shall not be used as interior wall or ceiling finish in plenums except as permitted in Section 2604 or when protected by a thermal barrier in accordance with Section 2603.4.

**2603.8 Special approval.** Foam plastic shall not be required to comply with the requirements of Sections 2603.4 through 2603.7, where specifically approved by the department based on large-scale tests such as, but not limited to, FM 4880, UL 1040, NFPA 286 or UL 1715. Such testing shall be related to the actual end-use configuration and be performed on the finished manufactured foam plastic assembly in the maximum thickness intended for use. Foam plastics that are used as interior finish on the basis of special tests shall also conform to the flame spread requirements of Chapter 8. Assemblies tested shall include seams, joints and other typical details used in the installation of the assembly and shall be tested in the manner intended for use.

## **SECTION BC 2604** **INTERIOR FINISH AND TRIM**

**2604.1 General.** Plastic materials installed as interior finish or trim shall comply with Chapter 8. Foam plastics shall only be installed as interior finish where approved in accordance with the special provisions of Section 2603.8. Foam plastics that are used as

interior finish shall also meet the flame spread index requirements for interior finish in accordance with Chapter 8. Foam plastics installed as interior trim shall comply with Section 2604.2.

**2604.2 Foam plastic interior trim.** Foam plastic used as interior trim shall comply with Sections 2604.2.1 through 2604.2.4.

**2604.2.1 Density.** The minimum density of the interior trim shall be 20 pcf (320 kg/m<sup>3</sup>).

**2604.2.2 Thickness.** The maximum thickness of the interior trim shall be 0.5 inch (12.7 mm) and the maximum width shall be 8 inches (204 mm).

**2604.2.3 Area limitation.** The interior trim shall not constitute more than 10 percent of the aggregate wall and ceiling area of any room or space.

**2604.2.4 Flame spread.** The flame spread index shall not exceed 75 where tested in accordance with ASTM E 84. The smoke-developed index shall not be limited.

## **SECTION BC 2605** **PLASTIC VENEER**

**2605.1 Interior use.** Where used within a building, plastic veneer shall comply with the interior finish requirements of Chapter 8.

**2605.2 Exterior use.** Exterior plastic veneer shall be permitted to be installed on the exterior walls of buildings of any type of construction in accordance with all of the following requirements:

1. Plastic veneer shall comply with Section 2606.4.
2. Plastic veneer shall not be attached to any exterior wall to a height greater than 50 feet (15 240 mm) above grade.
3. Sections of plastic veneer shall not exceed 300 square feet (27.9 m<sup>2</sup>) in area and shall be separated by a minimum of 4 feet (1219 mm) vertically.

**Exception:** The area and separation requirements and the smoke-density limitation are not applicable to plastic veneer applied to buildings constructed of Type VB construction, provided the walls are not required to have a fire-resistance rating.

## **SECTION BC 2606** **LIGHT-TRANSMITTING PLASTICS**

**2606.1 General.** The provisions of this section and Sections 2607 through 2611 shall govern the quality and methods of application of light-transmitting plastics for use as

light-transmitting materials in buildings and structures. Foam plastics shall comply with Section 2603. Light-transmitting plastic materials that meet the other code requirements for walls and roofs shall be permitted to be used in accordance with the other applicable chapters of the code.

**2606.2 Approval for use.** Sufficient technical data shall be submitted to substantiate the proposed use of any light-transmitting material, as approved by the department and subject to the requirements of this section.

**2606.3 Identification.** Each unit or package of light-transmitting plastic shall be identified with a mark or decal satisfactory to the commissioner, which includes identification as to the material classification.

**2606.4 Specifications.** Light-transmitting plastics, including thermoplastic, thermosetting or reinforced thermosetting plastic material, shall have a self-ignition temperature of 650°F (343°C) or greater where tested in accordance with ASTM D 1929; a smoke-developed index not greater than 450 where tested in the manner intended for use in accordance with ASTM E 84, or not greater than 75 where tested in the thickness intended for use in accordance with ASTM D 2843 and shall conform to one of the following combustibility classifications:

**Class CC1:** Plastic materials that have a burning extent of 1 inch (25 mm) or less where tested at a nominal thickness of 0.060 inch (1.5 mm), or in the thickness intended for use, in accordance with ASTM D 635,

**Class CC2:** Plastic materials that have a burning rate of 2.5 inches per minute (1.06 mm/s) or less where tested at a nominal thickness of 0.060 inch (1.5 mm), or in the thickness intended for use, in accordance with ASTM D 635.

**2606.5 Structural requirements.** Light-transmitting plastic materials in their assembly shall be of adequate strength and durability to withstand the loads indicated in Chapter 16. Technical data shall be submitted to establish stresses, maximum unsupported spans and such other information for the various thicknesses and forms used as deemed necessary by the department.

**2606.6 Fastening.** Fastening shall be adequate to withstand the loads in Chapter 16. Proper allowance shall be made for expansion and contraction of light-transmitting plastic materials in accordance with accepted data on the coefficient of expansion of the material and other material in conjunction with which it is employed.

**2606.7 Light-diffusing systems.** Light diffusing systems shall comply with Sections 2603.7.1 through 2603.7.6. Light-diffusing systems shall not be installed in the following occupancies and locations:

1. Any room in which the net floor area per occupant is 20 square feet (1.86 m<sup>2</sup>) or less, or any room leading therefrom through which it is necessary for occupants to pass in order to reach the only exit.
2. Group I-2.
3. Group I-3.
4. Exit stairways and exit passageways.

**2606.7.1 Support.** Light-transmitting plastic diffusers shall be supported directly or indirectly from ceiling or roof construction by use of noncombustible hangers. Hangers shall be at least No. 12 steel-wire gage (0.106 inch) galvanized wire or equivalent.

**Exception:** Light-transmitting plastic diffusers used in suspended acoustical ceiling systems shall conform with the support requirements as set forth in Section 803.9.

**2606.7.2 Installation.** Light-transmitting plastic diffusers shall comply with Chapter 8 unless the light-transmitting plastic diffusers will fall from the mountings before igniting, at an ambient temperature of at least 200°F (93°C) below the ignition temperature of the panels. The panels shall remain in place at an ambient room temperature of 175°F (79°C) for a period of not less than 15 minutes.

**2606.7.3 Size limitations.** Individual panels or units shall not exceed 10 feet (3048 mm) in length nor 30 square feet (2.79 m<sup>2</sup>) in area.

**2606.7.4 Fire suppression system.** In buildings that are equipped throughout with an automatic sprinkler system in accordance with Section 903.3.1.1, plastic light-diffusing systems shall be protected both above and below unless the sprinkler system has been specifically approved for installation only above the light-diffusing system. Areas of light-diffusing systems that are protected in accordance with this section shall not be limited.

**2606.7.5 Electrical lighting fixtures.** Light-transmitting plastic panels and light-diffuser panels that are installed in approved electrical lighting fixtures shall comply with the requirements of Chapter 8 unless the light-transmitting plastic panels conform to the requirements of Section 2606.7.2.

**2606.8 Partitions.** Light-transmitting plastics used in or as partitions shall comply with the requirements of Chapters 6 and 8.

**2606.9 Bathroom accessories.** Light-transmitting plastics shall be permitted as glazing in shower stalls, shower doors, bathtub enclosures and similar accessory units. Safety glazing shall be provided in accordance with Chapter 24.

**2606.10 Awnings, patio covers and similar structures.** Awnings constructed of light-transmitting plastics shall be constructed in accordance with provisions specified in Section 3105 and Chapter 32 for projections and appendages. Patio covers constructed of light-transmitting plastics shall comply with Section 2606. Light-transmitting plastics used in canopies at motor fuel-dispensing facilities shall comply with Section 2606 except as modified by Section 406.5.2.

**2606.11 Greenhouses.** Light-transmitting plastics shall be permitted in lieu of plain glass in greenhouses.

**2606.12 Solar collectors.** Light-transmitting plastic covers on solar collectors having noncombustible sides and bottoms shall be permitted on buildings not over three stories in height or 9,000 square feet (836.1 m<sup>2</sup>) in total floor area, provided the light-transmitting plastic cover does not exceed 33.33 percent of the roof area for CC1 materials or 25 percent of the roof area for CC2 materials.

**Exception:** Light-transmitting plastic covers having a thickness of 0.010 inch (0.3 mm) or less or shall be permitted to be of any plastic material provided the area of the solar collectors does not exceed 33.33 percent of the roof area.

## **SECTION BC 2607** **LIGHT-TRANSMITTING PLASTIC WALL PANELS**

**2607.1 General.** Light-transmitting plastics shall be permitted to be used as wall panels in exterior walls, provided that the walls are not required to have a fire-resistance rating and the installation conforms to the requirements of this section. Such panels shall be erected and anchored on a foundation, waterproofed or otherwise protected from moisture absorption and sealed with a coat of mastic or other approved waterproof coating. Light-transmitting plastic wall panels shall also comply with Section 2606.

**Exception:** Light-transmitting plastics shall not be used as wall panels in exterior walls in occupancies in Groups A-1, A-2, H, I-2 and I-3.

**2607.2 Installation.** Exterior wall panels installed as provided for herein shall not alter the type of construction classification of the building.

**2607.3 Height limitation.** Light-transmitting plastics shall not be installed more than 75 feet (22 860 mm) above grade plane, except as allowed by Section 2607.5.

**2607.4 Area limitation and separation.** The maximum area of a single wall panel and minimum vertical and horizontal separation requirements for exterior light-transmitting plastic wall panels shall be as provided for in Table 2607.4. The maximum percentage of wall area of any story in light-transmitting plastic wall panels shall not exceed that indicated in Table 2607.4 or the percentage of unprotected openings permitted by Section 704.8, whichever is smaller.



**Exceptions:**

1. In structures provided with approved flame barriers extending 30 inches (760 mm) beyond the exterior wall in the plane of the floor, a vertical separation is not required at the floor except that provided by the vertical thickness of the flame barrier projection.
2. Veneers of approved weather-resistant light-transmitting plastics used as exterior siding in buildings of Type V construction in compliance with Section 1406.
3. The area of light-transmitting plastic wall panels in exterior walls of greenhouses shall be exempt from the area limitations of Table 2607.4 but shall be limited as required for unprotected openings in accordance with Section 704.8.

**TABLE 2607.4**  
**AREA LIMITATION AND SEPARATION REQUIREMENTS FOR LIGHT-**  
**TRANSMITTING PLASTIC WALL PANELS<sup>a</sup>**  
**(Table 2607.4 attached to end of document)**

**2607.5 Automatic sprinkler system.** Where the building is equipped throughout with an automatic sprinkler system in accordance with Section 903.3.1.1, the maximum percentage area of exterior wall in any story in light-transmitting plastic wall panels and the maximum square footage of a single area given in Table 2607.4 shall be increased 100 percent, but the area of light-transmitting plastic wall panels shall not exceed 50 percent of the wall area in any story, or the area permitted by Section 704.8 for unprotected openings, whichever is smaller. These installations shall be exempt from height limitations.

**2607.6 Combinations of glazing and wall panels.** Combinations of light-transmitting plastic glazing and light-transmitting plastic wall panels shall be subject to the area, height and percentage limitations and the separation requirements applicable to the class of light-transmitting plastic as prescribed for light-transmitting plastic wall panel installations.

**SECTION BC 2608**  
**LIGHT-TRANSMITTING PLASTIC GLAZING**

**2608.1 Buildings of Type VB construction.** Openings in the exterior walls of buildings of Type VB construction, where not required to be protected by Section 704, shall be permitted to be glazed or equipped with light-transmitting plastic. Light-transmitting plastic glazing shall also comply with Section 2606.

**2608.2 Buildings of other types of construction.** Openings in the exterior walls of

buildings of types of construction other than Type VB, where not required to be protected by Section 704, shall be permitted to be glazed or equipped with light-transmitting plastic in accordance with Section 2606 and all of the following:

1. The aggregate area of light-transmitting plastic glazing shall not exceed 25 percent of the area of any wall face of the story in which it is installed. The area of a single pane of glazing installed above the first story above grade plane shall not exceed 16 square feet (1.5 m<sup>2</sup>) and the vertical dimension of a single pane shall not exceed 4 feet (1219 mm).

**Exception:** Where an automatic sprinkler system is provided throughout in accordance with Section 903.3.1.1, the area of allowable glazing shall be increased to a maximum of 50 percent of the wall face of the story in which it is installed with no limit on the maximum dimension or area of a single pane of glazing.

2. Approved flame barriers extending 30 inches (762 mm) beyond the exterior wall in the plane of the floor, or approved vertical panels not less than 4 feet (1219 mm) in height, shall be installed between glazed units located in adjacent stories.

**Exception:** Approved vertical panels not less than 3 feet (914 mm) in height or flame barriers extending 30 inches (762 mm) beyond the exterior wall shall be installed between glazed units located in adjacent stories in buildings equipped throughout with an automatic sprinkler system in accordance with Section 903.3.1.1.

3. Light-transmitting plastics shall not be installed more than 75 feet (22 860 mm) above grade level.

**Exception:** Buildings equipped throughout with an automatic sprinkler system in accordance with Section 903.3.1.1.

## **SECTION BC 2609** **LIGHT-TRANSMITTING PLASTIC ROOF PANELS**

**2609.1 General.** Light-transmitting plastic roof panels shall comply with this section and Section 2606. Light-transmitting plastic roof panels shall not be installed in Groups H, I-2 and I-3. In all other groups, light-transmitting plastic roof panels shall comply with any one of the following conditions:

1. The building is equipped throughout with an automatic sprinkler system in accordance with Section 903.3.1.1.
2. The roof construction is not required to have a fire-resistance rating by Table 601.
3. The roof panels meet the requirements for roof coverings in accordance with Chapter 15.

**2609.2 Separation.** Individual roof panels shall be separated from each other by a distance of not less than 4 feet (1219 mm) measured in a horizontal plane.

**Exceptions:**

1. The separation between roof panels is not required in a building equipped throughout with an automatic sprinkler system in accordance with Section 903.3.1.1.
2. The separation between roof panels is not required in low-hazard occupancy buildings complying with the conditions of Section 2609.4, Exception 2 or 3.

**2609.3 Location.** Where exterior wall openings are required to be protected by Section 704.8, a roof panel shall not be installed within 6 feet (1829 mm) of such exterior wall.

**2609.4 Area limitations.** Roof panels shall be limited in area and the aggregate area of panels shall be limited by a percentage of the floor area of the room or space sheltered in accordance with Table 2609.4.

**Exceptions:**

1. The area limitations of Table 2609.4 shall be permitted to be increased by 100 percent in buildings equipped throughout with an automatic sprinkler system in accordance with Section 903.3.1.1.
2. Low-hazard occupancy buildings, such as swimming pool shelters, shall be exempt from the area limitations of Table 2609.4, provided that the buildings do not exceed 5,000 square feet (465 m<sup>2</sup>) in area and have a minimum fire separation distance of 10 feet (3048 mm).
3. Greenhouses that are occupied for growing plants on a production or research basis, without public access, shall be exempt from the area limitations of Table 2609.4 provided they have a minimum fire separation distance of 4 feet (1219 mm).
4. Roof coverings over terraces and patios in Group R-3 occupancies shall be exempt from the area limitations of Table 2609.4.

**TABLE 2609.4**  
**AREA LIMITATIONS FOR LIGHT TRANSMITTING PLASTIC ROOF PANELS**  
**(Table 2609.4 attached to end of document)**

**SECTION BC 2610**  
**LIGHT-TRANSMITTING PLASTIC**  
**SKYLIGHT GLAZING**

**2610.1 Light-transmitting plastic glazing of skylight assemblies.** Skylight assemblies glazed with light-transmitting plastic shall conform to the provisions of this section and Section 2606. Unit skylights glazed with light-transmitting plastic shall also comply with Section 2405.5.

**Exception:** Skylights in which the light-transmitting plastic conforms to the required roof-covering class in accordance with Section 1505.

**2610.2 Mounting.** The light-transmitting plastic shall be mounted above the plane of the roof on a curb constructed in accordance with the requirements for the type of construction classification, but at least 4 inches (102 mm) above the plane of the roof. Edges of light-transmitting plastic skylights or domes shall be protected by metal or other approved noncombustible material, or the light-transmitting plastic dome or skylight shall be shown to be able to resist ignition where exposed at the edge to a flame from a Class B brand as described in ASTM E 108 or UL 790.

**Exceptions:**

1. Curbs shall not be required for skylights used on roofs having a minimum slope of three units vertical in 12 units horizontal (25-percent slope) in occupancies in Group R-3 and on buildings with a nonclassified roof covering.
2. The metal or noncombustible edge material is not required where nonclassified roof coverings are permitted.

**2610.3 Slope.** Flat or corrugated light-transmitting plastic skylights shall slope at least four units vertical in 12 units horizontal (4:12). Dome-shaped skylights shall rise above the mounting flange a minimum distance equal to 10 percent of the maximum span of the dome but not less than 3 inches (76 mm).

**Exception:** Skylights that pass the Class B Burning Brand Test specified in ASTM E 108 or UL 790 shall have no minimum slope requirement.

**2610.4 Maximum area of skylights.** Each skylight shall have a maximum area within the curb of 100 square feet (9.3 m<sup>2</sup>).

**Exception:** The area limitation shall not apply where the building is equipped throughout with an automatic sprinkler system in accordance with Section 903.3.1.1 or the building is equipped with smoke and heat vents in accordance with Section 910.

**2610.5 Aggregate area of skylights.** The aggregate area of skylights shall not exceed 33<sup>1</sup>/<sub>3</sub> percent of the floor area of the room or space sheltered by the roof in which such

skylights are installed where Class CC1 materials are utilized, and 25 percent where Class CC2 materials are utilized.

**Exception:** The aggregate area limitations of light-transmitting plastic skylights shall be increased 100 percent beyond the limitations set forth in this section where the building is equipped throughout with an automatic sprinkler system in accordance with Section 903.3.1.1 or the building is equipped with smoke and heat vents in accordance with Section 910.

**2610.6 Separation.** Skylights shall be separated from each other by a distance of not less than 4 feet (1219 mm) measured in a horizontal plane.

**Exceptions:**

1. Buildings equipped throughout with an automatic sprinkler system in accordance with Section 903.3.1.1.
2. In Group R-3, multiple skylights located above the same room or space with a combined area not exceeding the limits set forth in Section 2610.4.

**2610.7 Location.** Where exterior wall openings are required to be protected in accordance with Section 704, a skylight shall not be installed within 6 feet (1829 mm) of such exterior wall.

**2610.8 Combinations of roof panels and skylights.** Combinations of light-transmitting plastic roof panels and skylights shall be subject to the area and percentage limitations and separation requirements of Section 2609 applicable to roof panel installations.

**SECTION BC 2611**  
**LIGHT-TRANSMITTING PLASTIC INTERIOR SIGNS**

**2611.1 General.** Light-transmitting plastic interior wall signs shall be limited as specified in Sections 2611.2 through 2611.4. Light-transmitting plastic interior wall signs in covered mall buildings shall comply with Section 402.14. Light-transmitting plastic interior signs shall also comply with Section 2606.

**2611.2 Aggregate area.** The sign shall not exceed 20 percent of the wall area.

**2611.3 Maximum area.** The sign shall not exceed 24 square feet (2.2 m<sup>2</sup>).

**2611.4 Encasement.** Edges and backs of the sign shall be fully encased in metal.

**TABLE 2607.4  
AREA LIMITATION AND SEPARATION REQUIREMENTS FOR  
LIGHT-TRANSMITTING PLASTIC WALL PANELS<sup>a</sup>**

FIRE SEPARATION DISTANCE (feet)	CLASS OF PLASTIC	MAXIMUM PERCENTAGE AREA OF EXTERIOR WALL IN PLASTIC WALL PANELS	MAXIMUM SINGLE AREA OF PLASTIC WALL PANELS (square feet)	MINIMUM SEPARATION OF PLASTIC WALL PANELS (feet)	
				Vertical	Horizontal
Less than 6	—	Not Permitted	Not Permitted	—	—
6 or more but less than 11	CC1	10	50	8	4
	CC2	Not Permitted	Not Permitted	—	—
11 or more but less than or equal to 30	CC1	25	90	6	4
	CC2	15	70	8	4
Over 30	CC1	50	Not Limited	3 <sup>b</sup>	0
	CC2	50	100	6 <sup>b</sup>	3

For SI: 1 foot = 304.8 mm, 1 square foot = 0.0929 m<sup>2</sup>.

a. For combinations of plastic glazing and plastic wall panel areas permitted, see Section 2607.6.

b. For reductions in vertical separation allowed, see Section 2607.4.

**TABLE 2609.4  
AREA LIMITATIONS FOR LIGHT-TRANSMITTING  
PLASTIC ROOF PANELS**

CLASS OF PLASTIC	MAXIMUM AREA OF INDIVIDUAL ROOF PANELS (square feet)	MAXIMUM AGGREGATE AREA OF ROOF PANELS (percent of floor area)
CC1	300	30
CC2	100	25

For SI: 1 square foot = 0.0929 m<sup>2</sup>.

**CHAPTER 27**  
**ELECTRICAL**

**SECTION BC 2701**  
**GENERAL**

**2701.1 Scope.** This chapter governs the electrical components, equipment and systems used in buildings and structures covered by this code. Electrical components, equipment and systems shall be designed and constructed in accordance with the provisions of the *New York City Electrical Code*.

**SECTION BC 2702**  
**EMERGENCY POWER SYSTEMS**

**2702.1 Installation.** Emergency systems shall be installed in accordance with the *New York City Electrical Code*, NFPA 110 and NFPA 111, and shall have an on-premises fuel supply sufficient for not less than 6-hour full-demand operation of the system. However, for R-2 occupancies required to provide emergency power systems pursuant to the provisions of Section 403.11.2, and for voluntarily installed emergency power systems, natural gas from the public utility street main shall be permitted as fuel supply.

**2702.1.1 Stationary generators.** Emergency power generators shall be listed in accordance with UL 2200.

**2702.1.2 Capacity.** The emergency power system shall have a capacity and rating that supplies all equipment required to be operational at the same time.

**2702.2 Where required.** Emergency power systems shall be provided where required by this section.

**2702.2.1 Group A occupancies.** Emergency power shall be provided for voice/alarm communication systems in Group A occupancies in accordance with Section 907.2.1.2.

**2702.2.2 Smoke control systems.** Emergency power shall be provided for smoke control systems in accordance with Section 909.11.

**2702.2.3 Exit signs.** Emergency power shall be provided for exit signs in accordance with Section 1011.5.3.

**2702.2.4 Means of egress illumination.** Emergency power shall be provided for means of egress illumination in accordance with Section 1006.3.

**2702.2.5 Accessible means of egress elevators.** Emergency power shall be provided for elevators that are part of an accessible means of egress in accordance with Section 1007.4

**2702.2.6 Horizontal sliding doors.** Emergency power shall be provided for horizontal sliding doors in accordance with Section 1008.1.3.3

**2702.2.7 Semiconductor fabrication facilities.** Emergency power shall be provided for semiconductor fabrication facilities in accordance with Section 415.9.10.

**2702.2.8 Membrane structures.** Emergency power shall be provided for auxiliary inflation systems in accordance with Section 3102.8.2. Emergency power shall be provided for exit signs in tents and membrane structures.

**2702.2.9 Hazardous materials.** Emergency power shall be provided in occupancies with hazardous materials in accordance with Section 414.5.4 and the *New York City Fire Code*.

**2702.2.10 Highly toxic and toxic materials.** Emergency power shall be provided for occupancies with highly toxic or toxic materials in accordance with the *New York City Fire Code*.

**2702.2.11 Organic peroxides.** Emergency power shall be provided for occupancies with organic peroxides in accordance with the *New York City Fire Code*.

**2702.2.12 Pyrophoric materials.** Emergency power shall be provided for occupancies with silane gas in accordance with the *New York City Fire Code*.

**2702.2.13 Covered mall buildings.** Emergency power shall be provided for voice/alarm communication systems in covered mall buildings in accordance with Section 402.12

**2702.2.14 High-rise buildings.** Emergency power shall be provided in high-rise buildings in accordance with Section 403.11.

**2702.2.15 Underground buildings.** Emergency power shall be provided in underground buildings in accordance with Section 405.10.

**2702.2.16 Group I-3 occupancies.** Emergency power shall be provided for doors in Group I-3 occupancies in accordance with Section 408.4.2.

**2702.2.17 Reserved.**

**2702.2.18 Elevators.** Emergency power for elevators, including elevators provided to accommodate ambulance stretchers pursuant to Section 3002.4, shall be provided as set forth in Section 3003.1

**2702.2.19 Smokeproof enclosures and pressurized elevator shaft.** Emergency power shall be provided for smoke-proof enclosures as required by Section 909.20



and for pressurized elevator shafts provided in accordance with Item 5 of Section 403.9.1.1.

**2702.2.20 Occupancy Groups B, E and R-1.** An emergency power system shall be required in those Group B, E and R-1 occupancies specified in this section:

1. Group B occupancies with occupied floor less than 75 feet (22 860 mm) above the lowest fire department vehicle access having a gross floor area over 15,000 square feet (1,393.6 m<sup>2</sup>) per floor or a total gross floor area of 100,000 square feet (9,290.3 m<sup>2</sup>) or more.
2. Group E occupancies with occupied floor less than 75 feet (22 860 mm) above the lowest level of fire department vehicle access having a gross floor area over 15, 000 square feet (1,393.6 m<sup>2</sup>) per floor or a total gross floor area of 100,000 square feet (9,290.3 m<sup>2</sup>) or more.
3. All Group R-1 occupancies.

**2702.2.20.1 Equipment requiring emergency power system.** With respect to such occupancy Groups B, E and R-1, the following equipment, where such equipment is required by this code, shall be provided with an emergency power system:

1. Exit signs and means of egress illumination required by Chapter 10;
2. Elevator car lighting;
3. Emergency voice/alarm communications systems;
4. Automatic fire detection systems;
5. Fire alarm systems;
6. Electrically powered fire pumps;
7. Ventilating systems used for smoke venting or control;
8. Stair pressurization;
9. At least three elevators in a building at one time with manual transfer to other elevators as required by Section 3003.

**2702.3 Maintenance.** Emergency power systems shall be maintained and tested in accordance with the *New York City Fire Code* and *New York City Electrical Code*.

**CHAPTER 28**  
**MECHANICAL SYSTEMS**

**SECTION BC 2801**  
**GENERAL**

**2801.1 Scope.** Mechanical appliances, equipment and systems shall be constructed, installed and maintained in accordance with the *New York City Mechanical Code* and the *New York City Fuel Gas Code*. Masonry chimneys, fireplaces and barbecues shall comply with the *New York City Mechanical Code* and Chapter 21 of this code.

**CHAPTER 29**  
**PLUMBING SYSTEMS**

**SECTION BC 2901**  
**GENERAL**

**2901.1 Scope.** The provisions of this chapter and the *New York City Plumbing Code* shall govern the erection, installation, alteration, repairs, relocation, replacement, addition to, use or maintenance of plumbing equipment and systems. Plumbing systems and equipment shall be constructed, installed and maintained in accordance with the *New York City Plumbing Code*.

**SECTION BC 2902**  
**MINIMUM PLUMBING FACILITIES**

**2902.1 Minimum number of fixtures.** Plumbing fixtures shall be provided for the type of occupancy and in the minimum number shown in Table 403.1 of the *New York City Plumbing Code*. Types of occupancies not shown in Table 403.1 of the *New York City Plumbing Code* shall be considered individually by the commissioner. The number of occupants shall be determined by this code. Occupancy classification shall be determined in accordance with Chapter 3. However, with respect to the number of required plumbing fixtures in occupancy Group B, Table 403.1 of the *New York City Plumbing Code* shall be modified as follows:

**TABLE 403.1**  
**MINIMUM NUMBER OF REQUIRED PLUMBING FIXTURES**

NO.	CLASSIFICATION	USE GROUP	DESCRIPTION	WATER CLOSETS (URINALS SEE SECTION 419.2)		LAVATORIES		BATHTUBS/SHOWERS	DRINKING FOUNTAIN (SEE SECTION 410.1)	OTHER
				MALE	FEMALE	MALE	FEMALE			
2	Business (see Sections 403.2, 403.4 and 403.6)	B	Buildings for the transaction of business, professional services, other services involving merchandise, office buildings, banks, light industrial and similar uses	No. of persons for each sex	No. of fixtures	No. of persons	No. of fixtures	=	1 per 100	1 service sink
				1-20	1	1-25	1			
				21-45	2	26-50	2			
				46-70	3	51-75	3			
				71-100	4	76-115	4			
				101-140	5	116-160	5			
				141-190	6	1 fixture for each additional 60 persons				
				1 fixture for each additional 50 persons						

**2902.1.1 Unisex toilet and bath fixtures.** Fixtures located within unisex toilet bathing rooms complying with Section 404 of the *New York City Plumbing Code* are permitted to be included in determining the minimum required number of fixtures for assembly and mercantile occupancies.

**2902.2** Reserved.

**2902.3** Reserved.

**2902.4** Reserved.

**2902.5** Reserved.

**2902.6** Reserved.

**CHAPTER 30**  
**ELEVATORS AND CONVEYING SYSTEMS**

**SECTION BC 3001**  
**GENERAL**

**3001.1 Scope.** This chapter establishes the minimum safety requirements for, and governs the design, construction, installation, alteration, maintenance, inspection, test and operation of, elevators, dumbwaiters, escalators, moving walks, industrial lifts and loading ramps, mechanical parking equipment, console or stage lifts, power operated scaffolds, amusement devices, and special hoisting and conveying equipment. This chapter and all the provisions of this code for new installations shall also apply to elevators in existing buildings moved to new hoistways.

High-rise buildings elevators shall also conform to the provisions of Section 403 of this code.

**Exception:** Personnel and material hoists used for construction operations subject to the requirements of Chapter 33.

**3001.2 Referenced standards.** Except as otherwise provided for in this code, the design, construction, installation, alteration, repair and maintenance of elevators and other conveying systems and their components shall conform to ASME A17.1 as modified by Appendix K, ASME A17.2, ASME A18.1, ASME A17.5, ANSI A10.5, ASME QEI-1, ASME A90.1, ASME B20.1 as modified by Appendix K, ALI ALCTV, and for construction in areas of special flood hazard, Appendix G.

**3001.3 Accessibility.** Passenger elevators required to be accessible by Chapter 11 shall conform to ICC A117.1.

**3001.4 Change in use.** A change in use of an elevator from freight to passenger, passenger to freight, or from one freight class to another freight class shall comply with Section 8.7 of ASME A17.1.

**3001.5 Piping or ductwork.** No piping or ductwork of any kind shall be permitted within hoistway or elevator enclosures except:

1. As required for the elevator installation; and
2. Low voltage wiring less than 50 volts required for fire alarm systems required by this code.

**3001.6 Elevator mirrors.** A mirror shall be installed in each self-service passenger elevator in multiple dwellings. Such mirror shall be affixed and maintained in a manner sufficient to enable persons entering such elevator to view the inside thereof prior to entry to determine whether any person is in the elevator.

**3001.7 Car switch operation.** Elevators with car switch operation (manual operation) shall be provided with a signal system by means of which signals can be given from any landing whenever the elevator is desired at that landing.

**3001.8 Prohibited devices.** The following devices shall be prohibited:

**3001.8.1 Manlifts.** The installation of manlifts is prohibited.

**3001.8.2 Sidewalk elevators.** The installation of sidewalk elevators located outside the street line is prohibited

**3001.9 Approved equipment.** Buffers, PA interlocks, elevator entrances, wedge shackles, and elevator governors shall be approved by the commissioner.

**3001.10 Construction documents.** Applications for elevator, escalator, moving walkway and stairway, dumbwaiter, and similar equipment shall contain construction documents that include the following:

1. The location of all machinery, switchboards, junction boxes, and reaction points, with loads indicated;
2. The details of all hoistway conditions including bracket spacing;
3. The estimated maximum vertical forces on the guide rails on application of the safety device;
4. In the case of freight elevators for class B or C loading, the horizontal forces on the guide-rail faces during loading and unloading; and the estimated maximum horizontal forces in a postwise direction on the guide-rail faces on application of the safety device;
5. The size and weight per foot of any rail reinforcements where provided;
6. Compliance with the accessibility features of this code;
7. The details of capability of the withstanding forces (impact) on door entrance assembly and retaining devices;
8. The withstanding hourly fire rating of the hoistway and the hoistway door assembly;
9. The impact loads imposed on machinery and sheave beams, supports and floors or foundations;
10. The impact load on buffer supports due to buffer engagement at the maximum permissible speed and load;

11. Where compensation tie down is applied, the load on the compensation tie down supports; and

12. The total static and dynamic loads from the governor, ruper and tension system.

## **SECTION BC 3002** **HOISTWAY ENCLOSURES**

**3002.1 Hoistway enclosure protection.** Elevator, dumbwaiter and other hoistway enclosures shall have a fire-resistance rating not less than that specified in Chapter 6 and shall be constructed in accordance with Chapter 7.

**3002.1.1 Opening protectives.** Openings in hoistway enclosures shall be protected as required in Chapter 7.

**3002.1.2 Hardware.** Hardware on opening protectives shall be of an approved type installed as tested, except that approved interlocks, mechanical locks and electric contacts, door and gate electric contacts and door-operating mechanisms shall be exempt from the fire test requirements.

**3002.2 Number of elevator cars in a hoistway.** Where four or more elevator cars serve all or the same portion of a building, the elevators shall be located in at least two separate hoistways. Not more than four elevator cars shall be located in any single hoistway enclosure. Elevators that service different risers shall be located in separate hoistways.

**3002.3 Emergency signs.** An approved pictorial sign of a standardized design shall be posted adjacent to each elevator call station on all floors instructing occupants to use the exit stairways and not to use the elevators in case of fire. The sign shall read: IN FIRE EMERGENCY, DO NOT USE ELEVATOR. USE EXIT STAIRS. The emergency sign shall not be required for elevators that are part of an accessible means of egress complying with 1007.4.

**3002.4 Elevator car to accommodate ambulance stretcher.** In buildings five stories in height or more, at least one elevator shall be provided for Fire Department emergency access to all floors. Emergency power shall be provided in accordance with Sections 2702 and 3003. Such elevator car shall be of such a size and arrangement to accommodate a 24-inch by 76-inch (610 mm by 1930 mm) ambulance stretcher in the horizontal, open position and shall be identified by the international symbol for emergency medical services (star of life). The symbol shall not be less than 3 inches (76 mm) high and shall be placed on both jambs of the hoistway entrances on each floor.

**3002.5 Emergency doors.** Where an elevator is installed in a single blind hoistway or on the outside of a building, there shall be installed in the blind portion of the hoistway or blank face of the building, an emergency door in accordance with ASME A17.1.

**3002.6 Reserved.**

**3002.7 Common enclosure with stairway.** Elevators shall not be in a common shaft enclosure with a stairway.

## **SECTION BC 3003** **ELEVATOR EMERGENCY OPERATIONS**

**3003.1 Emergency power.** In buildings and structures where emergency power is required or furnished to operate an elevator, the operation shall be in accordance with Sections 3003.1.1 through 3003.1.4.

**3003.1.1 Manual transfer.** Emergency power shall be manually transferable to all elevators in each bank.

**3003.1.2 One elevator.** Where only one elevator is installed, the elevator shall automatically transfer to emergency power within 60 seconds after failure of normal power.

**3003.1.3 Two or more elevators.** Where two or more elevators are controlled by a common operating system, all elevators shall automatically transfer to emergency power within 60 seconds after failure of normal power where the emergency power source is of sufficient capacity to operate all elevators at the same time. Where the emergency power source is not of sufficient capacity to operate all elevators at the same time, all elevators shall transfer to emergency power in sequence, return to the designated landing and disconnect from the emergency power source. After all elevators have been returned to the designated level, at least three elevators shall remain operable from the emergency power source.

**3003.1.4 Venting.** Where emergency power is connected to elevators, the machine room ventilation or air conditioning shall be connected to the emergency power source.

**3003.2 Fire fighters' emergency operation.** Elevators shall be provided with Phase I emergency recall operation and Phase II emergency in-car operation in accordance with ASME A17.1 as modified by Appendix K.

**3003.3 Elevator in readiness.** Requirements for elevator in readiness shall be as defined in Sections 3003.3.1 through 3003.3.2 .

**3003.3.1 High-rise buildings.** Except as provided in Section 3003.3.2, in high-rise buildings as defined in Section 403, all floors shall be served by at least one elevator that shall be kept available for immediate use by the Fire Department during all hours of the night and day, including holidays, Saturdays and Sundays. There shall be available at all times a person competent to operate the elevator. However, an attendant shall not be required for buildings with occupied floors of 150 feet (45 720 mm) or less above the lowest level of the fire department vehicle access that have elevators with automatic or continuous pressure operation with keyed switches meeting the requirements of ASME A17.1 as modified by Appendix K so as to permit sole use of the elevators by the Fire Department.



**3003.3.2 Number of Elevators.** A number of elevators shall be kept available at every floor for the sole use of the Fire Department as required by Section 3003.3.2.1 and Section 3003.3.2.2. This requirement shall apply to the following types of buildings:

1. High-rise buildings classified in Groups A, B, E, F, H, M and S;
2. Buildings of Group B with a gross area of 200, 000 square feet (18 581 m<sup>2</sup>);
3. Buildings of Group R-1 and R-2.

**3003.3.2.1 Three or fewer elevators.** Where a floor is serviced by three or fewer elevator cars, every car shall be kept available for sole use by the Fire Department.

**3003.3.2.2 More than three elevators.** Where a floor is serviced by more than three elevator cars, at least three elevator cars with a total rated load capacity of not less than 6,000 pounds (2722 kg) shall be kept available for sole use by the Fire Department. Such cars shall include not more than two cars that service all floors and at least one other car in another bank servicing that floor. If the total load capacity of all cars servicing the floor is less than 6,000 pounds (2722 kg), all such cars shall be kept available for sole use by the Fire Department.

**3003.3.2.3 Operation and control.** Elevators that are kept for the sole use of the Fire Department and that have automatic or continuous pressure operation shall be controlled by keyed switches meeting the requirements of ASME 17.1.

**3003.3.2.4 Other elevator cars.** In high rise buildings classified in occupancy groups A, B, E, F, H, I, M and S, in low-rise buildings classified in occupancy group B with a gross area of 200,000 square feet (18 581 m<sup>2</sup>) or more and in buildings classified in occupancy group R-1 or R-2, all other automatically operated cars shall have manual operation capability.

## **SECTION BC 3004** **HOISTWAY VENTING**

**3004.1** Reserved.

**3004.2** Reserved.

**3004.3** Reserved.

**3004.4** Reserved.

**3004.5 Plumbing and mechanical systems.** Plumbing and mechanical systems shall not be located in an elevator shaft.

**Exception:** Floor drains sumps and sump pumps shall be permitted at the base of the shaft provided they are indirectly connected to the plumbing system.

**3004.6 Control of smoke and hot gases.** Hoistways of elevators shall be provided with any one of the following means to prevent the accumulation of smoke and hot gases in case of fire in accordance with Sections 3004.6.1 through 3004.6.4.

**3004.6.1 Vents in the hoistway enclosures.** Hoistway enclosures may be vented in accordance with the following:

1. Location of vents:

1.1. The vents in the side of the hoistway enclosure below the elevator machine room floor or in the roof of the hoistway shall open either directly to the outer air or through non-combustible ducts to the outer air.

1.2. The vents in the wall or roof of an overhead elevator machine room through the smoke hole in the top of the elevator hoistway shall be vented to the outer air through non-combustible ducts.

2. Area of vents. The area of vents in the hoistway or the elevator machine room and the smoke hole shall be not less than 3½ percent of the area of the hoistway nor less than 3 square feet (0.28 m<sup>2</sup>) for each elevator car, whichever is greater. Such vents shall comply with the following requirements:

2.1. Open Vents. Of the total required vent area, not less than one-third shall be permanently open or equipped with an openable hinged damper. The smoke hole shall be permanently open.

2.2. Closed Vents. The two-thirds closed portion of the required vent area either in the hoistway enclosure or in the elevator machine room may consist of windows or skylights glazed with annealed glass not more than ⅛-inch (3.2 mm) thick. A closed damper that opens upon the activation of a smoke detector placed at the top of the hoistway shall be considered closed.

**3004.6.2 Mechanical ventilation of the hoistway enclosure.** Hoistway enclosures may be mechanically vented. The system of mechanical ventilation shall be of sufficient capacity to exhaust at least 12 air changes per hour of the volume of such hoistways through a roof or an approved location on an exterior wall other than the lot line wall. Such system shall comply with the following requirements:

1. The smoke detector shall be placed at the top of the hoistway and shall activate the mechanical ventilation system.

2. Such mechanical ventilation system shall not pass through the overnight sleeping areas of a hotel, multiple dwelling, hospital, or similar buildings.

3. Such mechanical ventilation system shall be equipped with a manual shut-off in or near the elevator control panel at the designated level.

**3004.6.3 Air pressurization of hoistway enclosure.** Hoistways may be air pressurized. Where such system is utilized, the air shall not cause erratic operation of the landing or car door equipment, traveling cables, selector tapes, governor ropes, compensating ropes, or any other components sensitive to excess movement or deflection.

**3004.6.4 Alternate means.** The commissioner may accept alternate means to prevent the accumulation of smoke and hot gases in the hoistways and machine rooms in case of fire.

## **SECTION BC 3005** **CONVEYING SYSTEMS**

**3005.1 General.** Conveying systems shall comply with the provisions of this section.

**3005.2 Escalators and moving walks.** Escalators and moving walks shall be constructed of approved noncombustible and fire-retardant materials. This requirement shall not apply to electrical equipment, wiring, wheels, handrails and the use of <sup>1</sup>/<sub>28</sub>-inch (0.9 mm) wood veneers on balustrades backed up with noncombustible materials.

**3005.2.1 Enclosure.** Escalator floor openings shall be enclosed except where Exception 2 of Section 707.2 is satisfied.

**3005.2.2 Escalators.** Where provided in below-grade transportation stations, escalators shall have a clear width of 32 inches (813 mm) minimum.

**Exception:** The clear width is not required in existing facilities undergoing alterations.

**3005.3 Conveyors.** Conveyors and related equipment shall comply with ASME B20.1.

**3005.3.1 Enclosure.** Conveyors and related equipment connecting successive floors or levels shall be enclosed with fire barrier walls and approved opening protectives complying with the requirements of Section 3002 and Chapter 7.

**3005.3.2 Conveyor safeties.** Power-operated conveyors, belts, and other material-moving devices shall be equipped with automatic limit switches, which will shut off the power in an emergency and automatically stop all operation of the device.

**3005.4 Reserved.**

**3005.5 Amusement devices.** Amusement devices shall also comply with rules of the department.

## **SECTION BC 3006**

## MACHINE ROOMS

**3006.1 Access.** An approved means of access shall be provided to elevator machine rooms and overhead machinery spaces.

**3006.2 Venting.** Elevator machine rooms that contain solid-state equipment for elevator operation shall be provided with an independent ventilation or air-conditioning system to protect against the overheating of the electrical equipment. The system shall be capable of maintaining temperatures within the range established for the elevator equipment.

**3006.3 Pressurization.** The elevator machine room serving a pressurized elevator hoistway shall be pressurized upon activation of a heat or smoke detector located in the elevator machine room.

**3006.4 Machine rooms and machinery spaces.** Elevator machine rooms and machinery spaces shall be enclosed with construction having a fire-resistance rating not less than the required rating of the hoistway enclosure served by the machinery. Openings shall be protected with assemblies having a fire-resistance rating not less than that required for the hoistway enclosure doors.

**3006.5 Sprinklers prohibited.** Sprinklers are not permitted in elevator machine rooms.

**3006.6 Plumbing systems.** Plumbing systems not related to elevator machinery shall not be located in elevator equipment rooms.

**3006.7 Elevator machinery noise control in multiple dwellings.** Gear-driven machinery, gearless machinery, and motor generators located in an elevator machinery room or shaft on a roof, or on a floor other than a floor on grade, shall be supported on vibration isolator pads having a minimum thickness of ½ inch (12.7 mm).

## SECTION BC 3007 SERVICE EQUIPMENT CERTIFICATES

**3007.1 Required.** No service equipment shall be placed in operation until a service equipment certificate of compliance has been obtained in accordance with the provisions of this code.

**3007.2 Posting of inspection certificate.** At the time a service equipment certificate of compliance is issued, an inspection certificate issued by the commissioner shall be posted. No such inspection certificate shall be issued for elevators that are not subject to periodic inspections pursuant to this code. The inspection certificate shall be in such form as the commissioner shall determine by rule and shall be posted in a frame with a transparent cover in the car of every passenger and freight elevator and on or near every escalator and moving walk and power operated scaffold.

**3007.2.1 Alternate posting locations.** In lieu of posting the inspection certificate in those locations specified in this section, the inspection certificate may be kept in the on-site building manager's office. In such case, the building manager's office must be open during

normal business hours. In addition, notice must be posted in each location and kept in a frame with a transparent cover, or a plaque with an indelible inscription, stating that the inspection certificate is located in the building manager's office and identifying the location of such office.

**3007.3 Temporary use certificates.** The commissioner may issue temporary use certificates for any equipment or device regulated by this code, except power-operated scaffolds, provided that such partial use and operation may be made safely and without endangering public health, safety, and welfare and provided further that such temporary use certificate shall not be issued for a period of more than thirty calendar days, subject to renewal for additional thirty-day periods at the discretion of the commissioner. Temporary use certificates for elevators shall also be conditioned upon compliance with the following:

1. The class of service to be permitted shall be designated on the temporary use certificate.
2. The hoistway shall be enclosed throughout in an enclosure complying with ASME 17.1 or with a temporary enclosure in accordance with the requirements for workers' elevators (temporary elevators) of the *Industrial Code of the State of New York*, No. 23.

**3007.3.1 Posting of temporary use certificate.** The temporary use certificate shall be posted in a conspicuous location on, or adjacent to, the device covered by the certificate and shall state that the device has not been finally approved by the commissioner.

## **SECTION BC 3008** **ELEVATOR, AMUSEMENT, AND OTHER DEVICE OPERATORS**

**3008.1 Elevator operators.** With the exception of automatic operation, continuous pressure elevators and sidewalk elevators, every passenger and freight elevator with a rise of more than one story shall be in the charge of a designated competent operator, who shall be at least 18 years old, free from serious physical or mental defects, and selected with consideration of his or her abilities to perform his or her duties in a careful and competent manner. Such designated competent operator shall be instructed in accordance with requirements of department rules.

**3008.2 Amusement device operators.** Operators of amusement devices shall meet the requirements of rules of the department.

**3008.3 Other device operators.** Other devices regulated by this code shall, when deemed necessary by the commissioner to protect public safety, be in charge of a designated competent operator conforming to such qualifications as the commissioner may prescribe, except that operators for workers' hoists shall be assigned as required by the applicable provisions of ASME 10.4

**3008.4 Sanction for unlawful operation.** If the commissioner finds that any person engaged in operating an elevator, amusement, or other device is not competent to operate the elevator, amusement or other device, the owner, agent or lessee of such elevator, amusement, or other

device shall, upon notice from the commissioner, discontinue the operation of such device by such operator.

### **SECTION BC 3009** **ELEVATOR BEING SERVICED**

**3009.1 Signage.** When an existing or new automatic passenger elevator in any building or structure is being serviced by an elevator maintenance company, elevator maintenance personnel, or other person and there are no maintenance personnel available to remain in the elevator car, “CAUTION” sign tapes shall be placed across the car door jamb. One strip of “CAUTION” sign tape shall be placed at a height of 18 inches (457 mm) above the car floor and another strip of “CAUTION” sign tape shall be placed at a height of 54 inches (1372 mm) above the car floor.

**3009.1.1 Sign tape.** The “CAUTION” sign tape shall be 3 inches (76 mm) in width with the words “CAUTION – DO NOT ENTER” repeated every 6 inches (152 mm). The lettering shall be black on yellow background. The letters shall be at least 2 inches (51 mm) high.

### **SECTION BC 3010** **ACCIDENTS**

**3010.1 Accidents.** The owner of any device regulated by this chapter shall promptly notify the commissioner of every accident involving injury to any person requiring the services of a physician or damage to property or to apparatus exceeding one thousand dollars on, about, or in connection with such equipment, before commencing any repairs and shall afford the commissioner every facility for investigating such accident or damage. The commissioner shall make an investigation immediately thereafter, and shall prepare a full and complete report of such investigation. Such report shall give in detail all material facts and information available and the cause or causes as far as they can be determined. Such report shall be a public record. When an accident involves the failure or destruction of any part of the construction or operating mechanism of such equipment, no such equipment shall be used until it has been made safe, and re-inspected by the commissioner; and the commissioner may order the discontinuance of such equipment until a new service equipment certificate has been issued by him or her for its use. No part shall be removed from the premises of the damaged construction or operating mechanism until permission to do so has been granted by the commissioner.

### **SECTION BC 3011** **EXISTING INSTALLATIONS**

**3011.1 General.** Existing installations shall be modified in accordance with department rules.

### **SECTION BC 3012** **INSPECTION AND TESTING**

**3012.1 Elevators and Conveying Systems.** Inspection and testing of elevators and conveying systems shall be in accordance with Appendix K. Refer to Chapter 3 of Title 28 of the *Administrative Code* for additional requirements.

**3012.2 Amusement devices.** Inspection and testing of amusement devices shall comply with rules of the department. Refer to Chapter 3 of Title 28 of the *Administrative Code* for additional requirements.

**CHAPTER 31**  
**SPECIAL CONSTRUCTION**

**SECTION BC 3101**  
**GENERAL**

**3101.1 Scope.** The provisions of this chapter shall govern special building construction including membrane structures, temporary structures, pedestrian walkways and tunnels, awnings and canopies, marquees, signs, telecommunications towers and antennas, swimming pools and enclosures, sidewalk cafés, and fences.

**SECTION BC 3102**  
**MEMBRANE STRUCTURES**

**3102.1 General.** The provisions of this section shall apply to air-supported structures, air-inflated structures, membrane-covered cable structures, membrane-covered frame structures, and tents, collectively known as membrane structures.

**3102.1.1 Certificates of occupancy.** The duration of certificates of occupancy for air-inflated structures, air-supported structures, and tents may be limited in accordance with the requirements of Chapter 1.

**3102.2 Definitions.** The following terms shall, for the purposes of this section and as used elsewhere in this code, have the meanings shown herein:

**AIR-INFLATED STRUCTURE.** A building where the shape of the structure is maintained by air pressurization of cells or tubes to form a barrel vault over the usable area. Occupants of such a structure do not occupy the pressurized area used to support the structure.

**AIR-SUPPORTED STRUCTURE.** A building wherein the shape of the structure is attained and maintained by elevated air pressure and occupants of the structure are within the elevated pressure area. Air-supported structures are of two basic types:

**Double skin.** Similar to a single skin, but with an attached liner that is separated from the outer skin and provides an airspace which serves for insulation, acoustic, aesthetic or similar purposes.

**Single skin.** Where there is only the single outer skin and the air pressure is directly against that skin.

**CABLE-RESTRAINED, AIR-SUPPORTED STRUCTURE.** A structure in which the uplift is resisted by cables or webbings which are anchored to either foundations or dead men. Reinforcing cable or webbing is attached by various methods to the membrane or is an integral part of the membrane. This is not a cable-supported structure.



**MEMBRANE-COVERED CABLE STRUCTURE.** A nonpressurized structure in which a mast and cable system provides support and tension to the membrane weather barrier and the membrane imparts stability to the structure.

**MEMBRANE-COVERED FRAME STRUCTURE.** A nonpressurized building wherein the structure is composed of a rigid framework to support a tensioned membrane which provides the weather barrier.

**NONCOMBUSTIBLE MEMBRANE STRUCTURE.** A membrane structure in which the membrane and all component parts of the structure are noncombustible.

**TENT.** A non-pressurized membrane structure of a fabric weather barrier supported by poles and guys, in which the fabric weather barrier does not impart stability to the structure. Tents need not be fully enclosed on the sides.

**3102.3 Type of construction.** Noncombustible membrane structures shall be classified as Type IIB construction. Noncombustible frame or cable-supported structures covered by an approved membrane in accordance with Section 3102.3.1 shall be classified as Type IIB construction. Heavy timber frame-supported structures covered by an approved membrane in accordance with Section 3102.3.1 shall be classified as Type IV construction. Other membrane structures shall be classified as Type V construction.

**3102.3.1 Membrane and interior liner material.** Membranes and interior liners shall be either noncombustible as set forth in Section 703.4, or flame resistant as determined in accordance with NFPA 701 and the manufacturer's test protocol.

**3102.4 Allowable floor areas.** The area of a membrane structure shall not exceed the limitations set forth in Table 503, except as provided in Section 506.

**3102.5 Maximum height.** Membrane structures shall not exceed one story nor shall such structures exceed the height limitations in feet set forth in Table 503. Membrane structures may be erected above the roof of a building provided that such roof is of noncombustible construction required to have a fire-resistance rating

**Exception:** Noncombustible membrane structures serving as roofs only.

**3102.6 Mixed construction.** Membrane structures shall be permitted to be utilized as specified in this section as a portion of buildings of other types of construction. Height and area limits shall be as specified for the type of construction and occupancy of the building.

**3102.6.1 Noncombustible membrane.** A noncombustible membrane shall be permitted for use as the roof or as a skylight of any building or atrium of a building of any type of construction, provided it is at least 20 feet (6096 mm) above any floor, balcony or gallery, and meets the fire classification requirements of Section 1505 for roof assemblies.

**3102.6.1.1 Flame-resistant membrane.** A flame-resistant membrane shall be permitted to be used as the roof or as a skylight on buildings of Type IIB, III, IV and V construction, provided it is at least 20 feet (6096 mm) above any floor, balcony or gallery, and meets the fire classification requirements of Section 1505 for roof assemblies.

**3102.7 Engineering design.** Membrane structures shall be designed and constructed to sustain dead loads; loads due to tension or inflation; live loads including wind, snow or flood and seismic loads and in accordance with Chapter 16 and Appendix G.

**Exception:** Tents, air-inflated structures, and air-supported structures shall be designed by either an alternate engineering design approved by the commissioner or as follows:

1. Tents. Tents shall be guyed, supported, and braced to withstand a wind pressure of 10 psf (478.8 Pa) of projected area of the tent. The poles and their supporting guys, stays, stakes, fastenings, etc. shall be of sufficient strength and attached so as to resist wind pressure of 20 psf (957.6 Pa) of projected area of the tent.
  
2. Air-inflated structures and air-supported structures.
  - 2.1. Air-inflated structures and air-supported structures shall be anchored to the ground or supporting structure by either ballast or positive anchorage, sufficiently and evenly distributed, and adequate to resist the inflation lift load, the aerodynamic lift load, and the drag (shear) load due to wind impact. The latter factors shall be based on a fastest mile wind speed of 70 mph (112.65 km/hr), and an estimated stagnation of not less than 0.5 q for structures on grade whose height is equal to, or less than, the width of the structure. For greater heights, or for elevated structures, increased anchorage shall be provided, justified by analytical and/or experimental data subject to approval by the commissioner.
  
  - 2.2. The skin of the structure shall be of such strength, and the joints so constructed, as to provide a minimum dead load strip tensile strength at 70°F (21°C) of 4 times the 70 mph (121.65 km/hr) design load (inflation and aerodynamic loading). The joints shall provide a dead load strip tensile strength of 160°F (71°C) of twice the 70 mph (121.65 km/hr) design load (i.e., a factor of safety of 4 and 2 respectively). In addition, the material shall provide a trapezoidal tear strength of at least 15 percent of the maximum design tensile load. Material and joint strengths shall be so certified by the manufacturer, justified by analytical and/or experimental data.

**3102.8 Inflation systems.** Air-supported structures and air-inflated structures shall be provided with primary and auxiliary inflation systems to meet the minimum requirements of Sections 3102.8.1 through 3102.8.3.

**3102.8.1 Equipment requirements.** The primary inflation system shall consist of one or more blowers and shall include provisions for automatic control to maintain the required inflation pressures. Such system shall be so designed as to prevent over pressurization of the system.

**3102.8.1.1 Auxiliary inflation system.** In addition to the primary inflation system, in structures exceeding 1,500 square feet (140 m<sup>2</sup>) in area, an auxiliary inflation system shall be provided with sufficient capacity to maintain the inflation of the structure in case of primary system failure. The auxiliary inflation system shall operate automatically when there is a loss of internal pressure and when the primary blower system becomes inoperative.

**3102.8.1.2 Blower equipment.** Blower equipment shall meet the following requirements:

1. Blowers shall be powered by continuous-rated motors at the maximum power required for any flow condition as required by the structural design.
2. Blowers shall be provided with inlet screens, belt guards and other protective devices as required by the commissioner to provide protection from injury.
3. Blowers shall be housed within a weather-protecting structure.
4. Blowers shall be equipped with backdraft check dampers to minimize air loss when inoperative.
5. Blower inlets shall be located to provide protection from air contamination. The location of inlets shall be approved.

**3102.8.2 Emergency power.** Wherever an auxiliary inflation system is required, an approved emergency power-generating system shall be provided. However, notwithstanding Section 2702.1, the emergency power-generating system shall be equipped with a suitable means for automatically starting the generator set upon failure of the normal electrical service and for automatic transfer and operation of all of the required electrical functions at full power within 60 seconds of such service failure. Emergency power shall be capable of operating independently for a minimum of 4 hours.

**3102.8.3 Support provisions.** A system capable of supporting the membrane in the event of deflation shall be provided for in air-supported structures and air-inflated structures having an occupant load of more than 50 or where covering a swimming

pool regardless of occupant load. Such support system shall be capable of maintaining the membranes at least 7 feet (2134 mm) above the floor, seating area or surface of the water. When air-supported structures or air-inflated structures are used as a roof on Type I or II construction buildings, such support system shall be capable of maintaining the membranes not less than 20 feet (6096 mm) above the floor or seating area.

**3102.9 Separation.** No air-inflated structure, air-supported structure, or tent shall be erected closer than 20 feet (6096 mm) to any interior lot line nor closer than 30 feet (9144 mm) in any direction to an unprotected opening, required exterior stairway or corridor, or required exit door, on the same level or above the level of such structure. Such structure may abut another building on the same tax lot if the following conditions exist:

1. No unprotected openings or exits are located above or within 30 feet (9144 mm) of such structure.
2. No doors serving as a required exit are located between such structure and the abutted building.
3. The exterior wall of the abutted building meets the requirements of Section 705 for fire walls.

**3102.10 Exits.** In addition to the requirements of Chapter 10, travel distance to an exit from any point within a tent, air-supported structure, or air-inflated structure shall not exceed 75 feet (22 860 mm).

**3102.10.1 Exit openings from tents.** Exit openings from tents shall remain open unless covered by a flame-resistant curtain of a contrasting color to the tent. Such curtain shall be supported at least 80 inches (2032 mm) above the floor level at the exit and, when open, no part of the curtain shall obstruct the exit.

**3102.10.2 Exit openings from air-supported structures and air-inflated structures.** Exit doors in air-supported structures and air-inflated structures shall close automatically against normal operational pressures. Opening force at the edge of such doors shall not exceed 15 pounds (6.80 kg), with the structure at operational pressure. Exit doors shall be located in frames constructed such that they will remain operative and support the weight of the pressurized membrane structure in a state of total collapse.

## **SECTION BC 3103** **TEMPORARY STRUCTURES**

**3103.1 General.** The provisions of this section shall apply to temporary platforms, reviewing stands, outdoor bandstands and similar miscellaneous structures erected for a period of 30 days or less. Such structures may be constructed of wood whether located inside or outside of the fire districts.

**3103.1.1 Permit required.** Temporary structures that cover an area in excess of 120 square feet (11.16 m<sup>2</sup>), including connecting areas or spaces with a common means of egress or entrance, shall not be erected, operated or maintained for any purpose without obtaining a permit from the department.

**3103.2 Construction documents.** A permit application and construction documents shall be submitted for each installation of a temporary structure. The construction documents shall include a site plan indicating the location of the temporary structure and information delineating the means of egress and the occupant load.

**3103.3 Location.** Temporary structures shall be located in accordance with the requirements of Table 602 based on the fire-resistance rating of the exterior walls for the proposed type of construction.

**3103.4 Means of egress.** Temporary structures shall conform to the means of egress requirements of Chapter 10 and shall have a maximum exit access travel distance of 100 feet (30 480 mm).

## **SECTION BC 3104** **PEDESTRIAN WALKWAYS AND TUNNELS**

**3104.1 General.** This section shall apply to connections between buildings such as pedestrian walkways or tunnels, located at, above or below grade level, that are used as a means of travel by persons. The pedestrian walkway shall not contribute to the building area or the number of stories or height of connected buildings.

**3104.2 Separate structures.** Connected buildings shall be considered to be separate structures.

### **Exceptions:**

1. Buildings on the same tax lot in accordance with Section 503.1.3.
2. For purposes of calculating the number of Type B units required by Chapter 11, structurally connected buildings and buildings with multiple wings shall be considered one structure.

**3104.3 Construction.** The pedestrian walkway shall be of a construction type that is at least equal to the higher type of the two buildings connected.

**Exception:** Exterior pedestrian walkways serving as a required exit shall be constructed of noncombustible materials.

**3104.4 Contents.** Only materials approved by the department shall be located in the pedestrian walkway. Decorations may be permitted in accordance with the *New York City Fire Code*.

**3104.5 Fire barriers between pedestrian walkways and buildings.** Walkways shall be separated from the interior of the building by fire barrier walls with a fire-resistance rating of not less than 2 hours. This protection shall extend vertically from a point 10 feet (3048 mm) above the walkway roof surface or the connected building roof line, whichever is lower, down to a point 10 feet (3048 mm) below the walkway and horizontally 10 feet (3048 mm) from each side of the pedestrian walkway. Openings within the 10-foot (3048 mm) horizontal extension of the protected walls beyond the walkway shall be equipped with devices providing a ¾-hour fire protection rating in accordance with Section 715.

**Exception:** On pedestrian walkways having a maximum height above grade of 3 stories or 40 feet (12 192 mm), whichever is less; or 5 stories or 55 feet (16 764 mm) where sprinklered, whichever is less, the walls separating the pedestrian walkway from a connected building are not required to have a fire barrier by this section where any of the following conditions exist:

1. The distance between the connected buildings is more than 10 feet (3048 mm), the pedestrian walkway and connected buildings are equipped throughout with an automatic sprinkler system in accordance with NFPA 13 as modified in Appendix Q and the wall is constructed of a tempered, wired or laminated glass wall and doors subject to the following:
  - 1.1. The glass shall be protected by an automatic sprinkler system in accordance with NFPA 13 as modified in Appendix Q and the sprinkler system shall completely wet the entire surface of interior sides of the glass wall when actuated.
  - 1.2. The glass shall be in a gasketed frame and installed in such a manner that the framing system will deflect without breaking (loading) the glass before the sprinkler operates.
  - 1.3. Obstructions shall not be installed between the sprinkler heads and the glass.
2. The distance between the connected buildings is more than 10 feet (3048 mm), and both sidewalls of the pedestrian walkway are at least 50 percent open with the open area uniformly distributed to prevent the accumulation of smoke and toxic gases.
3. Buildings are on the same tax lot, in accordance with Section 503.1.3.
4. Where exterior walls of connected buildings are required by Section 704 to have a fire-resistance rating greater than 2 hours, the walkway shall be equipped throughout with an automatic sprinkler system installed in accordance with NFPA 13 as modified in Appendix Q.

5. The pedestrian walkway does not serve as a required exit.

**3104.6 Public way.** Pedestrian walkways over a public way shall also comply with Chapter 32.

**3104.7 Width.** The unobstructed width of pedestrian walkways shall not be less than 36 inches (914 mm). The total width shall not exceed 30 feet (9144 mm).

**3104.8 Egress.** Access shall be provided at all times to a pedestrian walkway that serves as a required exit. Doors satisfying the requirements of Chapter 10 shall enclose each end of such pedestrian walkway. The width of such pedestrian walkway shall be at least equal to the width of the doors opening onto such pedestrian walkway, but in no case less than 44 inches (1118 mm). The floor level at doors shall be the same as that of the connected building.

**Exception:** The floor level at doors of open pedestrian walkways shall be at least 7½ inches (191 mm) below the level of the door. Where the requirements of Chapter 11 are applicable, the differences in levels shall be accommodated by means of ramps in compliance with the provisions of Chapter 11.

**3104.9 Exit access travel.** The length of exit access travel shall not exceed 200 feet (60 960 mm).

**Exceptions:**

1. Exit access travel distance on a pedestrian walkway equipped throughout with an automatic sprinkler system in accordance with NFPA 13 as modified in Appendix Q shall not exceed 250 feet (76 200 mm).
2. Exit access travel distance on a pedestrian walkway constructed with both sides at least 50 percent open shall not exceed 300 feet (91 440 mm).
3. Exit access travel distance on a pedestrian walkway constructed with both sides at least 50 percent open, and equipped throughout with an automatic sprinkler system in accordance with NFPA 13 as modified in appendix Q, shall not exceed 400 feet (122 m).

**3104.10 Tunneled walkway.** Separation between the tunneled walkway and the building to which it is connected shall not be less than 2-hour fire-resistant construction and openings therein shall be protected in accordance with Table 715.3.

**3104.11 Ventilation.** Smoke and heat vents shall be provided for enclosed walkways and tunneled walkways as required for Group F-1 occupancies in accordance with Section 910.

**SECTION BC 3105**  
**AWNINGS AND CANOPIES**

**3105.1 General.** Awnings and canopies shall comply with the requirements of this section, the requirements of Chapter 32 for projections over public ways, and other applicable sections of this code.

**Exception:** Canopies projecting over public rights-of-way governed by Title 19 of the *Administrative Code* and rules of the New York City Department of Transportation.

**3105.2 Definition.** The following term shall, for the purposes of this section and as used elsewhere in this code, have the meaning shown herein.

**RETRACTABLE AWNING.** A retractable awning is a cover with a frame that retracts against a building or other structure to which it is entirely supported.

**3105.3 Design and construction.** Awnings and canopies shall be designed and constructed to withstand wind or other lateral loads and live loads as required by Chapter 16 with due allowance for shape, open construction and similar features that relieve the pressures or loads. Structural members shall be protected to prevent deterioration. Awnings shall have frames of noncombustible material, covered with flame-resistant fabric in accordance with NFPA 701, plastic in accordance with Section 2605, sheet metal, or other equivalent material, and shall be either fixed, retractable, folding or collapsible.

**3105.4 Reserved.**

**SECTION BC 3106**  
**MARQUEES**

**3106.1 General.** Marquees shall comply with this section and other applicable sections of this code. Marquees projecting beyond the street line shall also comply with the requirements of Chapter 32. Signs placed on marquees shall also comply with Section 3107.

**3106.2 Thickness.** The maximum height or thickness of a marquee measured vertically from its lowest to its highest point shall not be limited.

**Exception:** Marquees projecting beyond the street line shall meet the height and thickness requirements of Chapter 32.

**3106.3 Roof construction.** Where the roof or any part thereof is a skylight, the skylight shall comply with the requirements of Chapter 24. Every roof and skylight of a marquee shall be drained in accordance with the provisions of the *New York City Plumbing Code*.



**3106.4 Location prohibited.** Every marquee shall be so located as not to interfere with the operation of any exterior standpipe, and such that the marquee does not obstruct the clear passage of stairways or exit discharge from the building or the installation or maintenance of street lighting.

**3106.5 Construction.** A marquee shall be supported entirely from the building and constructed of noncombustible materials. Marquees shall be designed as required in Chapter 16. Structural members shall be protected to prevent deterioration.

## **SECTION BC 3107** **SIGNS**

**3107.1 General.** Signs shall be designed, constructed and maintained in accordance with Appendix H.

## **SECTION BC 3108** **RADIO, TELEVISION, AND TELECOMMUNICATIONS TOWERS AND** **ANTENNAS**

**3108.1 General.** Subject to the provisions of Chapter 16 and the requirements of Chapter 15 governing the fire-resistance ratings of buildings for the support of roof structures, radio, television, and telecommunications towers and antennas shall be designed and constructed as herein provided. All such towers and antennas shall be collectively referred to as “towers” for the purposes of this section.

**3108.2 Location and access.** Towers shall be located and equipped with step bolts and ladders so as to provide ready access for inspection purposes. Guy wires or other accessories shall not cross or encroach upon any street or other public space, or over above-ground electric utility lines, or encroach upon any privately owned property without written consent of the owner of the encroached-upon property, space or above-ground electric utility lines.

**3108.3 Construction.** Towers shall be constructed of approved corrosion-resistant noncombustible material. The minimum type of construction of isolated radio towers not more than 100 feet (30 480 mm) in height shall be Type IIB.

**3108.4 Loads.** Towers shall be designed to resist wind loads in accordance with TIA/EIA-222. Consideration shall be given to conditions involving wind load on ice-covered sections.

**3108.4.1 Dead load.** Towers shall be designed for the dead load plus ice load.

**3108.4.2 Wind load.** Towers shall be provided with adequate foundations and anchorage designed to resist two times the calculated wind load.

**3108.5 Grounding.** Towers shall be permanently and effectively grounded in accordance with the *New York City Electrical Code*.

**SECTION BC 3109**  
**SWIMMING POOLS, SWIMMING POOL ENCLOSURES, AND SAFETY**  
**DEVICES**

**3109.1 General.** Swimming pools, swimming pool enclosures, and swimming pool safety devices shall comply with the requirements of this section and other applicable sections of this code.

**3109.2 Definitions.** The following terms shall, for the purposes of this section and as used elsewhere in this code, have the meaning shown herein.

**SWIMMING POOL.** Any indoor or outdoor swimming, wading, spa, or special-purpose pool.

**Exceptions:**

1. Portable, freestanding wading pools containing water less than 24 inches (610 mm) in depth.
2. Float tanks or relaxation tanks sized for use by one person at a time.
3. Pools used for religious purposes.
4. Spa pools used for prescribed medical therapy or rehabilitation and under medical supervision.

**SWIMMING POOL, PRIVATE.** A swimming pool that is accessory to a one- or two-family dwelling, or to a single dwelling unit of a multiple dwelling, and that is solely for the use of the occupants for non-commercial purposes.

**SWIMMING POOL, PUBLIC.** A swimming pool that is not a private swimming pool. Public swimming pools include swimming pools that are accessory to bathing establishments as such term is defined in the *New York City Health Code*, whether owned or operated by city agencies, or commercial interests or private entities, including, but not limited to, public or private schools, corporations, hotels, motels, camps, apartment houses, condominiums, country clubs, gymnasia and health establishments.

**3109.3 All swimming pools.** Public and private swimming pools shall comply with the requirements for safety and accessibility as provided in this section.

**3109.3.1 Entrapment avoidance.** Where the suction inlet system, such as an automatic cleaning system, is a vacuum cleaner system which has a single suction inlet, or multiple suction inlets which can be isolated by valves, each suction inlet shall protect against user entrapment by an approved antivortex cover, a 12-inch by 12-inch (305 mm by 305 mm) or larger grate, or other approved means. In addition, all swimming pools and spas shall be equipped with an alternative backup system

which shall provide vacuum relief should grate covers be missing. Alternative vacuum relief devices shall include one of the following:

1. Approved vacuum release system.
2. Approved vent piping.
3. Other approved devices or means.

**3109.3.2 Water circulation, water treatment, and drainage.** The supply, circulation, treatment, and drainage of water for swimming pools shall meet the requirements of the *New York City Plumbing Code*.

**3109.3.3 Electrical precautions.** No overhead electrical conductors shall be installed within 15 feet (4572 mm) of any swimming pool. All metal fences, enclosures, or railings that might become electrically charged as a result of contact with broken overhead conductors or from any other cause near, or adjacent to, a swimming pool shall be grounded in accordance with the provisions of lightning protection in the *New York City Electrical Code*.

**3109.3.4 Facilities for people with disabilities.** Facilities for people with physical disabilities shall be provided where required by Chapter 11 of this code.

**3109.4 Public swimming pools.** Public swimming pools shall comply with the requirements for safety and accessibility as provided in Section 3109.3 and 3109.4.

**Exceptions:** A swimming pool with a power safety cover or a spa with a safety cover complying with ASTM F 1346.

**3109.4.1 Barrier height and clearances.** Public swimming pools shall be completely enclosed by a fence, wall, building, or other solid barrier, or any combination thereof, at least 6 feet (1829 mm) in height. Openings in the enclosure shall not permit the passage of a 4-inch-diameter (102 mm) sphere. The enclosure shall be equipped with self-closing and self-latching gates.

**Exception:** Enclosures shall be at least 4 feet (1219 mm) in height when surrounding wading pools with water less than 24 inches (610 mm) in depth.

**3109.4.2 Other laws.** In addition to the requirements of this section, any other, more stringent requirements for the construction and design of swimming pool and barriers that may be provided for in Article 165 of the *New York City Health Code*, as administered by the New York City Department of Health and Mental Hygiene, shall also be applicable.

**3109.5 Private swimming pools.** Private swimming pools shall comply with the requirements for safety and accessibility as provided in Section 3109.3 and this section.

**Exception:** An above-ground private swimming pool which has a maximum water depth of 4 feet (1219 mm) and an area not exceeding 500 square feet (46.45 m<sup>2</sup>) that is accessory to an R-3 occupancy and is privately used for non-commercial purposes shall not be required to comply with Sections 3109.3.1, 3109.3.2, 3109.5.2, 3109.5.3, and 3109.5.4.

**3109.5.1 Barrier height and clearances.** The top of the barrier enclosing a private swimming pool shall be at least 48 inches (1219 mm) above grade measured on the side of the barrier that faces away from the swimming pool. The maximum vertical clearance between grade and the bottom of the barrier shall be 2 inches (51 mm) measured on the side of the barrier that faces away from the swimming pool. Where the top of the pool structure is above grade, the barrier is authorized to be erected at grade level or mounted on top of the pool structure. The maximum vertical clearance between the top of the pool structure and the bottom of the barrier shall be 4 inches (102 mm).

**3109.5.1.1 Openings.** Openings in the barrier shall not allow passage of a 4-inch-diameter (102 mm) sphere.

**3109.5.1.2 Solid barrier surfaces.** Solid barriers which do not have openings shall not contain indentations or protrusions except for normal construction tolerances and tooled masonry joints.

**3109.5.1.3 Closely spaced horizontal members.** Where the barrier is composed of horizontal and vertical members and the distance between the tops of the horizontal members is less than 45 inches (1143 mm), the horizontal members shall be located on the swimming pool side of the fence. Spacing between vertical members shall not exceed 1¾ inches (44 mm) in width. Where there are decorative cutouts within vertical members, spacing within the cutouts shall not exceed 1¾ inches (44 mm) in width.

**3109.5.1.4 Widely spaced horizontal members.** Where the barrier is composed of horizontal and vertical members and the distance between the tops of the horizontal members is 45 inches (1143 mm) or more, spacing between vertical members shall not exceed 4 inches (102 mm). Where there are decorative cutouts within vertical members, spacing within the cutouts shall not exceed 1¾ inches (44 mm) in width.

**3109.5.1.5 Chain link dimensions.** Maximum mesh size for chain link fences shall be a 2¼ inch square (57 mm square) unless the fence is provided with slats fastened at the top or the bottom which reduce the openings to no more than 1¾ inches (44 mm).

**3109.5.1.6 Diagonal members.** Where the barrier is composed of diagonal members, the spacing between parallel diagonal members shall be no more than 1¾ inches (44 mm).

**3109.5.1.7 Gates.** Access gates shall comply with the requirements of Sections

3109.5.1.1 through 3109.5.1.6 and shall be equipped to accommodate a locking device. Pedestrian access gates shall open outward away from the pool and shall be self-closing and have a self-latching device. Gates other than pedestrian access gates shall have a self-latching device. Where the release mechanism of the self-latching device is located less than 54 inches (1372 mm) from the bottom of the gate, the release mechanism shall be located on the pool side of the gate at least 3 inches (76 mm) below the top of the gate, and the gate and barrier shall have no opening greater than ½ inch (12.7 mm) within 18 inches (457 mm) of the release mechanism.

**3109.5.1.8 Dwelling wall as a barrier.** Where a wall of a dwelling serves as part of the barrier, one of the following shall apply:

1. Doors with direct access to the swimming pool through that wall shall be equipped with an alarm which produces an audible warning when the door and its screen are opened. The alarm shall sound continuously for a minimum of 30 seconds immediately after the door is opened and be capable of being heard throughout the dwelling during normal household activities. The alarm shall automatically reset under all conditions. The alarm shall be equipped with a manual means to temporarily deactivate the alarm for a single opening. Such deactivation shall last no more than 15 seconds. The deactivation switch shall be located at least 54 inches (1372 mm) above the threshold of the door.
2. The swimming pool shall be equipped with a power safety cover which complies with ASTM F 1346.
3. The door providing access to the swimming pool from the dwelling shall open inward, away from the swimming pool, and shall be self-closing and have a self-latching device. The release mechanism of the self-latching device shall be located no less than 54 inches (1372 mm) from the bottom of the door.

**3109.5.1.9 Pool structure as barrier.** Where an aboveground private swimming pool structure is used as a barrier or where the barrier is mounted on top of the pool structure, and the means of access is a ladder or steps, then the ladder or steps either shall be capable of being secured, locked or removed to prevent access, or the ladder or steps shall be surrounded by a barrier which meets the requirements of Sections 3109.5.1.1 through 3109.5.1.8. When the ladder or steps are secured, locked or removed, any opening created shall not allow the passage of a 4-inch-diameter (102 mm) sphere.

**3109.5.2 Indoor swimming pools.** Walls surrounding indoor private swimming pools shall not be required to comply with Section 3109.5.1.8.

**3109.5.3 Prohibited locations.** Barriers shall be located so as to prohibit permanent structures, equipment or similar objects from being used to climb the barriers.

**3109.5.4 Construction requirements.** Private swimming pools shall be constructed so as to be water tight and easily cleaned. They shall be built of nonabsorbent materials with smooth surfaces and shall be free of open cracks and open joints.

**3109.5.4.1 Walls.** The walls of swimming pools shall be vertical for at least the top 30 inches (762 mm) below the normal water level. The junctions between the side walls and the bottom shall be coved. A swimming pool overflow shall be provided meeting the requirements of the *New York City Plumbing Code*.

**3109.5.4.2 Bottom slopes.** The bottom of the swimming pool shall slope downward toward the main drains. The slope in shallow areas with depths less than 5 feet (1524 mm) shall not exceed 1 unit vertical in 12 units horizontal. In portions of the swimming pool with depth greater than 5 feet (1524 mm), the slope shall not be steeper than 1 unit vertical in 3 units horizontal.

**3109.5.4.3 Ladders.** There shall be a ladder or steps with handrails at the deep end and at the shallow end of every swimming pool. Ladders and steps shall have no slip treads. All ladders shall be rigidly installed and shall be constructed of corrosion-resistant materials.

**3109.5.4.4 Walkways .** Every swimming pool shall have a walkway at least 5 feet (1524 mm) wide around its entire perimeter. The walkway shall have a non-slip surface and shall be constructed to drain away from the swimming pool.

**3109.5.4.5 Handholds.** Every swimming pool shall be constructed so that either the overflow gutter, if provided, or the tops of the side walls afford a continuous handhold for bathers.

**3109.5.4.6 Markings.** Permanent markings showing the depth of the shallow end, break points, diving depth, and deep end shall be provided so as to be visible from both inside and outside the swimming pool.

**3109.5.4.7 Diving boards and towers.** Diving towers shall be rigidly constructed and permanently anchored. The depth of the water below a diving board shall be at least 102 inches (2591 mm) for a board 39 inches (991 mm) or less above the water. For a diving board more than 39 inches (991 mm) and not more than 118 inches (2997 mm) above the water, the depth of the water below the board shall be at least 144 inches (3658 mm). For a diving board or platform more than 118 inches (2997 mm) above the water, the depth of the water below the board shall be at least 192 inches (4877 mm). Indoor swimming pools shall provide at least 144 inches (3658 mm) overhead clearance above all diving boards.

**SECTION BC 3110**  
**SIDEWALK CAFÉS**

**3110.1 General.** Sidewalk cafés provided beyond the building line shall comply with the requirements of this section, the New York City Zoning Resolution, the Commissioners of the Department of Consumer Affairs and Department of Transportation, and with the projection limitations of Chapter 32 of this code.

**3110.2 Enclosures.** Enclosed sidewalk cafés shall be constructed of noncombustible material. The walls of such enclosures shall not extend more than 8 feet (2438 mm) above the sidewalk. Light transmitting plastic glazing complying with Section 2606 shall be permitted as glazing within such walls. Light-transmitting plastic skylight glazing complying with Section 2610 may be installed in the roofs of such enclosures.

**3110.3 Awnings.** Awnings supported entirely from the building may be placed over unenclosed sidewalk cafés provided they are at least 8 feet (2438 mm) clear above the sidewalk and within the limits specified by the Commissioner of the Department of Consumer Affairs. Such awnings shall be in compliance with Section 3105 of this code.

**3110.4 Obstructions prohibited.** No part of any awning, enclosure, fixture, equipment or removable platform of a sidewalk café shall be located:

1. Beneath a fire escape so as to obstruct operation of fire escape drop ladders or counter-balanced stairs;
2. So as to obstruct any exit from a building;
3. So as to obstruct any cellar access hatch or areaway;
4. So as to interfere with any vent or other mechanical ventilation outlet or inlet;
5. So as to interfere with or obscure any standpipe connections, hydrant or associated signage in any way that would hinder its use by the fire department.

**Exception:** Upon special application, the commissioner may permit an easily removable, prominently designated platform, designed in accordance with Section 3110.5, to cover a cellar entrance or areaway that is not used as a required means of egress.

**3110.5 Removable platforms.** Removable platforms of sidewalk cafés shall be constructed in accordance with the requirements of this section.

**3110.5.1 Continuity.** Removable platforms shall be constructed to provide for a continuous unbroken and level floor without openings or cracks so as to prevent any material or liquid from falling through to the area beneath.

**3110.5.2 Maintenance.** No papers, trash or other materials may be permitted to accumulate in the area beneath the floor of any removable platform.

**3110.6 Accessibility.** Sidewalk cafés and access thereto shall comply with Chapter 11.

**3110.7 Assembly seating.** Unless separated from seating inside the building by fire partitions complying with Section 708, the seating for enclosed sidewalk cafés shall be added to that inside the building in order to determine whether a place of assembly permit is required.

**3110.8 Rules.** In addition to the requirements specified herein, the commissioner may promulgate such additional rules necessary to secure safety.

## **SECTION BC 3111**

### **FENCES**

**3111.1 Permitted heights.** Fences are permitted to be erected to a maximum height of 10 feet (3048 mm) above the ground.

#### **Exceptions:**

1. In residence districts, as established by the New York City Zoning Resolution, fences are permitted to be erected to a maximum height of 6 feet (1829 mm) above the ground.
2. Fences in residence districts used in conjunction with non-residence buildings and public playgrounds, excluding buildings accessory to dwellings, are permitted to be erected to a maximum height of 15 feet (4572 mm) above the ground.
3. Higher fences may be permitted by the commissioner where required for the enclosure of public playgrounds, school yards, parks, and similar public facilities.



**CHAPTER 32**  
**ENCROACHMENTS INTO THE PUBLIC RIGHT-OF-WAY**

**SECTION BC 3201**  
**GENERAL**

**3201.1 Scope.** The provisions of this chapter shall govern the encroachment of structures into the public right-of-way.

**3201.1.1 Encroachments removable.** All encroachments permitted beyond the street line by the provisions of this chapter shall be constructed so that they may be removed at any time without endangering the structural safety or fire safety of the building except that footings as permitted under Section 3202.1.1 of this code need not be removable.

**3201.2 Measurement.** The projection of any structure or appendage shall be the distance measured horizontally from the lot line to the outermost point of the projection.

**3201.3 Other laws.** The provisions of this chapter shall not be construed to permit the violation of other laws regulating the use and occupancy of public property.

**3201.3.1 Restrictions on construction and projections on certain streets, parkways, boardwalks and beaches.** Notwithstanding the provisions of this chapter, it shall be unlawful to build, erect, or make areaways, steps or other encroachments or projections prohibited by Sections 19-131, 19-132, 19-135, 18-109, 18-112 and 18-113 of the *Administrative Code*.

**3201.4 Drainage.** Drainage water collected from a roof, awning, canopy or marquee, other than canvas and flexible material, and condensate from mechanical equipment shall not flow over a public walking surface.

**3201.5 Permission revocable.** Any permission, expressed or implied, permitting the construction of encroachments within the area of the street under the provisions of this chapter shall be revocable, except footings as permitted under Section 3202.1.1.

**3201.6 Existing projections.** Any part of a building that projects beyond a street line on January 1, 1938 may be maintained as constructed until its removal is directed in accordance with applicable law.

**3201.7 Alteration of existing encroachments.** Alterations to existing encroachments beyond the street line may be permitted in whole or in part, provided that such alterations conform with the requirements of this chapter.

**3201.8 Definitions.** As used in this chapter, the following terms shall have the following meanings:

**CURB LINE.** The line coincident with the face of the street curb adjacent to the roadway.

**FOOTING.** A foundation element consisting of an enlargement of a foundation pier or foundation wall, wherein the soil materials along the side of and underlying the element may be visually inspected prior to and during its construction.

**PROJECTING SIGN.** A sign other than a wall sign, which projects from and is supported by a wall of a building or structure.

**SIGN.** Any letter, figure, character, mark, plane, point, marquee sign, design, poster, pictorial, picture, stroke, stripe, line, trademark, reading matter or illuminated service, which shall be constructed, placed, attached, painted, erected, fastened or manufactured in any manner whatsoever, so that the same shall be used for the attraction of the public to any place, subject, person, firm, corporation, public performance, article, machine or merchandise, whatsoever, which is displayed in any manner outdoors. Every sign shall be classified and conform to the requirements of that classification as set forth in this chapter.

**STREET.** A thoroughfare dedicated or devoted to public use by legal mapping or other lawful means, or a public way.

**STREET LINE.** A lot line separating a street from other land.

**VAULT.** Any space below the surface of the a street, that is covered over, except those openings that are used exclusively as places for descending, by means of steps, to the cellar or basement of any building.

## **SECTION BC 3202** **ENCROACHMENTS**

**3202.1 Encroachments below grade.** Encroachments below grade shall comply with Sections 3202.1.1 through 3202.1.4.

**3202.1.1 Footings.** Exterior wall and column footings may be constructed to project beyond the street line not more than 12 inches (305 mm), provided that the top of the footing is not less than 8 feet (2438 mm) below the ground or sidewalk level. Foundation walls required to support permitted projections may be constructed to project not more than the permitted projection beyond the street line.

**3202.1.2 Vaults.** Vaults may be permitted in accordance with the *New York City Charter* and Chapter 19 of the *Administrative Code*. Such vaults shall comply with the provisions of this code and other applicable laws and rules.

**3202.1.3 Areaways.** Areaways, subject to approval by the Commissioner of the Department of Transportation, shall be protected by grates, guards or other approved means.

**3202.1.4 Tunnels between buildings.** Tunnels connecting buildings, and projecting beyond street lines, may be constructed subject to the approval of the Commissioner of the Department of Transportation. Such tunnels shall comply with the provisions of this code and other applicable laws and regulations.

**3202.2 Encroachments above grade.** Encroachments into the public right-of-way above grade shall be prohibited except as provided for in Sections 3202.2.1 through 3202.2.3.

**3202.2.1 Encroachments subject to the area limitations.** Encroachments that are subject to area limitations are those elements listed in sections 3202.2.1.1 through 3202.2.1.8, generally of an architectural character, that form an integral part of the building facade. The aggregate area of all such elements constructed to extend beyond the street line shall not exceed 10 square feet (0.93 m<sup>2</sup>) within any 100 square feet (9.1 m<sup>2</sup>) of wall area, except that a veneer may be applied to the entire facade of a building erected before December 6, 1968, if such veneer does not project more than 4 inches (102 mm) beyond the street line. The area of any such projection shall be measured at that vertical plane, parallel to the wall, in which the area of the projection is greatest. This plane of measurement may be at the street line, the line of maximum projection, or any point in between.

**3202.2.1.1 Entrance details.** Entrance details, including steps, and doors when fully open, may be constructed to project beyond the street line not more than 18 inches (457 mm). Entrance steps that project beyond the street line shall be guarded at each end by railings or check pieces at least 3 feet (914 mm) high or by other members of the entrance detail providing equivalent protection.

**3202.2.1.2 Architectural details.** Details such as cornices, eaves, bases, sills, headers, band course, opening frames, sun control devices, rustications, applied ornament or sculpture, grilles, windows when fully open, air conditioning units, and other similar elements may be constructed:

1. To project not more than 4 inches (102 mm) beyond the street line when less than 10 feet (3048 mm) above the ground or sidewalk level.
2. To project not more than 10 inches (254 mm) beyond the street line when more than 10 feet (3048 mm) above the ground or sidewalk level.

**Exception:** Architectural details that are more than 10 feet (3048 mm) above the sidewalk and that project more than 10 inches (254 mm) may be permitted subject to the approval of the Commissioner of the Department of Transportation.

**3202.2.1.3 Balconies.** Balconies, including railings and supporting brackets, no parts of which are less than 10 feet (3048 mm) above the ground or sidewalk level, may be constructed to project not more than 22 inches (559 mm) beyond the street line. When permitted by the provisions of this code, fire escapes that are part of a required exit may be constructed to project not more than 4 feet 6 inches (1372 mm) beyond the street line provided no part, including any movable ladder or stair, is lower than 10 feet (3048 mm) above the ground or sidewalk level when not in use.

**3202.2.1.4 Marquees.** Marquees may be constructed to project beyond the street line provided that they comply with Section 3106 and Sections 3202.2.1.4.1 through 3202.2.1.4.5.

**3202.2.1.4.1 Height.** Marquees shall receive structural support only from the building, and shall be at least 10 feet (3048 mm) above the ground level or sidewalk.

**3202.2.1.4.2 Projection.** Marquees shall project no closer to the curb line than 2 feet (610 mm).

**3202.2.1.4.3 Thickness.** Marquees shall be no thicker nor shall the fascia be higher than 3 feet (914 mm) when measured from top to bottom.

**3202.2.1.4.4 Dimensions.** Dimensions shall include all decoration, but shall exclude any tension supports suspending the marquee from the wall.

**3202.2.1.4.5 Occupancy restrictions.** Marquees may be erected on:

1. Buildings of an essentially public nature including but not limited to the following:
  - 1.1 Public buildings.
  - 1.2. Theatres.
  - 1.3. Hotels.
  - 1.4. Terminals.
  - 1.5. Large department stores.
  - 1.6. Supermarkets.
  - 1.7. Multiple dwellings.
2. Warehouses or markets in one of the following established market areas:

## 2.1. Bronx.

2.1.1. Edgewater Road and Halleck Street between Lafayette Avenue and East Bay Avenue.

2.1.2. Lafayette Avenue between Edgewater Road and the Bronx River.

2.1.3. East Bay Avenue between Halleck Street and the Bronx River.

2.1.4. Hunt's Point Avenue between East Bay Avenue and the Bronx River.

2.1.5. Exterior Street between East 149<sup>th</sup> Street and East 157<sup>th</sup> Street.

2.1.6. Cromwell Avenue between East 150th Street and East 153<sup>rd</sup> Street.

2.1.7. East 150th Street between Exterior Street and River Avenue.

2.1.8. Westchester Avenue between St. Ann's Avenue and Bergen Avenue.

2.1.9. Brook Avenue between East 150th Street and East 156th Street.

2.1.10. Bergen Avenue between East 149th Street and East 156th Street.

2.1.11. East 152<sup>nd</sup> Street between Bergen Avenue and Brook Avenue.

2.1.12. East 153<sup>rd</sup> Street between Bergen Avenue and Brook Avenue.

## 2.2. Brooklyn.

2.2.1. North 6<sup>th</sup> Street between Berry Street and Wythe Avenue.

## 2.3. Manhattan.

2.3.1. John Street to Fulton Street between South Street and Front Street.

2.3.2. Fulton Street to Dover Street between South Street and Water Street.

2.3.3. South Street and Front Street between John Street and Dover Street.

2.3.4. Water Street between Fulton Street and Dover Street.

2.3.5. Horatio Street to West 14th Street between West Street and 9th Avenue.

2.3.6. West Street, Washington Street, Greenwich Street

2.3.7. 9th Avenue and 10th Avenue between Horatio Street and West 14th Street.

2.3.8. West 16th Street, north side, and West 17th Street, south side, between 10th Avenue and 11th Avenue.

2.3.9. West 24<sup>th</sup> Street to West 26<sup>th</sup> Street, south side, between 11<sup>th</sup> Avenue and 12<sup>th</sup> Avenue.

2.3.10. West 27th Street, north side, to West 28th Street between 11th Avenue and 12th Avenue.

2.3.11. 12th Avenue and St. Claire Place between 125th Street and 132nd Street.

2.3.12. 12th Avenue, west side, between 132nd Street and 133<sup>rd</sup> Street.

#### 2.4. Queens.

2.4.1. 95<sup>th</sup> Avenue, north side, between Sutphin Boulevard and 148<sup>th</sup> Street.

**3202.2.1.4.6 Change of occupancy.** When the occupancy or use of a building with a marquee is changed to an occupancy or use for which a projecting marquee is not permitted, the marquee shall be removed.

**Exception:** Where such marquee is subject to the jurisdiction of the Landmarks Preservation Commission such marquee shall not be removed without the prior approval of the Landmarks Preservation Commission.

**3202.2.1.4.7 Other agency approvals.** An applicant wishing to erect a marquee shall provide proof that the Commissioners of the Departments of Transportation, Consumer Affairs, and Environmental Protection have not permitted the use of a space or structure on or under the sidewalk beneath the proposed marquee in such

a manner that the construction of the proposed marquee shall interfere with the removal or repair of any such permitted use or structure.

**3202.2.1.5 Light fixtures** Light fixtures that are supported entirely from the building may be constructed to project not more than 2 feet (610 mm) beyond the street line, provided no part of the fixture is less than 8 feet (2438 mm) above the ground or sidewalk level.

**3202.2.1.6 Flagpoles.** Flagpoles that are supported entirely from the building may be constructed to project not more than 18 feet (5486 mm) beyond the street line, but not closer than 2 feet (610 mm) to the curb line, provided that no part of the flagpole is less than 15 feet (4572 mm) above the ground or sidewalk level.

**3202.2.1.7 Wall signs** Wall signs may be constructed to project not more than 12 inches (305 mm) beyond the street line when conforming to the requirements of this code and Section H111 of Appendix H.

**3202.2.1.8 Projecting signs** All permitted projecting signs may be constructed to project not more than 10 feet (3048 mm) beyond the street line, but not closer to the curb line than 2 feet (610 mm), when conforming to the requirements of this code and Section H112 of Appendix H, and provided that no part of the sign is less than 10 feet (3048 mm) above the ground or sidewalk level.

**Exceptions:** Permanent projecting signs are prohibited on buildings in the areas indicated below:

1. Borough of Manhattan.

1.1. Projecting signs. No permanent projecting sign shall be erected on any building on:

1.1.1. 5<sup>th</sup> Avenue between Washington Square north and 110<sup>th</sup> Street;

1.1.2. 34<sup>th</sup> Street between Park Avenue and 7<sup>th</sup> Avenue;

1.1.3. Madison Avenue between 23<sup>rd</sup> Street and 96<sup>th</sup> Street;

1.1.4. 57<sup>th</sup> Street between Lexington Avenue and Broadway;

1.1.5. Vanderbilt Avenue between 42<sup>nd</sup> Street and 47<sup>th</sup> Street;

1.1.6. Park Avenue between 32<sup>nd</sup> Street and 40<sup>th</sup> Street;

1.1.7. Park Avenue between 45<sup>th</sup> Street and 96<sup>th</sup> Street;

1.1.8. 33<sup>rd</sup> Street between Lexington Avenue and 5<sup>th</sup> Avenue;

1.1.9. 35<sup>th</sup> through 41<sup>st</sup> Streets between Lexington Avenue and 5<sup>th</sup> Avenue;

1.1.10. 43<sup>rd</sup> through 56<sup>th</sup> Streets between Lexington Avenue and 5<sup>th</sup> Avenue;

1.1.11. 58<sup>th</sup> Street between Lexington Avenue and 5<sup>th</sup> Avenue;

1.1.12. 60<sup>th</sup> Street between Lexington Avenue and 5<sup>th</sup> Avenue;

1.1.13. Nassau Street between Wall Street and Frankfort Street; or

1.1.14. John Street between Broadway and William Street.

1.2. Illuminated projecting signs. No permanent illuminated projecting sign shall be erected on any building on:

1.2.1. 72<sup>nd</sup> Street between Central Park West and River Drive.

## 2. Borough of Brooklyn.

2.1. Projecting signs. No permanent projecting sign shall be erected on any building on:

2.1.1. Fulton Street between Flatbush Avenue and Joralemon Street and Willoughby Street.

2.2. Illuminated projecting signs. No permanent illuminated projecting sign shall be erected on any building on:

2.2.1. Fulton Street between Flatbush Avenue and Prospect Street and Henry Street;

2.2.2. Washington Street between Myrtle Avenue and Prospect Street;

2.2.3. Court Street between Fulton Street and Livingston Street;

2.2.4. Pierrepoint Street between Fulton Street and Clinton Street;

2.2.5. Montague Street between Court Street and Clinton Street;

2.2.6. Remsen Street between Court Street and Clinton Street; or



2.2.7. Joralemon Street between Court Street and Clinton Street.

**3202.2.2 Encroachments not subject to area limitations.**

**3202.2.2.1 Ramps.** When a building erected prior to December 6, 1969 is altered to provide access to individuals who use wheelchairs, ramps constructed to provide such access may, with the approval of the commissioner, project beyond the street line for a distance of not more than 44 inches (1118 mm). Ramps shall comply with the applicable provisions of Chapter 11.

**3202.2.2.2 Bridges between buildings.** Bridges connecting buildings, and projecting beyond street lines may be permitted in accordance with applicable law. Such bridges shall be of a construction class that is at least equal to the higher class of the two buildings connected, and shall otherwise comply with the provisions of this code and other applicable laws and rules.

**3202.2.3 Awnings.** Awnings constructed in accordance with Section 3105 and supported entirely from the building may project beyond the street line as follows:

**3202.2.3.1 Store front awnings.** Store front awnings may project beyond the street line not more than 8 feet (2438 mm), provided no part of the awning is less than 8 feet (2438 mm) above the ground or sidewalk level, except for a flexible valance which may be not less than 7 feet (2134 mm) above the ground or sidewalk level, and provided that the awning box or cover does not project more than 12 inches (305 mm).

**3202.2.3.2 Awnings over windows or doors.** Awnings over windows or doors may project beyond the street line not more than 5 feet (1524 mm), provided that no part of the awning is less than 8 feet (2438 mm) above the ground or sidewalk level.

**3202.3 Reserved.**

**3202.4 Temporary encroachments.** Encroachments of temporary nature shall comply with Sections 3202.4.1 and 3202.4.2.

**3202.4.1 Sidewalk cafés.** Enclosures for sidewalk cafés, where permitted by the Commissioner of the Department of Consumer Affairs pursuant to applicable law and constructed in compliance with Section 3110, may be constructed beyond the street line.

**3202.4.2 Storm enclosures.** Storm enclosures projecting not more than 18 inches (457 mm) beyond the street line may be permitted during the period between November 15 and the following April 15. Such enclosures shall be removed at the end of this period. Construction of storm enclosures must comply with the requirements of this code including the fire resistance rating of the building to which it is appurtenant and Chapter 11 of this code.

**CHAPTER 33**  
**SAFEGUARDS DURING CONSTRUCTION OR DEMOLITION**

**SECTION BC 3301**  
**GENERAL**

**3301.1 Scope.** The provisions of this chapter shall govern the conduct of all construction or demolition operations with regard to the safety of the public and property. For regulations relating to the safety of persons employed in construction or demolition operations, *OSHA Standards* shall apply.

**3301.1.1 Responsibility for safety.** Nothing in this chapter shall be construed to relieve persons engaged in construction or demolition operations from complying with other applicable provisions of law, nor is it intended to alter or diminish any obligation otherwise imposed by law on the owner, construction manager, general contractor, contractors, materialmen, registered design professionals, or other party involved in a construction or demolition project to engage in sound design and engineering, safe construction or demolition practices including but not limited to debris removal, and to act in a reasonable and responsible manner to maintain a safe construction or demolition site.

**3301.1.2 Fire Code.** In addition to the requirements of this chapter, construction or demolition operations shall also be conducted in conformance with the *New York City Fire Code*.

**3301.2 Contractors.** Contractors, construction managers, and subcontractors engaged in building work shall institute and maintain safety measures and provide all equipment or temporary construction necessary to safeguard all persons and property affected by such contractor's operations.

**3301.3 Site Safety Managers, Coordinators and Superintendent of Construction.** A Site Safety Manager or Site Safety Coordinator must be designated and present on the construction or demolition of major buildings as defined by and in accordance with Section 3310. A Superintendent of Construction is required for the construction or demolition of such other buildings identified pursuant to rules promulgated by the commissioner.

**3301.4 Inspection of operations.** Inspection of operations for compliance with the provisions of this chapter may be performed by, or under, the authority of the person superintending the work. Unless otherwise specified by the provisions of this chapter, inspection and test reports relating to operations within the scope of this chapter shall be maintained by the permit holder or the person responsible for the inspection and made available to the department upon request.

**Exception:** Operations specifically required by this code to be inspected only by a registered design professional or special inspector.

**3301.5 Inspection of equipment.** Any equipment or device, except hand tools, that would affect public safety when operated shall be inspected by the person superintending the work or by his or her designated representative before the equipment or device is used on a specific job. Such inspection shall be made, and every defect or unsafe condition shall be corrected before use is permitted.

Any unsafe equipment or device shall immediately be made safe or removed from the site. Periodic inspection of equipment shall be performed during construction or demolition operations, and a record of such inspections shall be kept at the site for the duration of the work and made available to the department upon request.

### **3301.6 Sizes and stresses of materials and equipment.**

**3301.6.1 Sizes.** All sizes and dimensions prescribed in this chapter are minimum requirements. Lumber sizes are nominal or commercial except where stated otherwise.

**3301.6.2 Stresses.** Temporary equipment and constructions shall be designed so that the allowable stress values for the material as specified by this code are not exceeded.

**3301.6.3 Design capacity.** No structure, device, or equipment, whether permanent or temporary, including all partly or fully completed elements or sections of the building, shall be loaded in excess of its design capacity.

**3301.7 Design.** Whenever design is required by the provisions of this chapter, such design shall be executed by, or under, the supervision of a registered design professional who shall cause his or her seal and signature to be affixed to any drawings or specifications that may be required for the work unless specifically indicated by this chapter that the design may be executed by another individual. All such documents shall be kept at the site for inspection by the commissioner for the duration of the job.

**3301.8 Accident reporting.** The department shall be notified promptly, in accordance with the circumstances, of all accidents at construction or demolition sites.

**3301.9 Required signs.** The signs required below in Sections 3301.9.1 to 3301.9.6 shall be constructed of  $\frac{3}{4}$  inch (19 mm) plywood or sheet metal. The letters on the required signs shall be black on white background.

The required signs must be in place 24 hours prior to commencement of any construction or demolition activity and remain visible at the site until all work is completed. The signs shall be no larger than that needed to accommodate the required information in letters no less than 3 inches (76 mm) high.

**Exception.** Where construction or demolition operations are limited to the interior components of the building.

**3301.9.1 New buildings or demolitions.** At sites where a new building or full demolition permit is required, a sign with the statement “TO ANONYMOUSLY REPORT UNSAFE CONDITIONS AT THIS WORK SITE THAT ENDANGER WORKERS, CALL 311” in both English and Spanish shall be posted at a height of no more than 12 feet (3658 mm) above the ground on each perimeter of the site fronting a public thoroughfare.

**3301.9.2 Construction sites.** At a height of no more than 12 feet (3658 mm) above the ground on each perimeter of a construction site fronting a public thoroughfare, a sign shall be erected containing the following information:

1. The name, address and telephone number of the owner of the property;
2. The name, address and telephone number of the general contractor; and
3. The phone number for reporting complaints.

In addition, copies of all permits shall be displayed in a conspicuous location readily visible by the public.

**3301.9.3 Demolition sites.** At a height of no more than 12 feet (3658 mm) above the ground on each perimeter of a demolition site fronting a public thoroughfare, a sign shall be erected containing the following information:

1. The name, address, and telephone number of the owner of the property;
2. The name, address, and telephone number of the demolition contractor; and
3. The phone number for reporting complaints.

In addition, copies of all permits shall be displayed in a conspicuous location readily visible by the public.

**3301.9.4 Major buildings.** At all major building sites as defined in Section 3310, the following information shall be included, in both English and Spanish. The information may be included on the required construction or demolition sign, or on a separate sign placed at a height of no more than 12 feet (3658 mm) above the ground on each perimeter of the construction or demolition site fronting a public thoroughfare:

1. The telephone numbers of the department special units in charge of complaints on major buildings as identified pursuant to department rules; and
2. The telephone number of the department of transportation.

**3301.9.5 Sidewalk sheds.** Following the receipt of a permit to erect a sidewalk shed, the permit holder shall post a readily visible sign on the sidewalk shed. Such sign shall include:

1. The name, address, and telephone number of the permit holder;
2. The permit number; and
3. The expiration date of the permit. .

**3301.9.6 Scaffolds and Hoists.** Following the receipt of a permit to erect or suspend a scaffold, or erect a material or personnel hoist, the permit holder shall post a sign. Such sign shall be plainly visible from the street and include the name, address, telephone number of the permit holder, and permit number. The sign shall also include the expiration date of the permit.

The sign shall either be:

1. Affixed to the scaffold, runback structure, or a protective structure described in Section 3307. When attached to a scaffold or runback structure, the effects of wind on the sign shall be taken into consideration by a qualified individual in accordance with the provisions of Section 3314.3; or
2. Placed at the job site in at least one place readily visible to the public.

**3301.10 Obscured lawful signs.** When a protective structure is constructed in accordance with Section 3307, a temporary sign may be posted on such protective structure when the structure is adjacent to any building and obscures from view a lawful and existing sign. The temporary sign shall comply with the following requirements:

1. The temporary sign shall be securely fastened to the face of the protective structure at a location directly in front of such business storefront;
2. No projecting temporary signs shall be permitted, and all temporary signs shall be limited to a maximum height of 4 feet (1219 mm), and when affixed to a sidewalk shed shall not project above the parapet;
3. No temporary signs shall be permitted on the ends of any protective structure, unless the lawful and existing sign would otherwise be obscured from view by a deck or parapet of a sidewalk shed or bridge; and
4. No temporary sign shall project below the deck of any sidewalk shed.

**SECTION BC 3302**  
**DEFINITIONS**

**3302.1 Definitions.** The following words and terms shall, for the purposes of this chapter, have the following meanings.

**ARCHITECT.** See Chapter 1 of Title 28 of the *Administrative Code*.

**ARTICULATING BOOM CRANE.** A power operated machine for lifting or lowering a load and moving it horizontally that utilizes a boom consisting of a series of folding pin connected structural members, typically manipulated to extend or retract by power from hydraulic cylinders, with or without a hoisting mechanism integral to the machine.

**AXIS OF ROTATION.** The vertical axis around which the crane superstructure rotates.

**AXLE.** The shaft or spindle with which or about which a wheel rotates. On truck and wheel mounted cranes it refers to an automotive type of axle assembly including housing, gearing, differential, bearings and mounting appurtenances.

**BASE (MOUNTING):** The base or carrier on which the rotating superstructure is mounted such as a truck, crawler or platform.

**BEARER (PUTLOG).** A horizontal transverse scaffold member (which may be supported by legs or runners) upon which the scaffold platform rests and joins scaffold uprights, posts, poles, and similar members.

**BOOM.** A section or strut, of which the heel (lower end) is affixed to a base, carriage or support, and whose upper end supports a cable and sheaves where the load is lifted by means of wire rope and a hook.

**BOOM POINT.** The outward end of the top section of the boom, containing the hoist sheave assembly.

**BRAKE.** A device used for retarding or stopping motion by friction or power means.

**BUCKET HOIST.** A power or manually operated suspended bucket contained by guide rails used for raising or lowering material exclusively and controlled from a point outside the conveyance.

**CABLEWAY.** A power operated system for moving loads in a generally horizontal direction in which the loads are conveyed on an overhead cable, track or carriage.

**CERTIFICATE OF APPROVAL.** A certificate issued by the department upon review and approval of the engineering and testing of a specific make and model of hoisting equipment to ensure compliance with the applicable provisions of this code and its referenced standards

**CERTIFICATE OF OPERATION.** A certificate issued by the department annually upon satisfactory inspection of the hoisting equipment holding a certificate of approval to ensure that the equipment continues to be in compliance with this code and its referenced standards.

**CERTIFICATE OF ON-SITE INSPECTION.** A certificate issued by the department based on a site specific approval of the placement, founding and operation of hoisting equipment.

**COMMERCIAL TRUCK MOUNTED CRANE (BOOM TRUCK).** A crane consisting of a rotating superstructure (center post or turntable), boom, operating machinery, and one or more operator's stations mounted on a frame attached to a commercial truck chassis, usually retaining a payload hauling capability whose power source usually powers the crane. Its function is to lift, lower, and swing loads at various radii.

**CLAMSHELL.** A shovel bucket with two jaws which clamp together by their own weight when it is lifted by a closing line.

**COMPETENT PERSON.** One who is capable of identifying existing predictable hazards in the surroundings or conditions that are unsanitary, hazardous or dangerous, and who has authorization to take prompt corrective measures to eliminate such hazards.

**CONSTRUCTION.** The excavation, erection, alteration, and repair of buildings or any component parts, including all operations incidental thereto.

**CORNER SCAFFOLD (ANGLE SCAFFOLD).** A suspended scaffold consisting of an assembly of two or more platforms connected non-linearly and designed and manufactured to fit around a corner or a projecting part of a building.

**COUNTERWEIGHT.** Weight used to supplement the weight of the machine in providing stability for lifting loads.

**CRANE.** A power operated machine for lifting or lowering a load and moving it horizontally which utilizes wire rope and in which the hoisting mechanism is an integral part of the machine. The definition of a crane shall also include articulating boom crane, regardless of whether it has a hoisting mechanism integral to the machine.

**CRAWLER CRANE.** A crane consisting of a rotating superstructure with a power plant, operating machinery, and boom, mounted on a base and equipped with crawler treads for travel. Its function is to lift, lower, and swing loads at various radii.

**DEBRIS NET or NETTING.** A netting of a fine mesh of a size and strength sufficient to catch debris such as falling tools and materials.

**DEMOLITION.** Full or partial demolition.

**DEMOLITION, FULL.** The dismantling, razing, or removal of all of a building or structure, including all operations incidental thereto.

**DEMOLITION, PARTIAL.** The dismantling, razing, or removal of structural members, floors, interior bearing walls, and/or exterior walls or portions thereof, including all operations incidental thereto.

**DERRICK.** An apparatus consisting of a mast or equivalent member held at the end by guys or braces, with or without a boom, for use with a hoisting mechanism and operating ropes, for lifting or lowering a load and moving it horizontally.

**DRUM.** The cylindrical member around which a rope is wound for raising and lowering the load or boom.

**ENGINEER.** See Chapter 1 of Title 28 of the *Administrative Code*.

**FULL DEMOLITION.** See “Demolition, Full.”

**GUARDRAIL SYSTEM (SCAFFOLD).** A vertical barrier as described in Section 3314.8 consisting of, but not limited to, top rails, midrails and posts, erected to prevent falling from a scaffold platform or walkway to lower levels.

**GUY.** A rope used to steady or secure the mast or other members in the desired position.

**HEAVY DUTY SIDEWALK SHED.** A sidewalk shed designed to carry a live load of at least 300 pounds per square foot (1465 kg/m<sup>2</sup>).

**HOISTING MACHINE.** A power operated machine used for lifting or lowering a load, utilizing a drum and a wire rope, excluding elevators. This shall include but not be limited to a crane, derrick, cableway and hydraulic lifting system, and articulating booms.

**HOISTING MECHANISM.** A hoist drum and rope reeving system used for lifting and lowering loads.

**HOISTING EQUIPMENT.** Equipment used to raise and lower personnel and/or material with intermittent motion.

**JIB.** An extension attached to the boom point to provide added boom length for lifting specified loads. The jib may be in line with the boom or offset to various angles in the vertical plane of the boom.

**JUMP (JUMPING).** The process of adding or removing mast or tower sections to equipment that has already been erected.

**LAY.** That distance measured along a wire rope in which one strand makes one complete helical convolution about the core or center.



**LIGHT DUTY SIDEWALK SHED.** A sidewalk shed designed to carry a live load of at least 150 pounds per square foot (732.3 kg/m<sup>2</sup>)

**LOAD (WORKING).** The external load, in pounds (kilograms), applied to the crane or derrick, including the weight of auxiliary load attaching equipment such as lower load blocks, shackles and slings.

**LOAD RATINGS.** Crane and derrick ratings in pounds (kilograms) established by the manufacturer in accordance with standards set forth in rules promulgated by the commissioner.

**LOAD RATING CHART.** A full and complete range of manufacturer's crane load ratings at all stated operating radii, boom angles, work areas, boom lengths and configurations, jib lengths and angles (or offset), as well as alternative ratings for use and nonuse of optional equipment on the crane, such as outriggers and extra counterweights, that affect ratings.

**LOWER LOAD BLOCK.** The assembly of hook or shackle, swivel, sheaves, pins and frame suspended by the hoisting ropes.

**MAST-CLIMBING WORK PLATFORMS.** A powered device consisting of an elevating platform mounted on a base or chassis and mast, that when erected is capable of supporting personnel, material, equipment and tools on a deck or platform that is capable of traveling vertically in infinitely adjustable increments to reach the desired work level.

**MATERIAL HANDLING EQUIPMENT.** A power or manually operated platform, bucket, car or cage that moves horizontally and is mainly used for transporting material during construction, alteration, repair or demolition of a building or structure.

**MATERIAL HOIST (MATERIAL HOISTING EQUIPMENT).** A power or manually operated platform, bucket, car or cage that moves vertically and is used for raising or lowering material exclusively during construction, alteration, repair or demolition of a building or structure, and is controlled from a point outside the conveyance.

**MOBILE CRANE.** A commercial truck mounted crane, crawler crane, wheel mounted crane (multiple control stations), or wheel mounted crane (single control station).

**MOBILE SCAFFOLD.** A powered or unpowered, portable, caster, track or wheel-mounted supported scaffold.

**MULTI-POINT ADJUSTABLE SUSPENSION SCAFFOLD.** A suspension scaffold consisting of a platform(s) that is suspended by more than two ropes from overhead supports and equipped with a means to raise and lower the platform to the desired work levels.

**OUTRIGGER (CRANE).** Extendable or fixed members attached to the mounting base that rest on supports at the outer ends used to support the crane.

**OUTRIGGER (SCAFFOLD).** The structural member of a supported scaffold used to increase the base width of a scaffold in order to provide support for and increased stability of the scaffold.

**OUTRIGGER BEAM (THRUSTOUT).** The structural member of a suspension scaffold or outrigger scaffold that provides support for the scaffold by extending the scaffold point of attachment to a point out and away from the structure or building.

**OUTRIGGER SCAFFOLD.** A supported scaffold consisting of a platform resting on outrigger beams (thrustouts) projecting beyond the wall or face of the building or structure, the inboard ends of which are secured inside the building or structure

**PARTIAL DEMOLITION.** See “Demolition, Partial.”

**PERSONNEL HOIST.** A mechanism and its hoistway, equipped with a car that moves vertically on guide members, used for hoisting or lowering workers or workers and materials for the construction, alteration or demolition of a building structure or other work

**PLATFORM.** A work surface elevated above lower levels. Platforms can be constructed using individual wood planks, fabricated planks, or fabricated decks.

**POWER BUGGIES.** An automotive vehicle designed or used for the transportation of materials on or about construction or demolition sites. It shall not include automobiles, motor trucks, general purpose tractors, or excavating or material handling machinery.

**QUALIFIED PERSON.** A person who by possession of a recognized degree, certificate or professional standing, or who by knowledge, training and experience, has demonstrated his or her ability to solve or resolve problems related to the subject matter, the work or the project.

**REGISTERED DESIGN PROFESSIONAL.** An architect or engineer.

**ROPE.** Wire rope unless otherwise specified.

**RUNBACK STRUCTURE.** A temporary system of hoistway landing runways, vertical supports and horizontal diaphragms designed to bridge between the hoistway and the parent structure and to transmit both vertical and horizontal loads to the supporting structure and/or foundation.

**SCAFFOLD.** Any temporary elevated platform and its supporting structure (including points of anchorage) used for supporting workers or workers and material. Includes supported scaffold, suspension scaffold and mobile scaffold.

**SINGLE-POINT ADJUSTABLE SUSPENSION SCAFFOLD.** A suspension scaffold consisting of a platform suspended by one rope from an overhead support and equipped with means to permit the movement of the platform to desired work levels.

**STANDARD GUARDRAIL SYSTEM (SCAFFOLD).** See Guardrail System (Scaffold).

**STRUCTURAL NET or NETTING.** A system of nets capable of complying with the prototype test described in ANSI A10.11-1989.

**SUPERSTRUCTURE.** The rotating upper frame structure of the machine and the operating machinery mounted thereon.

**SUPPORTED SCAFFOLD.** One or more platforms supported by outrigger beams, brackets, poles, legs, uprights, posts, frames, including pre-fabricated frames that are mechanized but not motorized, or any similar rigid support, including back structures connecting hoistways to buildings, and including structures where sidewalk protection is constructed as an integral part of the apparatus.

**SUSPENSION SCAFFOLD.** One or more platforms suspended by ropes or other means from an overhead structure.

**SUSTAINED WIND.** Winds with a one minute average duration lasting for a one hour period or longer.

**SWING.** Rotation of the superstructure for movement of loads in a horizontal direction about the axis of rotation.

**TOWER.** A vertical structural frame consisting of columns and bracing that are capable of supporting working and dynamic loads and transmitting them to the support(s).

**TOWER CRANE.** A power operated hoisting machine that utilizes a vertical tower with a rotating superstructure and includes a load boom (jib) in order to lift or lower a load and move it horizontally.

**TRANSIT.** The moving or transporting of a crane from one job site to another.

**TRAVEL.** The function of the machine moving from one location to another on a job site.

**TWO-POINT SUSPENSION SCAFFOLD (SWING STAGE).** A suspension scaffold consisting of a platform supported by hangers (stirrups) suspended by two ropes from

overhead supports and equipped with means to permit the raising and lowering of the platform to desired working levels.

**WHEEL MOUNTED CRANE (MULTIPLE CONTROL STATIONS).** A crane consisting of a rotating superstructure, operating machinery, and operator's station and boom, mounted on a crane carrier equipped with axles and rubber-tired wheels for travel, a power source(s), and having separate stations for driving and operating. Its function is to lift, lower, and swing loads at various radii.

**WHEEL MOUNTED CRANE (SINGLE CONTROL STATION).** A crane consisting of a rotating superstructure, operating machinery, and boom, mounted on a crane carrier equipped with axles and rubber-tired wheels for travel, a power source, and having a single control station for driving and operating. Its function is to lift, lower, and swing loads at various radii.

## **SECTION BC 3303** **SAFEGUARDS AND MAINTENANCE OF SITE**

### **3303.1 Equipment.**

**3303.1.1 Machinery.** All exposed, electrically charged, moving or otherwise dangerous parts of machines and construction or demolition equipment shall be located, guarded, shielded, or barricaded so as to prevent contact by the public.

**3303.1.2 Service lines and conduits.** Hose lines, wires, ropes, pipes, chains and conduits shall be located so that they will not constitute a tripping hazard. Where it is necessary to carry such lines across sidewalks, or any public way, they shall either be suspended at least 8 feet (2438 mm) above the walks, or suitable chamfered planks or a pedestrian bridge shall be provided.

**3303.1.3 Contractors sheds.** Contractors sheds and offices located within 30 feet (9144 mm) of new construction or existing buildings shall be made of metal or other noncombustible material. Fire retardant treated wood may be used when protected from the weather.

**3303.1.4 Internal combustion-powered equipment.** In addition to the requirements of this chapter, the use of internal combustion-powered equipment shall also comply with the *New York City Fire Code*.

### **3303.2 Utilities.**

**3303.2.1 Existing services.** The location of all existing utilities and service lines shall be determined and adequate measures taken, or devices provided, to safeguard the public and property before such utilities are disturbed. If any utility is to be removed, relocated, or have its service interrupted, the utility company or city agency affected shall be notified at least 72 hours in advance.

**3303.2.2 Maintaining essential services.** Fire preventive, sanitary, or other facilities that have been provided for the protection of life, health, and property shall be continuously maintained and protected unless authorization is obtained from the agency having jurisdiction to temporarily or permanently disconnect such facility.

**3303.2.3 Electrical work.** All temporary electrical equipment and wiring shall meet the requirements of the *New York City Electrical Code*, and shall be maintained in compliance with such requirements. Portions of permanent electrical installations may be used for temporary operations provided the requirements of the *New York City Electrical Code* are met.

The person superintending the work shall notify the utility company affected at least 72 hours before the commencement of work that may affect a power line, above or below ground.

**3303.2.4 Sanitary facilities.** Sanitary facilities shall be provided during construction, remodeling, or demolition activities in accordance with the *New York City Plumbing Code*.

**3303.3 Obstruction of sidewalks and streets.** No street or sidewalk shall be closed either in whole or in part without a permit from the department of transportation. Such permit shall be displayed at the job site.

The closing or temporary use of streets or sidewalks or the obstruction of any part thereof shall comply with the requirements of the department of transportation.

#### **3303.4 Housekeeping.**

**3303.4.1 Maintenance.** All areas used by the public shall be maintained free from ice, snow, grease, debris, equipment, materials, projections, tools, or other items, substances, or conditions that may constitute a slipping, tripping, or other hazard.

**3303.4.2 Waste dumpsters, debris boxes and skip boxes.** Waste dumpsters, debris boxes and skip boxes shall comply with the following:

1. Waste dumpsters, debris boxes and skip boxes shall be secured by rope, cable or chocking at wheels at the end of the workday in order to prevent movement. Such waste dumpsters, debris boxes and skip boxes shall not be placed at the edge of the building at any time, except when being moved from the floor or building.
2. Containers containing debris or waste shall be covered at the end of the workday and at any time when full to near the rim. Containers need not be

covered when they are not in use or while stored in a fully enclosed space at the end of the workday.

**3303.4.3 Containers.** Sufficient containers of metal, canvas, plastic or other material acceptable to the commissioner shall be available for the storage of all garbage and debris.

**3303.4.4 Debris.** Debris control shall comply with the following:

1. All debris shall be cleaned off floors daily.
2. The roof of the sidewalk shed and the street shall be cleaned of construction or demolition debris daily.
3. A daily inspection shall be made for construction or demolition debris on all floors and if the building is a major building, such inspection shall be noted in the site safety log.

**3303.4.5 Storage of materials during construction or demolition.** Materials stored on the floors of a building during construction or demolition operations shall comply with Sections 3303.4.5.1 and 3303.4.5.2.

**3303.4.5.1 Housekeeping.** Housekeeping shall be conducted as follows:

1. When not being used, materials, equipment and tools that might fall from levels above areas used by the public shall be kept away from edges or openings.
2. When exterior walls are not in place, stored material shall be kept at least 10 feet (3048 mm) back from the perimeter of the building. However, when the floor area is less than 1,000 square feet (304.8 square meters), stored material may be kept not less than 5 feet (1524 mm) back from the perimeter of the building.
3. Material may be stored between 5 and 10 feet (1524 and 3048 mm) back from the perimeter of the building when such material weighs less than 750 pounds (340.2 kg).
4. Material stored on floors of a building or elsewhere on the site shall be secured when not being used.

**3303.4.5.2 Storage of materials at top working floors.** Storage of materials at top working floors shall comply with the following:

1. Material may be stored within 2 feet (610 mm) of the edge of a building provided that such material is stored not more than two stories below the

stripping operation on concrete structures, or the uppermost concrete floor on steel frame structures. Such material shall be secured against accidental movement. Storage of material on all other floors shall conform to Section 3303.4.5.1 and shall be secured when not being used.

2. No material shall hang over the edge of a building unless banded and braced preparatory to relocation at the end of the workday. Where such material is so banded and braced, it may overhang the floor of the stripping operation by not more than one-third of its length so long as it is relocated on the next workday for concrete operations.
3. Where the steel mill and lumber mill are located, material may overhang for relocation until the next workday. No more than two floors shall be designated as steel mills or lumber mills.

**3303.4.6 Storage of combustible material and equipment.** Storage of combustible material and other material and equipment that may present a fire hazard shall comply with the *New York City Fire Code*.

**3303.5 Removal of waste material.** Waste materials shall be removed in a manner that prevents injury or damage to persons, adjoining properties and public rights-of-way.

**3303.5.1 Removal of combustible waste material.** Combustible waste material or combustible debris shall not be permitted to accumulate, and shall be removed from the site at reasonable intervals in accordance with the requirements of the *New York City Fire Code*.

**3303.5.2 Dropping or throwing prohibited.** No material shall be dropped or thrown outside the exterior walls of a building.

**3303.5.3 Clogging.** Precautions shall be taken to prevent concrete or mortar washings, sand, grit, or any other material that would cause clogging from entering a sewer or drain.

**3303.5.4 Air pollution.** The provisions of the *Air Pollution Control Code* shall apply in order to prevent particulate matter from becoming airborne.

**3303.5.2 Chutes.** Chutes used in association with the removal of materials shall comply with Sections 3303.5.2.1, 3305.2.2, 3305.2.3, and 3305.2.4.

**3303.5.2.1 Enclosures.** Chute enclosures shall comply with the following requirements:

1. Material chutes that are at an angle of more than forty-five degrees with the horizontal shall be entirely enclosed on all sides, except for openings at the floor levels for the receiving of materials. Such openings shall not

exceed 48 inches (1219 mm) in height, measured along the wall of the chute, and all openings, except the top opening, shall be closed and secured when not in use.

2. Chutes at an angle of less than forty-five degrees with the horizontal may be open on the upper side.

**3303.5.2.2 Chute construction.** Chute construction shall comply with the following requirements:

1. Every chute used to convey waste material from a building shall be rigidly supported and braced throughout its height. Chutes less than 24 inches (610 mm) in maximum dimension shall be constructed of not less than 1-inch (25.4 mm) (nominal) wood or 1/8 inch (3.18 mm) thick steel. Chutes more than 24 inches (610 mm) in maximum dimensions shall be constructed of not less than 2-inch (51 mm) (nominal) wood or 3/16 inch (4.76 mm) thick steel.
2. Chutes shall be provided with a metal impact plate where material is forced to change direction while falling.
3. A gate shall be provided at the lower end of every chute to control the loading of material into trucks and to close the chute at all other times. Splashboards or baffles shall be erected to prevent materials from rebounding into the street or under the sidewalk shed.
4. A bumper or curb at least 4 inches by 4 inches (102 by 102 mm) in section shall be provided at each chute opening where such opening is level with, or below, the floor or platform. Every space between the chute and the edge of the opening in the floor or platform shall be solidly planked.

**3303.5.2.3 Fire retardant construction.** When used in the following applications, all chutes constructed of combustible material shall be covered on the exterior with corrugated steel sheeting having a minimum thickness of 24 gauge through their entire height. Alternatively, chutes shall be constructed of non-combustible material:

1. Chutes exceeding 75 feet (22 860 mm) in height.
2. Alteration, repair or partial demolition of buildings classified in occupancy groups I-1 to I-4.

**3303.5.2.4 Supports.** All structural supports of material chutes shall be of noncombustible material.



**3303.6 Escape hatches.** Where salamanders or other heating equipment are used to provide temporary heating during the placing of concrete for a floor, an escape hatch shall be provided from the floor where the concrete is being placed and shall extend through at least one story immediately below such floor. The escape hatch shall be located as near to the center of the building as practical.

**3303.6.1 Required ladders and metal shields.** The escape hatch shall be constructed with at least two ladders enclosed in a metal shield. The ladders shall extend from a distance of 3 feet (914 mm) above the floor under construction to at least two stories below, unless such floor is less than two stories above the lowest floor. The metal shield shall enclose the ladders on all sides from the top of the floor where the concrete is being placed to at least the top of the floor next below. The inside dimensions between faces of the shield shall be not less than 3 feet 8 inches (1118 mm).

**3303.6.2 Shield space and decking.** The space between the shield and the perimeter of the opening in the floor under construction and also between the shield and the perimeter of the opening in the floor next below, shall be decked over with 2-inch (51 mm) or heavier planking covered with plywood or sheet metal so as to make the decking smoke tight. At the termination of the ladders, the opening in the floor shall be covered completely with 2-inch (51 mm) planking or other material of equivalent strength.

**3303.7 Fire prevention and fire protection.** Fire fighting equipment, access at the construction or demolition site and the conduct of all construction or demolition operations affecting fire prevention and fire fighting shall comply with the *New York City Fire Code*.

**3303.7.1 Water supply.** No hazardous or combustible material shall be kept at the site unless water supply for fire protection, either temporary or permanent, is available at the site.

**3303.7.2 Fire extinguishers.** Fire extinguishers shall be provided in accordance with the *New York City Fire Code*.

**3303.8 Standpipe systems during construction, alteration or demolition.** During construction, alteration or demolition operations, standpipe systems shall comply with the following:

- 1.** When work reaches a height greater than 75 feet (22 860 mm) in a building for which a standpipe system will be required, a permanent or temporary standpipe meeting the requirements of Section 905 shall be kept in readiness at all times for use by fire fighting personnel. The system shall be a dry system when freezing conditions may be encountered.

2. Existing standpipe systems in structures undergoing demolition shall be maintained as dry standpipes. At the commencement of demolition, the standpipe risers shall be capped above the outlet on the floor immediately below the floor being demolished so as to maintain the standpipe system on all lower floors for Fire Department use. Standpipe hose, nozzles and spanners are not required to be maintained and may be removed at any time. Siamese hose connections shall be kept free from obstruction and shall be marked by a metal sign reading, "Standpipe Siamese Connection" and by a red light at night.
3. The standpipe system may be used for water supply necessary to demolition operations. In freezing weather, such standpipe system shall be completely drained after use to prevent freezing. Existing standpipe systems shall not be utilized to convey compressed air unless the standpipe consists of two or more risers. In such case and upon fire department approval, one of the risers may be used to convey compressed air to any floor or portion of the premises.

**3303.9 Elements to be maintained during remodeling and additions.** Required exits, existing structural elements, fire protection devices and sanitary safeguards shall be maintained at all times during remodeling, alterations, repairs or additions to any building or structure.

**Exception:** When such required elements or devices are being remodeled, altered or repaired and adequate alternate provisions are made.

**3303.10 Repair and alteration operations in occupied buildings.** Where repairs or alterations are conducted in occupied buildings, barricades, signs, drop cloths, and other protective means shall be erected as required to provide reasonable protection for the occupants against hazard and nuisance. In buildings containing occupied dwelling units, all work shall be performed in accordance with a tenant protection plan as required by Chapter 1 of Title 28 of the *Administrative Code*.

**3303.11 Maintenance of exits during construction or demolition.** Required means of egress shall be maintained at all times during construction or demolition.

**Exception:** Where there are approved temporary means of egress systems and facilities.

**3303.11.1 Stairways required.** Where a building has been constructed to a height greater than 50 feet (15 240 mm) or four stories, or where an existing building exceeding 50 feet (15 240 mm) in height is altered or demolished, at least one temporary lighted stairway shall be provided, unless one or more of the permanent stairways are erected or maintained as the construction or demolition progresses.

**3303.11.1.1 Maximum distance.** The maximum distance between the working deck of a building under construction or demolition and the highest floor accessible to a temporary or permanent stair shall be no more than 40 feet or 4

floors. In concrete construction, the working deck is the floor being formed. In steel construction the working deck is the floor where the metal decking and steel components are being placed before concrete is poured.

**3303.12 Temporary elevator or hoist.** Whenever construction or demolition work reaches a height greater than 75 feet (22 860 mm), at least one elevator meeting the requirements of Chapter 30, or a hoist meeting the requirements of Section 3318 shall be kept in readiness at all times for Fire Department use. The maximum distance between the highest accessible floor from a temporary elevator or hoist and the working deck of the building under construction or demolition shall be no more than 75 feet (13 716 mm) or 7 floors. In concrete construction, the working deck is the floor being formed. In steel construction the working deck is the floor where the metal decking and steel components are being placed before concrete is poured.

If the travel of the hoist cannot be increased due to inclement weather, it shall be increased by the end of the next working day.

### **3303.13 Abandoned and discontinued operations.**

**3303.13.1 Fencing.** If any construction or demolition operation is abandoned, discontinued or interrupted, a solid fence meeting the requirements of Section 3307.7 shall be provided to protect the public from potential hazards on the site.

**3303.13.2 Filling and grading.** When permits have expired and when no permits have been issued within three months of the cessation of excavation operations, the lot shall be filled and graded to eliminate all steep slopes, holes, obstructions, or similar sources of hazard.

Fill shall consist of clean, noncombustible material. The final surface shall be graded in such a manner as to drain the lot, eliminate pockets in the fill, and prevent the accumulation of water, without damaging any foundations on the premises or on adjoining property.

**3303.14 Drainage.** No condition shall be created as a result of construction or demolition operations that will interfere with natural surface drainage.

Water courses, drainage ditches, etc., shall not be obstructed by refuse, waste building materials, earth, stones, tree stumps, branches, or other debris that may interfere with surface drainage or cause the impoundment of surface waters.

## **SECTION BC 3304** **EXCAVATION**

**3304.1 Scope.** The provisions of this section shall apply to all excavations, including those made for the purposes of taking earth, sand, gravel, or other material, as well as for

purposes of construction or demolition. During excavation, the provisions of Section 3309 for the protection of adjoining property shall also apply.

**3304.2 Excavation and fill.** Excavation and fill operations shall be conducted in such a manner that life and property are not endangered.

**3304.2.1 Removal of wood.** Stumps and roots shall be removed from the soil to a depth of at least 12 inches (305 mm) below the surface of the ground in the area to be occupied by the building. Wood forms which have been used in placing concrete, if within the ground or between foundation sills and the ground, shall be removed before a building is occupied or used for any purpose. Before completion, loose or casual wood shall be removed from direct contact with the ground under the building.

### **3304.3 Notification.**

**3304.3.1 Notification of the department.** No earthwork within the property line shall commence unless the permit holder notifies the department, via phone or electronically, at least 24 hours, but no more than 48 hours prior to the commencement of such work. The notification shall state the date that such earthwork is to commence. Should the notification date fall on a weekend or official holiday, the permit holder shall notify the department on the last business day before the commencement date.

In the event that the earthwork does not begin on the date provided in the notification to the department, the permit holder shall notify the department of its cancellation not more than 24 hours prior to but no later than the date for which the earthwork was scheduled. Should the cancellation date fall on a weekend or an official holiday, the permit holder shall notify the department on the next business day after the intended commencement date. The permit holder shall notify the department of a new intended commencement date pursuant to the provisions above.

The commissioner may issue a stop work order if there is a failure to provide notice as required in this section and if the work is found to violate any of the provisions of this code, the *Zoning Resolution*, or other applicable laws or rules. Upon the issuance of such stop work order, the work shall be stopped for a minimum of three business days to enable the department to take any other appropriate action to ensure that the earthwork is being performed in a safe manner. The earthwork shall not recommence until the stop work order has been lifted.

#### **Exceptions:**

1. Hand excavation work that extends 5 feet (1524 mm) or less below the grade existing at the time of earthwork commencement and is 2 feet (610 mm) or more from an existing foundation. This exception shall not apply to any hand excavation work performed anywhere in existing or demolished basements or cellars that adjoin existing foundations.

2. Excavations for geotechnical observation that do not exceed 10 feet (3048 mm) in length, width or diameter and that are excavated under the supervision of a registered design professional.
3. Work on cemetery grounds for burials.
4. Emergency work performed by the Department of Housing Preservation and Development (HPD) or other agency as directed by the commissioner or work on unsafe buildings performed by HPD or other agency pursuant to a precept.

**3304.3.2 Notification of adjacent building owners.** When an excavation to a depth of 5 to 10 feet (1524 mm to 3048 mm) is to be made within 10 feet (3048 mm) of an adjacent building, or when any excavation over 10 feet (3048 mm) is to be made anywhere on the site, the person causing an excavation to be made shall provide written notice to the owners of the adjacent building or buildings not less than 10 days prior to the scheduled starting date of the excavation. The written notice shall provide a description of the work to be performed, the timeframe and schedule, and contact information of the person causing the excavation and of the department.

**3304.3.3 Underground construction operations.** Whenever excavation or drilling, for any purpose, to a depth greater than 100 feet (30 480 mm) is proposed in a block that has any part of its boundary falling within 500 feet (152 m) horizontal distance from the centerline of any water tunnel as measured at or near the surface (the "Corridor"), or whenever excavation of any depth is proposed within 200 feet (60 960 mm) of any subway, an approval and permit shall be obtained from the New York City Department of Environmental Protection and from the New York City Transit Authority, respectively. The owner of the premises or the contractor shall notify the New York City Department of Environmental Protection or the New York City Transit Authority prior to commencement of any such activity. The issuance of any permit or approval by the department shall not relieve the applicant of the obligation to comply with any approval or permitting requirements of the New York City Department of Environmental Protection or the New York City Transit Authority.

**3304.3.3.1 Excavations requiring permit from the New York State Department of Environmental Conservation.** Whenever drilling or excavation is planned deeper than five hundred (500) feet below grade, a permit may be required from the New York State Department of Environmental Conservation. The issuance of any permit or approval by the department shall not relieve the applicant of the obligation to comply with any approval or permitting requirements of the New York State Department of Environmental Conservation. Whenever any drilling for borings or geothermal wells is planned, the owner of the premises or the contractor shall notify the New York State Department of Environmental Conservation prior to commencement of such activity to determine if a permit is necessary.

## **3304.4 Protection of sides of excavations.**

**3304.4.1 Shoring and bracing and sheeting.** The sides of all excavations, including related or resulting embankments, that are 5 feet (1524 mm) or greater in depth or height measured from the level of the adjacent ground surface to the deepest point of the excavation, shall be protected and maintained by shoring, bracing, sheeting, sheet piling, or by other retaining structures as may be necessary to prevent the sides of the excavation from caving in before permanent supports are provided. Such methods of protection shall be subject to special inspection in accordance with the provisions of Chapter 17.

Alternatively, excavation sides may be sloped not steeper than 45 degrees or stepped so that the average slope is not steeper than 45 degrees with no step more than 5 feet (1524 mm) high, provided such slope does not endanger any structure, including subsurface structures. Deviation from the foregoing limitations for cut slopes shall be permitted only upon the completion of a soil investigation report acceptable to the commissioner.

**Exception: Rock cut excavation.**

**3304.4.1.1 Sheet piling and bracing.** Sheet piling and bracing used in trench excavations shall be at least equivalent in strength to that specified in Tables 3304.4.1.1(1) and 3304.4.1.1(2).

**3304.4.2 Rainstorms.** All sides or slopes of excavations or embankments shall be inspected after rainstorms, or any other hazard-increasing event, and safe conditions shall be restored.

**3304.4.3 Fence.** Every site with an excavation shall be enclosed with a fence that meets the requirements of Section 3307.7.

**3304.4.4 Guardrail.** A standard guardrail that meets the requirements of Section 3307.8, or a solid enclosure at least 3 feet 6 inches (1067 mm) high shall be provided along the open sides of excavations, except that such standard guardrail or solid enclosure may be omitted from a side or sides when access to the adjoining area is precluded, or where side slopes are one vertical to three horizontal or flatter.

**3304.4.5 Placing of excavation equipment and excavated material.** Excavated material and superimposed loads such as equipment and trucks shall not be placed closer to the edge of the excavation than a distance equal to one and one-half times the depth of such excavation, unless the excavation is in rock or unless the sides of the excavation have been sloped or sheet piled (or sheeted) and shored to withstand the lateral force imposed by such superimposed loads. When sheet piling is used, it shall extend at least 6 inches (152 mm) above the natural level of the ground. In the

case of open excavations with side slopes, the edge of excavation shall be taken as the toe of the slope.

**3304.4.6 Mechanical diggers.** Where trenching more than 5 feet (1524 mm) in depth is done by a mechanical digger, the required protection shall follow the boom as closely as practical.

**3304.5 Underpinning requirements.** The requirements of Section 1814 shall apply.

**3304.6 Retaining walls.** The requirements of Section 1806 shall apply.

**3304.7 Access.** Every excavation shall be provided with a safe means of ingress and egress that is kept available at all times.

**3304.8 Drainage.** All excavations shall be drained and the drainage maintained as long as the excavation continues or remains. Where necessary, pumping shall be used, provided proper permits are obtained from the New York City Department of Environmental Protection.

## **SECTION BC 3305** **ERECTION OPERATIONS**

**3305.1 Protection of pedestrians and adjoining property.** During erection operations, the applicable provisions of Sections 3307, 3308, and 3309 shall apply.

**3305.2 Structural steel assembly.** The requirements of Section 2205.6.4 shall apply.

**3305.3 Concrete formwork.** The requirements of Section 1906 shall apply.

## **SECTION BC 3306** **DEMOLITION**

**3306.1 Scope.** All full demolition and partial demolition operations shall be performed in accordance with the requirements of this section.

**3306.2 Protection of pedestrians and adjoining property.** Demolition operations shall not commence until the applicable pedestrian and adjoining property protection is in place as required by Sections 3307, 3308, and 3309.

**3306.2.1 Safety zone.** A safety zone approved by the commissioner shall be provided around the demolition area. Fences that meet the requirements of Section 3307.7 shall be erected to prevent persons other than workers from entering such safety zone.

**Exception.** Partial demolition operations limited to the interior components of the building where mechanical demolition equipment, other than handheld devices, are not used.

**3306.3 Notification.** The permit holder shall notify the department and adjoining building owners prior to the commencement of full and partial demolition operations in accordance with Sections 3306.3.1 and 3306.3.2.

**3306.3.1 Notification of the department.** The permit holder shall notify the department via phone or electronically, at least 24 hours, but no more than 48 hours prior to the commencement of such work.

**3306.3.2 Notification of adjoining property owners.** Adjoining property owners shall be notified of upcoming demolition operations in writing not less than 10 days prior to the scheduled starting date of the demolition. The written notice shall provide a description of the work to be performed, the timeframe and schedule, and contact information of the person causing the demolition and of the department.

**Exception.** Partial demolition operations limited to the interior components of the building where mechanical demolition equipment, other than handheld devices, are not used.

**3306.4 Mechanical demolition.** Where mechanical demolition equipment, other than handheld devices, is to be used in the full or partial demolition of a building or is to be used to remove debris or move material, approval of the commissioner for the use of the mechanical demolition equipment must be obtained prior to the commencement of demolition operations.

Unless permitted by the commissioner, mechanical demolition equipment shall not be used where a building or portion thereof occupied by one or more persons is located within the safety zone.

**3306.5 Submittal documents for demolition.** Where mechanical demolition equipment, other than handheld devices, are to be used in the full or partial demolition of a building from within the building, or are to be used within the building to remove debris or move material, documents prepared by or under the supervision of an engineer must be submitted and approved by the department before demolition work begins. The documents shall be professionally certified by the engineer. The approved set of documents shall be kept at the site at all times and be accessible for inspection. At a minimum, the demolition documents shall include the following:

1. Plans, sections, and details of the building or portion thereof to be demolished clearly showing the extent, sequence, and means and methods of demolition.
2. Listing and description of all proposed demolition equipment, other than hand held devices, to be used in demolition, including the scope of equipment work and positioning of equipment on the existing structure. Description of equipment shall include calculations showing adequacy of the existing structure to support loads imposed by such equipment. If more than one piece of demolition



equipment is proposed to be used at the same time, the effect of the simultaneous loads imposed on the existing structure shall be described and investigated.

3. Bracing and shoring necessary to support all demolition operations and equipment through all sequences of full or partial demolition.
4. Description of compliance with the provisions of Section 3306.9.

**3306.5.1 Partial Demolition operations.** The registered design professional of record shall submit details of the partial demolition operation as part of the construction documents filed for alteration of the building provided:

1. Where mechanical demolition equipment, other than handheld devices, is used, construction documents shall show compliance with all the requirements of Section 3306.5.
2. Where mechanical demolition equipment is not used, the registered design professional shall show at a minimum:
  - 2.1. Plans, sections, and details of the building or portion thereof to be demolished clearly showing the extent, sequence, and means and methods of demolition.
  - 2.2. Bracing and shoring necessary to support all demolition operations through all sequences of the partial demolition.
  - 2.3. Description of compliance with the applicable provisions of Section 3306.9.

**3306.6 Special inspection.** Where mechanical demolition equipment, other than handheld devices, is to be used in the full or partial demolition of a building from within the building, or is to be used within the building to remove debris or move material, such demolition operation shall be subject to special inspection in accordance with the provisions of Chapter 17. The special inspector shall visit the site a minimum of three times: before demolition operations start, during demolition, and at the conclusion of demolition.

**3306.7 Demolition of weakened structures.** Where a structure to be demolished has been partially wrecked or weakened by fire, flood, explosion, age, or other causes, it shall be shored or braced to the extent necessary to permit orderly full demolition or partial demolition without collapse. The necessary measures to ensure a safe demolition shall be determined by the owner's registered design professional and shall be approved by the commissioner.

**3306.8 Full and partial demolition of structural steel, reinforced concrete, and heavy timber construction.** Steel, reinforced concrete and heavy timber construction shall be

demolished column length-by-column length and tier-by-tier. Any structural member that is being dismembered shall not support any load other than its own weight, and such member shall be chained or lashed in place to prevent any uncontrolled swing or drop.

Structural members shall not be thrown or dropped from the building, but shall be slowly and carefully lowered by hoists equipped with adequate brakes and non-reversing safety devices.

**3306.9 Full demolition and partial demolition operations.** In addition to the requirements of Article 105 of chapter 1 of Title 28 of the *Administrative Code*, the following requirements shall apply to all full demolition and partial demolition operations.

**3306.9.1 Utilities and service lines.** Service utility connections shall be discontinued and capped, and certifications to that effect issued by the representative utility company shall be filed with the department.

**Exception.** Partial demolition operations.

**3306.9.2 Party wall exits, fire exits.** No party wall balcony or horizontal fire exit shall be demolished, removed, or obstructed in any manner that would destroy the full effectiveness of such fire exit as a means of egress, unless a substitute means of egress meeting the requirements of Chapter 10 has been provided.

**3306.9.3 Dust.** Dust producing operations shall be wetted down to the extent necessary to control the dust.

**3306.9.4 Water accumulation.** Provision shall be made to prevent the accumulation of water or water damage to any foundations on the premises or to the adjoining property.

**3306.9.5 Temporary elevators and standpipe systems.** See Sections 3303.8 and 3303.12 for requirements.

**3306.9.6 Sprinkler systems.** When existing sprinkler systems with siamese hose connections are present in structures undergoing full or partial demolition, such systems shall be maintained as a non-automatic sprinkler system. When demolition starts, the sprinkler risers shall be capped immediately below the floor being demolished so as to maintain the sprinkler system on all lower floors for Fire Department use. Siamese hose connections shall be kept free from obstruction and shall be marked by a metal sign reading "Sprinkler Siamese Connection" and by a red light at night.

**3306.9.7 Use of explosives.** The use of explosives in demolition operations shall conform to the requirements and limitations imposed by the *New York City Fire Code* and Section 3312.

**3306.9.8 Hazards to be removed.** Hazards shall be removed in accordance with the following requirements:

1. Before commencement of actual demolition, all glass in windows, doors, skylights, and fixtures shall be removed.
2. In any structure more than 25 feet high (7620 mm), any window or other exterior wall opening that is within 20 feet (6096 mm) of a floor opening used for the passage of debris from floors above shall be solidly boarded up or otherwise substantially covered, unless such window or opening is so located as to preclude the possibility of any person being injured by material that may fall from such window or opening.
3. Before demolition is started, the cellar and all floors shall be thoroughly cleaned of combustible materials and debris. All fixtures and equipment that would cause voids in the fill shall be removed. If the cellar is to be filled to grade, the first floor construction shall be removed and the existing cellar floor shall be broken up to the extent necessary to provide ground drainage and prevent accumulation of water. If the cellar is not to be filled, positive cellar drainage shall be provided.
4. All asbestos shall be removed and certifications to that effect shall be filed with the department and the Department of Environmental Protection.

**3306.9.9 Walls.** Demolition of walls and partitions shall comply with the following requirements:

1. Demolition of walls and partitions shall proceed in a systematic manner, and all work above each tier of floor beams shall be completed before any of the supporting structural members are disturbed.
2. Sections of masonry walls shall not be loosened or permitted to fall in such masses as to affect the carrying capacity of floors or the stability of structural supports.
3. No wall, chimney, or other structural part shall be left in such condition that it may collapse or be toppled by wind, vibration or any other cause.
4. No section of wall with a height more than 22 times its thickness shall be permitted to stand without bracing designed by a registered design professional.
5. Where brick or masonry chimneys cannot be safely toppled or dropped, all materials shall be dropped down on the inside of such chimneys.

6. All enclosed vertical shafts and stairs shall be maintained enclosed at all floors except the uppermost floor being demolished, and all work on the uppermost floor shall be completed before stair and shaft enclosures on the floor below are disturbed. All hand rails and banisters shall be left in place until actual demolition of such floor is in progress.

**3306.9.10 Floors.** No bearing partition shall be removed from any floor until the floor framing system on the floor above has been removed and lowered. All header beams and headers at stair openings and chimneys shall be carefully examined, and where required shall be shored from the cellar floor through successive floors. All operations shall be continually inspected as the work progresses to detect any hazards that may develop.

**3306.9.11 Storage of material.** Material shall not be stored on catch platforms, working platforms, floors, or stairways of any structure, except that any one floor of a building to be demolished may be used for the temporary storage of material when such floor can be evaluated by an engineer and proven to be of adequate strength to support one and one-half times the load to be superimposed. Such evaluation by the engineer shall be maintained by the permit holder and made available to the department upon request.

Storage spaces shall not interfere with access to any stairway or passageway, and suitable barricades shall be provided so as to prevent material from sliding or rebounding into any space accessible to the public. All material shall be safely piled in such storage locations in a manner that will not overload any part of the structure or create any hazard.

**3306.9.11.1 Examination.** Before any material is stored on any floor, the existing flooring adjacent to bearing walls, shear walls, beams and columns shall be removed and the connections of the floor framing system to the bearing walls, shear walls, beams and columns shall be carefully examined by a competent person to ascertain their condition and adequacy to support such material. If the connections are found to be in poor condition or inadequate to support the stored material, no material shall be deposited on the floor until these connections are shored from the cellar floor through each successive floor or otherwise strengthened to safely support such material.

**3306.9.11.2 Removal of floor slabs for storage.** In buildings of noncombustible construction, floor slabs to an elevation of not more than 25 feet (7620 mm) above the legally established curb level may be removed to provide temporary storage for debris, provided that:

1. The stored debris is piled with sufficient uniformity to prevent lateral displacement of interior walls or columns as determined by a registered design professional.

2. The height of the piled material will not burst the exterior walls due to horizontal loading as determined by a registered design professional.
3. The operation does not otherwise endanger the stability of the structure.

**3306.9.11.3 Cellar storage.** Debris stored in the cellar shall not be piled above the level of the adjacent exterior grade unless the contractor provides sheet-piling, shoring, bracing, or such other means necessary to insure the stability of the walls and to prevent any wall from collapsing due to horizontal loading created by the debris as determined by a registered design professional.

**3306.9.12 Removal of material.** Debris, bricks, and similar material shall be removed through openings in the floors of the structure, or by means of chutes, buckets, or hoists that comply with the provisions of this chapter. Openings in any floor shall not aggregate more than 25 percent of the area of that floor unless it can be shown by submission from a registered design professional to the satisfaction of the commissioner that larger openings will not impair the stability of the structure.

Every opening used for the removal of debris in every floor, except the top or working floor, shall be provided with a tight enclosure from floor to floor, equivalent to that afforded by planking not less than 2 inches (51 mm) in thickness. As an alternative, in buildings not more than 6 stories in height, such openings may be protected by a tight temporary covering equivalent to that afforded by planks not less than 2 inches (51 mm) in thickness and laid close. Wherever such covering has been temporarily removed to permit debris removal, floor openings shall be protected by standard guardrails that meet the requirements of Section 3307.8. Such covering shall be promptly replaced in position upon the ceasing of such work at the end of each workday.

Every opening not used for the removal of debris in any floor shall be solidly planked over.

**3306.9.13 Rodent extermination.** A licensed exterminator shall effectively treat the premises for rodent extermination as per the requirements of the Department of Health and Mental Hygiene.

**Exception.** Partial demolition operations.

**3306.10 Completion of Demolition Operations.** All work required for structural stability and permanent waterproofing of adjacent buildings must be completed prior to demolition sign-off.

At the completion of demolition operations, unless new construction is to follow within a period of three months, the site shall be graded, drained, or otherwise protected as provided in Section 3303.13.

**SECTION BC 3307**  
**PROTECTION OF PEDESTRIANS**

**3307.1 Protection required.** Pedestrians shall be protected during construction, alteration, remodeling, or demolition activities as required by this section and the rules of the Department of Transportation. Signs shall be provided to direct pedestrian traffic.

**3307.1.1 Signs.** Other than as specified in Section 3301.10, there shall be no information, pictorial representation, or any business or advertising messages posted on a sidewalk shed, bridge, fence, or other structure listed in this section that is erected at the construction or demolition site.

Where a protective structure required by this section obscures from view a lawful existing sign, a temporary sign may be installed in accordance with Section 3301.10.

No illuminated signs shall be permitted on any protective structure required by this section.

**3307.2 Sidewalks and walkways.** A sidewalk, walkway, or temporary walkway shall be provided for pedestrian travel in front of every construction or demolition site unless the Department of Transportation authorizes the sidewalk to be fenced or closed.

**3307.2.1 Temporary walkways.** Temporary walkways shall be of sufficient width to accommodate the pedestrian traffic, but in no case shall it be less than 5 feet (1524 mm) in width, and shall be provided with a durable walking surface.

All temporary walkways shall be illuminated at all times either by natural or artificial light. The level of illumination shall be the equivalent of that produced by 200 watt, 3400 lumen minimum, standard incandescent lamps enclosed in vandal-proof fixtures and spaced 15 feet (4572 mm) apart and 8 feet (2438 mm) above the floor level. Artificial lighting units shall be inspected nightly; and burned out or inoperative units shall be replaced or repaired immediately.

Temporary walkways shall be provided with adequate slopes so that they are accessible and shall be designed to support all imposed loads, and in no case shall the design live load be less than 150 pounds per square foot (732.3 kg/m<sup>2</sup>).

Where permission has been granted by the Department of Transportation to locate a temporary walkway beyond the curb line, such temporary walkway shall be provided with a guardrail in accordance with the Department of Transportation's requirements.

**3307.2.2 Foot bridges.** Foot bridges shall be of sufficient width to accommodate the pedestrian traffic, but in no case shall it be less than 5 feet (1524 mm) in width, and shall be provided with a durable walking surface.

All foot bridges shall be illuminated at all times either by natural or artificial light. The level of illumination shall be the equivalent of that produced by 200 watt, 3400 lumen minimum, standard incandescent lamps enclosed in vandal-proof fixtures and spaced 15 feet (4572 mm) apart and 8 feet (2438 mm) above the floor level. Artificial lighting units shall be inspected nightly; and burned out or inoperative units shall be replaced or repaired immediately.

Foot bridges shall be provided with adequate slopes so that they are accessible and shall be designed to support all imposed loads and in no case shall the design live load be less than 150 pounds per square foot (732.3 kg/m<sup>2</sup>). The walkway on such bridge shall be provided with guardrails for its entire length and shall have cleats to prevent slipping. Where planks are used to pave the walkway, they shall be laid close and securely fastened to prevent displacement. Planks shall be of uniform thickness, and all exposed ends on ramps shall be provided with beveled fillers to eliminate tripping hazards.

**3307.3 Protection of sidewalks, walkways and temporary walkways.** Unless the street is officially closed to the public during construction or demolition operations pursuant to a permit from the Department of Transportation, the following minimum safeguards shall be provided for the protection of the public.

**Exception.** Partial demolition operations limited to the interior components of the building.

**3307.3.1 Sidewalk shed.** A sidewalk shed that meets the requirements of Section 3307.6 shall be erected as follows:

1. When a structure higher than 40 feet (12 192 mm) is to be constructed and the horizontal distance from the top of the structure to the inside edge of the sidewalk, walkway or temporary walkway is equal to one-half or less of the height of the structure.
2. When a structure higher than 25 feet (7620 mm) is to be demolished and the horizontal distance from the top of the structure to the inside edge of the sidewalk, walkway or temporary walkway is equal to one-half or less of the height of the structure, or when a structure 25 feet (7620 mm) or less is to be demolished and a sidewalk shed is required by the commissioner as part of a safety zone per Section 3306.2.1.
3. When, regardless of the height of the structure or the horizontal distance between the structure and the sidewalk, walkway or temporary walkway, material or debris is to be moved by a hoist, crane, derrick, or chute over a sidewalk, walkway or temporary walkway that is not closed to the public.
4. When a portion of a facade over 40 feet (12 192 mm) above curb level is being altered or repaired and the horizontal distance from the portion of the

structure being altered or repaired to the inside edge of the sidewalk, walkway or temporary walkway is less than one-half the height of the structure being altered or repaired.

**Exception:** Access to walkways that are not under the jurisdiction of the Department of Transportation, and that are located in an area that is within a distance equal to or less than half the height of the highest work area, may be closed off by the authority having jurisdiction in lieu of providing a sidewalk shed provided the walkway is not required as part of the means of ingress or egress for a building.

**3307.3.2 Fence.** All new construction or demolition sites, regardless of the height of the building to be constructed or demolished, shall be enclosed with a fence that meets the requirements of Section 3307.7.

A fence may be used in lieu of a sidewalk shed when a structure higher than 40 feet (12 192 mm) is to be constructed, or a structure higher than 25 feet (7620 mm) is to be demolished, and the horizontal distance from the structure being built or demolished to the inside edge of the sidewalk, walkway or temporary walkway is between one-half and three-quarters of the height of the structure.

**3307.3.3 Guardrail.** For cases that do not fall within the circumstances described in Sections 3307.3.1 and 3307.3.2, a standard guardrail that meets the requirements of Section 3307.8 may be constructed along the inside edge of the sidewalk, walkway or temporary walkway. The rail shall be returned at its ends to the extent necessary to effectively close off the site.

If permission to close the sidewalk has been obtained from the Department of Transportation, the railing may be constructed along the curb or outside of the curb to such extent as approved by the Department of Transportation.

**3307.3.4 Openings.** Openings in sidewalk sheds, fences, barriers, and railings for loading and unloading purposes shall be kept closed at all times except during actual loading and unloading operations.

**3307.4 Warning signs and lights.** Warning signs and lights shall be installed to protect the public from the hazards of construction or demolition sites in accordance with Sections 3307.4.1 to 3307.4.3.

**3307.4.1 Obstructions and openings.** Where a material pile or other obstruction, or an excavation, opening, or other hazard is located in or adjacent to a public way, such hazard shall be indicated by red flags or signs during daylight hours, and by red lanterns, red lights, oil flares, flashing beacons, lighted signs, or equivalent devices from sunset to sunrise. Such warning devices shall be located no more than 30 feet (9144 mm) apart.



**3307.4.2 Dangerous areas.** In areas where special danger to the public exists, such as at vehicle entrances and exits, hoisting areas, points of storage of explosives or highly flammable material, or discharge ends of chutes, descriptive warning signs shall be provided. Such warning signs shall contain the word “DANGER” in prominent letters and, where in, or adjacent to, a public way, shall be illuminated from sunset to sunrise. Barricades and/or designated personnel shall be provided to the extent necessary to keep the public away from such areas or to guide them around the areas.

**3307.4.3 Vehicular traffic.** Whenever any work is being performed over, on, or in close proximity to a highway, street, or similar public way, control and protection of traffic shall be provided by barricades, signals, signs, flagperson, or other devices, equipment, and personnel in accordance with the requirements of the Department of Transportation.

### **3307.5 Watchperson and flagperson.**

**3307.5.1 Watchperson.** Where a building being constructed or demolished occupies a ground area between 5,000 square feet (1524 m<sup>2</sup>), and 40,000 square feet (12 192 m<sup>2</sup>), a competent watchperson shall be on duty at the site during all hours when operations are not in progress. Where the construction or demolition area occupies a ground area of more than 40,000 square feet (12 192 m<sup>2</sup>), at least one additional watchperson shall be on duty for each additional 40,000 square feet (12 192 m<sup>2</sup>) of construction or demolition area, or fraction thereof. The watchperson shall be familiar with the location of street fire alarm boxes and the location and use of fire fighting equipment on the job site.

**3307.5.2 Flagperson.** A flagperson shall be provided whenever intermittent operations are conducted on, or adjacent to, areas open to use by persons other than workers, or when dangerous operations, such as blasting, may affect such areas.

**3307.6 Sidewalk sheds.** Sidewalk sheds shall be erected when required by Section 3307.3.1. No sidewalk shed shall be erected without a permit in accordance with the requirements of Chapter 1 of Title 28. Following the receipt of a permit to erect a sidewalk shed, the permit holder shall post a sign on the sidewalk shed that meets the requirements of Section 3301.9.5.

Every sidewalk shed deck shall be designed and constructed as a heavy duty sidewalk shed to carry a live load of at least 300 pounds per square foot (1464.6 kg/m<sup>2</sup>). However, a light duty sidewalk shed constructed to carry a live load of 150 pounds per square (732.3 kg/m<sup>2</sup>) foot may be used when the building to be constructed, altered, or demolished is less than 100 feet (30 480 mm) in height.

**Exception:** Sidewalk sheds that provide a base for a scaffold or contractor’s shed shall be designed by an engineer to have a live load capable of supporting the scaffold or contractor’s shed plus an additional 200 pounds per square foot (976.4 kg/m<sup>2</sup>). No storage is allowed on sidewalk sheds that support scaffolds or contractor sheds unless

the sidewalk shed has been designed to have a live load capable of supporting the scaffold or contractor's shed, the total storage load, and an additional 200 pounds per square foot (976.4 kg/m<sup>2</sup>). The ground where the shed is to be constructed shall be examined by an engineer to determine it is capable of supporting the total load.

**3307.6.1 Sidewalk shed required.** When a sidewalk shed is required for the construction or alteration of a structure, the work shall stop at a height of 40 feet (12 192 mm) unless, and until, the sidewalk shed has been completed. Such shed shall remain in place until the structure is enclosed, all exterior work completed and the sash is glazed above the second story, the exterior of the facade is cleaned down, and until completion of all outside handling of material, equipment and machinery, and all dismantling of material hoists, or climber or tower cranes including the use of a derrick in their removal, above the second story.

When a sidewalk shed is required for the demolition of a structure, the sidewalk shed shall be completed before any demolition work is performed. Such shed shall remain in place until the structure has been razed to the height of the shed.

**3307.6.2 Areas to be protected.** Protection shall be provided for those sidewalks or walkways that are in front of the building to be constructed, altered, or demolished. Sidewalks or walkways in a plaza or other similar space that lead from the street to an entrance or exit into or out of the building that cannot be officially closed shall be similarly protected.

Where deemed necessary by the commissioner, the deck shall cover the entire width of the sidewalk or walkway in front of the building, except for reasonably small clearances at the building line and the curb. In all other instances, the sidewalk shed shall protect the sidewalk or walkway to a minimum 5 foot (1524 mm) width. Sidewalk sheds may extend beyond the curb to such extent as may be approved by the Department of Transportation pursuant to a permit from such department.

Unless constructed solely to comply with Section 3307.3.1, item 3, sidewalk sheds shall extend 5 feet (1524 mm) past the building when the building is less than 100 feet (30 480 mm) in height, and 20 feet (6096 mm) past the building when the building is over 100 feet (30 480 mm) in height, regardless of whether such extensions are in front of the property being developed or in front of adjacent property. Extensions of sidewalk sheds complying with the foregoing shall be constructed so as not to unreasonably obstruct, either visually or physically, entrances, egress, driveways, and show windows of adjacent properties.

**3307.6.3 Design of sidewalk sheds.** All sidewalk sheds shall be designed by an engineer.

**Exception:** Sidewalk sheds that follow a standard design approved by the department or the Board of Standards and Appeals.

**3307.6.4 Construction of sidewalk sheds.** Sidewalk sheds shall be constructed in accordance with the following:

1. Sidewalk sheds shall be constructed out of wood, steel, or other materials having equivalent strength and suitability.
2. The members of the sidewalk shed shall be adequately braced and connected to prevent displacement or distortion of the framework. Where posts supporting the shed deck are placed beyond the curb, such posts shall be protected against displacement by vehicles as directed by the Department of Transportation. Such placement shall require a permit from the Department of Transportation.
3. The upright members of the sidewalk shed shall be plumb. The tolerance is L/100. L is measured as the distance from the ground to the first x-brace or bottom of the beam.
4. The deck of the sidewalk shed shall consist of planking closely laid, and made tight.
5. Unless the top deck of the sidewalk shed is built solidly against the face of the structure in such a manner that no material can fall onto the sidewalk, the side of the shed toward the structure shall be solidly sealed with wood or other suitable material for the full height of the shed. Solid sliding or in swinging gates may be provided as necessary for the proper prosecution of the work.
6. The outer side and ends of the deck of the shed shall be provided with a substantial enclosure at least 3 feet 6 inches (1067 mm) high. Such enclosure may be vertical or inclined outward at approximately 45 degrees, and shall consist of boards laid close together and secured to braced uprights, of galvanized wire screen not less than no. 16 steel wire gage with a ½ inch (13 mm) mesh, of corrugated metal, or of solid plywood. Temporary removal of portions of the enclosure shall be permitted for handling material.
7. All sidewalk sheds shall provide protection for the full width of the shed extending upward at an angle of 45 degrees from the ends of the deck and outward a horizontal distance of at least 5 feet (1524 mm) beyond the ends of the shed. Such sloping end protection shall be constructed to meet the requirements of numbered items two and three with substantial outriggers bearing on and securely attached to the deck.
8. The passageway under the shed shall have a minimum clear ceiling height of 8 feet (2438 mm).

**3307.6.5 Use and maintenance of sidewalk sheds.** The use of sidewalk sheds shall be in accordance with the following:

1. Material and debris shall not be stored on sidewalk sheds unless the shed has been so designed for storage in accordance with rules promulgated by the commissioner.
2. The underside of sidewalk sheds shall be lighted at all times either by natural or artificial light. The level of illumination shall be the equivalent of that produced by 200 watt, 3400 lumen minimum, standard incandescent lamps enclosed in vandal-proof fixtures and spaced 15 feet (4572 mm) apart and 8 feet (2438 mm) above the floor level. Artificial lighting units shall be inspected nightly; and burned out or inoperative units shall be replaced or repaired immediately.

**3307.7 Fences.** When required by this code, fences shall be at least 8 feet (2438 mm) high, and constructed of wood or other suitable material. They shall be built solid for their entire length, except for openings with solid sliding or in swinging gates as are required for the proper prosecution of the work, and for viewing panels, which shall be blocked with plexiglass or equivalent nonfrangible material.

The fence shall be constructed along the inside edge of the sidewalk, walkway or temporary walkway. If permission to close the sidewalk has been obtained from the Department of Transportation, such fence may be erected along the curb or outside of the curb to such extent as approved by the Department of Transportation. The fence shall be returned at its ends to the extent necessary to effectively close off the site.

**3307.8 Standard guardrail.** A standard guardrail shall consist of a 2 inch by 4 inch (51 by 102 mm) wood top rail or equivalent capable of withstanding, without failure, a force applied in any downward or horizontal direction at any point along its top edge of at least 200 pounds (90.7 kg). The guardrail shall be not less than 3 feet (914 mm) nor more than 3 feet 6 inches (1067 mm) above the platform and there shall be a 1 inch by 4 inch (25 by 102 mm) wood intermediate rail midway between the top rail and the floor or standard toeboard, both supported by 2 inch by 4 inch (51 by 102 mm) wood posts spaced not more than 8 feet (2438 mm) apart.

To provide necessary openings for intermittent operations one or more sections of a required railing may be hinged or supported in sockets. When supported in sockets, rails shall be so constructed that they cannot be jolted out. A button or hook may be used to hold the rail in a fixed position. Substantial chains or ropes may be used to guard such openings in standard railings. Where so used, the chains or ropes shall be taut at the same height as the rails of the standard railing.

In lieu of wood construction, posts and rails may be constructed of at least 1¼ inch (32 mm) diameter standard pipe of at least 2 inch by 2¼ inch (51 by 57 mm) angles. Spacing of rails and posts shall be as required above

**3307.8.1 Standard toeboard.** Where a toeboard is required, it shall be at least 5½ inches (140 mm) high and constructed of metal, wood, or other substantial material. It shall be installed along the edge of the floor, opening, platform, ramp, or runway. Such standard toeboard shall be securely fastened to the posts and installed so that no open space exists between the floor and the standard toeboard.

**3307.9 Safety netting.** Safety netting shall be provided as required by Section 3308.

**3307.10 Repair, maintenance and removal.** Pedestrian protection required by this chapter or by the Department of Transportation shall be maintained in place and kept in good order for the entire length of time pedestrians may be endangered. The owner or the owner's agent, upon the completion of the construction or demolition activity, shall immediately remove sidewalk sheds, fences, guard rails, temporary walkways, debris and other obstructions and leave such public property in as good a condition as it was before such work was commenced.

In the event the Department of Transportation must repair, maintain, or install intersection control signs or electrical equipment, including traffic signals or street lighting poles at a location where pedestrian protection required by this chapter is located, such pedestrian protection shall be removed as directed by the department of buildings as long as the removal is deemed to be safe and, if necessary, suitable appropriate pedestrian protection that does not interfere with the work of the Department of Transportation is installed.

## **SECTION BC 3308** **SAFETY NETTING**

**3308.1 Safety netting during construction or demolition operations.** Horizontal and vertical safety netting shall be provided when required below. Safety netting is required in addition to the sidewalk sheds, fences, and other pedestrian protection required by Section 3307.

**Exception:** A supported scaffold may be used in lieu of horizontal safety netting provided the bottom, outer faces and ends of the scaffold are enclosed with debris netting or its equivalent so as to prevent the falling of material and debris.

**3308.1.1 Vertical netting.** When in the course of construction the building reaches a height of 4 stories or 40 feet (12 192 mm), vertical safety netting shall be maintained at each story except at the story at grade, the story immediately above the sidewalk shed and the roof level where a parapet is installed.

**3308.1.2 Horizontal netting during exterior wall construction.** When exterior walls are being constructed, altered or repaired at a height greater than 6 stories or 75 feet (22 860 mm), horizontal safety netting shall be provided on the sides of the structure where the structure is not enclosed. A structure shall be considered to be enclosed when the permanent facade is completed except for the windows. Such

windows shall be protected to a height specified in Section 3308.3 unless there is a sill not less than 2 feet 6 inches (762 mm) in height and vertical mullions or piers with a maximum opening of 5 feet (1524 mm) and a non-corrosive wire cable capable of withstanding a load of at least 200 pounds (90.7 kg) applied in any direction except upward.

**3308.1.3 Horizontal netting during new construction and structural additions.** When during the course of construction the building reaches a height of 6 stories or 75 feet (22 860 mm), horizontal safety netting shall be maintained at a level not more than two stories or 30 feet (9144 mm) below the stripping operation on concrete structures or the uppermost finished (and walkable) concrete floor on steel frame structures. The horizontal safety netting may be removed after the formwork for the topmost level of concrete is removed or after the topmost level of concrete for a steel building is poured.

**3308.1.4 Horizontal netting during demolition.** When demolition of the exterior walls or the roof of a structure occurs at a height greater than 6 stories or 75 feet (22 860 mm), horizontal safety netting shall be provided. The horizontal safety netting shall be constructed and maintained not more than two stories or 30 feet (9144 mm) below the story from which the exterior walls and roof are being removed until the demolition has progressed to within six stories or 75 feet (22 860 mm) off the ground or adjoining roof level

**3308.1.5 Horizontal netting and tarpaulins.** When tarpaulins encase one or more floors immediately below the finished concrete floor in order to maintain temporary heat, the horizontal nets may be located no more than three floors below the finished concrete floor.

**3308.1.6 Designated crane and derrick lifting areas.** Required horizontal safety netting may be omitted in designated crane and derrick lifting areas so long as such lifting area is as indicated on the crane application and on the site safety program.

**3308.2 Horizontal safety netting requirements.** Horizontal safety netting shall consist of a horizontal system of nets and their supports that meet requirements set forth in department rules, and shall include a structural net lined with a debris net of a size and strength sufficient to catch falling tools and materials.

Horizontal safety netting shall project outward horizontally from the edge of the floor a minimum distance of 10 feet (3048 mm).

**3308.3 Vertical safety netting requirements.** Vertical safety netting shall consist of a vertical system of nets and their supports that meet requirements set forth in department rules. Vertical safety netting shall be of a fine mesh of a size and strength sufficient to contain falling tools and materials. Wall opening screens, grills or tarpaulins may be used in lieu of vertical safety netting, provided that they shall be of such construction and mounting as to retain debris.

On every story where vertical safety netting is required, it shall extend from the floor to a height of not less than 60 inches (1524 mm). Vertical safety nets and their components shall also meet the requirements set forth in rules promulgated by the commissioner.

**3308.4 Responsibility.** The holder of the work permit and his or her designee shall be responsible for the installation and maintenance of all horizontal and vertical netting, and for complying with the requirements of this section.

**3308.5 Appeals.** Where requests are made regarding interpretations, consultations, and reconsiderations of safety netting, the commissioner may, in specific cases, modify these regulations where proper methods are proposed to be employed.

Any appeal shall state the specific relief requested and shall make reference to the Site Safety Program, where applicable, the practical difficulty, proposed equivalencies consistent with public safety, and any stipulations.

## **SECTION BC 3309** **PROTECTION OF ADJOINING PROPERTY**

**3309.1 Protection required.** Adjoining public and private property shall be protected from damage during construction or demolition work. Protection must be provided for footings, foundations, party walls, chimneys, skylights and roofs. Provisions shall be made to control water run-off and erosion during construction or demolition activities.

**3309.2 License to enter adjoining property.** The responsibility of affording any license to enter adjoining property shall rest upon the owner of the adjoining property involved; and in case any tenant of such owner fails or refuses to permit the owner to afford such license, such failure or refusal shall be a cause for the owner to dispossess such tenant through appropriate legal proceedings for recovering possession of real property.

**3309.3 Physical examination.** When permission to enter upon adjoining property has been obtained, a physical examination of such property shall be conducted by the person causing the construction or demolition operations prior to the commencement of the operations and at reasonable periods during the progress of the work. Observed conditions shall be recorded by the person causing the construction or demolition operations, and such records shall be made available to the department upon request.

**3309.4 Excavation or filling operations affecting adjoining property.** Regardless of the excavation or fill depth, the person who causes an excavation or fill to be made shall, at all times and at his or her own expense, preserve and protect from damage any adjoining structures, provided such person is afforded a license in accordance with the requirements of Section 3309.2 to enter and inspect the adjoining buildings and property, and to perform such work thereon as may be necessary for such purpose. If the person who causes the excavation or fill is not afforded a license, such duty to preserve and

protect the adjacent property shall devolve to the owner of such adjoining property, who shall be afforded a similar license with respect to the property where the excavation is to be made.

No excavation work to a depth of 5 to 10 feet (1524 mm to 3048 mm) within 10 feet (3048 mm) of an adjacent building, or an excavation over 10 feet (3048 mm) anywhere on the site shall commence until the person causing an excavation to be made has documented the existing conditions of all adjacent buildings in a pre-construction survey.

**3309.4.1 Additional safeguards during excavation.** The following additional requirements shall apply during excavation:

1. The person causing the excavation shall support the vertical load of the adjoining structure by proper foundations, underpinning, or other equivalent means where the level of the foundations of the adjoining structure is at or above the level of the bottom of the new excavation.
2. Where the existing adjoining structure is below the level of the new construction or demolition, provision shall be made to support any increased vertical or lateral load on the existing adjoining structure caused by the new construction or demolition.
3. Where the new construction or demolition will result in a decrease in the frost protection for an existing foundation below the minimums established in Section 1805.2.1, the existing foundation shall be modified as necessary to restore the required frost protection.

**3309.4.2 Support of party walls.** Where a party wall will be affected by excavation, regardless of the depth, the person who causes the excavation to be made shall preserve such party wall at his or her own expense so that it shall be, and shall remain, in a safe condition. Where an adjoining party wall is intended to be used by the person causing an excavation to be made, and such party wall is in good condition and sufficient for the uses of the existing and proposed buildings, it shall be the duty of such person to protect such party wall and support it by proper foundations, so that it shall be and remain practically as safe as it was before the excavation was commenced.

**3309.5 Underpinning.** Whenever underpinning is required to preserve and protect an adjacent property from construction or excavation work, the person who causes the construction or excavation work shall, at his or her own expense, underpin the adjacent building provided such person is afforded a license in accordance with the requirements of Section 3309.2 to enter and inspect the adjoining buildings and property, and to perform such work thereon as may be necessary for such purpose. If the person who causes the construction or excavation is not afforded a license, such duty to preserve and protect the adjacent property shall devolve to the owner of the adjoining property, who



shall be afforded a similar license with respect to the property where the excavation is to be made.

**3309.6 Foundation operations affecting adjacent properties.** Whenever subsurface operations are conducted that may impose loads or movements on adjoining property, such as driving of piles, compaction of soils, or soil solidification, the effects of such operations on adjoining property and structures shall be monitored .

Where placement of a foundation will cause changes in the ground water level under adjacent buildings, the effects of such changes on the stability and settlement of the adjacent foundations shall be investigated and provision shall be made to prevent damage to such buildings.

When, in the opinion of the commissioner, a potential hazard exists, elevations of the adjacent buildings shall be recorded by a registered design professional at intervals of 24 hours or less as determined by the commissioner to ascertain if movement has occurred.

**3309.7 Retaining Structures.** When the regulation of a lot requires the ground on such lot to be raised or lowered and kept higher than the ground of the adjoining lot, provided the ground of such adjoining lot is not maintained at a grade lower than in conformity with the street or streets on which it is situated, or where an excavation has been made or a fill placed on any lot meeting the curb level requirements, and the adjoining land is maintained at a grade in conformity with or lower than the streets or streets on which it is situated, and is without permanent structures other than frame sheds or similar structures, a retaining structure shall be constructed for the safe support of adjoining ground, unless the bank between the adjoining properties is maintained at a safe angle of repose. Any necessary retaining wall shall be built and maintained jointly by the owners on each side, unless otherwise agreed to by both owners.

**3309.7.1 Surplus Retaining Structures.** Where any owner maintains his or her ground either higher or lower than the legal regulation prescribed in the *Administrative Code*, the surplus retaining structure that may be necessary to support such height or provide for such excavation shall be made at the sole expense of such owner, and any additional thickness that may be required shall be built on the land of such owner.

**3309.7.2 Removal of Retaining Structures.** Any retaining structure erected as provided above, standing partly on the land of each owner, may be removed by either owner when the original reason for the erection of such retaining structure ceases to exist.

**3309.8 Adjoining walls.** When any construction or demolition operation exposes or breaches an adjoining wall, including load bearing and non load-bearing walls as well as party walls and non party walls, the person causing the construction or demolition operation shall, at his or her own expense, perform the following:

1. Maintain the structural integrity of such walls, have a registered design professional investigate the stability and condition of the wall, and take all necessary steps to protect such wall.
2. Maintain all required fire exits and passageways or provide substitutions meeting the requirements of this code.
3. Cut off close to the walls all beams in party walls, remove stub ends without weakening existing masonry, clean beam pockets of loose mortar, bend over all wall anchors at the beam ends in the standing wall, and brick-up all open beam holes with sound brick and cement mortar.
4. During demolition operations, where the floor beams of the adjacent building bear on the party wall, the person causing the demolition shall ascertain that such beams are anchored into the wall and, where such anchorage is lacking, shall provide anchorage or otherwise brace the standing wall.
5. During demolition operations, all non load-bearing chimney breasts, projections and any other debris exposed on party walls shall be examined and monitored by the person causing the demolition. Removal of such items shall be made under the supervision of a registered design professional only if the stability of the adjacent building or structure will not be affected. All openings shall be bricked up flush on the exterior side of the party wall. All masonry that is in poor condition shall be pointed and patched.

**3309.9 Weatherproof integrity of adjoining buildings.** Where the waterproof integrity of an adjoining wall or building has been impaired due to construction or demolition operations, the person causing the construction or demolition operations shall, at his or her own expense, provide all necessary measures to permanently waterproof the adjoining wall or building in order to restore the weatherproof integrity of such adjoining wall or building. This shall include, but is not limited to:

1. Bending over and flashing all roofing material of adjoining buildings;
2. Sealing and permanently waterproofing all doors or other openings in party walls;
3. Properly sealing all cornices, where cut;
4. Pointing up and making waterproof any walls and parapets and any walls that have been disturbed;
5. Removing all exposed furring, lath, and plaster on party walls; and
6. Removing, replacing, and firmly anchoring any loose wall material.

**3309.10 Protection of roofs, skylights, chimneys, etc.** Whenever any building is to be constructed or demolished above the roof of an adjoining building, it shall be the duty of the person causing such building to be constructed or demolished to protect the roof, skylights and other roof outlets of the adjoining building from damage, and to use every reasonable means to avoid interference with the use of the adjoining building during the course of construction or demolition. Such person shall be afforded a license in accordance with the requirements of Section 3309.2 to enter and inspect the adjoining building and perform such work thereon as may be necessary for such purpose; otherwise, the duty of protecting the roof, skylights and other roof outlets of the adjoining building shall devolve upon the owner of such adjoining building.

In addition, any person having the duty to alter or maintain chimneys of any adjoining building under and pursuant to the provisions of this code or the *New York City Mechanical Code* or other applicable laws and rules, shall likewise be afforded a license in accordance with the requirements of Section 3309.2 to enter and inspect such adjoining building and perform such work thereon as may be necessary for such purpose; otherwise, such duty shall devolve upon the owner of such adjoining building.

**3309.11 Protection of trees.** No trees outside the property line within the public right of way shall be disturbed or removed without the permission of the commissioner of the department of parks and recreation. Protection meeting the requirements of the department of parks and recreation shall be provided around the trunks of all such trees, and written notification shall also be made to the department of parks and recreation at least 48 hours prior to commencement of such work. No deleterious, caustic, or acid materials shall be dumped or mixed within 10 feet (3048 mm) of any such tree, nor shall salt for the removal of ice or snow be applied when runoff will drain to a tree.

## **SECTION BC 3310** **REQUIREMENTS FOR THE CONSTRUCTION OR DEMOLITION** **OF MAJOR BUILDINGS**

**3310.1 Scope.** This section outlines the requirements for site safety programs for major building construction or demolition that are in addition to the other applicable requirements of this chapter. These requirements are not intended to supersede other applicable city, state or federal requirements that address site safety and construction or demolition activity.

**3310.2 Major buildings.** A major building is a building proposed to have any of the following characteristics:

1. Be constructed to a height of 10 or more stories;
2. Be constructed to a height of 125 feet (38 100 mm) or more;
3. Have a lot coverage of 100,000 square feet (30 480 m<sup>2</sup>) or more regardless of height; or

4. As designated by the commissioner.

**3310.3 Site safety plan and site safety program required.** No permit shall be issued for the construction or demolition of a major building, or for the alteration of the façade of a major building when a sidewalk shed is required until a site safety plan that meets the requirements of Chapter 1 of Title 28 of the *Administrative Code* has been approved by the department.

**Exceptions:**

1. A site safety plan and site safety program is not required for the alteration of the façade of a major building between 10 and 14 stories in height.
2. A site safety plan and site safety program is not required for partial demolition operations in major buildings where the partial demolition operation is limited to the interior components of the building and where mechanical demolition equipment, other than handheld devices, are not used.

**3310.4 Required signs.** The requirements of Section 3301.9 shall apply.

**3310.5 Requirement for a site safety manager or coordinator.** A site safety manager certified by the department in accordance with the requirements of Chapter 4 of Title 28 of the *Administrative Code* is required for the construction or demolition of a major building, or the alteration of the façade of a major building when a sidewalk shed is required.

**Exceptions:**

1. A site safety coordinator certified by the department in accordance with the requirements of Chapter 4 of Title 28 of the *Administrative Code* may be used instead of a site safety manager for major buildings between 10 and 14 stories or 125 to 200 feet (38 100 to 60 960 mm) in height.
2. A site safety manager or coordinator is not required for the alteration of the façade of a major building between 10 and 14 stories in height.
3. A site safety manager or coordinator is not required for partial demolition operations in major buildings where the partial demolition operation is limited to the interior components of the building and where mechanical demolition equipment, other than handheld devices, are not used.

**3310.6 Designation of site safety manager and site safety coordinator.** It shall be the responsibility of the builder/owner, agent, construction manager, or general contractor (the "Contractor") to designate a site safety manager or coordinator who must be present

on a construction or demolition site when required, and who shall be responsible for all site safety requirements as specified in this chapter.

In the event that an alternate manager or coordinator will be acting as the full-time safety manager or coordinator for a period longer than two weeks, the department must be so notified. Any permanent change of site safety manager or coordinator requires immediate notification of the department. No proposed alternate manager or coordinator shall have as his or her primary duty the job of site safety manager or coordinator on any other construction or demolition project.

**3310.7 Contractor's responsibility.** The contractor shall notify all of its supervisory personnel and all of its subcontractors working on the construction or demolition site of the name and responsibilities of the site safety manager or coordinator. The contractor shall state to its directly employed personnel and also to its subcontractors that the site safety manager or coordinator is responsible for monitoring compliance with laws and rules governing site safety, and that they are required to obey and implement all orders and directives relating to safety requirements.

In the event the site safety manager or coordinator discovers violation of the site safety regulations, he or she shall immediately notify the person or persons responsible for creating the violation, whether these persons are employed by the contractor or by subcontractors. If the site safety manager or coordinator is unable to obtain the cooperation of these persons in correcting the violation, he or she shall inform his or her direct supervisor immediately and request that the supervisor order the necessary corrective action. If the supervisor of the site safety manager or coordinator is not present at the site or is otherwise unavailable, the site safety manager or coordinator shall notify any other supervisory personnel of the contractor present on the job or any other responsible manager or officer of the contractor. All such violations and corrective work shall be recorded in the daily log.

### **3310.8 Site safety manager's and coordinator's responsibility.**

**3310.8.1 Monitor compliance.** It is the responsibility of the site safety manager or coordinator to monitor compliance with the safety requirements of this chapter and to perform all other safety duties assigned by the owner or contractor to meet legal requirements.

The site safety manager or coordinator) shall meet on a weekly basis with the designated representative of each subcontractor to ascertain that all subcontractors are complying with the applicable provisions of this chapter.

**3310.8.2 Notification.** The site safety manager or coordinator shall immediately notify the department directly if he or she discovers any of the following conditions in the routine performance of the job:

1. A person is operating a crane, derrick or hoisting equipment on the site without a permit and refuses to desist from operating the equipment;
2. A crane is being operated by an unlicensed operator and such unlicensed operator refuses to desist from operating the crane;
3. No flagperson is present during crane operation where required by this chapter;
4. Sidewalk sheds required by the site safety plan are not in place during construction or demolition activity;
5. Permits have not been issued for the sidewalk sheds;
6. The designer and/or supplier of sidewalk sheds has not certified that the sheds have been erected in accordance with the approved plans; or
7. There has been an accident involving the public, or private or public property.

**3310.8.2.1 Responsibility.** Upon proper notification to the department of the existence of any of the above-noted circumstances, any responsibility the site safety manager or coordinator has under this code arising out of, relating to, or as a result of the existence of that circumstance, shall cease.

**3310.8.3 Inspections.** It shall be the responsibility of the site safety manager or coordinator to inspect personally, on a regular basis, specific areas and items on the construction or demolition site, as prescribed by rules promulgated by the commissioner, and to notify responsible personnel employed by the general contractor, construction manager or any subcontractor when violations of this chapter occur. The site safety manager or coordinator shall maintain a log of the inspection in accordance with the requirements set forth in rules promulgated by the commissioner.

**3310.8.4 Reasonable prudence.** In addition to the above requirements, the site safety manager or coordinator shall use reasonable prudence to ensure that safety is maintained at the job site as job conditions dictate.

## **SECTION BC 3311** **EXPLOSIVE POWERED AND PROJECTILE TOOLS**

**3311.1 Approved.** All explosive powered and projectile tools shall be approved by the commissioner or other approved agency.

### **3311.2 Projectile tools.**

**3311.2.1 Basic requirements.** Design and construction of the tool must be such as to safely retain all internal pressures that may occur during its operation. The discharge

mechanism shall be such that the projectile cannot be discharged by dropping the tool. The discharge mechanism shall be such that the discharge of each projectile shall be dependent on a separate and distinct act by the operator, and all safety features shall be durable.

A tool shall have such other characteristics as the commissioner may find necessary. Such other characteristics may include devices and materials external to the tool itself but associated with its function, and may also include in respect to high velocity projectile tools the basic requirements set forth above for explosive powered tools that discharge projectiles with comparable velocities.

**3311.2.2 Maintenance.** Every projectile tool shall be properly maintained. No such tool shall be used if any part necessary to retain internal pressures or to prevent accidental discharge of a projectile is not in sound and operable condition.

**3311.2.3 Operation.** The operation of projectile tools shall comply with the following:

1. A projectile tool shall be operated only by an authorized operator who shall be the owner, lessee, or other person having custody of the tool, or any other person whom he or she may authorize to operate it.
2. While a projectile tool is in the care and custody of an authorized operator, no other person shall handle or in any way utilize or modify it.
3. No authorized operator of a projectile tool shall leave it unattended while it is in a condition to discharge a projectile.
4. No person shall use a projectile tool for any purpose other than that for which it was manufactured.
5. No person shall point a projectile tool at another person or hold it at an angle that allows the projectile to fly free.
6. No person shall use a projectile tool in such a way as to endanger persons who may be in the vicinity.

**3311.3 Explosive powered tools.** The provisions of ANSI A10.3-1995, as modified in Section 3311.4 shall apply. The storage, handling and use of explosives shall comply with the *New York City Fire Code* and Section 3307.4.2.

**3311.4 Modifications to ANSI A10.3-1995.** The text of ANSI A10.3-1995 shall be modified as indicated in Sections 3311.4.1 through 3311.4.11.

**3311.4.1 ANSI A10.3-1995, Section 4.2.2.** Delete Sections 4.2.2.2, 4.2.2.3 and 4.2.2.4 in their entirety and modify Section 4.2.2.1 to read as follows:

4.2.2.1 Medium-velocity tools, indirect-acting (piston) type, as defined in section 3, shall not be accepted.

**3311.4.2 ANSI A10.3-1995, Section 4.2.3.** Delete Sections 4.2.3.2, 4.2.3.3 and 4.2.3.4 in their entirety and modify Section 4.2.3.1 to read as follows:

4.2.3.1 High velocity tools, direct-acting or indirect-acting type, as defined in section 3, shall not be accepted.

**3311.4.3 ANSI A10.3-1995, Section 5.6.** Add a new section 5.6 to read as follows:

5.6 Selection of load. No employer shall knowingly furnish to an employee for use in a tool any cartridge or load not suitable for safe use in that tool, whether by reason of excessive power, improper design or poor material. The operator shall use due care to select the proper cartridges or power loads, or other means of controlling the force of the explosion so that the tool develops no more than the necessary pressure to bring about the desired penetration. In doing so, the operator shall be guided by the manufacturer's specifications.

5.6.1 Proper Load. When doubt exists as to proper load, the operator shall make a trial shot to test the surface and the strength of the material to be penetrated. The trial shot shall be made with the lowest power level and then increasing strength until a proper fastening is made. During this test, the operator and all bystanders shall adhere to all safety rules including but not limited to wearing goggles and hard hats required for the job.

**3311.4.4 ANSI A10.3-1995, Section 7.11.** Add the following sentence at the beginning of section 7.11:

7.11 The operator shall always verify the thickness and type of material into which the stud, pin or fastener is to be driven.

**3311.4.5 ANSI A10.3-1995, Section 9.4.** Add a new section 9.4 to read as follows:

9.4 Storage of power loads shall be in accordance with the requirements of the *New York City Fire Code* and regulations of the Fire Department.

**3311.4.6 ANSI A10.3-1995, Section 10.3.1.** Add a new section 10.3.1 to read as follows:

10.3.1 The authorized instructors' card shall list the specific model(s) of powder actuated tool(s) for which training may be given.



**3311.4.7 ANSI A10.3-1995, Section 10.6.** Add a new section 10.6 to read as follows:

10.6 All authorized instructors shall hold a Certificate of Fitness issued by the Fire Department.

**3311.4.8 ANSI A10.3-1995, Section 11.4.1.** Add a new section 11.4.1 to read as follows:

11.4.1 The qualified operator's card shall list the specific model(s) of powder actuated tool(s) that may be used.

**3311.4.9 ANSI A10.3-1995, Section 11.6.** Add a new section 11.6 to read as follows:

11.6 All qualified operators shall hold a Certificate of Fitness issued by the Fire Department.

**3311.4.10 ANSI A10.3-1995, Section 12.** Add a new section 12 to read as follows:

12 Equipment Acceptance.

12.1 Powder-actuated tools using ammunition (power loads) shall be approved by the commissioner or other approved agency.

12.2 Labeling. A certificate or label indicating that the tool is approved shall be attached to the toolbox or operator's manual and shall be made available for inspection upon request of the commissioner.

**3311.4.11 ANSI A10.3-1995, Section 13.** Add a new section 13 to read as follows:

13 Fire Department Requirements.

13.1 The requirements of the *New York City Fire Code* and regulations of the Fire Department shall apply.

## **SECTION BC 3312** **EXPLOSIVES AND BLASTING**

**3312.1 General.** All handling, transporting, and use of explosives shall comply with the *New York City Fire Code* and Section 3307.4.2. The use of explosives is strictly prohibited unless the written consent of the commissioner and the Fire Department is obtained.

## **SECTION BC 3313** **FLAMMABLE AND COMBUSTIBLE MIXTURES, COMPRESSED GASES,**

## **AND OTHER HAZARDOUS MATERIALS**

**3313.1 General.** The transportation, handling, storage, installation, connection, ventilation, and use of all volatile flammable oils, flammable and combustible mixtures, compressed gases, and other hazardous materials shall comply with the *New York City Fire Code*, and shall also be safeguarded in accordance with the requirements of Section 3307.4.2.

### **SECTION BC 3314**

#### **SCAFFOLDS**

**3314.1 Scope.** All scaffolds shall be erected and maintained so that the safety of public and property will not be endangered by falling material, tools or debris, or by collapse of the scaffold.

**3314.1.1 Notification of scaffolding accidents.** The permit holder or person directly in charge of any scaffolding equipment shall immediately notify the commissioner following any accident involving scaffolding equipment. Following an incident, no person shall permit either of the following, without the permission of the commissioner:

1. Use of such scaffolding equipment; or
2. Removal of the scaffolding equipment or any part thereof from the area of the job site.

**3314.2 Permit.** Supported scaffolds 40 feet (12 192 mm) or more in height, outrigger scaffolds, and suspension scaffolds, including all supports, fastenings, connections and details, shall not be erected or installed unless and until a written permit has been issued by the commissioner on the basis of plans, drawings, and specifications. Copies of the permit shall be posted in a conspicuous location at the site visible to the general public. Copies of the approved plans shall be maintained at the site and made available to the commissioner upon request.

#### **Exceptions:**

1. Any two-point suspended scaffold supported by a parapet using C-hooks that meet the requirements of Section 3314.10.2. In lieu of a permit, no person shall use or install such a two-point suspended scaffold supported by a parapet using C-hooks without notifying the department in a form and manner specified by the department at least 24 hours, but no more than 48 hours prior to the commencement of such use or installation.
2. Any suspended scaffold or outrigger scaffold on new construction, or on alterations where the operation of the scaffold is confined within the property and the site is protected in accordance with Section 3307.

3. Window washing equipment that is permanently anchored to the building or structure by a davit.

**3314.2.1 Signs.** Following the receipt of a permit to erect or suspend a scaffold, the permit holder shall post a sign that meets the requirements of Section 3301.9.6. Such sign shall be clearly visible from the street. Other than as required by Section 3301.10, there shall be no information, pictorial representation, or business or advertising messages posted on a scaffold.

### **3314.3 Design of scaffolds.**

**3314.3.1 Design.** All supported scaffolds 40 feet (12 192 mm) or more in height, outrigger scaffolds, and suspension scaffolds, including all supports, fastenings, connections, and details shall be designed in accordance with the provisions below.

Each scaffold and its components shall be capable of supporting, without failure, its own weight and at least four times the maximum intended load applied or transmitted to it in accordance with Section 3314.3.3. Each suspension rope, including connecting hardware, used on non-adjustable suspension scaffolds shall be capable of supporting, without failure, at least six times the maximum intended load applied or transmitted to the rope.

Where applicable, scaffolds and their connections to the building or structure shall be designed for wind loads as prescribed in Section 1609.

Copies of the plans, drawings, and specifications for all supports, fastenings, connections, and details shall be kept at the site and made available to the commissioner upon request.

**3314.3.1.1 Supported scaffolds.** Supported scaffolds between 40 feet and 75 feet (12 192 mm and 22 860 mm) must be designed by a qualified person or company or a registered design professional. Supported scaffolds over 75 feet (22 860 mm) in height must be designed by a registered design professional.

**3314.3.1.2 Outrigger scaffolds.** Outrigger scaffolds must be designed by a registered design professional.

**3314.3.1.3 Suspension scaffolds.** Two-point suspended scaffolds having a support structure with a height from the roof or floor of less than 15 feet (4572 mm) must be designed by a licensed master or special rigger, or a registered design professional. All other suspension scaffolds must be designed by a registered design professional.

**3314.3.1.4 Excess loads.** Scaffolds with loads exceeding 75 pounds per square foot (366.15 kg/m<sup>2</sup>) shall be designed by a registered design professional.

**3314.3.1.5 Frame scaffold brackets.** Where brackets are used for any purpose other than the support of workers, the scaffold and brackets shall be designed by an engineer.

**3314.3.1.6 Parapet clamps.** Where parapet clamps are used to support a vertical load, a registered design professional shall verify that the supporting structure will not be overstressed.

**3314.3.1.7 Multiple trades.** When more than one trade is to use a scaffold simultaneously, the scaffold shall, at a minimum, be designed for a minimum of 50 pounds per square foot (244 kg/m<sup>2</sup>).

**3314.3.2 Plans.** When plans are required by this section, they shall include a plan view, an elevation view, details of anchorage, scaffold designation in accordance with Section 3314.3.3 and, for supported scaffolds, the number of planked levels and the number of levels to be loaded simultaneously.

**3314.3.3 Loading.** All scaffolds shall be designed for one of the intended loads described in Section 3314.3.3.1 to 3314.3.3.4. No scaffold shall be loaded in excess of the maximum load for which it is designed. Loads shall not be concentrated so as to cause stresses in excess of the allowable values designated for the applicable material described in this code.

**3314.3.3.1 Light duty scaffold.** The light duty scaffold is to be used for loads up to 25 pounds per square foot (122.05 kg/m<sup>2</sup>), and is intended for use by carpenters, painters, or others of similar trades. It shall not be used to support loads more severe than those imposed by such workers and a minimum amount of lightweight materials.

**3314.3.3.2 Medium duty scaffold.** The medium duty scaffold is to be used for loads up to 50 pounds per square foot (244.1 kg/m<sup>2</sup>), and is intended for use by bricklayers, plasterers, pipe fitters or other similar trades. It shall not be used to support loads more severe than those imposed by such workers and a moderate amount of their materials.

**3314.3.3.3 Heavy duty scaffold.** The heavy duty scaffold is to be used for loads up to 75 pounds per square foot (366.15 kg/m<sup>2</sup>), and is intended for use by stone masons. It shall not be used to support loads more severe than those imposed by such workers and a reasonable supply of their materials.

**3314.3.3.4 Extra heavy duty scaffold.** The extra heavy duty scaffold is to be used for loads exceeding 75 pounds per square foot (366.15 kg/m<sup>2</sup>) and shall be designed in accordance with Section 3314.3.1.4.

**3314.3.4 Fire retardant construction.** With the exception of the planking, the following scaffolds shall be constructed of noncombustible materials:

1. Exterior scaffolds exceeding 75 feet (22 860 mm) in height.
2. Interior scaffolds exceeding 21 feet (6.4 mm) in height.
3. All scaffolds used in the alteration, repair, or partial demolition of buildings in occupancy groups I-1 to I-4.

#### **3314.4 Installation and use of scaffolds.**

**3314.4.1 Installation.** Scaffolds that require a permit or design shall be erected and installed in accordance with the construction documents, drawings, and specifications for the scaffold. Upon completion of the installation of the scaffold, an inspection report verifying that the scaffold has been installed in accordance with the design drawings, construction documents and specifications shall be prepared by the designer, installer, or an approved inspection agency designated by both the designer and installer.

**3314.4.2 Maintenance and repair.** All scaffolds shall be maintained in a safe condition. No scaffold shall be altered, removed or partially dismantled while it is in active use, unless done by a qualified person.

Every damaged or weakened scaffold shall be immediately repaired or secured and shall not be used until satisfactory repairs have been completed, and the scaffold is inspected under the provisions of Section 3314.4.3.

**3314.4.3 Inspections.** All scaffolds, except for suspended scaffolds, shall be inspected daily before each use by a competent person designated by the trade(s) using the scaffold. A record of such daily inspections shall be maintained and available at the site where the scaffold has been erected. Suspended scaffolds shall be inspected in accordance with Section 3314.4.3.1.

**3314.4.3.1 Inspection of suspended scaffolds.** Before use, all suspended scaffolds shall be inspected daily by the licensed rigger or his or her foreman in accordance with Section 404 of Title 28 of the *Administrative Code*, or the licensed sign hanger or his or her foreman in accordance with Section 415 of Title 28 of the *Administrative Code*, or the superintendent of construction if the work is not performed by or under the supervision of a licensed rigger or sign hanger in accordance with the exception to Section 404.1 of Title 28 of the *Administrative Code* and Section 415.2 of Title 28 of the *Administrative Code*.

A record of such inspections shall be kept and maintained at the job site and shall be readily available and presented to department personnel upon request. The record shall be signed by the individual responsible for the inspection and shall also show the individual's name clearly and legibly printed.

**3314.4.4 Storage of material and debris.** Material and debris susceptible to dislodgment shall not be stored on scaffolds while work is not being performed.

**3314.4.5 Requirements for workers who erect, repair, maintain, modify or remove supported scaffolds.** Only workers with experience in erecting, repairing, maintaining, modifying, or removing supported scaffolds shall be employed to perform this work. They shall be supervised by a designated superintendent or foreman who shall enforce such measures as necessary for the protection of the public and property.

Workers who erect, repair, maintain, modify and remove supported scaffolds 40 feet (12 192 mm) or more in height must, at a minimum, have completed a training program or course that is at least 32 hours long, and must complete an 8 hour refresher program or course every 4 years thereafter. The training program or course shall be based on the United States Department of Labor Occupational Safety and Health Department (“OSHA”) scaffold safety and training guidelines and the scaffold requirements of this chapter. The training program or course shall be conducted by a registered New York State Department of Labor apprenticeship training program or by an educational institution or school chartered, licensed or registered by the New York State Department of Education and presented by an instructor(s) authorized under the applicable provisions established by OSHA for construction safety.

Successful completion of the training program or course shall be evidenced by a dated scaffold certificate of completion issued by the provider of the training program or course. The certificate or a copy thereof, shall be readily available to the commissioner upon request, and shall be deemed valid for four years from its date of issuance.

Workers who erect, repair, maintain, modify, or remove a sidewalk shed that provides a base for a scaffold 40 feet (12 192 mm) or more in height are subject to the above requirements.

**3314.4.6 Requirements for workers who use a supported scaffold.** Every worker who uses a supported scaffold to perform his or her job tasks shall complete a 4-hour training program or course, and a 4-hour refresher program or course every four years thereafter, that includes instruction on the nature of electrical hazards, fall and falling object hazards, material handling on scaffolds, and the maximum intended load and load-handling capacities of scaffolds. The training program or course shall be conducted by a registered New York State Department of Labor apprenticeship training program or by an educational institution or school chartered, licensed or registered by the New York State Department of Education, and presented by an instructor(s) authorized under the applicable provisions established by OSHA for construction safety.

Successful completion of the training program or course shall be evidenced by a dated scaffold user certificate issued by the provider of the training program or course. The certificate, or a copy thereof, shall be readily available to the commissioner upon request, and shall be deemed valid for four years from its date of issuance.

**3314.4.7 Requirements for workers who erect or use suspension scaffolds.**  
Workers who erect, repair, maintain, modify, remove or use suspension scaffolds shall meet the requirements set forth in rules promulgated by the commissioner.

**3314.5 Platform construction.** Platforms on all working levels of a scaffold shall be fully planked or decked between the front uprights and the guardrail system supports in accordance with Sections 3314.5.1 through 3314.5.6.

**Exception:** Platforms used solely as walkways or used solely by workers performing scaffold erection and dismantling shall be planked to provide safe working conditions.

**3314.5.1 Platform spacing.** Each platform unit shall be installed so that the space between adjacent units and the space between the platform and the uprights is no more than 1 inch (25 mm) wide except where a qualified person can demonstrate that a wider space is necessary.

**3314.5.2 Maximum span for wood plank.** All lumber used in scaffolds or their supports shall be at least equal in strength and quality to construction grade lumber in accordance with Section 2301. See Table 3314.5.2 for the maximum span for scaffold planks.

**3314.5.3 Minimum overhang.** The end of a platform shall extend over the centerline of its support a minimum of 6 inches (152 mm) unless cleated or otherwise restrained by hooks or equivalent means.

**3314.5.4 Maximum cantilever.**

**3314.5.4.1 Ten feet or less.** The end of a platform 10 feet (3048 mm) or less in length shall not extend over the centerline of its support more than 12 inches (305 mm) unless the platform and its tiedown are designed by a qualified person or the platform has guardrails to prevent access to the cantilevered end.

**3314.5.4.2 More than ten feet.** The end of a platform more than 10 feet (3048 mm) in length shall not extend over the centerline of its support more than 18 inches (457 mm) unless the platform and its tiedown are designed by a qualified person or the platform has guardrails to prevent access to the cantilevered end.

**3314.5.5 Platform tiedown.** All platforms shall be tied down, cleated or otherwise restrained by hooks or equivalent means to prevent dislodgment.

**3314.5.6 Platform deflection.** Platforms shall not deflect more than  $\frac{1}{60}$  of the span when loaded.

**3314.6 Footings and anchorage.** The footings and anchorage for every scaffold shall be sound and rigid, capable of carrying the maximum load without excessive settlement or deformation and secure against movement in any direction. Supports such as barrels, boxes, loose brick, loose stone, or other unstable materials shall not be used.

**3314.6.1 Safe points of anchorage.** Safe points of anchorage include structural members of a building. Window cleaners anchors, window frames, mullions, handrails, standpipes, vents and other piping systems, electrical conduit, outrigger beams, counterweights or similar elements shall not be used as anchors or braceback points.

**3314.6.2 Lifeline anchorage.** Lifeline anchorage shall be fastened to a fixed safe point of anchorage, shall be independent of the scaffold, and shall be protected from sharp edges and abrasion.

**3314.6.3 Lifelines and suspension ropes.** Lifelines, tiebacks, and suspension ropes shall each be attached to a different point of anchorage.

**3314.6.4 Scaffolds supported on structure.** Loads from supported and suspended scaffolds imposed on an existing roof or floor or similar structure shall not be concentrated so as to cause stresses in excess of the allowable values designated for the applicable material described in this code.

**3314.7 Outrigger beams.** Outrigger beams shall be made of structural metal or equivalent strength material and shall be restrained to prevent movement.

**3314.7.1 Overhang.** The overhang of outrigger beams shall not exceed that specified by the design and the inboard length of beam shall be at least one and one-half times the outboard length.

**3314.7.2 Wire rope suspenders.** The wire rope suspenders shall be securely fastened to the outrigger beams by steel shackles or equivalent means. The shackles and outrigger beams shall be placed so that the ropes will hang vertically.

**3314.8 Guardrail system and toeboards.** Except for scaffold platforms 6 feet (3048 mm) or less above the ground, the open sides and ends of every scaffold platform shall be provided with a guardrail system and toeboard, unless otherwise specified for the particular type of scaffold. The guardrail system shall be installed before the scaffold is released for use by workers other than the workers who are erecting or dismantling the scaffold.

**3314.8.1 Mesh installation.** Where it is possible for the public to pass under, or next to a scaffold, the space between the top rail and toeboard shall be enclosed with a



wire screen composed of not less than no. 18 steel wire gage with a maximum ½ inch (13 mm) mesh or equivalent synthetic safety netting. For the purpose of this provision the term "where it is possible for the public to pass under, or next to a scaffold" shall mean when the setback from the scaffold to the area used by the public is a distance equal to or less than half the height of the scaffold.

**3314.8.2 Top edge height.** The top edge height of the toprails or equivalent member shall be installed between 38 inches and 45 inches (965 and 1143 mm) above the platform surface.

**3314.8.3 Midrail installation.** When midrails, screens, mesh, intermediate vertical members, solid panels, or equivalent structural members are used, they shall be installed between the top edge of the guardrail system and the scaffold platform.

**3314.8.4 Midrail height.** When mid-rails are used, they shall be installed at a height approximately midway between the top edge of the guardrail system and the scaffold platform.

**3314.8.5 Screen or mesh height.** When screens or mesh are used, they shall extend from the top edge of the guardrail system to the scaffold platform and along the entire opening between supports.

**3314.8.6 Intermediate support spacing.** When intermediate supports such as ballisters or additional rails are used, they shall not be more than 19 inches (483 mm) apart.

**3314.8.7 Top rail design.** Each top rail or equivalent member of a guardrail system shall be capable of withstanding, without failure, a force applied in any downward or horizontal direction at any point along its top edge of at least:

1. 100 pounds (45.4 kg) for any guardrail systems installed on a single-point adjustable suspension scaffold or a two-point adjustable suspension scaffold;  
or
2. 200 pounds (90.7 kg) for guardrail systems installed on all other scaffolds.

**3314.8.8 Top rail deflection.** When loads specified in Section 3314.8.7 are applied in the downward direction, the top edge shall not drop below the heights above the scaffold platform as prescribed in Section 3314.8.2.

**3314.8.9 Midrail design.** Midrails, screens, mesh intermediate vertical members, solid panels, and equivalent structural members of a guardrail system shall be capable of withstanding, without failure, a force applied in any downward or horizontal direction at any point along the midrail or other member of at least:

1. 75 pounds (34 kg) for any guardrail systems installed on a single-point adjustable suspension scaffold or a two-point adjustable suspension scaffold; or
2. 150 pounds (68 kg) for guardrail systems installed on all other scaffolds.

**3314.8.10 Toeboards.** A toeboard shall be erected along the edge of the platform and shall be solid or with openings of not more than 1 inch (25 mm) along its longest dimension.

**3314.8.10.1 Toeboard design.** Toeboards shall be capable of withstanding, without failure, a force of at least 50 pounds (22.7 kg) applied in any downward or horizontal direction at any point along the toeboard.

**3314.8.10.2 Toeboard height.** The top edge of the toeboard shall be at least 3 ½ inches (89 mm) high from the level of the walking/working surface and there shall be not more than a ¼ inch (6 mm) clearance above the walking/working surface.

**3314.9 Supported scaffold.** Supported scaffolds shall meet the following requirements:

**3314.9.1 Height-to-base ratio.** A supported scaffold with a height-to-base ratio (including outriggers supports, if used) of more than four to one (4:1) shall be restrained from tipping by guying, tying, bracing or equivalent means as follows:

1. Guys, ties or braces shall be installed at locations where horizontal members support both inner and outer legs.
2. Guys, ties, or braces shall be installed according to the manufacturer's recommendations, or as designed in accordance with Section 3314.3, or at a minimum, the first guy, tie or brace shall be installed at a horizontal member and not more than a distance 4 times the least plan dimension from the base support and be repeated vertically at locations of horizontal members every 20 feet (6096 mm) or less thereafter for scaffolds 3 feet (914 mm) wide or less and every 26 feet (7925 mm) or less thereafter for scaffolds greater than 3 feet (914 mm) wide. The top guy, tie, or brace shall be placed no further than 4 times the least plan dimension from the top. Such guys, ties, or braces shall be installed at each end of the scaffold and at horizontal intervals not to exceed 30 feet (9144 mm) measured from one end (not both) towards each other.
3. Guys, ties, braces, or outriggers shall be used to prevent tipping of supported scaffolds in all circumstances where an eccentric load, such as a cantilevered work platform, is applied or is transmitted to the scaffold.

**3314.9.2 Foundation.** Supported scaffold poles, legs, posts, frames and uprights shall bear on base plates and mud sills or other adequate firm foundation.

**3314.9.3 Plumb.** Supported scaffold poles, legs, posts, frames, and uprights shall be plumb and braced to prevent swaying and displacement. The tolerance shall not exceed  $\frac{L}{100}$ , where L is the distance measured from the ground or grade elevation to the first X-brace or bottom of the first bearer or frame horizontal member.

**3314.10 Suspended scaffold.** Suspended scaffolds shall meet the requirements of Sections 3314.10.1 through 3314.10.10.

**3314.10.1 Installation and use.** Suspended scaffolds shall be erected and operated in such a manner that suspension elements are vertical and in a plane parallel to the wall at all times. The installation or change of position of any suspended scaffold shall be performed under the supervision of a licensed master or special rigger, or a licensed sign hanger, or his designated foreman who shall ensure the safety of such operation.

Suspended scaffolds shall be inspected in accordance with the requirements of Section 3314.4.3.1.

**3314.10.2 Support.** All suspended scaffold support devices, such as outrigger beams, C-hooks, parapet clamps, and similar devices shall rest on surfaces capable of supporting at least 4 times the load imposed on them by the scaffold operating at the rated load of the hoist. The support shall be inspected by a competent person prior to installation.

**3314.10.3 Outrigger beam location.** Outrigger beams shall be placed perpendicular to the face of the building or structure.

**Exception:** Where a licensed rigger or engineer can demonstrate to the commissioner's satisfaction that it is not possible to place an outrigger beam perpendicular to the face of the building or structure, the outrigger beam may be placed at a different angle, provided opposing angle tiebacks are used.

**3314.10.4 Outrigger beam stabilization.** The inboard ends of the suspended scaffold outrigger beam shall be stabilized by bolts or other direct connections to the floor or roof deck, or they shall have their inboard ends stabilized by counterweights.

**Exception:** Multi-point adjustable suspended scaffolds shall not be stabilized by counterweights.

**3314.10.5 Outrigger beam installation.** Outrigger beams shall be installed with all bearing supports perpendicular to the beam centerline and shall set and maintain the web in a vertical position. The shackle or clevis with which the rope is attached to the outrigger beam shall be placed directly over the centerline of the stirrup.

**3314.10.6 Counterweight material.** Counterweights shall be made of a non-flowable material. Sand, gravel and similar materials that can be easily dislocated shall not be used.

**3314.10.7 Counterweight securement.** Counterweights shall be secured by mechanical means to the outrigger to prevent accidental dislodgment.

**3314.10.8 Counterweight removal.** Counterweights shall not be removed from an outrigger beam until the scaffold is disassembled.

**3314.10.9 Tieback location.** Tiebacks shall be installed perpendicular to the face of the building, or opposing angle tiebacks shall be installed. Single tiebacks installed at an angle are prohibited.

**3314.10.10 Support devices.** Suspended scaffold support devices, such as C-hooks, cornice hooks, roof hooks, roof irons, parapet clamps or other similar devices shall meet the following requirements:

1. Support devices shall be made of steel, wrought iron or materials of equivalent strength.
2. Such devices shall be supported by bearing blocks.
3. Support devices shall be secured against movement by tiebacks installed at right angles to the face of the building or structure or by opposing angle tiebacks installed and secured to a structurally sound point of anchorage as prescribed in Section 3314.6.
4. Tiebacks shall be equivalent in strength to the hoisting rope.

**3314.11 Suspension rope.** When winding drum hoists are used on a suspended scaffold, they shall contain not fewer than four wraps of the suspension rope at the lowest point of scaffold travel. When other types of hoists are used, the suspension ropes shall be long enough to allow the scaffold to be lowered to the level below without the rope end passing through the hoist, or the rope end shall be configured or provided with means to prevent the end from passing through the hoist.

**3314.11.1 Repaired rope.** The use of repaired wire rope as suspension rope is prohibited.

**3314.11.2 Rope replacement.** Ropes shall be replaced or removed if any of the following conditions exist, and as otherwise prescribed by rule of the department:

1. Any physical damage that impairs the function and strength of the rope.
2. Presence of kinks that might impair the tracking or wrapping of the rope around the drum(s) or sheave(s).
3. Presence of abrasion, corrosion, scrubbing, flasttening or peening causing the loss of more than one-third of the original diameter of the outside wires.

4. Heat damage caused by a torch or any damage caused by contact with electrical wires.
5. Evidence that the secondary brake has been activated during an overspeed condition and has engaged the suspension rope.

**3314.11.3 Shielding.** Suspension ropes shall be shielded from heat-producing processes.

**3314.11.4 Corrosive substances.** When acids or other corrosive substances are used on a scaffold, the ropes shall be shielded, treated to protect against corrosive substances, or made of a material that will not be damaged by the corrosive substance being used.

**3314.11.5 Arcing prevention.** Precautions shall be taken to prevent the possibility of arcing through the suspension wire rope.

**3314.11.5.1 Insulated thimble.** An insulated thimble shall be used to attach each suspension wire rope to its hanging support. Excessive suspension wire rope and any additional independent lines from grounding shall be insulated.

**3314.11.5.2 Insulating material.** The suspension wire rope shall be covered with insulating material extending at least 4 feet (1219 mm) above the hoist. If there is a tail line below the hoist, it shall be insulated to prevent contact with the platform. The portion of the tail line that hangs free below the scaffold shall be guided or retained or both so that it does not become grounded.

**3314.11.5.3 Protective covers.** Each hoist shall be covered with insulated protective covers.

**3314.11.5.4 Grounding conductor.** In addition to a work lead attachment required by the welding process, a grounding conductor shall be connected from the scaffold to the structure. The size of the connector shall be at least the size of the welding process work lead, and this conductor shall not be in series with the welding process or the work piece.

**3314.11.5.5 Disconnected grounding lead.** If the scaffold grounding lead is disconnected at any time, the welding machine shall be shut off.

**3314.11.5.6 Welding rod or lead.** An active welding rod or uninsulated welding lead shall not be allowed to make contact with the scaffold or its suspension system.

**3314.11.6 Wire rope clips.** There shall be a minimum of three wire rope clips installed a minimum of six rope diameters apart. The clips shall be retightened to the

manufacturer's specifications after initial loading. U-bolt clips shall not be used at the point of suspension. When U-bolt clips are used, the U-bolt shall be placed over the dead end of the rope and the saddle shall be placed over the live end of the rope.

### **3314.12 Wood pole scaffolds.**

**3314.12.1 Standard designs.** All wood pole scaffolds 40 feet (12 192 mm) high or less shall be constructed in accordance with the minimum nominal sizes and maximum spacings shown in Tables 3314.12.1 (1) through 3314.12.1 (6). Wood pole scaffolds more than 40 feet (12 192 mm) high shall be designed in accordance with Section 3314.3.

**3314.12.2 Erection and removal.** When a new working level is desired, the existing planks shall be left undisturbed until the new working level is framed. As the platform level is abandoned with the progress of the work, all members other than the planking, railing and toeboards shall be left intact. When removing a scaffold, the sequence of removing the members shall be the reverse of that used in erection.

**3314.12.3 Materials and construction for wood pole scaffolds.** Wood pole scaffold materials and construction shall comply with the following requirements:

1. All lumber used in wood pole scaffolds or their supports shall be at least equal in strength and quality to construction grade lumber in accordance with Section 2301.
2. All lumber and timber shall be fastened at the various joints with sufficient nails or bolts of a suitable size to produce a secure joint capable of withstanding the design load. Table 3314.12.3 provides minimum requirements for size and number of nails. All nails shall be driven full length.
3. Any other suitable material, or dimensions other than those indicated, may be used for wood pole scaffold construction provided it is at least equivalent in strength and suitability to the comparable wood scaffold it is designed to replace, and approval of the commissioner has been obtained.

**3314.12.4 Poles.** Wooden scaffold poles shall be plumb and the foot ends shall be secured against lateral movement. Where wood poles are spliced, the squared end of the upper section shall bear uniformly on the squared end of the lower section and the two ends shall be rigidly fastened together with two or more wood splice plates, each at least 4 feet (1219 mm) in length. The plates shall be placed at right angles to each other, shall overlap the abutting ends of the pole equally, and shall have a combined sectional area not less than 50 percent of the cross sectional area of the pole. Splicing of adjacent poles shall be staggered. Splices shall be close to ledgers, but so located as not to interfere with the fastenings.

**3314.12.5 Bracing.** Wood pole scaffolds shall be braced and stayed to prevent movement away from the building. Diagonal or equivalent bracing shall be provided to prevent the poles from moving in a direction parallel to the building face and shall be so installed that every spliced section of every pole is braced to adjacent poles.

**3314.12.6 Planking.** Where planks are butted end to end, parallel putlogs or bearers shall be provided not more than 8 inches (203 mm) apart so that the butted ends rest on separate putlogs or bearers. Ends shall be nailed or cleated.

Where platform planks are used with overlapping ends, the ends of both the upper and lower planks shall overlap the putlog or bearer by at least 6 inches (152 mm).

Planks shall be laid close together and shall be of sufficient length to extend over three bearers.

**3314.12.7 Connections.** Ledgers shall not be spliced between poles but shall overlap the poles at each end by at least 4 inches (102 mm). Where ledgers lap each other, bearing-blocks attached to the pole shall be provided to support the ledger.

The ends of all wooden braces shall overlap the nailed fastenings by an amount sufficient to prevent the ends of the braces from splitting.

**3314.12.8 Putlogs for single pole scaffolds.** All putlogs shall be set with the greater dimension vertical and shall be long enough to project beyond the outer edge of the poles by at least 12 inches (305 mm). Putlogs shall be supported on the ledger and located against the side of the poles and fastened to either the pole or the ledger. The other end of the putlog shall rest in the wall of the building, with at least a 4 inch (102 mm) bearing, and shall not be notched or cut down, except for light duty scaffolds, which may be notched or cut down to fit into a space made by the removal of a brick. In such cases, the notch shall be made on the top of the putlog just deep enough to permit it to be inserted in the hole in the wall.

**3314.12.9 Bearers for independent pole scaffolds.** Bearers shall be set with their greater dimensions vertical, and shall be long enough to project over the ledgers beyond the outer row of poles by at least 12 inches (305 mm) and beyond the inner row of poles by at least 2 inches (51 mm). Bearers shall be supported on the ledgers, located against the sides of the poles and fastened to the ledgers.

### **3314.13 Fabricated frame scaffolds.**

**3314.13.1 Bracing.** Frames and panels shall be braced by cross, horizontal or diagonal braces or a combination thereof, which secure vertical members together laterally.

**3314.13.2 Vertical joining.** Frames and panels shall be joined together vertically by coupling or stacking pins or equivalent means. Where uplift can occur, the frames or panels shall be locked together vertically by pins or equivalent means.

**3314.13.3 Frame scaffold brackets.** Brackets used to support cantilevered loads shall be seated with side-brackets parallel to the frame and end-brackets at 90 degrees to the frames, shall not be bent or twisted from these positions and shall be used only to support light duty loads as defined in Section 3314.3.3, unless the design provisions of Section 3314.3 have been met.

**3314.14 Outrigger scaffolds (thrust out).** Outrigger scaffolds (thrust out) shall not be used for loading in excess of 50 pounds per square foot (244.1 kg/m<sup>2</sup>) (medium duty).

**3314.14.1 Outrigger beams.** The fulcrum point of the beam shall rest on a secure bearing at least 6 inches (152 mm) in each horizontal dimension. The beam shall be secured against movement and shall be securely braced against tipping at both the fulcrum point and the inboard end.

**3314.14.2 Inboard supports.** The inboard ends of outrigger beams shall be securely fixed to resist all vertical, horizontal, and torsional forces. Pull-out tests for adhesive and expansion anchors, if used, shall be approved by the commissioner.

**3314.15 Two-point adjustable suspension scaffolds.**

**3314.15.1 Width and support.** Two-point suspension platforms shall be at least 20 inches (508 mm) but not more than 36 inches (914 mm) in width unless designed by an engineer. Each end of the platform shall be supported by a stirrup or hanger that meets the requirements of Section 3315.15.2, and the platform shall be securely fastened thereto. Not more than two hangers or stirrups shall be used to support one scaffold.

**3314.15.2 Hangers or stirrups.** Hangers or stirrups shall be of steel or wrought iron. Each such hanger shall be formed to properly fit the platform and the hoist mechanism. The hanger or stirrup shall be placed at least 6 inches (152 mm) but not more than 18 inches (457 mm) from the end of the platform unless the manufacturer specifies otherwise.

**3314.15.3 Fiber suspension rope.** The use of fiber rope shall be limited to light duty two-point suspension scaffolds. Fiber rope shall be at least equivalent in strength and suitability to ¾ -inch (19 mm) grade #1 unspliced manila rope.

Fiber rope susceptible to damage from corrosive substances shall not be permitted for or near any work involving the use of corrosive substances

Fiber rope shall not be used where the upper block is more than 100 feet (30 480 mm) or ten stories above the ground or roof setback.



All blocks shall fit the size of rope they carry, and shall be constructed so as not to chafe the rope.

**3314.15.4 Combination.** Two or more two-point suspension scaffolds shall not be combined into one by bridging the distance between them or by any other form of connection.

**3314.15.5 Number of workers.** Not more than two workers shall be permitted to work on one scaffold at one time except where the scaffold is designed to hold more. Written permission from the commissioner shall be required for more than two workers on the scaffold.

**3314.15.6 Device to raise, lower, and hold the scaffold.** Every two-point suspension scaffold shall be equipped with an approved device to raise, lower or hold the scaffold in position.

**3314.15.7 Platforms.** The platforms of every two-point suspension scaffold shall be ladder-type, plank-type, beam-type, light-metal type, or another type acceptable to the commissioner.

**3314.16 Corner and angle scaffolds.** Corner and angle scaffolds shall comply with the following:

**3314.16.1 Motors.** As many motors as needed shall be provided to maintain the stability of the platform under all operating conditions.

**3314.16.2 Maximum number of people.** The number of people allowed on a corner or angle scaffold shall not be more than the number of motors required to keep the scaffold stable, unless otherwise designed by an engineer.

**3314.16.3 Permit application.** The following equipment information shall be submitted by an engineer with the permit application for corner and angle scaffolds:

1. Plans and details of the equipment;
2. Load capacity and distribution charts;
3. Certification from the engineer that he/she has reviewed the manufacturer's design calculations and testing or prepared sufficient calculations of his/her own and found them to conform to this code; and
4. Any supporting data, drawings, or calculations.

**3314.16.4 Inspection.** The equipment setting for corner and angle scaffolds shall be inspected by the department prior to its use. Additional inspection by the department shall be required each time the equipment is moved to a different position.

**3314.17 Multiple-point adjustable suspension scaffolds.** Multiple-point suspension scaffolds shall comply with the following:

1. All multiple-point suspension scaffolds shall be supported by wire ropes. The use of fiber ropes is not permitted;
2. Provision shall be made to prevent supports from slipping off the ends of outrigger beams;
3. Platform bearers shall be of metal; and
4. During raising or lowering, the levels of the various sections of the scaffolds shall be kept uniform and the differential height between sections shall be minimized.

**3314.18 Manually-propelled, free-standing scaffolds.** All manually-propelled free-standing scaffolds shall meet the following requirements:

1. Work platforms shall be tightly planked for the full width of the scaffold, except for necessary entrance openings. Planks shall be secured in place;
2. Platforms shall have a guardrail system;
3. Where a ladder is used to approach a platform, the ladder shall be secured to the scaffold;
4. Handholds shall be provided for safe passage from the ladder to the platform;
5. Unless temporarily braced to an adjacent structure, the ratio of the platform height to the least base dimension shall be such as to assure stability, but in no case shall such height be more than four times the least base dimension;
6. Provisions shall be made to prevent the scaffold from falling during movement from one location to another;
7. While the scaffold is in use, it shall rest upon a stable footing and shall stand plumb. The casters or wheels shall be locked in position; and
8. While the scaffold is being moved, no person shall be permitted to ride on it, and all tools, equipment and material shall be removed.

**3314.19 Mast-climbing work platform.** Mast-climbing work platforms, including all supports, fastenings, connections, and details shall not be erected or installed unless and until a written permit has been issued by the commissioner on the basis of construction documents, drawings, and specifications. Copies of the written permit application shall be kept at the site and made available to the commissioner upon request. Such permit shall be issued in accordance with rules promulgated by the commissioner.

**SECTION BC 3315**  
**STRUCTURAL RAMPS, RUNWAYS, AND PLATFORMS**

**3315.1 Ramps and runways.** Ramps and runways (including elevated walkways) shall comply with the requirements of Section 3315.1.1 through 3315.1.5.

**3315.1.1 Construction.** All runways and ramps shall be constructed, braced and supported to resist lateral displacement and all vertical loads, including impact.

**3315.1.2 For motor vehicle use.** Runways and ramps for the use of motor vehicles may consist of an earthfill or may be structurally supported. Such runways and ramps shall have a clear width of not less than 12 feet (3658 mm) with timber curbs at least 8 inches by 8 inches (203 mm by 203 mm) placed parallel to, and secured to, the sides of the runway or ramp. The flooring of structurally supported ramps shall consist of no smaller than 3 inch (76 mm) planking full size, undressed, or equivalent material, with spans designed for the loads to be imposed.

**3315.1.3 For use of workers.** Runways and ramps for the use of workers shall be at least 1 foot 6 inches (457 mm) in clear width. Where used for wheelbarrows, handcarts, or hand-trucks, runways and ramps shall be at least 3 feet (914 mm) in clear width. Flooring shall consist of at least 2 inch (51 mm) planking spanning as permitted by Table 3314.5.2, laid close, butt-joined, and securely fastened.

**3315.1.4 Slope limitations.** Ramps shall have a slope not steeper than one in four. If the slope is steeper than one in eight, the ramp shall be provided with cleats spaced not more than 14 inches (356 mm) apart and securely fastened to the planking to afford a foothold. Spaces in the cleats may be provided for the passage of the wheels of vehicles. The total rise of a continuous ramp used by workers carrying material or using wheelbarrows, hand-carts, or hand-trucks shall not exceed 12 feet (3658 mm) unless broken by horizontal landings at least 4 feet (1219 mm) in length.

**3315.1.5 Guardrail required.** All runways and ramps located more than 5 feet (1524 mm) above the ground or floor shall be provided with a standard guardrail and standard toeboard that meets the requirements of Section 3307.8 on open sides.

Where it is possible for the public to pass under, or next to, runways or ramps, the space between the top rail and the standard toeboard shall be enclosed with a wire screen composed of not less than no. 18 steel wire gage with a maximum ½ inch (12.7 mm) mesh.

**3315.2 Platforms.** Platforms shall comply with the requirements of Sections 3315.2.1 through 3315.2.2.

**3315.2.1 Planking.** Platforms used as working areas, or for the unloading of wheelbarrows, hand-trucks, or carts shall have a floor consisting of at least 2 inch (51 mm) planking spanning as permitted by Table 3314.5.2. Platforms for the use of

motor trucks shall have a floor of at least 3 inch (76 mm) planking, full size, undressed or equivalent materials with spans designed for the loads to be imposed. Planking shall be laid close and shall be butt-joined and securely fastened.

**3315.2.2 Guardrail required.** Every platform more than 5 feet (1524 mm) above the ground or above a floor shall be provided with a standard guardrail and standard toeboard that meets the requirements of Section 3307.8, except that the side of the platform used for the loading or unloading of vehicles may be protected by a timber curb at least 8 inches by 8 inches (203 mm by 203 mm) for motor trucks or 4 inches by 4 inches (102 mm by 102 mm) for wheelbarrows and hand-trucks in lieu of the standard guardrail and standard toeboard.

Where it is possible for the public to pass under, or next to, platforms, the space between the top rail and the standard toeboard shall be enclosed with a wire screen composed of not less than no. 18 steel wire gage with a maximum ½ inch (12.7 mm) mesh.

**3315.3 Special requirements where power buggies are used.** Runways, ramps, platforms, and other surfaces upon which power buggies are operated shall meet the following minimum requirements:

1. They shall be designed by a qualified person.
2. They shall be able to sustain, without failure, at least four times the maximum live load for which they are intended.
3. The minimum width, inside of curbs, for any ramp, runway, or platform shall be 2 feet (610 mm) wider than the outside width of any power buggy operated thereon without passing, and 3 feet (914 mm) wider than twice such buggy width in the places where passing occurs.
4. All runways shall be essentially level transversely.
5. Curbs shall be furnished along all buggy traffic paths that are nearer than 10 feet (3048 mm) horizontally to any unenclosed area, shaft, or other open space into which or through which a fall of more than 12 inches (305 mm) from such surface is possible, except as set forth in numbered item seven.
6. Where curbs are not required because the buggy is operated on a surface not over 12 inches (305 mm) above another surface, the lower surface shall be strong enough to sustain the loaded vehicle in the event of a fall thereon.
7. Curbs may be omitted at actual dumping points more than 12 inches (305 mm) above other surfaces if the edge over which dumping occurs is provided with bumpers or other means that will effectively stop the buggy from running over the edge while dumping.

8. Curbs must be at least 7 inches (178 mm) high, securely fastened, and capable of resisting side impact, and shall be equivalent to at least 2 inch by 8 inch (51 mm by 203 mm) plank set on edge against uprights securely fastened and braced at not more than 4 foot (1219 mm) intervals.

## **SECTION BC 3316** **HOISTING EQUIPMENT**

**3316.1 Scope.** Hoisting equipment shall meet and be used in accordance with the requirements of this section. Material hoists and bucket hoists shall also meet the requirements of Section 3317, personnel hoists shall also meet the requirements of Section 3318, and cranes and derricks shall also meet the requirements of Section 3319.

**3316.2 Requirements.** Hoisting equipment, its supports and runback structures shall be installed, operated, and maintained to eliminate hazard to the public or to property. It shall be unlawful to operate any such equipment that is not provided with a positive means for preventing the unauthorized operation of such machine. The means whereby such machines may be made inoperative shall be accepted by the department.

**3316.3 Notification of hoisting accidents.** The owner or person directly in charge of any hoisting equipment shall immediately notify the commissioner following any accident involving hoisting equipment. Following an incident, no person shall permit either of the following, without the permission of the commissioner:

1. Use of such hoisting equipment; or
2. Removal of the hoisting equipment or any part thereof from the area of the job site.

**3316.4 Permit.** Permits for hoisting equipment shall comply with the requirements of Sections 3316.4.1 through 3316.4.5.

**3316.4.1 Acceptance of equipment.** Hoists and all pre-manufactured runback structures shall be approved for use by the commissioner or other agency acceptable to the commissioner

**Exception:** Cranes and derricks shall meet the requirements of Section 3319.3.

**3316.4.2 Posting of permits.** Permits, or duplicates of the permits, shall be posted in a conspicuous location in the car or on the equipment.

**3316.4.3 Construction documents.** Copies of the written permit application and approved construction documents shall be kept at the site and made available to the commissioner upon request.

**3316.4.4 Permit signage.** Following the receipt of a permit to install a hoist, the permit holder shall post a sign that meets the requirements of Section 3301.9.6. Such sign shall be clearly visible from the street.

**3316.4.5 Other temporary signage.** Other than as specified in Section 3301.10, there shall be no information, pictorial representation, or any business or advertising messages posted on the hoisting equipment or runback structure.

**3316.5 Design, construction and inspection.** Hoisting equipment, its supports and runback structures shall be designed, constructed and inspected in accordance with rules promulgated by the commissioner.

**3316.6 Rope inspection and replacement.** All ropes used in hoisting equipment shall meet the inspection and replacement requirements specified in rules promulgated by the commissioner.

**3316.7 Operation.** Only operators designated by the person causing such hoisting equipment to be used shall operate such hoisting machinery. Operators and signalmen/signalwomen shall be qualified for the operation they perform. The operator shall be responsible for making the machine inoperative before he or she leaves the machine.

**3316.7.1 Use.** Hoisting equipment, its supports and runback structures shall be operated in compliance with the manufacturing specifications, the requirements of this code, and rules promulgated by the commissioner. If there is a discrepancy, the stricter requirement shall be met.

**3316.7.2 Use during installation, jumping, dismantling, or alteration.** Personnel and building materials connected with or related to the building project shall not be moved by the hoist while it is being installed, jumped, dismantled or altered.

**3316.8 Maintenance.** Hoisting equipment, its supports and runback structures shall be maintained in compliance with the manufacturing specifications and rules promulgated by the commissioner. If there is a discrepancy, the stricter requirement shall be met.

## **SECTION BC 3317** **MATERIAL HOISTS AND BUCKET HOISTS**

**3317.1 Scope.** Material hoists and bucket hoists shall meet the requirements of this section and Section 3316.

**3317.2 Permit.** The equipment user or his or her designated representative shall obtain a written permit issued by the commissioner on the basis of construction documents, drawings and specifications prior to erecting or installing all power-operated, material hoists, including any runback structure or supports.

**Exception:** Power-operated, non-guided material hoists with a maximum capacity of one ton or less and installed on new construction, or on alterations where the operation of the hoist is confined within the property and the site is protected in accordance with Section 3307.

**3317.3 Design, inspection, and operation.** Material hoists, bucket hoists and their components shall be designed, inspected, and operated in accordance with rules promulgated by the commissioner.

**3317.4 Construction.** Material hoists, bucket hoists and their components shall be constructed in compliance with the manufacturing specifications, the requirements of this code, and rules promulgated by the commissioner. If there is a discrepancy, the stricter requirement shall be met.

Upon completion of the installation of the hoisting equipment and/or its runback structure, an inspection report verifying that the hoist has been installed in accordance with the design drawings, construction documents and specifications shall be prepared by the designer, installer or an approved inspection agency designated by both the designer and installer.

**3317.5 Operation.** Notwithstanding any other provision of law, material hoists with a manufacturer's capacity over one ton shall be operated only by persons holding a Class A or Class B Hoisting Machine Operators License except during installation, jumping, dismantling or alteration operations.

## **SECTION BC 3318** **PERSONNEL HOISTS**

**3318.1 Scope.** Personnel hoists shall meet and be used in accordance with the requirements of this section and Section 3316.

**3318.2 Permit.** The equipment user or his or her designated representative shall obtain a written permit issued by the commissioner on the basis of construction documents, drawings and specifications prior to erecting or installing all power-operated, material hoists, including any runback structure or supports.

**3318.3 Design and inspection.** Personnel hoists and their components shall be designed and inspected in accordance with rules promulgated by the commissioner.

**3318.4 Construction.** Personnel hoists and their components shall be constructed in compliance with the manufacturer's specifications, this code, and rules promulgated by the commissioner. If there is a discrepancy, the stricter requirement shall be met.

Upon completion of the installation of the hoisting equipment and/or its runback structure, an inspection report verifying that the hoist has been installed in accordance with the design drawings, construction documents and specifications shall be prepared by

the designer, installer or third party designated by both the designer and installer and acceptable to the commissioner.

**3318.5 Operation.** Personnel hoists and their components shall be operated in accordance with this code and rules promulgated by the commissioner.

When the hoist is equipped with manual controls, the hoist shall be operated by a competent qualified operator. Only the operator authorized by the equipment user shall operate the hoist.

**3318.5.1 Making safety devices inoperative.** No person shall at any time make any required safety device or electrical protective device inoperative except when necessary during tests, inspections and maintenance.

Immediately upon completion of the tests, inspections and maintenance, such devices shall be restored to their normal operating condition in conformance with the applicable requirements of this section.

## **SECTION BC 3319** **CRANES AND DERRICKS**

**3319.1 Scope.** The construction, installation, inspection, maintenance and use of cranes and derricks shall be in conformance with the requirements of this section, Section 3316, and with rules promulgated by the commissioner.

**3319.2 Operation.** Riggers and hoisting machine operators shall be licensed as required by Chapter 4 of Title 28 of the *Administrative Code*.

**3319.3 Requirements.** No owner or other person shall authorize or permit the operation of any crane or derrick without a certificate of approval, a certificate of operation and a certificate of on-site inspection.

### **Exceptions:**

1. The requirements of this section shall not apply to excavating or earth-moving equipment, except cranes used with clamshells.
2. The requirements of this section shall not apply to cranes or derricks performing an emergency use pursuant to the lawful order of the head of any department.
3. The requirements of this section shall not apply to mobile cranes, including jibs and any other extensions to the boom not exceeding 50 feet (15 240 mm) in length and with a manufacturer's rated capacity of 3 tons (2722 kg) or less.
4. The requirements of this section shall not apply to mobile cranes, including jibs and any other extensions, exceeding 50 feet (15 240 mm) but not



exceeding 135 feet (41 148 mm) in length, and with a manufacturer's rated capacity of 3 tons (2722 kg) or less, except that a certificate of operation, as provided for in Section 3319.5, shall be required. The requirement for a certificate of operation shall not apply to such a crane used exclusively as a man basket. The commissioner may, by rule, exempt other mobile cranes of limited size from any or all requirements of this section.

5. The requirements of this section shall not apply to hoisting machines permanently mounted on the bed of material delivery trucks that are used exclusively for loading and unloading such trucks, provided that the length of boom does not exceed the length of the truck bed by more than 5 feet (1524 mm) and that any material transported thereon shall not be raised more than 2 feet (610 mm) in the unloading process. Operators of such equipment shall be exempt from licensing requirements described in Chapter 4 of Title 28 of the *Administrative Code*.
6. The requirements of this section shall not apply to cranes or derricks used in industrial or commercial plants or yards not used for the construction of the facility. Floating cranes, floating derricks, and cranes and derricks used on floating equipment shall also be exempt from the requirements of this section. Operators of such equipment shall be exempt from the licensing requirements described in Chapter 4 of Title 28 of the *Administrative Code*.
7. The requirements of this section shall not apply to augurs, churn-drills and other drilling equipment not used for hoisting any objects. Operators of such equipment shall be exempt from the licensing requirements described in Chapter 4 of Title 28 of the *Administrative Code*.
8. The requirements of this section shall not apply to derricks having a maximum rated capacity not exceeding 1 ton (907 kg).
9. The requirements of this section shall not apply to mechanic's truck with a hoisting device when used in activities related to the maintenance and repair of construction-related equipment.
10. The requirements of this section shall not apply to articulating boom cranes that do not have an integral hoisting mechanism, and that are used exclusively for loading and unloading of trucks or trailers, provided that the length of boom does not exceed 135 feet (41 148 mm) and that any material transported thereon shall not be raised more than 100 feet (30 480 mm) in the unloading process. Operators of such equipment shall be exempt from licensing requirements described in Chapter 4 of Title 28 of the *Administrative Code*.

**3319.4 Certificate of approval.** Certificates of approval shall comply with the following:

1. The manufacturer, owner, or designated representative of a crane or derrick for which a certificate of approval is sought shall file an application for such

- certificate of approval and provide such information as set forth in rules promulgated by the commissioner.
2. Upon the department's approval of the application described in item 1 above, the department shall issue a certificate of approval for the equipment and an approval of the submitted load rating chart.
  3. A new certificate of approval shall be required when a crane or derrick is modified or altered to increase the boom length, jibs or any extensions to the boom beyond the maximum approval length or when the load ratings are increased.

**3319.5 Certificate of operation.** Certificates of operation shall comply with the following:

1. The commissioner shall issue the initial certificate of operations for the crane or derrick with certificate of approval upon satisfactory inspection and test indicating that such crane or derrick is in a safe operating condition. The initial certificate of operation shall expire one year from the date of issuance.
2. The owner of a crane or derrick covered by the certificate of operation shall renew the certificate of operation each year.
3. If the owner of the covered crane or derrick applies for renewal of a certificate of operation within not more than 60 nor less than 30 days prior to the date of its expiration, such owner may continue to use the covered crane or derrick until the department grants or denies a new certificate;
4. When a crane or derrick configuration is changed to increase the boom length, jibs or any extensions to the boom beyond the maximum approval length or when the load ratings are increased, a new certificate of operation shall be required. In such a case, the crane or derrick may not be operated until the new certificate of operation is obtained.
5. An application for a new certificate of operation shall be submitted when attachments that affect the stability or structure of the crane or derrick are added. Calculations and load rating charts as required by rules promulgated by the commissioner shall be submitted with the renewal request.

**3319.6 Certificate of on-site inspection.** Certificates of on-site inspection shall comply with the following:

1. The equipment user, or his or her designated representative, shall obtain a certificate of on site inspection for the use of any crane or derrick used for construction or demolition purposes at each job site. Such application for the

certificate of on-site inspection shall include information set forth in rules promulgated by the commissioner.

2. Upon approval of the application, a copy of such approval shall be given to the applicant. It shall be unlawful to operate the equipment that is the subject of the approval until it has been inspected and found to be satisfactory by the department as set forth in rules promulgated by the commissioner. Upon inspection and a finding of satisfactory compliance, the approval shall be deemed a certificate of on-site inspection, which shall expire one year from the date of issuance. A certificate of on-site inspection may be renewed in accordance with rules promulgated by the commissioner;
3. The certificate of on-site inspection is y valid only if the conditions and statements contained in the approved application are complied with and the crane or derrick is operated in conformance with the provisions of this section and the rules applicable thereto.
4. A certificate of on-site inspection is not required for cranes or derricks performing work exempted from such requirement by rules promulgated by the commissioner.

**3319.7 Temporary certificates.** The commissioner may issue temporary certificates of approval, operation and on-site inspection for any crane or derrick during the pendency of an application for certificates of approval and operation upon inspection and upon such analysis and testing as the commissioner may deem necessary. The commissioner may revoke such temporary certificates if the application is denied.

## **SECTION BC 3320** **MATERIAL HANDLING EQUIPMENT**

**3320.1 Scope.** Material handling equipment shall meet and be used in accordance with the requirements of this section.

**3320.2 Requirements.** Material handling equipment shall be installed, operated, and maintained to eliminate hazard to the public or to property. It shall be unlawful to operate any such equipment that is not provided with a positive means for preventing the unauthorized operation of such machine. The means whereby such machines may be made inoperative shall be acceptable to the commissioner.

**3320.3 Operation.** Only operators designated by the person causing such machinery to be used shall operate material handling machinery. Operators and signalmen/singalwomen shall be experienced at the operation they perform. The operator shall be responsible for making the machine inoperative before he or she leaves the machine.

**3320.3.1 Loading.** Loading of material handling equipment shall be conducted in accordance with the following requirements:

1. Material handling equipment shall not be loaded in excess of the rated load specified by the manufacturer. When necessary, manufacturer load ratings shall be reduced to take into account effects of wind, ground condition and operating speed.
2. Rated load capacities and required charts shall be conspicuously posted on all material handling equipment or on the job site and shall be available to the commissioner at all times.
3. All loads shall be properly trimmed to prevent the dislodgment of any part during raising, lowering, swinging or transit.
4. Suspended loads shall be securely slung and properly balanced before they are set in motion.

**3320.3.2 Refueling.** Refueling of material handling equipment shall be conducted in accordance with the following requirements:

1. The engine shall be stopped during refueling, except as otherwise provided in rules promulgated by the commissioner.
2. Open lights, flames, or spark-producing devices shall be kept at a safe distance while refueling an internal combustion engine.
3. No person shall smoke or carry lighted smoking material in the immediate vicinity of the refueling area.
4. "No smoking" signs shall be conspicuously posted in all fueling or fuel storage areas.
5. Fuel shall be kept in containers that meet the requirements of the Fire Department.
6. All other requirements of the Fire Department shall be satisfied.

**3320.4 Notification of accidents involving material handling equipment.** The owner or person directly in charge of any material handling equipment shall immediately notify the commissioner following any accident involving material handling equipment. In such a case, no person shall permit either of the following without the permission of the commissioner:

1. Use of such material handling equipment; or
2. Remove of the material handling equipment or any part thereof from the area of the job site.

**3320.5 Conveyors.** Conveyors shall meet the requirements of Sections 3320.5.1 through 3320.5.3.

**3320.5.1 Walkways.** Walkways along belt conveyors or bucket conveyors shall be kept free of materials and, where 5 feet (127 mm) or more above the ground, shall be provided with a standard guardrail and standard toeboard that meets the requirements of Section 3307.8 along the outside of the walkway. The standard guardrail and standard toeboard may be omitted on the side toward the belt if the walkway is located adjacent to the conveyor.

**3320.5.2 Trippers.** Where trippers are used to control discharge, a device for throwing the belt or bucket drive into neutral shall be installed at each end of the runway.

**3320.5.3 Spillage.** Where conveyor belts cross any traveled way, trays shall be installed to catch spillage and overhead protection shall be provided for persons or traffic passing beneath.

**3320.6 Trucks.** Trucks shall meet the requirements of Sections 3320.6.1 and 3320.6.2.

**3320.6.1 Maintenance.** All parts and accessories of trucks shall be kept in repair. Brakes shall be maintained so that the vehicle with full load may be held on any grade that may be encountered on the job. Provision shall be made for the immediate application of wheel blocks to trucks traversing ramps steeper than one in ten.

**3320.6.2 Loading.** Trucks shall not be loaded beyond the manufacturer's rated capacity, nor beyond the legal load limit, where applicable. The loads shall be trimmed before the truck is set in motion to prevent spillage. Loads that project beyond the sides of the truck, or that may be dislodged in transit, shall be removed or securely lashed in place.

**3320.7 Power buggies.** Power buggies shall meet the requirements of Sections 3320.7.1 and 3320.7.2.

**3320.7.1 Responsibilities of employers and workers.** Employers and workers shall have the following responsibilities regarding power buggies:

- 1. Every person causing a power buggy to be used shall provide trained and competent operators and shall carry out or enforce all provisions of this section pertaining to the use, operation, and maintenance thereof.**
- 2. No person other than the operator assigned by the employer shall operate a power buggy. A power buggy shall be in the charge and custody of the operator assigned, and no other person shall in any way interfere with or handle it, nor shall the operator cause or permit any other person to do so.**

3. No power buggy shall be operated unless it is in good operating condition and is so constructed that it is stable under conditions of normal use.

**3320.7.2 Operation and construction.** Power buggies shall be operated and constructed in accordance with the requirements of Section 3320.7.2.1 through 3320.7.2.4.

**3320.7.2.1 Brakes.** Every power buggy shall be provided with brakes and tire surfaces capable of bringing it to a full stop within 25 feet (635 mm) on a level surface that is similar to the one on which it will be used and at full rated load and maximum design speed. Brakes shall be capable of being fixed in engagement to hold the full load stationary on a 25 percent grade.

**3320.7.2.2 Accidental starting.** All movement controls of every power buggy shall be so arranged or shielded that they cannot be inadvertently engaged or the buggy accidentally set in motion.

**3320.7.2.3 Parking on grades.** No power buggy shall be left unattended on any grade sufficiently steep to cause it to coast if free of engine and brake resistance.

**3320.7.2.4 Use on ramps, runways and platforms.** Power buggies shall not be used on ramps, runways, or platforms that do not meet the requirements of Section 3315

**3320.8 Lift and fork trucks.** Lift and fork trucks shall meet the requirements of Sections 3320.8.1 through 3320.8.4.

**3320.8.1 Load capacity.** A metal plate with readily legible etched or stamped figures giving the capacity rating in pounds shall be attached to every lift or fork truck.

**3320.8.2 Maintenance.** All parts and accessories of lift or fork trucks shall be kept in repair and with brakes adequate to maintain the fully loaded vehicle on any grade that may be encountered on the job.

**3320.8.3 Loading.** No lift or fork truck shall be loaded beyond its capacity rating. No hand-operated pallet truck loaded so that any point on the load is at a greater height than 4 feet 6 inches (114 mm) above the floor shall be moved by pushing unless handled by two persons.

**3320.8.4 Prohibited use.** No lift or fork truck shall be in motion when the loaded forks are elevated higher than necessary to clear obstructions, except as may be required for positioning, picking up, or depositing the load.

**3320.9 Hand propelled vehicles.** Hand propelled vehicles shall be constructed and braked to withstand the loads to be carried and shall be maintained in repair. Vehicles with loose parts shall not be used.

**3320.10 Mixing machines.** Where the public may have access to the working area near charging skips, standard guardrails that meet the requirements of Section 3307.8 shall be erected to enclose the area under the raised skip and the mixing machine. Each time before raising or lowering the charging skip, the operator shall ascertain that no one is in the danger zone.

**3320.11 Jacks.** Jacks shall meet the requirements of Sections 3320.11.1 through 3320.11.5.

**3320.11.1 Marking.** The rated capacity of every jack shall be legibly marked in a prominent location on the jack by casting or stamping. The manufacturer shall designate the intended supporting point of the load and the maximum permissible length of lever and force applied.

**3320.11.2 Overtravel to be limited.** Every jack shall, where practicable, be provided with a positive stop to prevent overtravel; otherwise an indicator to clearly show overtravel shall be provided on the jack.

**3320.11.3 Maintenance.** Lubrication and operation of jacks shall be in accordance with the recommendations of the manufacturer.

**3320.11.4 Foundations.** Jacks shall rest on a firm, level foundation adequate to support the load.

**3320.11.5 Blocking required.** When the object has been lifted to the desired height, blocking or cribbing shall be immediately placed under it if the jack does not have built-in safety devices such as stop-rings, locknuts, or place-in cylinder sleeves.

**3320.12 Cableways.** The construction, installation, inspection, maintenance and use of cableways shall be in conformance with rules promulgated by the commissioner.

**TABLE 3304.4.1.1 (1)**  
**MINIMUM SIZES OF TIMBER BRACING AND TIMBER SHEET PILING FOR**  
**TRENCHES FOUR FEET WIDE OR LESS<sup>a</sup>**

Depth of Trench, (ft.)	Sheet Piling		Stringers		Cross Bracing	
	Size (in.)	Horizontal Spacing (ft.)	Size (in.)	Vertical Spacing (ft.)	Size (in.)	Horizontal Spacing (ft.)
Hard and solid soil						
5-10.....	2 x 6	6	2 x 6	6	2 x 6	6
10-15.....	2 x 6	4	2 x 6	6	2 x 6	4
More than 15...	2 x 6	tight	4 x 8	4	4 x 8	6
Soil likely to crack or crumble						
5-10.....	2 x 6	3	2 x 6	5	2 x 6	5
10-15.....	2 x 6	2	2 x 6	4	2 x 6	4
More than 15...	2 x 6	tight	4 x 10	4	4 x 10	6
Soft, sandy filled-in loose soil						
5-10.....	2 x 6	tight	4 x 6	6	4 x 6	6
10-15.....	2 x 6	tight	4 x 6	5	4 x 6	6
More than 15...	2 x 6	tight	4 x 12	4	4 x 12	6
Where hydrostatic pressure exists						
To 10.....	2 x 6	tight	6 x 8	4	6 x 8	6
More than 10...	3 x 6	tight	6 x 10	4	6 x 10	6

**Note for Table 3304.4.1 (1):** <sup>a</sup> Steel sheet piling and bracing of equivalent strength may be substituted for wood sheet piling and timber bracing.

**Note:** For SI: 1 inch = 25.4 mm



**TABLE 3304.4.1.1 (2)**  
**MINIMUM SIZES OF TIMBER BRACING AND TIMBER SHEET PILING FOR**  
**TRENCHES FOUR TO EIGHT FEET WIDE<sup>a</sup>**

Depth of trench, (ft.)	Sheet Piling		Stringers		Cross Bracing	
	Size (in.)	Horizontal Spacing (ft.)	Size (in.)	Vertical Spacing (ft.)	Size (in.)	Horizontal Spacing (ft.)
Hard and solid soil						
5-10.....	2 X 6	6	4 X 6	4	4 X 6	6
10-20.....	2 X 6	tight	6 X 6	4	6 X 6	6
More than 20...	2 X 6	tight	6 X 8	4	6 X 8	6
Soil likely to crack or crumble						
5-10.....	2 X 6	3	4 X 6	4	4 X 6	6
10-20.....	2 X 6	tight	6 X 6	4	6 X 6	6
More than 20...	2 X 6	tight	6 X 8	4	6 X 8	6
Soft, sandy filled-in loose soil						
5-10.....	2 X 6	tight	4 X 6	4	4 X 6	6
10-20.....	2 X 6	tight	6 X 6	4	6 X 6	6
More than 20...	2 X 6	tight	6 X 8	4	6 X 8	6
Where hydrostatic pressure exists						
To 10.....	2 X 6	tight	6 X 8	4	6 X 8	6
More than 10...	3 X 6	tight	6 X 10	4	6 X 10	6

**Note for Table 3304.4.1 (2):** <sup>a</sup> Steel sheet piling and bracing of equivalent strength may be substituted for wood sheet piling and timber bracing.

**Note:** For SI: 1 inch = 25.4 mm

**TABLE 3314.5.2**  
**MAXIMUM PERMISSIBLE SPANS FOR TWO-INCH PLANK**  
**USED ON SCAFFOLDS**

Material	Full Thickness Undressed Lumber			Lumber of Nominal Thickness		
Working Load (psf).....	25	50	75	25	50	75
Permissible Span (ft.)...	10	8	6	8	6	5

**Note:** For SI: 1 inch = 25.4 mm

**TABLE 3314.12.1 (1)**  
**MINIMUM SIZE AND MAXIMUM SPACING OF MEMBERS OF SINGLE**  
**WOOD POLE LIGHT DUTY SCAFFOLDS**

Uniformly Distributed Load	Not to Exceed 25 psf				
Max. height of scaffold.....	20'	40'	60'		
				Top 60'	Lower Sect.
Poles or uprights (min.).....	2" x 4"	3" x 4"	4" x 4"	4" x 4"	4" x 6"
Pole foundation (min.).....			2" x 9"		
Max. pole spacing (longitudinal).			10' - 0"		
Max. width of scaffold.....			5' - 0"		
Bearers or putlogs (min.).....			3" x 4" or 2" x 6" (on edge)		
Ledgers (minimum):					
With 6'-0" pole space.....			1" x 6" (on edge)		
With 10'-0" pole space.....			1 1/4" x 9" (on edge)		
Vertical spacing of ledgers (max.)			7'-0"		
Non-supporting stringers.....			1" x 4"		
Tie-ins.....			1" x 4"		
Bracing.....			1" x 4"		
Planking:					
Not more than 6' span.....			1 1/4" x 9"		
Up to 10' span.....			2" x 9"		
Toeboards.....			1" x 6"		
Guard rails.....			2" x 4"		

**Note:** For SI: 1 inch = 25.4 mm

**TABLE 3314.12.1 (2)**  
**MINIMUM SIZE AND MAXIMUM SPACING OF MEMBERS OF SINGLE**  
**WOOD POLE MEDIUM DUTY SCAFFOLDS**

Uniformly Distributed Load	Not to exceed 50 psf				
Max. height of scaffold.....	20'	40'	60'	75'	
				Top 60'	Lower Sect.
Poles or uprights (min.).....	3" x 4" or 2" x 6"	4" x 4"	4" x 6"	4" x 6"	4" x 6"
Pole foundation (min.).....			2" x 9"		
Max. pole spacing (longitudinal)...			8' - 0"		
Max. width of scaffold.....		5' - 0"		8' - 0'	
Bearers or putlogs (min.).....	3" x 4" or 2" x 8" (on edge)		3" x 5" or 2" x 9" (on edge)		
Max. spacing of bearers or putlogs.			8' - 0"		
Ledgers (minimum).....			2" x 9" (on edge)		
Vertical spacing of ledgers (max.)..			7' - 0"		
Non-supporting stringers.....			1" x 6" or 1 1/4" x 4"		
Tie-ins.....			1" x 6"		
Bracing.....			1" x 6"		
Planking:					
Not more than 6' span.....			1 1/4" x 9"		
Up to 8' span.....			2" x 9"		
Toeboards.....			2" x 9"		
Guard rails.....			2" x 4"		

*\*\*As enacted but 6" x 6" probably intended.*

**Note:** For SI: 1 inch = 25.4 mm

**TABLE 3314.12.1 (3)**  
**MINIMUM SIZE AND MAXIMUM SPACING OF MEMBERS OF SINGLE**  
**WOOD POLE HEAVY DUTY SCAFFOLDS**

Uniformly Distributed Load	Not to exceed 75 psf				
Max. height of scaffold.....	20'	40'	60'	75'	
				Top 60'	Lower Sect.
Poles or uprights (min.).....	3" x 4" or 2" x 6"	4" x 4"	4" x 6"	4" x 6"	6" x 6"
Pole foundation (min.).....			2" x 9"		
Max. pole spacing (longitudinal)...			6' - 0"		
Max. width of scaffold.....		5' - 0"		8' - 0"	
Bearers or putlogs (min.).....		3" x 5"		3" x 6" or 2" x 9"	
Max. spacing of bearers or putlogs.			6' - 0"		
Ledgers (minimum).....			2" x 9" (on edge)		
Vertical spacing of ledgers (max.)..			7' - 0"		
Non-supporting stringers.....			2" x 4"		
Tie-ins.....			1" x 6"		
Bracing.....			1" x 6"		
Planking.....			2" x 9"		
Toeboards.....			2" x 9"		
Guard rails.....			2" x 4"		

**Note:** For SI: 1 inch = 25.4 mm

**TABLE 3314.12.1 (4)**  
**MINIMUM SIZE AND MAXIMUM SPACING OF MEMBERS OF**  
**INDEPENDENT WOOD POLE LIGHT DUTY SCAFFOLDS**

Uniformly Distributed Load	Not to exceed 25 psf				
Max. height of scaffold.....	20'	40'	60'	Top 60'	75' Lower Sect.
Poles or uprights (min.).....	2" x 4"	3" x 4" or 2" x 6"	4" x 4"	4" x 4"	4" x 6"
Pole foundation (min.).....			2" x 9"		
Max. pole spacing (longitudinal):					
With 1 1/4" x 9" ledgers.....			6' - 0"		
With 2" x 9" ledgers.....			10' - 0"		
Max. pole spacing (transverse).....			10' - 0" <sup>a</sup>		
Ledgers (minimum).....			1 1/4" x 9" (on edge) or 2" x 9"		
Vertical spacing of ledgers (max.)			7' - 0"		
Bearers (minimum).....			1 1/4" x 9" (on edge)		
Non-supporting stringers.....			1" x 4"		
Bracing.....			1" x 4"		
Planking:					
Not more than 6' span.....			1 1/4" x 9"		
Up to 10' span.....			2" x 9"		
Toeboards.....			1" x 6"		
Guard rails.....			2" x 4"		

**Note for Table 3314.12.1 (4):** <sup>a</sup> Total base dimension in both directions to be at least 25 per cent of height.

**Note:** For SI: 1 inch = 25.4 mm

**TABLE 3314.12.1 (5)**  
**MINIMUM SIZE AND MAXIMUM SPACING OF MEMBERS OF**  
**INDEPENDENT WOOD POLE MEDIUM DUTY SCAFFOLDS**

Uniformly Distributed Load	Not to exceed 50 psf				
Max. height of scaffold.....	20'	40'	60'	Top 60'	75' Lower Sect.
Poles or uprights (min.).....	3" x 4" or 2" x 6"	4" x 4"	4" x 6"	4" x 6"	6" x 6"
Pole foundation (min.).....			2" x 9"		
Max. pole spacing (longitudinal)...			8' - 0"		
Max. pole spacing (transverse).....			10' - 0" <sup>a</sup>		
Ledgers (minimum).....			2" x 9" (on edge)		
Vertical spacing of ledgers (max.)			6' - 0"		
Bearers (minimum).....			2" x 9" (on edge)		
Non-supporting stringers.....			1 1/4" x 4" or 1" x 6"		
Bracing.....			1" x 6"		
Planking:					
Not more than 6' span.....			1 1/4" x 9"		
More than 6' span.....			2" x 9"		
Toeboards.....			2" x 9"		
Guard rails.....			2" x 4"		

**Note for Table 3314.12.1 (5):** <sup>a</sup> Total base dimension in both directions to be at least 25 per cent of height.

**Note:** For SI: 1 inch = 25.4 mm

**TABLE 3314.12.1 (6)**  
**MINIMUM SIZE AND MAXIMUM SPACING OF MEMBERS OF**  
**INDEPENDENT WOOD POLE HEAVY DUTY SCAFFOLDS**

Uniformly Distributed Load	Not to exceed 75 psf				
	20'	40'	60'	75'	
				Top 60'	Lower Sect.
Max. height of scaffold.....	20'	40'	60'	4" x 6"	6" x 6"
Poles or uprights (min.).....	4" x 4"	4" x 4"	4" x 6"	4" x 6"	6" x 6"
Pole foundation (min.).....			2" x 9"		
Max. pole spacing (longitudinal)...			6' - 0" <sup>a</sup>		
Max. pole spacing (transverse).....			10' - 0" <sup>a</sup>		
Ledgers (minimum).....			2" x 9" (on edge)		
Vertical spacing of ledgers (max.)			5'-0"		
Bearers (minimum).....			2" x 9" (on edge)		
Non-supporting stringers.....			1 1/4" x 9"		
Bracing.....			1" x 6"		
Planking.....			2" x 9"		
Toeboards.....			2" x 9"		
Guard rails.....			2" x 4"		

**Note for Table 3314.12.1 (6):** <sup>a</sup> Total base dimension in both directions to be at least 25 per cent of height.

**Note:** For SI: 1 inch = 25.4 mm



**TABLE 3314.12.3**  
**SIZE AND NUMBER OF NAILS REQUIRED FOR**  
**SCAFFOLD CONSTRUCTION**

Thickness of Smaller Member (in.)	Trade Size of Nail	Length of Nail (in.)
1	8d	2 ½
2	20d	4
3	60d	6
4	—	8

Width of Smaller Member (in.)	Minimum Number of Nails Required
4	2
6	3
8	4
10	5
12	5

**Note:** For SI: 1 inch = 25.4 mm

**CHAPTER 34**  
**RESERVED**

## CHAPTER 35 REFERENCED STANDARDS

### AA

Aluminum Association  
900 - 19th Street N.W., Suite 300  
Washington, DC 20006

Standard  
Reference  
Number

Title

ADM 1—00

Aluminum Design Manual: Part 1-A Aluminum Structures, Allowable Stress Design; and Part 1-B  
—Aluminum Structures, Load and Resistance Factor Design of Buildings and Similar Type Structures

ASM 35—80.

Aluminum Sheet Metal Work in Building Construction

### AAMA

American Architectural Manufacturers Association  
1827 Waldon Office Square, Suite 104  
Schaumburg, IL 60173

Standard  
Reference  
Number

Title

1402—86

Standard Specifications for Aluminum Siding, Soffit and Fascia

101/I.S.2—97

Voluntary Specifications for Aluminum, Vinyl (PVC) and Wood Windows and Glass Doors

101/I.S.2/NAFS—02

Voluntary Performance Specification for Window, Skylights and Glass Doors

### ACI

American Concrete Institute  
P.O. Box 9094  
Farmington Hills, MI 48333-9094

Standard  
Reference  
Number

Title

216.1—97

Standard Method for Determining Fire Resistance of Concrete and Masonry Construction Assemblies

318—02

Building Code Requirements for Structural Concrete

530—02

Building Code Requirements for Masonry Structures

530.1—02

Specifications for Masonry Structures

TG/T1.1—01

Acceptance Criteria for Moment Frames Based on Testing

### AF&PA

American Forest & Paper Association  
1111 19th St, NW Suite 800  
Washington, DC 20036

Standard  
Reference  
Number

Title

AF&PA/ASCE 16—95

Standard for Load and Resistance Factor Design (LRFD) for Engineered Wood Construction

WCD No. 4—89

Plank and Beam Framing for Residential Buildings

WFCM—01

Frame Construction Manual for One-and Two-family Dwellings

T.R. No. 7—87

Basic Requirements for Permanent Wood Foundation System.

NDS—01

National Design Specification (NDS) for Wood Construction with 2001 Supplement

AF&PA—93

Span Tables for Joists and Rafters

### AHA

American Hardwood Association  
1210 West N.W. Highway  
Palatine, IL 60067

Standard  
Reference  
Number

Title

A135.4—95

Basic Hardboard

A135.5—95

Prefinished Hardboard Paneling.

A135.6—98

Hardboard Siding

A194.1—85

Cellulosic Fiber Board

### AISC

American Institute of Steel Construction  
One East Wacker Drive, Suite 3100  
Chicago, IL 60601-2001

Standard  
Reference

<u>Number</u>	<u>Title</u>
335—89s1	<u>Specification for Structural Steel Buildings—Allowable Stress Design and Plastic Design, including Supplement No.1, 2001</u>
<u>LRFD (1999)</u>	<u>Load and Resistance Factor Design Specification for Structural Steel Buildings</u>
<u>HSS (2000)</u>	<u>Load and Resistance Factor Design Specification for Steel Hollow Structural Sections</u>
341—02	<u>Seismic Provisions for Structural Steel Buildings</u>

## **AIISI**

American Iron and Steel Institute  
1140 Connecticut Avenue  
Suite 705  
Washington, DC 20036

<u>Standard Reference Number</u>	<u>Title</u>
<u>NASPEC 2001</u>	<u>North American Specification for Design of Cold-Formed Steel Structural Members</u>
<u>General Header</u>	<u>Standard for Cold-Formed Steel Framing-General Provisions, 2001</u>
<u>Truss</u>	<u>Standard for Cold-Formed Steel Framing-Header Design, 2001</u>
	<u>Standard for Cold-Formed Steel Framing-Truss Design, 2001</u>

## **AITC**

American Institute of Timber Construction  
Suite 140  
7012 S. Revere Parkway  
Englewood, CO 80112

<u>Standard Reference Number</u>	<u>Title</u>
<u>AITC A 190.1—92</u>	<u>Structural Glued Laminated Timber</u>
<u>AITC Technical Note 7—96</u>	<u>Calculation of Fire Resistance of Glued Laminated Timbers</u>
<u>AITC 104—84</u>	<u>Typical Construction Details</u>
<u>AITC 110—01</u>	<u>Standard Appearance Grades for Structural Glued Laminated Timber</u>
<u>AITC 112—93</u>	<u>Standard for Tongue-and-Groove Heavy Timber Roof Decking</u>
<u>AITC 113—01</u>	<u>Standard for Dimensions of Structural Glued Laminated Timber</u>
<u>AITC 117—01</u>	<u>Standard Specifications for Structural Glued Laminated Timber of Softwood Species— —Design Requirements—Standard Specifications for Structural Glued Laminated Timber of Softwood Species —Manufacturing Requirement</u>
<u>AITC 119—96</u>	<u>Standard Specifications for Structural Glued Laminated Timber of Hardwood Species</u>
<u>AITC 200—92</u>	<u>Inspection Manual</u>
<u>AITC 500—91</u>	<u>Determination of Design Values for Structural Glued Laminated Timber</u>

## **ALI**

Automotive Lift Institute  
P.O. Box 33116  
Indialantic, FL 32903-3116

<u>Standard Reference Number</u>	<u>Title</u>
<u>ALI ALCTV—98</u>	<u>Standard for Automotive Lifts—Safety Requirements for Construction, Testing and Validation (ANSI)</u>

## **ANSI**

American National Standards Institute  
25 West 43rd Street, Fourth Floor  
New York, NY 10036

<u>Standard Reference Number</u>	<u>Title</u>
----------------------------------	--------------

<u>A 13.1—96</u>	<u>Scheme for the Identification of Piping Systems</u>
<u>A 42.2—71</u>	<u>Portland Cement and Portland Cement Lime Plastering, Exterior (Stucco) and Interior</u>
<u>A 42.3—71</u>	<u>Lathing and Furring for Portland Cement and Portland Cement Lime Plastering, Exterior Stucco and Interior</u>
<u>A108.1A—99</u>	<u>Installation of Ceramic Tile in the Wet-set Method, with Portland Cement Mortar</u>
<u>A108.1B—99</u>	<u>Installation of Ceramic Tile. Quarry Tile on a Cured Portland Cement Mortar Setting Bed with Dry-set or Latex-Portland Mortar</u>
<u>A108.4—99</u>	<u>Installation of Ceramic Tile with Organic Adhesives or Water-cleanable Tile-Setting Epoxy Adhesive</u>
<u>A108.5—99</u>	<u>Installation of Ceramic Tile with Dry-set Portland Cement Mortar or Latex Portland Cement Mortar</u>
<u>A108.6—99</u>	<u>Installation of Ceramic Tile with Chemical-resistant, Water Cleanable Tile-setting-and-grouting Epoxy</u>
<u>A108.7—92</u>	<u>Specification for Electrically Conductive Ceramic Tile Installed with Conductive Dry-set Portland Cement Mortar</u>
<u>A108.8—99</u>	<u>Installation of Ceramic Tile with Chemical-resistant Furan Resin Mortar and Grout</u>
<u>A108.9—99</u>	<u>Installation of Ceramic Tile with Modified Epoxy Emulsion Mortar/Grout</u>
<u>A 108.10—99</u>	<u>Installation of Grout in Tilework</u>
<u>A 118.1—99</u>	<u>American National Standard Specifications for Dry-set Portland Cement Mortar</u>
<u>A 118.2—99</u>	<u>American National Standard Specifications for Conductive Dry-set Portland Cement Mortar</u>
<u>A 118.3—99</u>	<u>American National Standard Specifications for Chemical-resistant, Water-cleanable Tile-setting and -Grouting Epoxy and Water Cleanable Tile-setting Epoxy Adhesive</u>
<u>A 118.4—99</u>	<u>American National Standard Specifications for Latex-portland Cement Mortar</u>
<u>A 118.5—99</u>	<u>American National Standard Specifications for Chemical Resistant Furan Mortar and Grouts for Tile Installation</u>
<u>A 118.6—99</u>	<u>American National Standard Specifications for Cement Grouts for Tile Installation</u>
<u>A 118.8—99</u>	<u>American National Standard Specifications for Modified Epoxy Emulsion Mortar/Grout</u>
<u>A 136.1—99</u>	<u>American National Standard Specifications for Organic Adhesives for Installation of Ceramic Tile</u>
<u>A 137.1—88</u>	<u>American National Standard Specifications for Ceramic Tile</u>
<u>A 208.1—99</u>	<u>Particleboard</u>
<u>B 31.3—99</u>	<u>Process Piping—Including Addendum</u>
<u>Z 97.1—84 (R1994)</u>	<u>Safety Glazing Materials Used in Buildings-safety Performance Specifications and Methods of Test (Reaffirmed 1994)</u>

## **APA**

APA - Engineered Wood Association  
P.O. Box 11700  
Tacoma, WA 98411-0700

<u>Standard Reference Number</u>	<u>Title</u>
<u>APA PDS—97</u>	<u>Plywood Design Specification (revised 1998)</u>
<u>APA PDS Supplement 1—90</u>	<u>Design and Fabrication of Plywood Curved Panels (revised 1995)</u>
<u>APA PDS Supplement 2—92</u>	<u>Design and Fabrication of Plywood-lumber beams (revised 1998)</u>
<u>APA PDS Supplement 3—90</u>	<u>Design and Fabrication of Plywood Stressed-skin Panels (revised 1996)</u>
<u>APA PDS Supplement 4—90</u>	<u>Design and Fabrication of Plywood Sandwich Panels (revised 1993)</u>
<u>APA PDS Supplement 5—95</u>	<u>Design and Fabrication of All-plywood Beams (revised 1995)</u>
<u>EWS R540—96</u>	<u>Builders Tips: Proper Storage and Handling of Glulam Beams</u>
<u>EWS S475—99</u>	<u>Glued Laminated Beam Design Tables</u>
<u>EWS S560—99</u>	<u>Field Notching and Drilling of Glued Laminated Timber Beams</u>
<u>EWS T300—99</u>	<u>Glulam Connection Details</u>
<u>EWS X440—00</u>	<u>Product Guide-Glulam</u>
<u>EWS X445—97</u>	<u>Glulam in Residential Construction —Southern Edition</u>
<u>EWS X450—97</u>	<u>Glulam in Residential Construction —Western Edition</u>

## **ASAE**

American Society of Agricultural Engineers  
2950 Niles Road  
St. Joseph, MI 49085-9659

<u>Standard Reference Number</u>	<u>Title</u>
<u>EP 484.2 (1998)</u>	<u>Diaphragm Design of Metal-Clad, Post-Frame Rectangular Buildings</u>
<u>EP 486.1 (2000)</u>	<u>Shallow-Post Foundation Design</u>
<u>EP 559 (1997)</u>	<u>Design Requirements and Bending Properties for Mechanically Laminated Columns</u>

## **ASCE/SEI**

American Society of Civil Engineers  
Structural Engineering Institute  
1801 Alexander Bell Drive  
Reston, VA 20191-4400

<u>Standard Reference Number</u>	<u>Title</u>
----------------------------------	--------------

3—91	Standard Practice for the Construction and Inspection of Composite Slabs
5—02	Building Code Requirements for Masonry Structures
6—02	Specifications for Masonry Structures
7—02	Minimum Design Loads for Buildings and Other Structures
8—90	Standard Specification for the Design of Cold-formed Stainless Steel Structural Members
16—95	Standard for Load Resistance Factor Design (LRFD) for Engineered Wood Construction
19—96	Structural Applications of Steel Cables for Buildings
24—98	Flood Resistant Design and Construction
29—99	Standard Calculation Methods for Structural Fire Protection
32—01	Design and Construction of Frost Protected Shallow Foundations

## ASME

American Society of Mechanical Engineers  
Three Park Avenue  
New York, NY 10016-5990

Standard  
Reference  
Number

Title

A17.1—00	Safety Code for Elevators and Escalators
A18.1—99	Safety Standard for Platform Lifts and Stairway Chairlifts—with Addenda A18.1a-2001
A90.1—97	Safety Standard for Belt Manlifts—with Addenda A90.1a-99
B16.18—84 (R1994)	Cast Copper Alloy Solder Joint Pressure Fittings
B16.22—95	Wrought Copper and Copper Alloy Solder Joint Pressure Fittings—with Addenda B16.22a-98
B20.1—00	Safety Standard for Conveyors and Related Equipment

## ASTM

ASTM International  
100 Barr Harbor Drive  
West Conshohocken, PA 19428-2959

Standard  
Reference  
Number

Title

A 6/A 6M—01b	Specification for General Requirements for Rolled Steel, Structural Steel Bars, Plates, Shapes, and Sheet Piling
A 36/A 36M—00	Specification for Carbon Structural Steel
A 82—01	Specification for Steel Wire, Plain, for Concrete Reinforcement
A 123/A 123M—97e1	Specification for Zinc (Hot-Dip Galvanized) Coating on Iron and Steel Products
A 153—01a	Specification for Zinc Coating (Hot-Dip) on Iron and Steel Hardware
A 167—99	Specification for Stainless and Heat-Resisting Chromium-Nickel Steel Plate, Sheet and Strip
A 185—01	Specification for Steel Welded Wire Reinforcement, Plain for Concrete
A 252—E01	Specification for Welded and Seamless Steel Pipe Piles
A 283/A 283M—00	Specification for Low and Intermediate Tensile Strength Carbon Steel Plates
A 307—00	Specification for Carbon Steel Bolts and Studs, 60,000 psi Tensile Strength
A 416—99	Specification for Steel Strand, Uncoated Seven-Wire for Prestressed Concrete
A 421/A 421M—98	Specification for Uncoated Stress-Relieved Steel Wire for Prestressed Concrete
A 435/A 435M—90 (2001)	Specification for Straight-Beam Ultrasonic Examination of Steel Plates
A 496—01	Specification for Steel Wire, Deformed for Concrete Reinforcement
A 510—00	Specification for General Requirements for Wire Rods and Coarse Round Wire, Carbon Steel
A 568/A 568M—01	Specification for Steel, Sheet, Carbon, and High-Strength, Low-Alloy, Hot-Rolled and Cold-Rolled, General Requirements for

### ASTM—continued

A 572/A 572M—01	Specification for High-Strength Low-Alloy Columbium-Vanadium Structural Steel
A 588/A 588M—01	Specification for High-Strength Low-Alloy Structural Steel with 50 ksi (345 Mpa) Minimum Yield Point to 4 inches (100 mm) Thick
A 615/A 615M—00	Specification for Deformed and Plain Billet-Steel Bars for Concrete Reinforcement
A 641/A 641M—98	Specification for Zinc-coated (Galvanized) Carbon Steel Wire
A 653/A 653M—01a	Specification for Steel Sheet, Zinc-coated Galvanized or Zinc-iron Alloy-Coated Galvanized by the Hot-dip Process
A 706/A 706M—00	Specification for Low-Alloy Steel Deformed and Plain Bars for Concrete Reinforcement
A 706/A 706M—01	Specification for Low-Alloy Steel Deformed and Plain Bars for Concrete Reinforcement
A 722/A 722M—98	Specification for Uncoated High-Strength Steel Bar for Prestressing Concrete
A 755/A 755M—01	Specification for Steel Sheet, Metallic-Coated by the Hot-Dip Process and Prepainted by the Coil-Coating Process for Exterior Exposed Building Products
A 767/A 767M—00b	Specification for Zinc-coated (Galvanized) Steel Bars for Concrete Reinforcement
A 775/A 775M—01	Specification for Epoxy-Coated Steel Reinforcing Bars
A 792/A 792M—01a	Specification for Steel Sheet, 55% Aluminum-Zinc Alloy-Coated by the Hot-Dip Process
A 875M—99a	Specification for Steel Sheet Zinc-54% Aluminum Alloy-Coated by the Hot Dip Process
A 884—99	Specification for Epoxy-Coated Steel Wire and Welded Wire Fabric for Reinforcement
A 898/A 898M—91 (2001)	Specification for Straight Beam Ultrasonic Examination of Rolled Steel Shapes
A 899—91 (1999) S	Specification for Steel Wire Epoxy-Coated
A 913/A 913M—01	Specification for High-strength Low-Alloy Steel Shapes of Structural Quality, Produced by Quenching and Self-tempering Process (QST)
A 951—00	Specification for Masonry Joint Reinforcement
A 996/A 996M—00	Specification for Rail-Steel and Axle-Steel Deformed Bars Reinforcement for Concrete
A1008—01A	Specification for Steel, Sheet, Cold-Rolled, Carbon, Structural, High-Strength Low-Alloy and High-Strength Low-Alloy with

	<u>Improved Formability</u>
<u>B 42—98</u>	<u>Specification for Seamless Copper Pipe, Standard Sizes</u>
<u>B 43—98</u>	<u>Specification for Seamless Red Brass Pipe, Standard Sizes</u>
<u>B 68M—99</u>	<u>Specification for Seamless Copper Tube, Bright Annealed (Metric)</u>
<u>B 88—99e1</u>	<u>Specification for Seamless Copper Water Tube</u>
<u>B 101—01</u>	<u>Specification for Lead-Coated Copper Sheet and Strip for Building Construction</u>
<u>B 209—96</u>	<u>Specification for Aluminum and Aluminum Alloy Steel and Plate</u>
<u>B 251—97</u>	<u>Specification for General Requirements for Wrought Seamless Copper and Copper-alloy Tube</u>
<u>B 280—99e1</u>	<u>Specification for Seamless Copper Tube for Air Conditioning and Refrigeration Field Service</u>
<u>B 633—98</u>	<u>Specification for Electrodeposited Coatings of Zinc on Iron and Steel</u>
<u>C 5—97</u>	<u>Specification for Quicklime for Structural Purposes</u>
<u>C 22/C 22M—00</u>	<u>Specification for Gypsum</u>
<u>C 27—98</u>	<u>Specification for Standard Classification of Fireclay and High-Alumina Refractory Brick</u>
<u>C 31/31M—98</u>	<u>Practice for Making and Curing Concrete Test Specimens in the Field</u>
<u>C 33—99ae1</u>	<u>Specification for Concrete Aggregates</u>
<u>C 33—01a</u>	<u>Specification for Concrete Aggregates</u>
<u>C 34—96 (2001)</u>	<u>Specification for Structural Clay Load-bearing Wall Tile</u>
<u>C 35—95 (2001)</u>	<u>Specification for Inorganic Aggregates for Use in Gypsum Plaster</u>
<u>C 36/C 36M-01</u>	<u>Specification for Gypsum Wallboard</u>
<u>C 37/C 37M-01</u>	<u>Specification for Gypsum Lath</u>
<u>C 39—99ae1</u>	<u>Test Method for Compressive Strength of Cylindrical Concrete Specimens</u>
<u>C 42/C 42M—99</u>	<u>Test Method for Obtaining and Testing Drilled Cores and Sawed Beams of Concrete</u>
<u>C 55—01A</u>	<u>Specification for Concrete Brick</u>
<u>C 56—96 (2001)</u>	<u>Specification for Structural Clay Non-load Bearing Tile</u>
<u>C 59/C 59M—00</u>	<u>Specification for Gypsum Casting and Molding Plaster .</u>
<u>C 61/C 61M—00</u>	<u>Specification for Gypsum Keene's Cement</u>
<u>C 62—01</u>	<u>Specification for Building Brick (Solid Masonry Units Made from Clay or Shale)</u>
<u>C 67—02</u>	<u>Test Methods of Sampling and Testing Brick and Structural Clay Tile</u>
<u>C 73—99a</u>	<u>Specification for Calcium Silicate Face Brick (Sand-lime Brick)</u>
<u>C 79—01</u>	<u>Specification for Treated Core and Non-treated Core Gypsum Sheathing Board</u>
<u>C 90—01A</u>	<u>Specification for Loadbearing Concrete Masonry Units</u>
<u>C 91—01</u>	<u>Specification for Masonry Cement</u>
<u>C 94/C 94M—00</u>	<u>Specification for Ready-Mixed Concrete</u>
<u>C 126—99</u>	<u>Specification for Ceramic Glazed Structural Clay Facing Tile, Facing Brick, and Solid Masonry Units</u>
<u>C 140—01 ae1</u>	<u>Test Method Sampling and Testing Concrete Masonry Units and Related Units</u>
<u>C 150—99a</u>	<u>Specification for Portland Cement</u>
<u>C 150—01</u>	<u>Specification for Portland Cement</u>
<u>C 172—99</u>	<u>Practice for Sampling Freshly Mixed Concrete</u>
<u>C 199—84 (2000)</u>	<u>Test Method for Pier Test for Refractory Mortars</u>
<u>C 206—84 (1997)</u>	<u>Specification for Finishing Hydrated Lime</u>
<u>C 207—97</u>	<u>Specification for Hydrated Lime for Masonry Purposes</u>
<u>C 208—95</u>	<u>Specification for Cellulosic Fiber Insulating Board</u>
<u>C 212—00</u>	<u>Specification for Structural Clay Facing Tile</u>
<u>C 216—01A</u>	<u>Specification for Facing Brick (Solid Masonry Units Made from Clay or Shale)</u>
<u>C 270—01A</u>	<u>Specification for Mortar for Unit Masonry</u>

#### **ASTM—continued**

<u>C 315—00</u>	<u>Specification for Clay Flue Linings</u>
<u>C 317/C 317M—00</u>	<u>Specification for Gypsum Concrete</u>
<u>C 330—99</u>	<u>Specification for Lightweight Aggregates for Structural Concrete</u>
<u>C 331—01</u>	<u>Specification for Lightweight Aggregates for Concrete Masonry Units</u>
<u>C 406—00</u>	<u>Specification for Roofing Slate</u>
<u>C 442/C 442M—01</u>	<u>Specification for Gypsum Backing Board and Coreboard and Gypsum Shaftliner Board</u>
<u>C 472—99</u>	<u>Specification for Standard Test Methods for Physical Testing of Gypsum, Gypsum Plasters and Gypsum Concrete</u>
<u>C 473—00</u>	<u>Test Method for Physical Testing of Gypsum Panel Products</u>
<u>C 474—01</u>	<u>Test Methods for Joint Treatment Materials for Gypsum Board Construction</u>
<u>C 475—01</u>	<u>Specification for Joint Compound and Joint Tape for Finishing Gypsum Wallboard</u>
<u>C 476—01</u>	<u>Specification for Grout for Masonry</u>
<u>C 503—99e01</u>	<u>Specification for Marble Dimension Stone (Exterior)</u>
<u>C 514—01</u>	<u>Specification for Nails for the Application of Gypsum Board</u>
<u>C 516—E01</u>	<u>Specifications for Vermiculite Loose Fill Thermal Insulation.</u>
<u>C 547—00</u>	<u>Specification for Mineral Fiber Pipe Insulation</u>
<u>C 549—81 (1995)</u>	<u>Specification for Perlite Loose Fill Insulation</u>
<u>C 557—99</u>	<u>Specification for Adhesives for Fastening Gypsum Wallboard to Wood Framing</u>
<u>C 568—99</u>	<u>Specification for Limestone Dimension Stone</u>
<u>C 587—97</u>	<u>Specification for Gypsum Veneer Plaster</u>
<u>C 588/C 588M—01</u>	<u>Specification for Gypsum Base for Veneer Plasters</u>
<u>C 595—00</u>	<u>Specification for Blended Hydraulic Cements</u>
<u>C 595—01</u>	<u>Specification for Blended Hydraulic Cements</u>
<u>C 615—99</u>	<u>Specification for Granite Dimension Stone</u>
<u>C 616—99</u>	<u>Specification for Quartz-based Dimension Stone</u>
<u>C 618—99</u>	<u>Specification for Coal Fly Ash and Raw or Calcined Natural Pozzolan for Use as a Mineral Admixture in Concrete</u>
<u>C 629—99</u>	<u>Specification for Slate Dimension Stone</u>
<u>C 630/C 630M—01</u>	<u>Specification for Water-resistant Gypsum Backing Board</u>
<u>C 631—00</u>	<u>Specification for Bonding Compounds for Interior Gypsum Plastering</u>
<u>C 635—00</u>	<u>Specification for the Manufacturer, Performance, and Testing of Metal Suspension Systems for Acoustical Tile and Lay-in Panel Ceilings</u>

C 636—96	Practice for Installation of Metal Ceiling Suspension Systems for Acoustical Tile and Lay-in Panels
C 645—00	Specification for Nonstructural Steel Framing Members
C 652—01A	Specification for Hollow Brick (Hollow Masonry Units Made from Clay or Shale)
C 685/ C 685M—98a	Specification for Concrete Made by Volumetric Batching and Continuous Mixing
C 744—99	Specification for Prefaced Concrete and Calcium Silicate Masonry Units
C 754—00	Specification for Installation of Steel Framing Members to Receive Screw-attached Gypsum Panel Products
C 836—00	Specification for High-solids Content, Cold Liquid-applied Elastomeric Waterproofing Membrane for Use with Separate Wearing Course
C 840—01	Specification for Application and Finishing of Gypsum Board
C 841—99	Specification for Installation of Interior Lathing and Furring
C 842—99	Specification for Application of Interior Gypsum Plaster
C 843—99	Specification for Application of Gypsum Veneer Plaster
C 844—99	Specification for Application of Gypsum Base to Receive Gypsum Veneer Plaster
C 845—96	Specification for Expansive Hydraulic Cement
C 847—00	Specification for Metal Lath
C 887—(2001)	Specification for Packaged, Dry Combined Materials for Surface Bonding Mortar
C 897—00	Specification for Aggregate for Job-Mixed Portland Cement-Based Plasters
C 926—98a	Specification for Application of Portland Cement Based-Plaster
C 931/C 931M—01	Specification for Exterior Gypsum Soffit Board
C 932—98a	Specification for Surface-applied Bonding Agents for Exterior Plastering
C 933—A(2001)	Specification for Welded Wire Lath
C 946—91 (2001)	Specification for Practice for Construction of Dry-stacked, Surface-bonded Walls
C 954—00	Specification for Steel Drill Screws for the Application of Gypsum Panel Products or Metal Plaster Bases to Steel Studs from 0.033 inch (0.84 mm) to 0.112 inch (2.84 mm) in Thickness
C 955—01	Specification for Load Bearing Transverse and Axial Steel Studs, Runners Tracks, and Bracing or Bridging, for Screw Application of Gypsum Panel Products and Metal Plaster Bases
C 956—97	Specification for Installation of Cast-in-place Reinforced Gypsum Concrete
C 957—98	Specification for High-solids Content, Cold Liquid-applied Elastomeric Waterproofing Membrane with Integral Wearing Surface
C 960—97	Specification for Predecorated Gypsum Board
C 989—99	Specification for Ground Granulated Blast-furnace Slag for Use in Concrete and Mortars
C1002—01	Specification for Steel Self-Piercing Tapping Screws for the Application of Gypsum Panel Products or Metal Plaster Bases to Wood Studs or Steel Studs
C1007—00	Specification for Installation of Load Bearing (Transverse and Axial) Steel Studs and Related Accessories
C1019—00B	Test Method of Sampling and Testing Grout
C1029—96	Specification for Spray-applied Rigid Cellular Polyurethane Thermal Insulation
C1032—96	Specification for Woven Wire Plaster Base
C1047—99	Specification for Accessories for Gypsum Wallboard and Gypsum Veneer Base
C1063—99	Specification for Installation of Lathing and Furring to Receive Interior and Exterior Portland Cement Based Plaster

#### ASTM—continued

C1088—01A	Specification for Thin Veneer Brick Units Made from Clay or Shale
C1157—00	Performance Specification for Hydraulic Cement
C1167—96	Specification for Clay Roof Tiles
C1177/C1177M—01	Specification for Glass Mat Gypsum Substrate for Use as Sheathing
C1178/C1178M—01	Specification for Glass Mat Water-resistant Gypsum Backing Panel
C1186—99	Specification for Flat Nonasbestos Fiber Cement Sheets
C1218/ C1218M—99	Test Method for Water-soluble Chloride in Mortar and Concrete
C1240—00E1	Specification for Silica Fume for Use as a Mineral Admixture in Hydraulic-Cement Concrete, Mortar and Grout
C1261—98	Specification for Firebox Brick for Residential Fireplaces
C1278/C 1278M—01	Specification for Fiber-reinforced Gypsum Panels
C1280—99	Specification for Application of Gypsum Sheathing
C1283—00	Practice for Installing Clay Flue Liners
C1314—02	Test Method for Compressive Strength of Masonry Prisms
C1328—00	Specification for Plastic (Stucco Cement)
C1329—00	Specification for Mortar Cement
C1395/1395M—01	Specification for Gypsum Ceiling Board
D 25—99E01	Specification for Round Timber Piles
D 41—E01	Specification for Asphalt Primer Used in Roofing, Dampproofing and Waterproofing
D 43—00	Coal Tar Primer Used in Roofing, Dampproofing and Waterproofing
D 56—01	Test Method for Flash Point By Tag Closed Tester
D 86—01e01	Test Method for Distillation of Petroleum Products
D 93—00	Test Method for Flash Point By Pensky-Martens Closed Cup Tester
D 224—89 (1996)	Specification for Smooth-Surfaced Asphalt Roll Roofing (Organic Felt)
D 225—01	Specification for Asphalt Shingles (Organic Felt) Surfaced with Mineral Granules
D 226—97a	Specification for Asphalt-Saturated Organic Felt Used in Roofing and Waterproofing
D 227—97a	Specification for Coal-tar-saturated Organic Felt Used in Roofing and Waterproofing
D 249—89 (1996)	Specification for Asphalt Roll Roofing (Organic Felt) Surfaced with Mineral Granules
D 312—00	Specification for Asphalt Used in Roofing
D 371—89 (1996)	Specification for Asphalt Roll Roofing (Organic Felt) Surfaced with Mineral Granules: Wide-selvage
D 422—98	Test Method for Particle-size Analysis of Soils
D 450—00	Specification for Coal-tar Pitch Used in Roofing, Dampproofing and Waterproofing
D 635—98	Test Method for Rate of Burning and/or Extent and Time of Burning of Self-Supporting Plastics in a Horizontal Position
D1143—81 (1994) E01	Test Method for Piles Under Static Axial Compressive Load
D1227—00	Specification for Emulsified Asphalt Used as a Protective Coating for Roofing
D1557—00	Test Method for Laboratory Compaction Characteristics of Soil Using Modified Effort (56,000 ft-lb/ft <sup>3</sup> (2,700 KN m/m <sup>3</sup> ))
D1586—99	Specification for Penetration Test and Split-barrel Sampling of Soils



D1761—88(2000)	Test Method for Mechanical Fasteners in Wood
D1863—93 (2000)	Specification for Mineral Aggregate Used on Built-up Roofs
D1929—96 (2001)E01	Test Method for Determining Ignition Properties of Plastics
D1970—01	Specification for Self-Adhering Polymer Modified Bituminous Sheet Materials Used as Steep Roof Underlayment for Ice Dam Protection
D2166—00	Test Method for Unconfined Compressive Strength of Cohesive Soil
D2178—97a	Specification for Asphalt Glass Felt Used in Roofing and Waterproofing
D2216—98	Test Method for Laboratory Determination of Water(Moisture) Content of Soil and Rock by Mass
D2487—00	Practice for Classification of Soils for Engineering Purposes (Unified Soil Classification System)
D2626—97b	Specification for Asphalt Saturated and Coated Organic Felt Base Sheet Used in Roofing
D2822—91(97) el	Specification for Asphalt Roof Cement
D2823—90(97) el	Specification for Asphalt Roof Coatings
D2843—99	Test for Density of Smoke from the Burning or Decomposition of Plastics
D2850—95(1999)	Test Method for Unconsolidated, Undrained Triaxial Compression Test on Cohesive Soils
D2898—94 (1999)	Test Methods for Accelerated Weathering of Fire-Retardant-Treated Wood for Fire Testing
D3019—e01(Supp)	Specification for Lap Cement Used with Asphalt Roll Roofing, Nonfibered, Asbestos Fibered, and Nonasbestos Fibered
D3161—99a	Test Method for a Wind Resistance of Asphalt Shingles (Fan Induced Method)
D3201—94 (1998) el	Test Method for Hygroscopic Properties of Fire-Retardant Treated Wood and Wood-base Products
D3278—96e01	Test Methods for Flash Point of Liquids by Small Scale Closed-Cup Apparatus
D3462—E01	Specification for Asphalt Shingles Made from Glass Felt and Surfaced with Mineral Granules
D3468—99	Specification for Liquid-applied Neoprene and Chlorosulfonated Polyethylene Used in Roofing and Waterproofing
D3679—01c(Supp)	Specification for Rigid Poly [Vinyl Chloride (PVC) Siding]
D3689—90 (1995)	Method for Testing Individual Piles Under Static Axial Tensile Load
D3737—01B	Practice for Establishing Allowable Properties for Structural Glued Laminated Timber (Glulam)
D3746—85 (1996) el	Test Method for Impact Resistance of Bituminous Roofing Systems
D3747—E01	Specification for Emulsified Asphalt Adhesive for Adhering Roof Insulation
D3909—97b	Specification for Asphalt Roll Roofing (Glass Felt) Surfaced with Mineral Granules
D4022—00	Specification for Coal Tar Roof Cement, Asbestos Containing
D4272—99	Test Method for Total Energy Impact of Plastic Films by Dart Drop
D4318—00	Test Methods for Liquid Limit, Plastic Limit, and Plasticity Index of Soils
D4434—96	Specification for Poly (Vinyl Chloride) Sheet Roofing
D4479—00	Specification for Asphalt Roof Coatings - Asbestos-Free

#### ASTM—continued

D4586—00	Specification for Asphalt Roof Cement, Asbestos-Free
D4601—98	Specification for Asphalt-Coated Glass Fiber Base Sheet Used in Roofing
D4637—96	Specification for EPDM Sheet Used in Single-ply Roof Membrane
D4829—95	Test Method for Expansion Index of Soils
D4869—93	Specification for Asphalt-Saturated (Organic Felt) Underlayment Used in Steep Slope Roofing
D4897—01	Specification for Asphalt-Coated Glass Fiber Venting Base Sheet Used in Roofing
D4990—97a	Specification for Coal Tar Glass Felt Used in Roofing and Waterproofing
D4945—00	Test Method for High-Strain Dynamic Testing of Piles P
D5019—96	Specification for Reinforced Nonvulcanized Polymeric Sheet Used in Roofing Membrane
D5055—00	Specification for Establishing and Monitoring Structural Capacities of Prefabricated Wood I-joists
D5456—01AE01	Specification for Evaluation of Structural Composite Lumber Products
D5516—99a	Test Method of Evaluating the Flexural Properties of Fire-Retardant Treated Softwood Plywood Exposed to the Elevated Temperatures
D5643—00	Specification for Coal Tar Roof Cement, Asbestos-Free
D5664—01	Test Methods for Evaluating the Effects of Fire-Retardant Treatment and Elevated Temperatures on Strength Properties of Fire-Retardant Treated Lumber
D5665—99a	Specification for Thermoplastic Fabrics Used in Cold-Applied Roofing and Waterproofing
D5726—98	Specification for Thermoplastic Fabrics Used in Hot-Applied Roofing and Waterproofing
D6083—97a	Specification for Liquid Applied Acrylic Coating Used in Roofing
D6162—00A	Specification for Styrene Butadiene Styrene (SBS) Modified Bituminous Sheet Materials Using a Combination of Polyester and Glass Fiber Reinforcements
D6163—00 E01	Specification for Styrene Butadiene Styrene (SBS) Modified Bituminous Sheet Materials Using Glass Fiber Reinforcements
D6164—00	Specification for Styrene Butadiene Styrene (SBS) Modified Bituminous Sheet Metal Materials Using Polyester Reinforcements
D6222—98	Specification for Atactic Polypropylene (APP) Modified Bituminous Sheet Materials Using Polyester Reinforcements
D6223—98	Specification for Atactic Polypropylene (APP) Modified Bituminous Sheet Materials Using a Combination of Polyester and Glass Fiber Reinforcements
D6298—98	Specification for Fiberglass Reinforced Styrene-Butadiene-Styrene (SBS) Modified Bituminous Sheets with a Factory Applied Metal Surface
D6305—99e1	Practice for Calculating Bending Strength Design Adjustment Factors for Fire-Retardant-Treated Plywood Roof Sheathing
E 84—01	Test Methods for Surface Burning Characteristics of Building Material
E 90—99	Test Method for Laboratory Measurement of Airborne Sound Transmission Loss of Building Partitions and Elements
E 96—00	Test Method for Water Vapor Transmission of Materials
E 108—00	Test Methods for Fire Tests of Roof Coverings
E 119—00	Test Methods for Fire Tests of Building Construction and Materials
E 136—99	Test Method for Behavior of Materials in a Vertical Tube Furnace at 750°C
E 328—86	Methods for Stress Relaxation for Materials and Structures
E 330—97	Test Method for Structural Performance of Exterior Windows, Curtain Walls, and Doors by Uniform Static Air Pressure Difference
E 331—00	Test Method for Water Penetration of Exterior Windows, Skylights, Doors, and Curtain Walls by Uniform Static Air Pressure Difference
E 492—90 (1996)e1	Test Method for Laboratory Measurement of Impact Sound Transmission Through Floor-ceiling Assemblies Using the Tapping Machine
E 605—00	Test Method for Thickness and Density of Sprayed Fire-resistive Material (SFRM) Applied to Structural Members
E 681—01	Test Methods for Concentration Limits of Flammability of Chemical Vapors and Gases

E 736—00	Test Method for Cohesion/Adhesion of Sprayed Fire-resistive Materials Applied to Structural Members
E 814—00	Test Method of Fire Tests of Through-penetration Firestops
E 970—00	Test Method for Critical Radiant Flux of Exposed Attic Floor Insulation Using a Radiant Heat Energy Source
E1300—00	Practice for Determining Load Resistance of Glass in Buildings
E1592—01	Test Method for Structural Performance of Sheet Metal Roof and Siding Systems by Uniform Static Air Pressure Difference
E1602—01	Guide for Construction of Solid Fuel-Burning Masonry Heaters
E1886—97	Test Method for Performance of Exterior Windows, Curtain Wall, Doors and Storm Shutters Impacted by Missiles and exposed to Cyclic Pressure Differentials
E1966—00	Test Method for Fire-Resistant Joint Systems
E1996—01	Specification for Performance of Exterior Windows, Glazed Curtain Walls, Doors and Storm Shutters Impacted by Windborne Debris in Hurricanes
F 547—01	Terminology of Nails for Use with Wood and Wood-base Materials
F1346—91 (1996)	Performance Specification for Safety Covers and Labeling Requirements for All Covers for Swimming Pools, Spas and Hot Tubs
F1667—01A	Specification for Driven Fasteners: Nails, Spikes, and Staples
G 152—00A	Practice for Operating Open Flame Carbon Arc Light Apparatus for Exposure of Nonmetallic Materials
G 154—00A	Practice for Operating Fluorescent Light Apparatus for UV Exposure of Nonmetallic Materials
G 155—00A	Practice for Operating Xenon Arc Light Apparatus for Exposure of Non-Metallic Materials

## **AWPA**

American Wood-Preservers' Association  
P.O. Box 5690  
Grandbury, TX 76049

<u>Standard Reference Number</u>	<u>Title</u>
C1—00	All Timber Products—Preservative Treatment by Pressure Processes
C2—01	Lumber, Timber, Bridge Ties and Mine Ties—Preservative Treatment by Pressure Processes
C3—99	Piles—Preservative Treatment by Pressure Processes
C4—99	Poles—Preservative Treatment by Pressure Processes
C9—00	Plywood—Preservative Treatment by Pressure Processes
C14—99	Wood for Highway Construction, Pressure Treatment by Pressure Process
C15—00	Wood for Commercial-Residential Construction Preservative Treatment by Pressure Process
C16—00	Wood Used on Farms, Pressure Treatment by Pressure Process
C18—99	Standard for Pressure Treated Material in Marine Construction
C22—96	Lumber and Plywood for Permanent Wood Foundations—Preservative Treatment by Pressure Processes
C23—00	Round Poles and Posts Used in Building Construction—Preservative Treatment by Pressure Processes
C24—96	Sawn Timber Piles Used to Support Residential and Commercial Structures
C28—99	Standard for Preservative Treatment by Pressure Process of Structural Glued Laminated Members and Laminations before Gluing
C31—00	Lumber Used Out of Contact with the Ground and Continuously Protected from Liquid Water—Treatment by Pressure Processes
C33—00	Standard for Preservative Treatment of Structural Composite Lumber by Pressure Processes
M4—01	Standard for the Care of Preservative-Treated Wood Products
P1/13—01	Standard for Creosote Preservative
P2—01	Standard for Creosote Solutions
P5—01	Standard for Waterborne Preservatives
P8—01	Standard for Oil-borne Preservatives
P9—01	Standard for Solvents and Formulations for Organic Preservative Systems

## **AWS**

American Welding Society  
550 N.W. LeJeune Road  
Miami, FL 33126

<u>Standard Reference Number</u>	<u>Title</u>
D1.1—00	Structural Welding Code—Steel
D1.3—98	Structural Welding Code—Sheet Steel
D1.4—98	Structural Welding Code—Reinforcing Steel

## **BHMA**

Builders Hardware Manufacturers' Association  
355 Lexington Avenue, 17th Floor  
New York, NY 10017-6603

<u>Standard Reference Number</u>	<u>Title</u>
A 156.10—99	American National Standard for Power Operated Pedestrian Doors
A 156.19—97	American National Standard for Power Assist and Low Energy Operated Doors

## **CGSB**

Canadian General Standards Board  
222 Queens Street  
14th Floor, Suite 1402  
Ottawa, Ontario, Canada KIA 1G6

<u>Standard Reference</u>
---------------------------

<u>Number</u>	<u>Title</u>
37-GP-52M (1984)	Roofing and Waterproofing Membrane, Sheet Applied, Elastomeric CAN/CGSB
37.54—95	Polyvinyl Chloride Roofing and Waterproofing Membrane.
37-GP-56M (1980)	Membrane, Modified, Bituminous, Prefabricated, and Reinforced for Roofing—with December 1985 Amendment

## **CPSC**

Consumer Product Safety Commission  
4330 East West Highway  
Bethesda, MD 20814-4408

<u>Standard Reference Number</u>	<u>Title</u>
16 CFR Part 1201(1977)	Safety Standard for Architectural Glazing Material
16 CFR Part 1209 (1979)	Interim Safety Standard for Cellulose Insulation
16 CFR Part 1404 (1979)	Cellulose Insulation
16 CFR Part 1500 (1991)	Hazardous Substances and Articles; Administration and Enforcement Regulations
16 CFR Part 1500.44 (2001)	Method for Determining Extremely Flammable and Flammable Solids
16 CFR Part 1507 (2001)	Fireworks Devices
16 CFR Part 1630 (2000)	Standard for the Surface Flammability of Carpets and Rugs

## **CSSB**

Cedar Shake and Shingle Bureau  
P.O. Box 1178  
Sumas, WA 98295-1178

<u>Standard Reference Number</u>	<u>Title</u>
CSSB—97	Grading and Packing Rules for Western Red Cedar Shakes and Western Red Shingles of the Cedar Shake and Shingle Bureau

## **DASMA**

Door and Access Systems Manufacturers Association International  
1300 Summer Avenue  
Cleveland, OH 44115-2851

<u>Standard Reference Number</u>	<u>Title</u>
107—97	Room Fire Test Standard for Garage Doors Using Foam Plastic Insulation

## **DOC**

U.S. Department of Commerce  
National Institute of Standards and Technology  
100 Bureau Drive Stop 3460  
Gaithersburg, MD 20899

<u>Standard Reference Number</u>	<u>Title</u>
PS-1—95	Construction and Industrial Plywood
PS-2—92	Performance Standard for Wood-based Structural-use Panels
PS 20—99	American Softwood Lumber Standard

## **DOL**

U.S. Department of Labor  
c/o Superintendent of Documents  
U.S. Government Printing Office  
Washington, DC 20402-9325

<u>Standard Reference Number</u>	<u>Title</u>
29 CFR Part 1910.1000 (1974)	Air Contaminants

## **DOTn**

U.S. Department of Transportation  
c/o Superintendent of Documents  
U.S. Government Printing Office  
Washington, DC 20402-9325

<u>Standard Reference Number</u>	<u>Title</u>
49 CFR Part 172 (1999)	Hazardous Materials Tables, Special Provisions, Hazardous Materials Communications, Emergency Response Information and Training Requirements
49 CFR Parts 173 (1999)	Specification of Transportation of Explosive and Other Dangerous Articles, UN 0335, UN 0336 Shipping Containers

# FEMA

Federal Emergency Management Agency  
Federal Center Plaza  
500 C Street S.W.  
Washington, DC 20472

## Standard Reference

Number	Title
Pub 302 NEHRP	Recommended Provisions for Seismic Regulations for New Buildings and Other Structures
TB11-01	Crawlspace Construction for Buildings Located in Special Flood Hazard Areas

# FM

Factory Mutual  
Standards Laboratories Department  
1151 Boston-Providence Turnpike  
Norwood, MA 02062

## Standard Reference

Number	Title
4450 (1989)	Approval Standard for Class 1 Insulated Steel Deck Roofs— with Supplements thru 7/92
4470 (1992)	Approval Standard for Class 1 Roof Covers
4880 (2001)	American National Standard for Evaluating Insulated Wall or Wall and Roof/Ceiling Assemblies, Plastic Interior Finish Materials, Plastic Exterior Building Panels, Wall/Ceiling Coating Systems, Interior and Exterior Finish Systems.

# GA

Gypsum Association  
810 First Street N.E. #510  
Washington, DC 20002-4268

## Standard Reference

Number	Title
GA 216—00	Application and Finishing of Gypsum Board
GA 600—00	Fire-resistance Design Manual, 16th Edition, April, 2000

# HPVA

Hardwood Plywood Veneer Association  
1825 Michael Faraday Drive  
Reston, VA 20190-5350

## Standard Reference

Number	Title
HP-1—2000	The American National Standard for Hardwood and Decorative Plywood

# ICC

International Code Council  
5203 Leesburg Pike, Suite 600  
Falls Church, VA 22041

## Standard Reference

Number	Title
ICC/ANSI A117.1—2003	Accessible and Usable Buildings and Facilities
ICC 300—02	ICC Standard on Bleachers, Folding and Telescopic Seating, and Grandstands
ICC EC—03	ICC Electrical Code™
IEBC—03	International Existing Building Code™
IECC—03	International Energy Conservation Code®
IFC—03	International Fire Code®
IFGC—03	International Fuel Gas Code®
IMC—03	International Mechanical Code®
IPC—03	International Plumbing Code®
IPMC—03	International Property Maintenance Code®
IPSDC—03	International Private Sewage Disposal Code®
IRC—03	International Residential Code®
IUWIC—03	International Urban—Wildland Interface Code™
SBCCI SSTD 10—99	Standard for Hurricane Resistant Residential Construction
SBCCI SSTD 11—97	Test Standard for Determining Wind Resistance of Concrete or Clay Roof Tiles UBC Standard 18-2 Expansion Index Test

# NAAMM

National Association of Architectural  
Metal Manufacturers  
8 South Michigan Ave  
Chicago, IL 60603

## Standard Reference

Number	Title
FP 1001—90	Guide Specifications for Design of Metal Flag Poles

## **NCMA**

National Concrete Masonry Association  
2302 Horse Pen Road  
Herndon, VA 22071-3499

Standard Reference Number	Title
TEK 5-8A (1996)	Details for Concrete Masonry Fire Walls

## **NFPA**

National Fire Protection Association  
1 Batterymarch Park  
Quincy, MA 02269-9101

Standard Reference Number	Title
11—98	Low Expansion Foam
11A—99	Medium- and High-expansion Foam Systems
12—00	Carbon Dioxide Extinguishing Systems
12A—97	Halon 1301 Fire Extinguishing Systems
13—99	Installation of Sprinkler Systems
13D—99	Installation of Sprinkler Systems in One- and Two-family Dwellings and Manufactured Homes
13R—99	Installation of Sprinkler Systems in Residential Occupancies Up to and Including Four Stories in Height
14—00	Installation of Standpipe, Private Hydrants and Hose System
16—99	Installation Foam-Water Sprinkler and Foam-Water Spray Systems
17A—98	Wet Chemical Extinguishing Systems
30—00	Flammable and Combustible Liquids Code
32—00	Dry-cleaning Plants
40—97	Storage and Handling of Cellulose Nitrate Motion Picture Film
61—99	Prevention of Fires and Dust Explosions in Agricultural and Food Product Facilities
72—2002	National Fire Alarm Code
80—99	Fire Doors and Fire Windows
85—01	Boiler and Combustion System Hazards Code (Note: NFPA 8503 has been incorporated into NFPA 85)
101—00	Life Safety Code
110—99	Emergency and Standby Power Systems
111—01	Stored Electrical Energy Emergency and Standby Power Systems
120—99	Coal Preparation Plants
231C—98	Rack Storage of Materials
252—99	Standard Methods of Fire Tests of Door Assemblies
253—00	Test for Critical Radiant Flux of Floor Covering Systems Using a Radiant Heat Energy Source
257—00	Standard for Fire Test for Window and Glass Block Assemblies
259—98	Test Method for Potential Heat of Building Materials
265—98	Standard Method of Fire Tests for Evaluating Room Fire Growth Contribution of Textile Wall Coverings
268—96	Standard Test Method for Determining Ignitibility of Exterior Wall Assemblies Using a Radiant Heat Energy Source
285—98	Standard Method of Test for the Evaluation of Flammability Characteristics of Exterior Non-load-bearing Wall Assemblies Containing Combustible Components
286—00	Standard Method of Fire Test for Evaluating Contribution of Wall and Ceiling Interior Finish to Room Fire Growth
409—95	Standard on Aircraft Hangers
418—01	Standard for Heliports
651—98	Machining and Finishing of Aluminum and the Production and Handling of Aluminum Powders
654—00	Prevention of Fire & Dust Explosions from the Manufacturing, Processing, and Handling of Combustible Particulate Solids
655—93	Prevention of Sulfur Fires and Explosions
664—98	Prevention of Fires Explosions in Wood Processing and Woodworking Facilities
701—99	Standard Methods of Fire Tests for Flame-Propagation of Textiles and Films
704—96	Standard System for the Identification of the Hazards of Materials for Emergency Response
1124—98	Manufacture, Transportation, and Storage of Fireworks and Pyrotechnic Articles
2001—00	Clean Agent Fire Extinguishing Systems

## **NIST**

National Institute of Standards and Technology  
U.S. Department of Commerce  
100 Bureau Dr. – Stop 3460  
Gaithersburg, MD 20899-3460

Standard Reference Number	Title
BMS 71—41	Fire Tests of Wood and Metal-framed Partitions
TRBM-44—46	Fire-resistance and Sound-insulation Ratings for Walls, Partitions and Floors

# PCI

Precast Prestressed Concrete Institute  
175 W. Jackson Boulevard, Suite 1859  
Chicago, IL 60604-9773

Standard  
Reference  
Number

Title

---

MNL 124—89	<u>Design for Fire Resistance of Precast Prestressed Concrete</u>
MNL 128—01	<u>Recommended Practice for Glass Fiber Reinforced Concrete Panels</u>

# PTI

Post-Tensioning Institute  
1717 W. Northern Avenue, Suite 114  
Phoenix, AZ 85021

Standard  
Reference  
Number

Title

---

PTI 1996	<u>Design and Construction of Post-tensioned Slabs-on-ground, 2nd Edition</u>
----------	---

# RMA

Rubber Manufacturers Association  
1400 K. Street, N.W. #900  
Washington, DC 20005

Standard  
Reference  
Number

Title

---

RP-1—90	<u>Minimum Requirements for Non-reinforced Black EPDM Rubber Sheets</u>
RP-2—90	<u>Minimum Requirements for Fabric-reinforced Black EPDM Rubber Sheets</u>
RP-3—85	<u>Minimum Requirements for Fabric-reinforced Black Polychloroprene Rubber Sheets</u>

# RMI

Rack Manufacturers Institute  
8720 Red Oak Boulevard, Suite 201  
Charlotte, NC 28217

Standard  
Reference  
Number

Title

---

RMI (1997)	<u>Design, Testing and Utilization of Industrial Steel Storage Racks</u>
------------	--

# SJI

Steel Joist Institute  
3127 10th Avenue, North  
Myrtle Beach, SC 29577-6760

Standard  
Reference  
Number

Title

---

SJI—1994	<u>Standard Specification for Joist Girders</u>
K-Series Specification —1994	<u>Standard Specification for Open Web Steel Joists, K Series.</u>
SJI—1994	<u>Standard Specification for Longspan Steel Joists, LH Series and Deep Longspan Steel Joists, DLH Series</u>

# SPRI

Single-Ply Roofing Institute  
77 Rumford Ave.  
Suite 3-B  
Waltham, MA 02453

Standard  
Reference  
Number

Title

---

ES-1—98	<u>Wind Design Standard for Edge Systems Used with Low Slope Roofing Systems</u>
RP-4—88	<u>Wind Design Guide for Ballasted Single-ply Roofing Systems</u>

# TIA

Telecommunications Industry Association  
2500 Wilson Boulevard  
Arlington, VA 22201-3834

Standard  
Reference  
Number

Title

---

TIA/EIA-222-F—96	<u>Structural Standards for Steel Antenna Towers and Antenna Supporting Structures</u>
------------------	--

# **TMS**

The Masonry Society  
3970 Broadway, Unit 201-D  
Boulder, CO 80304-1135

---

Standard  
Reference  
Number

Title

---

0216—97	Standard Method for Determining Fire Resistance of Concrete and Masonry Construction Assemblies
402—02	Building Code Requirements for Masonry Structures
602—02	Specification for Masonry Structures

---

# **TPI**

Truss Plate Institute  
583 D'Onofrio Drive, Suite 200  
Madison, WI 53719

---

Standard  
Reference  
Number

Title

---

TPI 1—2002	National Design Standards for Metal-Plate-Connected Wood Truss Construction
------------	---

---

# **UL**

Underwriters Laboratories  
333 Pfingsten Road  
Northbrook, IL 60062-2096

---

Standard  
Reference  
Number

Title

---

10A—98	Tin Clad Fire Doors—with Revisions through July, 1998
10B—97	Fire Tests of Door Assemblies
10C—98	Positive Pressure Fire Tests of Door Assemblies—with Revisions thru November, 2001
14B—98	Sliding Hardware for Standard Horizontally Mounted Tin Clad Fire Doors—with Revisions through July, 2000
14C—96	Swinging Hardware for Standard Tin Clad Fire Doors Mounted Singly and in Pairs
103—98	Factory-Built Chimneys, for Residential Type and Building Heating Appliances—with Revisions through March 1999
127—99	Factory-Built Fireplaces—with Revisions through November, 1999
268—96	Smoke Detectors for Fire Protective Signaling Systems—with Revisions through January, 1999
300—96	Fire Testing of Fire Extinguishing Systems for Protection of Restaurant Cooking Areas—with Revisions through December, 1998
555—96	Fire Dampers—with Revisions through October, 2000
555C—96	Ceiling Dampers
555S—99	Smoke Dampers—with Revisions through December, 1999
580—94	Test for Uplift Resistance of Roof Assemblies—with Revisions through February, 1998
641—95	Type L Low-Temperature Venting Systems—with Revisions through April, 1999
790—97	Tests for Fire Resistance of Roof Covering Materials—with Revisions through July, 1998
864—96	Control Units for Fire Protective Signaling Systems—with Revisions through March, 1999
1040—96	Fire Test of Insulated Wall Construction—with Revisions thru April, 2001
1256—98	Fire Test of Roof Deck Construction—with Revisions through March, 2000

---

**UL—continued**

---

1479—94	Fire Tests of Through-Penetration Firestops
1715—97	Fire Test of Interior Finish Material
1777—98	Chimney Liners—with Revisions through July, 1998
1784—95	Air Leakage Tests of Door Assemblies
1897—98	Uplift Tests for Roof Covering Systems—with Revisions through December, 1999
1975—96	Fire Test of Foamed Plastics Used for Decorative Purposes
2079—98	Tests for Fire Resistance of Building Joint Systems
2200—98	Stationary Engine Generator Assemblies

---

# **ULC**

Underwriters Laboratories of Canada  
7 Crouse Road  
Scarborough, Ontario, Canada M1R3A9

---

Standard  
Reference  
Number

Title

---

S102.2—M88	Standard Method of Test for Surface Burning Characteristics of Floor Coverings, and Miscellaneous Materials and Assemblies
------------	--

---

# **USC**

United States Code  
c/o Superintendent of Documents  
U.S. Government Printing Office  
Washington, DC 20402-9325

---

Standard  
Reference

---

<u>Number</u>	<u>Title</u>
18 USC	Part 1, Ch.40 Importation, Manufacture, Distribution and Storage of Explosive Materials

---

## **WDMA**

Window and Door Manufacturers Association  
1400 East Touhy Avenue #470  
Des Plaines, IL 60018

---

Standard  
Reference

<u>Number</u>	<u>Title</u>
<u>AAMA/NWDA</u>	
<u>101/I.S.2—97</u>	<u>Voluntary Specifications for Aluminum, Vinyl (PVC) and Wood Windows and Glass Doors</u>
<u>AAMA/NWDA</u>	
<u>101/I.S.2/NAFS—02</u>	<u>Voluntary Performance Specification for Window, Skylights and Glass Doors</u>

## **WRI**

Wire Reinforcement Institute, Inc.  
203 Loudon Street, S.W.  
2nd Floor, Suite 203C  
Leesburg, VA 22075

---

Standard  
Reference

<u>Number</u>	<u>Title</u>
<u>WRI/CRSI—96</u>	<u>Design of Slab-on-ground Foundations</u>



**APPENDIX A**  
**RESERVED**

**APPENDIX B**  
**RESERVED**

**APPENDIX C**  
**RESERVED**

**APPENDIX D**  
**FIRE DISTRICTS**

**SECTION BC D101**  
**GENERAL**

**D101.1 Scope.** The provisions of this appendix shall regulate the division of the city of New York into geographical territories known as fire districts and control the occupancy groups and construction classes permitted in the fire districts. Wherever reference is made to the Fire District, it shall be construed to mean the fire districts designated and referred to in this appendix.

**D101.2 Establishment of fire district.** The following city areas are hereby established as being inside the fire districts:

1. All of the borough of Manhattan.
2. All of the borough of Bronx.
3. All of the borough of Brooklyn.
4. Such portions of the boroughs of Staten Island and Queens as are indicated on the “fire district maps” as per Figures D101.2 (1) and D101.2 (2).

**FIGURE D101.2 (1)**  
**FIRE DISTRICT MAPS**  
**BOROUGH OF RICHMOND**  
**(Figure D101.2(1) attached to end of document)**

**FIGURE D101.2 (2)**  
**FIRE DISTRICT MAPS**  
**BOROUGH OF QUEENS**  
**(Figure D101.2(2) attached to end of document)**

**SECTION BC D102**  
**BUILDING RESTRICTIONS**

**D102.1 Types of construction permitted.** Every building hereafter erected within the fire district, or located partially in the fire district pursuant to Section D104.1, shall be either Type I, II, III or IV.

**D102.2 Other specific requirements.**

**D102.2.1 Group H-1 prohibited.** Group H-1 occupancies shall be prohibited from location within the fire district.

**D102.2.2 Construction type.** Every building, room, or space hereafter altered or erected shall be constructed as required based on the type of construction indicated in Chapter 6 except as provided in Section D102.2.4.

**D102.2.3 Roof covering.** Roof covering in the fire district shall conform to the requirements of Class A or B roof coverings as defined in Section 1505.

**D102.2.4 Structural fire rating.** The fire-resistance rating of walls, floors, roofs and their supporting structural members shall comply with Table 601 of Chapter 6, but in no event shall such rating be less than 1-hour.

**Exceptions:**

1. Buildings of Type IV construction.
2. Buildings equipped throughout with an automatic sprinkler system in accordance with Section 903.3.1.1.
3. Automobile parking structures.
4. Buildings surrounded on all sides by a permanently open space of not less than 30 feet (9144 mm).
5. Partitions complying with Section 603.1 (8).

**D102.2.5 R-1 and R-2 Occupancies.** No building or space classified in occupancy group R-1 or R-2 may be located on a lot containing a building classified in construction Type IIB, VA or VB.

**SECTION BC D103**  
**CHANGES TO BUILDINGS**

**D103.1 Existing buildings within the fire district.** An existing building shall not hereafter be increased in height or area unless it is of a type of construction permitted for new buildings within the fire district or is altered to comply with the requirements for such type of construction. Nor shall any existing building be hereafter extended on any side, nor square footage or floors added within the existing building unless such modifications are of a type of construction permitted for new buildings within the fire district.

**D103.2 Other alterations.** Nothing in Section D103.1 shall prohibit other alterations within the fire district provided there is no change of occupancy that is otherwise prohibited and provided the fire hazard is not increased by such alteration.

**D103.3 Moving buildings.** Buildings shall not hereafter be moved into the fire district or to another lot in the fire district unless the building is of a type of construction permitted in the fire district.

**SECTION BC D104**  
**BUILDINGS LOCATED PARTIALLY**  
**IN THE FIRE DISTRICT**

**D104.1 General.** Any building located partially in the fire district, so that it is both inside and outside the district, shall be of a type of construction required for the fire district if more than 25 percent of the total floor area of the building is located inside the fire district.

**SECTION BC D105**  
**EXCEPTIONS TO RESTRICTIONS**  
**IN FIRE DISTRICT**

**D105.1 General.** The preceding provisions of this appendix shall not apply in the following instances:

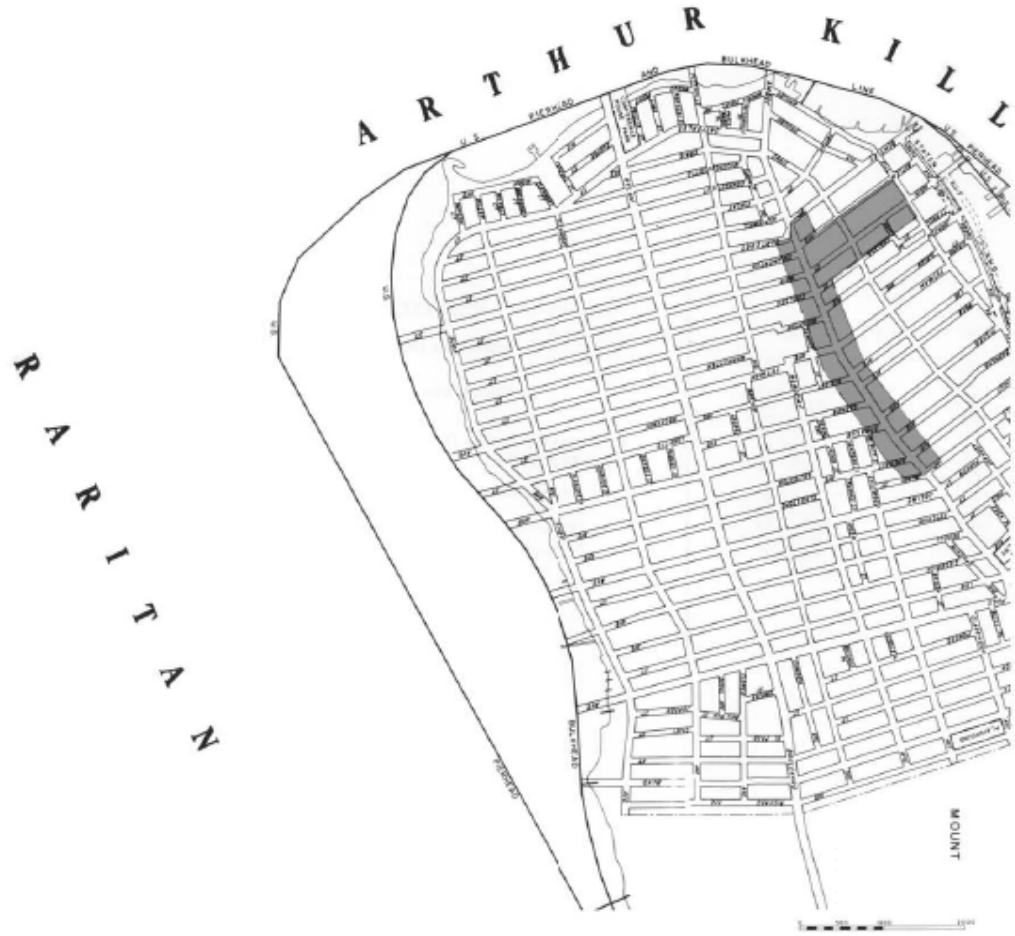
1. Temporary platforms, reviewing stands, and similar miscellaneous structures used for a limited period of time, subject to the approval of the commissioner.
2. Fences not over 6 feet (1829 mm) high.
3. Water towers, tank structures, and trestles may be constructed of wood planking and timbers of dimensions not less than as required for Type IV construction when not over 35 feet (10 668 mm) high and having an exterior separation of at least 30 feet (9144 mm).
4. Detached greenhouses accessory to a one- or two-family dwelling located on the same lot at least 6 feet (1829 mm) from any lot line or building walls and not exceeding 14 feet (4267 mm) in height.
5. Porches on dwellings not over one story in height, and not over 10 feet (3048 mm) wide from the face of the building, provided such porch does not come within 5 feet (1524 mm) of any property line.
6. Sheds open on a long side not over 15 feet (4572 mm) high and 500 square feet (46 m<sup>2</sup>) in area.
7. Existing one- and two-family dwellings of a type of construction not permitted in the fire district can be extended 25 percent of the floor area existing at the time of inclusion in the fire district by any type of construction permitted by this code.
8. Wood decks less than 600 square feet (56 m<sup>2</sup>) where constructed of 2-inch (51 mm) nominal wood, pressure treated for exterior use.
9. One- or two-family detached or semi-detached dwellings of two stories or less in

height and 2,500 square feet (232 m<sup>2</sup>) or less in area located within zoning Districts R-2 through R-5 may be constructed or reconstructed of construction Type VA, or if damaged for any cause only the damaged portions shall be required to be reconstructed to conform to Type VA construction. In addition, one-family dwellings located within zoning District R-1 anywhere in the city, may be constructed of Type VB construction in conformance with the area and height limits established by Table 503 of Chapter 5.

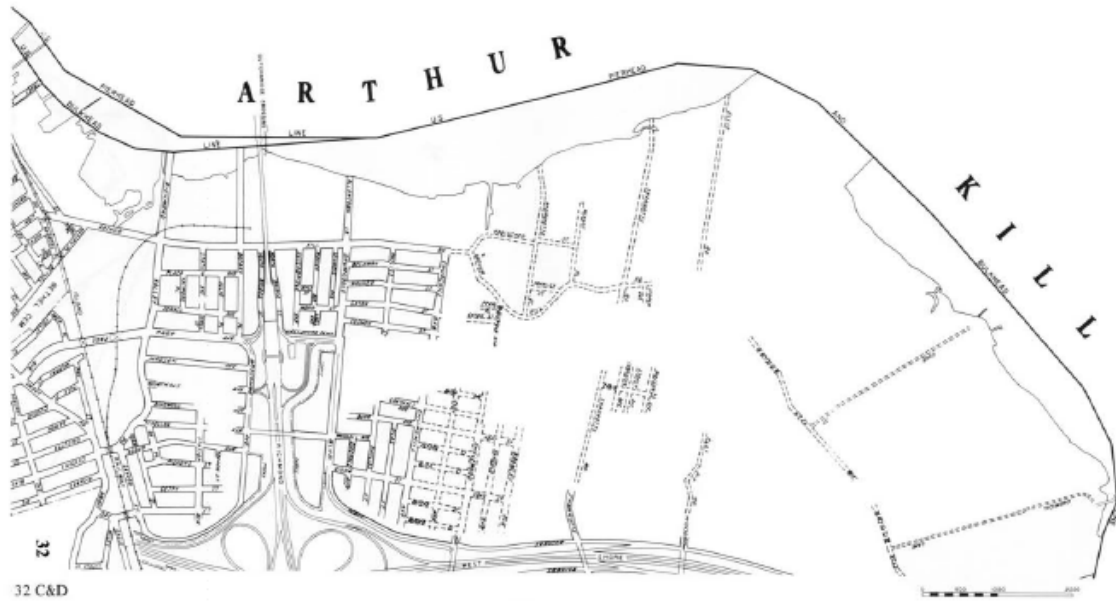
10. An accessory building or structure used as an office or similar use for an open parking lot located on the same lot, may be constructed of Type VA or VB construction provided its area shall be limited to 150 square feet (14 m<sup>2</sup>) and height of 10 feet (3048 mm) maximum. Such structure shall be located not less than 6 feet (1829 mm) from any lot line or buildings on the same lot.

**SECTION BC D106**  
**RESERVED**

**FIGURE D101.2 (1)**  
**FIRE DISTRICT MAPS**  
**BOROUGH OF RICHMOND**







32 C&D

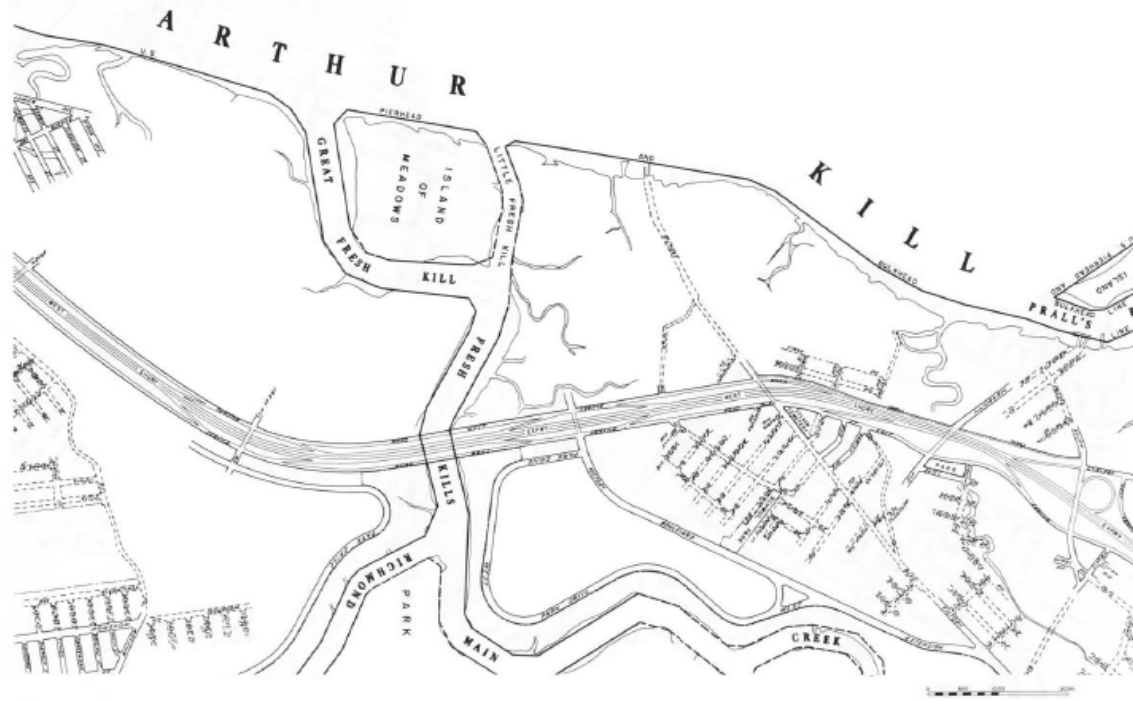


B A Y

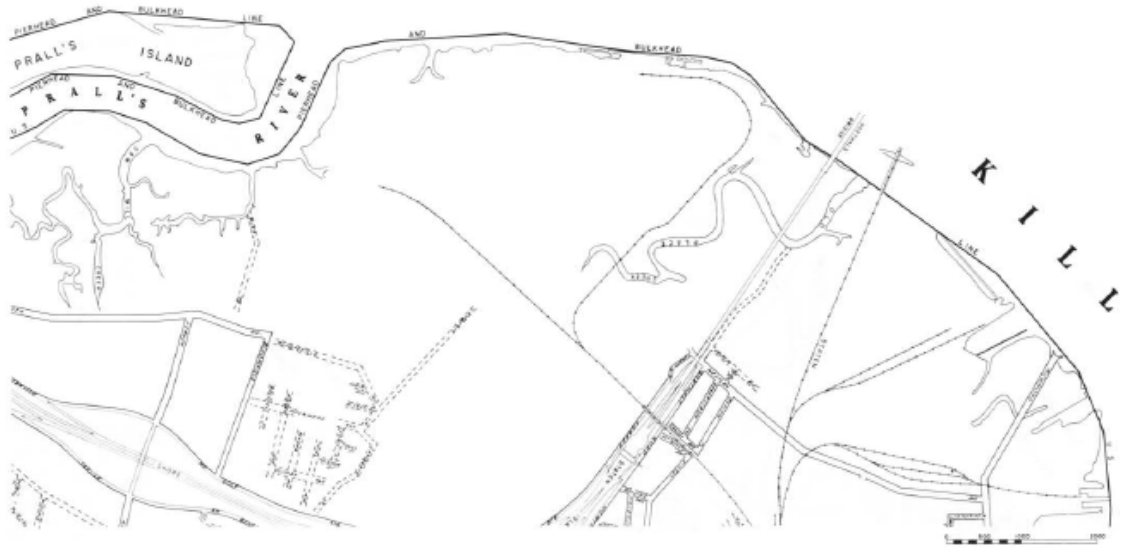


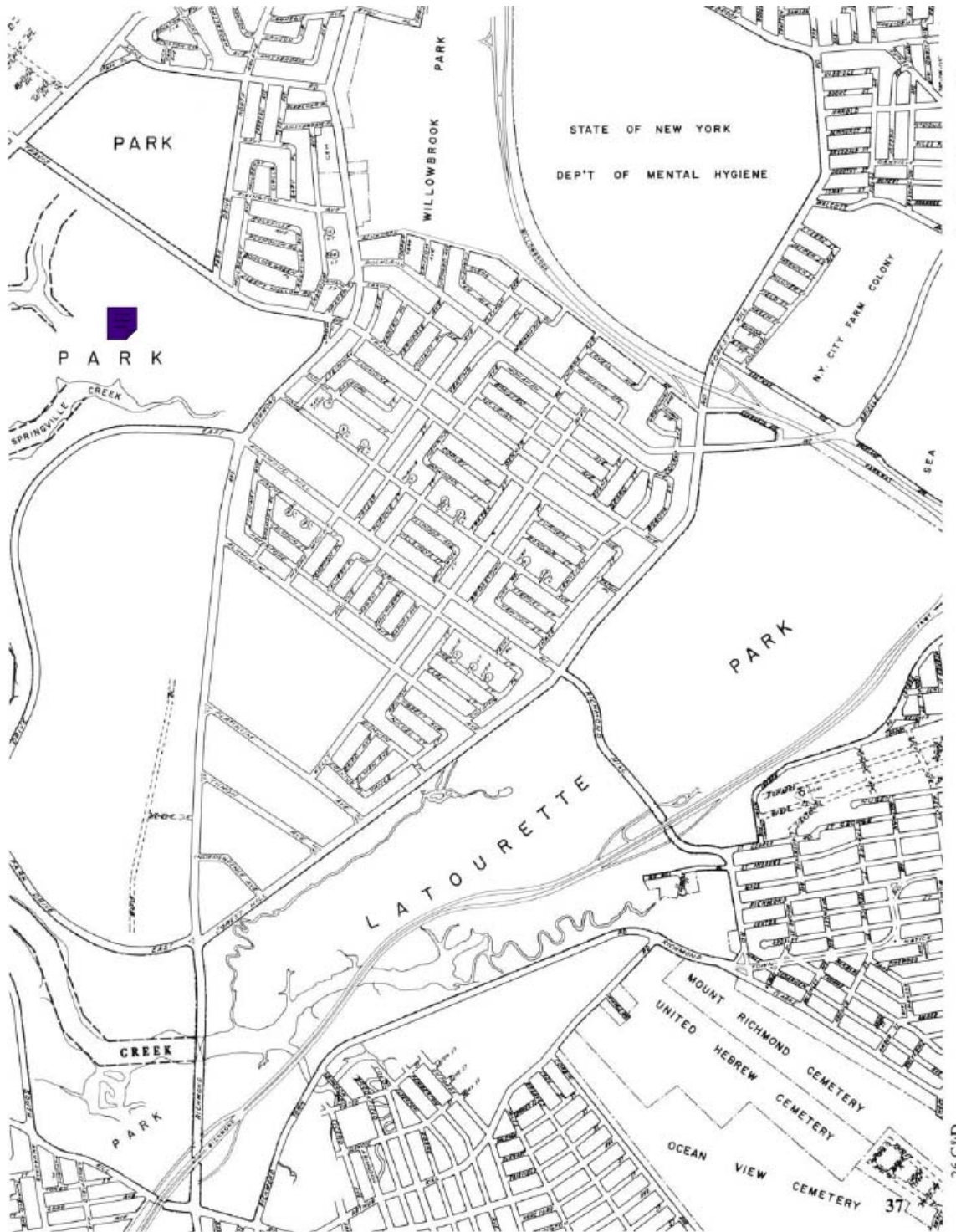


MOUNT LORETTO

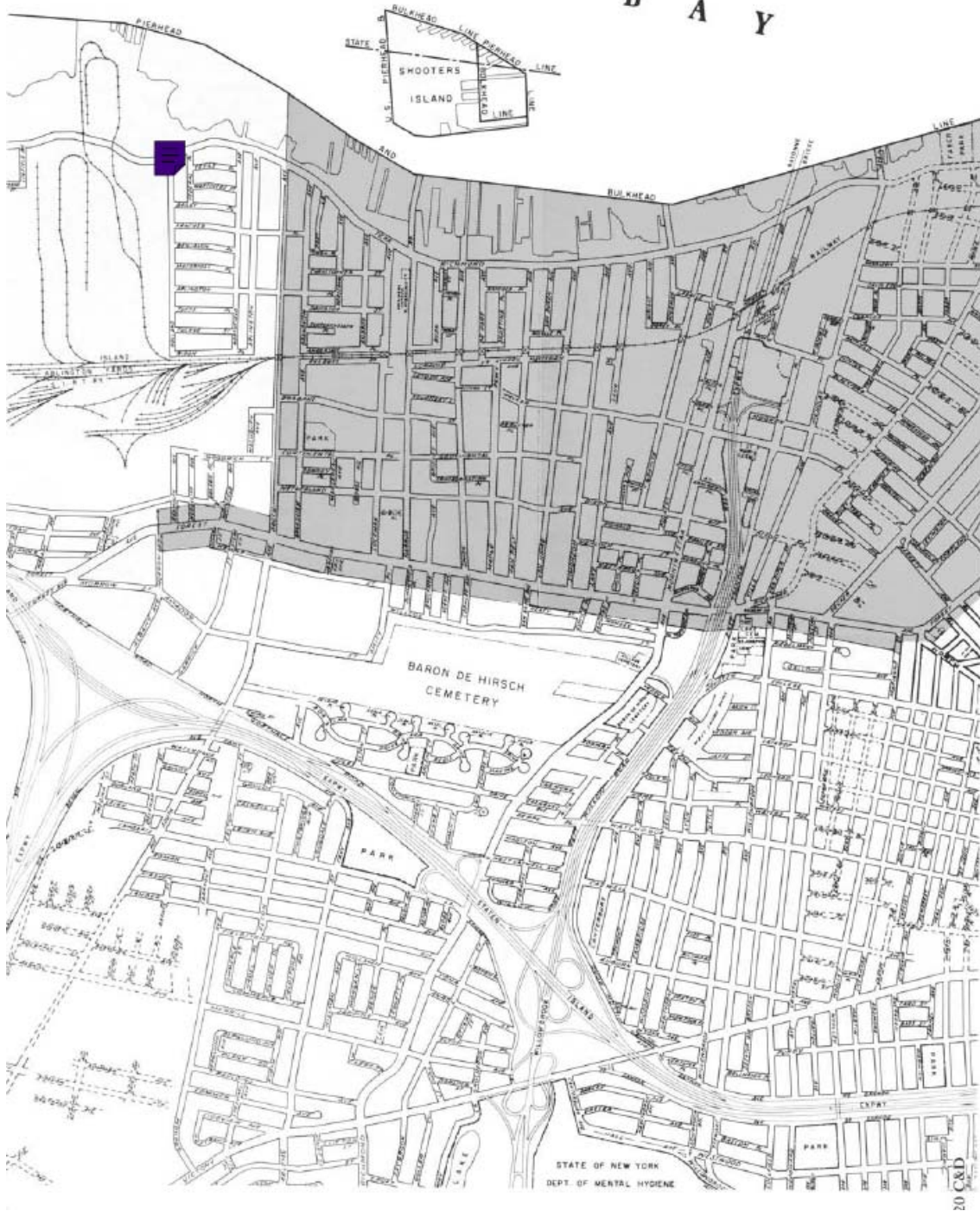


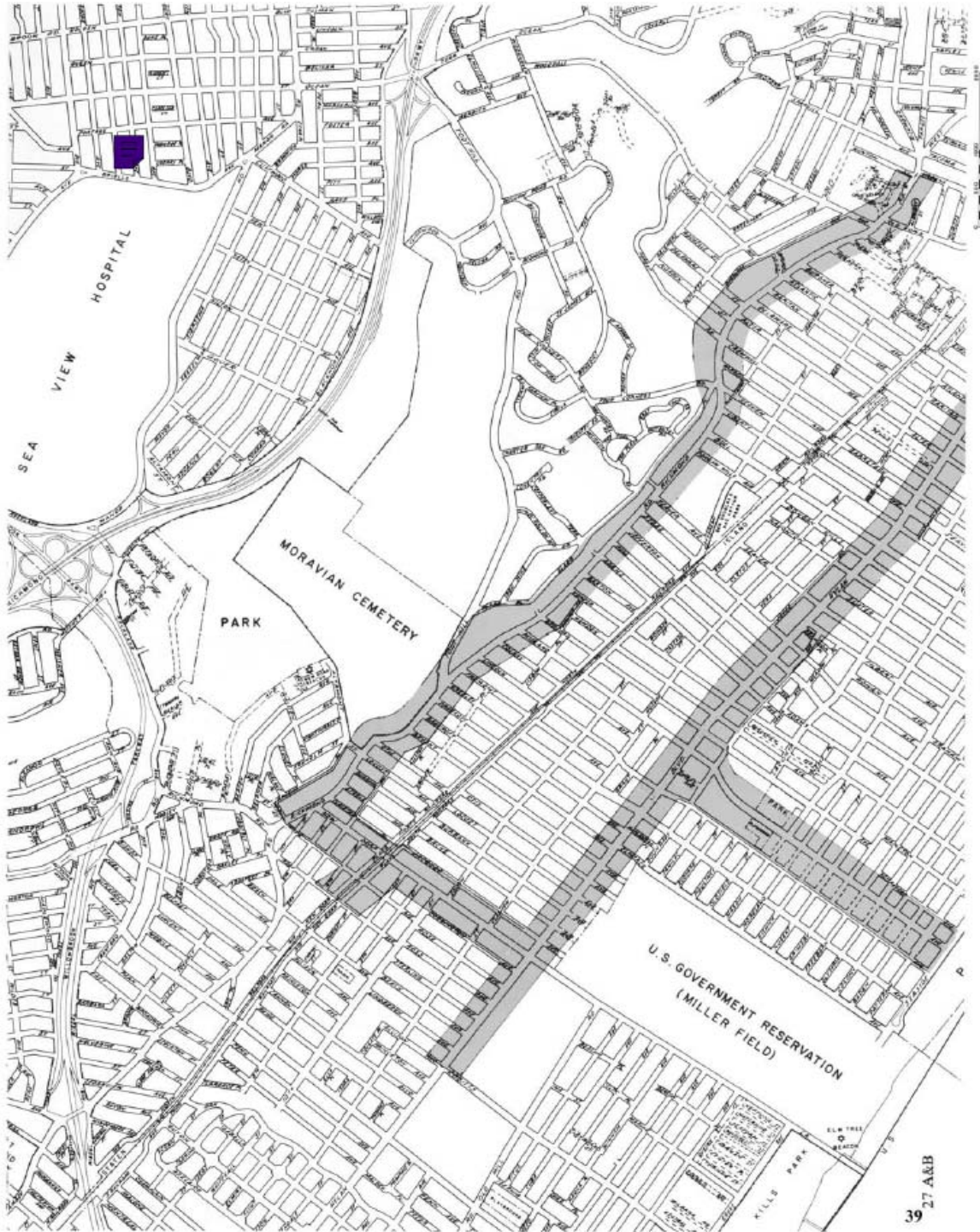
# A R T H U R





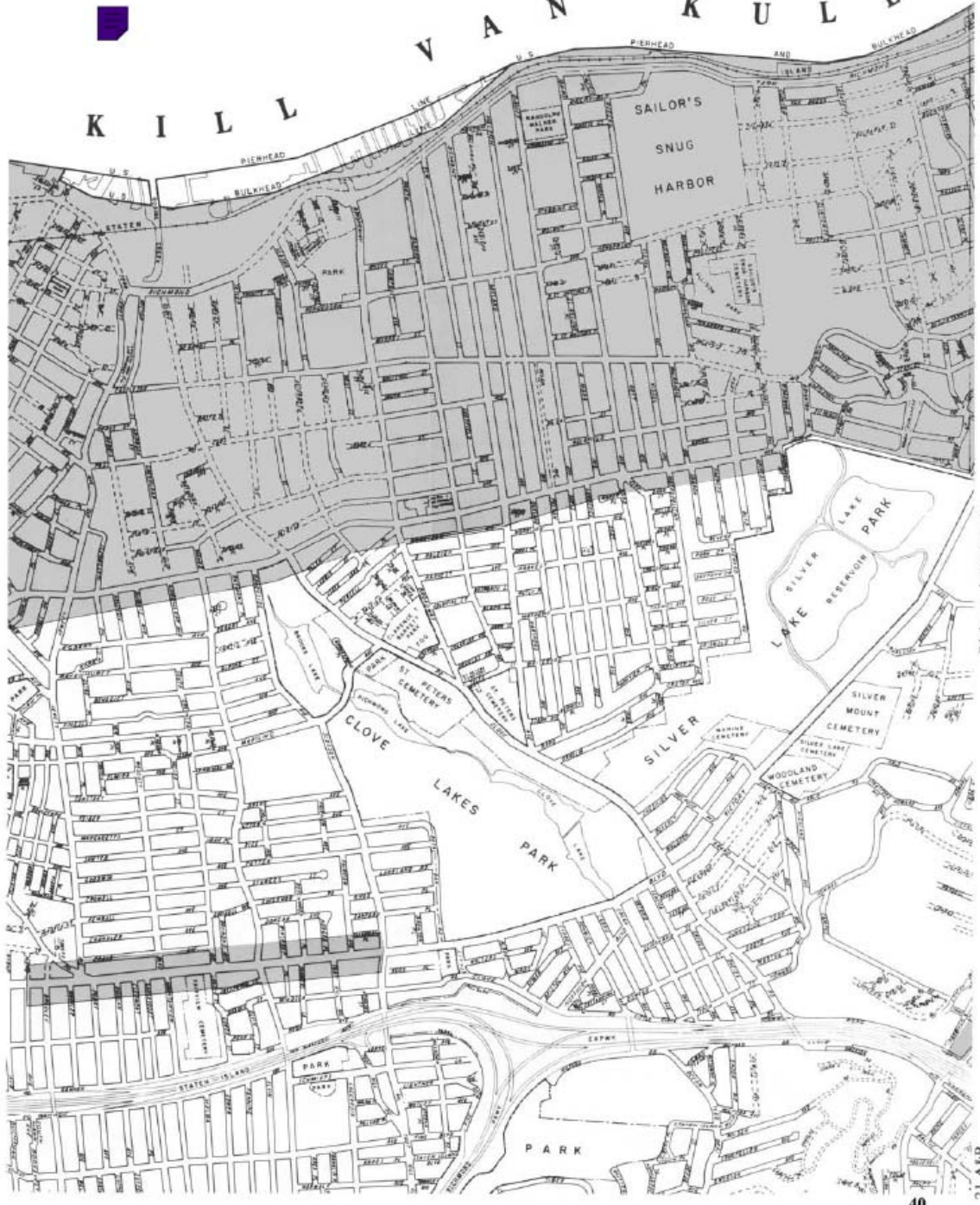
# N E W A R K B A Y





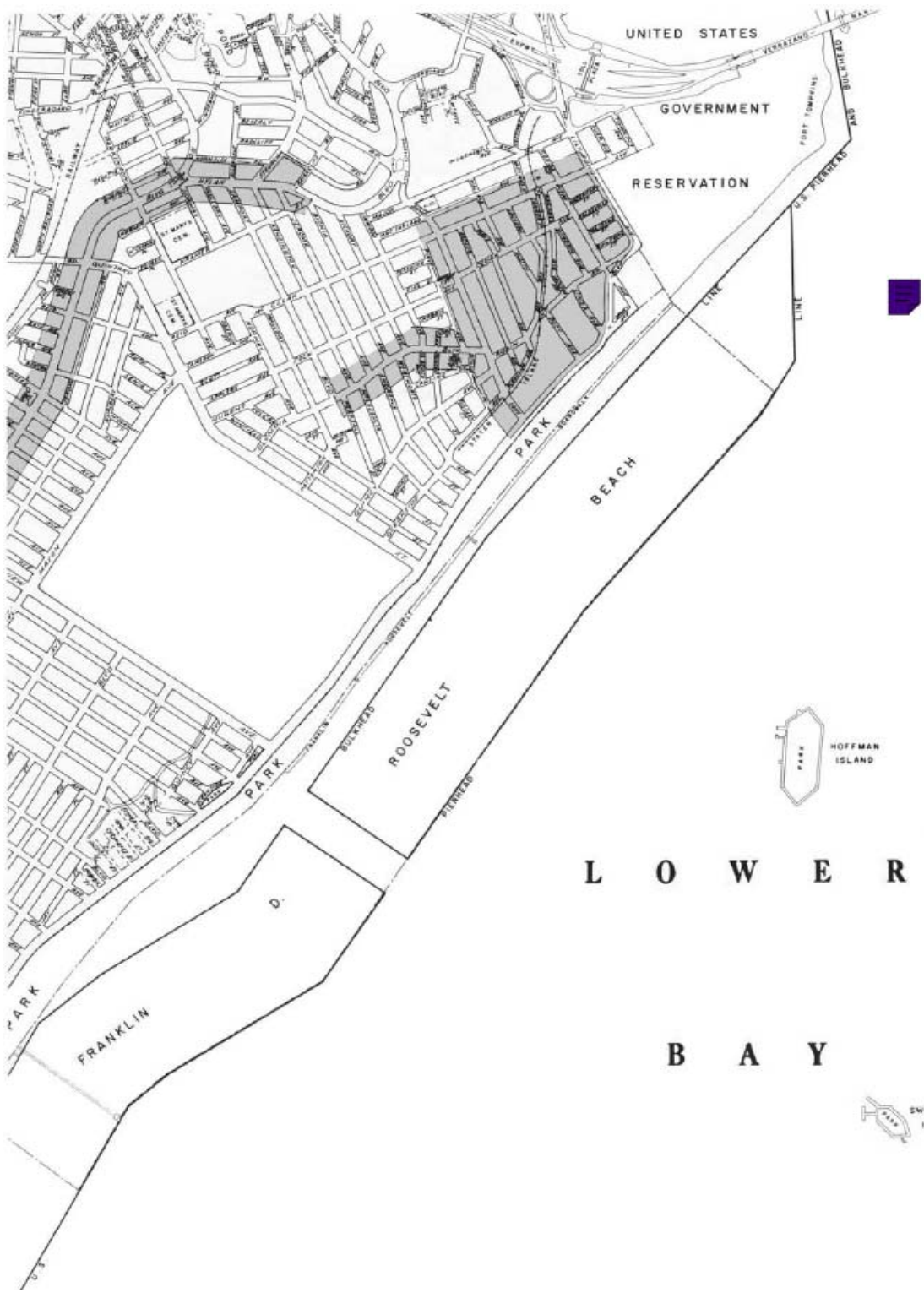


# K I L L V A N K U L L



Richmond RS 4-1-10

21 A&B



L O W E R  
B A Y



U P P E R

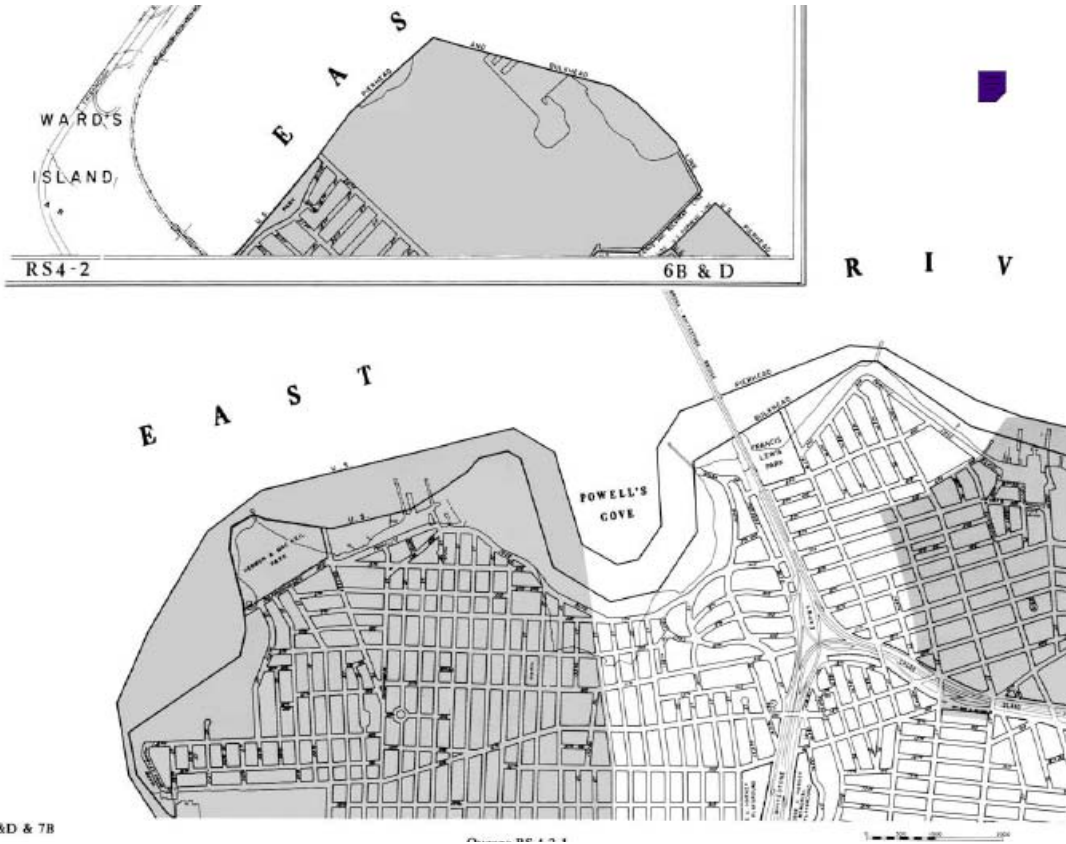
B A Y



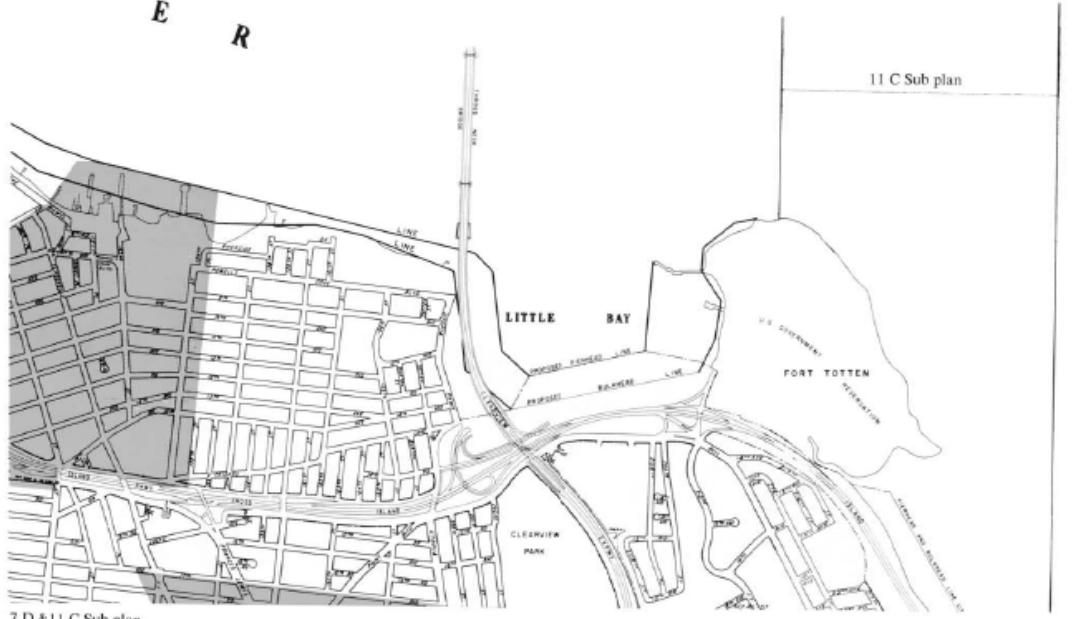




**FIGURE D101.2 (2)**  
**FIRE DISTRICT MAPS**  
**BOROUGH OF QUEENS**

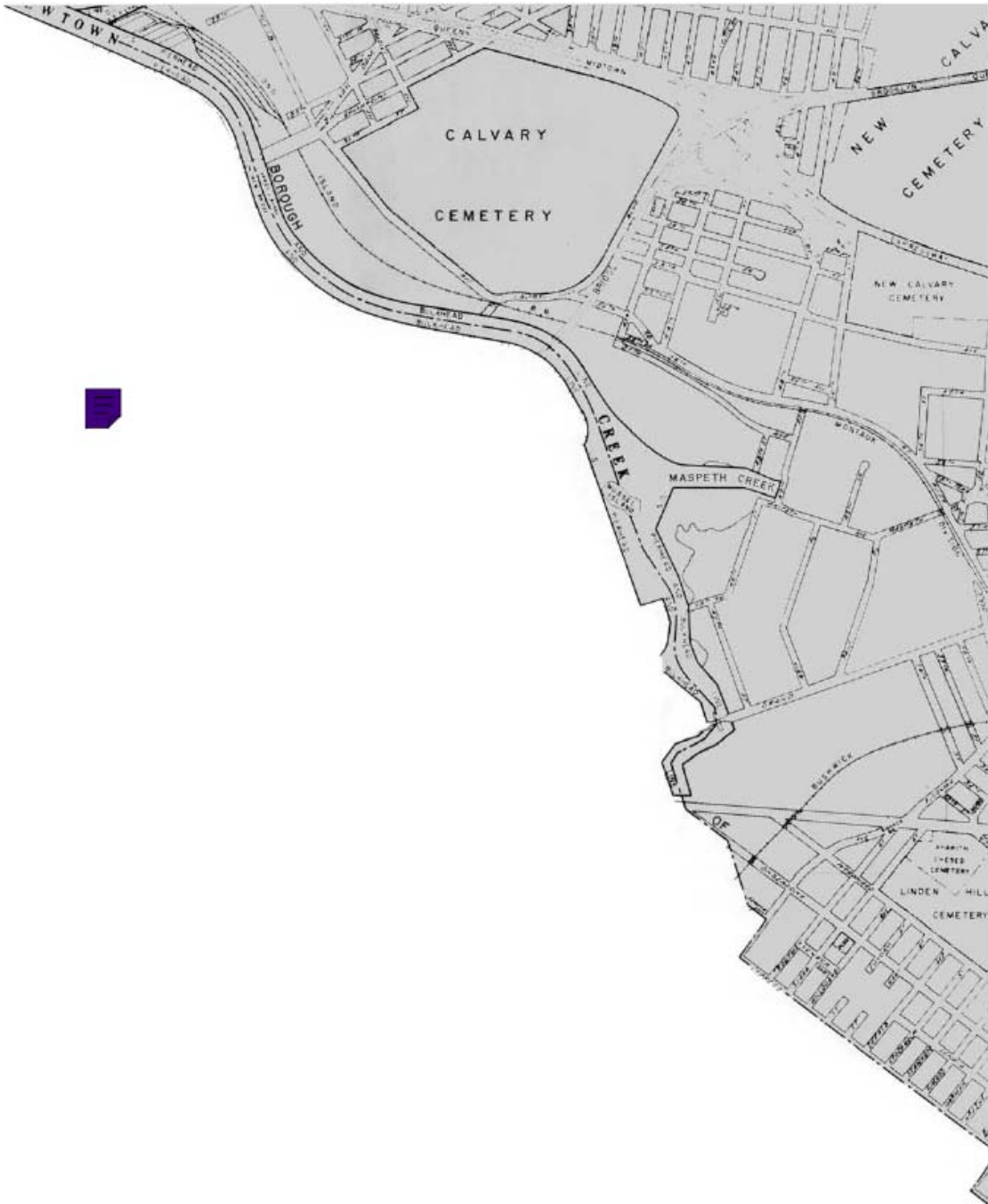


**E R**



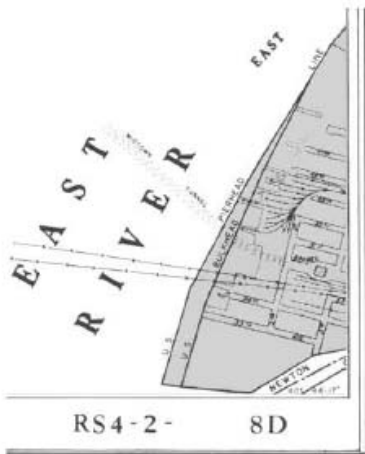
47

Orange B.C. 4.2.2



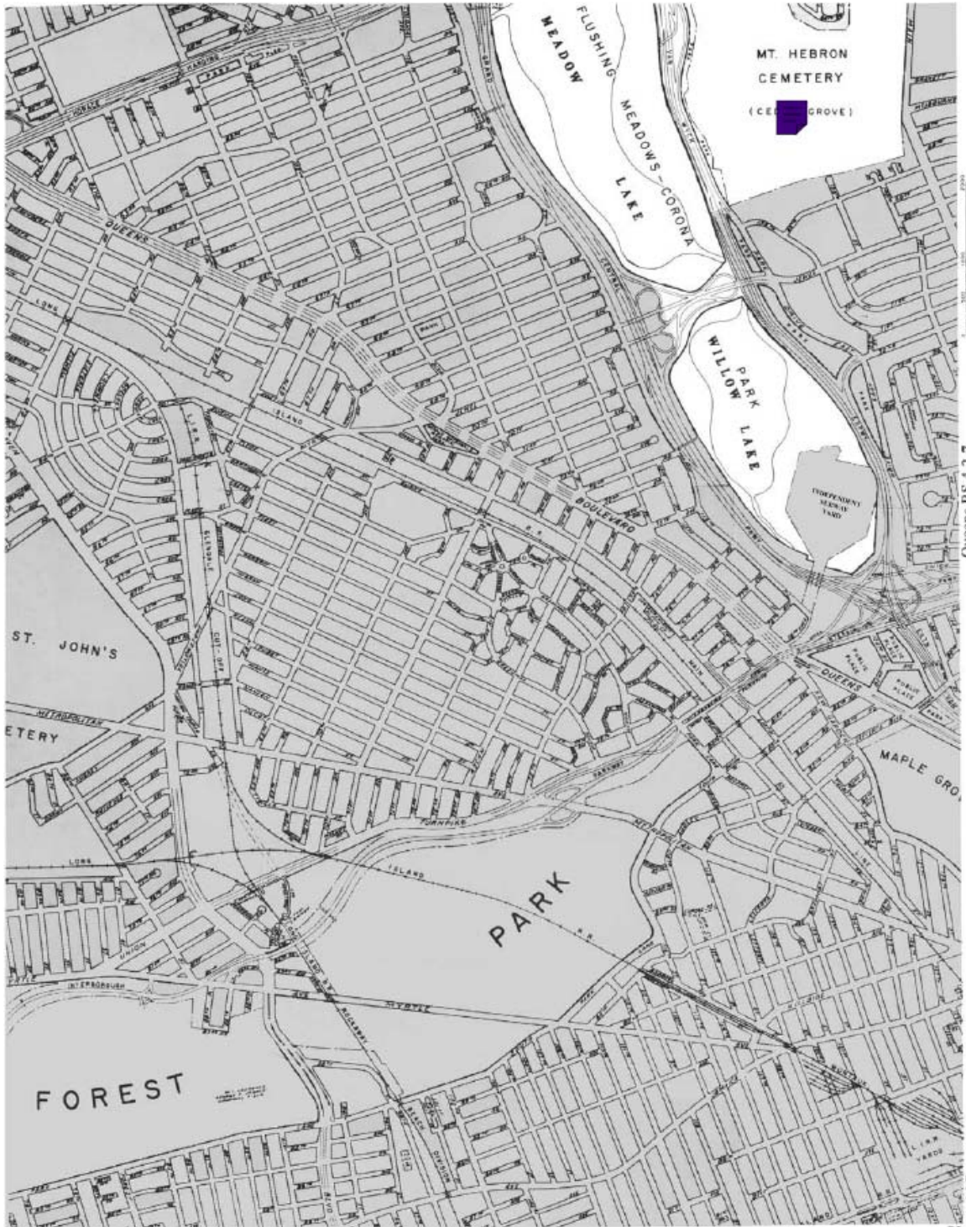
Queens RS 4-2-3





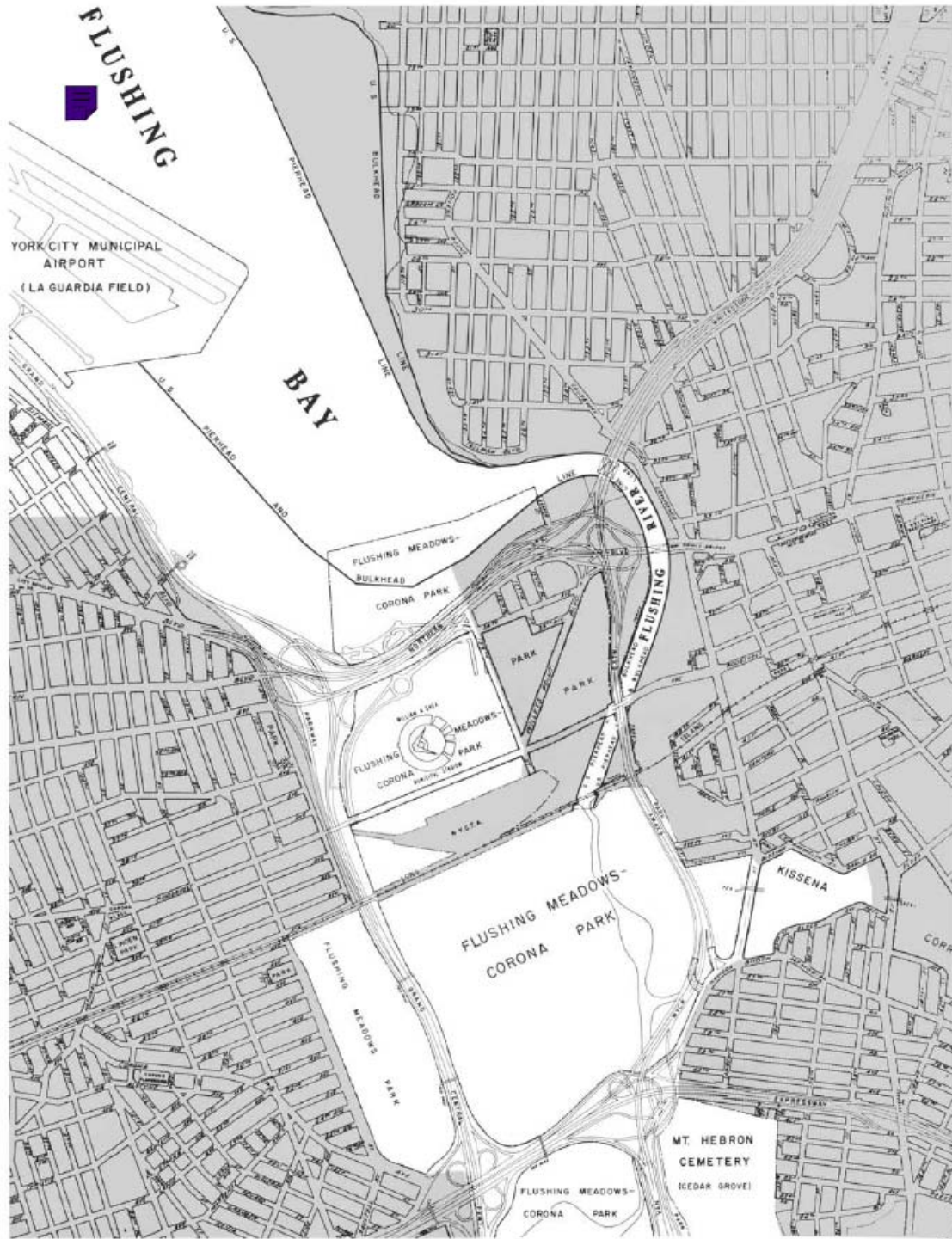






MT. HEBRON  
CEMETERY  
(CE GROVE)

Queens R.S. 4.7.7

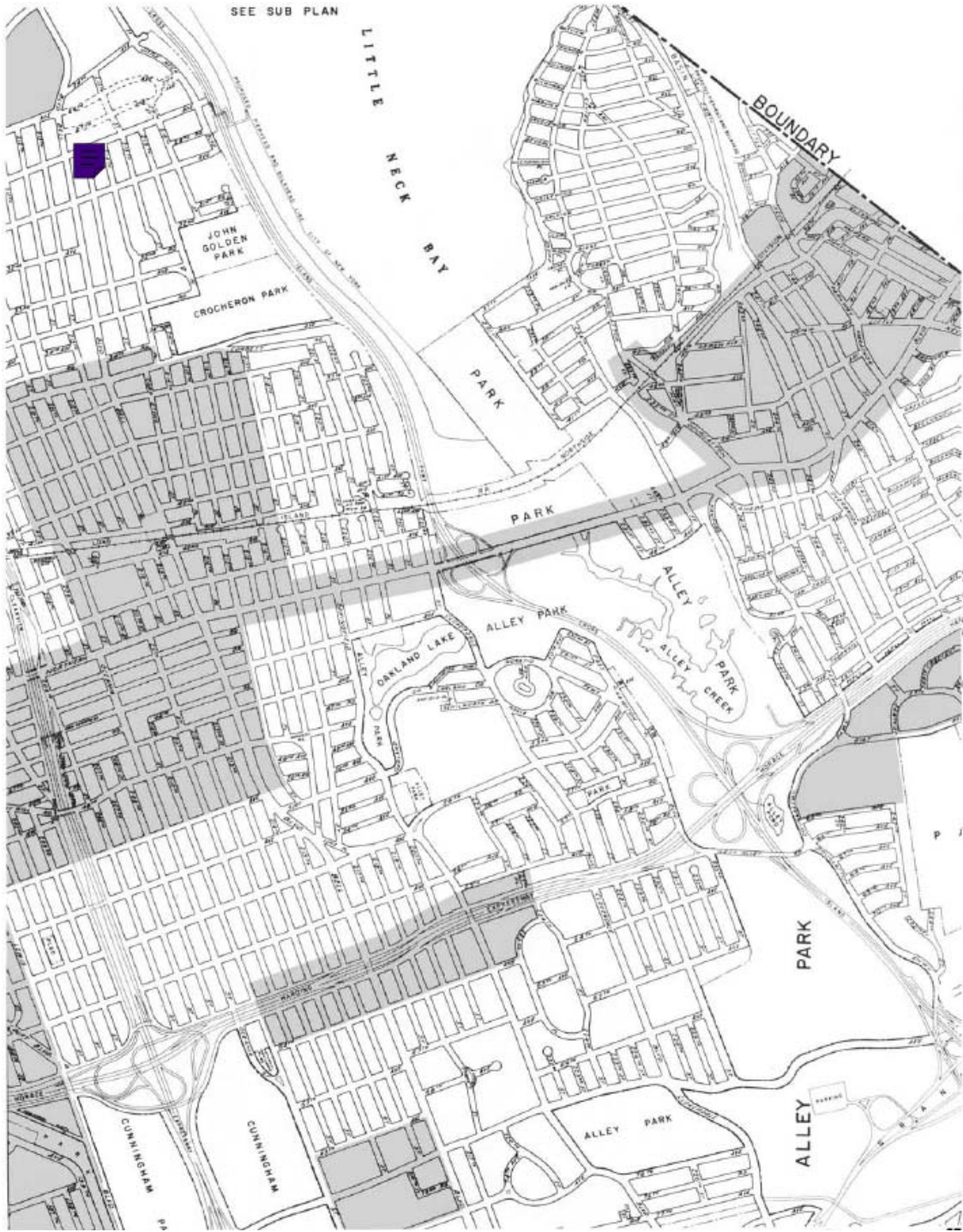












SEE SUB PLAN

LITTLE  
NECK  
BAY

BOUNDARY

JOHN  
GOLDEN  
PARK

CROCHERON PARK

PARK

PARK

ALLEY PARK

OAKLAND LAKE

ALLEY CREEK

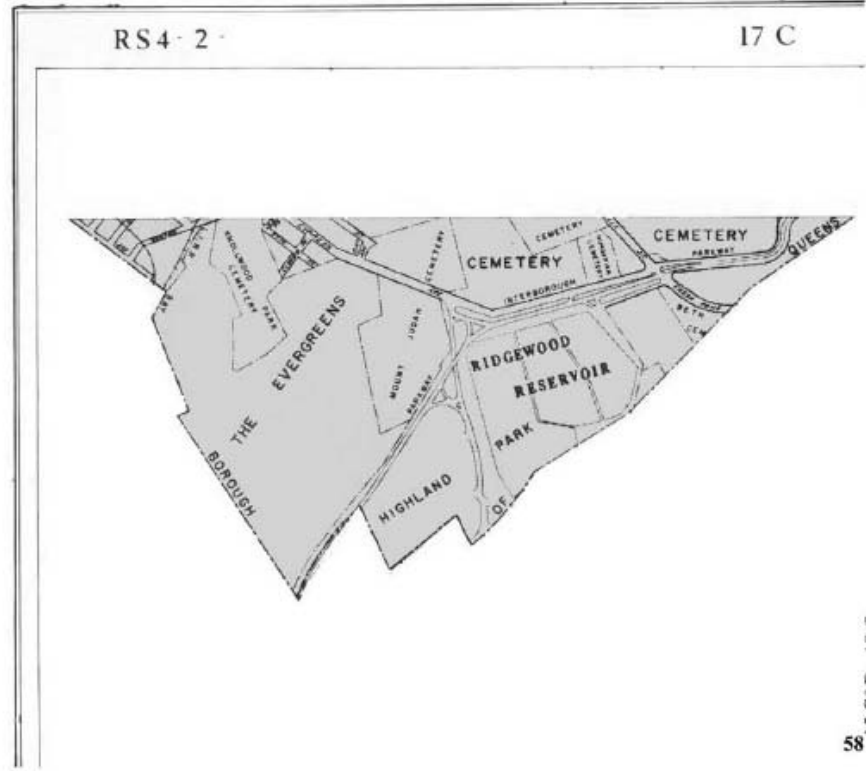
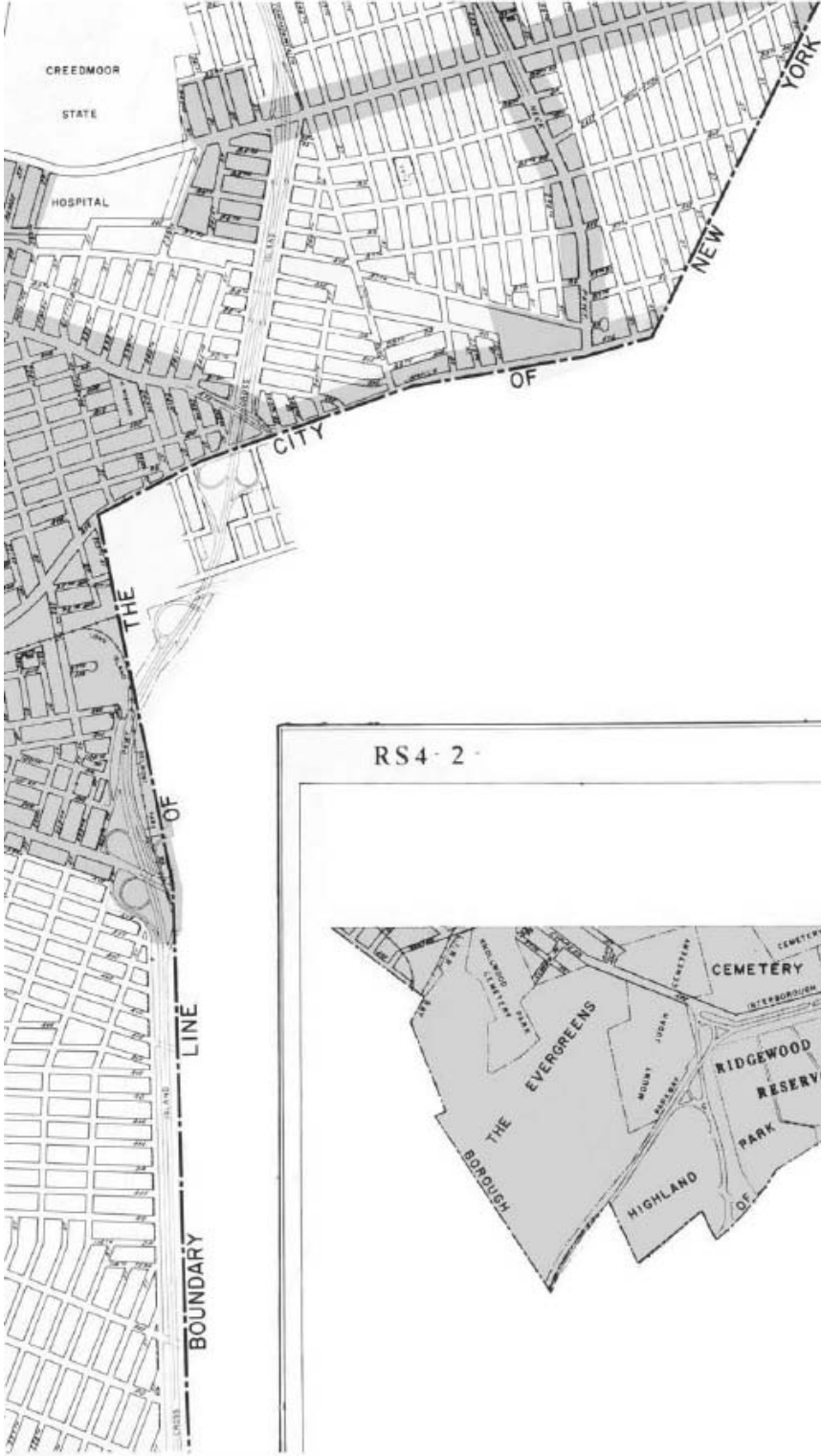
PARK

CUNNINGHAM

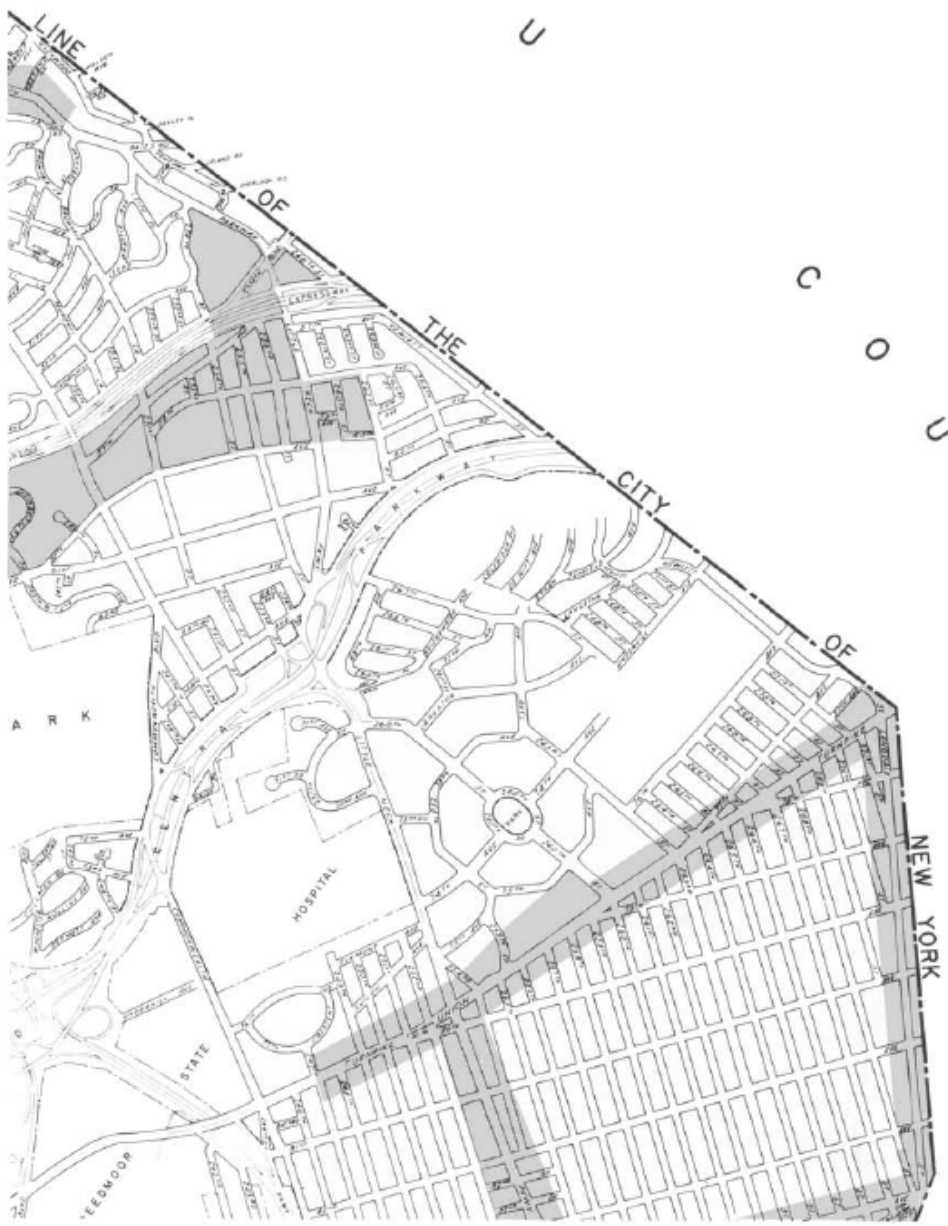
CUNNINGHAM

ALLEY PARK

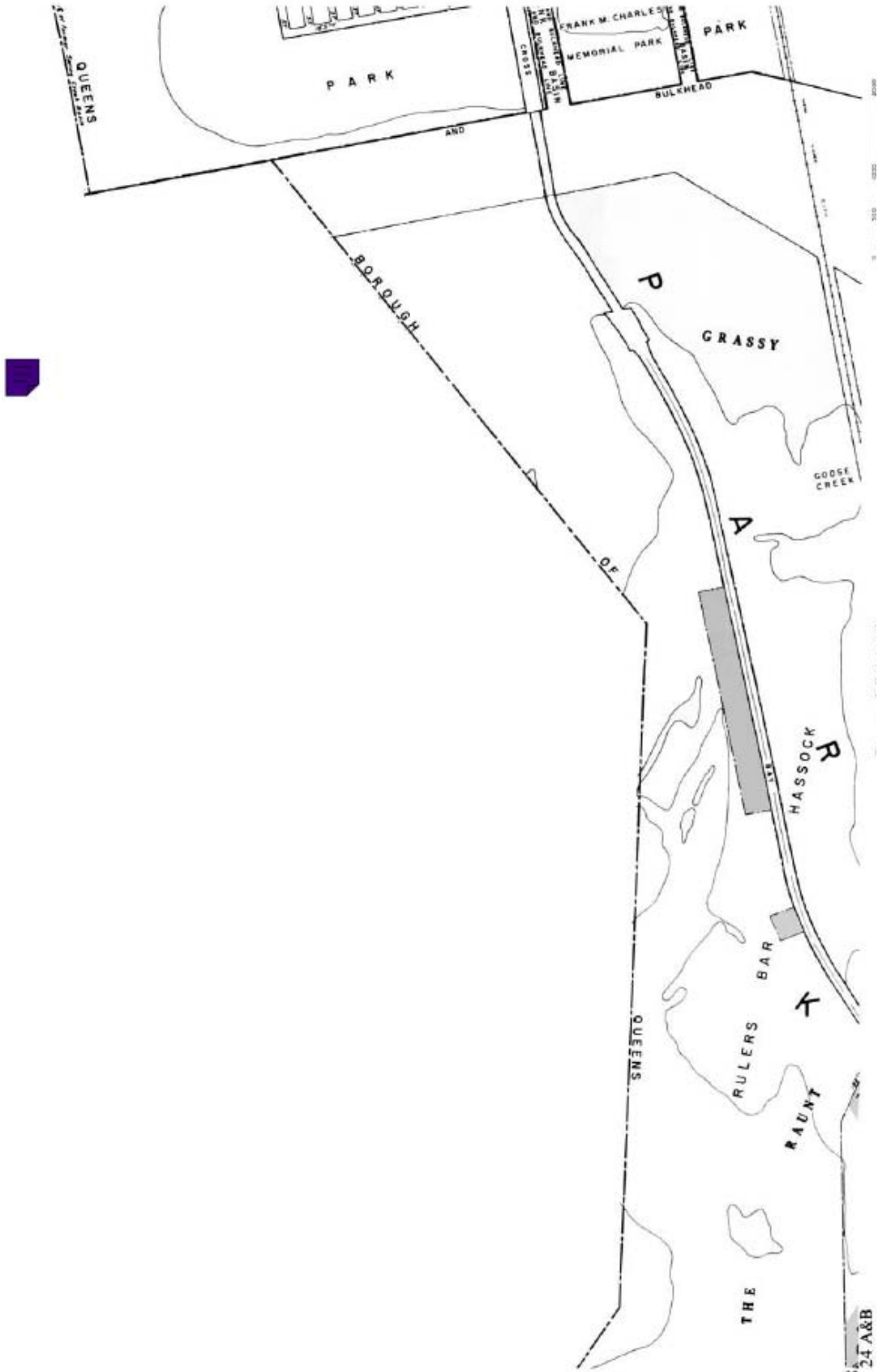
ALLEY

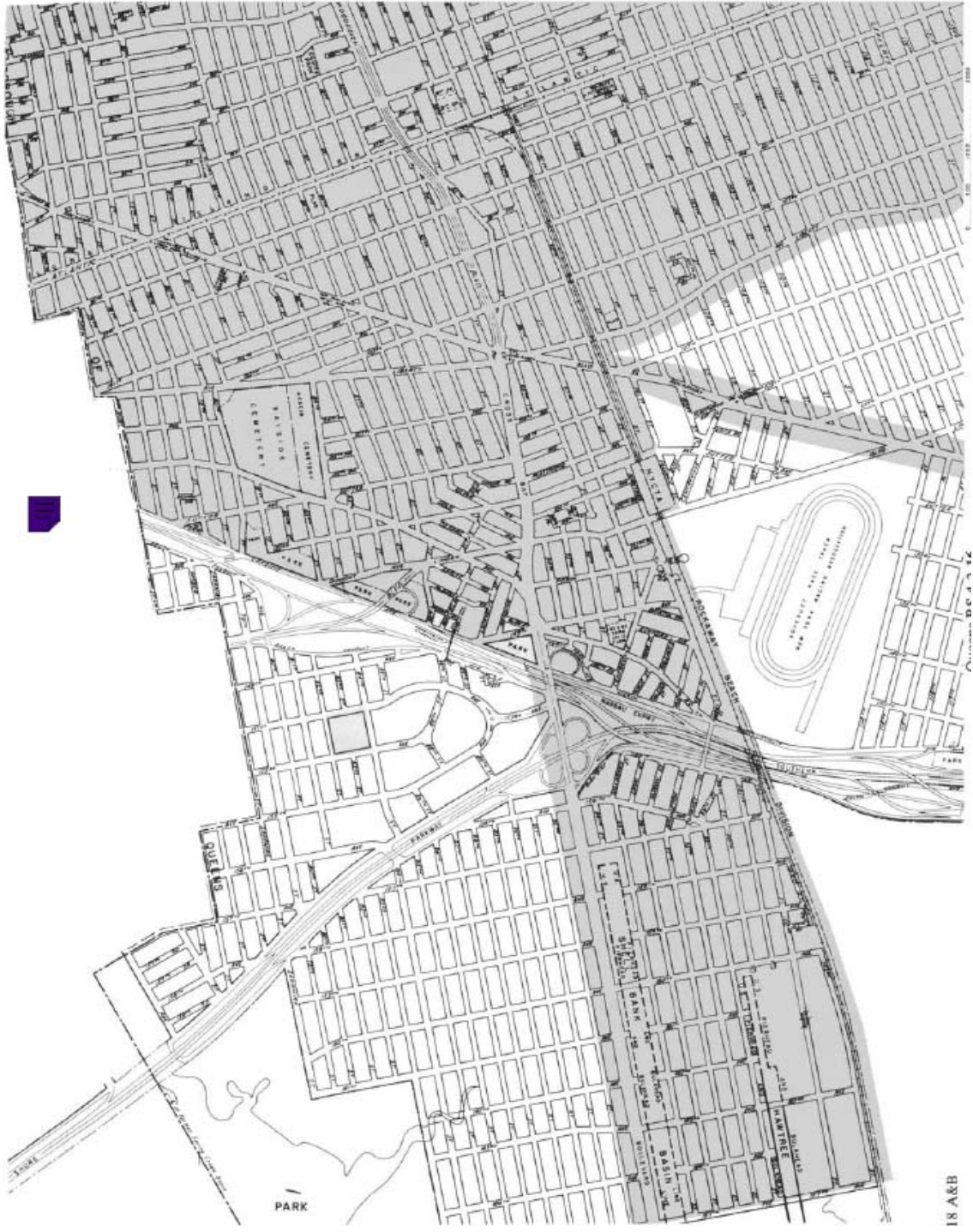


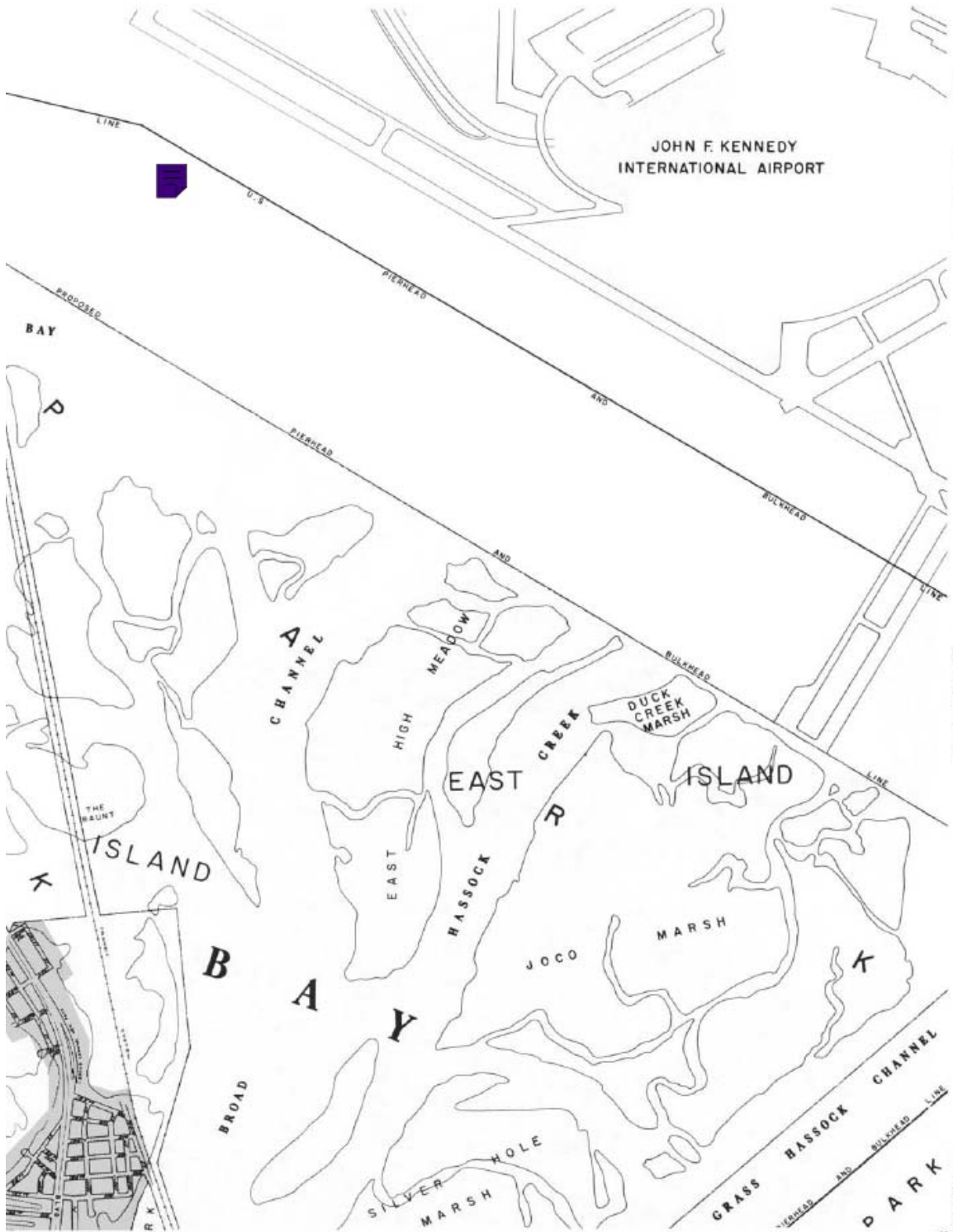
N  
A  
S  
S  
A  
U



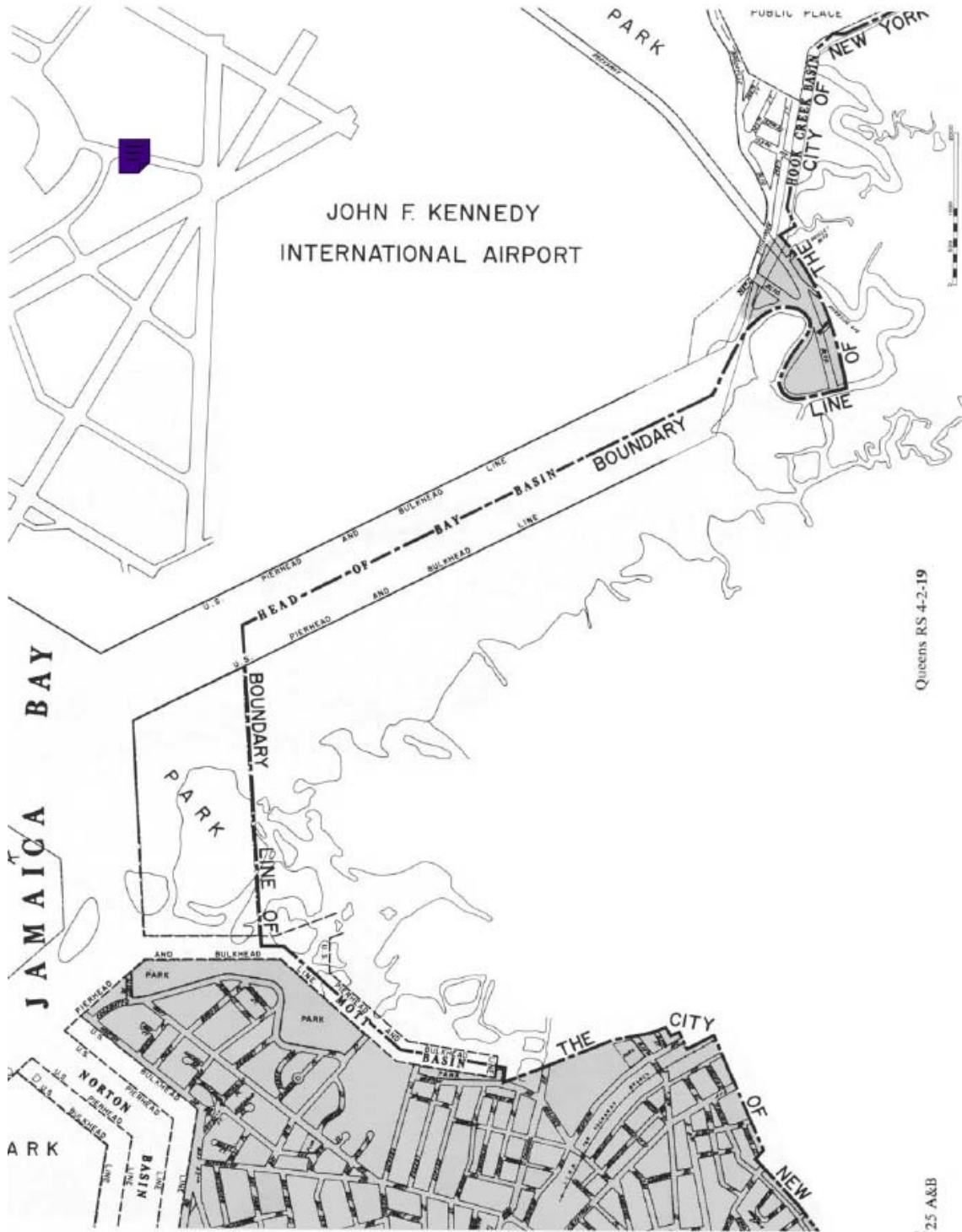
C  
O  
U  
N  
T  
Y











Queens RS 4-2-19

25 A&B

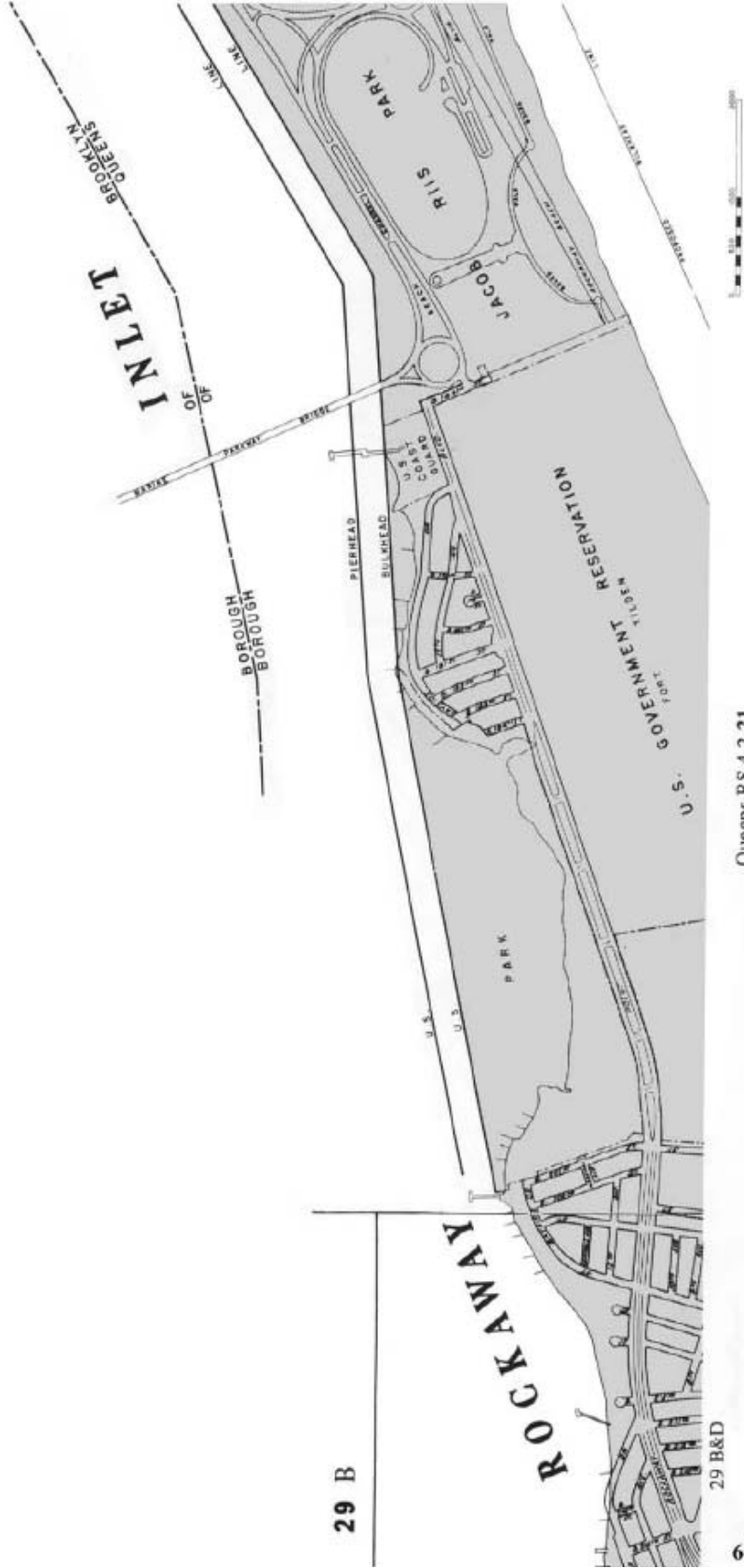




JOHN F. KENNEDY  
INTERNATIONAL AIRPORT

P A R K

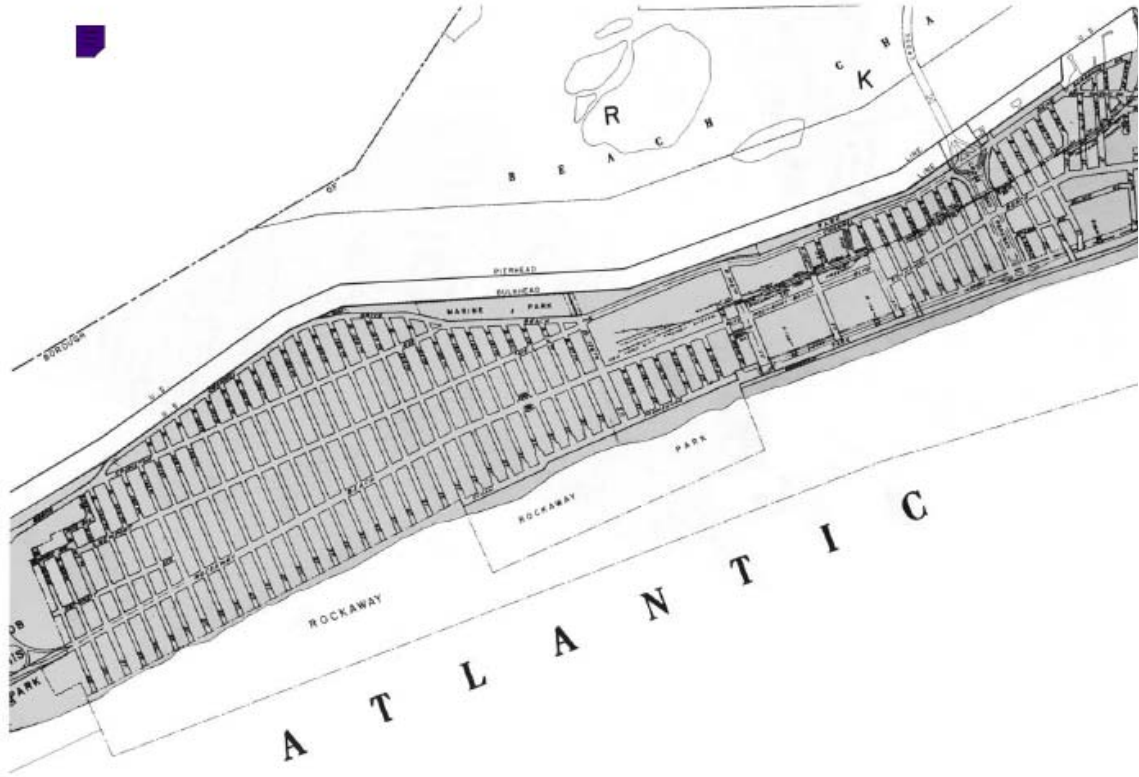
PUBLIC PLACE



29 B

29 B&D

U.S. GOVERNMENT RESERVATION

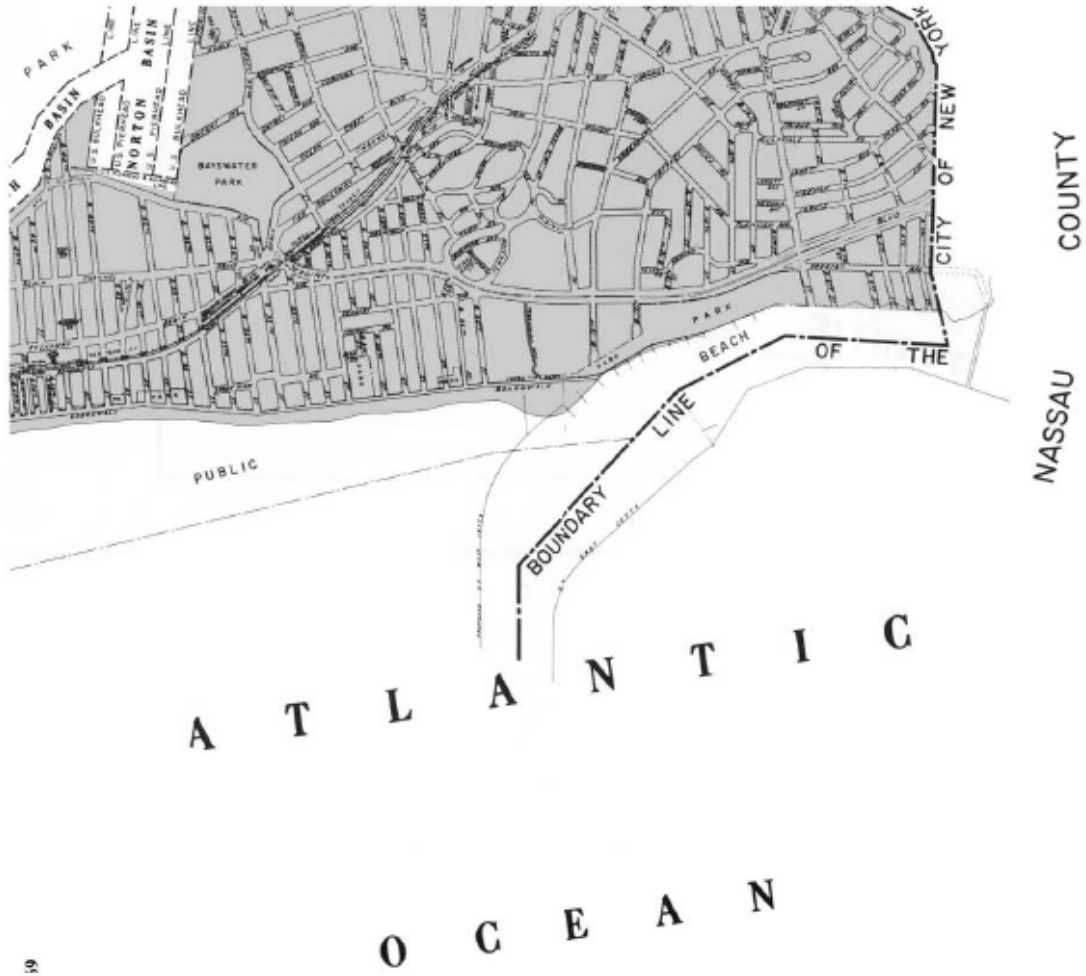


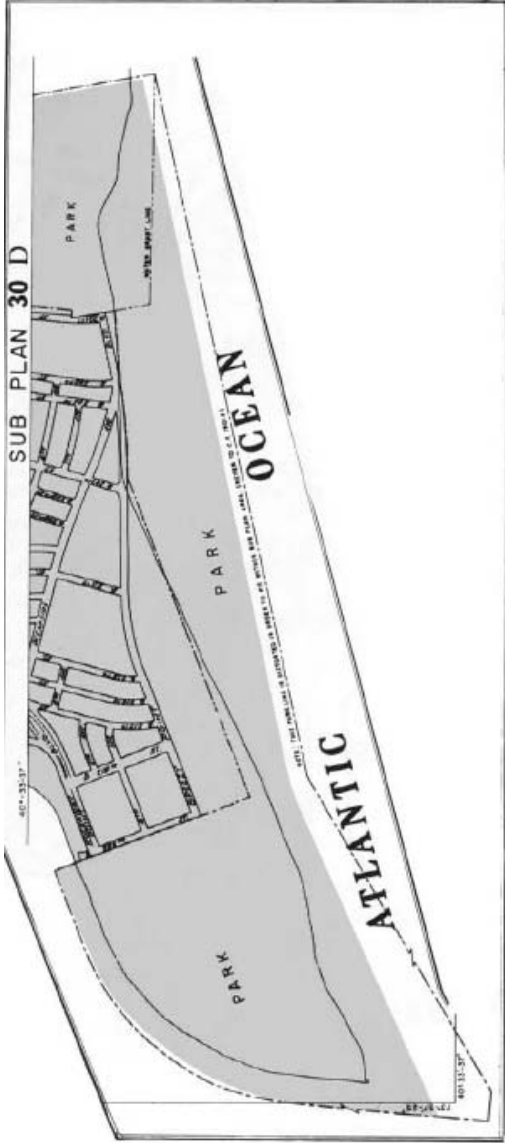
67  
30 A&B

Queens RS 4-2-22

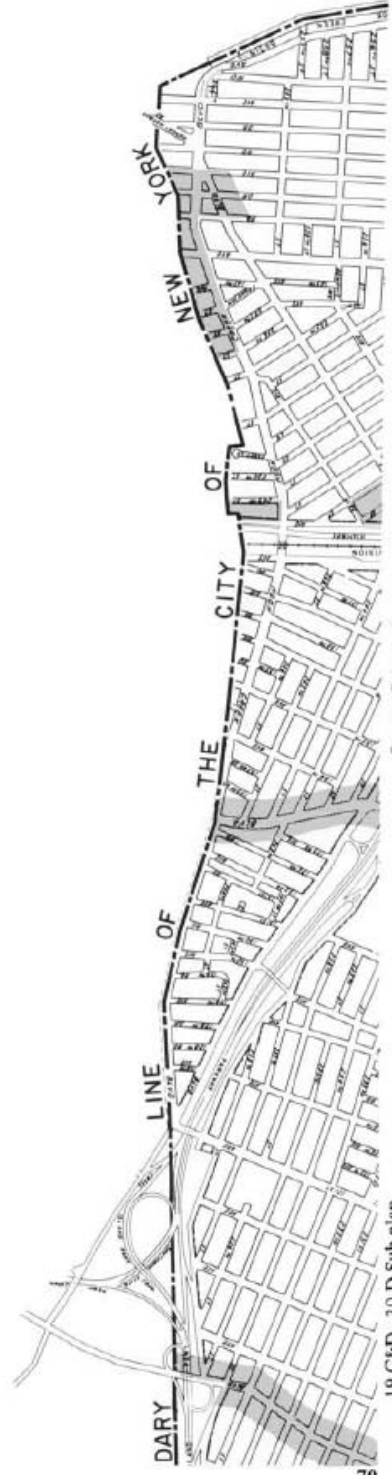








N  
A  
S  
S  
A  
U  
C  
O  
U  
N  
T  
Y



10 SEP 10 11 58 AM '04

**APPENDIX E**  
**SUPPLEMENTARY ACCESSIBILITY REQUIREMENTS**

**SECTION BC E101**  
**GENERAL**

**E101.1 Scope.** The provisions of this appendix shall control the supplementary requirements for the design and construction of facilities for accessibility to persons with physical disabilities.

**E101.2 Design.** Technical requirements for items herein shall comply with this code and ICC A117.1.

**SECTION BC E102**  
**DEFINITIONS**

**E102.1 General.** The following words and terms shall, for the purposes of this appendix, have the meanings shown herein.

**CLOSED-CIRCUIT TELEPHONE.** A telephone with a dedicated line such as a house phone, courtesy phone or phone that must be used to gain entrance to a facility.

**MAILBOXES.** Receptacles for the receipt of documents, packages or other deliverable matter. Mailboxes include, but are not limited to, post office boxes and receptacles provided by commercial mail-receiving agencies, apartment houses and schools.

**TRANSIENT LODGING.** A building, facility or portion thereof, excluding inpatient medical care facilities and long-term care facilities, that contains one or more dwelling units or sleeping units. Examples of transient lodging include, but are not limited to, resorts, group homes, hotels, motels, dormitories, homeless shelters, halfway houses and social service lodging.

**SECTION BC E103**  
**ACCESSIBLE ROUTE**

**E103.1 Raised platforms.** In banquet rooms or spaces where a head table or speaker's lectern is located on a raised platform, an accessible route shall be provided to the platform.

**SECTION BC E104**  
**SPECIAL OCCUPANCIES**

**E104.1 General.** Transient lodging facilities shall be provided with accessible features in accordance with Sections E104.2 and E104.3. Group I-3 occupancies shall be provided with accessible features in accordance with Sections E104.3 and E104.4.

**E104.2 Accessible beds.** In rooms or spaces having more than 25 beds, five percent of the beds shall have a clear floor space complying with Section 305 (Clear Floor Space) of ICC A117.1.

**E104.2.1 Sleeping areas.** A clear floor space complying with Section 305 (Clear Floor Space) of ICC A117.1 shall be provided on both sides of the accessible bed. The clear floor space shall be positioned for parallel approach to the side of the bed.

**Exception:** This requirement shall not apply where a single clear floor space complying with Section 305 (Clear Floor Space) of ICC A117.1 positioned for parallel approach is provided between two beds.

**E104.3 Communication features.** Communication features complying with Chapter 7 of ICC A117.1 shall be provided in accordance with Sections E104.3.1 through E104.3.3.

**E104.3.1 Transient lodging.** In transient lodging facilities, sleeping units with accessible communication features shall be provided in accordance with Table E104.3.1. Units required to comply with Table E104.3.1 shall be dispersed among the various classes of units.

**E104.3.2 Group I-3.** In Group I-3 occupancies at least 2 percent, but no fewer than one of the total number of general holding cells and general housing cells equipped with audible emergency alarm systems and permanently installed telephones within the cell, shall comply with Section E104.3.3.

**E104.3.3 Notification devices.** Visual notification devices shall be provided to alert room occupants of incoming telephone calls and a door knock or bell. Notification devices shall not be connected to visual alarm signal appliances. Permanently installed telephones shall have volume controls and an electrical outlet complying with ICC A117.1, including Section 309 (Operable Parts), located within 48 inches (1219 mm) of the telephone to facilitate the use of a TTY.

**E104.4 Partitions.** Solid partitions or security glazing that separates visitors from detainees in Group I-3 occupancies shall provide a method to facilitate voice communication. Such methods are permitted to include, but are not limited to, grilles, slats, talk-through baffles, intercoms or telephone handset devices. The method of communication shall be accessible to individuals who use wheelchairs and individuals who have difficulty bending or stooping. Hand-operable communication devices, if provided, shall comply with Section E106.3.

**TABLE E104.3.1**  
**DWELLING OR SLEEPING UNITS WITH ACCESSIBLE COMMUNICATION**  
**FEATURES**

**(Table E104.3.1 attached to end of document)**

**SECTION BC E105**



## **OTHER FEATURES AND FACILITIES**

**E105.1 Water coolers.** Where water coolers are provided, at least 50 percent, but not less than one, of such units provided on each floor shall comply with ICC A117.1.

**E105.2 Portable toilets and bathing rooms.** Where multiple single-user portable toilet or bathing units are clustered at a single location, at least 5 percent, but not less than one toilet unit or bathing unit at each cluster, shall comply with ICC A117.1, including Section 603 (Toilet and Bathing Rooms). Signs containing the International Symbol of Accessibility and complying with Section 703 (Signs) of ICC A117.1 shall identify accessible portable toilets and bathing units.

**Exception:** Portable toilet units provided for use exclusively by construction personnel on a construction site.

**E105.3 Laundry equipment.** Where provided in spaces required to be accessible, washing machines and clothes dryers shall comply with this section. Where laundry equipment is provided within a dwelling or sleeping unit, not for public use or common use, such equipment shall comply with Section 1107.2.8.

**E105.3.1 Washing machines.** Where three or fewer washing machines are provided, at least one shall comply with ICC A117.1, including Section 611 (Washing Machines and Clothes Dryers), and shall be front loading. Where more than three washing machines are provided, at least two shall comply with ICC A117.1, including Section 611 and shall be front loading.

**E105.3.2 Clothes dryers.** Where three or fewer clothes dryers are provided, at least one shall comply with ICC A117.1, including Section 611 (Washing Machines and Clothes Dryers), and shall be front loading. Where more than three clothes dryers are provided, at least two shall comply with ICC A117.1, including Section 611, and shall be front loading.

**E105.4 Depositories, vending machines, change machines and similar equipment.** Where provided, at least one of each type of depository, vending machine, change machine and similar equipment shall comply with ICC A117.1.

**Exception:** Drive-up-only depositories are not required to comply with this section.

**E105.5 Mailboxes.** Where mailboxes are provided in an interior location, at least five percent, but not less than one, of each type shall comply with ICC A117.1. In residential and institutional facilities, where mailboxes are provided for each dwelling unit or sleeping unit, mailboxes complying with ICC A117.1 shall be provided for each unit required to be an Accessible unit.

**E105.6 Automatic teller machines and fare machines.** Where automatic teller machines or self-service fare vending, collection or adjustment machines are provided, at least one machine of each type at each location where such machines are provided shall

comply with ICC A117.1, including Section 707 (ATMs and Fare Machines). Where bins are provided for envelopes, wastepaper or other purposes, at least one of each type shall comply with ICC A117.1, including Section 905 (Storage Facilities).

**E105.7 Two-way communication systems.** Where two-way Communication systems are provided to gain admittance to a building or facility or to restricted areas within a building or facility, the system shall comply with ICC A117.1, including Section 708 (Two-Way Communication Systems).

## **SECTION BC E106** **TELEPHONES**

**E106.1 General.** Where coin-operated public pay telephones, coinless public pay telephones, public closed-circuit telephones, courtesy phones or other types of public telephones are provided, accessible public telephones shall be provided in accordance with Sections E106.2 through E106.5 for each type of public telephone provided. For purposes of this section, a bank of telephones shall be considered two or more adjacent telephones.

**E106.2 Wheelchair-accessible telephones.** Where public telephones are provided, wheelchair-accessible telephones complying with ICC A117.1, including Section 704 (Telephones) and shall be provided in accordance with Table E106.2.

**E106.3 Volume controls.** All public telephones provided shall have volume control complying with Section 704.3 (Volume-Control Telephones) of ICC A117.1.

**E106.4 TTYs.** TTYs complying with ICC A117.1, including Section 704.4 through 704.7, shall be provided in accordance with Sections E106.4.1 through E106.4.9.

### **TABLE E106.2** **WHEELCHAIR-ACCESSIBLE TELEPHONES** **(Table E106.2 attached to end of document)**

**E106.4.1 Bank requirement.** Where four or more public pay telephones are provided at a bank of telephones, at least one public TTY shall be provided at that bank.

**Exception:** TTYs are not required at banks of telephones located within 200 feet (60 960 mm) of, and on the same floor as, a bank containing a public TTY.

**E106.4.2 Floor requirement.** Where four or more public pay telephones are provided on a floor of a privately owned building, at least one public TTY shall be provided on that floor. Where at least one public pay telephone is provided on a floor of a publicly owned building, at least one public TTY shall be provided on that floor.

**E106.4.3 Building requirement.** Where four or more public pay telephones are provided in a privately owned building, at least one public TTY shall be provided in

the building. Where at least one public pay telephone is provided in a publicly owned building, at least one public TTY shall be provided in the building.

**E106.4.4 Site requirement.** Where four or more public pay telephones are provided on a site, at least one public TTY shall be provided on the site.

**E106.4.5 Rest stops, emergency road stops, and service plazas.** Where a public pay telephone is provided at a public rest stop, emergency road stop or service plaza, at least one public TTY shall be provided.

**E106.4.6 Hospitals.** Where a public pay telephone is provided in or adjacent to a hospital emergency room, hospital recovery room or hospital waiting room, at least one public TTY shall be provided at each such location.

**E106.4.7 Transportation facilities.** Transportation facilities shall be provided with TTYs in accordance with Section E109.2.5 in addition to the TTYs required by Sections E106.4.1 through E106.4.4.

**E106.4.8 Detention and correctional facilities.** In detention and correctional facilities, where a public pay telephone is provided in a secured area used only by detainees or inmates and security personnel, then at least one TTY shall be provided in at least one secured area.

**E106.4.9 Signs.** Public TTYs shall be identified by the International Symbol of TTY complying with Section 703.6.3.2 (International Symbol of TTY) of ICC A117.1. Directional signs indicating the location of the nearest public TTY shall be provided at banks of public pay telephones not containing a public TTY. Additionally, where signs provide direction to public pay telephones, they shall also provide direction to public TTYs. Such signs shall comply with ICC A117.1, including Section 703.2 (Visual Characters) and shall include the International Symbol of TTY.

**E106.5 Shelves for portable TTYs.** Where a bank of telephones in the interior of a building consists of three or more public pay telephones, at least one public pay telephone at the bank shall be provided with a shelf and an electrical outlet in accordance with Section 704.6 (TTY Shelf) of ICC A117.1.

**Exceptions:**

1. In secured areas of detention and correctional facilities, if shelves and outlets are prohibited for purposes of security or safety shelves and outlets for TTYs are not required to be provided.
2. The shelf and electrical outlet shall not be required at a bank of telephones with a TTY.

**SECTION BC E107**

## **SIGNAGE**

**E107.1 Signs.** Required accessible portable toilets and bathing facilities shall be identified by the International Symbol of Accessibility.

**E107.2 Designations.** Interior and exterior signs identifying permanent rooms and spaces shall be tactile. Where pictograms are provided as designations of interior rooms and spaces, the pictograms shall have tactile text descriptors. Signs required to provide tactile characters and pictograms shall comply with Section 703.3 and 703.5 of ICC A117.1.

### **Exceptions:**

1. Exterior signs that are not located at the door to the space they serve are not required to comply.
2. Building directories, menus, seat and row designations in assembly areas, occupant names, building addresses and company names and logos are not required to comply.
3. Signs in parking facilities are not required to comply.
4. Temporary (seven days or less) signs are not required to comply.

**E107.3 Directional and informational signs.** Signs that provide direction to, or information about, permanent interior spaces of the site and facilities shall contain visual characters complying with Section 703.2 (Visual Characters) of ICC A117.1.

**Exception:** Building directories, personnel names, company or occupant names and logos, menus and temporary (seven days or less) signs are not required to comply with ICC A117.1.

**E107.4 Other signs.** Signage indicating special accessibility provisions shall be provided at fixed facilities and stations, signage must be provided in accordance with Sections E109.2.2 through E109.2.2.3.

## **SECTION BC E108** **RESERVED**

## **SECTION BC E109** **TRANSPORTATION FACILITIES AND STATIONS**

**E109.1 General.** Fixed transportation facilities and stations shall comply with the applicable provisions of Section E109.2.

**E109.2 New construction.** New stations in rapid rail, light rail, commuter rail, intercity rail, high speed rail and other fixed guideway systems shall comply with Sections E109.2.1 through E109.2.8.

**E109.2.1 Station entrances.** Where different entrances to a station serve different transportation fixed routes or groups of fixed routes, all entrance serving each group or route shall comply with Section 1104 and ICC A117.1, including Section 404 (Doors and Doorways).

**E109.2.2 Signs.** Signage in fixed transportation facilities and stations shall comply with Sections E109.2.2.1 through E109.2.2.3.

**E109.2.2.1 Tactile signs.** Where signs are provided at entrances to stations identifying the station or the entrance, or both, at least one sign at each entrance shall be tactile. A minimum of one tactile sign identifying the specific station shall be provided on each platform or boarding area. Such signs shall be placed in uniform locations at entrances and on platforms or boarding areas within the transit system to the maximum extent practicable. Tactile signs shall comply with Section 703.3 (Tactile Characters) of ICC A117.1.

**Exceptions:**

1. Where the station has no defined entrance but signs are provided, the tactile signs shall be placed in a central location.
2. Signs are not required to be tactile where audible signs are remotely transmitted to hand-held receivers, or are user or proximity actuated.

**E109.2.2.2 Identification signs.** Stations covered by this section shall have identification signs containing visual characters complying with Section 703.2 (Visual Characters) of ICC A117.1. Signs shall be clearly visible and within the sightlines of a standing or sitting passenger from within the train on both sides when not obstructed by another train.

**E109.2.2.3 Informational signs.** Lists of stations, routes and destinations served by the station which are located on boarding areas, platforms or mezzanines shall provide visual characters complying with Section 703.2 (Visual Characters) of ICC A117.1. Signs covered by this provision shall, to the maximum extent practicable, be placed in uniform locations within the transit system.

**E109.2.3 Fare machines.** Self-service fare vending, collection and adjustment machines shall comply with Section 707 (ATMs and Fare Machines) of ICC A117.1. Where self-service fare vending, collection or adjustment machines are provided for the use of the general public, at least one accessible machine of each type provided shall be provided at each accessible point of entry and exit.

**E109.2.4 Rail-to-platform height.** Station platforms shall be positioned to coordinate with vehicles in accordance with the applicable provisions of 36 CFR, Part 1192. Low-level platforms shall be 8 inches (203 mm) minimum above top of rail.

**Exception:** Where vehicles are boarded from sidewalks or street level, low-level platforms shall be permitted to be less than 8 inches (203 mm).

**E109.2.5 TTYs.** Where a public pay telephone is provided in a transit facility (as defined by the Department of Transportation) at least one public TTY complying with Section 704.4 through 704.7 of ICC A117.1 shall be provided in the station. In addition, where one or more public pay telephones serve a particular entrance to a transportation facility, at least one TTY telephone complying with Section 704.4 through 704.7 of ICC A117.1 shall be provided to serve that entrance.

**E109.2.6 Track crossings.** Where a circulation path serving boarding platforms crosses tracks, an accessible route complying with ICC A117.1, including Section 402 (Accessible Routes) shall be provided.

**Exception:** Openings for wheel flanges shall be permitted to be 2½ inches (64 mm) maximum.

**E109.2.7 Public address systems.** Where public address systems convey audible information to the public, the same or equivalent information shall be provided in a visual format.

**E109.2.8 Clocks.** Where clocks are provided for use by the general public, the clock face shall be uncluttered so that its elements are clearly visible. Hands, numerals and digits shall contrast with the background either light-on-dark or dark-on-light. Where clocks are mounted overhead, numerals and digits shall comply with Section 703.2 (Visual Characters) of ICC A117.1.

**E109.3 Reserved.**

**SECTION BC E110**  
**RESERVED**

**SECTION BC E111**  
**RESERVED**

**SECTION BC E112**  
**REFERENCED STANDARDS**

DOJ 36  
CFR Part 1192

Americans with Disabilities Act (ADA) Accessibility Guidelines for Transportation Vehicles (ADAAG). Washington, D.C.: Department of Justice, 1991

E109.2.4,

ICC A117.1-2003

Accessible and Usable Buildings and Facilities

E101.2, et al.

**TABLE E104.3.1**  
**DWELLING OR SLEEPING UNITS WITH ACCESSIBLE COMMUNICATION FEATURES**

TOTAL NUMBER OF DWELLING OR SLEEPING UNITS PROVIDED	MINIMUM REQUIRED NUMBER OF DWELLING OR SLEEPING UNITS WITH ACCESSIBLE COMMUNICATION FEATURES
1	1
2 to 25	2
26 to 50	4
51 to 75	7
76 to 100	9
101 to 150	12
151 to 200	14
201 to 300	17
301 to 400	20
401 to 500	22
501 to 1,000	5% of total
1,001 and over	50 plus 3 for each 100 over 1,000

**TABLE E106.2**  
**WHEELCHAIR-ACCESSIBLE TELEPHONES**

NUMBER OF TELEPHONES PROVIDED ON A FLOOR, LEVEL OR EXTERIOR SITE	MINIMUM REQUIRED NUMBER OF WHEELCHAIR-ACCESSIBLE TELEPHONES
1 or more single unit	1 per floor, level and exterior site
1 bank	1 per floor, level and exterior site
2 or more banks	1 per bank

**APPENDIX F**  
**RODENT PROOFING**

**SECTION BC F101**  
**GENERAL**

**F101.1 Scope.** The provisions of this appendix provide rodent-proofing design and construction requirements for the resistance of rodent ingress and infestation. For rodent extermination provisions related to demolition operations, see Section 3306.9.13. *The New York City Health Code, The New York City Housing Maintenance Code, and The New York City Sanitation Code* may contain additional provisions, as enforced by the New York City Department of Health and Mental Hygiene, the New York City Department of Housing Preservation and Development, and the New York City Sanitation Department.

**F101.2 General.** Every structure, room, or space hereafter altered or erected in which persons live, sleep or work, or in which feed, food or foodstuffs are stored, prepared, processed, served or sold, shall be constructed in accordance with the provisions of this section. All metal or wire protection materials specified herein shall be noncorrosive.

**F101.3 Reserved.**

**F101.4 Reserved.**

**F101.5 Reserved.**

**F101.6 Reserved.**

**SECTION BC F102**  
**PROTECTION**

**F102.1 Exterior walls and underground walls.** For walls or portions thereof within 2 feet (610 mm) of the outside ground level, and for walls below the outside ground level, all openings, including but not limited to annular spaces around pipes, electric cables, and conduits, shall be protected by closing such openings with cement mortar, concrete masonry, metal plates or screening designed to prevent the passage of rodents. Openings for doors, windows and vents shall be as provided for in Sections F102.3, F102.4 and F102.5, respectively.

**F102.2 Floors on grade.** Unless otherwise specified in this code, floors on grade, including but not limited to cellar floors and crawl space floors, shall be constructed of a minimum 2 inches (51 mm) thick continuous concrete slab. Gaps shall not be permitted between the slab and the abutting foundation walls or columns, except where expansion joints, thermal breaks, and control joints are located. All openings including but not limited to annular spaces around pipes, electric cables, and conduits in the slab shall be protected by closing such openings with cement mortar, concrete masonry, metal plates



or screening designed to prevent the passage of rodents.

**F102.3 Exterior doors.** Where an exterior door is nonmetal or nonmetal-clad, such door shall be covered with a kick plate of a minimum thickness of 0.033 inch (0.84 mm), extending at least 8 inches (203 mm) from the bottom of the door, and covering the entire width of the door. When closed, the maximum clearance between any door, door jambs and sills shall not be greater than 3/8 inch (9.5 mm).

**F102.4 Windows and other openings.** Windows and other openings shall comply with Sections F102.4.1 and F102.4.2.

**F102.4.1 Openings within two feet of ground level.** Operable windows and other openings providing required or voluntary natural ventilation located with any portion within 2 feet (610 mm) above outside ground level immediately below such opening shall be covered for their entire height and width of the operable portion with hardware cloth of at least 0.035 inch (0.89 mm) wire or heavier. The openings in the hardware cloth shall not exceed 1/4 inch (6.4 mm).

**F102.4.2 Rodent-accessible openings.** Operable windows and other openings providing required or voluntary natural ventilation in the exterior located within 2 feet (610 mm) of exposed pipes, wires, conduits and other appurtenances, shall be covered with wire cloth of at least 0.035 inch (0.89 mm) wire. The openings in the hardware cloth shall not exceed 1/4 inch (6.4 mm).

**Exception:** In lieu of wire cloth covering, said pipes, wires, conduits and other appurtenances shall be blocked from rodent usage in accordance with one of the following:

1. Installation of solid sheet metal collars 0.024 inch (0.61 mm) thick or heavier. Such collars shall be fastened around the pipes, wires, conduits or other appurtenances, projecting a minimum distance of 12 inches (305 mm) beyond and on either side of the pipes, wires, conduits or appurtenances.
2. Installation of solid sheet metal guards fastened securely to the exterior wall, projecting 12 inches (305 mm) perpendicularly from the exterior wall for the length of the opening plus 2 feet (610 mm) beyond each end of the opening.

**F102.5 Exterior wall ventilation openings.** Exterior wall ventilator openings located with any portion within 2 feet (610 mm) of outside ground level shall be covered for their height and width with perforated sheet metal plates no less than 0.070 inch (1.8 mm) thick, expanded sheet metal plates not less than 0.047 inch (1.2 mm) thick, cast iron grills or grating, extruded aluminum load-bearing vents or with hardware cloth of 0.035 inch (0.89 mm) wire or heavier. The openings therein shall not exceed 1/4 inch (6.4 mm).

**APPENDIX G**  
**FLOOD-RESISTANT CONSTRUCTION**

**CHAPTER G1**  
**GENERAL PROVISIONS**

**SECTION BC G101**  
**PURPOSE AND OBJECTIVES**

**G101.1 Purpose.** The purpose of this appendix is to promote the public health, safety and general welfare and to minimize public and private losses due to flood conditions in specific flood hazard areas through the establishment of comprehensive regulations for management of flood hazard areas designed to:

1. Prevent unnecessary disruption of commerce, access and public service during times of flooding;
2. Manage the alteration of natural flood plains, stream channels and shorelines;
3. Manage filling, grading, dredging and other development which may increase flood damage or erosion potential;
4. Prevent or regulate the construction of flood barriers which will divert floodwaters or which can increase flood hazards;
5. Contribute to improved construction techniques in the flood plain; and
6. Comply with and exceed the minimum standards of the National Flood Insurance Program as administered by the Federal Emergency Management Agency (FEMA).

**G101.2 Objectives.** The objectives of this appendix are to:

1. Protect human life;
2. Minimize the expenditure of public money for flood control projects;
3. Minimize the need for rescue and relief efforts associated with flooding;
4. Minimize prolonged business interruption;
5. Minimize damage to structures located in areas of special flood hazard;
6. Minimize damage to public facilities and utilities such as water, electricity, telephone and sewer lines, and streets and bridges located in areas of special flood hazard;

7. Help maintain a stable tax base by providing for the sound use and development of flood prone areas; and
8. Ensure that potential owners and occupants are notified that property is within areas of special flood hazard.

G101.3 Reserved.

G101.4 Reserved.

## **SECTION BC G102** **APPLICABILITY**

**G102.1 General.** This appendix, in conjunction with the *New York City Construction Codes*, provides minimum requirements for development located in areas of special flood hazard within the jurisdiction of New York City, including:

1. **Subdivisions.** This appendix shall apply to the subdivision of land;
2. **Utilities.** This appendix shall apply to the installation of utilities;
3. **Site improvements.** This appendix shall apply to site improvements, including but not limited to, temporary or permanent storage of materials, mining, dredging, filling, grading, paving, excavations, operations and other land disturbing activities;
4. **Prefabricated buildings and manufactured homes.** This appendix shall apply to placement and replacement of prefabricated buildings and manufactured homes;
5. **Post-FIRM construction.** This appendix shall apply to post-FIRM construction.;
6. **Alterations to Post-FIRM construction.** This appendix shall apply to repair, reconstruction, rehabilitation, or additions to post-FIRM construction;
7. **Substantial improvement of Pre-FIRM construction.** This appendix shall apply to substantial improvement of pre-FIRM buildings and structures, including restoration after damage, as if hereafter erected;
8. **Horizontal enlargements of pre-FIRM construction.** This appendix shall apply to horizontal enlargements of pre-FIRM buildings and structures to the extent of such horizontal enlargement, including but not limited to additions, decks, carports, or similar appendages. The existing portions of the structure shall not be required to comply, unless otherwise required because the

alteration is deemed a substantial improvement; and

**9. Other alterations to pre-FIRM construction.** This appendix shall apply to alterations or repairs to pre-FIRM buildings and structures, including installation of new components, materials, finishes and equipment, that increase the degree of noncompliance with this appendix. The following alterations or repairs, other than substantial improvements, shall not be deemed as an increase in the degree of noncompliance:

9.1. Where the alteration or repair comprises the replacement of pre-FIRM components, materials, finishes or equipment;

9.2. Where the alteration or repair comprises the installation of new components, materials, finishes or equipment in a space within the structure where similar pre-FIRM components, materials, finishes or equipment already exist; and

9.3. Where such alteration is a change in use, occupancy or how such space is used, provided that such change would not increase the degree of noncompliance with requirements of this appendix. The conversion of any space below the design flood elevation from non-habitable space into habitable space shall be deemed an increase in the degree of noncompliance.

**G102.2 Establishment of areas of special flood hazard.** The following flood hazard map and supporting data are adopted as referenced standards and declared to be a part of this appendix:

1. FEMA FIS 360497.
2. FEMA FIRMs 360497.

**G102.3 Letters of map change.** Map changes to FEMA FIRMs 360497 shall be administered in compliance with Sections G102.3.1 and G102.3.2.

**G102.3.1 Letters of map amendment (LOMA).** Where FEMA FIRMs 360497 indicates that a structure or tax lot is within a delineated area of special flood hazard, but the pre-FIRM ground elevations adjacent to the structure or throughout the tax lot are at or above the base flood elevation, the commissioner shall deem such structure or tax lot as being within the area of special flood hazard and shall not approve plans except in compliance with this appendix, unless a letter of map amendment (LOMA) is issued by FEMA removing such structure or tax lot from the area of special flood hazard.

**G102.3.2 Letter of map revision based on fill (LOMR-F).** Where FEMA FIRMs 360497 indicates that a structure or tax lot is within a delineated area of

special flood hazard, but post-FIRM compacted fill is proposed to be added adjacent to the structure or throughout the tax lot to an elevation at or above the base flood elevation, the commissioner shall deem such structure or tax lot as being within the area of special flood hazard and shall not approve plans except in compliance with this appendix, unless a conditional or final letter of map revision based on fill (LOMR-F) is issued by FEMA removing such structure or tax lot from the area of special flood hazard. The commissioner shall promulgate rules establishing procedures for processing letters of map revision based on fill (LOMR-F).

**G102.3.3 Certificates of occupancy.** Certificates of occupancy shall indicate that the structure or tax lot is subject to a letter of map amendment (LOMA) or letter of map revision based on fill (LOMR-F) as per Section G106.3.

## **SECTION BC G103** **ADMINISTRATION**

**G103.1 Permit applications.** The commissioner is hereby designated as the floodplain administrator for the City of New York and shall review permit applications to determine that:

1. Proposed development sites will be reasonably safe from flooding;
2. All site development activities, including grading, filling, utility installation and drainage modification, and all new construction and substantial improvements (including the placement of prefabricated buildings and manufactured homes) are designed and constructed with methods, practices and materials that minimize flood damage and that are in accordance with this code and ASCE 24; and
3. All other required state and federal permits have been obtained.

**G103.2 Reserved.**

**G103.3 Determination of base flood elevations.** Where the proposed development is within an area of special flood hazard but the base flood elevations are not specified in the FEMA FIRMs 360497, the commissioner shall require the applicant to request base flood elevation data from the New York State Department of Environmental Conservation (DEC); and

1. Submit to the commissioner either:
  - 1.1. A letter from DEC making such a determination of base flood elevation;  
or

- 1.2. A letter from the DEC indicating that the data are not available. When such a letter from DEC indicates that the data are not available, the base flood elevation shall be equal to 3 feet (914 mm) above the highest adjacent pre-FIRM grade.

**Exception:** Large lots. Where the base flood elevation is not specified, the applicant shall submit a detailed engineering study establishing the base flood elevation, performed by an engineer in accordance with accepted hydrologic and hydraulic engineering techniques, in sufficient detail to allow review by the commissioner for any of the following conditions:

1. For a development which is located on a tax lot greater than 5 acres (2.02 hectares), or is located on property that was part of a tax lot that was greater than 5 acres (2.02 hectares) at the time of the adoption of the FIRM (October 1, 1984), or at any subsequent applicable map change thereto; or
2. For subdivisions resulting in 50 or more tax lots, including all tax lots previously subdivided from the same tax lot since the adoption of the FIRM (October 1, 1984), or since any subsequent applicable map changes thereto.

#### **G103.4 Reserved.**

**G103.5 Floodway encroachment.** Prior to issuing a permit for any floodway encroachment, including fill, new construction, substantial improvements and other development or land-disturbing activity, the commissioner shall require submission of a certification, along with supporting technical data, demonstrating that such development will not cause any increase of the level of the base flood. However, a floodway encroachment that increases the level of the base flood may be authorized if the applicant has:

1. Applied for a conditional Letter of Map Revision; and
2. Received the approval of the Federal Emergency Management Agency (FEMA).

**G103.6 Watercourse alteration.** Prior to issuing a permit for any alteration or relocation of any watercourse within an area of special flood hazard, the commissioner shall require the applicant to:

1. Notify any affected adjacent municipalities or government jurisdictions;
2. Notify the DEC;

3. Submit evidence of such notifications to the commissioner and the Regional Director, Region II, the Federal Emergency Management Agency (FEMA);
4. Submit to the commissioner evidence of all such notifications;
5. Submit an engineering analysis demonstrating that the flood-carrying capacity of the altered or relocated portion of the watercourse will not be decreased; and
6. Submit evidence that such watercourses will be maintained in a manner which preserves the channel's flood-carrying capacity.

**G103.7 Sand dune alterations in V-Zones.** Prior to issuing a permit for any alteration of sand dunes in a V-Zone, the commissioner shall require submission of an engineering analysis demonstrating that the proposed alteration will not increase the potential for flood damage.

**G103.8 Records.** The commissioner shall maintain records of the following:

1. Applications and supporting documents for development in areas of special flood hazard;
2. Permits issued in areas of special flood hazard;
3. Inspection reports;
4. Certifications required in this appendix; and
5. Certificate of occupancy where applicable.

**G103.9 Violations.** See Chapter 2 of Title 28 of the *Administrative Code*.

## **SECTION BC G104** **PERMITS**

**G104.1 Permit required.** Any person, owner or authorized agent who intends to conduct any development, as applicable pursuant to Section G102.1, within an area of special flood hazard, shall first apply to the commissioner and shall obtain the required permit.

**G104.2 Permit application requirements.** The applicant shall file an application in writing on a form furnished by the commissioner. The commissioner shall not approve such application unless the applicant submits all plans, details, data and documents demonstrating that the development complies with Section G104 and all other provisions of this appendix.

**G104.3 Site plan.** The permit application shall include a site plan. The site plan shall include plans and drawings, shall be sealed by a registered design professional and shall include the following information and any other data as may be required by the department:

1. A delineation of the flood hazard areas, including identification of the base and design flood and elevations;
2. If applicable, the location of the regulatory floodway;
3. For all proposed structures, spot ground elevations at building corners and in 20-foot (6096 mm) or smaller intervals along the foundation footprint, or 1 foot (305 mm) contour elevations throughout the building site;
4. Proposed locations of water supply, sanitary sewer, and utilities;
5. Drainage patterns and facilities; and
6. Foundation design details, including but not limited to:
  - 6.1. Proposed elevation of the lowest floor including basement (for flood zone purposes) of all structures;
  - 6.2. For a crawl-space, parking, storage, building access and other wet floodproofed enclosures below the design flood elevation, location and total net area of foundation openings in accordance with ASCE 24;
  - 6.3. For dry floodproofed enclosures in buildings or structures that are nonresidential (for flood zone purposes), the proposed elevation to which the enclosure will be dry floodproofed in accordance with ASCE 24; and
  - 6.4. Any proposed fill and excavation details.

**Exception:** Applications for subdivisions shall comply with Section G302.

**G104.4 Water course alteration.** The permit application shall include, if applicable, a description of the extent to which any watercourse will be altered or relocated as a result of proposed development, and any documentation required by Section G103.6.

**G104.5 Certifications.** The permit application shall include the applicable certifications in accordance with Section G104.5.1 through G104.5.3.

**G104.5.1 A-Zones.** For construction in A-Zones, the permit application shall include the following certifications, as applicable:



1. **Wet floodproofing certification.** For wet floodproofed enclosures below the design flood elevation, construction documents shall include a certification by the applicant that the design provides for the automatic entry and exit of floodwaters for equalization of hydrostatic flood forces in accordance with Section 2.6.1.2, ASCE 24.
2. **Dry floodproofing certification for nonresidential buildings.** For dry floodproofed buildings and structures that are nonresidential (for flood zone purposes), construction documents shall include a certification by the applicant that the dry floodproofing is designed in accordance with ASCE 24.
3. **Utility certifications.** For all applications involving utility or mechanical work, including applications where such work is to be filed in a separate, related application, construction documents shall include a certification by the applicant that “all heating, ventilation, air conditioning, plumbing, electrical and other services facilities and equipment within the structure or site will be located or constructed so as to prevent water from entering or accumulating within the components during conditions of flooding in accordance with ASCE 24.”

**G104.5.2 V-Zones.** For construction in V-Zones the permit application shall include the following certifications, as applicable:

1. **Structural design certification.** Construction documents shall include a certification by the applicant that the “entire structure is designed in accordance with ASCE 24, including that the pile or column foundation and building or structure to be attached thereto is designed to be anchored to resist flotation, collapse and lateral movement due to the effects of wind and flood loads acting simultaneously on all building components, and other load requirements of Chapter 16 of the *New York City Building Code*.”
2. **Breakaway wall certification.** Where breakaway walls are provided, construction documents shall include a certification by applicant that “the breakaway walls meet the load requirements of Section 5.3.2.3 of ASCE 7, are designed in accordance with ASCE 24, and are of an open lattice type construction only.”
3. **Utility certifications.** For all applications involving utility or mechanical work, including applications where such work it to be filed in a separate, related application, construction documents shall include a certification by the applicant that “all heating, ventilation, air conditioning, plumbing, electrical and other services facilities and equipment within the structure or site will be located or constructed so as to prevent water from entering

or accumulating within the components during conditions of flooding, in accordance with ASCE 24.”

**G104.5.3 Floodway encroachment certification.** For any floodway encroachment, including fill, new construction, substantial improvements and other development or land-disturbing activity, the applicant shall submit a certification, along with supporting technical data, demonstrating that such development will not cause any increase of the level of the base flood in accordance with the requirements of Section G103.5.

**G104.6 Validity of permit.** The issuance of a permit under this appendix shall not be construed to be a permit for, or approval of, any violation of this appendix or any other provision of this code. The issuance of a permit based on submitted documents and information shall not prevent the commissioner from requiring the correction of errors. The commissioner is authorized to prevent occupancy or use of a structure or site which is in violation of this appendix or other provisions of this code.

**G104.7 Permit expiration.** A permit shall become invalid if the proposed development:

1. Is not commenced within 180 days after its issuance; or
2. If the work authorized is suspended or abandoned for a period of 180 days after the work commences.

**G104.8 Permit reinstatement.** Permit reinstatements shall be requested in writing. The commissioner is authorized to grant, in writing, one or more extensions of time, for periods not more than 180 days each subject to the limitations of Section 28-105.

**G104.9 Permit suspension or revocation.** The commissioner is authorized to suspend or revoke a permit issued under this appendix wherever the permit is issued in error or on the basis of incorrect, inaccurate or incomplete information, or in violation of this code, in accordance with Section 28-105.

## **SECTION BC G105**

### **SPECIAL INSPECTIONS REQUIREMENTS**

**G105.1 General.** Special inspections shall be performed in accordance with this section.

**G105.2 All work applications.** All work applications, regardless of the extent of the scope of work, shall be subject to the following special inspection:

1. **Flood zone compliance inspection.** Prior to sign off of work, a registered design professional shall certify that: “the structure was constructed” or “alterations were performed,” “with methods and practices that minimize

flood damage and that are in accordance with approved plans, and with any applicable provisions of Appendix G of the *New York City Building Code* and ASCE 24.”

**G105.3 New buildings and substantial improvements.** In addition to the flood zone compliance inspection required by Section G105.2, all applications for new buildings or substantial improvements shall be subject to the following special inspections:

1. **Elevation progress inspection.** Upon placement of the lowest floor, including the basement (for flood zone purposes), an engineer or licensed professional surveyor shall inspect the site and verify the elevation of such lowest floor. The inspection report verifying the elevation shall be submitted to the commissioner prior to further vertical construction. The commissioner shall be permitted to issue a stop work order if such inspection report is not submitted.
  
2. **Final elevation inspection.** The final elevations shall comprise either of the following, as applicable:
  - 2.1. **Elevation certificate.** Prior to sign off of work, an engineer or licensed professional surveyor shall submit to the commissioner a certification of the elevation of the lowest floor, including the basement (for flood zone purposes). Such certification shall be made utilizing FEMA Form 81-31 entitled, “Elevation Certificate.”
  
  - 2.2. **Dry floodproofing certificate.** Prior to sign off of work, an engineer or licensed professional surveyor shall submit to the commissioner a dry floodproofing certificate. Such certification shall be made utilizing FEMA Form 81-65 entitled, “Floodproofing Certification.”

**G105.3.1 Flood shield inspection.** Where floodshields or other flood control devices are installed as part of a dry floodproofing system in buildings and structures that are nonresidential (for flood zone purposes), a registered design professional shall inspect the shields or devices in their stored positions or locations, witness their activation or transportation to their installed positions, and witness their deactivation or transportation back to their stored locations. The registered design professional shall also confirm the installation of signage required by ASCE 24, Section 6.2.3, Item 3.

**G105.4 Reserved.**

**G105.5 Reserved.**

**G105.6 Reserved.**

**G105.7 Reserved.**

**SECTION BC G106**  
**CERTIFICATES OF OCCUPANCY**

**G106.1 Applicability.** This section shall apply to post-FIRM construction and substantial improvements where the work results in the issuance of a new or amended certificate of occupancy.

**G106.2 Spaces subject to flooding in A-Zones.** The certificate of occupancy shall describe all non-dry-floodproofed spaces below the design flood elevation as “subject to flooding,” including but not limited to wet floodproofed spaces usable solely for parking, storage, building access or crawl spaces.

**G106.3 Spaces subject to flooding in V-Zones.** The certificate of occupancy shall describe all spaces below the design flood elevation as “subject to flooding,” including but not limited to spaces usable solely for parking, storage, building access or crawl spaces.

**G106.4 Dry floodproofed spaces.** The certificate of occupancy shall describe any dry floodproofed spaces as “dry floodproofed”. For such buildings containing dwelling units, the certificate of occupancy shall also provide notations as required by Section G304.1.2, Item 2.2.5. Where flood shields or other flood control devices are installed, the certificate of occupancy shall also provide notations describing these features.

**G106.5 Letters of map change.** Where applicable, the certificate of occupancy shall indicate that “the structure is exempted from the area of special flood hazard pursuant to FEMA Letter of Map Amendment (LOMA) # ( \_\_\_\_\_ ),” or that “the structure is exempted from the area of special flood hazard pursuant to FEMA Letter of Map Revision Based on Fill (LOMR-F) # ( \_\_\_\_\_ ).”

**SECTION BC G107**  
**VARIANCES**

**G107.1 General.** The Board of Standards and Appeals shall hear and decide requests for variances from the requirements of this appendix. The Board of Standards and Appeals shall base its determination on technical justifications, and has the right to attach such conditions to variances as it deems necessary to further the purposes and objectives of this appendix.

**G107.2 Conditions for variance.**

**G107.2.1 Historic structures.** The Board of Standards and Appeals is authorized to issue a variance for the repair or rehabilitation of a historic structure provided that:

1. The application has received approval from the Landmark Preservation Committee and/or the New York State Historical Preservation Office, as applicable;
2. The proposed repair or rehabilitation will not preclude the structure's continued designation as a historic structure; and
3. The variance is the minimum necessary to preserve the historic character and design of the structure.

**G107.2.2 Floodway restrictions.** The Board of Standards and Appeals shall not issue a variance for any proposed development in a floodway if any increase in flood levels would result during the base flood discharge.

**G107.2.3 General conditions for variance.** Except for historic structures as provided for in Section G107.2.1, the Board of Standards and Appeals is authorized to issue a variance only upon:

1. A determination that the new construction, substantial improvement, or other proposed development is located on a tax lot that, on November 18, 1983, was no more than ½ acre (0.2 hectare) in size. However, where the tax lot has been determined to be larger than ½ acre (0.2 hectare), the technical justification required for issuing the variance increases with the lot size;
2. Showing of good and sufficient cause;
3. Determination that failure to grant the variance would result in exceptional hardship to the applicant;
4. Determination that the granting of a variance will not result in:
  - a. Increased flood heights;
  - b. Additional threats to public safety, provided, however, that the variance is permitted to increase risks to life and property for the subject structure;
  - c. Extraordinary public expense;
  - d. Nuisances;
  - e. Fraud on or victimization of the public; or
  - f. Conflict with existing local laws or ordinances; and

5. Determination that the variance is the minimum necessary, considering the flood hazard, to afford relief.

**G107.2.4 Functionally dependent facilities.** The Board of Standards and Appeals is authorized to issue a variance for the construction or substantial improvement of a functionally dependent facility provided that:

1. The criteria for Sections G107.2.1 through G107.2.3 are met; and
2. All methods and materials utilized minimize flood damage during the base flood and create no additional threats to public safety.

**G107.3 Standards for variance.** In reviewing applications for variances, the Board of Standards and Appeals shall consider all technical evaluations, all relevant factors, all other portions of this appendix and the following:

1. The danger that materials and debris may be swept onto other lands resulting in injury or damage;
2. The danger to life and property due to flooding or erosion damage;
3. The susceptibility of the proposed development, including contents, to flood damage and the effect of such damage on current and future owners;
4. The importance of the services provided by the proposed development to the community;
5. The availability of alternate locations for the proposed development that are not subject to flooding or erosion;
6. The relationship of the proposed development to the comprehensive plan and flood plain management program for that area;
7. The safety of access to the property in times of flood for ordinary and emergency vehicles;
8. The expected heights, velocity, duration, rate of rise and debris and sediment transport of the floodwaters and the effects of wave action, if applicable, expected at the site; and
9. The costs of providing governmental services during and after flood conditions including maintenance and repair of public utilities and facilities such as sewer, gas, electrical and water systems, streets and bridges.

**G107.4 Notification of risks.** Upon issuance of a variance, the Executive Director of the Boards of Standards and Appeals shall provide written notice to the owner and

the applicant that:

1. The issuance of a variance to construct a structure below the base flood level will result in increased premium rates for flood insurance; and
2. That such construction below the base flood level increases risks to life and property.

**G107.5 Records.** The Board of Standards and Appeals shall:

1. Maintain a record of all variance actions, including justification for their issuance; and
2. Report such variances issued in its biennial report submitted to the Federal Emergency Management Agency.

## **CHAPTER G2** **DEFINITIONS**

### **SECTION BC G201** **DEFINITIONS**

**G201.1 General.** The following words and terms shall, for the purposes of this appendix, have the meanings shown herein.

#### **G201.2 Definitions.**

**A-ZONE.** An area of special flood hazard without high velocity wave action. When not shown on the FIRMs, the water surface elevation may be determined from available data by the registered design professional of record in accordance with Section G103.3. See also “Area of special flood hazard.”

**AREA OF SPECIAL FLOOD HAZARD.** The land in the flood plain delineated as subject to a one percent or greater chance of flooding in any given year. Such areas are designated on the Flood Insurance Rate Map (FIRM) as A-Zones or V-Zones. Such areas are also known as the base flood plain or one hundred year flood plain. Areas designated as X-Zones shall not be deemed areas of special flood hazard for the purposes of this Appendix.

**BASE FLOOD.** The flood having a 1-percent chance of being equaled or exceeded in any given year.

**BASE FLOOD ELEVATION.** The elevation of the base flood, including wave height, as specified on FEMA FIRMs 360497 or as determined in accordance with Section G103.3, relative to the National Geodetic Vertical Datum (NGVD).

**BASEMENT (FOR FLOOD ZONE PURPOSES).** The portion of a building having its floor subgrade (below ground level) on all sides.

**BREAKAWAY WALL.** An open lattice wall that is not part of the structural support of the building to which it is attached and that is intended through its design and construction to collapse under specific later loading forces without causing damage to the elevated portion of the building or the supporting foundation system.

**DESIGN FLOOD ELEVATION.** The applicable elevation specified in ASCE 24, Tables 2-1, 4-1, 5-1, 6-1, or 7-1, depending on the structure category designated in ASCE 24, Table 1-1

**DEVELOPMENT.** Any man-made change to improved or unimproved real estate, including but not limited to, buildings or other structures, temporary or permanent storage of materials, mining, dredging, filling, grading, paving, excavations, operations and other land disturbing activities.

**EXISTING CONSTRUCTION.** See “PRE-FIRM DEVELOPMENT.”

**EXISTING STRUCTURE.** See “PRE-FIRM DEVELOPMENT”.

**FLOOD or FLOODING.** A general and temporary condition of partial or complete inundation of normally dry land from:

1. The overflow of inland or tidal waters.
2. The unusual and rapid accumulation or runoff of surface waters from any source.

**FLOOD-DAMAGE-RESISTANT MATERIALS.** Any construction material, including finishes, capable of withstanding direct and prolonged contact with floodwaters without sustaining any damage that requires more than cosmetic repair.

**FLOOD INSURANCE RATE MAP (FIRM).** The official map on which the Federal Emergency Management Agency (FEMA) has delineated areas of special flood hazard, base flood elevations, and the flood boundary and floodways.

**FLOOD INSURANCE STUDY (FIS).** The official report provided by the Federal Emergency Management Agency (FEMA) containing the Flood Insurance Rate Map (FIRM), the water surface elevation of the base flood and supporting technical data.

**FLOODPROOFING, DRY.** For buildings and structures that are nonresidential (for flood zone purposes), a combination of design modifications that results in the building's or structure's being water tight to the design flood elevation, including the attendant utility and sanitary facilities, with walls substantially impermeable to the



passage of water and with structural components having the capacity to resist loads as identified in ASCE 7.

**FLOODPROOFING, WET.** A floodproofing method designed to permit parts of the structure below the design flood elevation that are used for parking, storage, building access, or crawl space to intentionally flood, by equalizing hydrostatic pressures and by relying on the use of flood-damage-resistant materials and construction techniques.

**FLOODWAY.** The channel of the river, creek or other watercourse and the adjacent land areas that must be reserved in order to discharge the base flood without cumulatively increasing the water surface elevation more than a designated height. Floodways are mapped only in the Boroughs of the Bronx and Staten Island.

**FUNCTIONALLY DEPENDENT FACILITY.** A facility that cannot be used for its intended purpose unless it is located or carried out in close proximity to water, such as a docking or port facility necessary for the loading or unloading of cargo or passengers, shipbuilding or ship repair. The term does not include long-term storage, manufacture, sales or service facilities.

**HISTORIC STRUCTURE.** A pre-FIRM building or structure:

1. Designated as a landmark or located within an historic district designated by the New York City Landmarks Preservation Commission; or
2. Listed or preliminarily determined to be eligible for listing in the National or State Register of Historic Places; or
3. Determined by the Secretary of the U.S. Department of the Interior or the New York State Department of Parks and Recreation as contributing to the historical significance of a registered historic district or a district preliminarily determined to qualify as an historic district.

**LETTER OF MAP AMENDMENT (LOMA).** An official amendment to the FIRM, issued and approved by the Federal Emergency Management Agency (FEMA), removing structures or tax lots from areas of special flood hazard, resulting from a demonstration that the Pre-FIRM ground elevations are at or above the base flood elevation.

**LETTER OF MAP REVISION BASED ON FILL (LOMR-F).** An official amendment to the FIRM, issued and approved by the Federal Emergency Management Agency (FEMA), removing structures or tax lots from areas of special flood hazard, resulting from the Post-FIRM placement of compacted fill, such that the new ground elevation is at or above the base flood elevation.

**LOWEST FLOOR.** The floor of the lowest enclosed area, including crawl spaces

and basements (for flood zone purposes).

**Exception:** The lowest floor shall not include any wet floodproofed spaces usable solely for vehicle parking, building access, storage or crawl space, provided that such enclosure is not built so as to render the structure in violation of this appendix, including that:

1. Such enclosure shall allow for the automatic entry and exit of floodwaters;
2. Such enclosure shall be constructed solely of flood resistant materials and finishes;
3. Such enclosure shall have a floor elevation equal to or higher than the outside adjacent grade on at least one side; and
4. Such outside adjacent grade shall slope down, towards the source of flooding, providing positive drainage by gravity, thus preventing accumulations of water under or in the structure after the floodwaters recede without the use of pumps, pipes or drains.

**MANUFACTURED HOME.** A structure that is transportable in one or more sections, built on a permanent chassis, designed for use with or without a permanent foundation when attached to the required utilities, and constructed to the Federal Mobile Home Construction and Safety Standards and rules and regulations promulgated by the U.S. Department of Housing and Urban Development. The term also includes mobile homes, park trailers, travel trailers and similar transportable structures that are placed on a site for 180 consecutive days or longer.

**MANUFACTURED HOME PARK OR SUBDIVISION.** A parcel (or contiguous parcels) of land divided into two or more manufactured home lots for rent or sale.

**MARKET VALUE OF STRUCTURE.** The price that a buyer is willing, but is not under any duty, to pay for a particular structure to an owner who is willing, but not obligated, to sell, exclusive of the value of the land, or of other buildings or structures on the same tax lot. The market value of a structure shall be determined in accordance with rules promulgated by the commissioner.

**NATIONAL GEODETIC VERTICAL DATUM (NGVD).** The national vertical datum standard established in 1929, used as a reference for establishing elevations within a flood plain.

**NEW CONSTRUCTION.** See “POST-FIRM DEVELOPMENT.”

**NONRESIDENTIAL (FOR FLOOD ZONE PURPOSES).** A building or structure that either:

1. Contains no space classified in Groups I-1, R-1, R-2, or R-3, and contains no space that is accessory, as such term is defined in the New York City Zoning Resolution, to any I-1, R-1, R-2, or R-3 occupancy; or
2. Contains such space(s), but also contains space on the lowest floor that is not accessory, as such term is defined in the New York City Zoning Resolution, to an I-1, R-1, R-2, or R-3 occupancy.

**PRE-FIRM DEVELOPMENT.** Any development:

1. Completed prior to November 13, 1983;
2. Under construction on November 13, 1983 provided that the start of construction was prior to said date; or
3. Completed on or after November 13, 1983 but that:
  - 3.1. Was not located within an area of special flood hazard at the start of construction; and
  - 3.2. Is now located within an area of special flood hazard as a result of a subsequent change to the FIRM.

**PRE-FIRM STRUCTURE.** See “PRE-FIRM DEVELOPMENT.”

**POST-FIRM DEVELOPMENT.** Any development that is not pre-FIRM development.

**POST-FIRM STRUCTURE.** See “POST-FIRM DEVELOPMENT.”

**RECREATIONAL VEHICLE.** A vehicle that is built on a single chassis, 400 square feet (37.16 m<sup>2</sup>) or less when measured at the largest horizontal projection, designed to be self-propelled or permanently towable by a light-duty truck, and designed primarily not for use as a permanent dwelling but as temporary living quarters for recreational, camping, travel or seasonal use. A recreational vehicle is ready for highway use if it is on its wheels or jacking system, is attached to the site only by quick disconnect-type utilities and security devices and has no permanently attached additions.

**RESIDENTIAL (FOR FLOOD ZONE PURPOSES).** A building or structure containing any space that is either:

1. Classified in Groups I-1, R-1, R-2, or R-3; or
2. Accessory, as such term is defined in the New York City Zoning Resolution, to any I-1, R-1, R-2, or R-3 occupancy.

**Exception:** Such a building or structure shall be considered nonresidential (for flood zone purposes) when also containing space on the lowest floor that is not accessory, as such term is defined in the New York City Zoning Resolution, to an I-1, R-1, R-2, or R-3 occupancy.

**SAND DUNES.** Naturally occurring accumulations of sand in ridges or mounds landward of a beach.

**SPECIAL FLOOD HAZARD AREA.** See “Area of Special Flood Hazard.”

**START OF CONSTRUCTION.** The date of permit issuance for: (i) post-FIRM developments; (ii) substantial improvements to pre-FIRM structures; and (iii) those pre-FIRM developments that, at the time of permit issuance, were not within an area of special flood hazard but that, prior to completion, were within an area of special flood hazard as a result of map change; provided the actual commencement of construction, repair, reconstruction, rehabilitation, addition, placement or other improvement is within 180 days after the date of permit issuance and such construction activity is not thereafter suspended or abandoned for 180 days or more. For the purposes of this definition:

1. The actual commencement of construction means the first placement of permanent construction of a building (including a manufactured home or prefabricated building) on a site, such as the pouring of a slab or footings, installation of pilings or construction of columns.
2. Permanent construction does not include land preparation (such as clearing, excavation, grading or filling), the installation of streets or walkways, excavation for a basement (for flood zone purposes), footings, piers or foundations, the erection of temporary forms or the installation of accessory buildings such as garages or sheds not occupied as dwelling units or not part of the main building.
3. For a substantial improvement, the actual commencement of construction means the first alteration of any wall, ceiling, floor or other structural part of a building, regardless of whether that alteration affects the external dimensions of the building.

**SUBSTANTIAL DAMAGE.** Damage of any origin sustained by a structure whereby the cost of restoring the structure to its before-damaged condition would equal or exceed 50 percent of the market value of the structure before the damage occurred.

**SUBSTANTIAL IMPROVEMENT.** Any repair, reconstruction, rehabilitation, addition or improvement of a building or structure, the cost of which equals or exceeds 50 percent of the market value of the structure before the improvement or repair is started. If the structure has sustained substantial damage, any repairs are considered substantial improvement regardless of the actual repair work performed.

The term does not, however, include either:

1. Any project for improvement of a building required to correct pre-FIRM health, sanitary or safety code violations identified by the commissioner, the Fire Commissioner, the Commissioner of Housing Preservation and Development, or the Commissioner of Health and Mental Hygiene, and that are the minimum necessary to assure safe living conditions; or
2. Any alteration of a historic structure provided that the alteration will not preclude the structure's continued designation as a historic structure.

V-ZONE. An area of special flood hazard subject to high velocity wave action.

### **CHAPTER G3** **CONSTRUCTION STANDARDS**

#### **SECTION BC G301** **GENERAL**

**G301.1 All Developments.** To the extent required by Section G102.1, all developments, including but not limited to utility installation, site improvements, placement of prefabricated buildings and manufactured homes, new building construction, alterations and repairs, shall be designed and constructed to resist the effects of flood hazards and flood loads in accordance with this appendix and ASCE 24.

**G301.1.1 Multiple flood zones.** For a structure that is located in more than one zone (for instance both an A-Zone and an X-Zone, or both an A-Zone and a V-Zone), the provisions associated with the most restrictive area of special flood hazard shall apply to the entire structure.

**G301.2 Reserved.**

#### **SECTION BC G302** **SUBDIVISIONS**

**G302.1 General.** Any subdivision proposal, including proposals for manufactured home parks and subdivisions, or other proposed new development within an area of special flood hazard shall demonstrate that:

1. All such proposals are consistent with the need to minimize flood damage;
2. All public utilities and facilities, such as sewer, gas, electric and water systems are located and constructed to minimize or eliminate flood damage;  
and

3. Adequate drainage is provided to reduce exposure to flood hazards.

**G302.2 Subdivision requirements.** The following requirements shall apply to any proposed subdivision, including proposals for manufactured home parks and subdivisions, any portion of which lies within an area of special flood hazard:

1. The area of special flood hazard, including floodways and V-Zones, as appropriate, shall be delineated on tentative and final subdivision plats;
2. Base flood elevations shall be shown on tentative and final subdivision plats;
3. Building lots shall be provided with adequate buildable area, in accordance with the New York City Zoning Resolution, outside the floodway; and
4. The design criteria for any utilities and facilities, as set forth in this appendix and appropriate *New York City Construction Codes*, shall be met.

### **SECTION BC G303** **SITE IMPROVEMENT**

**G303.1 Development in floodways.** Development or land disturbing activity is prohibited in floodways unless it has been demonstrated through hydrologic and hydraulic analyses performed in accordance with standard engineering practice that the proposed encroachment will not result in any increase in the level of the base flood, in accordance with Section G103.5.

**G303.2 Sewer facilities.** All new and replaced sanitary sewer facilities, private sewage treatment plants (including all pumping stations and collector systems) and on-site waste disposal systems shall be designed in accordance with Chapter 8, ASCE 24, to minimize or eliminate infiltration of floodwaters into the facilities and discharge from the facilities into floodwaters, or impairment of the facilities and systems.

**G303.3 Water facilities.** All new and replacement water facilities shall be designed in accordance with the provisions of Chapter 8, ASCE 24, to minimize or eliminate infiltration of floodwaters into the systems.

**G303.4 Storm drainage.** Storm drainage shall be designed to convey the flow of surface waters to minimize or eliminate damage to persons or property and shall meet the requirements of ASCE 24.

**G303.5 Streets and sidewalks.** Streets and sidewalks shall be designed to minimize potential for increasing or aggravating flood levels and shall meet the requirements of Section G303.7.

**G303.6 Retaining walls and driveways.** Retaining walls and driveways shall meet the requirements of Section G303.7.

**G303.7 Grading and fill.** In areas of special flood hazard grading and/or fill shall not be approved:

1. Unless such fill is placed, compacted and sloped to minimize shifting, slumping and erosion during the rise and fall of flood water and, as applicable, wave action, in accordance with ASCE 24.
2. In floodways, unless it has been demonstrated through hydrologic and hydraulic analyses performed by an engineer in accordance with standard engineering practice that the proposed grading or fill, or both will not result in any increase in the flood levels during the occurrence of the design flood, in accordance with Section G103.5.
3. In V-Zones, unless such fill is conducted and or placed to avoid diversion of water and waves towards any building or structure.

## **SECTION BC G304**

### **POST-FIRM CONSTRUCTION AND SUBSTANTIAL IMPROVEMENTS**

**G304.1 A-Zone construction standards.** The following standards shall apply to post-FIRM construction and substantial improvements located within A-Zones.

**G304.1.1 Residential.** For buildings or structures that are residential (for flood zone purposes), all post-FIRM new buildings and substantial improvements shall comply with the applicable requirements in Chapter G3 and ASCE 24, and shall be elevated as follows:

1. **Lowest floor.** The lowest floor, including the basement (for flood zone purposes), shall be elevated to at or above the design flood elevation specified in ASCE 24, Table 2-1;
2. **Enclosures below the design flood elevation.** Enclosed spaces below the design flood elevation specified in ASCE 24, Table 2-1 shall be useable solely for parking of vehicles, building access, storage, or crawlspace, and shall be wet floodproofed in accordance with ASCE 24. Breakaway walls are not required in A-Zones.
3. **Materials.** Only flood-damage-resistant materials and finishes shall be utilized below the design flood elevation specified in ASCE 24, Table 5-1;
4. **Utilities and equipment.** Utilities and attendant equipment shall be located at or above the design flood elevation specified in ASCE 24, Table 7-1, or shall be constructed so as to prevent water from entering or

accumulating within the components during conditions of flooding in accordance with ASCE 24;

5. **Certifications.** Applications shall contain applicable certifications in accordance with Section G104.5; and
6. **Special inspections.** Special inspections shall be as required by Section G105.

**G304.1.2 Nonresidential.** For buildings or structures that are nonresidential (for flood zone purposes), all post-FIRM new buildings and substantial improvements shall comply with the applicable requirements in Chapter G3 and ASCE 24, and shall comply with either of the following:

1. **Elevation option.** The structure shall comply with Items 1 through 6 of Section G304.1.1; or
2. **Dry floodproofing option.** The structure shall comply with the following:
  - 2.1. **Elevation of dry floodproofing.** The structure shall be dry floodproofed to at or above the design flood elevation specified in ASCE 24, Table 6-1;
  - 2.2. **Dwelling units.** Where dwelling units are located in a building utilizing the dry floodproofing option, the following additional requirements shall be met:
    - 2.2.1. All rooms and spaces within dwelling units shall be located at or above the design flood elevation;
    - 2.2.2. No more than one toilet and one sink shall be located below the design flood elevation. Any such toilet room shall not be located within a dwelling unit and shall be no larger than required by Chapter 11; and no roughing therein shall be permitted to accommodate additional fixtures;
    - 2.2.3. No more than one two-compartment laundry tray shall be permitted below the design flood elevation;
    - 2.2.4. No kitchens or kitchenettes shall be permitted below the design flood elevation;
    - 2.2.5. A restrictive declaration noting the above restrictions shall be filed with the City Register or County Clerk, and the page number and liber number shall be identified in the permit application and on the certificate of occupancy.



2.3. **Utilities and equipment.** Utilities and attendant equipment shall be located within the dry floodproofed enclosure, or may be located outside the dry floodproofed enclosure provided that they are located at or above the design flood elevation specified in ASCE 24, Table 7-1 or are constructed so as to prevent water from entering or accumulating within the components during conditions of flooding in accordance with ASCE 24.

2.4. **Certifications.** Applications shall contain applicable certifications in accordance with Section G104.5; and

2.5. **Special inspections.** Special inspections shall be as required by Section G105.

**G304.2 V-Zone construction standards.** In addition to the requirements of ASCE 24, the following standards shall apply to post-FIRM construction and substantial improvements located within V-Zones.

1. **Foundation.** The lowest floor shall be elevated on adequately anchored pilings or columns and securely anchored to such piles or columns to prevent floatation, collapse and lateral movement resulting from wind and flood loads acting simultaneously on all building components, and other load requirements of Chapter 16 and this appendix.

2. **Lowest horizontal member.** The lowest portion of the lowest horizontal structural member of the lowest floor (excluding the pilings or columns) shall be at or above the design flood elevation specified in ASCE 24, Table 4-1.

3. **Below the lowest horizontal member.** Spaces below the lowest horizontal member shall be either:

3.1. Free of obstructions; or

3.2. Enclosed with breakaway walls providing unconditioned space useable solely for parking of vehicles, building access, storage or crawl space. Such breakaway walls shall:

3.2.1. Be of an open lattice type construction only;

3.2.2. Meet the load requirements of Section 5.3.2.3 of ASCE 7; and

3.2.3. Meet the additional requirements of ASCE 24.

4. **Materials.** Only flood-damage-resistant materials and finishes shall be utilized below the design flood elevation specified in ASCE 24, Table 5-1;
5. **Utilities and equipment.** Utilities and attendant equipment shall be located at or above the design flood elevation specified in ASCE 24, Table 7-1, or shall be constructed so as to both resist the wave action and prevent water from entering or accumulating within the components during conditions of flooding in accordance with ASCE 24;
6. **Prohibitions.** The following shall be prohibited in V-Zones:
  - 6.1. Development, including land disturbing activities, seaward of the reach of mean high tide;
  - 6.2. Use of fill for structural support of buildings; and
  - 6.3. Man-made alterations of sand dunes that would increase potential damage to buildings.
7. **Certifications.** Applications shall contain applicable certifications in accordance with Section G104.5; and
8. **Special inspections.** Special inspections shall be as required by Section G105.

## **SECTION BC G305** **MANUFACTURED HOMES.**

**G305.1 General.** Manufactured homes shall be prohibited in V-Zones. Within A-Zones, all new, replaced or substantially improved manufactured homes shall be:

1. Installed using methods and practices that minimize flood damage;
2. Elevated to or above the design flood elevation specified in ASCE 24, Table 2-1;
3. Placed on a permanent, reinforced foundation that is designed in accordance with ASCE 24;
4. Securely anchored to a foundation system designed to resist floatation, collapse and lateral movement. Methods of anchoring are authorized to include, but are not limited to, use of over-the-top or frame ties to ground anchors. This requirement is in addition to applicable state and local anchoring requirements for resisting wind forces.

## **SECTION BC G306**

## **RECREATIONAL VEHICLES**

**G306.1 General.** The following shall apply to placement of all recreational vehicles within areas of special flood hazard:

- 1. Placement in V-Zones and floodways prohibited.** The placement of recreational vehicles is prohibited in V-Zones and floodways.
- 2. Temporary placement in A-Zones.** Within A-Zones, recreational vehicles shall be fully licensed and ready for highway use, and shall be placed on a site for less than 180 consecutive days.
- 3. Permanent placement in A-Zones.** Within A-Zones, recreational vehicles that are not fully licensed and ready for highway use, or that are to be placed on a site for 180 or more consecutive days, shall meet the requirements of Section G305 for manufactured homes.

## **SECTION BC G307**

### **TANKS**

**G307.1 Underground tanks.** Underground tanks in areas of special flood hazard shall be designed, constructed, installed, and anchored to prevent flotation, collapse and lateral movement resulting from hydrostatic loads, including the effects of buoyancy, during conditions of flooding to the design flood elevation, in accordance with ASCE 24.

**G307.2 Above-ground tanks.** Above-ground tanks in areas of special flood hazard shall be:

- 1. Elevated to or above the design flood elevation specified in ASCE 24, Table 7-1; or**
- 2. Designed, constructed, installed, and anchored to prevent flotation, collapse and lateral movement resulting from hydrodynamic and hydrostatic loads, including the effects of buoyancy, during conditions of flooding to the design flood elevation, in accordance with ASCE 24.**

**G307.3 Tank inlets and vents.** In areas of special flood hazard, tank inlets, fill openings, outlets and vents shall be:

- 1. Installed at or above the design flood elevation specified in ASCE 24, Table 7-1, or fitted with covers designed to prevent the inflow of floodwater and outflow of the contents of the tanks during conditions of flooding to the design flood elevation, in accordance with ASCE 24; and**

2. Anchored to prevent lateral movement resulting from hydrodynamic and hydrostatic loads, including the effects of buoyancy, during conditions of flooding to the design flood elevation, in accordance with ASCE 24.

**SECTION BC G308**  
**OTHER DEVELOPMENT**

**G308.1 Accessory structures.** Accessory structures shall be anchored to prevent flotation, collapse and lateral movement resulting from hydrostatic loads, including the effects of buoyancy, during conditions of flooding to the design flood elevation. Enclosed accessory structures usable solely for parking or storage shall be wet floodproofed and shall have flood openings to allow for the automatic entry and exit of flood waters designed in accordance with ASCE 24.

**G308.2 Fences in floodways.** Fences in floodways that may block the passage of floodwaters, such as stockade fences and wire mesh fences, shall meet the requirement of Section G103.5.

**G308.3 Oil derricks.** Oil derricks located in areas of special flood hazard shall be designed in conformance with ASCE 24.

**G308.4 Prefabricated swimming pools in floodways.** Prefabricated swimming pools in floodways shall meet the requirements of Section G103.5.

**CHAPTER G4**  
**REFERENCED STANDARDS**

**SECTION BC G401**  
**REFERENCED STANDARDS.**

**G401.1** Reserved.

**G401.2** Reserved.

**G401.3** Reserved.

**G401.4** Reserved.

**G401.5** Reserved.

**G401.6** Reserved.

ASCE 7-02      Minimum Design Loads for Buildings and Other Structures      G104.5.2,      G201.2,  
G304.2

ASCE 24-05\*      Flood Resistant Design and Construction      G103.1,      G104.3,

			<u>G104.5.1,</u> <u>G104.5.2,</u> <u>G105.2,</u> <u>G105.3.1,</u> <u>G201.2,</u> <u>G301.1,</u> <u>G303.2,</u> <u>G303.3,</u> <u>G303.4,</u> <u>G303.7,</u> <u>G304.1.1,</u> <u>G304.1.2,</u> <u>G304.2,</u> <u>G305.1,</u> <u>G307.1,</u> <u>G307.2,</u> <u>G307.3,</u> <u>G308.1,</u> <u>G308.3</u>
<u>FEMA</u>	<u>FIS</u>	<u>Flood Insurance Study, Community Number</u>	<u>G102.2</u>
<u>360497</u>		<u>360497, Revised May 21, 2001;</u> <u>Federal Emergency Management Agency</u>	
<u>FEMA</u>	<u>FIRMS</u>	<u>1) Flood Insurance Rate Map, Community</u>	<u>G102.2,</u> <u>G102.3,</u>
<u>360497</u>		<u>Number 360497, Panel Numbers 1 through</u>	<u>G102.3.1,</u> <u>G102.3.2,</u>
		<u>153, Revised May 21, 2001;</u>	<u>G103.3, G201.2</u>
		<u>Federal Emergency Management Agency</u>	
		<u>2) Letter of Map Revision, revising FIRM</u>	
		<u>Panel 149, FEMA Case #01-02-045P,</u>	
		<u>effective July 3, 2002.</u>	
<u>FEMA</u>	<u>FORM</u>	<u>Elevation Certificate;</u>	<u>G105.3</u>
<u>81-31</u>		<u>Federal Emergency Management Agency</u>	
<u>FEMA</u>	<u>FORM</u>	<u>Floodproofing Certification;</u>	<u>G105.3</u>
<u>81-65</u>		<u>Federal Emergency Management Agency</u>	
<u>HUD 24</u>	<u>CFR</u>	<u>Manufactured Home</u>	<u>G201.2</u>
<u>Part 3280-94</u>		<u>Construction and Safety Standards, 1994</u>	

\*As modified in Chapter G5.

## **CHAPTER G5** **MODIFICATIONS TO REFERENCED STANDARDS**

### **SECTION BC G501** **MODIFICATIONS.**

The following amendments are hereby made to the Referenced Standards listed in Section G401.

**G501.1 Amendments to ASCE 24-05.** The following amendments are hereby made to the applicable sections of ASCE 24-05:

**Section 1.1.** Section 1.1 (Scope) is amended by deleting Items 1 through 4, and by adding the following paragraph to read as follows:

The scope of this standard is as provided for in Section G102.1 of the *New York City Building Code*, Appendix G.

**Section 1.1.1.** A new Section 1.1.1 is added to read as follows:

**1.1.1 A-Zones.** Notwithstanding any other provision in this standard, no special flood hazard area in New York City shall be classified as a Coastal A-Zone. All areas of special flood hazard that are identified on the FIRM as an A-Zone shall be classified as flood hazard areas that are “other than coastal high hazard area or coastal A-Zones”, and shall comply with the applicable items in Section 1.1 as such.

**Section 1.1.2.** A new Section 1.1.2 is added to read as follows:

**1.1.2 High Risk Flood Hazard Areas.** Notwithstanding any other provision in this standard, no special flood hazard in New York City shall be classified as alluvial fan area, flash flood area, mudslide area, ice jam and debris area, erosion-prone area, high velocity flow area. The only applicable High Risk Flood Hazard Areas in New York City are the Coastal High Hazard Areas (V-Zones).

**Section 1.2.** Section 1.2 (Definitions) is amended by modifying only the following definitions:

**Coastal A Zone—Reserved.**

**Design Flood Elevation—**The applicable elevation specified in Table 2-1, 4-1, 5-1, 6-1, or 7-1, depending on the structure category designated in Table 1-1.

**High Risk Flood Hazard Area—**An area designated as a *coastal high hazard area*, being those areas identified on the FIRM as a *V-Zone*.

**Nonresidential—**As defined in Section G201 of the *New York City Building Code*, Appendix G.

**Residential—**As defined in Section G201 of the *New York City Building Code*, Appendix G.

**Section 1.4.3.** Table 1-1 of Section 1.4.3 (Classification of Structures) is amended to read as follows:

Table 1-1. Classification of Structures for Flood-Resistant Design and Construction (Classification same as *New York City Building Code* Table 1604.5)

<u>Nature of Occupancy</u>	<u>Category</u>
----------------------------	-----------------

	<u>Y</u>
<u>Buildings and other structures that represent a low hazard to human life in the event of failure including, but not limited to:</u>	<u>I</u>
<ul style="list-style-type: none"> <li>• <u>Agricultural facilities</u></li> <li>• <u>Certain temporary facilities</u></li> <li>• <u>Minor storage facilities</u></li> </ul>	
<u>Buildings and other structures except those listed in Categories I, III and IV</u>	<u>II</u>
<u>Buildings and other structures that represent a substantial hazard to human life in the event of failure including, but not limited to:</u>	<u>III</u>
<ul style="list-style-type: none"> <li>• <u>Buildings and other structures where more than 300 people congregate in one area</u></li> <li>• <u>Buildings and other structures with elementary school, secondary school or day care facilities with an occupant load greater than 250</u></li> <li>• <u>Buildings and other structures with an occupant load greater than 500 for colleges or adult education facilities</u></li> <li>• <u>Health care facilities with an occupant load of 50 or more resident patients but not having surgery or emergency treatment facilities</u></li> <li>• <u>Jails and detention facilities</u></li> <li>• <u>Power-generating stations, water treatment for potable water, waste water treatment facilities and other public utility facilities not included in Category IV</u></li> <li>• <u>Buildings and other structures not included in Category IV containing sufficient quantities of toxic or explosive substances to be dangerous to the public if released</u></li> </ul>	
<u>Buildings and other structures designed as essential facilities including, but not limited to:</u>	<u>IV</u>
<ul style="list-style-type: none"> <li>• <u>Hospitals and other health care facilities having surgery or emergency treatment facilities</u></li> <li>• <u>Fire, rescue and police stations and emergency vehicle garages</u></li> <li>• <u>Designated earthquake, hurricane or other emergency shelters</u></li> <li>• <u>Designated emergency preparedness, communication, and operation centers and other facilities required for emergency response</u></li> <li>• <u>Power-generating stations and other public utility facilities required as emergency backup facilities for Category IV structures</u></li> <li>• <u>Structures containing highly toxic materials as defined by Section 307 where the quantity of the material exceeds the maximum allowable quantities of Table 307.7(2) of the <i>New York City Building Code</i></u></li> <li>• <u>Aviation control towers, air traffic control centers and emergency aircraft hangars</u></li> <li>• <u>Buildings and other structures having critical national defense functions</u></li> <li>• <u>Water treatment facilities required to maintain water pressure for fire suppression</u></li> </ul>	

**Section 2.3.** Table 2-1 of Section 2.3 (Elevation Requirements) is amended to read as follows:

Table 2-1. Minimum Elevation of the Top of Lowest Floor Relative to Design Flood Elevation (DFE)—A-Zones<sup>a</sup>

<u>Structure Category<sup>b</sup></u>	<u>Minimum Elevation of Lowest Floor</u>
<u>I</u>	<u>DFE = BFE</u>
<u>II<sup>c</sup></u>	<u>DFE = BFE</u>
<u>III<sup>c</sup></u>	<u>DFE = BFE + 1 ft</u>
<u>IV<sup>c</sup></u>	<u>DFE = BFE + 2 ft</u>

<sup>a</sup>Minimum elevations shown in Table 2-1 do not apply to V Zones (see Table 4-1). Minimum elevations shown in Table 2-1 apply to A-Zones unless specific elevation requirements are given in Section 3 of this Standard.

<sup>b</sup>See Table 1-1, or Table 1604.5 of the *New York City Building Code*, for category descriptions.

<sup>c</sup>For nonresidential buildings and nonresidential portions of mixed-use buildings, the lowest floor shall be allowed below the minimum elevation if the structure meets the floodproofing requirements of Section 6.

**Section 4.1.1.** Section 4.1.1 (Identification of Coastal High Hazard Areas and Coastal A Zones) is amended to read as follows:

**4.1.1 Identification of Coastal High Hazard Areas and Coastal A Zones.** For the purposes of this standard, “Coastal High Hazard Areas” shall mean those locations where an area has been designated as subject to high velocity wave action on a community’s flood hazard map (V-Zones). No special flood hazard area in New York City shall be classified as a Coastal A-Zone.

**Section 4.4.** Table 4-1 of Section 4.4 (Elevation Requirements) is amended to read as follows:

Table 4-1. Minimum Elevation of Bottom of Lowest Supporting Horizontal Structural Member of Lowest Floor Relative to Design Flood Elevation (DFE)—V Zones

<u>Structure Category<sup>a</sup></u>	<u>Member Orientation Relative to the Direction of Wave Approach</u>	
	<u>Parallel<sup>b</sup></u>	<u>Perpendicular<sup>b</sup></u>
<u>I</u>	<u>DFE = BFE</u>	<u>DFE = BFE</u>
<u>II</u>	<u>DFE = BFE</u>	<u>DFE = BFE</u>
<u>III</u>	<u>DFE = BFE + 1 ft</u>	<u>DFE = BFE + 2 ft</u>
<u>IV</u>	<u>DFE = BFE + 1 ft</u>	<u>DFE = BFE + 2 ft</u>

<sup>a</sup> See Table 1-1, or Table 1604.5 of the *New York City Building Code*, for category descriptions.

<sup>b</sup>Orientation of lowest horizontal structural member relative to the general direction of wave approach; parallel shall mean less than or equal to +20 degrees from the direction of approach; perpendicular shall mean greater than +20 degrees from the direction of approach.



**Section 4.6.1.** Section 4.6.1 (Breakaway Walls) is amended by adding the following sentence:

All breakaway walls enclosing spaces below the DFE in V-Zones shall be open lattice, and not solid, with such enclosed spaces constructed as unconditioned per the *New York State Energy Conservation Construction Code*.

**Section 5.1.** Table 5-1 of Section 5.1 (Materials, General) is amended to read as follows:

Table 5-1. Minimum Elevation, Relative to Design Flood Elevation (DFE), Below which Flood-Damage-Resistant Materials Shall Be Used

Structure Category <sup>a</sup>	A-Zone	V-Zones	
		Orientation Parallel <sup>b</sup>	Orientation Perpendicular <sup>b</sup>
I	DFE = BFE	DFE = BFE	DFE = BFE
II	DFE = BFE	DFE = BFE	DFE = BFE
III	DFE = BFE + 1 ft	DFE = BFE + 2 ft	DFE = BFE + 3 ft
IV	DFE = BFE + 2 ft	DFE = BFE + 2 ft	DFE = BFE + 3 ft

<sup>a</sup> See Table 1-1, or Table 1604.5 of the *New York City Building Code*, for category descriptions.

<sup>b</sup> Orientation of lowest horizontal structural member relative to the general direction of wave approach; parallel shall mean less than or equal to +20 degrees from the direction of approach; perpendicular shall mean greater than +20 degrees from the direction of approach.

**Section 5.2.6.** Section 5.2.6 (Finishes) shall be amended to read as follows:

**5.2.6 Finishes and other materials.** Interior and exterior finishes, as well as any materials not otherwise provided for in Sections 5.2.1 through 5.2.5, shall be flood-damage-resistant materials in Accordance with FEMA Technical Bulletin 2-93, Flood resistant Materials Requirement for Buildings Located in Special Flood Hazard Areas, or shall be required to be approved by the authority having jurisdiction.

**Section 6.2.** Table 6-1 of Section 6.2 (Dry Floodproofing) is amended to read as follows:

Table 6-1. Minimum Elevation of Floodproofing, Relative to Design Flood Elevation (DFE)—A-Zones

Structure Category <sup>a</sup>	Minimum Elevation of Floodproofing <sup>b</sup>
I	DFE = BFE
II <sup>c</sup>	DFE = BFE
III	DFE = BFE + 1 ft

IV

DFE = BFE + 2 ft

<sup>a</sup> See Table 1-1, or Table 1604.5 of the *New York City Building Code*, for category descriptions.

<sup>b</sup> Wet or dry floodproofing shall extend to the same level.

<sup>c</sup> Dry floodproofing of residential buildings and residential portions of mixed use buildings shall not be permitted.

**Section 6.2.2.** Item 3 of Section 6.2.2 (Dry Floodproofing Requirements) is amended to read as follows:

3. Have either:

3.1 All required means of egress elevated to or above the applicable DFE specified in Table 6-1, capable of providing human ingress and egress during the design flood; or

3.2 At least one elevated door located in close proximity to each required means of egress to the exterior that is to be blocked by flood shields or flood control devices, such that the face of the elevated door itself, and not merely its directional signage, is clearly visible to a person approaching the blocked egress door(s). Such door(s) shall be elevated to at or above the applicable DFE specified in Table 6-1, capable of providing human ingress and egress during the design flood. Such door(s) shall meet all *New York City Building Code* requirements for a required means of egress to the exterior of the structure including hardware and signage, but shall not be required to comply with the occupant load calculations, unless the structure is intended for occupancy during the design flood. Such door may be accessed by open steps and shall not be required to comply with Chapter 11 of the *New York City Building Code* if its only purpose is to provide supplemental egress and ingress during conditions of flooding and to provide emergency egress at other times.

**Section 7.1.** Table 7-1 of Section 7.1 (General) is amended to read as follows:

Table 7-1. Minimum Elevation of Utilities and Attendant Equipment Relative to Design Flood Elevation (DFE)

<u>Structure Category<sup>a</sup></u>	<u>Locate Utilities and Attendant Equipment Above<sup>b</sup></u>		
	<u>A-Zones</u>	<u>V-Zones</u>	
		<u>Orientation Parallel<sup>c</sup></u>	<u>Orientation Perpendicular<sup>c</sup></u>
<u>I</u>	<u>DFE = BFE</u>	<u>DFE = BFE</u>	<u>DFE = BFE</u>
<u>II</u>	<u>DFE = BFE</u>	<u>DFE = BFE</u>	<u>DFE = BFE</u>
<u>III</u>	<u>DFE = BFE + 1 ft</u>	<u>DFE = BFE + 2 ft</u>	<u>DFE = BFE + 3 ft</u>
<u>IV</u>	<u>DFE = BFE + 2 ft</u>	<u>DFE = BFE + 2 ft</u>	<u>DFE = BFE + 3 ft</u>

<sup>a</sup> See Table 1-1, or Table 1604.5 of the *New York City Building Code*, for category descriptions.

<sup>b</sup> Locate utilities and attendant equipment above elevations shown unless otherwise provided in the text.

<sup>c</sup> Orientation of lowest horizontal structural member relative to the general direction of wave approach; parallel shall mean less than or equal to +20 degrees from the direction of approach; perpendicular shall mean greater than +20 degrees from the direction of approach.

**Section 7.5.1.** A new section 7.5.1 is added to read as follows:

**7.5.1 Elevator signage.** Where there is potential for an elevator cab to descend below the elevation specified in Table 7-1 into a wet floodproofed space, the elevator shall be equipped with controls that will prevent the cab from descending into floodwaters. Permanent, durable, and washable signage shall be placed in the elevator cab and in the elevator lobby on any story subject to flooding, stating that “In the event of flooding, water sensors in the elevator shaft will prevent the elevator from descending to [description of story, e.g. ground floor, first floor, parking level, etc.] and will automatically cause the elevator to rise to [description of story, e.g. second floor, mezzanine, etc.]”

**Section 9.3.1.** The second sentence of the first paragraph of Section 9.3.1 (Attached Garages and Carports) is amended to read as follows:

Wet floodproofed garages and carports are permitted below elevations specified in Table 2-1 provided the lowest level of the garage or carport is at or above grade on at least one side, the garage or carport walls meet the opening requirements of Section 2.6, and the lowest level of the garage or carport is not classified as a “lowest floor” pursuant to Appendix G of the *New York City Building Code*.

**Section 9.5.** Section 9.5 (Pools) is amended by adding a new paragraph to read as follows:

Mechanical equipment for pools such as pumps and water heaters, and associated electrical wiring, shall comply with Section 7.2 and 7.4.

**G501.2 Reserved.**

**G501.3 Reserved.**

**SECTION BC G601**  
**RESERVED**

**SECTION BC 701**  
**RESERVED**

**SECTION BC G702**  
**RESERVED**

**APPENDIX H**  
**OUTDOOR SIGNS**

**SECTION BC H101**  
**GENERAL**

**H101.1 General.** An outdoor sign shall not be erected in a manner that would confuse or obstruct the view of or interfere with exit signs required by Chapter 10 or with official traffic signs, signals or devices. Signs and sign support structures, together with their supports, braces, guys and anchors, shall be kept in repair and in proper state of preservation. The display surfaces of signs shall be kept neatly painted or posted at all times. No sign shall project beyond the street line except as permitted by Chapter 32.

**H101.2 Signs exempt from permits.** The signs specified in Section 28-105.4.5 are exempt from the requirements to obtain a permit before erection. The changing of moveable parts of an approved sign that is designed for such changes, or the repainting or repositioning of display matter shall not be deemed an alteration requiring a separate permit, except that the replacing of flexible vinyl display signs shall be deemed such an alteration.

**SECTION BC H102**  
**DEFINITIONS**

**H102.1 General.** Unless otherwise expressly stated, the following words and terms shall, for the purposes of this appendix, have the meanings shown herein. Refer to Chapter 2 of this code for general definitions.

**COMBINATION SIGN.** A sign incorporating any combination of the features of pole, projecting and roof signs.

**DISPLAY SIGN.** The area made available by the sign structure for the purpose of displaying the sign.

**GROUND SIGN.** A billboard or similar type of sign which is supported by one or more uprights, poles or braces in or upon the ground other than a combination sign or pole sign, as defined by this code.

**POLE SIGN.** A sign wholly supported by a sign structure in the ground.

**PROJECTING SIGN.** A sign other than a wall sign, which projects from and is supported by a wall of a building or structure.

**ROOF SIGN.** A sign erected upon or above a roof or parapet of a building or structure.

**SIGN.** Any letter, figure, character, mark, plane, point, marquee sign, design, poster, pictorial, picture, stroke, stripe, line, trademark, reading matter or illuminated service, which shall be

constructed, placed, attached, painted, erected, fastened or manufactured in any manner whatsoever, so that the same shall be used for the attraction of the public to any place, subject, person, firm, corporation, public performance, article, machine or merchandise, whatsoever, which is displayed in any manner outdoors. Every sign shall be classified and conform to the requirements of that classification as set forth in this chapter.

**SIGN STRUCTURE.** Any structure which supports or is capable of supporting a sign as defined in this code. A sign structure is permitted to be a single pole and is not required to be an integral part of the building.

**TEMPORARY SIGN.** A sign, with display area 500 square feet (46.5 m<sup>2</sup>) or less, erected for a period of 30 days or less.

**WALL SIGN.** Any sign attached to or erected against the wall of a building or structure, projecting no more than 15 inches (381 mm) from the face of the wall, with the exposed face of the sign in a plane parallel to the plane of said wall.

### **SECTION BC H103** **LOCATION**

**H103.1 Location restrictions.** Signs shall not be erected, constructed or maintained so as to obstruct any fire escape or any window or door or opening used as a means of egress or so as to prevent free passage from one part of a roof to any other part thereof. A sign shall not be attached in any form, shape or manner to a fire escape or exterior stair, nor be placed in such manner as to interfere with any opening required for natural light or natural ventilation.

**H103.2 Fire Department access.** Signs erected to cover doors or windows required by Section 501.3.2 for Fire Department access to existing buildings shall be provided with access panels to such openings.

### **SECTION BC H104** **IDENTIFICATION**

**H104.1 Identification.** Every outdoor advertising display sign hereafter erected, constructed or maintained, for which a permit is required, shall be marked in accordance with Section 28-502.4.

### **SECTION BC H105** **DESIGN AND CONSTRUCTION**

**H105.1 General requirements.** Signs shall be designed and constructed to comply with the provisions of this code for use of materials, loads and stresses.

**H105.2 Permits, drawings and specifications.** Where a permit is required, as provided in Chapter 1, construction documents shall be required. These documents shall show the dimensions,

material and required details of construction, including loads, stresses and anchors. Every sign for which a permit is required shall be inspected at least once every calendar year.

**H105.3 Wind load.** Signs shall be designed and constructed to withstand wind pressure as provided for in Chapter 16.

**H105.4 Seismic load.** Signs designed to withstand wind pressures shall be considered capable of withstanding earthquake loads, except as provided for in Chapter 16.

**H105.5 Working stresses.** In outdoor advertising display signs, the allowable working stresses shall conform to the requirements of Chapter 16. The working stresses of wire rope and its fastenings shall not exceed 25 percent of the ultimate strength of the rope or fasteners.

**Exceptions:**

1. The allowable working stresses for steel and wood shall be in accordance with the provisions of Chapters 22 and 23.
2. The working strength of chains, cables, guys or steel rods shall not exceed one-fifth of the ultimate strength of such chains, cables, guys or steel.

**H105.6 Attachment.** Signs attached to masonry, concrete or steel shall be safely and securely fastened by means of metal anchors, bolts or approved expansion screws of sufficient size and anchorage to safely support the loads applied.

**SECTION BC H106**  
**ELECTRICAL**

**H106.1 Illumination.** A sign shall not be illuminated by other than electrical means, and electrical devices and wiring shall be installed in accordance with the requirements of the *New York City Electrical Code*. Any open spark or flame shall not be used for display purposes unless specifically approved.

**H106.1.1 Internally illuminated signs.** Wiring for electric lighting shall be entirely enclosed in the sign cabinet with a clearance of not less than 2 inches (51 mm) from the facing material.

**H106.2 Electrical service.** Signs that require electrical service shall comply with the *New York City Electrical Code*.

**H106.3 Material limitations.** All sign structures for signs requiring electric service shall be constructed of noncombustible materials, except as permitted by Section H107.

**H106.4 Projecting reflectors.** Lighting reflectors may project beyond the top or face of all signs provided that every part of such reflector is at least 10 feet (3048 mm) above the ground or

sidewalk level. Reflectors shall be constructed, attached, and maintained so that they shall not be, or become, a hazard to the public.

## **SECTION BC H107** **MATERIAL LIMITATIONS**

**H107.1 Use of combustibles.** In all signs required to be constructed of noncombustible materials pursuant to the provisions of Sections H109 through H116, the following materials may be used for moldings, cappings, nailing blocks, letters and laticing, or other purely ornamental features of signs, unless otherwise directed by the commissioner: wood, approved plastic or plastic veneer panels as provided for in Chapter 26, or other materials of combustible characteristics similar to wood. In all signs permitted to be constructed of combustible materials pursuant to the provisions of Sections H107 through H116, wood and other materials of combustible characteristics similar to wood shall be permitted, pursuant to the provisions of Sections H109 through H116, on the display surface without limit, except that approved plastic shall be limited in area by the provisions of Section H107.1.3.

**H107.1.1 Approved plastic materials.** Plastic materials which burn at a rate no faster than 2.5 inches per minute (64 mm/s) when tested in accordance with ASTM D 635 shall be deemed approved plastics and can be used as the display surface material and for the letters, decorations and facings on signs, subject to the area limitations of Sections H107.1.2 through H107.1.3.

**Exception:** Flexible vinyl signs shall comply with the requirements of Section H114.

**H107.1.2 Plastic area limitations for internally illuminated signs.** Except as provided for in Sections 402.14 and 2611 of this code, approved plastic used on the display surface of internally illuminated signs shall be permitted up to 200 square feet (18.6 m<sup>2</sup>) in area on signs required to be of noncombustible construction and on signs permitted to be of combustible construction.

**H107.1.3 Plastic area limitations for all other signs.** Approved plastic used on the display surface of ground signs, walls signs, roof signs, projecting signs, and marquee signs shall be limited in area as provided by Sections H107.1.3.1 through H107.1.3.4.

**H107.1.3.1 Plastic area limitations on noncombustible ground signs and wall signs.** On ground signs and wall signs required to be constructed of noncombustible materials, if the display surface does not exceed 150 square feet (13.9 m<sup>2</sup>), the entire display surface shall be permitted to be covered by approved plastic. If the area of a display surface exceeds 150 square feet (13.9 m<sup>2</sup>), the area occupied or covered by approved plastics shall be limited to 150 square feet (13.9 m<sup>2</sup>) plus 50 percent of the difference between 150 square feet (13.9 m<sup>2</sup>) and the total area of display surface. The area of plastic on a display surface shall not in any case exceed 1,050 square feet (97.5 m<sup>2</sup>), unless approved by the commissioner.



**H107.1.3.2 Plastic area limitations on combustible ground signs and wall signs.** On ground signs and wall signs permitted to be constructed of combustible materials, if the display surface does not exceed 300 square feet (27.9 m<sup>2</sup>), 50 percent of the display surface shall be permitted to be covered by approved plastic. If the area of a display surface exceeds 300 square feet (27.9 m<sup>2</sup>), the area occupied or covered by approved plastics shall be limited to 150 square feet (13.9 m<sup>2</sup>) plus 25 percent of the difference between 150 square feet (13.9 m<sup>2</sup>) and the total area of display surface. The area of plastic on a display surface shall not in any case exceed 575 square feet (53.4 m<sup>2</sup>), unless approved by the commissioner.

**H107.1.3.3 Plastic area limitations on noncombustible roof signs, projecting signs, and marquee signs.** On roof signs, projecting signs, and marquee signs required to be constructed of noncombustible materials, if the display surface does not exceed 150 square feet (13.9 m<sup>2</sup>), the entire display surface shall be permitted to be covered by approved plastic. If the area of a display surface exceeds 150 square feet (13.9 m<sup>2</sup>), the area occupied or covered by approved plastics shall be limited to 150 square feet (13.9 m<sup>2</sup>) plus 25 percent of the difference between 150 square feet (13.9 m<sup>2</sup>) and the total area of display surface. The area of plastic on a display surface shall not in any case exceed 575 square feet (53.4 m<sup>2</sup>), unless approved by the commissioner.

**H107.1.3.4 Plastic area limitations on combustible roof signs.** On roof signs permitted to be constructed of combustible materials, if the display surface does not exceed 1,000 square feet (92.9 m<sup>2</sup>), 25 percent of the display surface shall be permitted to be covered by approved plastic. If the area of a display surface exceeds 1,000 square feet (92.9 m<sup>2</sup>), the area occupied or covered by approved plastics shall be limited to 250 square feet (23.2 m<sup>2</sup>) plus 10 percent of the difference between 250 square feet (23.2 m<sup>2</sup>) and the total area of display surface. The area of plastic on a display surface shall not in any case exceed 350 square feet (32.5 m<sup>2</sup>), unless approved by the commissioner.

**H107.2 Glass panels.** Glass panels used in display areas of signs shall be limited in size, thickness and type of glass as provided by Table H107.2.

**TABLE H107.2**  
**SIZE, THICKNESS AND TYPE OF GLASS PANELS IN SIGNS**  
**(Table H107.2 attached to end of document)**

**SECTION BC H108**  
**ANIMATED DEVICES**

**H108.1 Fail-safe device.** Signs that contain moving sections or ornaments shall have fail-safe provisions to prevent the section or ornament from releasing and falling or shifting its center of gravity more than 15 inches (381 mm). The fail-safe device shall be in addition to the mechanism and the mechanism's housing which operate the movable section or ornament. The fail-safe device shall be capable of supporting the full dead weight of the section or ornament when the moving mechanism releases.

**SECTION BC H109**  
**GROUND SIGNS**

**H109.1 Materials.** Ground signs erected inside the fire districts shall be constructed entirely of noncombustible materials and the facings of such signs shall be of noncombustible materials, except as permitted by Section H107. Outside the fire districts, the structure of ground signs exceeding 25 feet (7620 mm) in height above grade, or exceeding 2500 square feet (232 m<sup>2</sup>) in display area, shall be constructed of noncombustible materials, and the facing of such signs shall be noncombustible, except as permitted by Section H107.

**H109.2 Required clearance.** The bottom coping of every ground sign shall be not less than 3 feet (914 mm) above the ground or street level, which space can be filled with platform decorative trim or light wooden construction.

**H109.3 Wood anchors and supports.** Where wood anchors or supports are embedded in the soil, the wood shall be pressure treated with an approved preservative.

**SECTION BC H110**  
**ROOF SIGNS**

**H110.1 Materials.** Roof signs erected inside the fire districts shall be constructed entirely of noncombustible materials and the facings of such signs shall be of noncombustible materials, except as permitted by Section H107. Outside of the fire districts, the structure of roof signs exceeding 65 feet (19 812 mm) in height above grade, or exceeding 1500 square feet (139 m<sup>2</sup>) in display area, shall be constructed of noncombustible materials and the facings of such signs shall be of noncombustible materials, except as permitted by Section H107.

**H110.2 Required clearance.** Roof signs shall be constructed so as to provide a clear space of at least 7 feet (2134 mm) between the roof and the lowest part of the sign, and at least 5 feet (1524 mm) between the vertical supports thereof.

**H110.3 Location.** Roof signs shall be set back a minimum of 6 feet (1829 mm) from the face of the walls of the building on which they are erected.

**H110.4 Bearing plates.** The bearing plates of roof signs shall distribute the load directly to or upon masonry walls, steel roof girders, columns or beams. The building shall be designed to avoid overstress of these members.

**H110.5 Reserved.**

## SECTION BC H111 WALL SIGNS

**H111.1 Materials.** Wall signs erected inside the fire districts shall be constructed entirely of noncombustible materials, and the facings of such signs shall be of noncombustible materials, except as permitted by Section H107. Outside of the fire districts, the structure of wall signs exceeding 500 square feet (46 m<sup>2</sup>) in display area shall be constructed of noncombustible materials, and the facings of such signs shall be of noncombustible materials, except as permitted in Section H107.

**H111.2 Exterior wall mounting details.** Wall signs attached to exterior walls of solid masonry, concrete or stone shall be safely and securely attached by means of metal anchors, bolts or expansion screws of not less than 3/8 inch (9.5 mm) diameter and shall be embedded at least 5 inches (127 mm). Wood blocks shall not be used for anchorage, except in the case of wall signs attached to buildings with walls of wood. A wall sign shall not be supported by anchorages secured to an unbraced parapet wall.

**H111.3 Extension.** Wall signs shall not extend above the top of the wall, nor beyond the ends of the wall to which the signs are attached unless such signs conform to the requirements for roof signs, projecting signs or ground signs.

## SECTION BC H112 PROJECTING SIGNS

**H112.1 Materials.** Projecting signs shall be constructed entirely of noncombustible materials, and the facings of such signs shall be of noncombustible materials, except as permitted by Section H107.

**H112.2 Attachment.** Projecting signs shall be securely attached to a building or structure by metal supports such as bolts, anchors, chains, guys or steel rods. Supports shall be secured to a bolt or expansion screw that will develop the strength of the supporting chains, guys or steel rods, with a minimum 5/8-inch (15.9 mm) bolt or lag screw, by an expansion shield. Turn buckles shall be placed in chains, guys or steel rods supporting projecting signs. Staples or nails shall not be used to secure any projecting sign to any building or structure. The dead load of projecting signs not parallel to the building or structure and the load due to wind pressure shall be supported with chains, guys or steel rods having net cross-sectional dimension of not less than 3/8 inch (9.5 mm) diameter. Such supports shall be erected or maintained at an angle of at least 45 percent (0.78 rad) with the horizontal to resist the dead load and at angle of 45 percent (0.78 rad) or more with the face of the sign to resist the specified wind pressure. If such projecting sign exceeds 30 square feet (2.8 m<sup>2</sup>) in one facial area, there shall be provided at least two such supports on each side not more than 8 feet (2438 mm) apart to resist the wind pressure.

**H112.3 Wall mounting details.** Chains, cables, guys or steel rods used to support the live or dead load of projecting signs are permitted to be fastened to solid masonry walls with expansion bolts or by machine screws in iron supports, but such supports shall not be attached to an unbraced

parapet wall. Where the supports must be fastened to walls made of wood, the supporting anchor bolts must go through the wall and be plated or fastened on the inside in a secure manner.

**H112.4 Height limitation.** A projecting sign shall not be erected on the wall of any building so as to project above the roof or cornice wall or above the roof level where there is no cornice wall; except that a sign erected at a right angle to the building, the horizontal width of which sign is perpendicular to such a wall and does not exceed 24 inches (610 mm), is permitted to be erected to a height not exceeding 5 feet (1524 mm) above the roof or cornice wall or above the roof level where there is no cornice wall. A sign attached to a corner of a building and parallel to the vertical line of such corner shall be deemed to be erected at a right angle to the building wall.

**Exception:** On buildings 35 feet (10 668 mm) high or less, projecting signs, not exceeding 24 inches (610 mm) in width, may be erected to a maximum height of 40 feet (12 192 mm) above grade but in no case to a height of more than 15 feet (4572 mm) above the main roof level.

**H112.5 Additional loads.** Projecting sign structures which will be used to support an individual on a ladder or other servicing device, whether or not specifically designed for the servicing device, shall be capable of supporting the anticipated additional load, but not less than a 100-pound (445 N) concentrated horizontal load and a 300-pound (1334 N) concentrated vertical load applied at the point of assumed or most eccentric loading. The building component to which the projecting sign is attached shall also be designed to support the additional loads.

**H112.6 Thickness.** Projecting signs shall be limited in thickness as provided for in Table H112.6.

**TABLE H112.6**  
**THICKNESS OF PROJECTING SIGNS**  
**(Table H112.6 attached to end of document)**

**H 112.7 Location restrictions.** Projecting signs shall not be erected on buildings located on those streets and avenues listed in Section 3202.2.1.8.

**SECTION BC H113**  
**MARQUEE SIGNS**

**H113.1 Materials.** Marquee signs shall be constructed entirely of noncombustible materials, and the facings of such signs shall be of noncombustible materials, except as provided for in Section H107.

**H113.2 Attachment.** Marquee signs shall be attached to approved marquees that are constructed in accordance with Section 3106 of this code and shall be anchored in conformance with the requirements for projecting signs under Section H112.

**H113.3 Extension.** No part of a marquee sign shall project above or below the marquee fascia, or beyond the perimeter of the marquee.

**Exception.** On marquees attached to buildings classified as Occupancy Group A-1, skating rinks in Occupancy Group A-4, or amusement park structures in Occupancy Group A-5, marquee signs may project not more than 8 feet (2438 mm) above nor more than 1 foot (305 mm) below the fascia, provided that the total height of such signs does not exceed 9 feet (2743 mm) and the lowest part of such signs is at least 10 feet (3048 mm) above the ground or sidewalk level. Marquee signs shall not project beyond the horizontal ends of the marquee.

**H113.4 Location restrictions.** Marquee signs erected on marquees projecting beyond the street line shall be limited to those occupancy groups and locations provided by Section 3202.2.1.4.5 of this code.

## **SECTION BC H114** **FLEXIBLE FABRIC SIGNS**

**H114.1 General.** The provisions of this section shall apply to flexible fabric signs and flexible fabric sign structures, including the fabric display area, the restraining framework, and all stiffening and fastening devices.

**H114.2 Materials.** Fabric used in flexible fabric signs shall be flame resistant in accordance with NFPA 701 or listed under UL 214.

**H114.2.1 Longevity.** The same fabric shall not be used for longer than a 12 month period. The same fabric may be relocated and re-erected within that 12 month period, but in no case shall re-inking of fabrics be permitted.

**H114.2.2 Affidavit.** The sign graphics producer shall furnish an affidavit attesting that the sign was made from noncombustible fabric, flame resistant fabric tested in accordance with NFPA 701 by a nationally recognized testing entity, or fabric bearing a UL Classification Mark obtained from the manufacturer of the fabric.

**H114.2.3 Identification.** The licensed sign hanger shall affix a decal bearing the UL Classification Mark or name of the testing entity and its listing number, and the date of erection of the flexible sign structure, to a corner of the face of the sign fabric. This decal shall be of color(s) contrasting with those of the background of the display, and shall be readable from street or roadway level with the aid of binoculars. If the same fabric is relocated, the existing decal shall remain, and a new decal stating the re-erection date shall be affixed.

**H114.2.4 Limitations.** When erected on walls, flexible fabric signs exceeding 500 square feet (46.5 m<sup>2</sup>) in area shall be of the open weave type, unless backed by means of a wall sign or projecting sign structure supported as provided by Sections H111 and H112.

**H114.3 Attachment to exterior walls.** The sign fabric shall not be placed in front of doors, windows, glass blocks, louvers, grilles, fire escapes, exterior stairs, balconies, marquees, wall recesses or projections unless backed by a wall sign or a projecting sign structure as provided by Sections H111 and H112.

**H114.3.1 Load spreader bars.** Load spreader bars comprised of noncombustible materials must be inserted around the entire perimeter of the fabric display area into pockets that are either woven, or heat-welded and stitched seamed. The load spreader bars shall be provided with rounded edges to prevent tearing of the fabric.

**H114.3.2 Spring snaps.** As an alternate to load spreader bars, the side hems of the fabric may be equipped with grommets to receive spring snaps. The applicant shall determine the appropriate spacing of grommets. The sides of fabric display areas equipped with grommets may be secured with spring snaps to vertical steel wire rope in lieu of restraining angles. The vertical steel wire rope shall be anchored to the wall or other mounting surface by means of eyebolts spaced at intervals to be determined by the applicant. The ends of the vertical steel wire rope shall be restrained by means of turnbuckles or "J" hooks secured to metal angles.

**H114.3.3 Fasteners.** Fasteners shall consist of "J" hooks secured with lock nuts or double nuts to continuous metal restraining angles around the perimeter of the display area. The "J" hooks shall extend through holes in the load spreader bars. The ends of the "J" hooks shall be secured with either safety clips or nuts in order to prevent accidental dislodging of the load spreader bars. In lieu of "J" hooks and restraining angles, the load spreader bars in the pockets along the top edge of the fabric display area may be bolted to steel flat bars.

**H114.3.3.1 Metal restraining angles and bars.** For all flexible sign structures, the metal angles and/or steel flat bars shall be secured to the wall or other mounting surface. Angles and/or bars shall not be secured to any parapet or wall unless the applicant has determined that the parapet or wall is capable of resisting the loads imposed on it by the flexible sign structure. Unsatisfactory parapets or walls shall be braced or otherwise reinforced as determined by the applicant, prior to the erection of the flexible sign structure. A wall sign, projecting sign, roof sign or ground sign structure must be capable of resisting the loads imposed on it by the flexible sign structure.

**H114.3.4 Tensioning.** Initial tension may be applied mechanically to the fabric display area, but it shall be held in final position by adjusting or tightening the turnbuckles, or the nuts holding the "J" hooks to the restraining angles. Mechanical tensioning devices may not remain attached to the flexible sign, except as permitted by Section H115.4.

**H114.4 Attachment to sign structures.** Fabric stretched around any edge of a sign structure shall be protected from any sharp edge that may cut or tear the fabric. The perimeter of the fabric located on the front or rear of a sign structure shall be secured as required by Section H115.3, except that the "J" hooks may be secured directly to the sign structure.

**H114.4.1 Tensioning devices.** Opposing ends of a fabric sign stretched around the edges of a sign structure may be secured to each other by means of mechanical tensioning devices behind the sign structure, provided that the open ends for the "S" hooks shall be closed with safety clips. Spring snaps may be used in lieu of "S" hooks. The mechanical tensioning devices shall

be fastened to safety wires, placed through the holes in the load spreader bars or grommets, to prevent the devices from falling in the event of loss of tension.

**H114.4.2 Limitations.** The length of the fabric or safety wire perpendicular to any edge of the sign structure shall be dimensioned such that in the event of failure of any part of the flexible sign structure, no load spreader bars, mechanical tensioning devices, clamps, or wires will strike any nearby doors, windows, vents, chimneys, grilles, skylights, light fixtures, decorations or other wall appurtenances, or mechanical equipment, nor shall any load spreader bar fall within 10 feet (3048 mm) of grade.

## **SECTION BC H115** **PORTABLE SIGNS**

**H115.1 General.** Portable signs shall conform to requirements for ground, roof, projecting, flat and temporary signs where such signs are used in a similar capacity. The requirements of this section shall not be construed to require portable signs to have connections to surfaces, tie-downs or foundations where provisions are made by temporary means or configuration of the structure to provide stability for the expected duration of the installation.

## **SECTION BC H116** **TEMPORARY SIGNS**

**H116.1 Materials.** Temporary signs less than 500 square feet (46.5 m<sup>2</sup>) in display area may be constructed of combustible materials. Temporary sign structures, with display area greater than 100 square feet (9.3 m<sup>2</sup>), shall be constructed of rigid materials with rigid frames.

**H116.2 Attachment.** Temporary signs shall be securely attached to the sign structure.

**H116.3 Duration.** Temporary signs shall be removed no later than 30 days after erection or as soon as such sign is torn or damaged.

**H116.4 Limitations.** Temporary signs constructed of combustible materials shall not extend more than 12 inches (305 mm) over, or into, a street.

### **Exceptions:**

1. When permitted by the Department of Transportation, temporary signs of combustible materials may be suspended from buildings or poles to extend across streets.
2. Temporary signs of combustible materials constructed without a frame may be attached flat against, or suspended from, the fascia of a canopy or marquee, provided that the lowest part of any such sign is at least 9 feet (2743 mm) above the ground or sidewalk level.

**SECTION BC H115**  
**REFERENCED STANDARDS**

<u>ASTM D 635-03</u>	<u>Standard Test Method for</u>	<u>H107.1.1</u>
	<u>Rate of Burning and/or</u>	
	<u>Extent and Time of</u>	
	<u>Burning of Self-Supporting</u>	
	<u>Plastics in a Horizontal Position</u>	
<u>NFPA 701-04</u>	<u>Methods of Fire Test for</u>	<u>H114.2</u>
	<u>Flame Propagation of Textiles</u>	
	<u>and Films</u>	
<u>UL 214-01</u>	<u>Standard for Tests for Flame</u>	
	<u>Propagation of Fabrics and Films</u>	<u>H114.2</u>



**TABLE H107.2**  
**SIZE, THICKNESS AND TYPE OF GLASS PANELS IN SIGNS**

MAXIMUM SIZE OF EXPOSED PANEL		MINIMUM THICKNESS OF GLASS (inches)	TYPE OF GLASS
Any dimension (inches)	Area (square inches)		
30	500	$\frac{1}{8}$	Plain, plate or wired
45	700	$\frac{3}{16}$	Plain, plate or wired
144	3,600	$\frac{1}{4}$	Plain, plate or wired
> 144	> 3,600	$\frac{1}{4}$	Wired glass

For SI: 1 inch = 25.4 mm, 1 square inch = 645 mm<sup>2</sup>.

---

**TABLE H112.6**  
**THICKNESS OF PROJECTING SIGNS**

PROJECTION (feet)	MAXIMUM THICKNESS (feet)
5	2
4	2.5
3	3
2	3.5
1	4

For SI: 1 foot = 304.8 mm.

---

**APPENDIX I**  
**RESERVED**

**APPENDIX J**  
**RESERVED**

**APPENDIX K**  
**MODIFIED INDUSTRY STANDARDS FOR ELEVATORS AND CONVEYING**  
**SYSTEMS**

**CHAPTER K1**  
**MODIFICATIONS TO ASME A17.1 - 2000, SAFETY CODE FOR ELEVATORS AND**  
**ESCALATORS**

**K101.1 General.** As referenced by Chapter 30 of the *New York City Building Code*, the provisions of ASME A17.1—00 with supplements A17.1a—02 and A17.1b—03 shall be modified in accordance with this chapter. The section numbers correlate to those in the referenced ASME standard.

**PART 1**  
**GENERAL**

**SECTION 1.3**  
**DEFINITIONS**

**1.3 Add or revise the following definitions to section 1.3 as follows:**

**Delete and revise the definition “Designated Level” to read as follows:**

**Designated Level:** For the purpose of applying Section 2.27.3, designated level shall mean the street floor or other level that best serves the needs of emergency personnel for fire fighting or rescue purposes.

**Add new definition “Elevator Classification” to read as follows:**

**Elevator Classification:** Elevator is classified as freight or passenger.

**Add new definition “Elevator, Service Car” to read as follows:**

**Elevator, Service Car:** A passenger or freight elevator, located in an Interim Multiple Dwelling registered with the New York City Loft Board, in accordance with Article 7-C of the Multiple Dwelling Law.

**Delete and revise the definition “Hospital Emergency Service” to read as follows:**

**Hospital Emergency Service:** A special operating control function that may be provided for elevators in a building classified in occupancy group I-2 (Hospital) or other applicable medical facility used to transport a patient in a life or death situation.

**Delete and revise the definition “Installation Placed Out of Service” to read as follows:**

**Installation Placed Out of Service (Dismantled):** An installation whose power feed lines have been disconnected from the main line disconnect switch and:

- (a) An electric elevator, dumbwaiter, sidewalk elevator or material lift whose suspension ropes have been removed, whose car and counterweight rest at the bottom of the hoistway, and whose hoistway doors have been permanently barricaded or sealed in the closed position on the hoistway side.
- (b) A hydraulic elevator, dumbwaiter, sidewalk elevator or material lift whose car rests at the bottom of the hoistway; whose pressure piping has been disassembled and a removed from the premises; whose hoistway doors have been permanently barricaded or sealed in the closed position.
- (c) An escalator or moving walk whose entrances have been permanently barricaded.

**Add new definition “Patient Elevator” to read as follows:**

**Patient Elevator:** An elevator located in a building classified in occupancy group I-2 (Hospital) reserved for the “sole” use of vertical transportation of non-ambulatory patients who are incapable of self-preservation because of age, physical or mental disability. Hospital staff or other passengers transporting a patient are permitted to ride with the patient. Such elevators must be operated by a designated attendant and shall meet the requirements of §2.27.4 and §2.27.5.3.

**Add new definition “Sky Lobby” to read as follows:**

**Sky Lobby:** The lowest landing of an elevator or a group of elevators located above the street level.

**Add new definition “Smoke Hole” to read as follows:**

**Smoke Hole:** An opening for an elevator hoistway venting at the top of the elevator hoistway(s).

**Add new definition “Zero Clearance Vestibule” to read as follows:**

**Zero Clearance Vestibule.** A space on the elevator lobby between the exterior of the hoistway door and the security door attached to the elevator hoistway.

**PART 2**  
**ELECTRIC ELEVATORS SECTION 2.1**  
**CONSTRUCTION OF HOISTWAYS AND**  
**HOISTWAY ENCLOSURES**

**2.1.4 Control of Smoke and Hot Gases.**

**Delete section 2.1.4.**

**2.1.6 Projections, Recesses, and Setbacks in Hoistway Enclosures.**

**Revise section 2.1.6.2 to read as follows:**

**2.1.6.2. On sides not used for loading and unloading:**

- (a) Recesses, except those necessary for installation of elevator equipment, shall not be permitted;**
- (b) Beams, floor slabs, or other building construction making an angle less than 75 degrees with the horizontal shall not project more than [100 mm (4 in.)] 50 mm (2 in) inside the hoistway enclosure unless the top surface of the projection is beveled at an angle not less than 75 degrees with the horizontal;**
- (c) Separator beams between adjacent elevators are not required to have bevels;**
- (d) Where setbacks exceeding [100 mm (4 in.)] 50 mm (2 in) occur in the enclosure wall, the top of the setback shall be beveled at an angle of not less than 75 degrees with the horizontal;**
- (e) Bevels are not required if the projections and setbacks are covered with material conforming to the following:**
  - (i) It shall be equal to or stronger than 1.110 mm (0.0437 in.) wire;**
  - (ii) It shall have openings not exceeding 25 mm (1 in.); and**
  - (iii) It shall be supported and braced such that it will not deflect more than 25 mm (1 in.) when subjected to a force of 4.79 kPa (100 lbs per sq ft) applied horizontally at any point.**

**SECTION 2.2**

**PITS**

**2.2.2 Design and Construction of Pits.**

**Delete and revise section 2.2.2.5 to read as follows:**

**2.2.2.5 Elevators with sprinklers in the shaftway shall be provided with a drain or sump pump.**

**2.2.4 Access to Pits.**

**Revise section 2.2.4.1 to read as follows:**

2.2.4.1 Access shall be by means of the lowest hoistway door or by means of a separate pit access door located at the level of the pit floor.

**Add new sub-section (f) to section 2.2.4.4 to read as follows:**

2.2.4.4 Separate pit door, when provided, shall be subject to the following requirements:

(f) Pit doors shall be labeled “DANGER, ELEVATOR PIT” with letters not less than 51 mm (2 in) high.

## **SECTION 2.7** **MACHINE ROOMS AND MACHINE SPACES**

**2.7.3.4 Access Doors and Openings.**

**Add new sub-section (e) to 2.7.3.4.1 to read as follows:**

2.7.3.4.1 Access doors to machine rooms and overhead machinery spaces shall:

(e) Be labeled “ ELEVATOR MACHINE ROOM”, with letters not less than 51 mm (2 in) high.

**2.7.5 Lighting, Temperature, and Humidity in Machine Rooms and Machinery Spaces.**

**Add new section 2.7.5.3 to read as follows:**

2.7.5.3 A duplex receptacle rated at not less than 20A, 120V with ground fault circuit interrupter shall be provided in each machine room and machinery space. The receptacle shall not be used for permanently installed equipment.

**2.7.8 Remote Machine and Control Rooms.**

**Delete and revise section 2.7.8.4 to read as follows:**

2.7.8.4 A permanent two-way voice communication shall be provided between the lobby fire command station (where required or provided), the elevator car and elevator machine room, and/or control room.

## **SECTION 2.8** **EQUIPMENT IN HOISTWAYS AND MACHINE ROOMS**

**2.8.1 Electrical Equipment and Wiring.**

**Revise section 2.8.1.2 to read as follows:**

2.8.1.2 Only such electrical wiring, raceways, and cables used directly in connection with the elevator, including wiring for signals, for communication with the car, fire department communications equipment, for lighting, heating, air conditioning, and ventilating the car, for fire detecting systems, for pit sump pumps, and for heating and lighting the hoistway and/or machine room and equipment allowed in §2.14.1.9.1(d) shall be permitted to be installed inside the hoistway.

## **2.8.2 Pipes, Ducts, Tanks, and Sprinklers.**

**Delete and revise section 2.8.2.3 to read as follows:**

2.8.2.3 Sprinkler systems are not permitted in control/machine rooms.

## **SECTION 2.11** **PROTECTION OF HOISTWAY OPENINGS**

### **2.11.1 Entrances and Emergency Doors Required.**

**Revise section 2.11.1.1 to read as follows:**

2.11.1.1 Hoistway Landing Entrances. All elevator hoistway-landing openings shall be provided with entrances that shall guard the full height and width of the openings. Entrances shall be at least 2030 mm (80 in.) in height and [800 mm (31.5 in.)] 915mm (36 in.) in width.

**Revise sub-section (a) of 2.11.1.2 to read as follows:**

2.11.1.2 Emergency Doors in Blind Hoistways. Where an elevator is installed in a single blind hoistway, there shall be installed in the blind portion of the hoistway an emergency door at every third floor, but not more than 11 m (36 ft) from sill to sill, conforming to the following:

(a) The clear opening shall be at least [700 mm (28 in.)] 915mm (36 in.) wide and 2030 mm (80 in.) high.

### **2.11.2 Types of Entrances.**

**Delete and revise section 2.11.2 .1 to read as follows:**

2.11.2.1 Passenger Elevators. For passenger elevators, entrances shall be one of the following types:

(a) Horizontally sliding;

(b) Horizontally swinging, single-section;



(c) Hand- or power-operated vertically sliding that slide up to open.

**Delete and revise section 2.11.2.2 to read as follows:**

**2.11.2.2 Freight Elevators.** For freight elevators, entrances shall be one of the following types:

(a) Horizontally sliding;

(b) Swinging, single-section;

(c) Center-opening, two- horizontally swinging, subject to restrictions of section 2.11.2.3;

(d) Vertically sliding biparting counterbalanced (see section 2.16.4); or

(e) Vertically sliding counterweighted, single or multi-section.

**2.11.6 Opening of Hoistway Doors.**

**Revise section 2.11.6.2 to read as follows:**

**2.11.6.2 Means shall not be provided for locking out the service doors at:**

(a) The top terminal landing;

(b) The bottom terminal landing;

(c) The designated sky lobby and sky lobby alternate [and alternate] landings for elevators equipped with Phase I Emergency Recall Operation, when Phase I is effective; [and]

(d) Any landing for elevators equipped with Phase II Emergency In-Car Operation when Phase II is effective [.];

(e) Consecutive vacant floors;

(f) Main lobby street floor.

**Add new section 2.11.6.5 to read as follows:**

**2.11.6.5 Elevator landings provided with a zero clearance vestibule (not to exceed 150 mm (6 in) from the elevator hoistway door) are permissible only when locking devices accessible from the car are installed exclusively on the door that separates the zero clearance vestibule from the occupied floor space.**

### **2.11.7 Glass in Hoistway Doors.**

**Revise sections 2.11.7.1, 2.11.7.1.1, and 2.11.7.1.2 to read as follows:**

**2.11.7.1 Vision Panels.** Manually operated or self-closing hoistway doors of the vertically or horizontally sliding type, for elevators with automatic or continuous-pressure operation, shall be provided with a vision panel. [Vision panels shall not be required at landings of automatic operation elevators where a hall position indicator is provided.] In multi doors, the vision panel is required in one only, but is permitted to be placed in all sections. All horizontally swinging elevator doors shall be provided with vision panels. Vision panels are permitted for any type of hoistway door. Vision panels shall not be required at the landing of automatic operation elevators equipped with horizontally side sliding car and hoistway doors.

Where required or used, vision panels shall conform to 2.11.7.1.1 through 2.11.7.1.7.

**2.11.7.1.1** The area of any single vision panel shall not be less than [0.015 m<sup>2</sup> (24 in<sup>2</sup>)] 0.008 m<sup>2</sup> (12 in<sup>2</sup>), and the total area of one or more panels in any hoistway door shall not be more than [0.055 m<sup>2</sup> (85 in<sup>2</sup>)] 0.026 m<sup>2</sup> (40 in<sup>2</sup>).

**2.11.7.1.2** Each clear panel opening shall reject a ball [150 mm (6in)] 102 mm (4 in.) in diameter.

### **2.11.11 Entrances, Horizontal Slide Type.**

**Revise sub-section (a) of 2.11.11.6 to read as follows:**

**2.11.11.6 Bottom Guides.** Bottom guides shall conform to the following:

(a) The bottom of each panel shall be guided by [one] two or more members.

### **2.11.15 Marking.**

**Add new text to section 2.11.15.1 and revise to read as follows:**

**2.11.15.1 Labeling of Tested Assembly.** In jurisdictions not enforcing the NBCC, 2.11.15.1.1 and 2.11.15.1.2 apply. Where required by this code, the entire entrance assembly shall be of an approved type.

## **SECTION 2.12** **HOISTWAY-DOOR LOCKING DEVICES AND ELECTRIC CONTACTS,** **AND HOISTWAY ACCESS SWITCHES**

**Delete and revise the heading of section 2.12 to read as follows:**

**SECTION 2.12.**  
**HOISTWAY-DOOR LOCKING DEVICES, AND HOISTWAY ACCESS SWITCHES**  
**AND ELEVATOR PARKING DEVICES.**

**2.12.3 Hoistway-Door Combination Mechanical Locks and Electric Contacts.**

**Delete section 2.12.3 in its entirety.**

**Section 2.12.3 Reserved.**

**2.12.4 Listing/Certification Door Locking Devices and Door or Gate Electric Contacts.**

**Delete and revise section 2.12.4.1 to read as follows:**

**2.12.4.1 Type Tests.** Each type and make of hoistway-door interlock, electric contact, and door or gate electric contact, shall be of an approved type.

**Delete and revise sub-section (b) of 2.12.4.3 to read as follows:**

**2.12.4.3 Identification Marking.**

**(b) The approved agency's name, date of approval and identifying number or symbol;**

**Add new section 2.12.6.2.6 to read as follows:**

**2.12.6.2.6. Elevator Parking Device**

**(a) *Parking Devices Required.*** Existing elevators that are operated from within the car only shall have elevator-parking devices installed at every landing that is equipped with an unlocking device. On elevators that are not operated from within the car only, an elevator parking device shall be provided at one landing and may be provided at other landings. This device shall be located at a height not greater than 2.11 m (6 ft 11 in) above the floor. Parking devices are not required for elevators having hoistway doors that are automatically unlocked when the car is within the landing zone.

**(b) *General Design Requirements.*** Parking devices shall conform to the following requirements:

**(1) They shall be mechanically or electrically operated.**

**(2) They shall be designed and installed so that friction or sticking or the breaking of any springs used in the device will not permit opening or unlocking a door when the car is outside the landing zone of that floor.**

(3) Springs, where used, shall be of the restrained compression type, to prevent separation of the parts in case the spring breaks.

**Delete and revise section 2.12.7.3.2 to read as follows:**

2.12.7.3.2 The car cannot be operated at a speed greater than 0.35 m/s (75 ft/min).

**Delete and revise section 2.13.2.1.2 to read as follows:**

2.13.2.1.2 Collapsible car gates shall not be power opened.

**SECTION 2.14**  
**CAR ENCLOSURES, CAR DOORS AND GATES, AND CAR ILLUMINATION**

**2.14.2 Passenger-Car Enclosures.**

**Revise section 2.14.2.1.1 to read as follows:**

2.14.2.1.1: Materials in their end use configuration, other than those covered by 2.14.2.1.2 through 2.14.2.1.6, shall conform to the following requirements, based on the tests conducted in accordance with the requirements of ASTM E 84, UL 723, or NFPA 255:

(a) Flame spread rating of 0 to [75] 50.

(b) Smoke development of 0 to [450] 100.

**Delete and revise sub-section (a) of 2.14.2.5 to read as follows:**

2.14.2.5 Vision Panels. Vision panels are not required, but where used, shall:

(a) Be of a total area of not more than 0.047 m<sup>2</sup> (72 in<sup>2</sup>), and contain no single glass panel having a width exceeding 101 mm (4 in.);

**2.14.4 Passenger and Freight Car Doors and Gates, General Requirements.**

**Revise section 2.14.4.11 to read as follows:**

2.14.4.11 Closed Position of Car Doors or Gates. Car doors or gates shall be considered to be in the closed position under the following conditions:

(a) For horizontally sliding doors or gates, when the clear open space between the leading edge of the door or gate and the nearest face of the jamb does not exceed [50 mm (2 in.)] 25 mm (1 in.) except where car-doors are provided with a car door interlock(s), 10 mm (0.375 in.);

(b) For vertically sliding counterweighted doors or gates, when the clear open space between the leading edge of the door or gate and the car platform sill does not exceed [50 mm (2 in.)] 25 mm (1 in.); and

(c) For horizontally sliding center-opening doors, or vertically sliding biparting counterbalanced doors, when the door panels are within [50 mm (2 in.)] 25 mm (1 in.) of contact with each other, except where horizontally sliding center opening car doors are provided with a car door interlock(s), 10 mm (0.375 in.).

#### **2.14.7 Illumination of Car and Lighting Fixtures.**

##### **Revise section 2.14.7.1.4 to read as follows:**

2.14.7.1.4 Each elevator shall be provided with [an] a guarded electric light and convenience outlet fixture on the car top and under the car platform.

### **SECTION 2.15** **CAR FRAMES AND PLATFORMS**

#### **2.15.8 Protection of Platforms Against Fire:**

##### **Revise section 2.15.8 to read as follows:**

2.15.8 Protection of Platforms Against Fire. All platform materials exposed to the hoistway shall be either:

(a) Metal; or

(b) Other materials that, in their end use configuration, conform to the following requirements, based on the tests conducted in accordance with the requirements of ASTM E 84, UL 723, NFPA 255, or CAN/ULC-S102.2, whichever is applicable (see Part 9):

(1) Flame spread rating of 0 to [75] 50; and

(2) Smoke development of 0 to [450] 100.

### **SECTION 2.16** **CAPACITY AND LOADING**

#### **2.16.1 Minimum Rated Load for Passenger Elevators.**

##### **Add new section 2.16.1.3.3 to read as follows:**

2.16.1.3.3 Nonpermanent freight-handling equipment (2.14.1.9.1) shall be removed when the elevator is used for passenger service.

**SECTION 2.20**  
**SUSPENSION ROPES AND**  
**THEIR CONNECTIONS**

**2.20.9 Suspension Rope Fastening.**

**Add new text to section 2.20.9.5 to read as follows:**

**2.20.9.5 Wedge Rope Sockets.** Wedge socket assemblies shall be of a design as shown in Fig. 2.20.9.5, and shall conform to 2.20.9.2 and 2.20.9.3, and 2.20.9.5.1 through 2.20.9.5.6. Wedge rope sockets are not permitted on counterweighted winding drum machines.

**SECTION 2.21**  
**COUNTERWEIGHTS**

**2.21.1 General Requirements.**

**Revise section 2.21.1.2 to read as follows:**

**2.21.1.2 Retention of Weight Sections.** Means shall be provided to retain weights in place in the event of buffer engagement or safety application or if they become broken. Where tie rods are used, a minimum of two shall be provided and they shall pass through all weight sections. Tie rods shall be provided with a lock nut and a cotter pin at each end.

- (a) Counterweight material shall be steel, iron or lead only and shall have a minimum melting temperature of 620 F°.

**2.21.4 Compensation of Means:**

**Revise section 2.21.4 to read as follows:**

**2.21.4 Compensation Means.** Except for safety hooks, where used, compensation means, such as compensating ropes or chains or other mechanical means and their attachments used to tie the counterweight and car together, shall be capable of withstanding, with a factor of safety of 5, any forces to which the means is subjected with the elevator at rest. The maximum suspended weight of compensation means with car or counterweight at the top of its travel and one half-total weight of tension sheave assembly, where used, shall be included. The factor of safety for compensation means shall be based on the proof load, breaking strength, or test reports.

**SECTION 2.22**  
**BUFFERS AND BUMPERS**

#### **2.22.4 Oil Buffers.**

**Add new paragraphs (a) and (b) to section 2.22.4. 6 as follows:**

**2.22.4.6 Means for Determining Oil Level.** Oil buffers shall be provided with means for determining that the oil level is within the maximum and minimum allowable limits. Glass sight gauges shall not be used.

**(a) A fixed inclined ladder shall be provided where the top of the buffer cylinder is over 1524 mm (5 ft.) in height above the pit floor.**

**(b) A fixed vertical or inclined ladder fitted with an inspection and maintenance platform with guard rails shall be provided where the top of the car buffer cylinder is over 2134 mm (7 ft.) from the pit floor.**

### **SECTION 2.24** **DRIVING MACHINES AND SHEAVES**

#### **2.24.10 Means for Inspection of Gears.**

**Delete and revise section 2.24.10 to read as follows:**

**2.24.10 Means for Inspection of Gears.** Each gear case of geared machines shall have access to permit inspection of the contact surfaces of the gears.

### **SECTION 2.25** **TERMINAL- STOPPING DEVICES**

#### **2.25.3 Final Terminal-Stopping Devices.**

**Add new sub-section (d) to section 2.25.3.1 to read as follows:**

**2.25.3.1 General Requirements.** Final terminal-stopping devices shall conform to 2.25.1 and the following:

**(d) Final limit switches and bracket shall be permanently secured and pinned.**

### **SECTION 2.26** **OPERATING DEVICES AND CONTROL EQUIPMENT**

#### **2.26.1.4 Inspection operation.**

**Add new subsections 3 and 4 to 2.26.1.4.1(c) to read as follows:**

**2.26.1.4.1 General Requirements.**

(c) Inspection operating devices shall:

(1) Be of the continuous-pressure type;

(2) Be labeled "UP" and "DOWN," respectively;

(d) A separate device of the continuous-pressure type labeled "ENABLE" shall be provided adjacent to the inspection operating devices; and

(e) The inspection operating devices shall become effective only when the "ENABLE" device is activated.

**Delete and revise section 2.26.1.4.2 to read as follows:**

**2.26.1.4.2 Top-of-Car Inspection Operation.** Top-of-car inspection operation shall conform to 2.26.1.4.1 and the following:

(a) A stop switch (see §2.26.2.8) shall be permanently located on the car top and readily accessible to a person standing at the hoistway entrance normally used for access to the car top.

(b) The transfer switch (see §2.26.1.4.1(b)) shall be located on the car top and shall be so designed as to prevent accidental transfer from the "INSPECTION" to "NORMAL" position.

(c) The inspection operating devices (see §2.26.1.4.1(c)) shall be permitted to be of the portable type provided that:

(1) the "ENABLE" device (see §2.26.1.4.2(c)), and a stop switch, in addition to the stop switch required in §2.26.1.4.2(a) are included in the portable unit; and

(2) the flexible cord is permanently attached so that the portable unit cannot be detached from the car top.

(d) Separate additional devices of the continuous-pressure type shall be permitted to be provided on the car top to make power door opening and closing and automatic car-leveling operative from the top of the car for testing purposes.

**2.26.2 Electrical Protective Devices:**

**Delete and revise section 2.26.2.5 to read as follows:**

**2.26.2.5 Emergency Stop Switch.** On all elevators, an emergency stop switch shall be provided in the car, and located in or adjacent to each car operating panel. When open ("STOP" position), this switch shall cause the electric power to be removed from the elevator driving-machine motor and brake. Emergency stop switches shall:



- (a) Be of the manually opened and closed type;
- (b) Have red operating handles or buttons;
- (c) Be conspicuously and permanently marked “STOP,” and shall indicate the “STOP” and “RUN” positions; and
- (d) While opened, cause the audible device to sound (see §2.27.1.1.1).

**Delete section 2.26.2.21 in its entirety:**

**Section 2.26.2.21 Reserved.**

## **SECTION 2.27** **EMERGENCY OPERATION AND SIGNALING DEVICES**

### **2.27.1 Car Emergency Signaling Devices.**

**Add new text to section 2.27.1.1.1 as follows:**

2.27.1.1.1 A two-way communications means between the car and a location in the building that is readily accessible to authorized and emergency personnel shall be provided. Means shall be provided to enable two-way voice communication between the machine room and the interior of the car.

**Delete and revise section 2.27.2.4.3 to read as follows:**

2.27.2.4.3 Means shall be provided adjacent to the selector switch (es) to indicate that the elevator is at the designated level with the doors in the normally open position.

### **2.27.3 Firefighters’ Emergency Operation – Automatic Elevators.**

**Revise sections 2.27.3.1.1, 2.27.3.1.2, and 2.27.3.1.3 to read as follows:**

2.27.3.1.1 A [three] two-position key-operated switch shall be:

- (a) Provided [only] at the designated level for each single elevator or for each group of elevators;
- (b) Labeled “FIRE RECALL” and its positions marked [“RESET”, “OFF,” and “ON”] “NORMAL” and “FIREMAN SERVICE” (in that order) [, with the “OFF” position as the center position]. The “FIRE RECALL” letters shall be a minimum of 5 mm (0.25 in.) high in red or a color contrasting with a red background;

(c) Located in the lobby within sight of the elevator or all elevators in that group and shall be readily accessible.

2.27.3.1.2 An additional key-operated “FIRE RECALL” switch, with two-positions, marked [“OFF” and “ON”] “NORMAL” and “FIREMAN SERVICE” (in that order), shall be permitted [only] at the building fire control station.

2.27.3.1.3 The switch(s) shall be rotated clockwise to go from [the “RESET” (designated level switch only), to “OFF” to “ON”] “NORMAL” to “FIREMAN SERVICE” positions. Keys shall be removable in the [“OFF” and “ON”] “NORMAL” and “FIREMAN SERVICE” positions.

**Delete and revise section 2.27.3.2 to read as follows:**

**2.27.3.2 Phase I Fire Alarm Activation:**

2.27.3.2.1 Smoke Detectors. Except as set forth in subparagraph k of this paragraph, smoke detectors installed in accordance with subparagraphs a, b, c or d shall initiate Phase I emergency recall operation.

(a) In buildings where a fire command station is not required or provided, a single smoke detector shall be installed in the ceiling of each elevator landing over the call button on each floor.

(b) In buildings where a fire command station is required or provided, either of the following shall apply:

(1) An analog addressable smoke detector employing alarm verification shall be installed in the ceiling of each elevator landing over the call button on each floor or

(2) Two (2) smoke detectors for cross-zoning shall be installed in the ceiling of each elevator landing on each floor and spaced as follows:

(i) In an elevator landing containing one (1) or two (2) elevators, the distance between smoke detectors shall be the width of the hoistway(s) but not greater than ten (10) feet.

(ii) In an elevator landing containing three (3) or more elevators, the distance between smoke detectors shall be the distance between the centerlines of the end elevators but not greater than twenty (20) feet.

(c) Associated Elevators:

(1) In associated elevator machine rooms of the buildings described in subparagraph (a) above, a smoke detector shall be installed.

- (2) In associated elevator machine rooms of the buildings described in subparagraph (b) above, either of the following shall be installed:
- (i) An analog addressable smoke detector employing alarm verification; or
  - (ii) At least two (2) smoke detectors for cross zoning spaced twenty (20) feet apart but not closer to the hoistway enclosure walls ¼ distance of the width of the machine room.
- (d) A smoke detector shall be installed at the top of the hoistway(s) of the buildings classified in occupancy group R-2 where a fire alarm system is installed or required. Smoke detectors may be installed in any other hoistway and shall be installed in hoistways that are sprinklered.
- (e) Smoke detectors are not required in elevator landings at an unenclosed landing which is open to the outside air.
- (f) Smoke Detector:
- (1) In buildings described in subparagraph (a) above, where a single smoke detector is installed in the elevator landing, the activation of a smoke detector in any elevator landing, other than the sky lobby, shall cause all automatic elevators servicing the floor on which the sensing device is activated to return nonstop to the designated or sky lobby level, except as modified by the commissioner.
  - (2) In buildings described in subparagraph (b) above, where either an analog addressable smoke detector or two (2) smoke detectors for cross-zoning are installed, the activation of either an analog addressable smoke detector or any one of the two smoke detectors for cross-zoning in any elevator lobby shall annunciate at the fire command station only with floor identification. After verification of an alarm condition either from the analog addressable smoke detector or from the first detector of cross-zoning detectors, the completion of the delayed time period of an analog addressable smoke detector or the activation of both smoke detectors for cross-zoning in any elevator lobby, other than the sky lobby, shall cause all automatic elevators servicing the floor on which the sensing device is activated to return nonstop to the designated or sky lobby level, except as modified by the commissioner.
  - (3) In associated machine rooms described in item 1 of subparagraph (c) above, the activation of the smoke detector in the elevator machine room shall cause all automatic elevators having any equipment located in that machine room, and any associated elevators of a group automatic operation, to return nonstop to the designated or sky lobby level, except as modified by the commissioner.

(4) In associated machine rooms described in item 2 of subparagraph (c) above, where either an analog addressable smoke detector or two (2) smoke detectors for cross-zoning are installed, the activation of either an analog addressable smoke detector or any one of the two smoke detectors for cross-zoning in any elevator machine room shall annunciate at the fire command station only with floor identification. After verification of an alarm condition either from the analog addressable smoke detector or from the first detector of cross-zoning detectors, the completion of the delayed time period of an analog addressable smoke detector or the activation of both smoke detectors for cross-zoning in any elevator machine room shall cause all automatic elevators having any equipment located in that machine room, and any associated elevators of a group automatic operation, to return nonstop to the designated or sky lobby level, except as modified by the commissioner.

(5) In addition to the activation of mechanical ventilation if provided {§2.1.4}, the activation of a smoke detector in any elevator hoistway shall cause all automatic elevators having any equipment located in the hoistway and any associated elevators of a group automatic operation, to return nonstop to the designated or sky lobby level.

The operation of this subparagraph shall conform to the requirements of §2.27.3.1.

(g) When the lowest landing of elevators is above the designated level, such as the sky lobby level, the activation of smoke detectors in the sky lobby level or the activation of the waterflow alarm {§2.27.3.2.2} on the sky lobby floor shall cause such elevators to return nonstop to a floor two (2) stories above the sky lobby level or, in the absence of a stop at that floor, to the nearest landing above the sky lobby level.

(h) Elevators shall react only to the first smoke detector zone that is activated for that group.

(i) Smoke detectors and/or smoke detector systems shall not be self-resetting.

(j) Activation of smoke detectors to initiate elevator recall shall override any automatic programming for car stops but shall not affect the other elevator safety circuits.

(k) The following buildings shall be exempt from the requirements of this section:

(1) Buildings classified in occupancy group R-2, except that they shall comply with the requirements of §2.27.3.2.1.(d).

(2) Buildings classified in occupancy group R-3.

- (3) Existing buildings with occupied floors at or below 22 860 mm (75 ft) above the lowest Fire Department vehicle access level classified in occupancy group E that have at least one (1) elevator available at all times for immediate use by the fire department and that are in compliance with the fire department's regulations governing "life safety requirements for schools with students having physical disabilities".
- (4) Existing office buildings, one hundred feet or more in height and existing high-rise buildings as defined by the *New York City Building Code* equipped throughout with an automatic sprinkler system including a waterflow alarm.

**2.27.3.2 Sprinkler Waterflow Alarm.** In a building equipped throughout with an automatic sprinkler system, the activation of the waterflow alarm shall cause Phase I emergency recall operation to be initiated. (§2.27.3.1)

**Delete and revise section 2.27.3.3 to read as follows:**

**2.27.3.3 Phase II Emergency In-Car Operation.** A three-position ("NORMAL", "HOLD", and "FIREMAN SERVICE" in that order) key-operated switch shall be provided in an operating panel in each car. The switch shall be rotated clockwise to go from the "NORMAL" to "HOLD" to "FIREMAN SERVICE" position. It shall become effective only when the designated or sky lobby level Phase I switch {§2.27.3.1} is in the "FIREMAN SERVICE" position or a smoke detector or water-flow alarm has been activated, and the car has returned to the designated or sky lobby level by Phase I operation. The key shall be removable in "NORMAL" or "HOLD" position. The "NORMAL", "HOLD", and "FIREMAN SERVICE" positions shall not change the operation until the car is at a landing with the doors in the normal open position.

**2.27.3.3.1** When the Phase II switch is in the "FIREMAN SERVICE" position, the elevator shall be on Phase II operation, and the elevator shall operate as follows:

- (a)** The elevator shall be operable only by a designated person in the car.
- (b)** All corridor call buttons and directional lanterns shall remain inoperative. Car position indicators, where provided, shall remain in service. Hall position indicators, where provided, shall remain inoperative except at the designated level, sky lobby level and the fire control station, where they shall remain in service for fire department operations.
- (c)** Only a continuous pressure door open button shall control the opening of power-operated doors. If the button is released prior to the door reaching the normal open position, the doors shall automatically re-close. §2.13.3.3, §2.13.4.2.1(b)(2), and §2.13.4.2.1(c) do not apply. On cars with two entrances, separate door-open buttons shall be provided for each entrance if both entrances can be opened at the same landing,

- (d) Open power-operated doors shall be closed only by momentary pressure on the door close button. On cars with two entrances, a separate door-close button shall be provided for each entrance if both entrances can be opened at the same landing.
- (e) Opening and closing of power operated car doors or gates that are opposite manual swing or manual slide hoistway doors shall conform to the requirements of §2.27.3.3.1(c) and (d). Door opening and closing buttons shall be provided in the car-operating panel.
- (f) Door reopening devices rendered inoperative, per §2.27.3.1.6(e) shall remain inoperative. Full speed closing is permitted. Corridor door opening and closing buttons, if provided, shall be rendered inoperative.
- (g) Every car shall be provided with a button marked “CALL CANCEL” located in the same car operating panel as the Phase II switch, which shall be effective during Phase II operation. When activated, all registered calls shall be canceled and a traveling car shall stop at or before the next available landing.
- (h) Floor selection buttons shall be provided in the car to permit travel to all landings served by the car and they shall be operative at all times. Means that prevent the operation of the floor selection buttons or door operating buttons, shall be rendered inoperative.
- (j) A traveling car shall stop at the next available landing for which a car call was registered. When a car stops at a landing, all registered car calls shall be cancelled.
- (k) The emergency stop switch shall remain operative.

2.27.3.3.2 When the Phase II switch is in the “HOLD” position, the elevator shall be on Phase II operation. The car shall remain at the landing with its doors open. The door close buttons shall be inoperative.

2.27.3.3.3 When the Phase II switch is in the “NORMAL” position, the elevator is not at the designated or sky lobby level and Phase I is in effect, the elevator shall operate as follows.

- (a) Automatic power-operated horizontally-sliding doors shall close automatically and the car shall revert to Phase I operation {§2.27.3.1} upon completion of door closing. All door reopening devices shall remain inoperative. Door open buttons shall remain operative. Full speed closing is permitted. If the Phase II switch is turned to the “FIREMAN SERVICE” or “HOLD” position prior to the completion of door closing, the doors shall reopen.

(b) Elevators having power operated vertically sliding doors shall have corridor door open and close buttons rendered operative. All door reopening devices shall remain inoperative. Door closing shall be in accordance with the requirements of §2.27.3.3.1 (d) Full speed closing is permitted. If the Phase II switch is turned to the “FIREMAN SERVICE” or “HOLD” position prior to the completion of door closing, the doors shall reopen. The car shall revert to Phase I operation {§2.27.3.1} upon completion of door closing.

(c) Elevators having manual doors shall revert to Phase I operation {§2.27.3.1} upon completion of door closing.

2.27.3.3.4 When the Phase II switch is in the “NORMAL position and the car is not at the designated or the sky lobby level, and Phase I is not in effect, the car shall remain at the landing with the doors open and door-close buttons inoperative and shall remain in Phase II.

2.27.3.3.5 Elevators shall be removed from Phase II operation only when:

(a) The Phase II switch is in the “NORMAL” position and the car is at the designated or sky lobby level with the doors in the normal open position; or

(b) The Phase II switch is in the “NORMAL” position when Phase I is in effect at the designated or sky lobby level with the doors in the normal open position.

2.27.3.3.6.

(a) For all elevators, applications filed after March 12, 1991 (the effective date of adoption of Cal #11-91-BCR), that propose the installation, alteration or change of controller, elevator machinery and any other work, excluding minor alteration and ordinary repairs, and applications filed for new elevators, the cost of which exceeds \$10,000 per car over a twelve (12) month period, shall comply with the requirements of this subdivision.

(b) In elevators complying with the requirements of paragraph (a) above, a 3 position switch labeled “NORMAL”, “HOLD” and “FIREMAN SERVICE” shall be required to replace the existing 2 position switch (“NORMAL” and “FIREMAN SERVICE”). The new “HOLD” position shall be marked by engraving or by affixing a permanent label to the operating panel of the elevator.

Delete and revise section 2.27.3.4 to read as follows:

2.27.3.4 Interruption of Power. Upon the resumption of power following a power interruption, the car shall move in the down direction to designated or sky lobby level. Restoration of electrical power following a power interruption shall not cause any elevator to be removed from Phase I or Phase II Operation.

## 2.27.4 Firefighters' Emergency Operation Non-Automatic Elevators.

### Delete and revise section 2.27.4.1 to read as follows:

2.27.4.1 Phase I Emergency Recall Operation. A two-position key-operated switch shall be provided at the designated or the sky lobby level only for each single elevator or for each group of elevators. The two-position switch shall be "NORMAL" and "FIREMAN SERVICE" (in that order). The commissioner with the concurrence of the Fire Commissioner may allow an additional two-position key-operated switch marked "NORMAL" and FIREMAN SERVICE" (in that order) at another location. However, it shall not affect Phase I operation if the designated-level or sky lobby level smoke detector or waterflow alarm has been activated. The switch(es) shall be rotated clockwise to go from the "NORMAL" to "FIREMAN SERVICE" position. All keys shall be removable from any position.

No device, other than Phase I switch(es), smoke detectors in the elevator lobbies, machine room, or hoistway, or a waterflow alarm in lieu of smoke detectors in the elevator lobbies, shall initiate Phase I operation.

When all switches are in the "NORMAL" position, normal elevator service shall be retained and operation from the smoke detectors or waterflow alarm required shall be functional.

When a Phase I switch is in the "FIREMAN SERVICE" position, a visual and audible signal shall be provided to alert the attendant to return nonstop to the designated or sky lobby level. The visual signal shall read "FIRE RECALL – RETURN TO {insert level to which the car should be returned (The Designated Level or Sky Lobby Level)}. The smoke detectors or waterflow alarm shall be activated when Phase I is in effect.

### Delete and revise section 2.27.4.2 to read as follows:

2.27.4.2 Phase I Smoke Detectors or Waterflow Alarm Devices Activation. Smoke detectors shall be installed in accordance with the requirements of §2.27.3.2 Phase I operation and shall be initiated when either any smoke or waterflow alarms are activated.

- (a) When the lowest landing of elevators is above the designated level such as the sky lobby level, the activation of smoke detectors or a waterflow alarm in the sky lobby or sky lobby floor shall cause such elevators to return nonstop to a floor two (2) stories above the sky lobby level or in the absence of a stop at that floor, to the nearest landing above the sky lobby level.
- (b) Elevators shall react only to the first smoke detector zone that is activated for that group.
- (c) Smoke detectors and/or smoke detector systems shall not be self-resetting.



(d) Activation of smoke detectors to initiate elevator recall shall override any automatic programming for car stops but shall not affect the other elevator safety circuits.

(e) The buildings described in §2.27.3.2 (1) (k) and meeting its requirements and buildings equipped throughout with an automatic sprinkler system are exempt from the requirements of this section.

### **2.27.5 Firefighters' Emergency Operation Automatic Elevators With Designated Attendant Operation.**

#### **Delete and revise section 2.27.5.2 to read as follows:**

2.27.5.2 When operated by a designated attendant in the car (except hospital emergency service):

(a) Elevators parked at a floor shall conform to the requirements of §2.27.3.1. At the completion of a time delay of not less than 15 seconds nor more than 60 seconds, elevators shall conform to the requirements of §2.27.3. There shall be no delay when the car is at the designated level.

(b) A moving car shall conform the requirements of §2.27.3.

#### **Add three new sub-sections 2.27.5.3.1, 2.27.5.3.2 and 2.27.5.3.3 to read as follows:**

**2.27.5.3.1 Hospital Emergency Service Recall Operation.** A two-position key-operated corridor call (Hospital Emergency Service) switch shall be provided at one or more landings to activate the special control function by authorized or designated personnel. The two-position switch shall be marked "NORMAL" and "HOSPITAL EMERGENCY SERVICE". Keys shall be removal only in the "NORMAL" position.

(a) When the switch is in the "HOSPITAL EMERGENCY SERVICE" position:

(1) All patient elevator cars equipped with the special control function shall override normal automatic operating modes for immediate recall of the patient elevator(s) to the landing at which the call is registered.

(2) On patient elevator cars with two entrances, if both entrances can be opened at the designated level, the doors serving the corridor where the two-position Hospital Emergency Service switch is located shall open and remain open.

(3) A patient elevator car traveling away from the designated level shall reverse at or before the next available landing without opening its doors.

- (4) A patient elevator car stopped at a landing other than the designated level, with the doors open and in-car emergency stop switch in the run position, shall close the doors without delay and proceed to the designated level.
- (5) A visual and audible signal shall be activated within the patient elevator car to alert the passengers and/or attendant operator that the “Hospital Emergency Service” function has been activated.
- (6) Upon arrival at the registered call landing, power operated doors shall open automatically and remain in the open position for a predetermined adjustable time period to allow the authorized personnel sufficient time to activate the “In- Car” special operation function.
- (7) If the Phase I (§2.27.3.1) recall mode is initiated while the elevator is under “Hospital Emergency Service” recall mode and “In-Car” hospital emergency service is not activated, the elevator shall revert to Phase I (§2.27.3.1) operation.
- (8) Hospital emergency service corridor recall shall not override fire emergency Phase I (§2.27.3.1) or Phase II (§2.27.3.3) operation in effect.

**2.27.5.3.2 Hospital Emergency Service In-Car Operation:** A two-position “NORMAL” and “HOSPITAL EMERGENCY SERVICE” key-operated switch shall be provided in an operating panel inside the patient elevator(s) to activate the “Hospital Emergency Service”, a special independent operating mode. The switch shall be rotated clockwise to go from the “NORMAL” to “HOSPITAL EMERGENCY SERVICE” position. It shall become effective only when the designated level corridor call “Hospital Emergency Service” switch is in the “HOSPITAL EMERGENCY SERVICE” position and the car has returned to the designated level by “Hospital Emergency Service” recall operation.

- (a) When the “In-Car” switch is in the “HOSPITAL EMERGENCY SERVICE” position, the patient elevator shall be on Hospital Emergency Service operation, and the patient elevator shall operate as follows:
  - (1) The patient elevator shall be operable only by a designated person in the car.
  - (2) Activation of the “In-Car” operating mode shall remove the patient elevator from normal automatic and/or attendant service.
  - (3) The patient elevator(s) shall not be recalled under Phase I (§2.27.3.1) operation after the activation of “In-Car” operation mode.
  - (4) Doors shall remain open until the authorized person registers the car call and initiates the door closing function.

- (5) The patient elevator shall travel directly to the selected landing, overriding normal corridor call demand or Phase I (§2.27.3.1) recall and shall automatically open the doors upon the arrival at the selected landing, except when the smoke detector(s) are activated on the selected landing or the waterflow alarm is activated on that floor. In such case, before the patient elevator has reached the selected landing, the patient elevator shall stop at a floor two stories below the selected landing or in the absence of a stop at that floor, at the nearest landing below the selected landing.
- (6) When the patient elevator reaches the selected floor and the smoke detector(s) are activated on that landing or the waterflow alarm is activated on that floor before the doors are open, the patient elevator, without opening the doors, shall travel to a floor two stories below the selected landing or in the absence of a stop at that floor, to the nearest landing below the selected landing.
- (7) Doors shall remain open with the audible and visual signal functioning until the “in-Car” switch is turned to the “NORMAL” position or for a predetermined adjustable time period to allow the removal of patients from the car and the patient elevator is placed into automatic, attendant or Phase I (§2.27.3.1) if in effect, operating mode.
- (8) Upon transfer from “HOSPITAL EMERGENCY SERVICE” back to normal operation during a fire emergency and Phase I (§2.27.3.1) is in effect, the patient elevator shall be automatically recalled to the designated level.

**2.27.5.3.3 Hospital Emergency Service Switches Color.** The color of the Hospital Emergency Service switches located in the corridor at the designated level and inside the patient elevator(s) operating panel shall be “BLUE”.

**Delete section 2.27.7 in its entirety.**

**Section 2.27.7 Reserved.**

**Delete and revise section 2.27.8 to read as follows:**

**2.27.8. Switch Keys.** The switches required by §2.27.2 through §2.27.5 for all elevators in a building shall be operable only by a citywide standard key 2642. The citywide standard key shall be designed in accordance with the requirements of the Fire Department and shall be obtained only through Fire Department authorization. Citywide standard keys shall be kept on the premises by a person responsible for the maintenance and operation of the elevators in a location readily accessible to authorized persons in an emergency, but not where they are available to the public.

## **SECTION 2.29** **IDENTIFICATION**

**Delete and revise section 2.29.1 to read as follows:**

**2.29.1 Identification of Equipment.** Each elevator shall be assigned a unique alphabetical or numerical identification, a minimum of 6 mm (¼ in.) in height. The identification number shall be applied to the following locations:

- (a) The driving machine;
- (b) MG and/or Transformers set;
- (c) Controller;
- (d) Selector;
- (e) Governor;
- (f) Main line disconnect switch;
- (g) The crosshead, or where there is no crosshead, the car frame, such that it is visible from the top of the car;
- (h) The car operating panel, minimum of 13 mm (0.5 in.) in height;
- (i) Adjacent to or on every elevator entrance at the designated level, minimum of 75 mm (3 in.) height; and
- (j) Each bank of elevators shall be identified by an alphabetic letter.

**Add new section 2.29.1.1 to read as follow:**

**2.29.1.1 New York City Identification Number.** Each elevator shall be assigned a unique numerical identification, a minimum of 6 mm (¼ in.) in height. The City identification number shall be applied to the following locations:

- (a) The driving machine;
- (b) MG and/or Transformers set;
- (c) Controller;
- (d) Main line disconnect switch;
- (e) The crosshead, or where there is no crosshead, the car frame, such that it is visible from the top of the car;
- (f) The car operating panel (main panel only).

**PART 3**  
**HYDRAULIC ELEVATORS**

**SECTION 3.7**  
**MACHINE ROOMS AND MACHINERY SPACES**

**Revise first paragraph of section 3.7 to read as follows:**

Machine rooms and machinery spaces shall conform to §2.7.1 through §2.7.5 and §2.7.7 and shall be vented to the outside air naturally or mechanically.

**SECTION 3.26**  
**OPERATING DEVICES AND CONTROL EQUIPMENT**

**3.26.3 Anti-Creep and Leveling Operation.**

**Revise section 3.26.3.1.2 to read as follows:**

3.26.3.1.2 The anti-creep device shall maintain the car within [25 mm (1 in.)] 13 mm (½ in) of the landing irrespective of the position of the hoistway door.

**PART 4**  
**ELEVATORS WITH OTHER TYPES OF**  
**DRIVING MACHINES**

**SECTION 4.3**  
**HAND ELEVATORS**

**Delete section 4.3 in its entirety:**

**Section 4.3 Reserved.**

**PART 5**  
**SPECIAL APPLICATION ELEVATORS**

**SECTION 5.2**  
**LIMITED-USE/LIMITED-APPLICATION ELEVATORS**

**5.2.1 Electric Limited-Use/Limited-Application Elevators.**

**Revise sub-section (b) of 5.2.1.16.1 to read as follows:**

**5.2.1.16.1 Rate Load and Platform Area.**

(b) The inside net platform area shall not exceed 18 ft<sup>2</sup> (1.67 m<sup>2</sup>) and in no event shall be less than 1219 mm x 1219 mm (4 ft x 4 ft) with a minimum 812 mm (32 in.) clear door opening. The Car Operating Panel shall be on the strike wall.

**PART 6**  
**ESCALATORS AND MOVING WALKS**

**SECTION 6.1**  
**ESCALATORS**

**6.1.1 Protection of Floor Openings**

**Delete and revise section 6.1.3.3.5 it to read as follows:**

**6.1.3.3.5 Clearance Between Skirt and Step.** The clearance on either side of the steps between the step and the adjacent skirt panel shall not be more than 4 mm (0.16 in.), and the sum of the clearances on both sides shall be not more than 7 mm (0.28 in.).

**Add new text to sub-section (c) of 6.1.3.3.6 to read as follows:**

**6.1.3.3.6 Skirt Panels:**

(c) The exposed surfaces of the skirt panels adjacent to the steps shall be smooth and made from a low friction material, or permanently treated with a friction-reducing material. Untreated surfaces, such as porcelain, enameled steel bronze, or stainless steel, are not acceptable.

**Delete section 6.1.3.3.7 in its entirety:**

**6.1.3.3.7 Reserved.**

**Delete and revise section 6.1.3.3.8 to read as follows:**

**6.1.3.3.8 Skirt Deflector Devices.** Deflector Devices shall be required. Deflector Devices shall extend from skirt panels parallel to the escalator path of travel. Means to secure such deflector devices are required to be on the exposed surface of the skirt. Any exposed fastener heads shall be of the tamper resistant type and flush to within 1 mm (0.04 in.).

**Revise section 6.1.3.5.4 to read as follows:**

**6.1.3.5.4 Clearance Between Step Threads.** The maximum clearance between step treads on the horizontal run shall be 6 mm (0.25 in.). (See Appendix I, Fig. I7 [I6]).

**Delete and revise section 6.1.6.3.3 to read as follows:**

**6.1.6.3.6 Skirt Obstruction Device.** Means shall be provided to cause the electric power to be removed from the escalator driving machine motor and brake, if an object becomes caught between the step and the skirt as the step approaches the upper combplate, intermediate device or lower comb plate. On units having a run of 6096 mm (20 ft.) or more, intermediate devices shall be provided on both sides of the escalator with devices located at intervals of 3048 mm (10 ft.) or less. The activation of an intermediate device shall stop the escalator at a rate not greater than 914 mm (3 ft.) per second square in the direction of travel. The upper and lower comb plate devices shall be located so that the escalator will stop before that object reaches the comb plate. The activation of any skirt device shall stop the escalator when a load equal to the brake rated load is applied while the escalator is running.

**Revise section 6.1.6.3.13 to read as follows:**

**6.1.6.3.13 Comb-Step Impact Devices.** Devices shall be provided that will cause the opening of the power circuit to the escalator driving machine motor and brake if either:

- (a) A horizontal force not greater than 1 780 N (400 lbf) in the direction of travel is applied at either side, or not greater than 3 560 N (800 lbf) applied at the center of the front edge of the comb plate; or
- (b) A resultant vertical force not greater than [670 N (150 lbf)] 268 N (60 lbf) in the upward direction is applied at the center of the front of the comb plate.

**Revise section 6.2.6.3.11 to read as follows:**

**6.2.6.3.11 Comb-Pallet Impact Devices.** Devices shall be provided that will cause the opening of the power circuit to the moving walk driving-machine motor and brake if either:

- (a) A horizontal force not greater than 1 780 N (400 lbf) in the direction of travel is applied at either side, or not greater than 3 560 N (800 lbf) applied at the center of the front edge of the combplate; or
- (b) A resultant vertical force not greater than [670 N (150 lbf)] 268 N (60 lbf) in the upward direction is applied at the center of the front of the combplate. These devices shall be of the manual-reset type.

## **PART 7**

### **DUMBWAITERS AND MATERIAL LIFTS**

#### **SECTION 7.4**

#### **MATERIAL LIFTS WITHOUT AUTOMATIC TRANSFER DEVICES**

##### **7.4.2 Classification**

**Delete and revise section 7.4.2 to read as follows:**

**7.4.2 Classification of Material Lifts.**

**(a) Type A Material Lifts shall conform to ASME B20.1.**

**(b) Type B Material Lifts are not permitted.**

**SECTION 7.5**

**ELECTRIC MATERIAL LIFTS WITHOUT AUTOMATIC TRANSFER DEVICES**

**7.5.1.2 Car Doors and Gates.**

**Delete and revise section 7.5.1.2.1 to read as follows:**

**7.5.1.2.1 Requirement §2.14.4.1 applies to Type A Material Lifts.**

**7.5.3 Capacity and Loading.**

**Add new section 7.5.3.5 to read as follows:**

**7.5.3.5 The maximum capacity shall be 2,500 pounds at 50 pounds per square foot.**

**7.5.5 Speed Governors.**

**Revise section 7.5.5.1 to read as follows:**

**7.5.5.1 The requirements of §2.18.1 apply, except the rated speed shall be modified to read [1 m/s (200 ft/min)] 0.125 m/s (25 ft/min).**

**7.5.12 Operating Devices and Control Equipment.**

**Delete and revise section 7.5.12.1.5 to read as follows:**

**7.5.12.1.5 The requirements of §2.26.2.5 do not apply. An emergency stop switch (switches) conforming to §2.26.2.5(a), (b), and (c) shall be provided to stop operation of the material lift, and the door and gate operation (if power operated). The emergency stop switch shall be located in each hall station.**

**Delete and revise section 7.5.12.1.10 to read as follows:**

**7.5.12.1.10 The requirement of §2.26.2.15 applies.**

**PART 8**

**GENERAL REQUIREMENTS**



**SECTION 8.1**  
**SECURITY**

**8.1.2 Group 1: Restricted.**

**Add new Note (p) to 8.1.2 to read as follows:**

(p) The requirements of §2.14.1.10 and §5.1.11.1.2(d), side emergency exit doors apply.

**8.1.4 Group 3: Emergency Operation.**

**Delete and revise section 8.1.4 to read as follows:**

**8.1.4 Group 3: Emergency Operation.** Group 3 covers access or operation of equipment by firefighters and emergency personnel. This key shall be a citywide standard key 2642 as defined by the New York City Fire Department.

**SECTION 8.4**  
**ELEVATOR SAFETY REQUIREMENTS FOR**  
**SEISMIC RISK ZONE 2 OR GREATER**

**8.4.4 Car Enclosures, Car Doors and Gates, and Car Illumination.**

**Delete section 8.4.4 in its entirety.**

**Section 8.4.4. Reserved.**

**SECTION 8.6**  
**MAINTENANCE, REPAIR, AND REPLACEMENT**

**8.6.4.10 Refastening or Resocketing of Car Hoisting Ropes on Winding-Drum Machines.**

**Delete and revise section 8.6.4.10.1 to read as follows:**

**8.6.4.10.1**

**(1) The hoisting ropes of elevators having winding-drum driving-machines with 1:1 roping, if of the babbitted rope socket type, shall be resocketed at intervals no longer than:**

**(a) 1 year, for machines located over the hoistway;**

**(b) 2 years, for machines located below or at the side of the hoistway;**

**(c) 4 years, for all counterweight cable ends of drum machines;**

(2) In addition to the foregoing requirements, rope fastenings shall be resocketed when an inspection reveals any evidence of failure at the shackle regardless of the period of time since last re-shackling.

(3) Where auxiliary rope-fastening devices conforming to the requirements of §2.20.10 or where car hoist ropes with an additional approved type emergency clamping devices are installed, refastening at the period specified is not required provided that, where such devices are installed, all hoisting ropes shall be refastened on the failure or indication of failure of any rope fastening. Wedge clamp shackles shall not be used on drum machines.

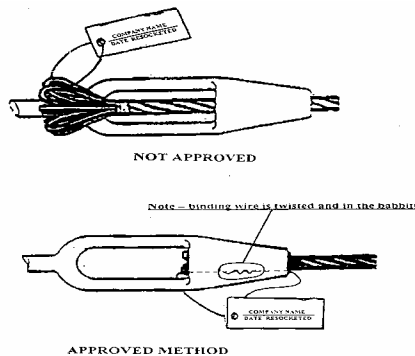
(4) Where the elevator is equipped with a drum counterweight, the fastenings shall be examined for fatigue or damage at the socket. Where fatigue or damage is detected, the ropes shall be refastened in conformance with §8.6.4.10.2.

**Delete and revise section 8.6.4.10.3 to read as follows:**

**8.6.4.10.3 Tags.** A legible metal tag shall be securely attached through one of the tapered rope sockets during each resocketing, *(as shown in the diagram below)* and shall bear the following information:

(a) The name of the person or firm who performed the resocketing and;

(b) The date on which the rope was resocketed. The material and marking of the tags shall conform to §2.16.3.3, except that the height of the letters and figures shall be not less than 1.5 mm (0.0625 in.).



**Diagram 8.6.4.10.3**

**8.6.8.3 Step/Skirt Performance Index.**

**Delete section 8.6.8.3 in its entirety.**

**Section 8.6.8.3 Reserved.**

**SECTION 8.7**  
**ALTERATIONS**

**8.7.2 Alterations to Electric Elevators.**

**Delete and revise section 8.7.2.13, sub-section (c) to read as follows:**

**8.7.2.13 Door Reopening Device.**

(c) When firefighters' emergency operation is provided, door reopening devices and door closing during Phase I and Phase II shall comply with the requirements applicable at the time of installation or alteration.

**8.7.2.14 Car Enclosures, Car Doors, and Gates, and Car Illumination.**

**Revise section 8.7.2.14.1 to read as follows:**

8.7.2.14.1 Where an alteration consists of the installation of a new car, the installation shall conform to §2.12.6, §2.14, §2.15, and §2.17 (see also §8.7.2.15.1).

**Delete and revise sub-section (e) of 8.7.2.14.2 to read as follows:**

**8.7.2.14.2**

(e) Side emergency exits may be permanently fixed in the closed position provided that the corresponding side emergency exit on an adjacent car shall also be fixed in the closed position. The installation shall conform to §2.12.6.

**Revise section 8.7.2.14.3, sub-section (b)(2) to read as follows:**

**8.7.2.14.3**

(b)(2) Smoke development of 0 to 100 [450].

**8.7.2.17 Change in Travel or Rated Speed**

**Add new sub-section (4) to 8.7.2.17.1(c) to read as follows:**

**8.7.2.17.1 Increase or Decrease in Travel.**

(4) Where the only hoistway alteration is the decrease in travel at the upper end of the travel, the installation shall be modified as follows:

(i) Terminal stopping devices shall be provided based on the new top terminal landing location and the final limit switch shall be of the manual reset type.

(ii) A key controlled switch shall be provided in accordance with §8.1.5 (i.e. Group 4) requirements to by-pass the new top terminal stopping devices, when the elevator transfer switch is placed in the Top-of-Car Inspection Operation position, for access to the hoistway above the terminal landing.

The switch shall be manually operated, be labeled “Terminal By-Pass”, and shall have two positions; By-Pass and Normal.

The switch shall be located in the hoistway, in the vicinity of the terminal limits and shall be accessible to a person standing on the car top. The car transfer switch shall not be removed from the Top-of-Car Inspection Operation position until the terminal limit By-Pass switch is placed in the Normal position.

(iii) Existing terminal stopping devices shall remain functional. The hoistway door electro-mechanical safety interlocks shall remain in the safety circuit and locked with door panel(s) separately secured in closed position on the hoistway side.

(iv) The car operating panel shall be removed with associated labeling and signaling.

#### **8.7.2.25 Driving Machines and Sheaves**

**Delete and revise sub-section (a) of 8.7.2.25.1 to read as follows:**

##### **8.7.2.25.1 Alterations to Driving Machines and Sheaves**

(a) Where a driving machine is installed as part of an alteration, the installation shall conform to §2.7.2.2, §2.9, §2.10.1, §2.19, §2.20, §2.24, and §2.26.8. The requirements of §2.7.2.2 and §2.19 shall apply only to the extent that the existing installation permits.

#### **8.7.2.27 Operating Devices and Control Equipment**

**Revise sub-section (a) of 8.7.2.27.4 to read as follows:**

##### **8.7.2.27.4 Controllers.**

(a) Where a controller is installed as part of an alteration, it shall conform to §2.22, §2.25, §2.26.1.4, §2.26.1.5, §2.26.4 through §2.26.9, and §2.27.2 through §2.27.8.

**Revise subsection 8.7.2.27.5(e) to read as follows:**

#### **8.7.2.27.5 Change in Type of Motion Control.**

(e) Car overspeed protection and unintended movement protection shall conform to §2.19 to the extent that the existing installation permits. Where hoisting machinery is retained or altered in such a way that makes the installation of an emergency braking system per 2.19.3 impossible, conformance with §2.19 is not required.

### **SECTION 8.8** **WELDING**

#### **8.8.1 Qualification of Welders.**

**Revise section 8.8.1 read as follows:**

**8.8.1 Qualification of Welders.** Where required elsewhere in this code, welding of parts, except for tack welds later incorporated into finished welds, shall be undertaken:

- (a) by welders qualified in accordance with the requirements of Section 5 of ANSI/AWS D1.1, whereby the welders shall be qualified by the manufacturer or contractor; a professional consulting engineer; or a recognized testing laboratory; or
- (b) by a fabricator qualified to the requirements of CSA W47.1, whichever is applicable (see Part 9), and
- (c) as per department rules.

### **SECTION 8.10** **ACCEPTANCE INSPECTIONS AND TESTS**

#### **8.10.1 General Requirements for Acceptance Inspections and Tests.**

**Delete and revise section 8.10.1.1.3 to read as follows:**

##### **8.10.1.1 Persons Authorized to Make Inspections and Tests.**

**8.10.1.1.3** The inspector shall be a special inspector who meets the qualifications prescribed by rule of the department.

#### **8.10.2. Inspection and Test Requirements for New Installations**

**Delete and revise sub-section (o) of 8.10.2.2.2 to read as follows:**

##### **8.10.2.2.2 Machine Room.**

**(o) Braking System.** For passenger elevators and all freight elevators, the brake shall be tested for compliance with applicable requirements. A test of the brake shall be made with 125% of load. When the car returns to one of the lower landings, the main line switch shall be pulled while the car is running at inspection speed to ensure the brake has set and holds the load. The driving machine shall safely lower, stop, and hold the car with this load. Freight elevators of class C-2 loading shall sustain and level the elevator car. (§2.16.6) (Item §2.15 of A17.2).

(1) Braking system (§2.24.8.2.2)

(2) Electromechanical brake (§2.24.8.3)

#### **8.10.4 Acceptance Inspection and Tests of Escalators and Moving Walks.**

**Delete and revise sub-section (p) of 8.10.4.1.1 to read as follows:**

##### **8.10.4.1.1 External Inspection and Tests**

**(p) Skirt Panels (Items 1.17 and 3.17)**

(1) Clearance between skirt and steps {§6.1.3.3.5 or §6.2.3.3.5(a), and §6.2.3.3.6(a)}

(2) Height above step {§6.1.3.3.6(a) or §6.2.3.3.5(b), and §6.2.3.3.6(b)}

(3) Deflection {§6.1.3.3.6(b) or §6.2.3.3.6(c)}

(4) Smoothness {§6.1.3.3.6(c) or §6.2.3.3.6(d)}

#### **8.10.5 Acceptance Inspection and Tests of Other Equipment.**

**Delete section 8.10.5.3 in its entirety.**

**8.10.5.3 Reserved.**

### **SECTION 8.11** **PERIODIC INSPECTIONS AND TESTS**

#### **8.11.1 General Requirements for Periodic Inspections and Tests.**

**Delete and revise section 8.11.1.1 to read as follows:**

**8.11.1.1 Persons Authorized to Make Inspections and Tests.** The inspector shall be a special inspector who meets the qualifications prescribed by rule of the department.

**Delete and revise section 8.11.1.3 to read as follows:**

**8.11.1.3 Periodic Inspection and Test Frequency.** See Chapter 3 of Title 28 of the *Administrative Code*.

(NOTE (8.11.1.3): Required intervals for periodic inspections and tests can be found in Table 8.11.1.3)

**Revise table N1 of Appendix N by deleting rows 6, 7 & 8 and the note. Renumber as Table 8.11.1.3.**

**(Table 8.11.1.3 is attached on page 42 of this document)**

**Delete and revise section 8.11.1.4 to read as follows:**

**8.11.1.4 Installation Placed Out of Service.** An installation placed out of service permanently or temporarily so that it cannot be operated for a definite period shall comply with the following requirements:

**8.11.1.4.1 Elevators Not in Use But Available for Service.** Elevators not in use but available for service are those elevators whose power feed line has been disconnected by opening the main line switch. All required tests shall be regularly performed and a periodic inspection shall be made, and fees shall be paid pursuant to this code. An elevator inspector shall verify that these tests and inspections are being performed, and that the power was interrupted.

**8.11.1.4.1.1 Elevators Placed Out of Service (Dismantled).** Elevators placed out of active service by dismantling shall meet the requirements for installations placed out of service. In addition, an application shall be filed with the department and an inspection fee charged. Thereafter, one (1) additional inspection per year shall be made to verify that the status is unchanged and fees shall be paid for such inspection. Before the installation is put back in service, an application shall be filed with the department. For access to the bottom of the hoistway, the requirements of §8.11.1.4.1.2(b)(4) shall apply.

**8.11.1.4.1.2 Elevators Removed and Permanently Discontinued – One Elevator Shaftway.** When a single elevator with one elevator shaftway is removed and permanently discontinued, an application shall be filed with the department and inspection fees charged. Such process shall meet the following requirements:

**(a)** If it is proposed to extend the floor at every story of the building, the new construction shall be the same or of similar construction as the existing adjacent floor and of equivalent or better fire resistive rating. All hoistway equipment shall be completely removed; rails may remain.

**(b)** If the hoistway shaft is to remain open:

- (1) All hoistway equipment shall be completely removed; rails may remain. Except as provided in item 4, all door and window assemblies opening onto masonry shaftway and masonry enclosed associated machine rooms shall be completely removed and the open space so created shall be filled with the same or similar material of equal thickness and of equivalent or better fire restive rating as the adjacent masonry.
- (2) Except as provided in item 3, all door and window assemblies opening onto the hoistway shaft that were originally enclosed with an open wire screen and subsequently enclosed with other than masonry units (i.e. metal lath and plaster or transit boards) shall remain. Such door and window assemblies shall be fastened in a closed position and shall be adequately welded or bolted shut. The assembly shall be enclosed in material of equal or similar thickness of equivalent or better fire resistive rating as the adjacent enclosure.
- (3) The sidewalk elevator door at the street level shall be fastened in a closed position and shall be adequately welded shut. The underside of such door shall be properly reinforced and supported by steel beams and columns to support the same loading as the sidewalk.
- (4) Firefighter access to the bottom of the hoistway (elevator pit) shall be provided through the door assembly of the pit door and shall meet the following requirements:

  - (i) If the machine room is located at or near the level of the bottom of the shaftway and is so located that access to the bottom of the shaftway is readily available through the machine room, the door to the machine room shall be kept closed with a heavy-duty dead bolt locking device.
  - (ii) If the machine room is located other than at or near the level of the bottom of the shaftway or the bottom of the shaftway is not otherwise readily accessible through the machine room, the lowermost door opening onto the shaftway shall be kept closed with a heavy-duty dead bolt locking device. A conspicuous sign of 26 mm (1 in.) block letters with contrasting background permanently affixed to the door and shall read "HOISTWAY."
  - (iii) The key to the locking device required in items (i) and (ii) above shall be kept by the building superintendent and shall be readily available to the commissioner or the commissioner's representative and to firefighters.



(c) The ventilation opening (smoke hole) in the flooring provided at the top of the hoistway immediately below the sheaves or at the level of the top of the machine room floor beams and the ventilation opening at the exterior portion of the machine room shall be maintained.

(d) All electric service to the elevator hoistway and machine room shall be disconnected outside the confines of the elevator hoistway and machine room.

**8.11.1.4.1.3 Elevators Removed and Permanently Discontinued – Multi-Elevator Shaftway.** When a single elevator in multi-elevator shaftway is removed and permanently discontinued, an application shall be filed with the department and inspection fees charged. Such process shall meet the following requirements:

(a) If it is proposed to extend the floor at every story of the building, the new construction shall be the same or of similar construction as the existing adjacent floor and of equivalent or better fire resistive rating. All hoistway equipment for the discontinued elevator shall be completely removed; rails may remain. The shaft enclosure shall be rearranged so that the remaining operating elevators are properly enclosed to maintain the integrity of the shaftway.

(b) If the hoistway shaft is to remain open:

(1) All hoistway equipment for the discontinued elevator shall be completely removed; rails may remain. All door assemblies serving the discontinued elevator, openings onto masonry shaftway shall be completely removed and the open space so created shall be filled with the same or similar material of equal thickness of equivalent or better fire resistive rating as the adjacent masonry.

(2) All door assemblies serving the discontinued elevator, opening onto the hoistway shaft that were originally enclosed with an open wire screen and subsequently enclosed with other than masonry units (i.e. metal lath and plaster or transite boards), shall remain. Such door assemblies shall be fastened in a closed position and shall be adequately welded shut. The assembly shall be enclosed in material of equivalent or better fire resistive rating as the adjacent enclosure.

#### **8.11.1.4.2 Escalator Installation Placed Out of Service**

**8.11.1.4.2.1 Escalators Not in Use but Available for Service.** Escalators not in use but available for service are those escalators whose power feed lines have been disconnected from the main line disconnect switch and whose entrances have been barricaded. All required tests shall be regularly performed and a periodic inspection

shall be made, and fees shall be paid pursuant to this code. An elevator inspector shall verify that these tests and inspections are being performed, and that the power was interrupted.

**8.11.1.4.2 Escalators Discontinued or Placed Out of Service.** Escalators discontinued or placed out of service shall comply with § 8.11.1.4.2.1. An application shall be filed with the department and an inspection fee charged. Thereafter, one (1) additional inspection per year shall be made to verify that the status is unchanged and fees shall be paid for such inspection. Before the installation is put back in service, it shall be subject to all of the routine and periodic inspections and tests required by this code.

**8.11.1.4.3 Escalators Removed and Permanently Discontinued.** An application shall be filed with the department and inspection fees charged. The escalator steps, newels, rails, all wire cables, and other equipment and machinery shall be completely removed. An opening created by the removal of the escalator shall be filled with new construction of the same or similar construction as the existing adjacent floor and of equivalent or better fire restive rating.

#### **8.11.1.4.3 Moving Walk Installation Placed Out of Service**

**8.11.1.4.3.1 Moving Walks Not in Use But Available for Service.** Moving walks not in use but available for service are those moving walks whose power feed lines have been disconnected from the main line disconnect switch and whose entrances have been barricaded. All required tests shall be regularly performed and a periodic inspection shall be made and fees charged. An elevator inspector shall verify that these tests and inspections are being performed, and that the power was interrupted.

**8.11.1.4.3.2 Moving Walk Discontinued or Placed Out of Service.** Moving walks discontinued or placed out of service shall meet the requirements of § 8.11.1.4.3.1 except for periodic inspection. An application shall be filed with the department and inspection fees charged. Thereafter, one (1) additional inspection per year shall be made to verify that the status is unchanged and fees shall be paid for such inspection. Before the installation is placed back in service, it shall be subject to all of the routine and periodic inspections and tests required by this code.

**8.11.1.4.3.3 Moving Walk Removed and Permanently Discontinued.** An application shall be filed with the department and inspection fees charged. The moving walk treadways, newels, rails, all wire cables, and other equipment and machinery shall be completely removed. The truss may remain. An opening created by the removal of the moving walk shall be covered by new construction of the same or similar construction as the existing adjacent floor and of equivalent or better fire resisting rating.

**Delete and revise section 8.11.1.6 to read as follows:**

**8.11.1.6 Test Tags.** A metal test tag with the test date, the category number requiring the test, and the name of the person or firm performing the test shall be installed in the machine room and at the vicinity of the lower starting station of escalators and moving walks for all Category 1, 3 and 5 tests.

**Add new language to section 8.11.2.3.4 to read as follows:**

**8.11.2.3.4 Braking System.** For passenger elevators and all freight elevators, the brake shall be tested for compliance with applicable requirements. The load shall be placed in the car as shown in Table 8.11.2.3.4 and the car run to the lowest landing by normal operating means. The driving machine shall safely lower, stop, and hold the car with this load. Freight elevators of class C-2 loading shall sustain and level the elevator car.

A test of the brake shall be made in accordance with §8.10.2.2.2 (o).

**Delete section 8.11.4.2.19 in its entirety.**

**Section 8.11.4.2.19** Reserved.

**Delete and revise section 8.11.4.2.20 to read as follows:**

**8.11.4.2.20 Clearance Between Step and Skirt.** Escalators installed under ASME A17.1d-2000 shall be tested as follows:

- (a)** The clearance between step and skirt shall be taken at each step. These measurements shall be made independently on each side of the escalator.

**TABLE 8.11.1.3**  
**REQUIRED INSPECTION AND TEST INTERVALS IN “MONTHS”**  
Periodic Tests

Reference	Equipment Type	Periodic Inspections		Category One		Category Three		Category Five	
		Requirement	Interval	Requirement	Interval	Requirement	Interval	Requirement	Interval
<u>8.11.2</u>	<u>Electric Elevators</u>	<u>8.11.2.1</u>	<u>6-12</u>	<u>8.11.2.2</u>	<u>12</u>	<u>N/A</u>	<u>N/A</u>	<u>8.11.2.3</u>	<u>60</u>
<u>8.11.3</u>	<u>Hydraulic Elevators</u>	<u>8.11.3.1</u>	<u>6-12</u>	<u>8.11.3.2</u>	<u>12</u>	<u>8.11.3.3</u>	<u>36</u>	<u>8.11.3.4</u>	<u>60</u>
<u>8.11.4</u>	<u>Escalators &amp; Moving Walks.</u>	<u>8.11.4.1</u>	<u>6-12</u>	<u>8.11.4.2</u>	<u>12</u>	<u>N/A</u>	<u>N/A</u>	<u>N/A</u>	<u>N/ A</u>
<u>8.11.5.1</u>	<u>Sidewalk Elevators</u>	<u>8.11.2.1,</u> <u>8.11.3.1</u>	<u>6-12</u>	<u>8.11.2.2,</u> <u>8.11.3.2</u>	<u>12</u>	<u>8.11.3.3</u>	<u>8.11.</u>	<u>8.11.2.3,</u> <u>8.11.3.4</u>	<u>60</u>
<u>8.11.5.2</u>	<u>Private Residence Elevators</u>	<u>8.11.2.1,</u> <u>8.11.3.1</u>	<u>—</u>	<u>8.11.2.2,</u> <u>8.11.3.2</u>	<u>12</u>	<u>8.11.3.3</u>	<u>36</u>	<u>8.11.2.3,</u> <u>8.11.3.4</u>	<u>60</u>
<u>8.11.5.6</u>	<u>Special Purpose Personnel Elevators</u>	<u>8.11.2.1,</u> <u>8.11.3.1</u>	<u>6-12</u>	<u>8.11.2.2,</u> <u>8.11.3.2</u>	<u>12</u>	<u>8.11.3.3</u>	<u>8.11.</u>	<u>8.11.2.3,</u> <u>8.11.3.4</u>	<u>60</u>
<u>8.11.5.7</u>	<u>Inclined Elevators</u>	<u>8.11.2.1,</u> <u>8.11.3.1</u>	<u>6-12</u>	<u>8.11.2.2,</u> <u>8.11.3.2</u>	<u>12</u>	<u>8.11.3.3</u>	<u>8.11.</u>	<u>8.11.2.3,</u> <u>8.11.3.4</u>	<u>60</u>
<u>8.11.5.8</u>	<u>Shipboard Elevators</u>	<u>8.11.2.1,</u> <u>8.11.3.1</u>	<u>6-12</u>	<u>8.11.2.2,</u> <u>8.11.3.2</u>	<u>12</u>	<u>8.11.3.3</u>	<u>8.11.</u>	<u>8.11.2.3,</u> <u>8.11.3.4</u>	<u>60</u>
<u>8.11.5.9</u>	<u>Screw-column Elevators</u>	<u>8.11.2.1,</u> <u>8.11.3.1</u>	<u>6-12</u>	<u>8.11.2.2,</u> <u>8.11.3.2</u>	<u>12</u>	<u>8.11.3.3</u>	<u>8.11.</u>	<u>8.11.2.3,</u> <u>8.11.3.4</u>	<u>60</u>
<u>8.11.5.10</u>	<u>Rooftop Elevators</u>	<u>8.11.2.1,</u> <u>8.11.3.1</u>	<u>6-12</u>	<u>8.11.2.2,</u> <u>8.11.3.2</u>	<u>12</u>	<u>8.11.3.3</u>	<u>8.11.</u>	<u>8.11.2.3,</u> <u>8.11.3.4</u>	<u>60</u>
<u>8.11.5.12</u>	<u>Limited-use/Limited-application Elevators</u>	<u>8.11.2.1,</u> <u>8.11.3.1</u>	<u>6-12</u>	<u>8.11.2.2,</u> <u>8.11.3.2</u>	<u>12</u>	<u>8.11.3.3</u>	<u>8.11.</u>	<u>8.11.2.3,</u> <u>8.11.3.4.</u>	<u>60</u>
<u>8.11.5.13</u>	<u>Elevators Used for Construction</u>	<u>8.11.2.1,</u> <u>8.11.3.1</u>	<u>6-12</u>	<u>8.11.2.2,</u> <u>8.11.3.2</u>	<u>12</u>	<u>8.11.3.3</u>	<u>8.11.</u>	<u>8.11.2.3,</u> <u>8.11.3.4</u>	<u>60</u>

**CHAPTER K2.**  
**MODIFICATIONS TO ASME B20.1-2003, SAFETY STANDARD FOR CONVEYORS**  
**AND RELATED EQUIPMENT**

**K201.1 General.** As referenced in section 3001.2 of the *New York City Building Code*, the provisions of ASME B20.1 —03 shall be modified in accordance with this chapter. The section numbers correlate to those in the referenced ASME standard.

**1 SCOPE**

**Revise the text of section 1 to read as follows:**

This Standard applies to the design, construction, installation, maintenance, inspection, and operation of conveyors and conveying systems in relation to hazards. The conveyors may be of the bulk material, package, or unit handling types where the installation is designed for permanent, temporary, or portable operation.

This standard shall apply, with the exceptions noted below, to all conveyor installations.

This standard specifically excludes any conveyor designed for, installed for, or used [primarily] for the movement of human beings. This standard does, however, apply to certain conveying devices that incorporate within their supporting structure, work stations or operator's stations specifically designed for authorized personnel.

This standard does not apply to conveyors such as underground mine conveyors for which specific standards are already in effect, or to equipment such as industrial trucks, tractors, trailers, automatic guided vehicles, tiering machines (except pallet load tierers), cranes, hoists, power shovels, power scoops, bucket drag lines, trenchers, platform elevators designed to carry passengers or operator, manlifts, moving walks, moving stairways (escalators), highway or railroad vehicles, cableways, tramways, dumbwaiters, pneumatic conveyors, robots or integral machine transfer devices. Some of the foregoing have specific standards.

The provisions of this Standard shall apply to equipment installed one year after the standard's date of issuance.

**4 DEFINITIONS**

**Revise the definition Vertical Reciprocating Conveyor in section 4 to read as follows:**

*Conveyor, vertical reciprocating:* a permanent reciprocating power or gravity actuated unit (not designed to carry passengers or an operator) that receives objects on a carrier and transmits these objects vertically between two or more levels.

## **6 SPECIFIC SAFETY STANDARDS**

### **6.21 Vertical Reciprocating Conveyors.**

#### **6.21.1 Add new sub-sections d, e, f, g, h, i, j and k to section 6.21.1 to read as follows:**

##### **6.21.1 Safety Considerations**

- (d) Travel distance shall be limited to less than 22 860 mm (75 ft.) with a maximum of four (4) landings served.
- (e) Conveyor(s) shall be enclosed in a two- (2) hour fire rated hoistway, equipped with a minimum 1½ hour fire rated entrance at each landing served.
- (f) Access at landings shall be a restricted area for authorized personnel with no public access.
- (g) Where there is an occupied space or an unoccupied space not secured against unauthorized access under the hoistway, the conveyor shall be equipped with a safety designed to stop and hold the conveyor with the rated full load capacity independent of the hoisting or driving mechanism.
- (h) The operating device shall not be located inside the conveyor enclosure and must be external to the hoistway at each landing served.
- (i) The system shall incorporate a position indicator at each floor landing to register the location of the conveyor.
- (j) The rated load capacity shall not be less than 239 kg/m<sup>2</sup> (49 lbs. per sq. ft.) with a maximum capacity of 9072 kg (20,000 lbs.).
- (k) The rated speed shall not exceed 406 mm/sec. (80 FPM).
- (l) VRCs are permitted only in commercial and industrial occupancies.

#### **6.21.2 Revise sub-sections (c) and (d) of 6.21.2 to read as follows:**

##### **6.21.2 Guarding.**

- (c) Vertical reciprocating conveyors designed to automatically receive and discharge material [may] shall have interlocked doors as in (b) above or, as an alternative, may be guarded by a suitable enclosure extending from the path of the moving carrier.
- (d) Where the application requires that personnel walk onto the carrier to load or unload material, the carriers shall be provided with a conveyor enclosure securely

fastened to the conveyor platform. The enclosure walls shall be of solid, grille or perforated construction; and shall be of such strength and support that when subjected to a leaning or falling rated load on the conveyor, the enclosure walls will not deflect or deform in a way that reduces running clearances to less than 13mm (0.5 in.). Enclosure entrance(s) shall be provided with solid doors or gates; and shall guard the full width opening with a minimum height of 2030mm (80 in.). Grille or perforated portions of conveyor enclosures and entrance gates shall reject a ball 38mm (1.5 in.) in diameter. [with standard railings, snap chains, or equivalent across the loading/unloading side(s). Snap chains shall be at least 39 in. at their lowest point.]

**APPENDIX L**  
**RESERVED**



**APPENDIX M**  
**SUPPLEMENTARY REQUIREMENTS FOR ONE- AND TWO-FAMILY**  
**DWELLINGS**

**SECTION BC M101**  
**GENERAL**

**M101.1 General.** The provisions of this appendix contain supplementary requirements for the design and construction of one- and two-family dwellings not more than three stories in height.

**SECTION BC M102**  
**DEFINITIONS**

**M102.1 General.** The following words and terms shall, for the purposes of this appendix and as used elsewhere in this code, have the meanings shown herein.

**DWELLING, ONE-FAMILY.** Any building or structure designed and occupied exclusively for residence purposes on a long-term basis for more than a month at a time by not more than one family. One-family dwellings shall also be deemed to include a dwelling located in a series of one-family dwellings each of which faces or is accessible to a legal street or public thoroughfare, provided that each such dwelling unit is equipped as a separate dwelling unit with all essential services, and also provided that each such unit is arranged so that it may be approved as a legal one-family dwelling.

**DWELLING, TWO-FAMILY.** Any building or structure designed and occupied exclusively for residence purposes on a long-term basis for more than a month at a time by not more than two families. Two-family dwellings shall also be deemed to include a dwelling located in a series of two-family dwellings each of which faces or is accessible to a legal street or public thoroughfare, provided that each such dwelling is equipped as a separate dwelling with all essential services, and also provided that each such dwelling is arranged so that it may be approved as a legal two-family dwelling.

**SECTION BC M103**  
**FIRE WALL SEPARATION**

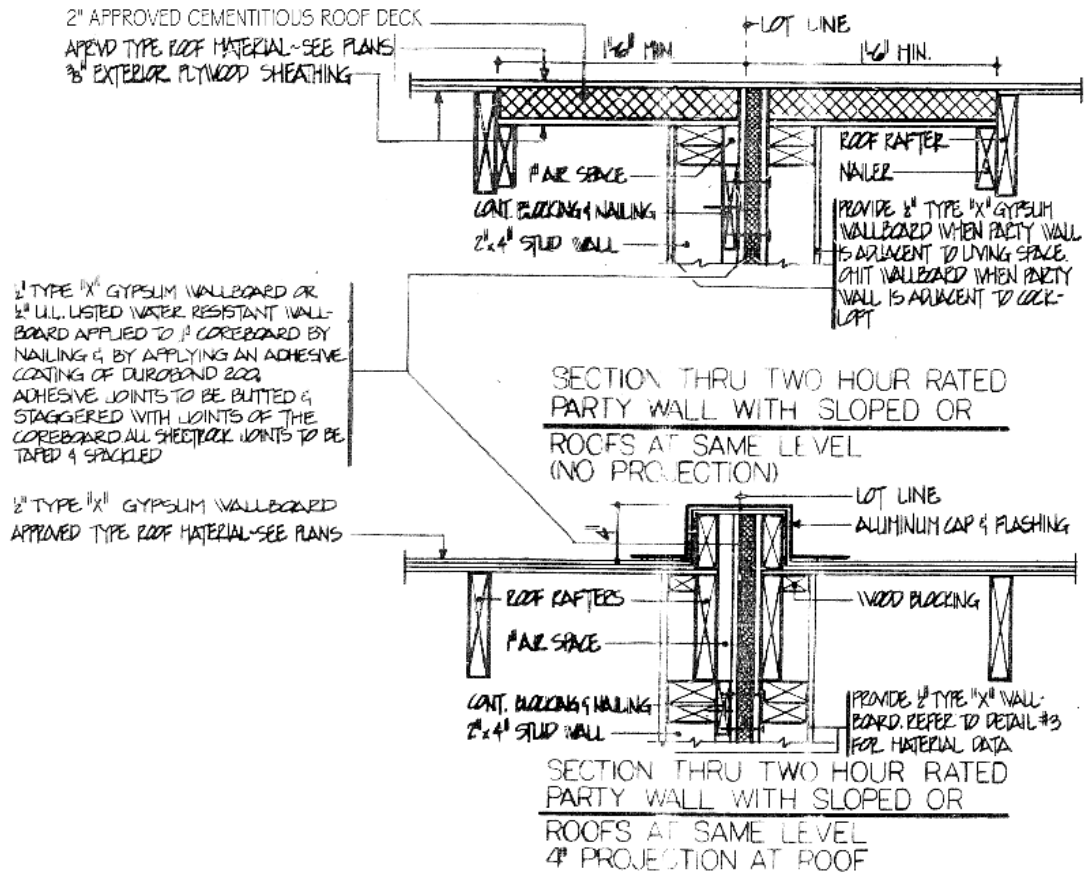
**M103.1 General.** A fire wall shall be provided between buildings in accordance with Chapter 7 of this code. However, multiple one- and two-family dwellings of construction Type IIIA, IIIB, VA and VB where permitted, not more than three stories in height, and not more than 2,100 square feet (195 m<sup>2</sup>) on a story may be separated by party walls constructed in accordance with the following and as illustrated in Figures M103(1) and M103(2):

1. Such wall shall consist of a solid 1 inch (25 mm) Type X gypsum wall board core covered on each side by ½ inch (12.7 mm) moisture-resistant Type X gypsum wall board, followed by a 1 inch (25 mm) air gap on one side. Such assembly

shall be constructed between two independently supported load-bearing stud walls. See Figure M102.1.

2. Such wall shall be continuous between foundations and roofs.
3. When roof construction on the same level is combustible on both sides of the party wall, the party wall shall extend through the roof construction to a height of at least 4 inches (102 mm) above the high point of the roof framing unless a minimum of 18 inches (457 mm) of non-combustible roof construction is provided on each side of the party wall.
4. Such party wall shall be made smoke tight at junctions with exterior walls. In buildings in construction Type VA and VB, exterior walls shall be constructed of noncombustible materials for a distance of at least 18 inches (457 mm) on each side of the party wall, or the party wall shall project at least 12 inches (305 mm) through the exterior wall.

**FIGURE M103(1)**  
**PARTY WALL VERTICAL SECTION**



## FIGURE M103(2) PARTY WALL PLAN SECTION

WHEN 4" BRICK OR STONE VENEER IS USED PROVIDE 1" AIR SPACE BETWEEN SHEATHING & 4" VENEER. REFER TO GENERAL CONSTRUCTION NOTES ALL OTHER CONDITIONS REMAIN THE SAME

1/2" TYPE "X" GYPSUM WALLBOARD OR 1/2" U.L. LISTED WATER RESISTANT WALLBOARD APPLIED TO 1" COREBOARD BY NAILING & BY APPLYING AN ADHESIVE COATING OF DURABOND 222. ADHESIVE JOINTS TO BE BUTTED & STAGGERED WITH JOINTS OF THE COREBOARD. ALL SHEETROCK JOINTS TO BE TAPED & SPACKLED

1" AIR SPACE

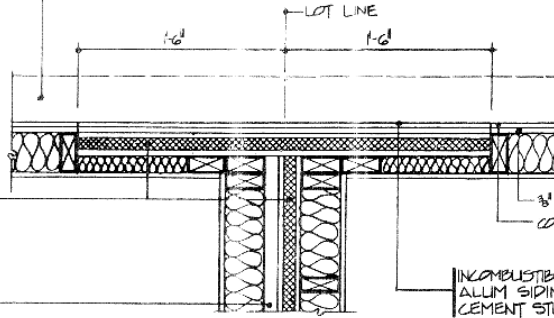
3/8" FIBERGLASS INSULATION (R-15)

1/2" TYPE "X" GYPSUM WALLBOARD

3/8" PLYWOOD SHEATHING  
COMBUSTIBLE FINISHES

INCOMBUSTIBLE FINISHES - REDWOOD, ALUM SIDING, ASBESTOS SIDING, CEMENT STUCCO, ETC.

1/2" WATER RESISTANT GYPSUM WALLBOARD



3/8" PLYWOOD SHEATHING  
COMBUSTIBLE FINISHES

INCOMBUSTIBLE FINISHES - REDWOOD, ALUM SIDING, ASBESTOS SIDING, CEMENT STUCCO, ETC.

2x4" STUDS STAGGERED EACH SIDE WITH 1/2" WALLBOARD NAILED TO EACH SIDE

COMBUSTIBLE FINISHES

INCOMBUSTIBLE FINISHES - REDWOOD, ALUM SIDING, ASBESTOS SIDING, CEMENT STUCCO, ETC.

PLAN OF TWO HOUR PARTY WALL WITH AND WITHOUT PROJECTION THRU EXTERIOR FACADE

**APPENDIX N**  
**ASSISTIVE LISTENING SYSTEMS PERFORMANCE STANDARDS**

**SECTION BC N101**  
**GENERAL**

**N101.1 Scope.** The provisions of this appendix shall control the performance standards of assistive listening systems (ALS).

**SECTION BC N102**  
**INDUCTION LOOP SYSTEM**

**N102.1 Induction loop system specifications.**

1. If the ambient electromagnetic noise (generally caused by lighting regulation systems or major power supplies) produces a field strength exceeding 30 mA/meter at frequencies that would decrease the signal-to-noise ratio specified in Item 4, then it is recommended that, unless the noise can be reduced, an induction loop system not be considered.
2. If the electromagnetic signal produced by a nearby induction loop system spills over into a new user area being considered for a different induction loop system and produces an average magnetic field strength exceeding 15 mA/meter, then it is recommended that, unless the use of each system can be scheduled so as not to occur simultaneously, an induction loop system not be considered in the new area.
3. Given an input signal to the amplifier that has a constant level over a minimum frequency range of 100 Hz to 8,000 Hz, the measured frequency response of the magnetic field generated by the induction loop system over that range shall not vary by more than +/- 3 decibels from the value at 1,000 Hz. In actual usage, graphic equalization of the output signal is allowed.
4. Given an output power level equal to the average value specified in Item 6, the minimum signal-to-noise ratio of the program signal carried by the electromagnetic field shall be at least 30 decibels.
5. Given a 1,000 Hz input signal to the amplifier that has a level sufficient to produce the minimum signal-to-noise ratio specified in Item 4, the harmonic distortion between the input signal and the program signal carried by the electromagnetic field shall not vary by more than 5 percent over the field strength range specified in Item 6.

6. Given a 1,000 Hz sinusoidal input signal, at a level equal to the long-time average level of a speech signal, the average value of the magnetic field strength generated within the user area by the loop shall equal 100 mA/meter +/- 3 decibels.

The maximum value of the magnetic field strength for a system set to the above recommended average value shall be 400 mA/meter (derived on the basis that the difference of the maximum short-time average level between a speech signal — approximately 0.125 seconds — and the long-time average level is approximately 12 decibels).

Both measurements shall be made 48 inches (1219 mm) above floor level at any point within the user area.

7. If a hand-held receiver with earphone(s) is used, the specifications in Items 3, 4 and 5 shall apply. Additionally, the sound pressure level generated by the receiver and earphone(s) shall be at least 80 decibels. The maximum high-frequency average sound pressure level generated by the receiver earphone(s) shall not exceed 130 decibels.
8. The system must have inputs capable of accepting signals at line level and microphone level and must be capable of interfacing with existing public address systems or stand-alone.
9. Any stand-alone devices powered by 110-120 volt AC used as part of the system must have been tested by an approved laboratory.
10. All input and output wiring must comply with the *New York City Electrical Code*.
11. The installation of all stand-alone components of the system must comply with the *New York City Electrical Code*.

### **SECTION BC N103** **INFRA-RED SYSTEM**

#### **N103.1 Infra-red system specifications.**

1. If the ambient infra-red light (generally caused by other infra-red light-generating devices or direct sunlight) produces interference, it is recommended that, unless the interfering infra-red light can be reduced, infra-red systems not be considered.
2. Given an input signal to the transmitter at the levels specified in Item 6 over a minimum frequency range of 200 Hz to 8,000 Hz, the measured frequency response of the output signal generated by the receiver and transducer over that range shall not vary by more

- than +/- 5 decibels from the value at 1,000 Hz. In actual usage, graphic equalization of the output signal is allowed.
3. Given an input signal to the transmitter at the levels specified in Item 6, the minimum signal-to-noise ratio of the output generated by the receiver and transducer shall be 35 decibels at all frequencies specified in Item 2.
  4. Given an input signal of 1,000 Hz to the transmitter at a level sufficient to produce the minimum signal-to-noise ratio specified in Item 3, the harmonic distortion produced by the receiver and transducer shall not be more than 5 percent.
  5. Given a 1,000 Hz sinusoidal input signal at the levels specified in Item 6, the following are the possible transducers:
    - 5.1. If using a neckloop as an output transducer, generate a magnetic field strength of at least 150 mA/meter. The peak field strength shall not exceed 600 mA/meter. Measurements shall be made at the geometric center of the plane of the neckloop.
    - 5.2. If using a silhouette as an output transducer, generate a magnetic field strength of at least 50 mA/meter (the peak field strength shall not exceed 200 mA/meter). Measurements shall be made at a distance of 10 centimeters from the silhouette.
    - 5.3. If using a miniature earphone as an output transducer, generate a sound pressure level of at least 80 decibels. The maximum high-frequency average sound pressure level shall not exceed 130 decibels.
    - 5.4. If a direct input cable is used between the output of the receiver and the input of a hearing aid boot or shoe, generate a minimum voltage range of 2 mV to 800 mV and match a boot/shoe input impedance of 50 ohms or greater. The plugs at either end shall be molded 2-pin, 3-pin and/or 3.5-millimeter mini-plug (stereo or mono).
  6. The system must have inputs capable of accepting signals at line level and microphone level and must be capable of interfacing with existing public address systems or stand-alone.
  7. The minimum light level of the transmitted infra-red carrier signal must be sufficient so that a receiver can produce the specifications in Items 2, 3, 4 and 5 at any point within the user area.

8. Any stand-alone devices powered by 110-120 volt AC used as part of the system must be tested by an approved laboratory.
9. All input wiring must comply with the *New York City Electrical Code*.
10. The installation of all stand-alone components of the system must comply with the *New York City Electrical Code*.

## **SECTION BC N104** **FM SYSTEM**

### **N104.1 FM system specifications.**

1. If an ambient FM signal (generally caused by other agencies on the same frequency or major power supplies) produces interference, it is recommended that, unless the frequency can be changed, an FM system not be considered.
2. Given an input signal to the transmitter at the levels specified in Item 6 over a minimum frequency range of 100 Hz to 8,000 Hz, the measured frequency response of the output signal generated by the receiver and a transducer over that range shall not vary by more than +/- 5 decibels from the value at 1,000 Hz. In actual usage, graphic equalization of the output signal is allowed.
3. Given an input signal to the transmitter at the levels specified in Item 6, the minimum signal-to-noise ratio of the output generated by the receiver and transducer shall be 35 decibels at all frequencies specified in Item 2.
4. Given an input signal to the transmitter at 1,000 Hz. at a level sufficient to produce the minimum signal-to-noise ratio specified in Item 3, the total harmonic distortion between the input signal and the program signal produced by the receiver and transducer shall not be more than 10 percent.
5. Given a 1,000 Hz. sinusoidal input signal at the levels specified in Item 6, the following are among the possible transducers:
  - 5.1. If using a neckloop as an output transducer, generate a magnetic field strength of at least 150 mA/meter. The peak field strength shall not exceed 600 mA/meter. Measurements shall be made at the geometric center of the plane of the neckloop.
  - 5.2. If using a silhouette as an output transducer, generate a magnetic field strength of at least 50 mA/meter. The peak field strength



shall not exceed 200 mA/meter. Measurements shall be made at a distance of 10 centimeters from the silhouette.

- 5.3. If using a miniature earphone as an output transducer, generate a sound pressure level of at least 80 decibels. The maximum high-frequency average sound pressure level shall not exceed 130 decibels.
- 5.4. If a direct input cable is used between the output of the receiver and the input of a hearing aid boot or shoe, generate a minimum voltage range of 2 mV to 800 mV and match a boot/shoe input impedance of 50 ohms or greater. The plugs at either end shall be molded 2-pin, 3-pin and/or 3.5-millimeter mini-plug (stereo or mono).
6. The system must have inputs capable of accepting signals at line level and microphone level and must be capable of interfacing with existing public address systems or stand-alone.
7. The minimum sensitivity of the receiver shall be at least 2  $\mu$ V at 12 decibel SINAD. The maximum RF signal generated by the transmitter shall not exceed 8,000  $\mu$ V/meter at 30 meters.
8. Any stand-alone devices powered by 110-120 volt AC used as part of the system must be tested by an approved laboratory.
9. All input and output wiring must comply with the *New York City Electrical Code*.
10. The installation of all stand-alone components of the system must comply with the *New York City Electrical Code*.
11. The frequencies used by the transmitter should be in compliance with applicable FCC rules.

**APPENDIX O**  
**RESERVED**

**APPENDIX P**  
**R-2 OCCUPANCY TOILET AND BATHING FACILITIES REQUIREMENTS**

**SECTION BC P101**  
**GENERAL**

**P101.1 Scope.** All toilet and bathing facilities within a dwelling unit or sleeping unit subject to Appendix P pursuant to Section 1107.2.2 shall comply with Section P102. Within each such toilet and bathing facility, at least one lavatory, one water closet and either a bathtub or shower shall comply with Section P102. Such toilet and bathing fixtures shall be in a single room, such that travel between fixtures does not require travel beyond the room in which the fixture(s) of such toilet or bathing facility are located. Where a bathing fixture is omitted in a room, the remaining fixtures shall comply with Section P102.

**SECTION BC P102**  
**TOILET AND BATHING FACILITIES**

**P102.1 Accessible route.** At least one accessible route shall connect all spaces and elements with each toilet and bathing facility within a dwelling or sleeping unit unless as permitted in Section 1107.2.5, Exception 2 of condition 3. Accessible routes shall comply with ICC A117.1.

**P102.2 Operable parts.** Lighting controls, electrical switches and receptacle outlets, and environmental controls shall comply with Section 309 of ICC A117.1.

**P102.3 Doors.** Doors shall comply with Section 1107.2.1 including maneuvering clearances as required in Section 404.2.3 of ICC A117.1. Section 1003.5, Exception 2 of ICC A117.1 shall not apply. Doors shall not swing into the clear floor or ground space or clearance for any fixture.

**Exception:** Doors may swing into the clear floor or ground space or clearances for fixtures where either:

1. A clear floor or ground space complying with Section 305.3 of ICC A117.1 is provided within the room, beyond the arc of the door swing; or
2. The door and frames are provided with mortised hinge and latch blanks to permit future reversal of the door on the same frames using common hand tools and without further alterations to the door and frames. Such future swing of the door shall not obstruct the maneuvering clearances required at the door or doorway.

**P102.4 Knee and toe clearance.** Clear floor space at fixtures shall be permitted to include knee and toe clearances complying with Section 306 of ICC A117.1.

**P102.5 Overlap.** Clear floor or ground spaces and clearances are permitted to overlap.

**P102.6 Lavatory.** Lavatories, including those within a toilet and bathing facility accessed through a private office by a single occupant, shall comply with Section 606 of ICC A117.1.

**Exception:** Cabinetry shall be permitted under the lavatory, provided:

1. Such cabinetry can be removed without removal or replacement of the lavatory; and
2. The finish floor extends under such cabinetry; and
3. The walls behind and surrounding cabinetry are finished.

**P102.7 Mirrors and medicine cabinets.** Mirrors above lavatories shall have the bottom edge of the reflecting surface 40 inches (1016 mm) maximum above the floor or ground. Medicine cabinets, if provided, must include a storage shelf no higher than 44 inches (1118 mm) above the floor.

**P102.8 Water Closet.** Water closets shall comply with Section P102.8.

**P102.8.1 Location.** The water closet shall be positioned with a wall to the rear and to one side. The centerline of the water closet shall be 16 inches (406 mm) minimum and 18 inches (457 mm) maximum from the side wall.

**P102.8.2 Clearance.** Clearance around the water closet shall comply with Sections P102.8.2.1 through P102.8.2.3 and Figure P102.8.2.

**FIGURE P102.8.2**  
**CLEARANCE AT WATER CLOSET**  
**(Figure P102.8.2 attached to end of document)**

**P102.8.2.1 Parallel approach.** Where only a parallel approach is provided to the water closet, the clearance shall be 56 inches (1422 mm) minimum, measured perpendicular from the rear wall, and 48 inches (1219 mm) minimum, measured perpendicular from the side wall. A lavatory complying with Section P102.6 shall be permitted on the rear wall, 18 inches (457 mm) minimum from the water closet centerline.

**P102.8.2.2 Forward approach.** Where only a forward approach is provided to the water closet, the clearance shall be 66 inches (1676 mm) minimum, measured perpendicular from the rear wall, and 48 inches (1219 mm) minimum, measured perpendicular from the side wall. A lavatory complying with Section P102.6 shall be permitted on the rear wall, 18 inches (457 mm) minimum from the water closet centerline.

**P102.8.2.3 Parallel and forward approach.** Where both a parallel and a forward approach are provided to the water closet, the clearance shall be 56 inches (1420 mm) minimum, measured perpendicular from the rear wall, and 60 inches (1524 mm) minimum, measured perpendicular from the side wall. No fixtures or obstructions, other than the water closet, shall be within the clearance.

**P102.8.3 Grab bars.** Grab bars for water closets shall comply with Section 609 of ICC A117.1 and shall be provided in accordance with Sections P102.8.3.1 through P102.8.3.2. Mounting heights of grab bars shall comply with Section 609.4 of ICC A117.1.

**Exception:** Grab bars are not required to be installed where reinforcement for such grab bars is installed and located to permit future installation of grab bars complying with Section P102.8.3.

**P102.8.3.1 Fixed side wall grab bars.** Fixed side wall grab bars shall be 42 inches (1067 mm) minimum in length, located 12 inches (305 mm) maximum from the rear wall and extending 54 inches (1372 mm) minimum from the rear wall. In addition, a vertical grab bar 18 inches (457 mm) minimum in length shall be mounted with the bottom of the bar located between 39 inches (991 mm) and 41 inches (1041 mm) above the floor, and with the center of the bar located at 30 inches (762 mm) from the rear wall.

**Exception:** Where a side wall is not available for a 42-inch (1067 mm) grab bar, the sidewall grab bar shall be permitted to be 18 inches (457 mm) minimum in length, located 12 inches (305 mm) maximum from the rear wall and extending 30 inches (762 mm) minimum from the rear wall.

**P102.8.3.2 Rear wall grab bars.** The rear wall grab bar shall be 24 inches (610 mm) minimum in length, centered on the water closet.

**P102.8.4 Height.** The top of the toilet seat shall be 15 inches (381 mm) minimum and 19 inches (483 mm) maximum above the floor or ground.

**P102.8.5 Flush controls.** Hand operated flush controls shall comply with Section 309 of ICC A117.1. Flush controls shall be located on the open side of the water closet.

**P102.8.6 Dispensers.** Toilet paper dispensers shall be 7 inches (178 mm) minimum and 9 inches (229 mm) maximum in front of the water closet measured to the centerline of the dispenser. The outlet of the dispenser shall be 14 inches (356 mm) minimum and 19 inches (483 mm) maximum above the floor, and shall not be located behind the grab bars.

**P102.9 Bathing facilities.** Where a bathtub or shower compartment is provided, it shall comply with Section P102.9.1 or P102.9.2.

**P102.9.1 Bathtub.** Bathtubs, including those within a toilet and bathing facility accessed through a private office by a single occupant, shall comply with Section 607 of ICC A117.1. Lavatories complying with Section P102.6 shall be permitted in the clearance required by Section 607.2 of ICC A117.1. Bathtub seats shall not be required.

**P102.9.1.1 Grab bars.** Grab bars for bathtubs, including those within a toilet and bathing facility accessed through a private office by a single occupant, shall comply with Section 609 of ICC A117.1 and shall be provided in accordance with Section 607.4 of ICC A117.1.

**Exception:** Grab bars are not required to be installed where reinforcement for such grab bars is installed and located to permit future installation of grab bars complying with P102.9.1.1.

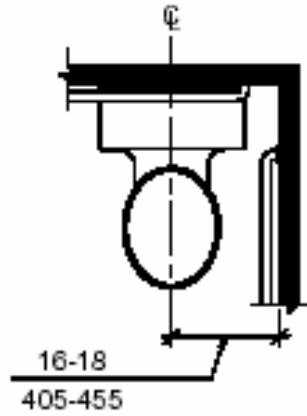
**P102.9.2 Shower.** Showers, including those within a toilet and bathing facility accessed through a private office by a single occupant, shall comply with Section 608 of ICC A117.1.

**Exception:** For showers other than transfer-type showers, counter tops and cabinetry shall be permitted at the control end of the clearance, provided such counter tops and cabinetry can be removed and the floor finish extends under such cabinetry.

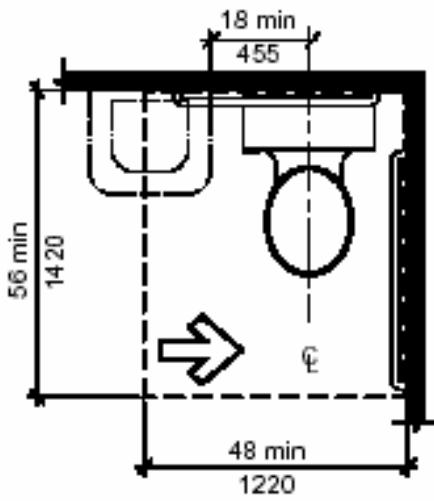
**P102.9.2.1 Grab bars and seats.** Grab bars and seats for showers, including those within a toilet and bathing facility accessed through a private office by a single occupant, shall comply with Section 609 and 610 of ICC A117.1 and shall be provided in accordance with Section 608.3 and 608.4 of ICC A117.1.

**Exception:** Grab bars and seats are not required to be installed where reinforcement for such grab bars and seats is installed and located to permit future installation of grab bars and seats complying with Section P102.9.2.1.

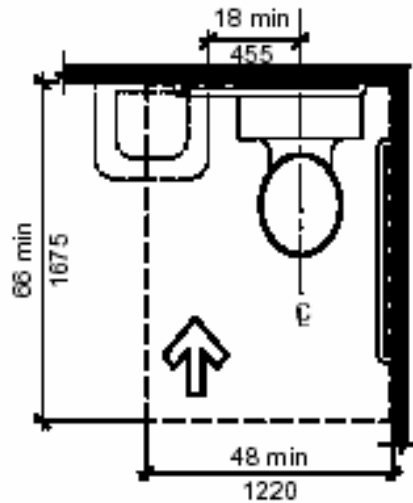
**FIGURE P102.8.2**  
**CLEARANCE AT WATER CLOSET**



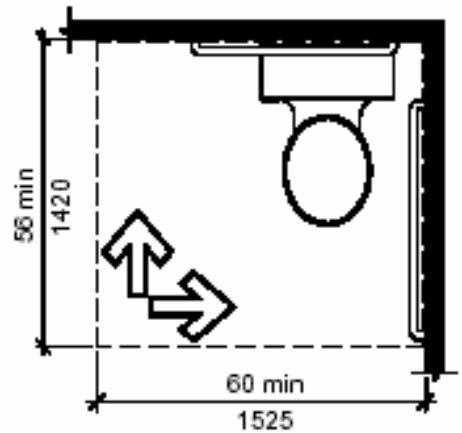
(a) Water Closet Location



(a) Parallel Approach



(b) Forward Approach



(c) Parallel and Forward Approach

**APPENDIX Q**  
**MODIFIED NATIONAL STANDARDS FOR AUTOMATIC SPRINKLER,**  
**STANDPIPE, AND FIRE ALARM SYSTEMS**

**SECTION BC Q101**  
**SCOPE**

**Q101.1 Scope.** This appendix provides the modifications to the nationally recognized standards NFPA 13, NFPA 13D, NFPA 13R, NFPA 14, and NFPA 72, governing the installation and maintenance requirements of automatic sprinkler systems, standpipe and hose systems, and fire alarm systems. Where a referenced publication has been modified for the City of New York as by the *New York City Building Code* and the *New York City Fire Code*, every reference to such publication shall be deemed to include all such modifications.

**SECTION BC Q102**  
**INSTALLATION OF SPRINKLER SYSTEMS**

**Q102.1 General.** Sprinkler systems, where required by this code, shall be installed in accordance with NFPA 13, *Standard for the Installation of Sprinkler Systems*, 2002 edition, modified for New York City as follows:

**Chapter 1 - Administration:** No changes

**Chapter 2 - Referenced Publications**

**2.1** Add at end the following: “Where a referenced publication has been modified for the City of New York by the *New York City Building Code* and the *New York City Fire Code*, every reference to such publication shall be deemed to include all such modifications.”

**2-3.6** Delete.

**Chapter 3 - Definitions**

**Chapter 4 - General Requirements** No changes

**Chapter 5 - Classification of Occupancies and Commodities** No changes

**Chapter 6 - System Components**

**6.3.1.4** Delete the words “and polybutylene”.

**6.3.6.1** Delete the word “polybutylene”

The use of pipe or tube other than that described above must involve consideration of many factors, including but not limited to the following:



1. Pressure rating.
2. Beam strength (hangers).
3. Corrosion (chemical and electrolytic).
4. Resistance to failure when exposed to elevated temperatures.
5. Methods of joining (strength, permanence, fire hazard).
6. Availability of fittings (for sprinkler outlets and proper routings).
7. Physical characteristics relating to integrity during earthquakes.
8. Toxicity
9. Combustibility
10. Movement during sprinkler operation (water distribution).

**Table 6.3.6.1** Delete the following: Specification for special listed polybutylene (PB) pipe ASTM D 3309.

Add Section 6.3.6.5 Non-metallic piping and fittings are permitted to be used only in Group R Occupancies 6 stories or less in height.

**6.4.3** Delete the word “polybutelene.”

**6.8.3** Delete.

Add Section 6.9.2.2.3 The alarm apparatus for a dry-pipe system shall also consist of approved low and high air pressure alarm attachments to the dry-pipe valve.

**6.9.5** Change “8.15.2.6” to “8.16.1.10”.

## **Chapter 7 - System Requirements**

Add Section 7.2.6.2.4 High / Low air pressure in the system shall be monitored so that either condition sends a supervisory signal. Such signal shall trigger an audible alarm notification appliance, and shall report to a central station if the system is required otherwise to do so.

**7.5.3.1** Delete.

**Table 7.5.3.1** Delete.

7.5.3.2 Add the following sentence at the end of 7.5.3.2: Backflow Prevention Device relief discharge shall be piped to a safe location.

7.6 Delete entire section including subsections.

7.9 Delete entire section including subsections.

## **Chapter 8 - Installation Requirements**

8.2.1 Delete the first sentence and replace with the following: The maximum floor area on any one floor to be protected by a single riser from a control and alarm device shall be as follows:

8.14.4.4 Delete.

8.14.4.1 Delete the reference to 8.14.4.4 and add at the end of this section the following: when required by other sections of this standard or the *New York City Building Code*.

8.14.4.5(2) Delete the words “NFPA 101, Life Safety Code” and add the words “provisions of the *New York City Building Code*.”

8.14.5 Delete.

8.14.8.1.2 Delete all words after and including “as defined”.

8.14.13 Delete entire section.

Add Section 8.14.19.3.5 In altering existing sprinkler systems which contain ¾-inch pipe, the existing ¾-inch pipe may be retained except that extension from such ¾-inch pipe shall be made using pipe having a minimum diameter of one-inch except as provided for in Section 8.14.19.3.1, 8.14.19.3.2 and 8.14.19.3.3.

Add Section 8.14.19.3.6 Where nipples used are less than 1 in. diameter, nipples shall be schedule 80 and no longer than shoulder.

Add Section 8.15.1.1.1.4 An approved indicating shutoff valve may be used in lieu of an O.S. &Y. gate valve wherever referred to in these modifications except such valve shall not be part of the pressure reducing valve. The indicator shall be readily visible from the floor.

Add Section 8.15.1.1.1.5 A connection from public water system shall not extend into or through a building unless such connection is under the control of an outside indicator post or O.S.&Y. gate or under the control of an inside O.S.&Y. gate valve located near the outside wall of the building.

Add Section **8.15.1.1.1.6** All gate valves controlling water supplied for sprinklers shall be located where readily accessible and when necessary, permanent ladders, clamped treads on risers, chains and wheels, or other accepted means shall be provided.

Add Section **8.15.1.1.1.7** Floor control valves shall be provided where required or in special cases where area or height or number of tenants is excessive, both in manufacturing and mercantile buildings, or where contents are more than ordinarily susceptible to damage. Floor valves shall be located where they are readily accessible. They are to be O.S.&Y. or indicating type located ahead of the inlet of any pressure reducing valve.

Add Section **8.15.1.1.1.8** Valves controlling sprinkler supplied from the standpipe system shall be listed for standpipe service in the pressure zone in which it is installed. They shall be O.S.&Y. or indicating valves and shall be located ahead of the inlet of any pressure reducing valve installed.

**8.15.1.1.2.2** Revise to read as follows: Floor control valves in high-rise buildings shall comply with 8.15.1.1.2.1 (1) or 8.15.1.1.2.1 (2).

**8.15.1.1.3.5** Delete and replace with the following: Where there is one water supply connection a check valve shall be installed. Such check valve may be a swing check, alarm check, an approved fire meter or an approved detector check.

**8.15.1.2.4** Delete all words including and after the word “unless”.

**8.15.1.2.5** Delete all words after and including the word “at”.

Add Section **8.15.1.1.3.6** Where a system having only one dry-pipe valve is supplied with city water and Fire Department connection, it will be satisfactory to install the main check valve in the water supply connection in a vertical position immediately inside of the building after the main indicating valve.

Add Section **8.15.1.1.3.7** Check valves on tank or pump connections, when located underground, may be placed inside of buildings and at a safe distance from the tank riser or pump, except in cases where the building is entirely of one fire area, in which case the check valve may be located over-head in the lowest level.

Add Section **8.15.1.1.4.4** Where either a wet or dry pipe sprinkler system is supplied by city water and a Fire Department connection and has more than one riser with O.S.&Y. gate valve in each, and the whole system is controlled by one outside post indicator valve, the main check valve in the water supply connection may be installed immediately inside building. If the supply is controlled by an underground gate valve with a Department of Environmental Protection standard curb, roadway or sidewalk flush box, the main check valve in the water supply connection should be installed immediately after the O.S.&Y. gate valve inside the building.

Add Section 8.15.1.1.4.5 A gate valve should be installed on each side of each check valve under conditions other than described in sections 8.15.1.1.4.1, 8.15.1.1.4.2, 8.15.1.1.4.3 and 8.15.1.1.4.4. However, this shall not apply to Fire Department siamese check valves.

Add Section 8.15.1.1.4.6 In a city connection serving as one source of supply the city valve in the connection may serve as one of the required gate valves. An O.S.&Y. valve or an indicator post valve should be installed on the systems (water supply) side of the check valve.

8.15.1.1.5.1 Delete and replace with the following: Where a gravity tank is located on a tower in the yard, the gate valve on the tank side of the check valve shall be of O.S.&Y. type; the other shall be either an O.S.&Y. valve or other listed indicating valve. Where a gravity tank is located on a building, both gate valves shall be the O.S.&Y. type; and all fittings inside the buildings, except the drain tee fill line, and heater connections, shall be under the control of a gate valve.

Add Section 8.15.1.3.3 Where sprinklers are supplied from a yard main, a listed outside indicator post gate valve shall be placed in the connecting pipe at a safe distance from the building. Indicator post valves should be located not less than 40 feet from buildings; but where necessary to place a valve close to a building, it should be located at a blank part of the wall.

Add Section 8.15.1.3.4 When a building has no basement, and an outside post indicator control cannot be furnished, a short post indicator may be installed in a horizontal position in riser with handwheel projecting outside of wall.

Add Section 8.15.1.4.2.7 Pits for underground valves except those located at the base of a tank riser, are described in the Standard for Outside Protection (ANSI/NFPA No. 24-2002). For pits protecting valves located at the base of a tank riser, refer to Section 8.15.1.4.2.6.

Table 8.15.2.4.2 Change the table to the following:

**Table 8.15.2.4.2**  
**Sectional or Floor Valve Size Minimum Size of Drain Connection**

<u>Up to 2 in.</u>	<u>1-in.</u>
<u>2-½ in. to 4-in.</u>	<u>1 1/4-in.</u>
<u>5-in. and Larger</u>	<u>2-in.</u>

Add Section 8.16.1.5.3 Identification signs shall be provided for outside alarm devices. The sign should be located near the device in a conspicuous position and shall be worded as follows: “SPRINKLER FIRE ALARM – WHEN BELL RINGS NOTIFY FIRE DEPARTMENT OR POLICE”.

8.16.1.6 Add at end a new item 4 as follows: (4) Refer to NFPA-72 for further requirements.

Add Section 8.16.1.9 as follows:

8.16.1.9 Dry Pipe System Alarms.

8.16.1.9.1 The alarm apparatus for a dry-pipe system shall consist of approved low and high air pressure alarm attachments as well as waterflow pressure type alarm attachments to the dry-pipe valve. When a dry-pipe valve is located on the system side of an alarm valve, the actuating device of the alarms for the dry-pipe valve may be connected to the alarms on the wet-pipe system.

Add Section 8.16.1.10: Drains for Alarm Devices.

8.16.1.10.1 Where vents are necessary for satisfactory electric alarm switch operations, such vents should be properly piped to a drain.

8.16.1.10.2 Drains from alarm devices shall be so arranged that there will be no danger of freezing, and so that there will be no overflowing at the alarm apparatus, at domestic connections or elsewhere with the sprinkler drains wide open and under pressure.

8.16.1.10.3 Drain from retarding chamber and electric alarm switch shall be permitted to discharge through an open cone and be run separate from main system drains to a safe and visible point of free discharge or to sewer or ground drain. Drain from water-motor-operated alarm device may run separately to sewer or ground drain or may be connected to drain from retarding chamber at a point between such sewer and a check valve on this drain, a union or plug being inserted in the drain from the alarm device to permit inspection. Where checks are used they shall be so located as to have the equivalent of at least a four-foot head and shall not be installed in a vertical position.

8.16.1.10.4 Where drains are conveyed to a sewer, a proper trap shall be provided.

8.16.1.10.5 Where it is necessary to drain alarm valves outside the wall, an open discharge cone shall be provided inside to break the pipe line so that cold air will not conduct directly into the retarding chamber. Alternately, all drains shall have at least 4 feet of pipe beyond the valves, in a warm area.

8.16.2.2 Delete items 1 – 3 and add the following:

(1) Systems with sprinklered areas not exceeding 2000 square feet.

(2) Systems containing 36 or fewer sprinkler heads except as otherwise required by other sections of this referenced standard.

8.16.2.3 Delete items 1 – 4 and add the following:

(1) Minimum size of Siamese connection is 5 in. except for Siamese connections supplying a single system with a riser smaller than 5 in. where a 4 in. Siamese connection may be used.

Add Section 8.16.4.2.1 This test pipe shall be not less than 1-inch in diameter, located in the upper story, and the connection shall be permitted to be piped from the end of the most remote branch line. The discharge shall be at a point where it can be readily observed. In locations where it is not practical to terminate the test pipe outside the building, the test pipe may terminate in a drain. In such case, the test connection shall be made using a sight test connection containing a smooth bore corrosion resistant orifice giving a flow equivalent to one sprinkler. The test valve shall be located at an accessible point, and not over seven feet above the floor. The control valve on the test connection shall be located at a point not exposed to freezing.

**8.16.5.1.2** Add at the end “where a Standpipe System is not otherwise required by Section 905 of the *New York City Building Code*.”

**8.16.5.1.3** Delete items (1), (3), (4) and (5). Modify Item (2) by adding at the end “, separately valved and connected to each sprinkler riser for hose stations located in the area covered by the sprinkler system that such riser serves upstream of all sprinkler control valves or in lieu thereof connected to the riser of an adjacent system with areas of coverage as stated above and connected upstream of all sprinkler control valves” and renumber as item (1).

**8.16.5.1.4** Add at the beginning “Where a Standpipe System is not otherwise required by Section 905 of the NYC Building Code,” and delete item (2) and renumber items (3), (4) and (5) to (2), (3) and (4), respectively.

## **Chapter 9 - Hangers** No changes

## **Chapter 10 - Underground Piping**

**10.10.1** Delete and replace with the following: The installing contractor shall perform all required inspections and acceptance tests in accordance with this chapter prior to scheduling an inspection.

**Figure 10.10.1** Delete.

## **Chapter 11 - Design Approaches**

Add Section 11.2.2.10 Where the water supply to a system sized in accordance with the pipe sizing schedules is taken from a water storage tank, the adequacy of the tank capacity shall be verified with a hydraulic calculation.

11.2.3.1.1 Delete and replace with the following: The minimum water supply requirements for a hydraulically designed occupancy hazard fire control sprinkler system shall be determined in accordance with the requirements of section 11.2.3.1.5.

Add Section 11.2.3.1.1.1 In fully sprinklered buildings, where an Automatic Wet Standpipe System is not required by Section 905 of the *New York City Building Code*, the storage capacity of the fire reserve in the tank supplying water to the sprinkler system shall be as required for the sprinkler demand, at a minimum.

## **Chapter 12 Storage**

## **Chapter 13 - Special Occupancy Requirements**

Add section 13.1.1.3 The application of the requirements of this Chapter are subject to the approval of the Fire Commissioner.

13.15.2.1.1 Add the following at the end of the first paragraph: Sprinklers shall be provided in chute vestibules on all floors; if no vestibule exists, sprinklers shall be provided above chute doors and shall be located no more than 1-foot horizontally from face of chute door. All building service chute sprinkler systems shall be provided with a local water flow and valve supervisory alarm with central station annunciation. In high rise buildings where sprinklers in chutes are supplied by a chute riser(s), such riser(s) shall be zone to coincide with the zoning of the standpipe riser(s) that supplies them”.

## **Chapter 14 - Plans and Calculations**

14.1.3 (35) Add the words “if required” at the end of this line item.

## **Chapter 15 - Water Supplies**

15.1.1 Add the following:

(a) Two automatic sources of water supply shall be provided for sprinklers in:

(1) Buildings classified in occupancy group H.

(2) Buildings classified in occupancy group M when the area on one floor exceeds 20,000 square feet.

(3) Buildings classified in occupancy group A-1 when open heads are required for stages of unlimited size.

(b) The domestic water supply may be used to supply any sprinklers required by the *New York City Building Code* Section 903 when installed in buildings classified in occupancy groups B, E, I and R, and not classified as a high-rise building, provided that all the requirements stated in subdivision (d) of this section are met.

(c) The domestic water supply may be used to supply water to sprinklers in cooling towers if provision is made to automatically stop the use of water through the domestic supply lines and provided that all of the requirements stated in subdivision (d) of this section are met.

(d) When the domestic water is used to supply sprinklers as permitted in subdivisions (b) and (c) of this section, all of the following conditions shall be met:

(1) The domestic water supply line from the tank or street supply shall be at least the size of the sprinkler line and the capacity available shall be at least equal to the capacity required for the sprinklers.

(2) The domestic water supply line from the tank or street shall have the required pressure as provided in this referenced standard.

(3) The domestic water supply line shall be of nonferrous material except when the domestic water supply is four inches or more.

(4) An O.S. and Y. valve or other listed valve having visual indication, and sealed open, shall be installed in the sprinkler supply branch, or such other valve arrangement as may be provided in this referenced standard and in referenced standards NFPA-13R or NFPA 13-D as modified for New York City, as applicable.

(5) The pipe connecting the domestic water supply and the sprinkler control valve shall be of nonferrous material and not less than twelve inches long.

(6) The number of heads in each fire section shall not exceed twenty, except that the number of heads in each fire section may exceed twenty in buildings classified in occupancy group R-2, or R-3 not exceeding six stories or 75 feet in height and in spaces classified in occupancy group R-2, or R-3 in buildings not exceeding six stories or 75 feet in height, provided that no more than 10 heads are supplied from any one domestic water riser.

(7) The connection shall be made at the supply or riser side of any domestic branch control valves.

(8) In connection with the above conditions, the number of fire sections having 20 or fewer heads may be unlimited; and the installation of alarms in branches supplying fire sections shall be at the option of the owner, except that such alarms shall be provided where required by referenced standards NFPA-13R and NFPA-13D as modified for New York City.

(9) A check valve shall be installed on the sprinkler supply branch.

**15.1.3.2 (1) Delete the words “or Class II Standpipes”.**



## **Pumps**

### **15.2.2 Add the following new sections:**

**15.2.2.1 Combined Use.** In light hazard occupancies with only limited ordinary hazard areas, an automatic fire pump serving the lower 300 feet of the standpipe system may be used as the primary supply to the sprinkler system, provided that an automatic switching secondary power supply is available to drive the pump, where secondary power is required by other provisions of this code, and that and that the pump is fully supervised as to pump running and power loss. The supervisory attachments shall be directly connected to an office where maintenance personnel are in attendance twenty-four hours a day; or, in lieu thereof, the supervisory attachment may be directly connected to the central station of an approved operating fire alarm company

**15.2.2.2** In hydraulically designed sprinkler systems supplied from a gravity tank, the pressure may be increased by means of an automatic, special service fire pump. The pump shall be sized to satisfy the water supply requirements of this section and the *New York City Building Code* and shall be arranged with a bypass to permit the portion of the system so supplied to be served by the system's siamese connections.

If the pump is not supplied from the street side of the building service switch, the electrical service and pump operation shall be fully supervised and an automatic switching secondary power supply provided to drive the pumps, where secondary power is required by other provisions of this code.

**15.2.2.3 Wiring for Fire Pumps.** When the fire pump feeder conductors are routed through the building(s), they shall be enclosed by 2 in. of concrete or an assembly which has a minimum of 1-hour fire resistive rating. Wiring for all fire and sprinkler pumps shall be in accordance with the *New York City Electrical Code*.

**15.2.2.4 Sprinkler Booster Pumps.** Where the pressure from the city water main is insufficient to comply with the requirements of this referenced standard, but is sufficient to provide at least 5 PSI at the highest level of sprinklers as determined by test, an automatic, electrically driven pump installed for the purpose of boosting or increasing the city water pressure in the sprinkler system may be used subject to the following requirements:

(a) Pumps shall be of approved centrifugal type, capable of delivering at least 200 GPM, and shall be capable of supplying the calculated flow and pressure demand of the sprinkler system.

(b) Pumps shall be maintained under approved automatic control with closed circuit supervisory attachment. The supervisory attachments shall be directly connected to an office where maintenance personnel are in attendance twenty-four hours a day; or, in lieu thereof, the supervisory attachment may be directly connected to the central station of an

approved operating fire alarm company. The supervisory alarm services shall be arranged so as to provide positive indication at an approved central office or sprinkler alarm panel board that the pump has operated or that the source of electrical supply has failed.

(c) Such pumps shall also comply with the applicable provisions of this Referenced Standard and the *New York City Building Code* pertaining to Fire Pumps, except that only one water supply and no enclosure shall be required.

(d) Power to such pumps shall be supplied from the street side of the building service switch. Secondary power shall be provided where required by other provisions of this code.

(e) If a secondary power supply is provided to drive the pump and such power supply is automatic switching, the 5 PSI requirement in section 15.2.2.4 and the requirements of paragraph (d), for power to be supplied from the street side of the building service switch, may be waived.

### **Pressure Tanks**

**15.2.3.1 to 15.2.3.3.2 delete and replace with the following:**

**15.2.3.1** A pressure tank providing water supply in accordance with Table 11.2.2.1 or 11.2.3 is an acceptable water supply source. The total available quantity of water in pressure tanks need not exceed 15,000 gallons when there is a secondary source of water supply available from a gravity tank or a street connection. The maximum gross capacity of a single pressure tank shall be 9,000 gallons and shall include the needed extra capacity to fill dry-pipe or preaction systems when installed.

**15.2.3.1.1** Each tank shall be kept at a maximum of  $\frac{2}{3}$  full of water and a minimum of  $\frac{1}{3}$  full of air maintained under a minimum pressure of 75 psig. The water-to-air ratio shall be so proportioned and the tank so located that a minimum pressure of 15 psig will be available on the highest line of sprinklers below the main roof when all the water has been discharged from the tank.

**15.2.3.1.2** The tank supports shall be designed on the basis of a full tank. The tanks shall be supplied with water through a fixed pipe, independent of the sprinkler piping and at least 2 inch in size. The water supply shall be capable of supplying the tank at a rate of at least 65 gpm without decreasing the pressure in the tank. The tank shall have a fixed water level plate on the end of the tank opposite the gage glass, or equivalent devices, to indicate the level of the water in the tank.

**15.2.3.1.3** The air compressor shall be provided with automatic controls for maintaining the air pressure. The capacity of the compressor shall be sufficient to build up the tank pressure to 75 psig within 3 hr. or less.

15.2.3.1.4 Pressure tanks shall be provided with closed circuit high and low water and high and low air pressure alarms.

15.2.3.1.5 Pressure tanks shall be located at or above the top level of sprinklers.

### **Gravity Tanks**

15.2.4 Add at end the following: If any of the sprinkler heads are supplied from domestic water tanks, the combined water supply in the tank shall be at least 5,000 gallons. Further, the sprinkler water supply shall be taken from the lowest level of the tank.

Add Section 15.2.4.1 Combined Use. In A, B, E, I and R Occupancies, with only limited ordinary hazard areas, the sprinkler and standpipe reserve may be common to both. The Reserve shall be sized for the greater demand, in accordance with NFPA 14, section 7.10.1.3. For purposes of this section, limited shall be defined as less than 30 percent of the floor area on the given floor. Buildings whose occupancies are more than 85 percent light hazard may have a light hazard water supply, provided the ordinary hazard areas are designed for ordinary hazard requirements with respect to sprinkler spacing and pipe sizing.

Add Section 15.2.4.2 Combined standpipe and sprinkler systems may be used in Occupancies A, B, E, F, I, M, R and S. If an automatic fire pump is used as the primary supply, the requirements of 15.2.2.1 shall apply.

### **Chapter 16 Systems Acceptance**

16.1 Delete and replace with the following: The installing contractor shall inspect and test the installation in accordance with the procedures of this chapter prior to scheduling an inspection.

16.3 Delete entire section.

16.3.1 Delete.

16.3.2 Delete.

16.3.3 Delete.

16.3.4 Delete.

Chapter 17 - Marine No Changes.

### **Chapter 18 - System Inspection, Testing and Maintenance:**

18.1 Delete and replace with the following: General. A sprinkler system installed in accordance with this standard shall be properly inspected, tested, and maintained in

accordance with NFPA 25, *Standard for the Inspection, Testing, and Maintenance of Water-Based Fire Protection Systems* and the *New York City Fire Code*, to provide at least the same level of performance and protection as designed.

## ANNEXES

**The Annexes are not a part of the requirements of this Referenced Standard but are included for informational purposes only. This annex contains explanatory material, numbered to correspond with the applicable text paragraphs. In the event of any conflict between the Annexes and the body of the Referenced Standard, particularly where modifications have been made for New York City, the body of the Referenced Standard will govern.**

### Annex A

A.5.2 Move Occupancy Classification of Theaters and Auditoriums from Light Hazard to Ordinary Hazard Group 1.

A.11.2.3.1.7 Delete.

## SECTION BC Q103

### INSTALLATION OF SPRINKLER SYSTEMS IN ONE- AND TWO-FAMILY DWELLINGS AND MANUFACTURED HOMES

**Q103.1 General.** Sprinkler systems, where required by this code, shall be installed in accordance with NFPA 13D, *Standard for the Installation of Sprinkler Systems in One- and Two-Family Dwellings and Manufactured Homes*, 2002 edition, modified for New York City as follows:

**Chapter 1 - Administration** No Changes.

### **Chapter 2 - Referenced Publications**

**2.2** Add at end the following: Where a referenced publication has been modified for the City of New York by the *New York City Building Code* and the *New York City Fire Code*, every reference to such publication shall be deemed to include all such modifications.

### **Chapter 3 - Definitions**

**3.3.9.3** Delete.

**3.3.9.6** Delete.

### **Chapter 4 - General Requirements**

4.2.1 Add at end the following: The owner is responsible for the maintenance of the system.

4.3.1 Delete and replace with the following: Where a Fire Department pumper connection is not provided, the system shall be hydrostatically tested for leakage at 50 PSI above normal system operating pressure and checked visually for leakage at each joint or coupling.

Add new Section 4.3.3 Fire Department connections are not required for systems covered by this standard, but may be installed at the discretion of the owner. In these cases, hydrostatic tests in accordance with Reference Standard NFPA 13-2002, as modified for New York City, are necessary. Dry systems should also be tested by placing the system under 40 pounds (2.8 bar) air pressure. Any leak that results in a drop in system pressure greater than 2 psi (0.14 bar) in 24 hours should be corrected. Check for leaks using soapy water brushed on each joint or coupling. Leaks will be shown by the presence of bubbles. This test should be made prior to concealing of piping.

## **Chapter 5 - System Components**

5.2.1 Add at end the following: Non-metallic pipe shall be used in wet systems only.

5.2.1.3 Delete.

5.2.2.2 Delete the words “and polybutylene (PB)”.

Table 5.2.2.2 Delete the line for “Specification for Polybutylene (PB) Pipe” and delete the reference to “ASTM D 3309”.

5.2.9.2 Delete the words “and polybutylene (PB)”.

5.3 Delete.

## **Chapter 6 - Water Supply**

6.2 Add the following as item (5):

(5) A common supply main to the building, serving both sprinklers and domestic uses, may be used if provision is made to prevent flow on the domestic water system upon operation of sprinklers, and closure of the main sprinkler control valve(the house control valve) will shut off the domestic water supply.

6.3 Delete.

## **Chapter 7 - Installation**

7.1.1 Delete the remainder of the sentence starting with and including the word “unless”.

7.1.2 Delete and replace with the following: Except for the meter set controlling combined domestic water and fire sprinkler systems, sectional control valves and other valves if provided in supply pipes to sprinklers shall be locked open and supervised open by one of the following methods:

(a) Central station, proprietary or remote station signaling service, or

(b) Local signaling service that will cause the sounding of an audible signal.

Exception - Underground gate valves with roadway boxes need not be supervised.

7.1.3 Delete the remainder of the sentence starting with and including the word “other”.

7.6 Add at the end the following: as modified for New York City.

## **Chapter 8 - System Design**

8.3.3.3.1.1 Delete and replace with the following: Arrangement of supply piping to an anti-freeze system shall be in accordance with NFPA-13-2002 as modified for New York City.

8.3.3.3.1.2 Delete.

8.3.3.3.1.3 Delete.

8.3.3.3.2 Delete.

8.3.3.3.2.1 Delete.

8.3.3.3.2.2 Delete.

8.3.3.3.2.3 Delete.

8.4.3.2 Delete the remainder of the section starting with and including the word “unless”.

8.4.3.3 Delete.

8.6.4 Add the following after the word “garages”: provided that at least one sprinkler head is located within 3 feet (914mm) of any communicating opening between the garage and the dwelling.

8.6.5 Add after the word “attics”, the words “without floors”.

## **ANNEXES**

**The Annexes are not a part of the requirements of this Referenced Standard but are included for informational purposes only. This annex contains explanatory material, numbered to correspond with the applicable text paragraphs. In the event of any conflict between the Annexes and the body of the Referenced Standard, particularly where modifications have been made for New York City, the body of the Referenced Standard will govern.**

A.5.2.2.2 Delete.

A.5.2.9.2 Delete.

Figure A.6.2 (c) Delete the sprinkler control valve shown.

A.6.3 Delete.

Figure A.6.3 (a) Delete.

Figure A.6.3 (b) Delete.

Figure A.6.3 (c) Delete.

A.8.4.3.3 (i) Delete.

**SECTION BC Q104**  
**INSTALLATION OF SPRINKLER SYSTEMS IN RESIDENTIAL**  
**OCCUPANCIES UP TO AND INCLUDING SIX STORIES IN HEIGHT**

**Q104.1 General.** Sprinkler systems, where required by this code, shall be installed in accordance with NFPA 13R, *Standard for the Installation of Sprinkler Systems in Residential Occupancies up to and Including Four Stories in Height*, 2002 edition, modified for New York City as follows:

**Chapter 1 - Administration**

1.1 Delete the word “four” and replace with “six”.

**Chapter 2 - Referenced Publications**

2.2 Add at end the following: Where a referenced publication has been modified for the City of New York by the *New York City Building Code* and the *New York City Fire Code*, every reference to such publication shall be deemed to include all such modifications.

**Chapter 3 - Definitions**

3.3.5 Delete.

3.3.6 Delete (Use definitions contained in NYC BC).

**Chapter 4 - General Requirements** No changes.

**Chapter 5 - System Components**

5.2.1 Add at the end the following: Non-metallic pipe shall be used in wet systems only.

5.2.2.2 Delete the words “and polybutylene (PB)”.

Table 5.2.2.2 Delete “Specification for Polybutylene (PB) Pipe ASTM D 3309”.

5.2.10.2 Delete the words “and polybutylene (PB)”.

5.3.2 (1) Delete and replace with the following: Antifreeze systems – Only glycerin type anti-freeze is permitted for use in systems containing non-metallic pipe or fittings.

**Chapter 6 - Working Plans, Design, Installation, Acceptance Tests and Maintenance**

6.2.2 Delete.

Figure 6.2.2 Delete.

6.5.3 Add the following as item (5):

(5) A common supply main to the building, serving both sprinklers and domestic uses, may be used if provision is made to prevent flow on the domestic water system upon operation of sprinklers, and closure of the main sprinkler control valve (the house control valve) will shut off the domestic water supply.

6.5.5 Delete.

6.5.6 Delete.

6.6.1.2 Delete and replace with the following:

Except for the meter set controlling combined domestic water and fire sprinkler systems, sectional control valves and other valves if provided in supply pipes to sprinklers shall be locked open and supervised open by one of the following methods:

(a) Central station, proprietary or remote station signaling service, or

(b) Local signaling service that will cause the sounding of an audible signal at a constantly attended point.

Exception- Underground gate valves with roadway boxes need not be supervised.



6.6.4 Delete and replace with the following:

**Fire Department Connection.** Except in buildings classified in occupancy group R-1, at least one 3 in. (76 mm) single inlet Fire Department connection shall be provided and located in accordance with the *New York City Building Code*. Buildings classified in occupancy group R-1 shall be provided with siamese connections in accordance with the referenced standard NFPA-13-2002 as modified for New York City.

6.6.4.1 Delete.

6.6.4.2 Delete.

6.8.5 After the word “attics” add the words: “without floors”.

Add Section 6.8.7 Location of sprinklers installed in buildings classified in occupancy group R-1 shall be in accordance with the requirements of the *New York City Building Code* and NFPA -13-2002 as modified for New York City.

6.9.2 Delete and replace with the following: Sprinkler systems shall be inspected, tested, and maintained in accordance with the *New York City Fire Code* and with the rules of the Fire Department.

## ANNEXES

**The Annexes are not a part of the requirements of this Referenced Standard but are included for informational purposes only. This annex contains explanatory material, numbered to correspond with the applicable text paragraphs. In the event of any conflict between the Annexes and the body of the Referenced Standard, particularly where modifications have been made for New York City, the body of the Referenced Standard will govern.**

A.1.1 Delete the words “four stories” and replace with the words: “six stories”.

A.5.2.2.2 Delete.

A.5.2.10.2 Delete.

A.6.3.2 Delete the words “, or flexible piping such as listed polybutylene,” and delete the sentence that reads “Testing with air pressure is permitted for polybutylene piping where conducted in accordance with the testing procedures of 16.2.2.1 of NFPA 13, *Standard for the Installation of Sprinkler Systems*.”

A.6.5.5 Delete.

Table A.6.5.5(a) Delete.

**Table A.6.5.5(b) Delete.**

**SECTION BC Q105**  
**INSTALLATION OF STANDPIPE AND HOSE SYSTEMS**

**Q105.1 General.** Standpipe and hose systems, where required by this code, shall be installed in accordance with NFPA 14, *Standard for the Installation of Standpipe and Hose Systems*, 2003 edition, modified for New York City as follows:

**Chapter 1 – General Information:** No changes

**Chapter 2 – Referenced Publications**

**2.1** Add at end the following: Where a referenced publication has been modified for the City of New York by the *New York City Building Code* and the *New York City Fire Code*, every reference to such publication shall be deemed to include all such modifications.

**Chapter 3 - Definitions**

**3.3.9** Add at end the following: For the purposes of this section, a penthouse of any area with an occupant load greater than 10 shall be considered a story.

**3.3.27.2** Add at end the following: Class II standpipe systems are permitted for high pile and rack storage occupancies only.

**Chapter 4 – System Components and Hardware**

**4.2.2** Delete and replace with the following: Pipe for buried portions of the standpipe system, whether inside or outside of the building, shall be red brass, ductile iron, hard tempered type “K” copper tubing, galvanized steel or other approved corrosion resistant material. All such pipe, other than ductile iron, shall be adequately wrapped or otherwise protected against corrosion.

Add Section **4.2.2.1** Where ductile iron pipe is installed in accordance with Table 4.2.1, it shall be lined in accordance with AWWA C104, *Cement-Mortar Lining for Ductile-Iron Pipe and Fittings for Water*.

**4.2.3** Add at end the following: Piping conforming to the specifications contained in this section may only be used in buildings with floor heights not exceeding 300 feet above grade plane or in the highest 300 foot portion of other buildings. Otherwise piping conforming to the wall thicknesses specified in 4.2.4 shall be used.

**4.5.1** Add at end the following: 6 inch and larger sectional and riser control valves shall have a minimum ¾ inch valved by-pass.

4.6.2.1 Change “30.5 m (100 ft)” to “38.1 m (125 ft)”.

4.6.2.2 Delete.

4.6.3.2 Delete.

4.6.5 Delete and replace with the following: **Label.** Each rack or storage facility for 40-mm (1½-in.) hose shall be provided with a label that shall include operating instructions.

4.7.2 Delete and replace with the following: Hose connections shall have nominal 2-½ inch threads conforming to FDNY standards.

4.8.2 Delete and replace with the following: Each Fire Department connection shall have at least two 3 inch internally threaded swivel fittings having threads conforming to FDNY standards and be of a minimum size of 5 inches except where supplying a single 4 inch standpipe riser, in which case the minimum size shall be 4 inches.

4.8.2.1 Add at end the following: Caps shall be painted red, except that the caps for combination standpipe and sprinkler systems shall be painted yellow, and caps for sprinkler systems only shall be painted green.

4.8.2.2 Delete and replace with the following:

Siamese connections shall be provided as follows:

(a) One siamese connection shall be provided for each 300 feet of exterior building wall or fraction thereof facing upon each street or public space.

(b) Where buildings face upon two parallel streets or public spaces without an intersecting street or public space, one siamese shall be provided for each 300 feet of exterior building wall or fraction thereof facing upon each such parallel street or public space.

(c) Where a building faces upon two intersecting streets or public spaces and the total length of the exterior building walls facing upon such streets or public spaces does not exceed 300 feet only one Siamese connection need be installed provided the siamese connection is located within 15 feet of the corner and on the street with the longest building frontage.

(d) Where a building faces on three streets or public spaces, one siamese connection shall be provided for each 300 feet of building wall or fraction thereof facing upon such streets or public spaces provided that at least one siamese connection is installed on each of the parallel streets or public spaces, and further provided that the siamese connections shall be located so that the distance between them does not exceed 300 feet.

(e) Where a building faces upon four streets or public spaces, at least one Siamese connection shall be provided on each street front or public space; however, only one siamese connection need be provided at the corner of two intersecting streets or public spaces if the siamese connection is located within 15 feet of the corner and on the street with the longest building frontage or public space, and if the distances between siamese connections, in all cases, do not exceed 300 feet.

(f) In any case where the exterior building walls of a building facing a street or public space are obstructed in part by another building, one siamese connection shall be provided for each clear three hundred feet of exterior building wall or fraction thereof facing upon such street or public space.

(g) Location.

(1) Siamese connections shall be placed between 18 inches and 36 inches above the sidewalk level.

(2) Siamese connections shall be of the flush or free standing type, and with the exception of the swivel caps, shall not project beyond the street property line. The riser pipe to a free standing siamese connection shall be red brass. When siamese connections are installed in wall recesses, the recesses shall be of ample size to permit convenient hose attachment.

(h) Check valve.-Each siamese connection shall be provided with a swing-type check valve inside of the building or in a valve pit outside of the building. In addition, each high zone siamese zone shall be provided with a swing-type check valve located at each connection between the high zone siamese express riser and the high zone standpipe system and located at the level of such connection.

(i) Drip valve. A ¾ inch automatic ball drip valve shall be placed between the siamese connection and the check valve, except that on a fireboat siamese connection, a ½ inch open drip without a shutoff may be used. Automatic ball drips shall be placed in the horizontal position.

(j) Fire Department siamese connections shall be provided in maximum siamese zone heights of 600 feet, supplying no more than two standpipe zones. A normally closed valved interconnect shall be provided between each siamese zone.

(1) Express piping to high zone Siamese connections shall not be installed in stairway enclosures but may be installed in any other protected shaft.

(2) Isolation valves shall be provided in all standpipe risers at 100 foot vertical intervals

4.10 Add at end the following: All interior signage shall have a red background with minimum 1 inch high white letters. All exterior signage shall have a white background with minimum 1 inch high red letters.

## **Chapter 5 – System Requirements**

5.1.3 Add at end the following: and Section 905 of the *New York City Building Code*.

5.1.4 Delete.

5.3.2.1 Delete.

5.3.3.1 Delete.

5.3.3.2 Delete all after the word “required” and add the following: except where specifically required by Section 905 of the *New York City Building Code*.

5.4.1.1 Delete the words “manual, automatic, or semiautomatic” and replace with the words: manual-wet or automatic-wet.

5.4.1.2 Delete the words “automatic or semi-automatic” and replace with the words: automatic-wet.

5.4.3 Delete “or semi-automatic wet”.

## **Chapter 6 – Installation requirements**

6.1.2.1 Add at end the following: in accordance with the requirements of section 905 of the *New York City Building Code*.

6.1.2.2 - Add at end the following: in accordance with the requirements of section 905 of the *New York City Building Code*.

6.1.2.3 Add at beginning the following: **Protection of standpipe system**

6.1.2.3.1 Add at end the following:

All parts of the standpipe systems that may be exposed to frost shall be protected from freezing by any one of the following methods:

- (1) The piping shall be frostproofed with insulation having a thermal conductance of 0.1 Btu/hr. per square foot of surface per degree F at a mean temperature of 70 to 75 degrees F. Insulation shall be protected to prevent water infiltration, and when exposed to the weather the insulation shall be covered with a 45 pound roofing felt jacket or equivalent.

(2) Steam or electric tracers may be used in conjunction with the insulation.

(3) Tanks subject to freezing temperatures shall be protected.

6.2.1 Add at end the following: Check valves other than those in siamese and fire pump line shall be provided with an O. S. & Y. or indicating shutoff valve (with indicator readily visible from the floor) that is flanged, mechanically coupled or wafer type and connected to the inlet and outlet of such check valves. The valves on the suction and discharge of the fire pump shall be deemed to comply with this requirement when the discharge valve is placed on the discharge side of the check valve. One of the shutoff valves placed on each side of the tank check valve may be of the remote control type, and when used, shall be on the downstream side of such check valve.

6.2.2 – Add at end the following:

(1) Riser control valves, shall where practical, be located within a required stair enclosure serving the entrance floor. Where the stair enclosure extends to the basement or cellar, the riser control valve may be located within the stair enclosure at or in the basement or cellar ceiling, providing that a sign indicating the valve location is installed within the stair enclosure at the entrance floor. The hose outlet valve for the entrance floor shall be located on the riser side of the riser control valve. Sectional control valves shall be provided at maximum 100 foot increments in all standpipe risers. Riser control valves or sectional valves shall not be required on a vertical line supplying one or two hose outlet valves.

(2) Where riser control or section valves are located outside of a required stair enclosure, the valves shall be of such type and so installed so as to be remotely operated by either electric motors or hydraulic means. The remote control shall be from either the entrance floor or from a fire pump room. Operating devices shall be grouped, suitably housed, and kept locked with a Fire Department lock and key. The door of the housing shall be embossed to indicate the purpose of the device. Instructions for operating the remote valves by the control device shall be legible, detailed, and complete, and shall be permanently secured to the inner face of the door.

(3) Each valve shall be so designed and installed as to permit its manual operation at the valve location. Pressure ratings and the name of the manufacturer shall be cast raised or depressed on each valve used in the system.

(4) The position of each remotely controlled valve, whether opened or closed, shall be indicated at its remote control point and also at the valve.

(5) Valves shall be readily accessible for inspection, repair, and use. If the valve is placed so that its operating mechanism is more than 7 feet above a floor or stair landing, a 12 inch wide wrought iron, steel or equivalent ladder securely fastened shall be provided for access to the valve. In lieu of a ladder, chain operated mechanisms are permissible and shall be padlocked securely in place.

(6) Each control valve shall be conspicuously marked with the number assigned to it on the riser diagram for the standpipe system. Metal numbered tags at least 2 inch in diameter shall be securely attached to the valve. Each valve shall have a metal sign stating “STANDPIPE CONTROL VALVE” securely hung from the valve.

(7) Each control valve not remotely controlled shall be electrically supervised in its normal position. If the normal position is the closed position, a metal placard stating such fact shall be conspicuously attached to the valve.

6.2.4 Add at the end the following: Wafer type control valves may not be used in pump suction piping.

6.2.7 Add at end of item (3) the following: Only permissible when no fire alarm system is present and delete item (4).

6.2.8.3 Add at the end the following: Such sprinkler system piping supply shall only be permitted where approved by the commissioner.

6.3.2 Add at end the following: In addition, each high zone siamese zone shall be provided with a swing-type check valve located at each connection between the high zone siamese express riser and the high zone standpipe system and located at the level of such connection.

6.3.5.2 Delete and replace with the following: **Marking.** Each siamese connection shall be provided with caps painted red, and shall have the word “STANDPIPE” in letters 1 inch high and 1/8 inch deep cast in the body or on a nonferrous metal plate secured to the connection or mounted on the wall in a visible location, except that caps of each siamese connection used for combination standpipe and sprinkler systems shall be painted yellow and the words shall read “COMBINATION STANDPIPE AND SPRINKLER SYSTEMS”. Where Siamese connections serve other than the entire building, the connections shall be marked in accordance with the specifications of this section “LOW ZONE” or “HIGH ZONE” and indicate the floors served.

6.3.5.2.1 Delete.

6.3.6 Delete “1219 mm (48 in.)” and replace with the following: 914 mm (36 in.).

## Chapter 7 – Design

7.1.1 Delete.

7.2 Delete and replace with the following: The maximum pressure at any point in the system at any time shall not exceed 24.1 bar (350 psi), except for piping to high zone Siamese connections, and shall not, in any case, be greater than the pressure rating of the

system components in accordance with section 4.2 of this referenced standard. Maximum height per zone is limited to 300 feet.

7.2.1.1 Change the word “regulating” to “restricting”.

7.2.1.2 Delete.

7.3.2 Delete all after the word “connections” and replace with the following: in accordance with the requirements of Section 905 of the *New York City Building Code*.

7.3.2.1 Delete.

7.3.2.2 Delete and replace with the following: At the top of the highest riser there shall be provided, above the main roof level, a three way manifold equipped with three 2 ½ inch (63.5 mm) hose valves with hose valve caps. The lowest valve shall be located with the hose end at least 18 inch (457 mm) above the roof and the highest valve with the hose end not more than 60 inch (1524 mm) above the roof. The manifold may be set in a horizontal or vertical position, provided the hose outlets are set back between 18 inch (457 mm) and 60 inch (1524 mm) above the roof level. Where the manifold is located other than within a heated stair enclosure, the control valve shall be located in a horizontal run of piping below the roof, with a long stem extending through the roof and equipped with a wheel handle at its upper end at least 12 inch. (304.8 mm) above the roof. Between the control valve and the manifold there shall be provided within the heated space a ½ inch (12.7 mm) open drip or a ¾ inch (19 mm) automatic ball drip, with the drip pipe extended to spill over a plumbing fixture or drain.

7.3.2.3 Delete.

7.3.4.1 Delete all after the word “required”.

7.3.4.1.1 Delete.

7.4 Add at end the following: and shall be provided in accordance with the requirements of Section 905 of the *New York City Building Code*.

7.5 Delete all and replace with the following:

### **Interconnection of Standpipes**

(1) Standpipe systems that include more than one riser shall have all risers cross-connected at, or below, the street entrance floor level, except as otherwise provided in this section.

(2) Standpipe systems in buildings required by the provisions of Section 905 of this code to have one or more zones shall be so designed and installed that the risers supplied from each zone will be cross-connected below, or in, the story of the lowest



hose outlets from the water source in each zone. Horizontal intermediate check valves shall be installed in the run of each riser continuing into a higher zone in such manner as to permit all upper zones of the system within each Siamese zone provided in accordance with 4.8.2.2 to be fed through one riser from the zone below and to prevent any lower zone of the system from being supplied from a zone above, except as otherwise required by this referenced standard. Siamese zones shall be interconnected as in accordance with 4.8.2.2(j).

(3) Risers supplied by an upper level cross connection shall be provided with manual control valves or remote control valves, so arranged that risers supplied by the upper level cross connections may independently be shut off from the tank supplies.

(4) Cross connections shall be at least as large as the largest riser supplied by the cross connection. However, when supplying two, but not more than four 4 inch risers, the cross connection shall not be less than 5 inches. The cross connection shall not be less than 6 inches for all other riser combinations.

(5) Where there is no cellar, cross connections may be hung from the ceiling of the lowest story.

(6) Each siamese connection shall be connected to a riser or to a cross connection connecting other Siamese hose connections or risers within each Siamese zone provided in accordance with section 4.8.2.2. The pipe from the siamese connection to the riser or cross connection shall be five inch I.P.S., except that a 4 inch pipe shall be sufficient when such pipe supplies a single four inch riser system. The pipe from the siamese connection shall be run as directly as practicable to the riser or cross connection.

(7) When tanks are used for the primary water supply, the standpipe systems may use separate riser systems serving, respectively, low and high parts of the building. Separate gravity tanks or pressure tanks may supply each zone, but in every case the standpipe system shall be so designed that every hose outlet of the entire system can be supplied through the required cross connections from every siamese connection within each Siamese zone provided in accordance with section 4.8.2.2.

**7.5.1 Delete.**

**7.5.2 Delete.**

**7.5.2.1 Delete.**

**7.6.1 Delete and replace with the following: Class I and Class III standpipes in buildings with floor heights less than 150 feet (45 720 mm) above grade plane shall be at least 4 inches (100 mm) in size. Standpipes in buildings with floor heights greater than 150 (45 720 mm) feet above grade plane shall be no less than 6 inches (150 mm) in diameter.**

7.6.3 Delete and replace with the following: In fully sprinklered buildings having a combined standpipe system that is hydraulically calculated, the minimum standpipe size in buildings with floor heights less than 150 feet (45 720 mm) above the lowest level of fire department vehicle access shall be 4 inches (100 mm).

7.7.4 Delete the words, “or semiautomatic”.

7.7.4 Delete.

7.8.1.1 Delete “100 psi (6.9 bar) and replace with “65 psi (4.5 bar).

7.8.2 Delete.

7.8.2.1 Delete.

Table 7.8.2.1 Delete .

7.8.2.2 Delete.

7.8.3.1 Change the word “regulating” to “restricting”.

7.8.3.2 Change the word “regulating” to “restricting”.

7.8.3.3 Change the word “regulating” to “restricting”.

7.9.1 Add after the word “pumps” the words “or tanks”. Add after the word “pump” the words “or tank”.

7.9.1.1 Delete and replace with the following: The maximum standpipe system zone height for any building is 91 440 mm (300 feet). In the lowest zone in a building, such height shall be measured from grade plane. Floors below grade plane may be included in the lowest zone, provided that the maximum siamese zone height for the siamese zone that includes the lowest zone, in accordance with 4.8.2.2 (j), is not exceeded.

7.9.3 Delete.

7.9.3.1 Delete.

7.9.3.1.1 Delete.

7.9.4.1 Delete and replace with the following: In buildings with occupied floors less than 91.4 m (300 feet) in height above the lowest level of fire department vehicle access, water supplies may be provided by a public waterworks system in accordance with 9.1.4(1), by automatic fire pumps in accordance with 9.1.4(2), or by gravity tanks in accordance with 9.1.4(4).

Add Section 7.9.4.2 All zones servicing occupied floors located higher than 91.4 m (300 feet) above the lowest level of fire department vehicle access shall be equipped with a primary and auxiliary water supply provided by gravity tanks supplemented by pumps where necessary in accordance with 9.1.4.

Add Section 7.9.4.2.1 All zones servicing occupied floors located higher than 91.4 m (300 feet) above the lowest level of fire department vehicle access but not more than 152.4 m (500 feet) above grade plane, shall be equipped with a special service fire pump, in accordance with 9.1.4(4)(I), to boost supply to pressures as required by 7.8.1.1 and 7.8.3.1. A Pressure Reducing Valve (PRV) by-pass shall be provided, where necessary, and arranged to provide water supply from the upper zone to the lower zone at the required pressures. Where a PRV is not necessary to provide required pressures, a normally open bypass shall be provided.

Add Section 7.9.4.3 Where portions of a standpipe system service floors located 152.4 m (500 feet) or more above the lowest level of fire department vehicle access, all portions of the system shall be provided with a primary and auxiliary means of water supply in accordance with 9.1.4 and the following:

(1) Primary water supplies shall serve one zone only as the primary supply. However, the primary water supply for one zone may be used as the auxiliary supply for no more than one other zone.

(2) Intermediate tanks, which serve as the suction source for the pumps providing primary water supply for zones located higher than 91.4 m (300 feet) above grade plane, shall be located so as to provide the auxiliary water supply for the next lowest zone at the required pressures by gravity only, and such pressures shall not exceed the minimum pressures required in such next lowest zone by more than 15 percent.

(3) The auxiliary water supply for the topmost section of the system zone shall be provided by a gravity tank in accordance with 9.1.4(4) and shall be equipped with a special service fire pump, in accordance with 9.1.4(4)(I), to boost supply to pressures as required by 7.8.1.1 and 7.8.3.1.

(4) Zone heights shall be selected such that the topmost zone has a minimum height of 45.7 m (150 feet) so as to provide an auxiliary water supply from the intermediate or roof tank(s) to the next lowest zone at pressures as required by 7.8.1.1 and 7.8.3.1 by gravity only, and such pressures shall not exceed the minimum pressures required in such next lowest zone by more than 15 percent.

7.12.1 Delete the words “76 mm (3-in.)”. Add after the word “riser” the following: of adequate size. Add after the word “standpipe” the following: or attached sprinkler system.

7.12.1.1 Delete and replace with the following: The riser shall be equipped with a plug and be located on every floor.

7.12.1.2 Delete.

7.13.1.1 Delete.

7.13.2 Add at end the following: and be located in accordance with Section 4.8.2.2 of this referenced standard.

7.13.2.1 Delete.

Chapter 8 – Plans and Calculations No Changes.

Chapter 9 – Water Supplies

9.1.1 Delete the words “and semi-automatic”.

9.1.2 Add at the end the following: Where manual combination standpipe systems are provided in accordance with the provisions of section 5.4.1.1 of this referenced standard an automatic water supply sufficient to provide the required sprinkler system demand shall be provided. Where such supply is provided by an automatic fire pump, the minimum pump capacity shall be as required by the sprinkler system demand in accordance with Section 903 of the *New York City Building Code* and NFPA 13. Where such water supply is provided by pressure or gravity tanks the minimum water supply shall also be as required in accordance with the above.

9.1.3 Delete the words “and semi-automatic”. Delete the words “a secondary” and replace with “an auxiliary”.

9.1.4 Delete and replace with the following:

Water supplies from the following sources shall be permitted:

(1) A public waterworks system where pressure and flow rate are adequate as confirmed by a statement by the Bureau of Water Supply of the Department of Environmental Protection.

(a) Each service directly supplying a standpipe system or a fire pump shall be equipped with a control valve located under the sidewalk in a flush sidewalk box located within two feet of the street line, or in such other locations as may be approved by the Department of Environmental Protection. The purpose of each such control valve shall be clearly indicated by the words. “Standpipe Supply Control,” cast in the cover of such flush sidewalk, box or, in lieu thereof, a metal sign with 1 inch lettering shall be located on the exterior building wall indicating the use and location of the valve.

(2) Automatic fire pumps connected to an approved water source in accordance with NFPA 20, *Standard for the Installation of Stationary Pumps for Fire Protection* and the following:

(a) Any required automatic fire pump shall draw from two independent street water mains in different streets, except that: (1) any automatic fire pump serving a building classified in occupancy group R-2 that is fully protected by a system of automatic sprinklers may draw from a single water main; and (2) an automatic fire pump may draw from a single water main if augmented by a suction tank or tanks, and if the valves at the meter and pump are provided with tamper switches that are wired to an approved central station of an operating fire alarm company. Where two services are installed, one service from the street water main shall be run directly to the pump, and the other service may be used for domestic water supply. The connection from water to the mains to the pumps shall be at least six inch pipe size and shall be flushed before connection is made to the system. Connections shall be in accordance with the provisions of the *New York City Plumbing Code* and applicable referenced standards.

(b) In the event that two separate and distinct water mains are not available as a supply or the street mains cannot produce the required supply, there shall be provided a suction tank, or tanks suitably located and of sufficient capacity to furnish the fire pump with at least a one-half hour supply at the rated capacity of such pump. Suction tanks shall be filled by a six inch connection to the water main, controlled by an automatic ball float valve in the suction tank. A six inch bypass shall be provided so that pumps may be fed directly from the street water main.

(c) When a water service supplies both the domestic service and the fire pump, a remote control valve shall be placed on the domestic service connection at the point where such connection is taken from the city supply or service main. Such remote control valve shall be controlled from a point near the pump control panel. In lieu of a remote control valve, a manually operated valve may be installed to shut off the entire domestic water supply to the building, provided such valve is located in the fire pump room and is properly tagged for identification.

(d) Power supply for standpipe fire pumps. The type of fire pump and prime mover used in a standpipe system shall be suitable for the required service in a standpipe system provided for Fire Department use. If the prime mover employs any form of power other than an electric current supplied by a public utility, the use thereof shall be subject to the approval of the commissioner. Electrical power to the motor shall be taken from the street side of the house service switch. Where an emergency secondary power source is required, fire pumps shall be supplied from such source and power supply shall be automatic switching.

(e) When the fire pump feeder conductors are routed through the building(s), they shall be enclosed by 2 in. of concrete or an approved assembly which has a minimum of 1-hour fire resistive rating.

(f) Fire pumps shall be placed on concrete pads at least 12 in. above the pump room floor with a clearance of at least 3 ft. maintained on all sides from walls or from other equipment in the pump room. In the event of the use of a vertical shaft centrifugal fire pump, the 12 in. high concrete pad may be omitted, provided the bottom of the electric driving motor and all electrical appurtenances are raised at least 12 in. above the pump room floor.

(g) Each automatic fire pump shall be equipped with a 3 in. National Pipe Thread pressure relief valve installed in the pump discharge. Such relief valve shall be set to relieve below the shutoff head of the pump, but above the pressure required to maintain the operating pressure at the highest hose valve. The discharge from the relief valve may be piped back into the suction side of the pump on the pump side of the suction valve provided a visual sight glass is installed in the discharge of the relief valve. Automatic fire pumps may be provided with a time delay switch to insure a minimum running time for the pump.

(h) The check valves in the pump discharge line shall be either swing type or spring loaded.

(i) Where a group of two or more buildings, whether connected or separated, are operated under a single ownership, one fire pump may be accepted as the water supply for the group. The pump shall be installed in the building where the maintenance personnel are located, and a metal sign with 1 inch lettering shall be installed in each building at all of the hose outlets on the entrance floor indicating the location of the fire pump.

(3) Pressure tanks installed in accordance with NFPA 22, *Standard for Water Tanks for Private Fire Protection* and the following:

(a) The water storage quantities required for the tanks are met with an additional volume equivalent to one-half of the required water storage space provided for the required air.

(b) An air compressor is provided with suitable automatic control and of sufficient capacity to build up air pressure of at least 75 psig. in the tank within three hours and to maintain thereafter an air pressure between 70 and 80 psig. The automatic control shall also maintain the proper air-to-water ratio in the pressure tank.

(c) Pressure tanks shall be supplied with water through a fixed pipe, independent of the standpipe riser and at least two inches in size. The water supply and connection shall be capable of supplying the tank at a rate of at least 75 gpm without reducing the pressure in the tank. The tank shall have a fixed

water level plate on the end opposite the gauge glass, or other equivalent indicating device.

(d) All pressure tanks used to provide the required primary water supply of a standpipe system shall be equipped with a high and low air pressure and a high and low water level electrical alarm system. Air-to-water ratio shall be 1 to 2 by volume and may be maintained by automatic electrical controls.

(4) Gravity tanks installed in accordance with NFPA 22, *Standard for Water Tanks for Private Fire Protection* and the following:

(a) Construction and support of tanks. Tanks for the standpipe system supply shall be constructed and supported in accordance with the provisions of Referenced Standard NFPA 22 and applicable provisions of the *New York City Building Code* for loads and structural work. Tanks with a total capacity of 15,000 gallons or greater shall be multi-compartment type such that no compartment is larger than one half of the required standpipe water supply reserve plus the domestic water reserve in combination tanks. In the alternative, multiple tanks may be provided, provided that the above criteria are met.

(b) Combination tanks. Gravity tanks may be used to provide the required primary water supply to the standpipe system and may also be used to supply automatic sprinkler and/or domestic water in a building provided all the following conditions are met:

(1) The connections to the tank are made in such a manner as to provide the required sprinkler and/or fire standpipe reserve. The domestic supply is above the sprinkler and/or standpipe reserve. Where a standpipe riser is used to supply water to a combination sprinkler and standpipe system as permitted, the connection to the tank shall be made in such a manner as to provide the required sprinkler or standpipe reserve, whichever is greater.

(2) The connections to the system are made outside of the tank. When connections or piping are installed inside the tank, the piping shall be assembled without couplings and shall be of red brass or approved equivalent material in accordance with the *New York City Plumbing Code* and applicable referenced standards.

(3) The tank is filled by means of an automatic pump at a rate of not less than 65 gpm.

(c) Filling of tanks.

(1) Pressure or gravity tanks shall be filled at the rate of at least 65 gpm. Pipes used to fill the tanks shall not be used for any other purpose; nor shall required fire pumps be used for filling purposes.

(2) Where there is sufficient pressure in the city water main to fill tanks at the required rate during all hours of each day, and a filling pump is not provided, the connection to the city water supply shall be made near the point where the city water service enters the building.

(3) A combined fire standpipe reserve and domestic water tank shall only be filled by direct public water connection or separate fill pumps, or direct connection to equipment, or pumps used to supply domestic water systems in accordance with the *New York City Plumbing Code* and applicable referenced standards.

(d) Emergency Drains on standpipe tanks. Each standpipe tank shall be provided with a drain of at least 4 in. National Pipe Thread. Each drain pipe shall be controlled by a manually operated gate valve located so as to be readily accessible. The drain shall be installed in accordance with the *New York City Plumbing Code* and applicable referenced standards.

(e) Heating of standpipe tanks.

(1) Where the water in the tank is subject to freezing, the tank shall be equipped with a tank heater in accordance with the provisions of NFPA 22.

(2) Where the standpipe supply and domestic water supply are combined in a single tank, heating of such tank shall not be required in hotels, multiple dwellings, hospitals, or other occupancies where the domestic supply is drawn upon during all hours of every day of the week.

(f) Strainer.

(1) Every standpipe gravity or suction tank shall be provided with a brass or bronze strainer at the discharge to risers or to pump supply lines.

(2) Each strainer shall have clear openings with an aggregate area equal to, or more than, the required area of the pipe into which the tank discharges. Openings shall be not more than 1 in. nor less than ½ in. in diameter.

(g) Overflow pipe for standpipe tanks. Each gravity standpipe tank shall be provided with an overflow in accordance with the *New York City Plumbing Code* and applicable referenced standards.

(h) Access to standpipe tanks. Access to the top of each gravity tank shall be by means of a steel, wrought iron or approved equivalent material gooseneck ladder, constructed of flat side bars at least 2 in. by ¾ in, or equivalent, spaced at least 14 in. apart, with round or square rungs at least 5/8 in. thick spaced not more than 12 in. on centers. The ladder shall be rigidly braced and shall not tip outward from



the vertical at any point. When ladders exceed 25 ft. in height, body irons spaced not more than 2 ft. on center and a metal platform at least 14 in. square, rigidly secured to the stringers of the ladder or other type of enclosed safe access, shall be provided near the top of the tank.

(i) Gravity tanks shall be equipped with a high and low water level electrical alarm system.

(j) Where a group of two or more buildings, connected or separated, is operated under a single control, a single gravity tank may be accepted as the primary water supply for the several standpipe systems of such group, provided a dead riser is carried from the bottom of the tank to an underground header or cross connection system and provided each building unit has a post indicator type control valve outside or an o.s. and y. control valve inside the building at a readily accessible location. The underground cross connection may not cross any public street without the approval of the city departments having jurisdiction.

(k) The bottom of the topmost zone gravity tanks shall be located above the highest hose outlet in the zone that such tank supplies, excepting the roof manifold and those hose outlets in a penthouse enclosing mechanical equipment. Pressures may be boosted by use of automatic special service or other fire pump(s) to provide the hose outlet pressures required by section 7.8.1.1 of this referenced standard. Tanks in intermediate zones may be sufficiently elevated to provide the pressures required by section 7.8.1.1 provided that they are also installed in accordance with sections 7.9.4.2 and 7.9.4.3.

(l) The special service pump, as required by this standard, may be located anywhere in the zone served, provided that an express piped suction supply is installed from the gravity tank(s) that supply such pump, and such pump is located at a lower elevation than the gravity tank. Special service pumps are to be installed in accordance with the requirements of sections 9.1.4 (2) - (d), (e), (f) and (h).

**9.2 Add at end the following: except where manual standpipe systems are permitted in accordance with section 5.4.1.2, water supplies shall be provided in accordance with section 9.1.3 of this referenced standard.**

**Add Section 9.4 Minimum Supply for Group R-2 Occupancies. The water supply servicing standpipe systems in Group R-2 occupancies shall not be less than 500 gpm, and the minimum stored water supply in any gravity tank or intermediate tank shall not be less than 15,000 gallons per zone.**

**Chapter 10 – Water Supply Testing No Changes**

**Chapter 11 – System Acceptance**

11.5.6 Delete.

11.5.6.1 Delete.

11.5.6.2 Delete.

## **Chapter 12 – Buildings Under Construction**

12.1 Delete the words “Where required by the authority having jurisdiction”. Add at the end “or demolition. Provision shall be made for the use of such standpipe by the Fire Department when the height of building construction or demolition exceeds 75 feet.”

12.2 Delete and replace with the following: The standpipe shall be provided with a readily accessible siamese Fire Department connection at street level. The location of the siamese hose connection shall be placarded, kept free from obstruction, and identified by a red light.

12.3 Add the following:

Temporary risers shall be at least 4 inches in diameter for structures less than 450 feet high and at least 6 inches in diameter for structures 450 feet high or more. There shall be as many risers as will be, or were, required for the permanent system. Each such riser shall be connected to a cross connection that is supplied through siamese hose connections at the street level, and shall be equipped on each floor with a 2 and one-half inch hose outlet valve. The installations shall be made so that each riser, cross connection, and branch line can be plugged or capped when work is not being done on the system.

12.8 Delete.

12.8.1 Delete.

12.8.2 Delete.

## **ANNEXES**

**The Annexes are not a part of the requirements of this Referenced Standard but are included for informational purposes only. This annex contains explanatory material, numbered to correspond with the applicable text paragraphs. In the event of any conflict between the Annexes and the body of the Referenced Standard, particularly where modifications have been made for New York City, the body of the Referenced Standard will govern.**

### **Annex A - Explanatory Material**

**Delete Figures A.7.1(b) and A7.1(c).**

A.7.3.2 Delete.

A.7.3.2.1 Delete.

A.7.3.2.2 Delete.

A.7.3.2.3 Delete.

Delete Figures A.7.3.2(a), (b) and (c).

Annex B - Informational References No Changes

**SECTION BC Q106**  
**INSTALLATION AND MAINTENANCE OF FIRE ALARM SYSTEMS**

Q106.1 General. Fire alarm system installation, testing, and maintenance, where required by this code, shall be conducted and documented in accordance with NFPA 72, National Fire Alarm Code, 2002 edition, modified for New York City as follows:

2.1 Add at the end the following: Where a referenced publication has been modified for the City of New York by the *New York City Building Code* and the *New York City Fire Code*, every reference to such publication shall be deemed to include all such modifications.

4.3.2.1 Add after the words “who are” the following: “New York State registered Professional Engineers and”.

4.3.3 Add: “Fire alarm installations shall be performed by a New York City licensed electrical contractor.” to the beginning of the first sentence.

4.4.1.2 Delete “NFPA 70, National Electrical Code” and replace with the following: *New York City Electrical Code*.

4.4.1.3 Delete and replace with the following: **Power Supply Sources.** Refer to the *New York City Electrical Code* for requirements.

4.4.1.3.1 Delete.

4.4.1.3.2 Delete.

4.4.1.4.1 Delete and replace with the following: See *New York City Electrical Code* for requirements.

4.4.1.4.2.2 Delete the words “FIRE ALARM CIRCUIT” and replace with the following: “FIRE ALARM DISCONNECT” followed by lettering indicating specific fire alarm system served by floor, zone, or other acceptable nomenclature.”

4.4.1.5.1 Delete and replace with the following: See *New York City Electrical Code* for requirements.

4.4.1.5.3 Delete and replace with the following: See *New York City Electrical Code* for requirements.

4.4.1.6.3 Delete (A) and (B).

4.4.4.4 Delete and replace with the following: See *New York City Electrical Code* for requirements.

5.5.2.2 Delete the word “tenantless”.

5.6 Delete the words “other NFPA codes and standards or by the authority having jurisdictions” and replace with the following: the *New York City Building Code* and the *New York City Fire Code*.

5.12.4 Replace: “1.37 m (4 ½ feet)” with “1.22 m (4 feet)”.

5.14.4.2.1 Delete the words “other NFPA standards” and replace with the following: the *New York City Building Code*.

6.2.3.2 Delete the words “agency having jurisdiction” and replace with the following: *New York City Building Code* and the *New York City Fire Code*.

6.8.5.1.2 Delete Exception.

6.9.4.6 Delete Exception.

6.9.5.1 Replace: “agency having jurisdiction” with “Fire Commissioner”. Delete exceptions No. 1 and No. 2.

6.9.5.2 Delete the words: “If required by the agency having jurisdiction”.

6.9.5.3 Delete.

6.9.5.4 Delete.

6.9.5.5 Delete.

6.9.5.6 Delete.

6.9.5.7 Delete the words: “If provided”.

6.9.5.8 Delete.

6.9.6.1 Delete the words “a building entrance” and replace with the following: the building entrance lobby. Delete the words “authority having jurisdiction” and replace with the following: Fire Department.

6.9.7.3 Delete the words “Where required”.

6.9.9.9 Delete the words “or jack” in both places used.

6.9.9.10 Delete “or jack”.

6.9.9.12 Delete “or jacks” in each use thereof. Delete the words: “if approved by the authority having jurisdiction,”.

6.9.9.13 Delete “or telephone jack”.

6.9.9.14 Delete.

6.13 Delete.

6.13.1 Delete.

6.13.2 Delete.

6.13.3 Delete.

6.13.4 Delete.

6.13.5 Delete.

6.15.2.6 Delete the words “NFPA 70, National Electrical Code, Article 760” and replace with the following: *New York City Electrical Code*.

6.15.3.3 Delete the words “authority having jurisdiction” and replace with the following: Fire Department and add the words “, sprinkler water-flow devices” following “detectors”.

6.15.3.4 Add the words “, sprinkler water-flow device” following “ detectors”.

6.15.3.9 Delete the last sentence and replace with the following: Actuation of these detectors shall be required to actuate the system notification appliances. Delete the Exception.

6.15.3.10 Delete and replace with the following: For each group of elevators within a building, a minimum of three separate elevator control circuits shall be terminated at the designated elevator controller within the group's elevator machine room(s). The operation of the elevators shall be in accordance with the *New York City Building Code*. The smoke detectors or other automatic fire detection as permitted by 6.15.3.7 shall actuate the elevator control circuits.

6.15.4.2 Add new text after the first sentence and before "Alternatively," to read as follows: Upon activation of the heat detector used for elevator power shutdown, there shall be a delay in the activation of power shunt trip. This delay shall be the time it takes the elevator cab to travel from the top of the hoist-way to the lowest recall level.

6.15.4.3 Delete and replace with the following: Pressure or water-flow switches shall not be used to shut down elevator power.

6.15.5.3 Delete and reserve.

Add new Section 6.15.5.3.1 to read as follows:

Connections between fire alarm systems and the HVAC systems for the purpose of monitoring and control shall be arranged such that primary control (the control that all other controls are secondary or subservient to) capability rests with the fire alarm control unit(s) under all circumstances and in addition shall operate and be monitored in accordance with the *New York City Building Code*.

**Exception:** Primary control of HVAC systems may rest with approved smoke control systems.

Add new Section 6.15.5.3.2 to read as follows:

Those HVAC fans or fan systems which have been automatically shut down by the activation of any fire alarm control unit or device shall be arranged and equipped not to automatically restart when the fire alarm control unit or device is resent. At least two manual means of restarting the fans or fan systems shall be required, such as manually resetting the fire alarm control unit or device and subsequently manually resetting the fan or fan system controls.

Add new Section 6.15.5.3.3 to read as follows:

Fans or fan systems that were automatically shut down by the fire alarm control unit or device in High Rise fire alarm systems shall be manually enabled to start by means of overriding the fan shut down through the use of a city wide standard key switch (#2642) located at the Fire Command Center and/or Fire Fighters' Smoke Control Station. The actual start of the fans shall be accomplished manually through HVAC controls at the Fire Command Center, Fire Fighters' Smoke Control Station and locally at the fan rooms.

Add new Section 6.15.5.3.4 to read as follows:

Smoke Exhaust control means shall be enabled through the use of a city wide standard key (#2642) located at the Fire Command Center, Fire Fighters' Smoke Control Station, fire alarm control unit or, in the entrance lobby of the building adjacent to the fire alarm remote annunciator, when provided.

6.15.6.2 Delete the Exception.

6.15.7.2 In the Exception, delete the words "authority having jurisdiction or other codes" and replace with the following: *New York City Building Code*.

Chapter 10: Delete all of Chapter 10, except 10.1.1 with modifications.

10.1.1 Delete "their initiating devices, and notification, appliances shall comply with the requirements of this chapter" and add at the end of the sentence "shall comply with the *New York City Fire Code*".

11.1.2: Delete.

11.1.5 Delete.

11.5 Delete and replace with the following: **Detection and Notification.** Smoke Alarm detection and notification requirements shall be in accordance with Section 907 of the *New York City Building Code*.

11.5.1 through 11.5.12: Delete all sections and subsections.

11.8.5 Delete the words: "NFPA 70, National Electrical Code, Article 760" and replace with the following: *New York City Building Code* and the *New York City Electrical Code*.

**APPENDIX R**  
**ACOUSTICAL TILE AND LAY-IN PANEL CEILING SUSPENSION SYSTEMS**

**SECTION BC R101**  
**GENERAL**

**R101.1 General.** Where required by Section 803.9 of this code, the provisions of ASTM C635 and ASTM C636, as modified by this appendix, shall govern the design and installation of ceiling suspension systems used to support acoustical tiles, or acoustical lay-in panels weighing less than four pounds per square foot (191.5 Pa), not contributing to the fire-resistance rating of a floor or roof assembly and not used for meeting the noise control requirements of the building code.

**SECTION BC R102**  
**MODIFICATIONS TO ASTM C635 – STANDARD SPECIFICATION FOR THE**  
**MANUFACTURE, PERFORMANCE, AND TESTING OF METAL SUSPENSION**  
**SYSTEMS FOR ACOUSTICAL TILE AND LAY-IN PANEL CEILINGS.**

**R102.1 ASTM C635, Figure 1.** Delete Figure 1 and replace as follows:

**FIGURE 1A**  
**INDIRECT HUNG SUSPENSION SYSTEM**  
**(Figure 1A attached to end of document)**

**FIGURE 1B**  
**INDIRECT HUNG SUSPENSION SYSTEM**  
**(Figure 1B attached to end of document)**

**FIGURE 1C**  
**FURRING BAR SUSPENSION SYSTEM**  
**(Figure 1C attached to end of document)**

**R102.2 ASTM C635, Section 3.1.** Modify section 3.1 as follows:

3.1.1.4 carrying channel – The term “carrying channel” shall mean the three sided or “[“ shaped metal sections that support the entire structural grid network (Figure 1A, 1B, and 1C). The carrying channels are suspended by hangers from the existing structure and main runners are then attached to the channels.

3.1.1.6 cross runner – The term “cross runner” shall mean the secondary or cross beams of a mechanical ceiling suspension (Figure 1A). The cross runners normally support only the acoustical tile. In some forms of suspension systems, the cross runners also provide support for other cross runners.



3.1.1.7 hanger – The term “hanger” shall mean the member employed to suspend the acoustical ceiling from the existing structure (wood joists, steel bar joists, steel beams, concrete slabs, etc.) (Figure 1A, 1B, and 1C).

3.1.1.10 main runner – The term “main runner” shall mean the primary or main beams of the type of ceiling suspension system in Figure 1A, and Figure 1B. The main runners provide direct support for cross runners, and they may support lighting fixtures and air diffusers. In addition, the acoustical tile may also be directly supported by the main runners. The main runners are installed perpendicular to the carrying channels and are supported by specially designed sheet metal or wire clips attached to the carrying channels (Figure 1A, 1B)

**R102.3 ASTM C635, Section 4.5.** Add section 4.5 as follows:

4.5 Splines shall not be considered as providing nor shall be used for providing structural support for the ceiling material.

**SECTION BC R103**  
**MODIFICATIONS TO ASTM C636 – STANDARD PRACTICE FOR**  
**INSTALLATION OF METAL CEILING SUSPENSION SYSTEMS FOR**  
**ACOUSTICAL TILE AND LAY-IN PANELS.**

**R103.1 ASTM C636, Section 2.1.3.** Delete Section 2.1.3 and replace as follows:

2.1.3 Hangers shall be spaced a maximum of 4'-6" (1372 mm) on center. Each hanger shall be capable of supporting the suspended load in accordance with the provisions of this code. If local situations require greater center distances between hangers, the load-carrying capacity of the ceiling suspension system shall be reduced commensurate with the actual center-to-center hanger distances used.

**R103.2 ASTM C636, Section 2.1.4.** Delete Section 2.1.4 and replace as follows:

2.1.4 Hangers shall be designed to support the suspended loads and shall be a minimum ¼" (6.4 mm) diameter galvanized steel rods or 1" x ⅛" thick (25 mm x 3.2 mm) flat steel bars. The use of steel wire as a hanger shall not be permitted.

**R103.3 ASTM C636, Figure 1.** Delete Figure 1 and replace as follows:

**FIGURE 1A**  
**HANGER CONNECTION DETAILS FOR CONSTRUCTION GROUPS I AND II**  
**(Figure 1A attached to end of document)**

**FIGURE 1B**  
**HANGER CONNECTION DETAILS FOR CONSTRUCTION GROUPS I AND II**  
**(Figure 1B attached to end of document)**

**R103.4 ASTM C636, Section 2.1.5.** Delete Section 2.1.5 and replace as follows:

2.1.5 Each connection of a hanger to a structural member of the building shall be in accordance with Sections 2.1.5.1 or 2.1.5.2 as applicable.

2.1.5.1 Construction types I and II. In buildings of Types I and II construction, hangers shall be attached to the structure of the building in accordance with the applicable structural systems indicated in Figures 1A and 1B.

2.1.5.2 Construction types III, IV, and V. Every other hanger supported from wood structural members of the building shall be attached by two ¼" (6.4 mm) diameter through bolts or clinched nails. However, every other hanger shall be permitted to be attached by two ¼" (6.4 mm) diameter barbed anchor nails 2 ¼" (57 mm) long with oval heads. All bolts and nails shall be inserted at least 2 inches above the bottom of the wood members.

**R103.5 ASTM C636, Section 2.1.6.** Delete Section 2.1.6 and replace as follows:

2.1.6 Existing hangers shall not be used unless they comply, or are made to comply, with all of the provisions of this code relating to hangers.

**R103.6 ASTM C636, Section 2.1.7.** Delete Section 2.1.7 and replace as follows:

2.1.7 Carrying channels shall be attached to hangers in a manner that will prevent any vertical movement or rotation. If hangers are secured to special attachment devices that support the carrying channels, such devices shall have certified load test data from an approved testing agency and shall be capable of carrying four times the design load.

**R103.7 ASTM C636, Section 2.2.3.** Delete Section 2.2.3 and replace as follows:

2.2.3 Local kinks or bends shall not be made in hangers as a means of leveling the carrying channels.

**R103.8 ASTM C636, Section 2.2.4.** Delete Section 2.2.4 and replace as follows:

2.2.4 Carrying channels shall be designed to support the suspended loads, and shall be a minimum 1-1/2" deep (38 mm) cold-rolled steel channel weighing 0.457 pounds per linear foot (0.707 kg/m) and shall be given an electro-galvanized, hot-dipped galvanized cadmium coating, or zinc coating.

**R103.9 ASTM C636, Section 2.3.1.** Delete Section 2.3.1 and replace as follows:

2.3.1 Main runners shall be installed such that they are level within 1/8 inch vertical in 12 feet horizontal when the main runner is in firm contact with the carrying channel.

**R103.10 ASTM C636, Section 2.3.2.** Delete Section 2.3.2 and replace as follows:

2.3.2 Main runners shall be supported from the carrying channels. Direct hung suspension systems where the main runners are supported directly to the existing structure shall not be permitted. Indirect hung or furring bar suspension systems designed and installed in accordance with this code and utilizing carrying channels shall be permitted.

**R103.11 ASTM C636, Section 2.3.3.** Delete Section 2.3.3 and replace as follows:

2.3.3 Main runners shall be attached to the carrying channels in a manner that will prevent any vertical movement or rotation.

**R103.12 ASTM C636, Section 2.3.4.** Delete Section 2.3.4 and Figure 2 and replace as follows:

2.3.4 If the main runners are supported from the carrying channels by special devices, such devices shall be capable of carrying four times the design load. The devices shall be load tested by an approved testing agency that shall certify the devices are in compliance with this code. Such certifications shall be made available to the department and the applicant of record upon request.

**R103.13 ASTM C636, Section 2.7.2.** Modify Section 2.7.2 to read as follows:

2.7.2 Fixtures shall not be supported from main runners if the weight of the fixture causes the total dead load to exceed the deflection capability of the ceiling suspension system. Fixtures exceeding 80 lbs. (36 kg) in weight shall be supported independent of the ceiling suspension system. Fixtures weighing 80 lbs. (36 kg) or less may be supported from the carrying channels. Fixtures weighing 50 lbs. (23 kg) or less may be supported from the main runners. Cross runners shall not be used to support fixtures.

**R103.14 ASTM C636, Section 2.7.5.** Add Section 2.7.5 to read as follows:

2.7.5 The construction documents shall show the necessary details of the acoustical ceiling to identify the number, size, spacing, location, weights, and types of fixtures and means employed to comply with these requirements.

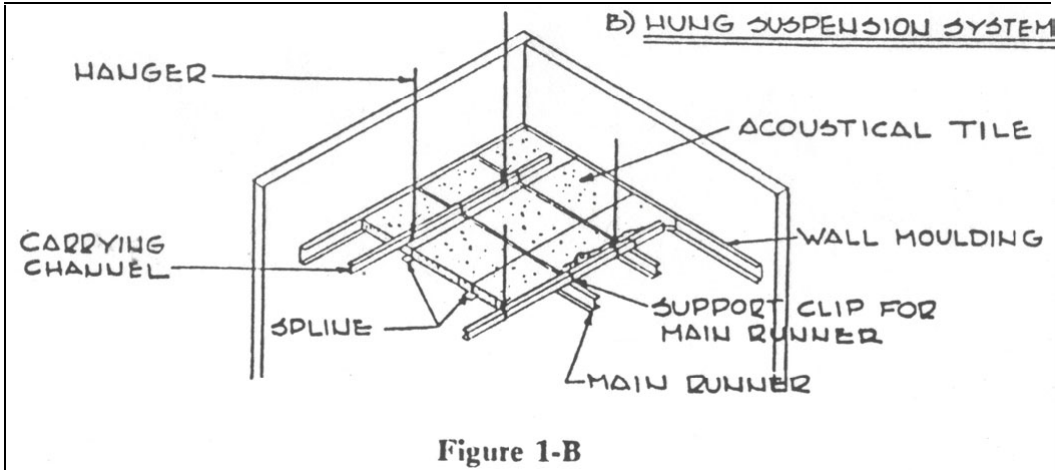
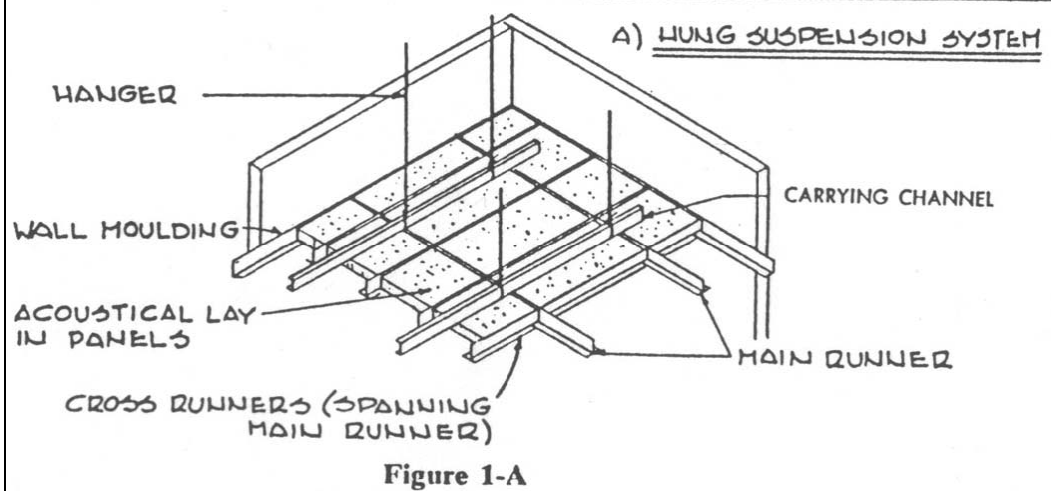
**FIGURE 1A – INDIRECT HUNG SUSPENSION SYSTEM**

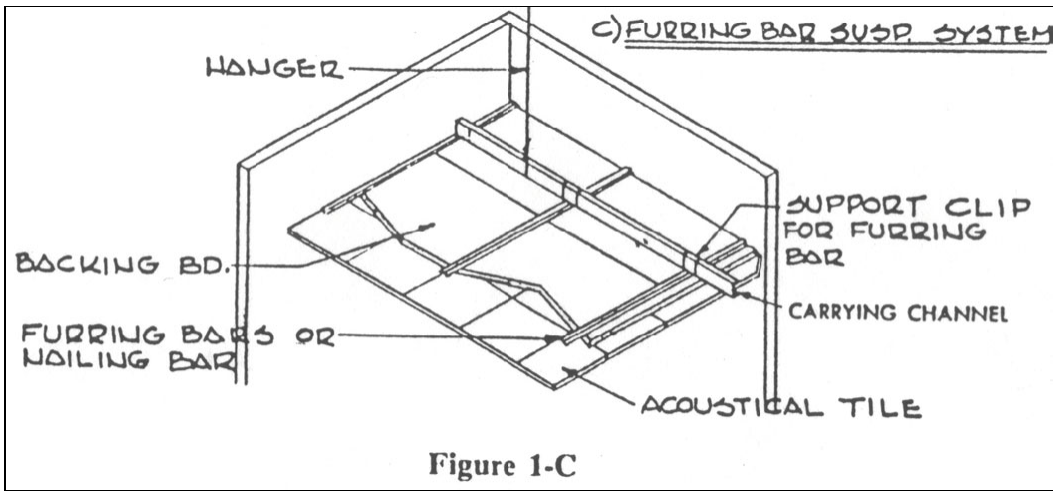
**FIGURE 1B – INDIRECT HUNG SUSPENSION SYSTEM**

**FIGURE 1C – FURRING BAR SUSPENSION SYSTEM**

**{NOTE: DELETE THE WORDS “REFERENCE STANDARD RS 5-16” BELOW}**

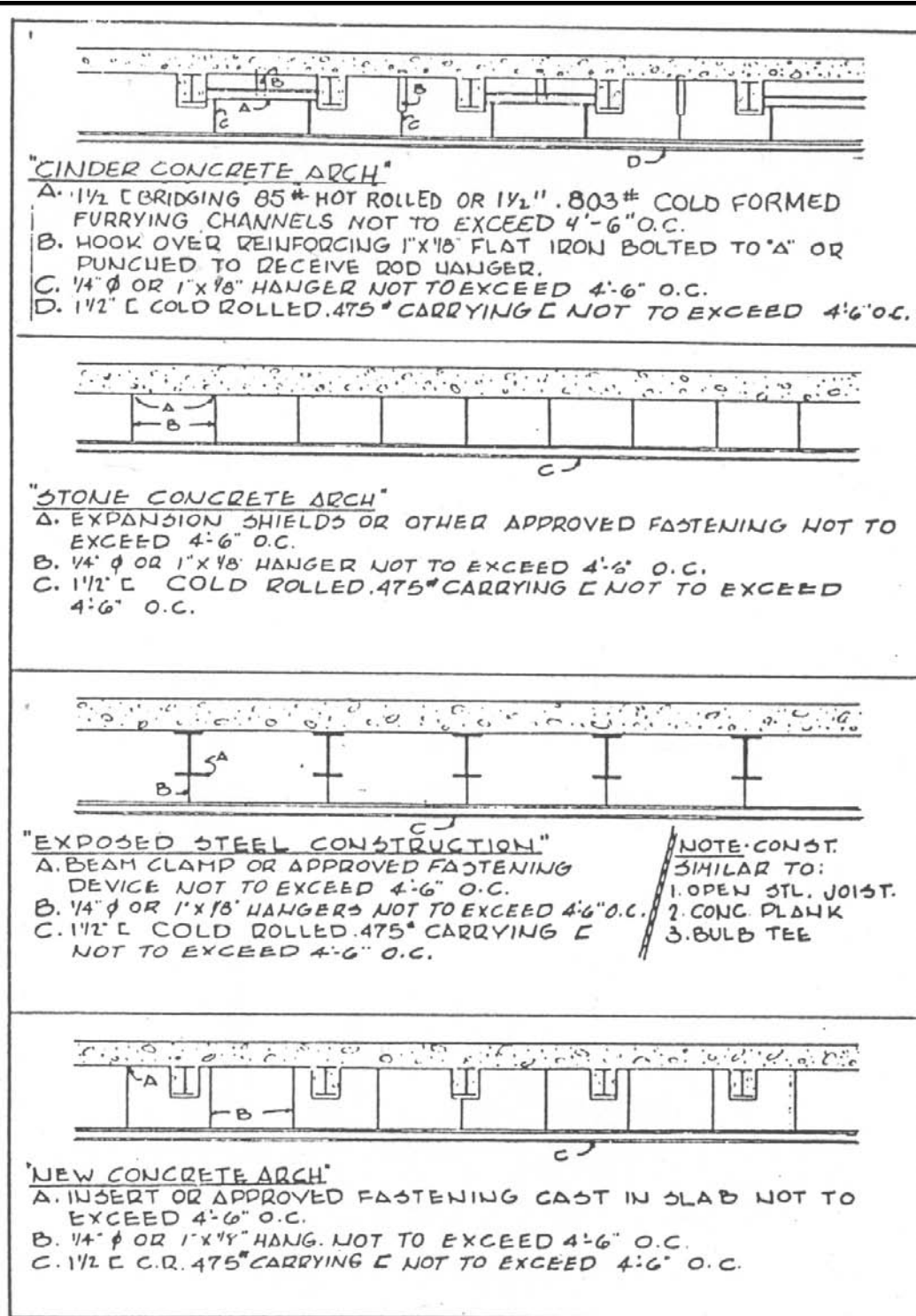
**\*REFERENCE STANDARD RS 5-16  
Acoustical Tile and Lay-in Panel Ceiling Suspension Systems**





**FIGURE 1A – HANGER CONNECTION DETAILS FOR CONSTRUCTION  
GROUPS I AND II**

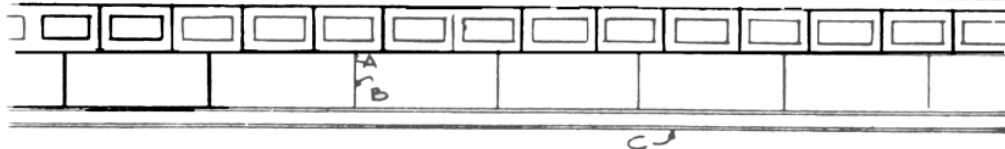
**{NOTE: DELETE THE WORDS “FIGURE 2-A” BELOW}**



\*Figure 2-A

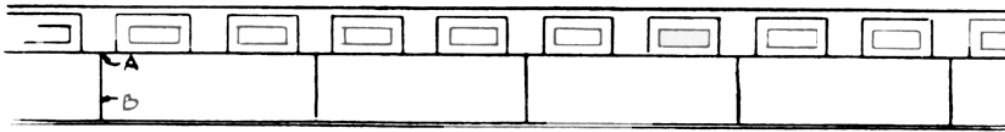
**FIGURE 1B – HANGER CONNECTION DETAILS FOR CONSTRUCTION GROUPS I AND II**

**{NOTE: DELETE THE WORDS "FIGURE 2-B" BELOW}**



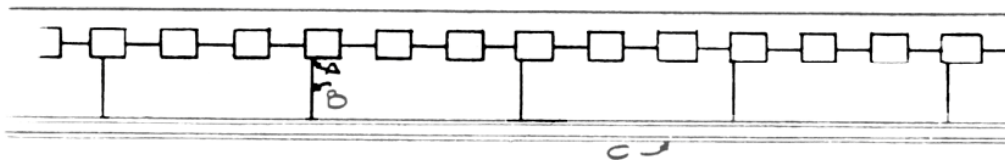
"TERRA COTTA ARCH"

- A. T.C. INSERT 4'-0" X 3'-0" O.C.
- B. 1/4"  $\phi$  OR 1" X 1/8" HANGERS 4'-0" X 3'-0" O.C.
- C. 1 1/2" E COLD ROLLED .475# CARRYING C NOT TO EXCEED 4'-0" O.C.



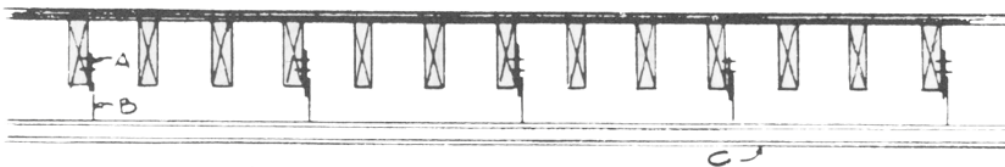
"REPUBLIC ARCH"

- A. EXPANSION SHIELDS OR OTHER FASTENING NOT TO EXCEED 4'-6" O.C.
- B. 1/4"  $\phi$  OR 1" X 1/8" HANGERS NOT TO EXCEED 4'-6" O.C.
- C. 1 1/2" E COLD ROLLED .475# CARRYING C NOT TO EXCEED 4'-6" O.C.



"METAL DECK"

- A. SLOT, TAB OR OTHER APPROVED FASTENING NOT TO EXCEED 4'-6" O.C.
- B. 1/4"  $\phi$  OR 1" X 1/8" HANGERS NOT TO EXCEED 4'-6" O.C.
- C. 1 1/2" E COLD ROLLED .475# CARRYING C NOT TO EXCEED 4'-6" O.C.



"WOOD JOIST CONSTRUCTION"

- A. A" X 1/8" STRAP SECURED TO WOOD JOIST W/TWO (2) 2" ANCHOR NAILS NOT TO EXCEED 4'-6" O.C.
- B. 1/4" OR 1" X 1/8" HANGERS NOT TO EXCEED 4'-6" O.C.
- C. 1 1/2" [ COLD ROLLED 475# CARRYING ] NOT TO EXCEED 4'-6" O.C.

\*353-72-BCR

\*Figure 2-B



# THE NEW YORK CITY MECHANICAL CODE

## CHAPTER 1 ADMINISTRATION

### SECTION MC 101 GENERAL

**101.1 Title.** This code shall be known and may be cited as the “New York City Mechanical Code,” “NYCMC” or “MC”. All section numbers in this code shall be deemed to be preceded by the designation “MC”.

**101.2 Scope.** This code shall regulate the design, installation, maintenance, alteration and inspection of mechanical systems that are permanently installed and utilized to provide control of environmental conditions and related processes within buildings. This code shall also regulate those mechanical systems, system components, equipment and appliances specifically addressed herein. The installation of fuel gas distribution piping and equipment, fuel gas-fired appliances and fuel gas-fired appliance venting systems shall be regulated by the *New York City Fuel Gas Code*.

**101.3 Intent.** The purpose of this code is to provide minimum standards to safeguard life or limb, health, property and public welfare by regulating and controlling the design, construction, installation, quality of materials, location, operation and maintenance or use of mechanical systems.

**101.4 Severability.** If a section, subsection, sentence, clause or phrase of this code is, for any reason, held to be unconstitutional, such decision shall not affect the validity of the remaining portions of this code.

### SECTION MC 102 APPLICABILITY

**102.1 General.** The provisions of this code shall apply to all matters affecting or relating to structures and premises, as set forth in Section 101. Where, in a specific case, different sections of this code specify different materials, methods of construction or other requirements, the most restrictive shall govern.

**102.2 Existing installations.** Except as otherwise provided for in this chapter or elsewhere in this code, a provision in this code shall not require the removal, alteration or abandonment of, nor prevent the continued utilization and maintenance of, a mechanical system lawfully in existence on the effective date of this code.

**102.3 Maintenance.** Mechanical systems, both existing and new, and parts thereof shall be maintained in proper operating condition in accordance with the original design and in a safe and sanitary condition. Devices or safeguards that are required by this code shall be maintained in compliance with the applicable provisions under which they were installed. The owner shall be

responsible for maintenance of mechanical systems. To determine compliance with this provision, the commissioner shall have the authority to require existing mechanical systems to be inspected.

**102.4 Additions, alterations or repairs.** Additions, alterations, renovations or repairs to a mechanical system shall conform to requirements for a new mechanical system without requiring the existing mechanical system to comply with all of the requirements of this code. Additions, alterations or repairs shall not cause an existing mechanical system to become unsafe, hazardous or overloaded. Minor additions, alterations, renovations and repairs to existing mechanical systems shall meet the provisions for new construction, unless such work is done in the same manner and arrangement as was in the existing system, is not hazardous and is approved.

**102.5 Change in occupancy.** Refer to Chapter 1 of Title 28 of the *Administrative Code*.

**102.6 Reserved.**

**102.7 Reserved.**

**102.8 Referenced standards.** The standards referenced herein shall be those that are listed in Chapter 15 and in the rules of the department and such standards shall be considered as part of the requirements of this code to the prescribed extent of each such reference. Where differences occur between provisions of this code and the referenced standards, the provisions of this code shall apply. Refer to Article 103 of Chapter 1 of Title 28 of the *Administrative Code* for additional provisions relating to referenced standards.

**102.9 Requirements not covered by this code.** Requirements necessary for the strength, stability or proper operation of an existing or proposed mechanical system, or for the public safety, health and general welfare, not specifically covered by this code, shall be determined by the commissioner.

### **SECTION MC 103** **DEPARTMENT OF BUILDINGS**

**103.1 General.** Refer to the New York City Charter and Chapter 1 of Title 28 of the *Administrative Code*.

### **SECTION MC 104** **DUTIES AND POWERS OF THE COMMISSIONER OF BUILDINGS**

**104.1 General.** The commissioner shall have the authority to render interpretations and to adopt rules establishing policies, and procedures to clarify and implement the provisions of this code. Such interpretations and rules shall be in compliance with the intent and purpose of this code. Refer to the New York City Charter and Chapter 1 of Title 28 of the *Administrative Code* for additional provisions relating to the authority of the Commissioner of Buildings.

### **SECTION MC 105**

## **PERMITS**

**105.1 General.** Permits shall comply with this section, with Article 105 of Chapter 1 of Title 28 of the *Administrative Code*, and with requirements found elsewhere in this code.

**105.2 Required.** Any owner or authorized agent who intends to construct, add to, alter, repair, move, demolish, or change the occupancy of a building or structure, or to erect, install, add to, alter, repair, remove, convert or replace any gas, mechanical or plumbing system, the installation of which is regulated by this code, or to cause any such work to be done, shall first make application for construction document approval in accordance with Chapter 1 of Title 28 of the *Administrative Code* and this chapter and obtain the required permit.

**105.3 Work exempt from permit.** Exemptions from permit requirements of this code as authorized in Chapter 1 of Title 28 of the *Administrative Code* and the rules of the department shall not be deemed to grant authorization for any work to be done in any manner in violation of the provisions of this code or any other laws or rules.

**105.4 Validity of permit.** The issuance or granting of a permit shall not be construed to be a permit for, or an approval of, any violation of any of the provisions of this code or of any other law. Permits presuming to give authority to violate or cancel the provisions of this code or other law shall not be valid. The issuance of a permit based on construction documents and other data shall not prevent the commissioner from requiring the correction of errors in the construction documents and other data. The commissioner is also authorized to prevent occupancy or use of a structure where in violation of this code or of any other law.

## **SECTION MC 106** **CONSTRUCTION DOCUMENTS**

**106.1 General.** Construction documents shall comply with Article 104 of Chapter 1 of title 28 of the *Administrative Code* and other applicable provisions of this code and its referenced standards. Such construction documents shall be coordinated with architectural, structural and means of egress plans.

**106.2 Required documents.** The applicant shall submit all of the documents specified in Sections 106.3 through 106.10 as appropriate to the nature and extent of the work proposed. Construction documents shall indicate the heating, ventilation, refrigeration, and other mechanical work to be performed, so drawn as to conform to the architectural and structural aspects of the building and to show in detail compliance with this code.

**106.2.1 Composite plans.** Composite plans showing compliance of architectural, structural, and mechanical parts of a building may be submitted provided that a clear understanding of each part is not impaired.

**106.3 Lot diagram.** The lot diagram shall be provided where applicable to the work proposed, including but not limited to the installation of exterior or rooftop equipment.

**106.4 Building classification statement.** Where applicable to the proposed work, the statement shall identify:

1. The occupancy group or groups that apply to parts of the building in accordance with Section 302 of the *New York City Building Code*;
2. The occupancy group of the main use or dominant occupancy of the building in accordance with Section 302.1 of the *New York City Building Code*;
3. The construction class of the building in accordance with Section 602 of the *New York City Building Code*;
4. The structure category in accordance with Table 1604.5 of the *New York City Building Code*;
5. The height of the building as defined in Section 502.1 of the *New York City Building Code*;
6. The applicable measurements to the highest and lowest level of fire department access; and
7. Whether the building is inside or outside of the fire districts.

**106.5 Fuel-burning and fuel-oil storage equipment plans.** Construction documents for fuel-burning and fuel oil storage equipment shall contain plans that include the following data and information:

1. Diagrams of all distribution piping, including vent and fill piping for oil systems, and all safety cut-off and relief devices and valves in piping; indications of the sizes of distribution piping to be used and the fire resistive ratings of the shafts or spaces containing distribution piping where required to be fire rated.
2. Diagrammatic floor plans showing the size, location, material for all fuel oil and transfer distribution piping and related equipment.
3. Floor plans or partial floor plans showing the location, layout, size, and listing information for all fuel-burning equipment, tanks, vents, and chimneys. The plans shall also indicate the method or means of providing air to the equipment space, including duct and opening sizes.
4. Plans indicating the location and type of any relevant smoke and heat detectors, alarm, and fire extinguishing systems.
5. Seismic protection and restraint details for piping and equipment as required by Chapter 16 of the *New York City Building Code*.

6. Details indicating the location, size and materials for all breechings; the thickness and type of insulation materials; and the clearances from combustibile walls, partitions, and ceiling; and the fire-resistive ratings of rooms and spaces containing the equipment.
7. Details describing the type, material, listing information, height, and termination distances to adjacent properties and structures for chimneys and vents.
8. Details showing structural supports for fuel-burning equipment where required.
9. A statement as to the kind or grade of fuel to be used.
10. Plans indicating the location, arrangement, size, load, and maximum capacity of the burning, storage and fuel-pumping equipment.
11. In areas of special flood hazards, construction documents shall comply with Appendix G of the *New York City Building Code*.

**106.6 Heating systems.** Construction documents for heating systems shall include the temperature to be maintained in every room and the output capacity in BTU per hour of the central heating source.

**106.7 Boilers.** Construction documents for boiler installations shall indicate the output capacity in BTU per hour, the operating weight of each boiler, the pressure setting of the relief valves, and such other data and information as required by this code.

**106.8 Air conditioning and ventilating systems.** Construction documents for air conditioning and ventilating systems shall contain plans that include the following data and information:

1. The location and sizes of all ducts; the location of all fire and smoke dampers, motors, fans, and filters; the type, air capacity, and size of all equipment; and where not shown on accompanying structural plans, the operating weight and manner of support of equipment.
2. The locations of smoke detecting devices.
3. The location and size of the fresh air intake, the design population, and the required ventilation for each room or space.
4. The amount of air to be exhausted or supplied from each outlet for each room or space.
5. In the case of ventilating or exhaust systems for ranges, fryers, ovens, and other similar types of restaurant or bakery equipment, for which a hood is required, the plans shall also show the type of extinguishing system, the location of heat detection devices, nozzles, piping, gas controls, manual and automatic control valves, method of joining ducts, method and location of discharging exhaust from building, the location of break-glass controls, and the quantity in cfm designed for each hood.

**106.9 Refrigerating systems.** Construction documents for refrigerating systems shall contain plans that include the following data and information:

1. The location of all machinery; the horsepower of compressors; the type and number of pounds of refrigerant to be used; and the air quantities for, and means of, ventilating the machinery space.
2. The location of emergency switches for compressors and for ventilation in the machinery rooms.
3. The location of pressure relief piping and any city water connections and water-saving devices.
4. The tonnage capacity of the machine and the suction and discharge pressures at which the machine is rated.
5. The operating weight of the equipment.
6. The class of refrigerant utilized.

**106.10 Energy efficiency.** Construction documents shall include a statement by the registered design professional of record that: “To the best of my knowledge, belief and professional judgment, these plans and specifications are in compliance with the *Energy Conservation Construction Code of New York State*.” In addition, the following requirements shall apply:

1. A lead energy professional shall be identified for each project, who shall draw the relevant information regarding envelope, mechanical systems, service water heating system and lighting and power systems from construction documents into an energy analysis. The energy analysis shall balance total energy consumption of all systems in accordance with the *Energy Conservation Construction Code of New York State* and shall be signed and sealed by the lead energy professional.
2. The format for the energy analysis shall be as established in the *Energy Conservation Construction Code of New York State*, or as approved by the department, and shall comprise a sheet within the drawing set. Supporting documentation shall be available within the drawing set or upon request of the department.

## **SECTION MC 107** **INSPECTIONS AND TESTING**

**107.1 General.** Except as otherwise specifically provided, inspections required by this code or by the department during the progress of work may be performed on behalf of the owner by approved agencies or, if applicable, by special inspectors. However, in the interest of public safety, the commissioner may direct that any of such inspections be performed by the department. All

inspections shall be performed at the sole cost and expense of the owner. Refer to Article 116 of Chapter 1 of Title 28 of the *Administrative Code* for additional provisions relating to inspections. In addition to any inspections otherwise required by this code or applicable rules, the following inspections shall be required:

1. Progress inspections:

1.1. Underground inspection shall be made after trenches or ditches are excavated and bedded, piping installed, and before backfill is put in place. When excavated soil contains rocks, broken concrete, frozen chunks and other rubble that would damage or break the piping or cause corrosive action, clean backfill shall be on the job site.

**Exception:** Ground-source heat pump loop systems tested in accordance with Section 1208.1.1 shall be permitted to be backfilled prior to inspection.

1.2. Rough-in inspection shall be made after the roof, framing, fireblocking and bracing are in place and all ducting and other components to be concealed are complete, and prior to the installation of wall or ceiling membranes.

2. Special inspections. Special inspections shall be performed in accordance with this code and Chapter 17 of the *New York City Building Code*.

3. Final inspection. Refer to Article 116 of Chapter 1 of Title 28 of the *Administrative Code*.

4. Issuance of Certificate of Compliance. Upon satisfactory inspection of service equipment and the satisfaction of all the requirements for sign-off, the department shall issue a certificate of compliance as applicable for the following service equipment:

4.1. Air-conditioning and ventilation systems

4.2. Fuel-burning and fuel-oil storage equipment, including generators,

4.3. Refrigeration systems,

4.4. Heating systems, and

4.5. Boilers.

The requirements of Section 107.1 shall not be considered to prohibit the operation of any heating equipment or appliances installed to replace existing heating equipment or appliances serving an occupied portion of a structure provided that a request for inspection of such heating equipment or appliances has been filed with the department not more than 48 hours after such replacement work is completed, and before any portion of such equipment or appliances is concealed by any permanent portion of the structure.

**107.1.1 Approved inspection agencies.** Refer to Articles 114 and 115 of Chapter 1 of Title 28 of the *Administrative Code*.

**107.1.2 Inspection of prefabricated construction assemblies.** Prior to the approval of a prefabricated construction assembly having concealed mechanical work and the issuance of a permit, the department shall require the submittal of an evaluation report by an approved agency on each prefabricated construction assembly, indicating the complete details of the mechanical system, including a description of the system and its components, the basis upon which the system is being evaluated, test results and similar information, and other data as necessary for the commissioner to determine conformance to this code.

**107.1.2.1 Test and inspection records.** Required test and inspection records shall be available to the commissioner at all times during the fabrication of the mechanical system and the erection of the building; or such records as the commissioner designates shall be filed.

**107.2 Testing.** Mechanical systems shall be tested as required in this code and in accordance with Sections 107.2.1 through 107.2.3. Tests shall be made by the permit holder and witnessed by the department or an approved agency.

**107.2.1 New, altered, extended or repaired systems.** New mechanical systems and parts of existing systems, that have been altered, extended, renovated or repaired, shall be tested as prescribed herein to disclose leaks and defects.

**107.2.2 Apparatus, material and labor for tests.** Apparatus, material and labor required for testing a mechanical system or part thereof shall be furnished by the permit holder.

**107.2.3 Reinspection and testing.** Where any work or installation does not pass an initial test or inspection, the necessary corrections shall be made so as to achieve compliance with this code. The work or installation shall then be resubmitted to the department for inspection and testing.

**107.3 Sign-off of completed work.** Refer to Article 116 of Chapter 1 of Title 28 of the *Administrative Code*.

**107.4 Temporary connection.** The commissioner shall have the authority to authorize the temporary connection of a mechanical system to the sources of energy for the purpose of testing mechanical systems or for use under a temporary certificate of occupancy.

## **SECTION MC 108** **VIOLATIONS**

**108.1 General.** Refer to Chapters 2 and 3 of Title 28 of the *Administrative Code*.



**CHAPTER 2**  
**DEFINITIONS**

**SECTION MC 201**  
**GENERAL**

**201.1 Scope.** Unless otherwise expressly stated, the following words and terms shall, for the purposes of this code, have the meanings indicated in this chapter.

**201.2 Interchangeability.** Words used in the present tense include the future; words in the masculine gender include the feminine and neuter; the singular number includes the plural and the plural, the singular.

**201.3 Terms defined in other codes.** Where terms are not defined in this code and are defined in the *New York City Building Code*, the *New York City Electrical Code*, the *New York City Fire Code*, the *New York City Fuel Gas Code* or the *New York City Plumbing Code*, such terms shall have meanings ascribed to them as in those codes.

**201.4 Terms not defined.** Where terms are not defined through the methods authorized by this section, such terms shall have ordinarily accepted meanings such as the context implies.

**SECTION MC 202**  
**GENERAL DEFINITIONS**

**ABRASIVE MATERIALS.** Moderately abrasive particulate in high concentrations, and highly abrasive particulate in moderate and high concentrations, such as alumina, bauxite, iron silicate, sand and slag.

**ABSORPTION SYSTEM.** A refrigerating system in which refrigerant is pressurized by pumping a chemical solution of refrigerant in absorbent, and then separated by the addition of heat in a generator, condensed (to reject heat), expanded, evaporated (to provide refrigeration), and reabsorbed in an absorber to repeat the cycle; the system may be single or multiple effect, the latter using multiple stages or internally cascaded use of heat to improve efficiency.

**ACCESS (TO).** That which enables a device, appliance or equipment to be reached by ready access or by a means that first requires the removal or movement of a panel, door or similar obstruction [see also “Ready access (to)”].

**AIR.** All air supplied to mechanical equipment and appliances for combustion, ventilation, cooling, etc. Standard air is air at standard temperature and pressure, namely, 70°F (21°C) and 29.92 inches of mercury (101.3 kPa).

**AIR CONDITIONING.** The treatment of air so as to control simultaneously the temperature, humidity, cleanness and distribution of the air to meet the requirements of a conditioned space.

**AIR-CONDITIONING SYSTEM.** A system that consists of heat exchangers, blowers, filters, supply, exhaust and return ducts, and shall include any apparatus installed in connection therewith.

**AIR DISTRIBUTION SYSTEM.** Any system of ducts, plenums and air-handling equipment that circulates air within a space or spaces and includes systems made up of one or more air-handling units.

**AIR, EXHAUST.** Air being removed from any space, appliance or piece of equipment and conveyed directly to the atmosphere by means of openings or ducts.

**AIR, INTAKE.** Air supplied from the outdoors to any space, appliance or piece of equipment.

**AIR, RELIEF.** Air removed from any space, appliance or piece of equipment.

**AIR-HANDLING UNIT.** A blower or fan used for the purpose of distributing supply air to a room, space or area.

**AIR, MAKEUP.** Air that is provided to replace air being exhausted.

**AIR TRANSFER OPENING.** An opening designed to allow the movement of environmental air between two contiguous spaces.

**ALTERATION.** Any construction, addition, change of use or occupancy, or renovation to a building or structure in existence. See Section 28-101.5 of the *Administrative Code*.

**APPLIANCE.** A device or apparatus that is manufactured and designed to utilize energy and for which this code provides specific requirements.

**APPLIANCE, EXISTING.** Any appliance regulated by this code which was legally installed prior to the effective date of this code, or for which a permit to install has been issued.

**APPLIANCE, FUEL-FIRED.** An appliance that burns solid, liquid and/or gaseous fuel, including but not limited to wood stoves, household cooking ranges, furnaces, boilers, water heaters, clothes dryers and gas-fired refrigerators.

**APPLIANCE, GAS (EQUIPMENT).** Any apparatus or equipment that uses gas as a fuel or raw material to produce light, heat, power, refrigeration or air conditioning.

#### **APPLIANCE TYPE.**

**High-heat appliance.** Any appliance in which the products of combustion at the point of entrance to the flue under normal operating conditions have a temperature greater than 2,000°F (1093°C).

**Low-heat appliance (residential appliance).** Any appliance in which the products of combustion at the point of entrance to the flue under normal operating conditions have a temperature of 1,000°F (538°C) or less.

**Medium-heat appliance.** Any appliance in which the products of combustion at the point of entrance to the flue under normal operating conditions have a temperature of more than 1,000°F (538°C), but not greater than 2,000°F (1093°C).

**APPLIANCE, VENTED.** An appliance designed and installed in such a manner that all of the products of combustion are conveyed directly from the appliance to the outside atmosphere through an approved chimney or vent system.

**APPROVED.** Acceptable to the commissioner. In reference to construction documents, the determination by the department after full examination that submitted construction documents comply with this code and other applicable laws and rules. In reference to materials, the determination by the commissioner that material is acceptable for its intended use. See Section 28-101.5 of the *Administrative Code*.

**APPROVED AGENCY.** An established and recognized agency, or other qualified person, regularly engaged in conducting tests or furnishing inspection services, when approved pursuant to department rules as qualified to perform or witness identified testing or inspection services. See Chapter 1 of Title 28 of the *Administrative Code*.

**APPROVED INSPECTION AGENCY.** An approved agency that is approved by the department as qualified to perform one or more of the inspections required by this code. See Chapter 1 of Title 28 of the *Administrative Code*.

**APPROVED TESTING AGENCY.** An approved agency that is approved by the department as qualified to test and evaluate the performance of one or more of the materials regulated in their use by this code. Such term shall include, when approved pursuant to department rules, a third party testing or certification agency, evaluation agency, testing laboratory, testing service or other entity concerned with product evaluation. See Chapter 1 of Title 28 of the *Administrative Code*.

**ARCHITECT.** A person licensed and registered to practice the profession of architecture under the Education Law of the state of New York.

**AUTOMATIC BOILER.** Any class of boiler that is equipped with the controls and limit devices specified in Chapter 10.

**BATHROOM.** A room containing a bathtub, shower, spa or similar bathing fixture.

**BOILER, HIGH-PRESSURE.** An appliance (equipment) for supplying steam of hot water that, for a steam boiler, operates at a pressure of more than 15 psig (103 kPa gauge), and for a hot water boiler, operates at a pressure exceeding 160 psig (1103 kPa gauge) or at a temperature exceeding 250°F (121°C).

**BOILER, LOW-PRESSURE.** A self-contained appliance for supplying steam or hot water as follows:

**Hot water heating boiler.** A boiler in which no steam is generated, from which hot water is circulated for heating purposes and then returned to the boiler, and that operates at water pressures not exceeding 160 pounds per square inch gauge (psig) (1103 kPa gauge) and at water temperatures not exceeding 250°F (121°C) at or near the boiler outlet.

**Hot water supply boiler.** A boiler, completely filled with water, which furnishes hot water to be used externally to itself, and that operates at water pressures not exceeding 160 psig (1103 kPa gauge) and at water temperatures not exceeding 250°F (121°C) at or near the boiler outlet.

**Steam-heating boiler.** See “steam-heating boiler”.

**BOILER ROOM.** A room primarily utilized for the installation of a boiler.

**BRAZED JOINT.** A gas-tight joint obtained by the joining of metal parts with metallic mixtures or alloys which melt at a temperature above 1,000°F (538°C), but lower than the melting temperature of the parts to be joined.

**BRAZING.** A metal joining process wherein coalescence is produced by the use of a nonferrous filler metal having a melting point above 1,000°F (538°C), but lower than that of the base metal being joined. The filler material is distributed between the closely fitted surfaces of the joint by capillary attraction.

**Btu.** Abbreviation for British thermal unit, which is the quantity of heat required to raise the temperature of 1 pound (454 g) of water 1°F (0.56°C) (1 Btu = 1055 J).

**BUILDING.** Any structure used or intended for supporting or sheltering any use or occupancy. The term shall be construed as if followed by the phrase “structure, premises, lot or part thereof” unless otherwise indicated by the text. See Section 28-101.5 of the *Administrative code*.

**CEILING RADIATION DAMPER.** A device installed to limit radiant heat transfer through an air outlet or air inlet opening in the ceiling of a floor-ceiling or roof-ceiling assembly, which device has not less than a 1-hour fire-resistance rating.

**CHIMNEY.** A primarily vertical structure containing one or more flues, for the purpose of carrying gaseous products of combustion and air from a fuel-burning appliance to the outside atmosphere.

**Factory-built chimney.** A listed and labeled chimney composed of factory-made components, assembled in the field in accordance with manufacturer’s instructions and the conditions of the listing.

**Masonry chimney.** A field-constructed chimney composed of solid masonry units, bricks, stones or concrete.

**Metal chimney.** A field-constructed chimney of metal.

**CHIMNEY CONNECTOR.** A pipe or metal breeching that connects a fuel-burning appliance to a chimney.

**CLEARANCE.** The minimum distance through air measured between the heat-producing surface of the mechanical appliance, device or equipment and the surface of the combustible material or assembly.

**CLOSED COMBUSTION SOLID-FUEL-BURNING APPLIANCE.** A heat-producing appliance that employs a combustion chamber that has no openings other than the flue collar, fuel charging door and adjustable openings provided to control the amount of combustion air that enters the combustion chamber.

**CLOTHES DRYER.** An appliance used to dry wet laundry by means of heat. Dryer classifications are as follows:

**Type 1.** Factory-built package, multiple production. Primarily used in family living environment. Usually the smallest unit physically and in function output.

**Type 2.** Factory-built package, multiple production. Used in business with direct intercourse of the function with the public. Not designed for use in individual family living environment.

**COMBUSTIBLE ASSEMBLY.** Wall, floor, ceiling or other assembly constructed of one or more component materials that are not defined as noncombustible.

**COMBUSTIBLE LIQUIDS.** Any liquids having a flash point at or above 100°F (38°C), and that are divided into the following classifications:

**Class II.** Liquids having flash points at or above 100°F (38°C) and below 140°F (60°C).

**Class IIIA.** Liquids having flash points at or above 140°F (60°C) and below 200°F (93°C).

**Class IIIB.** Liquids having flash points at or above 200°F (93°C).

**COMBUSTIBLE MATERIAL.** Any material not defined as noncombustible.

**COMBUSTION.** In the context of this code, refers to the rapid oxidation of fuel accompanied by the production of heat or heat and light.

**COMBUSTION AIR.** Air necessary for complete combustion of a fuel, including theoretical air and excess air.

**COMBUSTION CHAMBER.** The portion of an appliance within which combustion occurs.

**COMBUSTION PRODUCTS.** Constituents resulting from the combustion of a fuel with the oxygen of the air, including the inert gases, but excluding excess air.

**COMMERCIAL COOKING RECIRCULATING SYSTEM.** Self-contained system consisting of the exhaust hood, the cooking equipment, the filters, and the fire suppression system. The system is designed to capture cooking vapors and residues generated from commercial cooking equipment. The system removes contaminants from the exhaust air and recirculates the air to the space from which it was withdrawn.

**COMMERCIAL COOKING APPLIANCES.** Appliances used in a commercial food service establishment for heating or cooking food and which produce grease vapors, steam, fumes, smoke or odors that are required to be removed through a local exhaust ventilation system. Such appliances include deep fat fryers; upright broilers; griddles; broilers; steam-jacketed kettles; hot-top ranges; under-fired broilers (charbroilers); ovens; barbecues; rotisseries; and similar appliances. For the purpose of this definition, a food service establishment shall include any building or a portion thereof used for the preparation and serving of food.

#### **COMMERCIAL KITCHEN HOODS.**

**Backshelf Hood.** A backshelf hood is also referred to as a low-proximity hood, or as a sidewall hood where wall mounted. Its front lower lip is low over the appliance(s) and is “set back” from the front of the appliance(s). It is always closed to the rear of the appliances by a panel where free-standing, or by a panel or wall where wall mounted, and its height above the cooking surface varies. (This style of hood can be constructed with partial end panels to increase its effectiveness in capturing the effluent generated by the cooking operation).

**Double Island Canopy Hood.** A double island canopy hood is placed over back to back appliances or appliance lines. It is open on all sides and overhangs both fronts and the sides of the appliance(s). It could have a wall panel between the backs of the appliances. (The fact that exhaust air is drawn from both sides of the double canopy to meet in the center causes each side of this hood to emulate a wall canopy hood, and thus it functions much the same with or without an actual wall panel between the backs of the appliances).

**Eyebrow Hood.** An eyebrow hood is mounted directly to the face of an appliance, such as an oven and dishwasher, above the opening(s) or door(s) from which effluent is emitted, extending past the sides and overhanging the front of the opening to capture the effluent.

**Pass-over Hood.** A pass-over hood is a free-standing form of a backshelf hood constructed low enough to pass food over the top.

**Single Island Canopy Hood.** A single island canopy hood is placed over a single appliance or appliance line. It is open on all sides and overhangs the front, rear, and sides of the

appliance(s). A single island canopy is more susceptible to cross drafts and requires a greater exhaust air flow than an equivalent sized wall-mounted canopy to capture and contain effluent generated by the cooking operation(s).

**Wall Canopy Hood.** A wall canopy exhaust hood is mounted against a wall above a single appliance or line of appliance(s), or it could be free-standing with a back panel from the rear of the appliances to the hood. It overhangs the front and sides of the appliance(s) on all open sides. The wall acts as a back panel, forcing the makeup air to be drawn across the front of the cooking equipment, thus increasing the effectiveness of the hood to capture and contain effluent generated by the cooking operation(s).

**COMMISSIONER.** The Commissioner of Buildings of the City of New York or his or her duly authorized representative. See Section 28-101.5 of the *Administrative Code*.

**COMPENSATING HOODS.** Compensating hoods are those having integral (built-in) makeup air supply. The makeup air supply for such hoods is generally supplied from: short-circuit flow from inside the hood, air curtain flow from the bottom of the front face, and front face discharge from the outside front wall of the hood. The compensating makeup airflow can also be supplied from the rear or side of the hood, or the rear, front, or sides of the cooking equipment. The makeup air flow can be one or a combination of methods.

**COMPRESSOR.** A specific machine, with or without accessories, for compressing a gas.

**COMPRESSOR, POSITIVE DISPLACEMENT.** A compressor in which increase in pressure is attained by changing the internal volume of the compression chamber.

**COMPRESSOR UNIT.** A compressor with its prime mover and accessories.

**CONCEALED LOCATION.** A location that cannot be accessed without damaging permanent parts of the building structure or finished surface. Spaces above, below or behind readily removable panels or doors shall not be considered as concealed.

**CONDENSATE.** The liquid that condenses from a gas (including flue gas) caused by a reduction in temperature or increase in pressure.

**CONDENSER.** A heat exchanger designed to liquefy refrigerant vapor by removal of heat.

**CONDENSING UNIT.** A specific refrigerating machine combination for a given refrigerant, consisting of one or more power-driven compressors, condensers, liquid receivers (when required), and the regularly furnished accessories.

**CONDITIONED SPACE.** An area, room or space being heated or cooled by any equipment or appliance.

**CONFINED SPACES.** A space having a volume less than 50 cubic feet per 1,000 British thermal

units per hour (Btu/h) (4.8 m<sup>3</sup>/kW) of the aggregate input rating of all appliances installed in that space.

**CONSTRUCTION DOCUMENTS.** Plans and specifications and other written, graphic and pictorial documents, prepared or assembled for describing the design, location and physical characteristics of the elements of the project necessary for obtaining a building permit. See Section 28-101.5 of the *Administrative Code*.

**CONTROL.** A manual or automatic device designed to regulate the gas, air, water or electrical supply to, or operation of, a mechanical system.

**CONVERSION BURNER.** A burner designed to supply gaseous fuel to an appliance originally designed to utilize another fuel.

**COOKING APPLIANCE.** See “Commercial cooking appliances.”

**DAMPER.** A manually or automatically controlled device to regulate draft or the rate of flow of air or combustion gases.

**Volume damper.** A device that, when installed, will restrict, retard or direct the flow of air in a duct, or the products of combustion in a heat-producing appliance, its vent connector, vent or chimney therefrom.

**DESIGN WORKING PRESSURE.** The maximum allowable working pressure for which a specific part of a system is designed.

**DIRECT REFRIGERATION SYSTEM.** A system in which the evaporator or condenser of the refrigerating system is in direct contact with the air or other substances to be cooled or heated.

**DIRECT-VENT APPLIANCES.** Appliances that are constructed and installed so that all air for combustion is derived from the outside atmosphere and all flue gases are discharged to the outside atmosphere.

**DRAFT.** The pressure difference existing between the equipment or any component part and the atmosphere, that causes a continuous flow of air and products of combustion through the gas passages of the appliance to the atmosphere.

**Induced draft.** The pressure difference created by the action of a fan, blower or ejector, that is located between the appliance and the chimney or vent termination.

**Natural draft.** The pressure difference created by a vent or chimney because of its height, and the temperature difference between the flue gases and the atmosphere.

**DRIP.** The container placed at a low point in a system of piping to collect condensate and from which the condensate is removable.



**DRY CLEANING SYSTEMS.** Dry cleaning plants or systems are classified as follows:

**Type I.** Those systems using Class I flammable liquid solvents having a flash point below 100°F (38°C).

**Type II.** Those systems using Class II combustible liquid solvents having a flash point at or above 100°F (38°C) and below 140°F (60°C).

**Type III.** Those systems using Class III combustible liquid solvents having a flash point at or above 140°F (60°C).

**Types IV and V.** Those systems using Class IV nonflammable liquid solvents.

**DUCT.** A tube or conduit utilized for conveying air. The air passages of self-contained systems are not to be construed as air ducts.

**DUCT FURNACE.** A warm-air furnace normally installed in an air distribution duct to supply warm air for heating. This definition shall apply only to a warm-air heating appliance that, for air circulation, depends on a blower not furnished as part of the furnace.

**DUCT SYSTEM.** A continuous passageway for the transmission of air that, in addition to ducts, includes duct fittings, dampers, plenums, fans and accessory air-handling equipment and appliances.

**DWELLING.** A building or structure that is occupied in whole or in part as the home, residence or sleeping place of one or more families.

**DWELLING UNIT.** A single unit consisting of one or more habitable rooms and occupied or arranged to be occupied as a unit separate from all other units within a dwelling.

**ELECTRIC HEATING APPLIANCE.** An appliance that produces heat energy to create a warm environment by the application of electric power to resistance elements, refrigerant compressors or dissimilar material junctions.

**ENERGY RECOVERY VENTILATION SYSTEM.** Systems that employ air-to-air heat exchangers to recover energy from or reject energy to exhaust air for the purpose of preheating, precooling, humidifying or dehumidifying outdoor ventilation air prior to supplying such air to a space, either directly or as part of an HVAC system.

**ENGINEER.** A person licensed and registered to practice the profession of engineering under the Education Law of the State of New York.

**ENVIRONMENTAL AIR.** Air that is supplied, returned, recirculated, or exhausted from a space for the purpose of modifying the existing atmosphere within a building.

**EQUIPMENT.** All piping, ducts, vents, control devices and other components of systems other than appliances which are permanently installed and integrated to provide control of environmental conditions for buildings. This definition shall also include other systems specifically regulated in this code.

**EQUIPMENT, EXISTING.** Any equipment regulated by this code which was legally installed prior to the effective date of this code, or for which a permit to install has been issued.

**EVAPORATIVE COOLER.** A device used for reducing the sensible heat of air for cooling by the process of evaporation of water into an airstream.

**EVAPORATIVE COOLING SYSTEM.** The equipment and appliances intended or installed for the purpose of environmental cooling by an evaporative cooler from which the conditioned air is distributed through ducts or plenums to the conditioned area.

**EVAPORATOR.** That part of the system in which liquid refrigerant is vaporized to produce refrigeration.

**EXCESS AIR.** The amount of air provided in addition to theoretical air to achieve complete combustion of a fuel, thereby preventing the formation of dangerous products of combustion.

**EXHAUST SYSTEM.** An assembly of connected ducts, plenums, fittings, registers, grilles and hoods through which air is conducted from a space or spaces and exhausted to the outside atmosphere.

**EXTRA-HEAVY DUTY COOKING APPLIANCE.** Extra-heavy duty cooking appliances include appliances utilizing solid fuel such as wood, charcoal, briquettes, and mesquite as the primary source of heat for cooking.

**FIREPLACE.** An assembly consisting of a hearth and fire chamber of noncombustible material and provided with a chimney, for use with solid fuels.

**Factory-built fireplace.** A listed and labeled fireplace and chimney system composed of factory-made components, and assembled in the field in accordance with manufacturer's instructions and the conditions of the listing.

**Masonry fireplace.** A field-constructed fireplace composed of solid masonry units, bricks, stones or concrete.

**FIREPLACE STOVE.** A free-standing chimney-connected solid-fuel-burning heater, designed to be operated with the fire chamber doors in either the open or closed position.

**FLAME SAFEGUARD.** A device that will automatically shut off the fuel supply to a main burner or group of burners when the means of ignition of such burners becomes inoperative, and

when flame failure occurs on the burner or group of burners.

**FLAME SPREAD INDEX.** The numerical value assigned to a material tested in accordance with ASTM E 84.

**FLAMMABILITY CLASSIFICATION.** Refrigerants shall be assigned to one of the three classes—1, 2 or 3—in accordance with ASHRAE 34.

**FLAMMABLE LIQUIDS.** Any liquid that has a flash point below 100°F (38°C), and has a vapor pressure not exceeding 40 psia (276 kPa) at 100°F (38°C). Flammable liquids shall be known as Class I liquids and shall be divided into the following classifications:

**Class IA.** Liquids having a flash point below 73°F (23°C) and a boiling point below 100°F (38°C).

**Class IB.** Liquids having a flash point below 73°F (23°C) and a boiling point at or above 100°F (38°C).

**Class IC.** Liquids having a flash point at or above 73°F (23°C) and below 100°F (38°C).

**FLAMMABLE VAPOR OR FUMES.** Mixtures of gases in air at concentrations equal to or greater than the LFL and less than or equal to the upper flammability limit (UFL).

**FLASH POINT.** The minimum temperature corrected to a pressure of 14.7 psia (101 kPa) at which the application of a test flame causes the vapors of a portion of the sample to ignite under the conditions specified by the test procedures and apparatus. The flash point of a liquid shall be determined in accordance with ASTM D 56, ASTM D 93 or ASTM D 3278.

**FLOOR AREA, NET.** The actual occupied area, not including unoccupied accessory areas or thicknesses of walls.

**FLOOR FURNACE.** A completely self-contained furnace suspended from the floor of the space being heated, taking air for combustion from outside such space and with means for observing flames and lighting the appliance from such space.

**FLUE.** A passageway within a chimney or vent through which gaseous combustion products pass.

**FLUE CONNECTION (BREECHING).** A passage for conducting the products of combustion from a fuel-fired appliance to the vent or chimney (see also “Chimney connector” and “Vent connector”).

**FLUE GASES.** Products of combustion and excess air.

**FLUE LINER (LINING).** A system or material used to form the inside surface of a flue in a chimney or vent, for the purpose of protecting the surrounding structure from the effects of

combustion products and conveying combustion products without leakage into the atmosphere.

**FUEL GAS.** A natural gas, manufactured gas, liquefied petroleum gas or a mixture of these.

**FUEL OIL.** Kerosene or any hydrocarbon oil having a flash point not less than 100°F (38°C).

**FUEL-OIL PIPING SYSTEM.** A closed piping system that connects a combustible liquid from a source of supply to a fuel-oil-burning appliance.

**FURNACE.** A completely self-contained heating unit that is designed to supply heated air to spaces remote from or adjacent to the appliance location.

**FURNACE ROOM.** A room primarily utilized for the installation of fuel-burning space-heating and water-heating appliances other than boilers (see also “Boiler room”).

**FUSIBLE PLUG.** A device arranged to relieve pressure by operation of a fusible member at a predetermined temperature.

**GROUND SOURCE HEAT PUMP LOOP SYSTEM.** Piping buried in horizontal or vertical excavations or placed in a body of water for the purpose of transporting heat transfer liquid to and from a heat pump. Included in this definition are closed loop systems in which the liquid is recirculated and open loop systems in which the liquid is drawn from a well or other source.

**HAZARDOUS LOCATION.** Any location considered to be a fire hazard for flammable vapors, dust, combustible fibers or other highly combustible substances. The location is not necessarily categorized in the *New York City Building Code* as a high-hazard use group classification.

**HEAT EXCHANGER.** A device that transfers heat from one medium to another.

**HEAT PUMP.** A refrigeration system that extracts heat from one substance and transfers it to another portion of the same substance or to a second substance at a higher temperature for a beneficial purpose.

**HEAT TRANSFER LIQUID.** The operating or thermal storage liquid in a mechanical system, including water or other liquid base, and additives at the concentration present under operating conditions used to move heat from one location to another. Refrigerants are not included as heat transfer liquids.

**HEAVY-DUTY COOKING APPLIANCE.** Heavy-duty cooking appliances include electric under-fired broilers, electric chain (conveyor) broilers, gas under-fired broilers, gas chain (conveyor) broilers, gas open-burner ranges (with or without oven), electric and gas wok ranges, and electric and gas over-fired (upright) broilers and salamanders.

**HIGH-PROBABILITY SYSTEMS.** A refrigeration system in which the basic design or the location of components is such that a leakage of refrigerant from a failed connection, seal or

component will enter an occupancy classified area, other than the machinery room.

**HIGH-SIDE PRESSURE.** The parts of a refrigerating system subject to condenser pressure.

**HOOD.** An air-intake device used to capture by entrapment, impingement, adhesion or similar means, grease and similar contaminants before they enter a duct system.

**Type I.** A kitchen hood for collecting and removing grease vapors and smoke.

**Type II.** A general kitchen hood for collecting and removing steam, vapor, heat and odors.

**HOOD, FUME.** A hood used for hazardous exhaust systems.

**HYDROGEN GENERATING APPLIANCE.** A self-contained package or factory-matched packages of integrated systems for generating gaseous hydrogen. Hydrogen generating appliances utilize electrolysis, reformation, chemical, or other processes to generate hydrogen.

**IGNITION SOURCE.** A flame, spark or hot surface capable of igniting flammable vapors or fumes. Such sources include appliance burners, burner ignitors and electrical switching devices.

**IMMEDIATELY DANGEROUS TO LIFE OR HEALTH (IDLH).** The concentration of airborne contaminants that poses a threat of death, immediate or delayed permanent adverse health effects, or effects that could prevent escape from such an environment. This contaminant concentration level is established by the National Institute of Occupational Safety and Health (NIOSH) based on both toxicity and flammability. It is generally expressed in parts per million by volume (ppm v/v) or milligrams per cubic meter (mg/m<sup>3</sup>).

**INDIRECT REFRIGERATION SYSTEM.** A system in which a secondary coolant cooled or heated by the refrigerating system is circulated to the air or other substance to be cooled or heated. Indirect systems are distinguished by the method of application shown below:

**Closed system.** A system in which a secondary fluid is either cooled or heated by the refrigerating system and then circulated within a closed circuit in indirect contact with the air or other substance to be cooled or heated.

**Double-indirect open-spray system.** A system in which the secondary substance for an indirect open-spray system is heated or cooled by an intermediate coolant circulated from a second enclosure.

**Open-spray system.** A system in which a secondary coolant is cooled or heated by the refrigerating system and then circulated in direct contact with the air or other substance to be cooled or heated.

**Vented closed system.** A system in which a secondary coolant is cooled or heated by the refrigerating system and then passed through a closed circuit in the air or other substance to be

cooled or heated, except that the evaporator or condenser is placed in an open or appropriately vented tank.

**JOINT, FLANGED.** A joint made by bolting together a pair of flanged ends.

**JOINT, FLARED.** A metal-to-metal compression joint in which a conical spread is made on the end of a tube that is compressed by a flare nut against a mating flare.

**JOINT, MECHANICAL.** A general form of gas-tight joints obtained by the joining of metal parts through a positive-holding mechanical construction, such as flanged joint, screwed joint or flared joint.

**JOINT, PLASTIC ADHESIVE.** A joint made in thermoset plastic piping by the use of an adhesive substance which forms a continuous bond between the mating surfaces without dissolving either one of them.

**JOINT, PLASTIC HEAT FUSION.** A joint made in thermoplastic piping by heating the parts sufficiently to permit fusion of the materials when the parts are pressed together.

**JOINT, PLASTIC SOLVENT CEMENT.** A joint made in thermoplastic piping by the use of a solvent or solvent cement which forms a continuous bond between the mating surfaces.

**JOINT, SOLDERED.** A gas-tight joint obtained by the joining of metal parts with metallic mixtures of alloys which melt at temperatures between 400°F (204°C) and 1,000°F (538°C).

**JOINT, WELDED.** A gas-tight joint obtained by the joining of metal parts in molten state.

**LABELED.** Material to which has been attached a label, symbol or other identifying mark of the manufacturer that contains the name of the manufacturer, the function and performance characteristics of the product or material, and the name and identification of an approved agency and that indicates that a representative sample of the material has been tested and evaluated by an approved agency for compliance with nationally recognized standards or tests to determine suitable usage in a specified manner. See Section 28-101.5 of the *Administrative Code*.

**LIGHT-DUTY COOKING APPLIANCE.** Light-duty cooking appliances include gas and electric ovens (including standard, bake, roasting, revolving, retherm, convection, combination convection/steamer, conveyor, deck or deck-style pizza, and pastry), electric and gas steam-jacketed kettles, electric and gas compartment steamers (both pressure and atmospheric) and electric and gas cheesemelters.

**LIMIT CONTROL.** A device responsive to changes in pressure, temperature or level for turning on, shutting off or throttling the gas supply to an appliance.

**LIMITED CHARGE SYSTEM.** A system in which, with the compressor idle, the design pressure will not be exceeded when the refrigerant charge has completely evaporated.

**LISTED.** Material identified in a list published by an approved agency that maintains periodic inspection of production of listed material or periodic evaluation services and whose listing states either that the material meets identified nationally recognized standards or has been tested and found suitable for a specified purpose when installed in accordance with the manufacturer's installation instructions. See Section 28-101.5 of the *Administrative Code*.

**LIVING SPACE.** Space within a dwelling unit utilized for living, sleeping, eating, cooking, bathing, washing and sanitation purposes.

**LOWER EXPLOSIVE LIMIT (LEL).** See "LFL."

**LOWER FLAMMABILITY LIMIT (LFL).** The minimum concentration of refrigerant that is capable of propagating a flame through a homogeneous mixture of refrigerant and air.

**LOW-PRESSURE HOT-WATER-HEATING BOILER.** A boiler furnishing hot water at pressures not exceeding 160 psig (1103 kPa) and at temperatures not exceeding 250°F (121°C).

**LOW-PRESSURE STEAM-HEATING BOILER.** A boiler furnishing steam at pressures not exceeding 15 psig (103 kPa).

**LOW-PROBABILITY SYSTEMS.** A refrigeration system in which the basic design or the location of components is such that a leakage of refrigerant from a failed connection, seal or component will not enter an occupancy-classified area, other than the machinery room.

**LOW-SIDE PRESSURE.** The parts of a refrigerating system subject to evaporator pressure.

**MACHINERY ROOM.** A room meeting prescribed safety requirements and in which refrigeration systems or components thereof are located (see Sections 1105 and 1106).

**MECHANICAL DRAFT SYSTEM.** A venting system designed to remove flue or vent gases by mechanical means, that consists of an induced-draft portion under nonpositive static pressure or a forced-draft portion under positive static pressure.

**Forced-draft venting system.** A portion of a venting system using a fan or other mechanical means to cause the removal of flue or vent gases under positive static pressure.

**Induced-draft venting system.** A portion of a venting system using a fan or other mechanical means to cause the removal of flue or vent gases under nonpositive static vent pressure.

**Power venting system.** A portion of a venting system using a fan or other mechanical means to cause the removal of flue or vent gases under positive static vent pressure.

**MECHANICAL EQUIPMENT/APPLIANCE ROOM.** A room or space in which nonfuel-fired mechanical equipment and appliances are located.

**MECHANICAL EXHAUST SYSTEM.** A system for removing air from a room or space by mechanical means.

**MECHANICAL JOINT.** A connection between pipes, fittings, or pipes and fittings, which is neither screwed, caulked, threaded, soldered, solvent cemented, brazed nor welded. Also, a joint in which compression is applied along the centerline of the pieces being joined. Some joints are part of a coupling, fitting or adapter.

**MECHANICAL SYSTEM.** A system specifically addressed and regulated in this code and composed of components, devices, appliances and equipment which become part of the building.

**MEDIUM-DUTY COOKING APPLIANCE.** Medium-duty cooking appliances include electric discrete element ranges (with or without oven), electric and gas hot-top ranges, electric and gas griddles, electric and gas double-sided griddles, electric and gas fryers (including open deep fat fryers, donut fryers, kettle fryers, and pressure fryers), electric and gas pasta cookers, electric and gas conveyor pizza ovens, electric and gas tilting skillets (braising pans) and electric and gas rotisseries.

**MODULAR BOILER.** A steam or hot-water-heating assembly consisting of a group of individual boilers called modules intended to be installed as a unit with no intervening stop valves. Modules are under one jacket or are individually jacketed. The individual modules shall be limited to a maximum input rating of 400,000 Btu/h (117 228 W/h) gas, 3 gallons per hour (gph) (11.4 L/h) oil, or 115 kW (electric).

**NATURAL DRAFT SYSTEM.** A venting system designed to remove flue or vent gases under nonpositive static vent pressure entirely by natural draft.

**NATURAL VENTILATION.** The movement of air into and out of a space through intentionally provided openings, such as windows and doors, or through nonpowered ventilators.

**NONABRASIVE/ABRASIVE MATERIALS.** Nonabrasive particulate in high concentrations, moderately abrasive particulate in low and moderate concentrations, and highly abrasive particulate in low concentrations, such as alfalfa, asphalt, plaster, gypsum and salt.

**NONCOMBUSTIBLE MATERIALS.** Materials that, when tested in accordance with ASTM E 136, have at least three of four specimens tested meeting all of the following criteria:

- 1. The recorded temperature of the surface and interior thermocouples shall not at any time during the test rise more than 54°F (30°C) above the furnace temperature at the beginning of the test.**
- 2. There shall not be flaming from the specimen after the first 30 seconds.**



3. If the weight loss of the specimen during testing exceeds 50 percent, the recorded temperature of the surface and interior thermocouples shall not at any time during the test rise above the furnace air temperature at the beginning of the test, and there shall not be flaming of the specimen.

**OCCUPANCY.** The purpose or activity for which a building or space is used or is designed, arranged or intended to be used.

**OFFSET (VENT).** A combination of approved bends that make two changes in direction bringing one section of the vent out of line but into a line parallel with the other section.

**OUTDOOR AIR.** Air taken from the outdoors, and therefore not previously circulated through the system.

**OUTDOOR OPENING.** A door, window, louver or skylight openable to the outside atmosphere.

**OUTLET, GAS.** A threaded connection or bolted flange in a piping system to which a gas-burning appliance is attached.

**PANEL HEATING.** A method of radiant space heating in which heat is supplied by large heated areas of room surfaces. The heating element usually consists of warm water piping, warm air ducts, or electrical resistance elements embedded in or located behind ceiling, wall or floor surfaces.

**PELLET FUEL-BURNING APPLIANCE.** A closed-combustion, vented appliance equipped with a fuel-feed mechanism for burning processed pellets of solid fuel of a specified size and composition.

**PIPING.** Where used in this code, “piping” refers to either pipe or tubing, or both.

**Pipe.** A rigid conduit of iron, steel, copper, brass or plastic.

**Tubing.** Semirigid conduit of copper, aluminum, plastic or steel.

**PLASTIC, THERMOPLASTIC.** A plastic that is capable of being repeatedly softened by increase of temperature and hardened by decrease of temperature.

**PLASTIC, THERMOSETTING.** A plastic that is capable of being changed into a substantially infusible or insoluble product when cured under application of heat or chemical means.

**PLENUM.** A compartment or chamber located in one story only to which one or more air ducts are connected and which forms part of the air supply or return system and may be part of the building construction, such as the concealed space above a ceiling.

**PORTABLE FUEL CELL APPLIANCE.** A fuel cell generator of electricity, which is not fixed in place. A portable fuel cell appliance utilizes a cord and plug connection to a grid-isolated load and has an integral fuel supply.

**POWER BOILER.** See “Boiler.”

**PREMISES.** Land, improvements thereon, or any part thereof.

**PRESSURE, FIELD TEST.** A test performed in the field to prove system tightness.

**PRESSURE-LIMITING DEVICE.** A pressure-responsive mechanism designed to stop automatically the operation of the pressure-imposing element at a predetermined pressure.

**PRESSURE RELIEF DEVICE.** A pressure-actuated valve or rupture member designed to relieve excessive pressure automatically.

**PRESSURE RELIEF VALVE.** A pressure-actuated valve held closed by a spring or other means and designed to relieve pressure automatically in excess of the device’s setting.

**PRESSURE VESSELS.** Closed containers, tanks or vessels that are designed to contain liquids or gases, or both, under pressure.

**PRESSURE VESSELS—REFRIGERANT.** Any refrigerant-containing receptacle in a refrigerating system. This does not include evaporators where each separate section does not exceed 0.5 cubic foot (0.014 m<sup>3</sup>) of refrigerant-containing volume, regardless of the maximum inside dimensions, evaporator coils, controls, headers, pumps and piping.

**PROTECTIVE ASSEMBLY (REDUCED CLEARANCE).** Any noncombustible assembly that is labeled or constructed in accordance with Table 308.6 and is placed between combustible materials or assemblies and mechanical appliances, devices or equipment, for the purpose of reducing required airspace clearances. Protective assemblies attached directly to a combustible assembly shall not be considered as part of that combustible assembly.

**PURGE.** To clear of air, water or other foreign substances.

**QUICK-OPENING VALVE.** A valve that opens completely by fast action, either manually or automatically controlled. A valve requiring one-quarter round turn or less is considered to be quick opening.

**RADIANT HEATER.** A heater designed to transfer heat primarily by direct radiation.

**READY ACCESS (TO).** That which enables a device, appliance or equipment to be directly reached, without requiring the removal or movement of any panel, door or similar obstruction (see “Access (to)”).

**RECEIVER, LIQUID.** A vessel permanently connected to a refrigeration system by inlet and outlet pipes for storage of liquid refrigerant.

**RECIRCULATED AIR.** Air removed from a conditioned space and intended for reuse as supply air.

**RECLAIMED REFRIGERANTS.** Refrigerants reprocessed to the same specifications as for new refrigerants by means including distillation. Such refrigerants have been chemically analyzed to verify that the specifications have been met. Reclaiming usually implies the use of processes or procedures that are available only at a reprocessing or manufacturing facility.

**RECOVERED REFRIGERANTS.** Refrigerants removed from a system in any condition without necessarily testing or processing them.

**RECYCLED REFRIGERANTS.** Refrigerants from which contaminants have been reduced by oil separation, removal of noncondensable gases, and single or multiple passes through devices that reduce moisture, acidity and particulate matter, such as replaceable core filter dryers. These procedures usually are performed at the field job site or in a local service shop.

**REFRIGERANT.** A substance utilized to produce refrigeration by its expansion or vaporization.

**REFRIGERANT SAFETY CLASSIFICATIONS.** Groupings that indicate the toxicity and flammability classes in accordance with ASHRAE 34.

**REFRIGERATED ROOM OR SPACE.** A room or space in which an evaporator or brine coil is located for the purpose of reducing or controlling the temperature within the room or space to below 68°F (20°C).

**REFRIGERATING SYSTEM.** A combination of interconnected refrigerant-containing parts constituting one closed refrigerant circuit in which a refrigerant is circulated for the purpose of extracting heat.

**REFRIGERATION MACHINERY ROOM.** See “Machinery room.”

**REFRIGERATION SYSTEM, ABSORPTION.** A heat-operated, closed-refrigeration cycle in which a secondary fluid (the absorbent) absorbs a primary fluid (the refrigerant) that has been vaporized in the evaporator.

**Direct system.** A system in which the evaporator is in direct contact with the material or space refrigerated, or is located in air-circulating passages communicating with such spaces.

**Indirect system.** A system in which a brine coil cooled by the refrigerant is circulated to the material or space refrigerated, or is utilized to cool the air so circulated. Indirect systems are distinguished by the type or method of application.

**REFRIGERATION SYSTEM CLASSIFICATION.** Refrigeration systems are classified according to the degree of probability that leaked refrigerant from a failed connection, seal or component will enter an occupied area. The distinction is based on the basic design or location of the components.

**REFRIGERATION SYSTEM, MECHANICAL.** A combination of interconnected refrigeration-containing parts constituting one closed refrigerant circuit in which a refrigerant is circulated for the purpose of extracting heat and in which a compressor is used for compressing the refrigerant vapor.

**REFRIGERATION SYSTEM, SELF-CONTAINED.** A complete factory-assembled and tested system that is shipped in one or more sections and has no refrigerant-containing parts that are joined in the field by other than companion or block valves.

**REGISTERED DESIGN PROFESSIONAL.** Refer to Chapter 1 of Title 28 of the *Administrative Code*.

**RETURN AIR.** Air removed from an approved conditioned space or location and recirculated or exhausted to the outside atmosphere.

**RETURN AIR SYSTEM.** An assembly of connected ducts, plenums, fittings, registers and grilles through which air from the space or spaces to be heated or cooled is conducted back to the supply unit (see also "Supply air system").

**ROOM HEATER, VENTED.** A free-standing heating unit burning solid or liquid fuel for direct heating of the space in and adjacent to that in which the unit is located.

**SAFETY VALVE.** A valve that relieves pressure in a steam boiler by opening fully at the rated discharge pressure. The valve is of the spring-pop type.

**SELF-CONTAINED EQUIPMENT.** Complete, factory-assembled and tested, heating, air-conditioning or refrigeration equipment installed as a single unit, and having all working parts, complete with motive power, in an enclosed unit of said machinery.

**SHAFT.** An enclosed space extending through one or more stories of a building, connecting vertical openings in successive floors, or floors and the roof.

**SHAFT ENCLOSURE.** The walls or construction forming the boundaries of a shaft.

**SMOKE DAMPER.** A listed device that is designed to resist the passage of air and smoke. The device is arranged to operate automatically, controlled by a smoke detection system, and when required, is capable of being positioned manually from a remote command station.

**SMOKE-DEVELOPED INDEX.** A numerical value assigned to a material tested in accordance with ASTM E 84.

**SOLID FUEL (COOKING APPLICATIONS).** Applicable to commercial food service operations only, solid fuel is any bulk material such as hardwood, mesquite, charcoal or briquettes that is combusted to produce heat for cooking operations.

**SOURCE CAPTURE SYSTEM.** A mechanical exhaust system designed and constructed to capture air contaminants at their source and to exhaust such contaminants to the outdoor atmosphere.

**STATIONARY FUEL CELL POWER PLANT.** A self-contained package or factory-matched packages which constitute an automatically operated assembly of integrated systems for generating useful electrical energy and recoverable thermal energy that is permanently connected and fixed in place.

**STEAM-HEATING BOILER.** A boiler operated at pressures not exceeding 15 psi (103 kPa) for steam.

**STOP VALVE.** A shutoff valve for controlling the flow of liquid or gases.

**STORY.** That portion of a building included between the upper surface of a floor and the upper surface of the floor next above, except that the topmost story shall be that portion of a building included between the upper surface of the topmost floor and the ceiling or roof above.

**STRENGTH, ULTIMATE.** The highest stress level that the component will tolerate without rupture.

**SUPPLY AIR.** That air delivered to each or any space supplied by the air distribution system or the total air delivered to all spaces supplied by the air distribution system, which is provided for ventilating, heating, cooling, humidification, dehumidification and other similar purposes.

**SUPPLY AIR SYSTEM.** An assembly of connected ducts, plenums, fittings, registers and grilles through which air, heated or cooled, is conducted from the supply unit to the space or spaces to be heated or cooled (see also "Return air system").

**THEORETICAL AIR.** The exact amount of air required to supply oxygen for complete combustion of a given quantity of a specific fuel.

**THERMAL RESISTANCE (R).** A measure of the ability to retard the flow of heat. The R-value is the reciprocal of thermal conductance.

**TLV-TWA (THRESHOLD LIMIT VALUE-TIME WEIGHTED AVERAGE).** The time-weighted average concentration of a refrigerant or other chemical in air for a normal 8-hour workday and a 40-hour workweek, to which nearly all workers are repeatedly exposed, day after

day, without adverse effects, as adopted by the American Conference of Government Industrial Hygienists (ACGIH).

**TOILET ROOM.** A room containing a water closet and, frequently, a lavatory, but not a bathtub, shower, spa or similar bathing fixture.

**TOXICITY CLASSIFICATION.** Refrigerants shall be classified for toxicity to one of two classes in accordance with ASHRAE 34.

**TRANSITION FITTINGS, PLASTIC TO STEEL.** An adapter for joining plastic pipe to steel pipe. The purpose of this fitting is to provide a permanent, pressure-tight connection between two materials which cannot be joined directly one to another.

**UNCONFINED SPACE.** A space having a volume not less than 50 cubic feet per 1,000 Btu/h (4.8m<sup>3</sup>/kW) of the aggregate input rating of all appliances installed in that space. Rooms communicating directly with the space in which the appliances are installed, through openings not furnished with doors, are considered a part of the unconfined space.

**UNIT HEATER.** A self-contained appliance of the fan type, designed for the delivery of warm air directly into the space in which the appliance is located.

**UNUSUALLY TIGHT CONSTRUCTION.** Construction meeting all of the following requirements:

1. Walls exposed to the outside atmosphere having a continuous water vapor retarder with a rating of 1 perm (57 ng/s • m<sup>2</sup> • Pa) or less with openings gasketed or sealed; and
2. Openable windows and doors meeting the air leakage requirements of the *Energy Conservation Construction Code of New York State*, Section 502.1.4; and
3. Caulking or sealants are applied to areas, such as joints around window and door frames, between sole plates and floors, between wall-ceiling joints, between wall panels, at penetrations for plumbing, electrical and gas lines, and at other openings.

**VENT.** A pipe or other conduit composed of factory-made components, containing a passageway for conveying combustion products and air to the atmosphere, listed and labeled for use with a specific type or class of appliance.

**Pellet vent.** A vent listed and labeled for use with listed pellet-fuel-burning appliances.

**Type L vent.** A vent listed and labeled for use with the following:

1. Oil-burning appliances that are listed for use with Type L vents.
2. Gas-fired appliances that are listed for use with Type B vents.

**VENT CONNECTOR.** The pipe that connects an approved fuel-fired appliance to a vent.

**VENT DAMPER DEVICE, AUTOMATIC.** A device intended for installation in the venting system, in the outlet of an individual automatically operated fuel-burning appliance that is designed to open the venting system automatically when the appliance is in operation and to close off the venting system automatically when the appliance is in a standby or shutdown condition.

**VENTILATION.** The natural or mechanical process of supplying conditioned or unconditioned air to, or removing such air from, any space.

**VENTILATION AIR.** That portion of supply air that comes from the outside (outdoors), plus any recirculated air that has been treated to maintain the desired quality of air within a designated space.

**VENTING SYSTEM.** A continuous open passageway from the flue collar of an appliance to the outside atmosphere for the purpose of removing flue or vent gases. A venting system is usually composed of a vent or a chimney and vent connector, if used, assembled to form the open passageway.

**WATER HEATER.** Any heating appliance or equipment that heats potable water and supplies such water to the potable hot water distribution system.

## **CHAPTER 3** **GENERAL REGULATIONS**

### **SECTION MC 301** **GENERAL**

**301.1 Scope.** This chapter shall govern the approval and installation of all equipment and appliances that comprise parts of the building mechanical systems regulated by this code in accordance with Section 101.2.

**301.2 Energy utilization.** Heating, ventilating and air-conditioning systems of all structures shall be designed and installed for efficient utilization of energy in accordance with the *Energy Conservation Construction Code of New York State*.

**301.3 Fuel gas appliances and equipment.** The approval and installation of fuel gas distribution piping and equipment, fuel gas-fired appliances and fuel gas-fired appliance venting systems shall be in accordance with the *New York City Fuel Gas Code*.

**301.4 Listed and labeled.** All appliances regulated by this code shall be listed and labeled.

**301.5 Testing of materials and equipment.** Refer to Section 28-113 of the *Administrative Code*.

**301.6 Label information.** A permanent factory-applied name-plate(s) shall be affixed to appliances on which shall appear in legible lettering, the manufacturer's name or trademark, the model number, serial number and the seal or mark of the approved agency. A label shall also include the following:

1. Electrical equipment and appliances: Electrical rating in volts, amperes and motor phase; identification of individual electrical components in volts, amperes or watts, motor phase; Btu/h (W) output; and required clearances.
2. Absorption units: Hourly rating in Btu/h (W); minimum hourly rating for units having step or automatic modulating controls; type of fuel; type of refrigerant; cooling capacity in Btu/h (W); and required clearances.
3. Fuel-burning units: Hourly rating in Btu/h (W); type of fuel approved for use with the appliance; and required clearances.
4. Electric comfort heating appliances: Name and trade-mark of the manufacturer; the model number or equivalent; the electric rating in volts, ampacity and phase; Btu/h (W) output rating; individual marking for each electrical component in amperes or watts, volts and phase; required clearances from combustibles; and a seal indicating approval of the appliance by an approved agency.

**301.7 Electrical.** Electrical wiring, controls and connections to equipment and appliances regulated by this code shall be in accordance with the *New York City Electrical Code*.

**301.8 Plumbing connections.** Potable water supply and building drainage system connections to equipment and appliances regulated by this code shall be in accordance with the *New York City Plumbing Code*.

**301.9 Fuel types.** Fuel-fired appliances shall be designed for use with the type of fuel to which they will be connected and the altitude at which they are installed. Appliances that comprise parts of the building mechanical system shall not be converted for the usage of a different fuel, except where approved and converted in accordance with the manufacturer's instructions. The fuel input rate shall not be increased or decreased beyond the limit rating for the altitude at which the appliance is installed.

**301.10 Vibration isolation.** Where vibration isolation of equipment and appliances is employed, supplemental restraint shall be used to accomplish the support and restraint.

**301.11 Repair.** Defective material or parts shall be replaced or repaired in such a manner so as to preserve the original approval or listing.

**301.12 Wind resistance.** Mechanical equipment, appliances and supports that are exposed to wind shall be designed and installed to resist the wind pressures determined in accordance with the *New York City Building Code*.



**301.13 Flood hazard.** For structures located in areas of special flood hazard, mechanical systems, equipment and appliances shall comply with Appendix G of the *New York City Building Code*.

**301.14 Rodent proofing.** Buildings or structures and the walls enclosing habitable or occupiable rooms and spaces in which persons live, sleep or work, or in which feed, food or foodstuffs are stored, prepared, processed, served or sold, shall be constructed to protect against the entrance of rodents in accordance with the *New York City Building Code*.

**301.15 Seismic resistance.** When earthquake loads are applicable in accordance with the *New York City Building Code*, mechanical system supports shall be designed and installed for the seismic forces in accordance with the *New York City Building Code*.

## **SECTION MC 302** **PROTECTION OF STRUCTURE**

**302.1 Structural safety.** The building or structure shall not be weakened by the installation of mechanical systems. Where floors, walls, ceilings or any other portion of the building or structure are required to be altered or replaced in the process of installing or repairing any system, the building or structure shall be left in a safe structural condition in accordance with the *New York City Building Code*.

**302.2 Penetrations of floor/ceiling assemblies and fire-resistance-rated assemblies.** Penetrations of floor/ceiling assemblies and assemblies required to have a fire-resistance rating shall be protected in accordance with the *New York City Building Code*.

**302.3 Cutting, notching and boring in wood framing.** The cutting, notching and boring of wood framing members shall comply with Sections 302.3.1 through 302.3.4.

**302.3.1 Joist notching.** Notches on the ends of joists shall not exceed one-fourth the joist depth. Holes bored in joists shall not be within 2 inches (51 mm) of the top or bottom of the joist, and the diameter of any such hole shall not exceed one-third the depth of the joist. Notches in the top or bottom of joists shall not exceed one-sixth the depth and shall not be located in the middle third of the span.

**302.3.2 Stud cutting and notching.** In exterior walls and bearing partitions, any wood stud is permitted to be cut or notched not to exceed 25 percent of its depth. Cutting or notching of studs not greater than 40 percent of their depth is permitted in nonbearing partitions supporting no loads other than the weight of the partition.

**302.3.3 Bored holes.** A hole not greater in diameter than 40 percent of the stud depth is permitted to be bored in any wood stud. Bored holes not greater than 60 percent of the depth of the stud are permitted in nonbearing partitions or in any wall where each bored stud is doubled, provided not more than two such successive doubled studs are so bored. In no case

shall the edge of the bored hole be nearer than 0.625 inch (15.9 mm) to the edge of the stud. Bored holes shall not be located at the same section of stud as a cut or notch.

**302.3.4 Engineered wood products.** Cuts, notches and holes bored in trusses, laminated veneer lumber, glue-laminated members and I-joists are prohibited except where the effects of such alterations are specifically considered in the design of the member.

**302.4 Alterations to trusses.** Truss members and components shall not be cut, drilled, notched, spliced or otherwise altered in any way without written concurrence and approval of a registered design professional. Alterations resulting in the addition of loads to any member (e.g., HVAC equipment, water heaters) shall not be permitted without verification that the truss is capable of supporting such additional loading.

**302.5 Cutting, notching and boring in steel framing.** The cutting, notching and boring of steel framing members shall comply with Sections 302.5.1 through 302.5.3.

**302.5.1 Cutting, notching and boring holes in structural steel framing.** The cutting, notching and boring of holes in structural steel framing members shall be as prescribed by the registered design professional.

**302.5.2 Cutting, notching and boring holes in cold-formed steel framing.** Flanges and lips of load-bearing cold-formed steel framing members shall not be cut or notched. Holes in webs of load-bearing cold-formed steel framing members shall be permitted along the centerline of the web of the framing member and shall not exceed the dimensional limitations, penetration spacing or minimum hole edge distance as prescribed by the registered design professional. Cutting, notching and boring holes of steel floor/roof decking shall be as prescribed by the registered design professional.

**302.5.3 Cutting, notching and boring holes in nonstructural cold-formed steel wall framing.** Flanges and lips of nonstructural cold-formed steel wall studs shall not be cut or notched. Holes in webs of nonstructural cold-formed steel wall studs shall be permitted along the center-line of the web of the framing member, shall not exceed 1.5 inches (38 mm) in width or 4 inches (102 mm) in length, and shall not be spaced less than 24 inches (610 mm) center to center from another hole or less than 10 inches (254 mm) from the bearing end.

## **SECTION MC 303** **EQUIPMENT AND APPLIANCE LOCATION**

**303.1 General.** Equipment and appliances shall be located as required by this section, specific requirements elsewhere in this code and the conditions of the equipment and appliance listing.

**303.2 Hazardous locations.** Appliances shall not be located in a hazardous location unless listed and approved for the specific installation.

**303.3 Prohibited locations.** Fuel-fired appliances shall not be located in, or obtain combustion air from, any of the following rooms or spaces:

1. Rooms occupied for sleeping purposes.
2. Bathrooms.
3. Toilet rooms.
4. Storage closets.
5. Surgical rooms.

**Exception:** This section shall not apply to the following appliances:

1. Direct-vent appliances that obtain all combustion air directly from the outdoors.
2. Solid fuel-fired appliances provided that the room is not a confined space and the building is not of unusually tight construction.
3. Appliances installed in a dedicated enclosure in which all combustion air is taken directly from the outdoors, in accordance with Section 703. Access to such enclosure shall be through a solid door, weather-stripped in accordance with the exterior door air leakage requirements of the *Energy Conservation Construction Code of New York State* and equipped with an approved self-closing device.

**303.4 Protection from damage.** Appliances shall not be installed in a location where subject to mechanical damage unless protected by suitable barriers.

**303.5 Indoor locations.** Fuel-fired furnaces and boilers installed in closets and alcoves shall be listed for such installation. For purposes of this section, a closet or alcove shall be defined as a room or space having a volume less than 12 times the total volume of fuel-fired appliances other than boilers and less than 16 times the total volume of boilers. Room volume shall be computed using the gross floor area and the actual ceiling height up to a maximum computation height of 8 feet (2438 mm).

**303.6 Outdoor locations.** Appliances installed in other than indoor locations shall be listed and labeled for outdoor installation.

**303.7 Pit locations.** Appliances installed in pits or excavations shall not come in direct contact with the surrounding soil. The sides of the pit or excavation shall be held back a minimum of 12 inches (305 mm) from the appliance. Where the depth exceeds 12 inches (305 mm) below adjoining grade, the walls of the pit or excavation shall be lined with concrete or masonry. Such concrete or masonry shall extend a minimum of 4 inches (102 mm) above adjoining grade and

shall have sufficient lateral load-bearing capacity to resist collapse. The appliance shall be protected from flooding.

**303.8 Elevator shafts.** Mechanical systems shall not be located in an elevator shaft.

## **SECTION MC 304** **INSTALLATION**

**304.1 General.** Equipment and appliances shall be installed as required by the terms of their approval, in accordance with the conditions of the listing, the manufacturer's installation instructions and this code. Manufacturer's installation instructions shall be available on the job site at the time of inspection.

**304.2 Conflicts.** Where conflicts between this code and the conditions of listing or the manufacturer's installation instructions occur, the provisions of this code shall apply.

**Exception:** Where a code provision is less restrictive than the conditions of the listing of the equipment or appliance or the manufacturer's installation instructions, the conditions of the listing and the manufacturer's installation instructions shall apply.

**304.3 Elevation of ignition source.** Equipment and appliances having an ignition source and located in hazardous locations and public garages, private garages, repair garages, automotive motor-fuel-dispensing facilities and parking garages shall be elevated such that the source of ignition is not less than 18 inches (457 mm) above the floor surface on which the equipment or appliance rests. Such equipment and appliances shall not be installed in Group H occupancies or control areas where open use, handling or dispensing of combustible, flammable or explosive materials occurs. For the purpose of this section, rooms or spaces that are not part of the living space of a dwelling unit and that communicate directly with a private garage through openings shall be considered to be part of the private garage.

**304.4 Hydrogen generating and refueling operations.** Hydrogen generation and refueling operations shall be prohibited except as permitted by the Commissioner of the Fire Department.

**304.5 Public garages.** Appliances located in public garages, motor fuel dispensing facilities, repair garages or other areas frequented by motor vehicles, shall be installed a minimum of 8 feet (2438 mm) above the floor. Where motor vehicles exceed 6 feet (1829 mm) in height and are capable of passing under an appliance, appliances shall be installed a minimum of 2 feet (610 mm) higher above the floor than the height of the tallest vehicle.

**Exception:** The requirements of this section shall not apply where the appliances are protected from motor vehicle impact and installed in accordance with Section 304.3 and NFPA 88B.

**304.6 Private garages.** Appliances located in private garages and carports shall be installed with a minimum clearance of 6 feet (1829 mm) above the floor.

**Exception:** The requirements of this section shall not apply where the appliances are protected from motor vehicle impact and installed in accordance with Section 304.3.

**304.7 Construction and protection.** Boiler rooms and furnace rooms shall be protected as required by the *New York City Building Code*.

**304.8 Clearances to combustible construction.** Heat-producing equipment and appliances shall be installed to maintain the required clearances to combustible construction as specified in the listing and manufacturer's instructions. Such clearances shall be reduced only in accordance with Section 308. Clearances to combustibles shall include such considerations as door swing, drawer pull, overhead projections or shelving and window swing, shutters, coverings and drapes. Devices such as doorstops or limits, closers, drapery ties or guards shall not be used to provide the required clearances.

**304.9 Clearances from grade.** Equipment and appliances installed at grade level shall be supported on a level concrete slab or other approved material extending above adjoining grade or shall be suspended a minimum of 6 inches (152 mm) above adjoining grade.

**304.10 Guards.** Guards shall be provided where appliances, equipment, fans or other components that require service are located within 10 feet (3048 mm) of a roof edge or open side of a walking surface and such edge or open side is located more than 30 inches (762 mm) above the floor, roof or grade below. The guard shall extend not less than 30 inches (762 mm) beyond each end of such appliance, equipment, fan or component and the top of the guard shall be located not less than 42 inches (1067 mm) above the elevated surface adjacent to the guard. The guard shall be constructed so as to prevent the passage of a 21-inch-diameter (533 mm) sphere and shall comply with the loading requirements for guards specified in the *New York City Building Code*.

**304.11 Area served.** Appliances serving different areas of a building other than where they are installed shall be permanently marked in an approved manner that uniquely identifies the appliance and the area it serves.

## **SECTION MC 305** **PIPING SUPPORT**

**305.1 General.** All mechanical system piping shall be supported in accordance with this section.

**305.2 Materials.** Pipe hangers and supports shall have sufficient strength to withstand all anticipated static and specified dynamic loading conditions associated with the intended use. Pipe hangers and supports that are in direct contact with piping shall be of materials that are compatible with the piping and that will not promote galvanic action.

**305.3 Structural attachment.** Hangers and anchors shall be attached to the building structure.

**305.4 Interval of support.** Piping shall be supported at distances not exceeding the spacing specified in Table 305.4, or in accordance with MSS SP-69.

**TABLE 305.4**  
**PIPING SUPPORT SPACING**  
**(Table 305.4 attached to end of document)**

**305.5 Protection against physical damage.** In concealed locations where piping, other than cast-iron or steel, is installed through holes or notches in studs, joists, rafters or similar members less than 1.5 inches (38 mm) from the nearest edge of the member, the pipe shall be protected by shield plates. Protective shield plates shall be a minimum of 0.062-inch-thick (1.6 mm) steel, shall cover the area of the pipe where the member is notched or bored, and shall extend a minimum of 2 inches (51mm) above sole plates and below top plates.

**SECTION MC 306**  
**ACCESS AND SERVICE SPACE**

**306.1 Clearances for maintenance and replacement.** Clearances around appliances to elements of permanent construction, including other installed equipment and appliances, shall be sufficient to allow inspection, service, repair or replacement without removing such elements of permanent construction or disabling the function of a required fire-resistance-rated assembly.

**306.1.1 Central furnaces.** Central furnaces within compartments or alcoves shall have a minimum working space clearance of 3 inches (76 mm) along the sides, back and top with a total width of the enclosing space being at least 12 inches (305 mm) wider than the furnace. Furnaces having a firebox open to the atmosphere shall have at least 6 inches (152 mm) working space along the front combustion chamber side. Combustion air openings at the rear or side of the compartment shall comply with the requirements of Chapter 7.

**Exception:** This section shall not apply to replacement appliances installed in existing compartments and alcoves where the working space clearances are in accordance with the equipment or appliance manufacturer's installation instructions.

**306.2 Appliances in rooms.** Rooms containing appliances requiring access shall be provided with a door and an unobstructed passageway measuring not less than 36 inches (914 mm) wide and 80 inches (2032 mm) high.

**Exception:** Within a dwelling unit, appliances installed in a compartment, alcove, basement or similar space shall be accessed by an opening or door and an unobstructed passageway measuring not less than 24 inches (610 mm) wide and large enough to allow removal of the largest appliance in the space, provided that a level service space of not less than 30 inches (762 mm) deep and the height of the appliance, but not less than 30 inches (762 mm), is present at the front or service side of the appliance with the door open.

**306.3 Appliances in attics.** Attics containing appliances requiring access shall be provided with an opening and unobstructed passageway large enough to allow removal of the largest appliance. The passageway shall not be less than 30 inches (762 mm) high and 22 inches (559 mm) wide and not more than 20 feet (6096 mm) in length measured along the centerline of the passageway from the opening to the appliance. The passageway shall have continuous solid flooring not less than 24 inches (610 mm) wide. A level service space not less than 30 inches (762 mm) deep and 30 inches (762 mm) wide shall be present at the front or service side of the appliance. The clear access opening dimensions shall be a minimum of 20 inches by 30 inches (508 mm by 762 mm), where such dimensions are large enough to allow removal of the largest appliance.

**Exception:** The passageway and level service space are not required where the appliance is capable of being serviced and removed through the required opening.

**306.3.1 Electrical requirements.** A lighting fixture controlled by a switch located at the required passageway opening and a receptacle outlet shall be provided at or near the appliance location in accordance with the *New York City Electrical Code*.

**306.4 Appliances under floors.** Underfloor spaces containing appliances requiring access shall be provided with an access opening and unobstructed passageway large enough to remove the largest appliance. The passageway shall not be less than 30 inches (762 mm) high and 22 inches (559 mm) wide, nor more than 20 feet (6096 mm) in length measured along the centerline of the passageway from the opening to the appliance. A level service space not less than 30 inches (762 mm) deep and 30 inches (762 mm) wide shall be present at the front or service side of the appliance. If the depth of the passageway or the service space exceeds 12 inches (305 mm) below the adjoining grade, the walls of the passageway shall be lined with concrete or masonry. Such concrete or masonry shall extend a minimum of 4 inches (102 mm) above the adjoining grade and shall have sufficient lateral-bearing capacity to resist collapse. The clear access opening dimensions shall be a minimum of 22 inches by 30 inches (559 mm by 762 mm), where such dimensions are large enough to allow removal of the largest appliance.

**Exception:** The passageway is not required where the level service space is present when the access is open and the appliance is capable of being serviced and removed through the required opening.

**306.4.1 Electrical requirements.** A lighting fixture controlled by a switch located at the required passageway opening and a receptacle outlet shall be provided at or near the appliance location in accordance with the *New York City Electrical Code*.

**306.5 Equipment and appliances on roofs or elevated structures.** Where equipment and appliances requiring access are installed on roofs or elevated structures at a height exceeding 16 feet (4877 mm), such access shall be provided by a permanent means of access, the extent of which shall be from grade or floor level to the equipment and appliances' level service space. Such access shall not require climbing over obstructions greater than 30 inches (762 mm) high or walking on roofs having a slope greater than 4 units vertical in 12 units horizontal (33-percent slope).

Permanent ladders installed to provide the required access shall comply with the following minimum design criteria:

1. The side railing shall extend above the parapet or roof edge not less than 30 inches (762 mm).
2. Ladders shall have rung spacing not to exceed 14 inches (356 mm) on center.
3. Ladders shall have a toe spacing not less than 6 inches (152 mm) deep.
4. There shall be a minimum of 18 inches (457 mm) between rails.
5. Rungs shall have a minimum 0.75 inch (19.1 mm) diameter and be capable of withstanding a 300-pound (136.1 kg) load.
6. Ladders over 30 feet (9144 mm) in height shall be provided with offset sections and landings capable of withstanding 100 pounds (488.2 kg/m<sup>2</sup>) per square foot.
7. Ladders shall be protected against corrosion.

Catwalks installed to provide the required access shall be not less than 24 inches (610mm) wide and shall have railings as required for service platforms.

**Exception:** This section shall not apply to Group R-3 occupancies.

**306.6 Sloped roofs.** Where appliances are installed on a roof having a slope of 3 units vertical in 12 units horizontal (25-percent slope) or greater and having an edge more than 30 inches (762 mm) above grade at such edge, a level platform shall be provided on each side of the appliance to which access is required by the manufacturer's installation instructions for service, repair or maintenance. The platform shall not be less than 30 inches (762 mm) in any dimension and shall be provided with guards in accordance with Section 304.10.

## **SECTION MC 307** **CONDENSATE DISPOSAL**

**307.1 Fuel-burning appliances.** Liquid combustion by-products of condensing appliances shall be collected and discharged to a plumbing fixture or disposal area in accordance with the manufacturer's installation instructions. Condensate piping shall be of corrosion-resistant material and shall not be smaller than the drain connection on the appliance. Such piping shall maintain a minimum horizontal slope in the direction of discharge of not less than 1/8 unit vertical in 12 units horizontal (1-percent slope).



**307.2 Evaporators and cooling coils.** Condensate drain systems shall be provided for equipment and appliances containing evaporators or cooling coils. Condensate drain systems shall be designed, constructed and installed in accordance with Sections 307.2.1 through 307.2.4.

**307.2.1 Condensate disposal.** Condensate from all cooling coils and evaporators shall be conveyed from the drain pan outlet to a place of disposal. Condensate shall not discharge into a street, alley or other areas so as to cause a nuisance.

**307.2.2 Drain pipe materials and sizes.** Components of the condensate disposal system shall be cast iron, galvanized steel, copper, cross-linked polyethylene, polyethylene, ABS, CPVC or PVC pipe or tubing. All components shall be selected for the pressure and temperature rating of the installation. Condensate waste and drain line size shall be not less than ¾ inch (19 mm) internal diameter and shall not decrease in size from the drain pan connection to the place of condensate disposal. Where the drain pipes from more than one unit are manifolded together for condensate drainage, the pipe or tubing shall be sized accordingly. All horizontal sections of drain piping shall be installed in uniform alignment at a uniform slope.

**307.2.3 Auxiliary and secondary drain systems.** In addition to the requirements of Section 307.2.1, a secondary drain or auxiliary drain pan shall be required for each cooling or evaporator coil where damage to any building components will occur as a result of overflow from the equipment drain pan or stoppage in the condensate drain piping. One of the following methods shall be used:

1. An auxiliary drain pan with a separate drain shall be provided under the coils on which condensation will occur. The auxiliary pan drain shall discharge to a conspicuous point of disposal to alert occupants in the event of a stoppage of the primary drain. The pan shall have a minimum depth of 1.5 inches (38 mm), shall not be less than 3 inches (76 mm) larger than the unit or the coil dimensions in width and length and shall be constructed of corrosion-resistant material. Metallic pans shall have a minimum thickness of not less than 0.0276-inch (0.7 mm) galvanized sheet metal. Nonmetallic pans shall have a minimum thickness of not less than 0.0625 inch (1.59 mm).
2. A separate overflow drain line shall be connected to the drain pan provided with the equipment. Such overflow drain shall discharge to a conspicuous point of disposal to alert occupants in the event of a stoppage of the primary drain. The overflow drain line shall connect to the drain pan at a higher level than the primary drain connection.
3. An auxiliary drain pan without a separate drain line shall be provided under the coils on which condensate will occur. Such pan shall be equipped with a water-level detection device that will shut off the equipment served prior to overflow of the pan. The auxiliary drain pan shall be constructed in accordance with Item 1 of this section.

**307.2.4 Traps.** Condensate drains shall be trapped as required by the equipment or appliance manufacturer.

**307.3 Exceptions.** This section applies to permanently installed equipment. Window units and through-the-wall air-conditioning units are exempt from the requirements of this section.

## **SECTION MC 308** **CLEARANCE REDUCTION**

**308.1 Scope.** This section shall govern the reduction in required clearances to combustible materials and combustible assemblies for chimneys, vents, kitchen exhaust equipment, mechanical appliances, and mechanical devices and equipment.

**308.2 Listed appliances and equipment.** The reduction of the required clearances to combustibles for listed and labeled appliances and equipment shall be in accordance with the requirements of this section except that such clearances shall not be reduced where reduction is specifically prohibited by the terms of the appliance or equipment listing.

**308.3 Protective assembly construction and installation.** Reduced clearance protective assemblies, including structural and support elements, shall be constructed of noncombustible materials. Spacers utilized to maintain an airspace between the protective assembly and the protected material or assembly shall be noncombustible. Where a space between the protective assembly and protected combustible material or assembly is specified, the same space shall be provided around the edges of the protective assembly and the spacers shall be placed so as to allow air circulation by convection in such space. Protective assemblies shall not be placed less than 1 inch (25 mm) from the mechanical appliances, devices or equipment, regardless of the allowable reduced clearance.

**308.4 Allowable reduction.** The reduction of required clearances to combustible assemblies or combustible materials shall be based on the utilization of a reduced clearance protective assembly in accordance with Section 308.5 or 308.6.

**308.5 Labeled assemblies.** The allowable clearance reduction shall be based on a reduced clearance protective assembly that has been tested and bears the label of an approved agency.

**308.6 Reduction table.** The allowable clearance reduction shall be based on one of the methods specified in Table 308.6. Where required clearances are not listed in Table 308.6, the reduced clearances shall be determined by linear interpolation between the distances listed in the table. Reduced clearances shall not be derived by extrapolation below the range of the table.

### **TABLE 308.6** **CLEARANCE REDUCTION METHODS** **(Table 308.6 attached to end of document)**

**308.7 Solid fuel-burning appliances.** The clearance reduction methods specified in Table 308.6 shall not be utilized to reduce the clearance required for solid fuel-burning appliances that are labeled for installation with clearances of 12 inches (305 mm) or less. Where appliances are

labeled for installation with clearances of greater than 12 inches (305 mm), the clearance reduction methods of Table 308.6 shall not reduce the clearance to less than 12 inches (305 mm).

**308.8 Masonry chimneys.** The clearance reduction methods specified in Table 308.6 shall not be utilized to reduce the clearances required for masonry chimneys as specified in Chapter 8 and the *New York City Building Code*.

**308.9 Chimney connector pass-throughs.** The clearance reduction methods specified in Table 308.6 shall not be utilized to reduce the clearances required for chimney connector pass-throughs as specified in Section 803.10.4.

**308.10 Masonry fireplaces.** The clearance reduction methods specified in Table 308.6 shall not be utilized to reduce the clearances required for masonry fireplaces as specified in Chapter 8 and the *New York City Building Code*.

**308.11 Kitchen exhaust ducts.** The clearance reduction methods specified in Table 308.6 shall not be utilized to reduce the minimum clearances required by Section 506.3.10 for kitchen exhaust ducts enclosed in a shaft.

### **SECTION MC 309** **TEMPERATURE CONTROL**

**309.1 Space-heating systems.** Interior spaces intended for human occupancy shall be provided with active or passive space-heating systems capable of maintaining a minimum indoor temperature of 68°F (20°C) at a point 3 feet (914 mm) above floor on the design heating day. The installation of portable space heaters shall not be used to achieve compliance with this section. Refer to Section 1204 of the *New York City Building Code*.

**Exception:** Interior spaces where the primary purpose is not associated with human comfort.

### **SECTION MC 310** **EXPLOSION CONTROL**

**310.1 Required.** Structures occupied for purposes involving explosion hazards shall be provided with explosion control in compliance with rules of the Commissioner of the Fire Department. Explosion control systems shall be designed and installed in accordance with the *New York City Fire Code*.

### **SECTION MC 311** **SMOKE AND HEAT VENTS**

**311.1 Required.** Approved smoke and heat vents shall be installed in the roofs of one-story buildings where required by the *New York City Fire Code*. Smoke and heat vents shall be designed and installed in accordance with the *New York City Fire Code*.

**SECTION MC 312**  
**HEATING AND COOLING LOAD CALCULATIONS**

**312.1 Load calculations.** Heating and cooling system design loads for the purpose of sizing systems, appliances and equipment shall be determined in accordance with the procedures described in the ASHRAE Handbook of Fundamentals. Heating and cooling loads shall be adjusted to account for load reductions that are achieved when energy recovery systems are utilized in the HVAC system in accordance with the ASHRAE Handbook - HVAC Systems and Equipment. Alternatively, design loads shall be determined by an approved equivalent computation procedure, using the design parameters specified in Chapter 3 of the *Energy Conservation Construction Code of New York State*. Heating and cooling system design loads for the purpose of sizing systems, appliances and equipment shall also comply with the requirements of Section 1204 of the *New York City Building Code*.

**CHAPTER 4**  
**VENTILATION**

**SECTION MC 401**  
**GENERAL**

**401.1 Scope.** This chapter shall govern the ventilation of spaces within a building intended to be occupied. This chapter does not govern the requirements for smoke control systems. See Section 513 of this code.

**401.2 Ventilation required.** Every occupied space shall be ventilated by natural means in accordance with Section 402 or by mechanical means in accordance with Section 403.

**401.3 When required.** Ventilation shall be provided during the periods that the room or space is occupied.

**401.4 Exits.** Equipment and ductwork for exit enclosure ventilation shall comply with one of the following items:

- 1.** Such equipment and ductwork shall be located exterior to the building and shall be directly connected to the exit enclosure by ductwork enclosed in construction as required by the *New York City Building Code* for shafts.
- 2.** Where such equipment and ductwork is located within the exit enclosure, the intake air shall be taken directly from the outdoors and the exhaust air shall be discharged directly to the outdoors, or such air shall be conveyed through ducts enclosed in construction as required by the *New York City Building Code* for shafts.
- 3.** Where located within the building, such equipment and ductwork shall be separated from the remainder of the building, including other mechanical equipment, with construction as required by the *New York City Building Code* for shafts.

In each case, openings into fire-resistance-rated construction shall be limited to those needed for maintenance and operation and shall be protected by self-closing fire-resistance-rated devices in accordance with the *New York City Building Code* for enclosure wall opening protectives.

Exit enclosure ventilation systems shall be independent of other building ventilation systems.

**401.5 Opening location.** Outside air exhaust and intake openings shall be located a minimum of 10 feet (3048 mm) from lot lines or buildings on the same lot. Where openings front on a street or public way, the distance shall be measured to the centerline of the street or public way. Outdoor intakes for high-rise office buildings having occupied floors located more than 75 feet (22 860 mm) above the lowest level of fire department vehicle access serving spaces above the second story and serving spaces greater than 10, 000 square feet (929 square meters) of floor area shall be located at least 20 feet (6096 mm) above ground level, at least 30 feet (9144 mm) from exhaust outlets and other exhaust discharges, and at least 20 feet (6096 mm) from areas that may collect vehicular exhaust, such as off street loading bays.

**Exception: Group R-3.**

**401.5.1 Intake openings.** Mechanical and gravity outside air intake openings, shall be located a minimum of 20 feet (6096 mm) from any hazardous or noxious contaminant such as vents, chimneys, plumbing vents, streets, alleys, parking lots and loading docks, except as otherwise specified in this code. Where a source of contaminant is located within 20 feet (6096 mm) of an intake opening, such opening shall be located a minimum of 2 feet (610 mm) below the contaminant source.

An outdoor air intake opening with gross area of more than 144 square inches (.0929 m<sup>2</sup>) shall be provided with fire dampers and smoke dampers, or combined fire and smoke dampers when such opening is located as follows:

1. Less than 30 feet (9144 mm) above grade.
2. Less than 30 feet (9144 mm) in any direction from any opening in another building.
3. Less than 15 feet (4572 mm) from a lot line.
4. Less than 50 feet (15 240 mm) above and less than 50 feet (15 240 mm) in any direction from a roof constructed of combustible material or a building in which the exterior walls are constructed wholly or partly of wood.

**Exceptions:**

1. Smoke dampers shall not be required for outdoor air intake openings installed in any construction required to have a fire resistance rating that is less than two hours.

2. Smoke dampers shall not be required for outdoor air intake openings of systems greater than 15,000 cfm (7.1 m<sup>3</sup>/s) which are provided with smoke dampers in accordance with Chapter 6 of this code and arranged so as to not introduce smoke into the building or space in which the equipment is located.

**401.5.2 Exhaust openings.** To minimize the hazard from fires and from noxious, toxic or obnoxious discharges to structures, any exhaust air discharge to the outside atmosphere shall terminate at or above the roof or setback roof of the buildings or in an exterior wall adjoining a street, yard or court. Exhaust air discharges shall be at least 10 feet (3048 mm) above the sidewalk or ground and shall terminate at least 10 feet (3048 mm) from any window in another building or from any window in a residential portion of the same building, or from any fire escape, exterior stair, or balcony. Exhaust system openings shall be provided with vanes or louvers constructed so as to direct the air away from windows, other openings, and pedestrians.

**Exception:** In occupancy groups R-2 and R-3 each dwelling unit may be individually exhausted directly to the outdoors with a dedicated, continuously operated exhaust fan and shall comply with the following:

1. The exhaust system for the kitchen and the toilet/baths may be combined to the inlet of a single fan, provided such exhaust system serves only one dwelling unit.
2. The dedicated exhaust from each dwelling unit shall be directed away from any window serving the same dwelling unit from which the exhaust is taken, and in addition, such exhaust opening shall terminate at least:
  - 2.1. 2 feet (610 mm) from any window serving the same dwelling unit.
  - 2.2. 4 feet (1219 mm) from any window serving an adjoining dwelling unit.
  - 2.3. 4 feet (1219 mm) from any window serving another occupancy group in the same building.
  - 2.4. 10 feet (3048 mm) from any outdoor air intake opening.
  - 2.5. 10 feet (3048 mm) above the public sidewalk adjoining the same building.
3. All other minimum distances described in 401.5 shall be met.

**401.5.3 Flood hazard.** For structures located in areas of special flood hazard, outdoor exhaust openings shall comply with Appendix G of the *New York City Building Code*.

**401.6 Outdoor opening protection.** Air exhaust and intake openings that terminate outdoors shall be protected with corrosion-resistant screens, louvers or grilles. Openings in louvers, grilles and screens shall be sized in accordance with Table 401.6, and shall be protected against local weather

conditions. Outdoor air exhaust and intake openings located in exterior walls shall meet the provisions for exterior wall opening protectives in accordance with the *New York City Building Code*.

**TABLE 401.6**  
**OPENING SIZES IN LOUVERS, GRILLES AND**  
**SCREENS PROTECTING OUTDOOR EXHAUST AND**  
**AIR INTAKE OPENINGS**

**(Table 401.6 attached to end of document)**

**401.7 Contaminant sources.** Stationary local sources producing air-borne particulates, heat, odors, fumes, spray, vapors, smoke or gases in such quantities as to be irritating or injurious to health shall be provided with an exhaust system in accordance with Chapter 5 or a means of collection and removal of the contaminants. Such exhaust shall discharge directly to an approved location at the exterior of the building.

**SECTION MC 402**  
**NATURAL VENTILATION**

**402.1 General.** Natural ventilation of an occupied space shall comply with Chapter 12 of the *New York City Building Code*.

**402.2 Reserved.**

**402.3 Reserved.**

**402.4 Reserved.**

**SECTION MC 403**  
**MECHANICAL VENTILATION**

**403.1 Ventilation system.** Mechanical ventilation shall be provided by a method of supply air and return or exhaust air. The amount of supply air shall be approximately equal to the amount of return and exhaust air. The system shall not be prohibited from producing negative or positive pressure. The system to convey ventilation air shall be designed and installed in accordance with Chapter 6.

Ventilation supply systems shall be designed to deliver the required rate of supply air to the occupied zone within an occupied space. The occupied zone shall have boundaries measured at 3 inches (76 mm) and 72 inches (1829 mm) above the floor and 24 inches (610 mm) from the enclosing walls.

**403.2 Outdoor air required.** The minimum ventilation rate of required outdoor air shall be determined in accordance with Section 403.3.

**403.2.1 Recirculation of air.** The air required by Section 403.3 shall not be recirculated. Air in excess of that required by Section 403.3 shall not be prohibited from being recirculated as a component of supply air to building spaces, except that:

1. Ventilation air shall not be recirculated from one dwelling unit to another or to dissimilar occupancies.
2. Supply air to a swimming pool and associated deck areas shall not be recirculated unless such air is dehumidified to maintain the relative humidity of the area at 60 percent or less. Air from this area shall not be recirculated to other spaces.
3. Where mechanical exhaust is required by Table 403.3, recirculation of air from such spaces shall be prohibited. All air supplied to such spaces shall be exhausted, including any air in excess of that required by Table 403.3.

**403.2.2 Transfer air.** Except where recirculation from such spaces is prohibited by Table 403.3, air transferred from occupied spaces is not prohibited from serving as makeup air for required exhaust systems in such spaces as kitchens, baths, toilet rooms, elevators and smoking lounges. The amount of transfer air and exhaust air shall be sufficient to provide the flow rates as specified in Sections 403.3 and 403.3.1. The required outdoor air rates specified in Table 403.3 shall be introduced directly into such spaces or into the occupied spaces from which air is transferred or a combination of both.

**403.3 Ventilation rate.** Ventilation systems shall be designed to have the capacity to supply the minimum outdoor airflow rate determined in accordance with Table 403.3 based on the occupancy of the space and the occupant load or other parameter as stated therein. The occupant load utilized for design of the ventilation system shall not be less than the number determined from the estimated maximum occupant load rate indicated in Table 403.3. Ventilation rates for occupancies not represented in Table 403.3 shall be determined by an approved engineering analysis. The ventilation system shall be designed to supply the required rate of ventilation air continuously during the period the building is occupied, except as otherwise stated in other provisions of the code.

**Exception:** The occupant load is not required to be determined, based on the estimated maximum occupant load rate indicated in Table 403.3, where approved statistical data document the accuracy of an alternate anticipated occupant density.

**TABLE 403.3**  
**REQUIRED OUTDOOR VENTILATION AIR**  
**(Table 403.3 attached to end of document)**

**403.3.1 System operation.** The minimum flow rate of outdoor air that the ventilation system must be capable of supplying during its operation shall be permitted to be based on the rate per person indicated in Table 403.3 and the actual number of occupants present. Intermittent



exhaust shall be permitted where an individual exhaust duct and fan are provided and the operation of the fan is controlled by occupants of the space being vented.

**403.3.2 Common ventilation system.** Where spaces having different ventilation rate requirements are served by a common ventilation system, the ratio of outdoor air to total supply air for the system shall be determined based on the space having the largest outdoor air requirement or shall be determined in accordance with the following formula:

**(Equation 4-1 attached to end of document)**

**403.3.3 Variable air volume system control.** Variable air volume air distribution systems, other than those designed to supply only 100-percent outdoor air, shall be provided with controls to regulate the flow of outdoor air. Such control systems shall be designed to maintain the flow of outdoor air at a rate of not less than that required by Section 403 over the entire range of supply air operating rates.

**403.3.4 Balancing.** Ventilation systems shall be balanced by an approved method. Such balancing shall verify that the ventilation system is capable of supplying the airflow rates required by Section 403.

## **SECTION MC 404** **ENCLOSED PARKING GARAGES**

**404.1 Enclosed parking garages.** Mechanical ventilation systems for enclosed parking garages are not required to operate continuously where the system is arranged to operate automatically upon detection of a concentration of carbon monoxide of 25 parts per million (ppm) by approved automatic detection devices.

**404.2 Minimum ventilation.** Automatic operation of the system shall not reduce the ventilation rate below 0.05 cfm per square foot ( $0.00025\text{m}^3/\text{s} \cdot \text{m}^2$ ) of the floor area and the system shall be capable of producing a ventilation rate of 1.5 cfm per square foot ( $0.0076\text{m}^3/\text{s} \cdot \text{m}^2$ ) of floor area.

**404.3 Occupied spaces accessory to public garages.** Connecting offices, waiting rooms, ticket booths and similar uses that are accessory to a public garage shall be maintained at a positive pressure and shall be provided with ventilation in accordance with Section 403.3.

## **SECTION MC 405** **SYSTEMS CONTROL**

**405.1 General.** Mechanical ventilation systems shall be provided with manual or automatic controls that will operate such systems whenever the spaces are occupied. Air-conditioning systems that supply required ventilation air shall be provided with controls designed to automatically maintain the required outdoor air supply rate during occupancy.

**405.2 Manual control.** Each air distribution system shall be provided with not less than one manual control to stop the operation of the supply, return, and exhaust fans(s) in an emergency. The manual control shall be provided at an approved location.

**405.2.1 Office buildings.** Any building classified in occupancy group B having occupied floors located more than 75 feet (22 860 mm) above the lowest level of fire department vehicle access, where a system serves a floor or floors other than the floor on which the equipment is located, shall be provided with the following controls, in addition to the controls required by this chapter:

1. Manual controls for operating individually each air supply and each exhaust or return fan in the system located as follows:
  - 1.1. At the Fire Command Center, and
  - 1.2. In the room containing the affected air-handling fans.
2. Manual controls for operating individually or in groups each remote control reversible fire shutter, when such shutters are provided in accordance with the provisions of the *New York City Building Code*, or each smoke damper provided in accordance with the provisions of the *New York City Building Code*. Such controls shall be located at the Fire Command Center.

## **SECTION MC 406** **VENTILATION OF UNINHABITED SPACES**

**406.1 General.** Uninhabited spaces, such as crawl spaces and attics, shall be provided with natural ventilation openings as required by the *New York City Building Code* or shall be provided with a mechanical exhaust and supply air system. The mechanical exhaust rate shall be not less than 0.02 cfm per square foot ( $0.00001 \text{ m}^3/\text{s} \cdot \text{m}^2$ ) of horizontal area and shall be automatically controlled to operate when the relative humidity in the space served exceeds 60 percent.

## **SECTION MC 407** **VENTILATION OF NON-PRODUCTION CHEMICAL LABORATORIES**

**407.1 General.** Non-production chemical laboratories complying with the hazardous materials quantity limitations of Section 419 of the *New York City Building Code* shall provide a mechanical ventilation system in accordance with this code and NFPA 45, except that ducts constructed of combustible materials shall not be permitted.

## **CHAPTER 5** **EXHAUST SYSTEMS**

**SECTION MC 501**  
**GENERAL**

**501.1 Scope.** This chapter shall govern the design, construction and installation of mechanical exhaust systems, including dust, stock and refuse conveyor systems, exhaust systems serving commercial cooking appliances and energy recovery ventilation systems.

**501.2 Outdoor discharge.** The air removed by every mechanical exhaust system shall be discharged outdoors at a point where it will not cause a nuisance and from which it cannot again be readily drawn in by a ventilating system. Air shall not be exhausted into an attic or crawl space.

**Exception:** Whole-house ventilation-type attic fans that discharge into the attic space of dwelling units having private attics.

**501.3 Pressure equalization.** Mechanical exhaust systems shall be sized to remove the quantity of air required by this chapter to be exhausted. The system shall operate when air is required to be exhausted. Where mechanical exhaust is required in a room or space in other than occupancies in Group R-3, such space shall be maintained with a neutral or negative pressure. If a greater quantity of air is supplied by a mechanical ventilating supply system than is removed by a mechanical exhaust system for a room, adequate means shall be provided for the natural exit of the excess air supplied. If only a mechanical exhaust system is installed for a room or if a greater quantity of air is removed by a mechanical exhaust system than is supplied by a mechanical ventilating supply system for a room, adequate means shall be provided for the natural supply of the deficiency in the air supplied.

**501.4 Ducts.** Where exhaust duct construction is not specified in this chapter, such construction shall comply with Chapter 6 of this code.

**501.5 Independent system required.**

1. Single or combined mechanical exhaust systems from bath, toilet, urinal, locker, service sink closets and similar rooms shall be independent of all other exhaust systems, except as permitted in Section 401.5.2.
2. A separate grease duct system shall be provided for each Type I hood except as provided in Section 506.3.5.
3. Hazardous exhaust systems shall be independent of other types of exhaust systems as provided in Section 510.

**SECTION MC 502**  
**REQUIRED SYSTEMS**

**502.1 General.** An exhaust system shall be provided, maintained and operated as specifically required by this section and for all occupied areas where machines, vats, tanks, furnaces, forges,

salamanders and other appliances, equipment and processes in such areas produce or throw off dust or particles sufficiently light to float in the air, or which emit heat, odors, fumes, spray, gas or smoke, in such quantities so as to be irritating or injurious to health or safety.

**502.1.1 Exhaust location.** The inlet to an exhaust system shall be located in the area of heaviest concentration of contaminants.

**502.1.2 Fuel-dispensing areas.** The bottom of an air inlet or exhaust opening in fuel-dispensing areas shall be located not more than 18 inches (457 mm) above the floor.

**502.1.3 Equipment, appliance and service rooms.** Equipment, appliance and system service rooms that house sources of odors, fumes, noxious gases, smoke, steam, dust, spray or other contaminants shall be designed and constructed so as to prevent spreading of such contaminants to other occupied parts of the building.

**502.1.4 Hazardous exhaust.** The mechanical exhaust of high concentrations of dust or hazardous vapors shall conform to the requirements of Section 510.

**502.2 Aircraft fueling and defueling.** Compartments housing piping, pumps, air eliminators, water separators, hose reels and similar equipment used in aircraft fueling and defueling operations shall be adequately ventilated at floor level or within the floor itself.

**502.3 Battery-charging areas.** Ventilation shall be provided in an approved manner in battery-charging areas to prevent a dangerous accumulation of flammable gases.

**502.4 Stationary lead-acid battery systems.** Ventilation shall be provided for stationary lead-acid battery systems in accordance with this chapter and Section 502.4.1 or 502.4.2.

**502.4.1 Hydrogen limit.** The ventilation system shall be designed to limit the maximum concentration of hydrogen to 1.0 percent of the total volume of the room.

**502.4.2 Ventilation rate.** Continuous ventilation shall be provided at a rate of not less than 1 cubic foot per minute per square foot (cfm/ft<sup>2</sup>) [0.00508 m<sup>3</sup>/(s · m<sup>2</sup>)] of floor area of the room.

**502.5 Valve-regulated lead-acid batteries.** Valve-regulated lead-acid battery systems as regulated by the *New York City Fire Code*, shall be provided with ventilation in accordance with Section 502.5.1 or 502.5.2 for rooms and in accordance with Section 502.5.3 or 502.5.4 for cabinets.

**502.5.1 Hydrogen limit in rooms.** The ventilation system shall be designed to limit the maximum concentration of hydrogen to 1.0 percent of the total volume of the room during the worst-case event of simultaneous boost charging of all batteries in the room.

**502.5.2 Ventilation rate in rooms.** Continuous ventilation shall be provided at a rate of not less than 1 cubic foot per minute per square foot (cfm/ft<sup>2</sup>) [0.00508 m<sup>3</sup>/(s · m<sup>2</sup>)] of floor area of

the room.

**502.5.3 Hydrogen limit in cabinets.** The ventilation system shall be designed to limit the maximum concentration of hydrogen to 1.0 percent of the total volume of the cabinet during the worst-case event of simultaneous boost charging of all batteries in the cabinet.

**502.5.4 Ventilation rate in cabinets.** Continuous ventilation shall be provided at a rate of not less than 1 cubic foot per minute per square foot (cfm/ft<sup>2</sup>) [0.00508 m<sup>3</sup>/(s · m<sup>2</sup>)] of the floor area covered by the cabinet. The room in which the cabinet is installed shall also be ventilated as required by Section 502.5.1 or 502.5.2.

**502.6 Dry cleaning plants.** Mechanical ventilation in dry cleaning plants shall be provided and shall be adequate to protect employees and the public in accordance with this section and DOL 29 CFR Part 1910.1000, where applicable.

**502.6.1 Type II and Type III systems.** Type II and Type III dry cleaning systems shall be provided with a mechanical ventilation system that is designed to exhaust 1 cubic foot of air per minute for each square foot of floor area (1 cfm/ft<sup>2</sup>) [0.00508 m<sup>3</sup>/(s · m<sup>2</sup>)] in dry cleaning rooms and in drying rooms. The ventilation system shall operate automatically when the dry cleaning equipment is in operation and shall have manual controls at an approved location.

**502.6.2 Type IV and V systems.** Type IV and V dry cleaning systems shall be provided with an automatically activated exhaust ventilation system to maintain a minimum of 100 feet per minute (0.5 m/s) air velocity through the loading door when the door is opened.

**Exception:** Dry cleaning units are not required to be provided with exhaust ventilation where an exhaust hood is installed immediately outside of and above the loading door which operates at an airflow rate as follows:

**(Equation 5-1 attached to end of document)**

**502.6.3 Spotting and pretreating.** Scrubbing tubs, scouring, brushing or spotting operations shall be located such that solvent vapors are captured and exhausted by the ventilating system.

**502.7 Application of flammable finishes.** Mechanical exhaust as required by this section shall be provided for operations involving the application of flammable finishes and shall comply with the *New York City Fire Code*.

**502.7.1 During construction.** Ventilation shall be provided for operations involving the application of materials containing flammable solvents in the course of construction, alteration or demolition of a structure.

**502.7.2 Limited spraying spaces.** Positive mechanical ventilation which provides a minimum of six complete air changes per hour shall be installed in limited spraying spaces. Such system shall meet the requirements of the *New York City Fire Code* for handling flammable vapors.

Explosion venting is not required.

**502.7.3 Spraying areas.** Mechanical ventilation of spraying areas and resin application areas shall be provided in accordance with Sections 502.7.3.1 through 502.7.3.7.

**502.7.3.1 Operation.** Mechanical ventilation shall be kept in operation at all times while spraying operations are being conducted and for a sufficient time thereafter to allow vapors from drying coated articles and finishing material residue to be exhausted. Spraying equipment shall be interlocked with the ventilation of the spraying area such that spraying operations cannot be conducted unless the ventilation system is in operation.

**502.7.3.2 Recirculation.** Air exhausted from spraying operations shall not be recirculated.

**Exceptions:**

1. Air exhausted from spraying operations shall be permitted to be recirculated as makeup air for unmanned spray operations provided that:
  - 1.1. Solid particulate has been removed.
  - 1.2. The vapor concentration is less than 25 percent of the lower flammability limit (LFL).
  - 1.3. Approved equipment is used to monitor the vapor concentration.
  - 1.4. An alarm is sounded and spray operations are automatically shut down if the vapor concentration exceeds 25 percent of the LFL.
  - 1.5. The spray booths, spray spaces or spray rooms involved in any recirculation process shall be provided with mechanical ventilation that shall automatically exhaust 100 percent of the required air volume in the event of shutdown by approved equipment used to monitor vapor concentrations.
2. Air exhausted from spraying operations shall be permitted to be recirculated as makeup air to manned spraying operations if all of the conditions provided in Exception 1 are included in the installation and documents have been prepared to show that the installation does not present life safety hazards to personnel inside the spray booth, spray space or spray room.

**502.7.3.3 Air velocity.** Ventilation systems shall be designed, installed and maintained such that the average air velocity over the open face of the booth, or booth cross section in the direction of airflow during spraying operations, is not less than 100 feet per minute (0.51 m/s).

**502.7.3.4 Ventilation obstruction.** Articles being sprayed shall be positioned in a manner

that does not obstruct collection of overspray.

**502.7.3.5 Independent ducts.** Each spray booth and spray room shall have an independent exhaust duct system discharging to the outdoors.

**Exceptions:**

1. Multiple spray booths having a combined frontal area of 18 square feet (1.67m<sup>2</sup>) or less are allowed to have a common exhaust where identical spray-finishing material is used in each booth. If more than one fan serves one booth, such fans shall be interconnected so that all fans operate simultaneously.
2. Where treatment of exhaust is necessary for air pollution control or energy conservation, ducts shall be allowed to be manifolded if all of the following conditions are met:
  - 2.1. The sprayed materials used are compatible and will not react or cause ignition of the residue in the ducts.
  - 2.2. Nitrocellulose-based finishing material shall not be used.
  - 2.3. A filtering system shall be provided to reduce the amount of overspray carried into the duct manifold.
  - 2.4. Automatic sprinkler protection shall be provided at the junction of each booth exhaust with the manifold, in addition to the protection required by this chapter.

**502.7.3.6 Termination point.** The termination point for exhaust ducts discharging to the atmosphere shall be located with the following minimum distances.

1. For ducts conveying explosive or flammable vapors, fumes or dusts: 30 feet (9144 mm) from the property line; 10 feet (3048 mm) from openings into the building; 6 feet (1829 mm) from exterior walls and roofs; 30 feet (9144 mm) from combustible walls and openings into the building which are in the direction of the exhaust discharge; 10 feet (3048 mm) above adjoining grade.
2. For other product-conveying outlets: 10 feet (3048 mm) from the property line; 3 feet (914 mm) from exterior walls and roofs; 10 feet (3048 mm) from openings into the building; 10 feet (3048 mm) above adjoining grade.
3. For environmental air duct exhaust: 3 feet (914 mm) from the property line; 3 feet (914 mm) from openings into the building.

**502.7.3.7 Fan motors and belts.** Electric motors driving exhaust fans shall not be placed

inside booths or ducts. Fan rotating elements shall be nonferrous or nonsparking or the casing shall consist of, or be lined with, such material. Belts shall not enter the duct or booth unless the belt and pulley within the duct are tightly enclosed.

**502.7.4 Dipping operations.** Vapor areas of dip tank operations shall be provided with mechanical ventilation adequate to prevent the dangerous accumulation of vapors. Required ventilation systems shall be so arranged that the failure of any ventilating fan will automatically stop the dipping conveyor system.

**502.7.5 Electrostatic apparatus.** The spraying area in spray-finishing operations involving electrostatic apparatus and devices shall be ventilated in accordance with Section 502.7.3.

**502.7.6 Powder coating.** Exhaust ventilation for powder-coating operations shall be sufficient to maintain the atmosphere below one-half of the minimum explosive concentration for the material being applied. Nondeposited, air-suspended powders shall be removed through exhaust ducts to the powder recovery cyclone or receptacle.

**502.7.7 Floor resurfacing operations.** To prevent the accumulation of flammable vapors during floor resurfacing operations, mechanical ventilation at a minimum rate of 1 cfm/ft<sup>2</sup> [0.00508 m<sup>3</sup>/(s · m<sup>2</sup>)] of area being finished shall be provided. Such ventilation shall be by approved temporary or portable means. Vapors shall be exhausted to the outdoors. Such ventilation equipment shall be kept in operation while the floor finishing operations are conducted and until any flammable vapors have been exhausted.

**502.7.8 Resin application areas.** Exhaust ventilation for resin application areas shall comply with Section 502.7.3.

**Exception:** Mechanical ventilation is not required for buildings that are unenclosed for at least 75 percent of the perimeter.

**502.8 Hazardous materials - general requirements.** Exhaust ventilation systems for structures containing hazardous materials shall be provided as required in Sections 502.8.1 through 502.8.5 and shall comply with the *New York City Fire Code*.

**502.8.1 Storage in excess of the maximum allowable quantities.** Indoor storage areas and storage buildings for hazardous materials in amounts exceeding the maximum allowable quantity per control area shall be provided with mechanical exhaust ventilation or natural ventilation where natural ventilation can be shown to be acceptable for the materials as stored.

**Exception:** Storage areas for flammable solids complying with the *New York City Fire Code*.

**502.8.1.1 System requirements.** Exhaust ventilation systems shall comply with all of the following:



1. The installation shall be in accordance with this code.
2. Mechanical ventilation shall be provided at a rate of not less than 1 cfm/ft<sup>2</sup> [0.00508 m<sup>3</sup>/(s · m<sup>2</sup>)] of floor area over the storage area.
3. The systems shall operate continuously unless alternate designs are approved.
4. A manual shutoff control shall be provided outside of the room in a position adjacent to the access door to the room or in another approved location. The switch shall be of the break-glass type and shall be labeled: VENTILATION SYSTEM EMERGENCY SHUTOFF.
5. The exhaust ventilation system shall be designed to consider the density of the potential fumes or vapors released. For fumes or vapors that are heavier than air, exhaust shall be taken from a point within 12 inches (304 mm) of the floor.
6. The location of both the exhaust and inlet air openings shall be designed to provide air movement across all portions of the floor or room to prevent the accumulation of vapors.
7. The exhaust ventilation shall not be recirculated within the room or building if the materials stored are capable of emitting hazardous vapors.

**502.8.2 Gas rooms, exhausted enclosures and gas cabinets.** The ventilation system for gas rooms, exhausted enclosures and gas cabinets for any quantity of hazardous material shall be designed to operate at a negative pressure in relation to the surrounding area. Highly toxic and toxic gases shall also comply with Sections 502.9.7.1, 502.9.7.2 and 502.9.8.4.

**502.8.3 Indoor dispensing and use.** Indoor dispensing and use areas for hazardous materials in amounts exceeding the maximum allowable quantity per control area shall be provided with exhaust ventilation in accordance with Section 502.8.1.

**Exception:** Ventilation is not required for dispensing and use of flammable solids other than finely divided particles.

**502.8.4 Indoor dispensing and use-point sources.** Where gases, liquids or solids in amounts exceeding the maximum allowable quantity per control area and having a hazard ranking of 3 or 4 in accordance with NFPA 704 are dispensed or used, mechanical exhaust ventilation shall be provided to capture fumes, mists or vapors at the point of generation.

**Exception:** Where it can be demonstrated that the gases, liquids or solids do not create harmful fumes, mists or vapors.

**502.8.5 Closed systems.** Where closed systems for the use of hazardous materials in

amounts exceeding the maximum allowable quantity per control area are designed to be opened as part of normal operations, ventilation shall be provided in accordance with Section 502.8.4.

**502.9 Hazardous materials - requirements for specific materials.** Exhaust ventilation systems for specific hazardous materials shall be provided as required in Section 502.8 and Sections 502.9.1 through 502.9.11 and shall comply with the *New York City Fire Code*.

**502.9.1 Compressed gases medical gas systems.** Rooms for the storage of compressed medical gases in amounts exceeding the maximum allowable exempt quantity per control area, and which do not have an exterior wall, shall be exhausted through a duct to the exterior of the building. Each space shall be separately exhausted, and each exhaust air stream shall be enclosed in a 1-hour-rated shaft enclosure from the room to the exterior. Approved mechanical ventilation shall be provided at a minimum rate of 1 cfm/ft<sup>2</sup> [0.00508 m<sup>3</sup>/(s · m<sup>2</sup>)] of the area of the room.

Gas cabinets for the storage of compressed medical gases in amounts exceeding the maximum allowable quantity per control area shall be connected to an exhaust system. The average velocity of ventilation at the face of access ports or windows shall be not less than 200 feet per minute (1.02 m/s) with a minimum velocity of 150 feet per minute (0.76 m/s) at any point at the access port or window.

**502.9.2 Corrosives.** Where corrosive materials in amounts exceeding the maximum allowable quantity per control area are dispensed or used, mechanical exhaust ventilation in accordance with Section 502.8.4 shall be provided.

**502.9.3 Cryogenics.** Storage areas for stationary or portable containers of cryogenic fluids in any quantity shall be ventilated in accordance with Section 502.8. Indoor areas where cryogenic fluids in any quantity are dispensed shall be ventilated in accordance with the requirements of Section 502.8.4 in a manner that captures any vapor at the point of generation.

**Exception:** Ventilation for indoor dispensing areas is not required where it can be demonstrated that the cryogenic fluids do not create harmful vapors.

**502.9.4 Explosives.** Squirrel cage blowers shall not be used for exhausting hazardous fumes, vapors or gases in operating buildings and rooms for the manufacture, assembly or testing of explosives. Only nonferrous fan blades shall be used for fans located within the ductwork and through which hazardous materials are exhausted. Motors shall be located outside the duct.

**502.9.5 Flammable and combustible liquids.** Exhaust ventilation systems shall be provided as required by Sections 502.9.5.1 through 502.9.5.5 for the storage, use, dispensing, mixing and handling of flammable and combustible liquids. Unless otherwise specified, this section shall apply to any quantity of flammable and combustible liquids.

**Exception:** This section shall not apply to flammable and combustible liquids that are exempt from the *New York City Fire Code*.

**502.9.5.1 Vaults.** Vaults that contain tanks of Class I liquids shall be provided with continuous ventilation at a rate of not less than 1 cfm/ft<sup>2</sup> of floor area [0.00508 m<sup>3</sup>/(s · m<sup>2</sup>)], but not less than 150 cfm (4 m<sup>3</sup>/min). Failure of the exhaust airflow shall automatically shut down the dispensing system. The exhaust system shall be designed to provide air movement across all parts of the vault floor. Supply and exhaust ducts shall extend to a point not greater than 12 inches (305 mm) and not less than 3 inches (76 mm) above the floor. The exhaust system shall be installed in accordance with the provisions of NFPA 91. Means shall be provided to automatically detect any flammable vapors and to automatically shut down the dispensing system upon detection of such flammable vapors in the exhaust duct at a concentration of 25 percent of the LFL.

**502.9.5.2 Storage rooms and warehouses.** Liquid storage rooms and liquid storage warehouses for quantities of liquids exceeding those specified in the *New York City Fire Code* shall be ventilated in accordance with Section 502.8.1.

**502.9.5.3 Cleaning machines.** Areas containing machines used for parts cleaning in accordance with the *New York City Fire Code* shall be adequately ventilated to prevent accumulation of vapors.

**502.9.5.4 Use, dispensing and mixing.** Continuous mechanical ventilation shall be provided for the use, dispensing and mixing of flammable and combustible liquids in open or closed systems in amounts exceeding the maximum allowable quantity per control area and for bulk transfer and process transfer operations. The ventilation rate shall be not less than 1 cfm/ft<sup>2</sup> [0.00508m<sup>3</sup>/(s · m<sup>2</sup>)] of floor area over the design area. Provisions shall be made for the introduction of makeup air in a manner that will include all floor areas or pits where vapors can collect. Local or spot ventilation shall be provided where needed to prevent the accumulation of hazardous vapors.

**502.9.5.5 Bulk plants or terminals.** Ventilation shall be provided for portions of properties where flammable and combustible liquids are received by tank vessels, pipelines, tank cars or tank vehicles and which are stored or blended in bulk for the purpose of distributing such liquids by tank vessels, pipelines, tank cars, tank vehicles or containers as required by Sections 502.9.5.5.1 through 502.9.5.5.3.

**502.9.5.5.1 General.** Ventilation shall be provided for rooms, buildings and enclosures in which Class I liquids are pumped, used or transferred. Design of ventilation systems shall consider the relatively high specific gravity of the vapors. Where natural ventilation is used, adequate openings in outside walls at floor level, unobstructed except by louvers or coarse screens, shall be provided. Where natural ventilation is inadequate, mechanical ventilation shall be provided. The natural ventilation design shall be approved for each specific application by the commissioner prior to installation and/or use.

**502.9.5.5.2 Basements and pits.** Class I liquids shall not be stored or used within a building having a basement or pit into which flammable vapors can travel, unless such area is provided with ventilation designed to prevent the accumulation of flammable vapors therein.

**502.9.5.5.3 Dispensing of Class I liquids.** Containers of Class I liquids shall not be drawn from or filled within buildings unless a provision is made to prevent the accumulation of flammable vapors in hazardous concentrations. Where mechanical ventilation is required, it shall be kept in operation while flammable vapors could be present.

**502.9.6 Highly toxic and toxic liquids.** Ventilation exhaust shall be provided for highly toxic and toxic liquids as required by Sections 502.9.6.1 and 502.9.6.2.

**502.9.6.1 Treatment system.** This provision shall apply to indoor and outdoor storage and use of highly toxic and toxic liquids in amounts exceeding the maximum allowable quantities per control area. Exhaust scrubbers or other systems for processing vapors of highly toxic liquids shall be provided where a spill or accidental release of such liquids can be expected to release highly toxic vapors at normal temperature and pressure.

**502.9.6.2 Open and closed systems.** Mechanical exhaust ventilation shall be provided for highly toxic and toxic liquids used in open systems in accordance with Section 502.8.4. Mechanical exhaust ventilation shall be provided for highly toxic and toxic liquids used in closed systems in accordance with Section 502.8.5.

**Exception:** Liquids or solids that do not generate highly toxic or toxic fumes, mists or vapors.

**502.9.7 Highly toxic and toxic compressed gases—any quantity.** Ventilation exhaust shall be provided for highly toxic and toxic compressed gases in any quantity as required by Sections 502.9.7.1 and 502.9.7.2.

**502.9.7.1 Gas cabinets.** Gas cabinets containing highly toxic or toxic compressed gases in any quantity shall comply with Section 502.8.2 and the following requirements:

1. The average ventilation velocity at the face of gas cabinet access ports or windows shall be not less than 200 feet per minute (1.02 m/s) with a minimum velocity of 150 feet per minute (0.76 m/s) at any point at the access port or window.
2. Gas cabinets shall be connected to an exhaust system.
3. Gas cabinets shall not be used as the sole means of exhaust for any room or area.

**502.9.7.2 Exhausted enclosures.** Exhausted enclosures containing highly toxic or toxic compressed gases in any quantity shall comply with Section 502.8.2 and the following requirements:

1. The average ventilation velocity at the face of the enclosure shall be not less than 200 feet per minute (1.02 m/s) with a minimum velocity of 150 feet per minute (0.76 m/s).
2. Exhausted enclosures shall be connected to an exhaust system.
3. Exhausted enclosures shall not be used as the sole means of exhaust for any room or area.

**502.9.8 Highly toxic and toxic compressed gases—quantities exceeding the maximum allowable per control area.** Ventilation exhaust shall be provided for highly toxic and toxic compressed gases in amounts exceeding the maximum allowable quantities per control area as required by Sections 502.9.8.1 through 502.9.8.6.

**502.9.8.1 Ventilated areas.** The room or area in which indoor gas cabinets or exhausted enclosures are located shall be provided with exhaust ventilation. Gas cabinets or exhausted enclosures shall not be used as the sole means of exhaust for any room or area.

**502.9.8.2 Local exhaust for portable tanks.** A means of local exhaust shall be provided to capture leakage from indoor and outdoor portable tanks. The local exhaust shall consist of portable ducts or collection systems designed to be applied to the site of a leak in a valve or fitting on the tank. The local exhaust system shall be located in a gas room. Exhaust shall be directed to a treatment system where required by the *New York City Fire Code*.

**502.9.8.3 Piping and controls—stationary tanks.** Filling or dispensing connections on indoor stationary tanks shall be provided with a means of local exhaust. Such exhaust shall be designed to capture fumes and vapors. The exhaust shall be directed to a treatment system where required by the *New York City Fire Code*.

**502.9.8.4 Gas rooms.** The ventilation system for gas rooms shall be designed to operate at a negative pressure in relation to the surrounding area. The exhaust ventilation from gas rooms shall be directed to an exhaust system.

**502.9.8.5 Treatment system.** The exhaust ventilation from gas cabinets, exhausted enclosures and gas rooms, and local exhaust systems required in Sections 502.9.8.2 and 502.9.8.3 shall be directed to a treatment system where required by the *New York City Fire Code*.

**502.9.8.6 Process equipment.** Effluent from indoor and outdoor process equipment containing highly toxic or toxic compressed gases which could be discharged to the

atmosphere shall be processed through an exhaust scrubber or other processing system. Such systems shall be in accordance with the *New York City Fire Code*.

**502.9.9 Ozone gas generators.** Ozone cabinets and ozone gas-generator rooms for systems having a maximum ozone-generating capacity of one-half pound (0.23 kg) or more over a 24-hour period shall be mechanically ventilated at a rate of not less than six air changes per hour. For cabinets, the average velocity of ventilation at makeup air openings with cabinet doors closed shall be not less than 200 feet per minute (1.02 m/s).

**502.9.10 LP-gas distribution facilities.** LP-gas distribution facilities shall conform to the requirements of the *New York City Fire Code*.

**502.9.11 Silane gas.** Exhausted enclosures and gas cabinets for the indoor storage of silane gas in amounts exceeding the maximum allowable quantities per control area shall comply with this section.

1. Exhausted enclosures and gas cabinets shall be in accordance with Section 502.8.2.
2. The velocity of ventilation across unwelded fittings and connections on the piping system shall not be less than 200 feet per minute (1.02 m/s).
3. The average velocity at the face of the access ports or windows in the gas cabinet shall not be less than 200 feet per minute (1.02 m/s) with a minimum velocity of 150 feet per minute (0.76 m/s) at any point at the access port or window.

**502.10 Hazardous production materials (HPM).** Exhaust ventilation systems and materials for ducts utilized for the exhaust of HPM shall comply with this section, other applicable provisions of this code, the *New York City Building Code* and the *New York City Fire Code*.

**502.10.1 Where required.** Exhaust ventilation systems shall be provided in the following locations in accordance with the requirements of this section and the *New York City Building Code*:

1. Fabrication areas: Exhaust ventilation for fabrication areas shall comply with the *New York City Building Code*. Additional manual control switches shall be provided where required by the commissioner.
2. Workstations: A ventilation system shall be provided to capture and exhaust fumes and vapors at workstations.
3. Liquid storage rooms: Exhaust ventilation for liquid storage rooms shall comply with Section 502.8.1.1 and the *New York City Building Code*.
4. HPM rooms: Exhaust ventilation for HPM rooms shall comply with Section 502.8.1.1 and the *New York City Building Code*.

5. Gas cabinets: Exhaust ventilation for gas cabinets shall comply with Section 502.8.2. The gas cabinet ventilation system is allowed to connect to a workstation ventilation system. Exhaust ventilation for gas cabinets containing highly toxic or toxic gases shall also comply with Sections 502.9.7 and 502.9.8.
6. Exhausted enclosures: Exhaust ventilation for exhausted enclosures shall comply with Section 502.8.2. Exhaust ventilation for exhausted enclosures containing highly toxic or toxic gases shall also comply with Sections 502.9.7 and 502.9.8.
7. Gas rooms: Exhaust ventilation for gas rooms shall comply with Section 502.8.2. Exhaust ventilation for gas cabinets containing highly toxic or toxic gases shall also comply with Sections 502.9.7 and 502.9.8.

**502.10.2 Penetrations.** Exhaust ducts penetrating fire barrier assemblies shall be contained in a shaft of equivalent fire-resistive construction. Exhaust ducts shall not penetrate building separation fire walls. Fire dampers shall not be installed in exhaust ducts.

**502.10.3 Treatment systems.** Treatment systems for highly toxic and toxic gases shall comply with the *New York City Fire Code*.

**502.11 Motion picture projectors.** Motion picture projectors shall be exhausted in accordance with Section 502.11.1 or 502.11.2.

**502.11.1 Projectors with an exhaust discharge.** Projectors equipped with an exhaust discharge shall be directly connected to a mechanical exhaust system. The exhaust system shall operate at an exhaust rate as indicated by the manufacturer's installation instructions.

**502.11.2 Projectors without exhaust connection.** Projectors without an exhaust connection shall have contaminants exhausted through a mechanical exhaust system. The exhaust rate for electric arc projectors shall be a minimum of 200 cubic feet per minute (cfm) (0.09 m<sup>3</sup>/s) per lamp. The exhaust rate for xenon projectors shall be a minimum of 300 cfm (0.14 m<sup>3</sup>/s) per lamp. Xenon projector exhaust shall be at a rate such that the exterior temperature of the lamp housing does not exceed 130°F (54°C). The lamp and projection room exhaust systems, whether combined or independent, shall not be interconnected with any other exhaust or return system within the building.

**502.12 Organic coating processes.** Enclosed structures involving organic coating processes in which Class I liquids are processed or handled shall be ventilated at a rate of not less than 1 cfm/ft<sup>2</sup> [0.00508 m<sup>3</sup>/(s · m<sup>2</sup>)] of solid floor area. Ventilation shall be accomplished by exhaust fans that intake at floor levels and discharge to a safe location outside the structure. Noncontaminated intake air shall be introduced in such a manner that all portions of solid floor areas are provided with continuous uniformly distributed air movement.

**502.13 Public garages.** Mechanical exhaust systems for public garages, as required in Chapter 4,

shall operate continuously or in accordance with Section 404.

**502.14 Motor vehicle operation.** In areas where motor vehicles operate, mechanical ventilation shall be provided in accordance with Section 403. Additionally, areas in which stationary motor vehicles are operated shall be provided with a source capture system that connects directly to the motor vehicle exhaust systems.

**Exceptions:**

1. This section shall not apply where the motor vehicles being operated or repaired are electrically powered.
2. This section shall not apply to one- and two-family dwellings.
3. This section shall not apply to motor vehicle service areas where engines are operated inside the building only for the duration necessary to move the motor vehicles in and out of the building.

**502.15 Repair garages.** Where Class I liquids are stored or used within a building having a basement or pit wherein flammable vapors could accumulate, the basement or pit shall be provided with ventilation at a minimum rate of 1.5 cubic feet per minute per square foot (cfm/ft<sup>2</sup>) [0.008 m<sup>3</sup>/(s · m<sup>2</sup>)] to prevent the accumulation of flammable vapors therein.

**502.16 Repair garages for natural gas- and hydrogen-fueled vehicles.** Repair garages used for the repair of natural gas- or hydrogen-fueled vehicles shall be provided with an approved mechanical ventilation system. The mechanical ventilation system shall be in accordance with Sections 502.16.1 and 502.16.2.

**Exception:** Where approved by the commissioner, natural ventilation shall be permitted in lieu of mechanical ventilation.

**502.16.1 Design.** Indoor locations shall be ventilated utilizing air supply inlets and exhaust outlets arranged to provide uniform air movement to the extent practical. Inlets shall be uniformly arranged on exterior walls near floor level. Outlets shall be located at the high point of the room in exterior walls or the roof.

1. Ventilation shall be by a continuous mechanical ventilation system or by a mechanical ventilation system activated by a continuously monitoring natural gas detection system activating at a gas concentration of not more than 25 percent of the LFL. In all cases, the system shall shut down the fueling system in the event of failure of the ventilation system.
2. The ventilation rate shall be at least 1 cubic foot per minute per 12 cubic feet [0.00138 m<sup>3</sup>/(s · m<sup>3</sup>)] of room volume.



**502.16.2 Operation.** The mechanical ventilation system shall operate continuously.

**Exceptions:**

1. Mechanical ventilation systems that are interlocked with a gas detection system designed in accordance with the *New York City Building Code*.
2. Mechanical ventilation systems in garages that are used only for the repair of vehicles fueled by liquid fuels or odorized gases, such as CNG, where the ventilation system is electrically interlocked with the lighting circuit.

**502.17 Tire rebuilding or recapping.** Each room where rubber cement is used or mixed, or where flammable or combustible solvents are applied, shall be ventilated in accordance with the applicable provisions of NFPA 91.

**502.17.1 Buffing machines.** Each buffing machine shall be connected to a dust-collecting system that prevents the accumulation of the dust produced by the buffing process.

**502.18 Specific rooms.** Specific rooms, including bathrooms, locker rooms, smoking lounges and toilet rooms, shall be exhausted in accordance with the ventilation requirements of Chapter 4.

**502.19 Domestic kitchen exhaust systems.** In all group R occupancies a minimum of No. 18 Gage galvanized sheet metal shall be used, except that ductwork that complies with Section 603.6.1.2 shall be permitted for independent apartment exhaust systems providing general exhaust ventilation of kitchen and toilet areas.

**502.20 Nonproduction chemical laboratories.** Nonproduction chemical laboratories shall comply with Section 419 of the *New York City Building Code* and NFPA 45.

**SECTION MC 503**  
**MOTORS AND FANS**

**503.1 General.** Motors and fans shall be sized to provide the required air movement. Motors in areas that contain flammable vapors or dusts shall be of a type approved for such environments. A manually operated remote control installed at an approved location shall be provided to shut off fans or blowers in flammable vapor or dust systems. Electrical equipment and appliances used in operations that generate explosive or flammable vapors, fumes or dusts shall be interlocked with the ventilation system so that the equipment and appliances cannot be operated unless the ventilation fans are in operation. Motors for fans used to convey flammable vapors or dusts shall be located outside the duct or shall be protected with approved shields and dustproofing. Motors and fans shall be provided with a means of access for servicing and maintenance.

**503.2 Fans.** Parts of fans in contact with explosive or flammable vapors, fumes or dusts shall be of nonferrous or nonsparking materials, or their casing shall be lined or constructed of such material. When the size and hardness of materials passing through a fan are capable of producing a

spark, both the fan and the casing shall be of nonsparking materials. When fans are required to be spark resistant, their bearings shall not be within the airstream, and all parts of the fan shall be grounded. Fans in systems-handling materials that are capable of clogging the blades, and fans in buffing or woodworking exhaust systems, shall be of the radial-blade or tube-axial type.

**503.3 Equipment and appliances identification plate.** Equipment and appliances used to exhaust explosive or flammable vapors, fumes or dusts shall bear an identification plate stating the ventilation rate for which the system was designed.

**503.4 Corrosion-resistant fans.** Fans located in systems conveying corrosives shall be of materials that are resistant to the corrosive or shall be coated with corrosion-resistant materials.

**503.5 Fan location.** Fans exhausting noxious, toxic, hot vapor or grease laden air shall be located as close to the terminus as practicable, at the roof or within a mechanical equipment room, immediately below the roof.

**Exception:** Where the fan is listed or approved for such an application.

## **SECTION MC 504** **CLOTHES DRYER EXHAUST**

**504.1 Installation.** Clothes dryers shall be exhausted in accordance with the manufacturer's instructions. Dryer exhaust systems shall be independent of all other systems and shall convey the moisture and any products of combustion to the outside of the building.

**Exception:** This section shall not apply to listed and labeled condensing (ductless) electric clothes dryers.

**504.2 Exhaust penetrations.** Ducts that exhaust clothes dryers shall not penetrate or be located within any fireblocking, draftstopping or any wall, floor/ceiling or other assembly required by the *New York City Building Code* to be fire-resistance rated, unless such duct is constructed of galvanized steel or aluminum of the thickness specified in Section 603.4 and the fire-resistance rating is maintained in accordance with the *New York City Building Code*. Fire dampers, combination fire/smoke dampers and any similar devices that will obstruct the exhaust flow, shall be prohibited in clothes dryer exhaust ducts.

**504.3 Cleanout.** Each vertical riser shall be provided with a means for cleanout.

**504.4 Exhaust installation.** Dryer exhaust ducts for clothes dryers shall terminate on the outside of the building and shall be equipped with a backdraft damper. Screens shall not be installed at the duct termination. Ducts shall not be connected or installed with sheet metal screws or other fasteners that will obstruct the exhaust flow. Clothes dryer exhaust ducts shall not be connected to a vent connector, vent or chimney. Clothes dryer exhaust ducts shall not extend into or through ducts or plenums.

**504.5 Makeup air.** Installations exhausting more than 200 cfm (0.09 m<sup>3</sup>/s) shall be provided with makeup air. Where a closet is designed for the installation of a clothes dryer, an opening having an area of not less than 100 square inches (0.0645 m<sup>2</sup>) shall be provided in the closet enclosure.

**504.6 Domestic clothes dryer ducts.** Exhaust ducts for domestic clothes dryers shall be constructed of metal and shall have a smooth interior finish. The exhaust duct shall be a minimum nominal size of 4 inches (102 mm) in diameter. The entire exhaust system shall be supported and secured in place. The male end of the duct at overlapped duct joints shall extend in the direction of airflow. Clothes dryer transition ducts used to connect the appliance to the exhaust duct system shall be limited to single lengths not to exceed 8 feet (2438 mm) and shall be listed and labeled for the application. Transition ducts shall not be concealed within construction.

**504.6.1 Maximum length.** The maximum length of a clothes dryer exhaust duct shall not exceed 25 feet (7620 mm) from the dryer location to the outlet terminal. The maximum length of duct shall be reduced 2½ feet (762 mm) for each 45-degree (0.79 rad) bend and 5 feet (1524 mm) for each 90-degree (1.6 rad) bend. The maximum length of the exhaust duct does not include the transition duct.

**Exception:** Where the make and model of the clothes dryer to be installed is known and the manufacturer's installation instructions for such dryer are provided, the maximum length of the exhaust duct, including any transition duct, shall be permitted to be in accordance with the dryer manufacturer's installation instructions.

**504.6.2 Rough-in required.** Where a compartment or space for a domestic clothes dryer is provided, an exhaust duct system shall be installed in accordance with Sections 504.6 and 504.6.1.

**504.7 Commercial clothes dryers.** The installation of dryer exhaust ducts serving Type 2 clothes dryers shall comply with the appliance manufacturer's installation instructions. Exhaust fan motors installed in exhaust systems shall be located outside of the airstream. In multiple installations, the fan shall operate continuously or be interlocked to operate when any individual unit is operating. Ducts shall have a minimum clearance of 6 inches (152 mm) to combustible materials. Clothes dryer transition ducts used to connect the appliance to the exhaust duct system shall be limited to single lengths not to exceed 8 feet (2438 mm) in length and shall be listed and labeled for the application. Transition ducts shall not be concealed within construction.

## **SECTION MC 505** **DOMESTIC KITCHEN EQUIPMENT EXHAUST**

**505.1 Domestic systems.** Where domestic range hoods and domestic appliances equipped with downdraft exhaust are located within dwelling units, such hoods and appliances shall discharge to the outdoors through ducts constructed of galvanized steel, stainless steel, aluminum or copper. Such ducts shall have smooth inner walls and shall be air tight and equipped with a backdraft damper. Such exhaust system shall be installed in strict compliance with the manufacturer's recommendations as well as the requirements of the listing.

**Exceptions:**

1. Where installed in accordance with the manufacturer's installation instructions and where mechanical or natural ventilation is otherwise provided in accordance with Chapter 4, listed and labeled ductless range hoods shall not be required to discharge to the outdoors.
2. Ducts for domestic kitchen cooking appliances equipped with downdraft exhaust systems shall be permitted to be constructed of Schedule 40 PVC pipe provided that the installation complies with all of the following:
  - 2.1. The duct shall be installed under a concrete slab poured on grade.
  - 2.2. The underfloor trench in which the duct is installed shall be completely backfilled with sand or gravel.
  - 2.3. The PVC duct shall extend not greater than 1 inch (25 mm) above the indoor concrete floor surface.
  - 2.4. The PVC duct shall extend not greater than 1 inch (25 mm) above grade outside of the building.
  - 2.5. The PVC ducts shall be solvent cemented.

**SECTION MC 506**  
**COMMERCIAL KITCHEN HOOD VENTILATION**  
**SYSTEM DUCTS AND EXHAUST EQUIPMENT**

**506.1 General.** Commercial kitchen hood ventilation ducts and exhaust equipment shall comply with the requirements of this section. Commercial kitchen grease ducts shall be designed for the type of cooking appliance and hood served. All ducts shall lead directly to the exterior of the building and terminate as required by 506.3.12.

**506.2 Corrosion protection.** Ducts exposed to the outside atmosphere or subject to a corrosive environment shall be protected against corrosion in an approved manner.

1. The exterior portion of the ductwork shall be vertical wherever possible and shall be installed and adequately supported on the exterior of a building. Bolts, screws, rivets, and other mechanical fasteners shall not penetrate duct walls. Clearance of any vertical or horizontal ducts to any other material or construction shall comply with Section 506.3.6. and to any additional clearance requirements as may be applicable in accordance with Section 506.5.4.

2. All exterior ducts shall be constructed of stainless steel not less than 0.043 inch (1.09 mm) (No. 18 Gage) in thickness. At the base of each duct and at its termination point a clearly identifiable permanent sign shall be installed identifying the facility from which the duct originates.
1. No portion of an exterior metal duct shall be nearer than 24 inches (610 mm) to any door or window or to any exit, or located where it would be readily accessible to the public, unless it is insulated or shielded to avoid injury to any person coming in contact with the duct.

**Exception:** Listed and labeled factory-built commercial kitchen grease ducts may be used when installed in accordance with Section 304.1.

**506.3 Ducts serving Type I hoods.** Type I exhaust ducts shall be independent of all other exhaust systems except as provided in Section 506.3.5. Commercial kitchen duct systems serving Type I hoods shall be designed, constructed and installed in accordance with Sections 506.3.1 through 506.3.12.3.

**506.3.1 Duct materials.** Ducts serving Type I hoods shall be constructed of materials in accordance with Sections 506.3.1.1 and 506.3.1.2.

**506.3.1.1 Grease duct materials.** Grease ducts serving Type I hoods, and located within buildings, shall be constructed as follows:

1. Ducts with a cross-sectional area up to and including 155 square inches ( 100 000 mm<sup>2</sup>) shall be constructed of 0.0598 inch (1.52 mm) No. 16 Gage steel;
2. Ducts with a cross-sectional area over 155 square inches (100 000 mm<sup>2</sup>), but not more than 200 square inches (0.129 m<sup>2</sup>) shall be constructed of 0.074 inch (1.9 mm) No. 14 Gage steel; and
3. Ducts with a cross-sectional area equal to or more than 200 square inches (0.129 m<sup>2</sup>) shall be constructed of 0.1046 inch (2.66 mm) No. 12 Gage steel.

If stainless steel is used for ducts of any of the cross-sectional areas shown above, the Gage steel may be increased upwards (resulting in a smaller thickness) by 1 Gage.

**Exception:** Listed and labeled factory-built commercial kitchen grease ducts shall be installed in accordance with Section 304.1, and as approved by the commissioner.

**506.3.1.2 Makeup air ducts.** Make up air ducts connecting to or within 18 inches (457 mm) of a Type I hood shall be constructed and installed in accordance with Sections 603.1, 603.3, 603.4, 603.9, 603.10, and 603.12. Duct insulation installed within 18 inches (457 mm) of a Type I hood shall be noncombustible or shall be listed for the application.

**506.3.2 Joints, seams and penetrations of grease ducts.** Joints, seams and penetrations of grease ducts shall be made with a continuous liquid-tight weld or braze made on the external surface of the duct system.

**Exceptions:**

1. Penetrations shall not be required to be welded or brazed where sealed by devices that are listed for the application.
2. Internal welding or brazing shall not be prohibited provided that the joint is formed or ground smooth and is provided with ready access for inspection.
3. Listed and labeled factory-built commercial kitchen grease ducts installed in accordance with Section 304.1.

**506.3.2.1 Duct joint types.** Duct joints shall be butt joints or overlapping duct joints of either the telescoping or bell type. Overlapping joints shall be installed to prevent ledges and obstructions from collecting grease or interfering with gravity drainage to the intended collection point. The difference between the inside cross-sectional dimensions of overlapping sections of duct shall not exceed 0.25 inch (6 mm). The length of overlap for overlapping duct joints shall not exceed 2 inches (51 mm).

**506.3.2.2 Duct-to-hood joints.** Duct-to-hood joints shall be made with continuous internal or external liquid-tight welded or brazed joints. Such joints shall be smooth, accessible for inspection, and without grease traps.

**Exceptions:** This section shall not apply to:

1. A vertical duct-to-hood collar connection made in the top plane of the hood in accordance with all of the following:
  - 1.1. The hood duct opening shall have a 1-inch-deep (25 mm), full perimeter, welded flange turned down into the hood interior at an angle of 90 degrees from the plane of the opening.
  - 1.2. The duct shall have a 1-inch-deep (25 mm) flange made by a 1-inch by 1-inch (25 mm by 25 mm) angle iron welded to the full perimeter of the duct not less than 1 inch (25 mm) above the bottom end of the duct.
  - 1.3. A gasket rated for use at not less than 1,500°F (815°C) is installed between the duct flange and the top of the hood.
  - 1.4. The duct-to-hood joint shall be secured by stud bolts not less than 0.25 inch (6.4 mm) in diameter welded to the hood with a spacing not greater than 4

inches (102 mm) on center for the full perimeter of the opening. All bolts and nuts are to be secured with lockwashers.

2. Listed and labeled duct-to-hood collar connections installed in accordance with Section 304.1.

**506.3.2.3 Duct-to-exhaust fan connections.** Duct-to-exhaust fan connections shall be flanged and gasketed at the base of the fan for vertical discharge fans; shall be flanged, gasketed and bolted to the inlet of the fan for side-inlet utility fans; and shall be flanged, gasketed and bolted to the inlet and outlet of the fan for in-line fans. Approved flexible connectors may be provided.

**506.3.2.4 Vibration isolation.** A vibration isolation connector for connecting a duct to a fan shall consist of noncombustible packing in a metal sleeve joint of approved design or shall be a coated-fabric flexible duct connector listed and labeled for the application. Vibration isolation connectors shall be installed only at the connection of a duct to a fan inlet or outlet.

**506.3.3 Grease duct supports.** Grease duct bracing and supports shall be of noncombustible material securely attached to the structure and designed to carry gravity and seismic loads within the stress limitations of the *New York City Building Code*. Bolts, screws, rivets and other mechanical fasteners shall not penetrate duct walls.

**506.3.4 Air velocity.** Grease duct systems serving a Type I hood shall be designed and installed to provide an air velocity within the duct system of not less than 500 feet per minute (2.54 m/s).

**Exception:** The velocity limitations shall not apply within duct transitions utilized to connect ducts to differently sized or shaped openings in hoods and fans, provided that such transitions do not exceed 3 feet (914 mm) in length and are designed to prevent the trapping of grease.

**506.3.5 Separation of grease duct system.** A separate grease duct system shall be provided for each Type I hood.

**Exceptions:**

1. A separate grease duct system is not required where all of the following conditions are met:
  - 1.1. All interconnected hoods are located within the same story, provided that they are part of the same facility and under the control of one owner or tenant.

- 1.2. All interconnected hoods are located within the same room or in adjoining rooms, provided that they are part of the same facility and under the control of one owner or tenant.
- 1.3. Interconnecting ducts do not penetrate assemblies required to be fire-resistance rated.
- 1.4. The grease duct system does not serve solid fuel-fired appliances.
2. Branch ducts from other equipment in the same kitchen area, for which hoods and filters are not required or from registers exhausting the kitchen space in general, may be connected to the main hood exhaust duct if the following requirements are complied with:
  - 2.1. A fusible link fire damper of the same gage as the hood exhaust duct shall be added at the point of connection of the branch duct to the exhaust duct.
  - 2.2. If the branch connection is made to the portion of the ductwork that will contain the fire extinguishing medium, then the fire dampers required in Exception Item 2.1 shall be arranged to close automatically upon the operation of the fire extinguishing system.
  - 2.3. The branch connection shall be made in either the top or sides of the main duct in a manner to prevent grease from flowing into the branch duct.
  - 2.4. The branch ducts shall be constructed of steel, aluminum, or copper of the gages and weights required in Chapter 6, and they shall be insulated with 2 inches (51 mm) of magnesia or other material having equivalent insulative and fire resistance qualities.
  - 2.5. All registers in these branches shall have fusible link actuated dampers.
  - 2.6. Where branch ductwork is to be used to exhaust vapors from dishwashers, pot sinks, or other similar equipment of a commercial type from which moisture is emitted, copper or aluminum of the minimum gage and weights required in Chapter 6 shall be used. Such ductwork shall be installed so that condensate cannot leak from it.

**506.3.6 Grease duct clearances.** Grease duct systems and exhaust equipment serving a Type I hood shall have a clearance to combustible construction of not less than 18 inches (457 mm), and shall have a clearance to noncombustible construction and gypsum wallboard attached to noncombustible structures of not less than 3 inches (76 mm).

**Exceptions:**



1. Listed and labeled factory-built commercial kitchen grease ducts and exhaust equipment installed in accordance with Section 304.1 and the manufacturer's instructions, and as approved by the commissioner.
2. Protected with a minimum insulation covering of 2 inches (51 mm) of magnesium or calcium silicate block, with staggered joints, attached with galvanized steel wire or material assembly equivalent in insulating and fire resistant qualities which can not be penetrated by grease, shall be applied to all ducts inside of the building as approved by the commissioner.

**506.3.7 Prevention of grease accumulation in grease ducts.** Duct systems serving a Type I hood shall be constructed and installed so that grease cannot collect in any portion thereof, and the system shall slope not less than one-fourth unit vertical in 12 units horizontal (2-percent slope) toward the hood or toward an approved grease reservoir. Where horizontal ducts exceed 75 feet (22 860 mm) in length, the slope shall not be less than one unit vertical in 12 units horizontal (8.3-percent slope). Dampers shall not be installed in the grease duct systems, except as required by Section 506.3.5 Exception Item 2.

**506.3.7.1 Residue trap.** A residue trap shall be provided at the base of each vertical riser with provision for cleanout in accordance with NFPA 96.

**506.3.8 Grease duct cleanouts and other openings.** Grease duct systems shall not have openings therein other than those required for proper operation and maintenance of the system. Any portion of such system having sections not provided with access from the duct entry or discharge shall be provided with cleanout openings. Cleanout openings shall be provided at every change in direction, within 3 feet (914 mm) of the exhaust fan, and as required under Section 506.3.9. Cleanout openings shall be equipped with tight-fitting doors constructed of steel having a thickness not less than that required for the duct. Doors shall be equipped with a substantial method of latching, sufficient to hold the door tightly closed. Doors shall be designed so that they are operable without the use of a tool. Door assemblies shall have a gasket or sealant that is noncombustible and liquid tight, and shall not have fasteners that penetrate the duct. Listed and labeled access door assemblies shall be installed in accordance with the terms of the listing. Signage shall be provided at all required access doors and openings in accordance with Section 506.3.11.

**506.3.8.1 Personnel entry.** Where ductwork is large enough to allow entry of personnel, not less than one approved or listed opening having dimensions not less than 20 inches by 20 inches (508 mm by 508 mm) shall be provided in the horizontal sections, and in the top of vertical risers. Where such entry is provided, the duct and its supports shall be capable of supporting the additional load and the cleanouts specified in Section 506.3.8 are not required. Where personnel entry is not possible, access for cleaning interior vertical ducts shall be provided on each floor, and for cleaning the base of the vertical riser.

**506.3.9 Grease duct horizontal cleanouts.** Cleanouts located on horizontal sections of ducts shall be spaced not more than 20 feet (6096 mm) apart, unless the opening prescribed by

Section 506.3.8.1 is not possible, in which case openings large enough to permit thorough cleaning shall be provided at 12 feet (3658 mm) intervals. The cleanouts shall be located on the side of the duct with the opening not less than 1.5 inches (38 mm) above the bottom of the duct, and not less than 1 inch (25 mm) below the top of the duct. The opening minimum dimensions shall be 12 inches (305 mm) on each side. Where the dimensions of the side of the duct prohibit the cleanout installation prescribed herein, the openings shall be on the top of the duct or the bottom of the duct. Where located on the top of the duct, the opening edges shall be a minimum of 1 inch (25 mm) from the edges of the duct. Where located in the bottom of the duct, cleanout openings shall be designed to provide internal damming around the opening, shall be provided with gasketing to preclude grease leakage, shall provide for drainage of grease down the duct around the dam, and shall be approved for the application. Where the dimensions of the sides, top or bottom of the duct preclude the installation of the prescribed minimum-size cleanout opening, the cleanout shall be located on the duct face that affords the largest opening dimension and shall be installed with the opening edges at the prescribed distances from the duct edges as previously set forth in this section.

**506.3.10 Grease duct enclosure.** A grease duct serving a Type I hood that penetrates a ceiling, wall or floor shall be enclosed from the first point of penetration to the outlet terminal. A duct shall penetrate exterior walls only at locations where unprotected openings are permitted by the *New York City Building Code*. Ducts shall be enclosed in accordance with the *New York City Building Code* requirements for shaft construction. The duct enclosure shall be sealed around the duct at the point of penetration and vented to the outside of the building through the use of weather-protected openings. Clearance from the duct to the interior surface of enclosures of combustible construction shall be not less than 18 inches (457 mm). Clearance from the duct to the interior surface of enclosures of noncombustible construction or gypsum wallboard attached to noncombustible structures shall be not less than 6 inches (152 mm). The duct enclosure shall serve a single grease exhaust duct system and shall not contain any other ducts, piping, wiring or systems.

**Exceptions:**

1. The shaft enclosure provisions of this section shall not be required where a duct penetration is protected with a through-penetration firestop system classified in accordance with ASTM E 814 and having an .F. and .T. rating equal to the fire-resistance rating of the assembly being penetrated and where the surface of the duct is continuously covered on all sides from the point at which the duct penetrates a ceiling, wall or floor to the outlet terminal with a classified and labeled material, system, method of construction or product specifically evaluated for such purpose, which material, system, method of construction or product is approved by the commissioner and installed according to the manufacturer's instructions. Exposed duct wrap systems shall be protected where subject to physical damage.
2. As an alternative to Exception Item 1 of this section, a minimum insulation covering of 2 inches (51 mm) of magnesium or calcium silicate block, with staggered joints, attached with galvanized steel wire or material assembly

equivalent in insulating and fire resistant qualities which can not be penetrated by grease, and as approved by the commissioner, shall be applied to all ducts inside of the building.

3. A duct enclosure shall not be required for a grease duct that penetrates only a nonfire-resistance-rated roof/ceiling assembly.
4. A listed and labeled factory-built commercial kitchen grease duct system, evaluated as an enclosure system for reduced clearances to combustibles, and approved by the commissioner and installed according to manufacturer's instructions.

**506.3.11 Grease duct fire-resistive access opening.** Where cleanout openings are located in ducts within a fire-resistance-rated enclosure, access openings shall be provided in the enclosure at each cleanout point. Access openings shall be equipped with tight-fitting sliding or hinged doors that are equal in fire-resistive protection to that of the shaft or enclosure. An approved sign shall be placed on access opening panels with wording as follows: "ACCESS PANEL. DO NOT OBSTRUCT." Cleanout openings provided in ducts that are not located within a fire resistance-rated enclosure shall be provided with signage at the required opening that contains the same wording.

**506.3.12 Exhaust outlets serving Type I hoods.** Exhaust outlets for grease ducts serving Type I hoods shall conform to the requirements of Sections 506.3.12.1 through 506.3.12.3.

**506.3.12.1 Termination above the roof.** Exhaust outlets that terminate above the roof shall have the discharge opening located not less than 40 inches (1016 mm) above the roof surface. The exhaust flow shall be directed away from the surface of the roof.

**506.3.12.2 Termination through an exterior wall.** Exhaust outlets shall be permitted to terminate through exterior walls where the smoke, grease, gases, vapors, and odors in the discharge from such terminations do not create a public nuisance or a fire hazard. Such terminations shall not be located where protected openings are required by the *New York City Building Code*. Other exterior openings shall not be located within 3 feet (914 mm) of such terminations.

**506.3.12.3 Termination location.** Exhaust outlets shall be located not less than 10 feet (3048 mm) horizontally from parts of the same or contiguous buildings, adjacent property lines and air intake openings into any building and shall be located not less than 10 feet (3048 mm) above the adjoining grade level.

**Exception:** Exhaust outlets shall terminate not less than 5 feet (1524mm) from an adjacent building, adjacent property line and air intake openings into a building where air from the exhaust outlet discharges away from such locations.

**506.4 Ducts serving Type II hoods.** Single or combined Type II exhaust systems for food-

processing operations shall be independent of all other exhaust systems. Commercial kitchen exhaust systems serving Type II hoods shall comply with Sections 506.4.1 and 506.4.2.

**506.4.1 Type II exhaust outlets.** Exhaust outlets for ducts serving Type II hoods shall comply with Sections 401.5 and 401.5.2. Such outlets shall be protected against local weather conditions and shall meet the provisions for exterior wall opening protectives in accordance with the *New York City Building Code*.

**506.4.2 Ducts.** Ducts and plenums serving Type II hoods shall be constructed of rigid metallic materials. Duct construction, installation, bracing and supports shall comply with Chapter 6. Ducts subject to positive pressure and ducts conveying moisture-laden or waste-heat-laden air shall be constructed, joined and sealed in an approved manner.

**506.4.2.1 Cooking spaces.** For all buildings other than those classified as residential occupancy, a minimum of No. 16 Gage for galvanized sheet duct shall be used for nongrease duct exhaust applications.

**506.5 Exhaust equipment.** Exhaust equipment, including fans and grease reservoirs, shall comply with Section 506.5.1 through 506.5.5 and shall be of an approved design or shall be listed for the application.

**506.5.1 Exhaust fans.** Exhaust fan housings serving a Type I hood shall be constructed as required for grease ducts in accordance with Section 506.3.1.1.

**Exception:** Fans listed and labeled in accordance with UL 762.

**506.5.1.1 Fan motor.** Exhaust fan motors shall be located outside of the exhaust airstream.

**506.5.2 Exhaust fan discharge.** Exhaust fans shall be positioned so that the discharge will not impinge on the roof, other equipment or appliances or parts of the structure. A vertical discharge fan serving a Type I hood shall be manufactured with an approved drain outlet at the lowest point of the housing to permit drainage of grease to an approved grease reservoir.

**506.5.3 Exhaust fan mounting.** An upblast fan shall be hinged and supplied with a flexible weatherproof electrical cable to permit inspection and cleaning. The ductwork shall extend a minimum of 18 inches (457 mm) above the roof surface.

**506.5.4 Clearances.** Exhaust equipment serving a Type I hood shall have a clearance to combustible construction of not less than 18 inches (457 mm).

**Exception:** Factory-built exhaust equipment installed in accordance with Section 304.1 and listed for a lesser clearance.

**506.5.5 Termination location.** The outlet of exhaust equipment serving Type I hoods, shall be in accordance with Section 506.3.12.3.

**Exception:** The minimum horizontal distance between vertical discharge fans and parapet-type building structures shall be 2 feet (610 mm) provided that such structures are not higher than the top of the fan discharge opening.

**506.5.6 Exhaust fan operation.** The operation of the exhaust fan shall be in accordance with the following requirements:

1. The hood exhaust fan(s) shall continue to operate after the exhausting system has been activated unless fan shutdown is required by a listed component of the ventilation system or by the design of the extinguishing system.
2. The hood exhaust fan shall not be required to start automatically upon activation of the extinguishing system if the exhaust fan and all cooking equipment served by the fan have previously been shut down.
3. The cooking appliances shall be interlocked with the exhaust hood system to prevent appliance operation when the exhaust hood system is not operating.

**506.6 Exterior duct installations.** The installation of exterior ducts shall comply with the following requirements:

1. The exterior portion of the ductwork shall be vertical wherever possible and shall be installed and supported on the exterior of a building.
2. Bolts, screws, rivets, and other mechanical fasteners shall not penetrate duct walls.
3. Clearance of any ducts shall comply with Section 506.3.6.
4. All ducts shall be protected on the exterior by paint or other suitable weather-protective coating.
5. Ducts constructed of stainless steel shall not be required to have additional paint or weather-protective coatings.
6. Ductwork subject to corrosion shall have minimal contact with the building surface.

**506.7 Identification of ducts.** All duct systems serving Type I and Type II exhaust equipment shall be permanently labeled: “CAUTION: KITCHEN EXHAUST SYSTEM”.

**506.8 Types I and II hoods.** All exhaust ducts serving Type I or Type II hoods shall have a minimum insulation covering of 2 inches (51 mm) of magnesium or calcium silicate block, attached with galvanized steel wire or construction equivalent in insulating and fire resistance qualities, and shall be applied to all ducts inside of the building. The insulation shall be applied up to the outer face of the discharge from the building and shall also be applied to the housing of the

exhaust fan when it is located inside of the building. Care shall be taken to insure that the insulation extends through the walls and roofs to separate the ducts from the building construction. Masonry or concrete ducts shall not require insulation.

## **SECTION MC 507** **COMMERCIAL KITCHEN HOODS**

**507.1 General.** Commercial kitchen exhaust hoods shall comply with the requirements of this section. Hoods shall be Type I or Type II and shall be designed to capture and confine cooking vapors and residues.

### **Exceptions:**

1. Factory-built commercial exhaust hoods which are tested in accordance with UL 710, listed, labeled and installed in accordance with Section 304.1 shall not be required to comply with Sections 507.4, 507.7, 507.11, 507.12, 507.13, 507.14 and 507.15.
2. Net exhaust volumes for hoods shall be permitted to be reduced during no-load cooking conditions, where engineered or listed multispeed or variable-speed controls automatically operate the exhaust system to maintain capture and removal of cooking effluents as required by this section.

**507.2 Where required.** A Type I or Type II hood shall be installed at or above all commercial cooking appliances in accordance with Sections 507.2.1 and 507.2.2. Where any cooking appliance under a single hood requires a Type I hood, a Type I hood shall be installed. Where a Type II hood is required, a Type I or Type II hood shall be installed.

**507.2.1 Type I hoods.** Type I hoods shall be installed where cooking appliances produce grease or smoke, such as occurs with griddles, fryers, broilers, ovens, ranges and wok ranges.

**507.2.2 Type II hoods.** Type II hoods shall be installed where cooking or dishwashing appliances produce heat or steam and do not produce grease or smoke, such as steamers, kettles, pasta cookers and dishwashing machines.

### **Exceptions:**

1. Under-counter-type commercial dishwashing machines.
2. A Type II hood is not required for dishwashers and potwashers that are provided with heat and water vapor exhaust systems that are supplied by the appliance manufacturer and are installed in accordance with the manufacturer's instructions.

**507.2.3 Domestic cooking appliances used for commercial purposes.** Domestic cooking appliances utilized for commercial purposes shall be provided with Type I or Type II hoods as required for the type of appliances and processes in accordance with Sections 507.2, 507.2.1

and 507.2.2.

**507.2.4 Solid fuel.** Type I hoods for use over solid fuel-burning cooking appliances shall discharge to an exhaust system that is independent of other exhaust systems.

**507.3 Fuel-burning appliances.** Where vented fuel-burning appliances are located in the same room or space as the hood, provisions shall be made to prevent the hood system from interfering with normal operation of the appliance vents.

**507.4 Type I materials.** Type I hoods shall be constructed of steel not less than 0.043 inch (1.09 mm) (No. 18 MSG) in thickness, or stainless steel not less than 0.037 inch (0.94 mm) (No. 20 MSG) in thickness.

**507.5 Type II hood materials.** Type II hoods shall be constructed of steel not less than 0.030 inch (0.76 mm) (No. 22 Gage) in thickness, stainless steel not less than 0.024 inch (0.61 mm) (No. 24 Gage) in thickness, copper sheets weighing not less than 24 ounces per square foot (7.3 kg/m<sup>2</sup>), or of other approved material and gage.

**507.6 Supports.** Type I hoods shall be secured in place by noncombustible supports. All Type I and Type II hood supports shall be adequate for the applied load of the hood, the unsupported ductwork, the effluent loading, and the possible weight of personnel working in or on the hood.

**507.7 Hood joints, seams and penetrations.** Hood joints, seams and penetrations shall comply with Sections 507.7.1 and 507.7.2.

**507.7.1 Type I hoods.** External hood joints, seams and penetrations for Type I hoods shall be made with a continuous external liquid-tight weld or braze to the lowest outermost perimeter of the hood. Internal hood joints, seams, penetrations, filter support frames, and other appendages attached inside the hood shall not be required to be welded or brazed but shall be otherwise sealed to be grease tight.

**Exceptions:**

1. Penetrations shall not be required to be welded or brazed where sealed by devices that are listed for the application.
2. Internal welding or brazing of seams, joints, and penetrations of the hood shall not be prohibited provided that the joint is formed smooth or ground so as to not trap grease, and is readily cleanable.

**507.7.2 Type II hoods.** Joints, seams and penetrations for Type II hoods shall be constructed as set forth in Chapter 6, shall be sealed on the interior of the hood and shall provide a smooth surface that is readily cleanable and water tight.

**507.8 Cleaning and grease gutters.** A hood shall be designed to provide for thorough cleaning of

the entire hood. Grease gutters shall drain to an approved collection receptacle that is fabricated, designed and installed to allow access for cleaning.

**507.9 Clearances for Type I hood.** A Type I hood shall be installed with a clearance to combustibles of not less than 18 inches (457 mm).

**Exception:** Clearance shall not be required from gypsum wallboard attached to noncombustible structures provided that a smooth, cleanable, nonabsorbent and noncombustible material is installed between the hood and the gypsum wallboard over an area extending not less than 18 inches (457 mm) in all directions from the hood.

**507.10 Hoods penetrating a ceiling.** Type I hoods or portions thereof penetrating a ceiling, wall or furred space shall comply with all the requirements of Section 506.3.10.

**507.11 Grease filters.** Type I hoods shall be equipped with UL 1046 listed grease filters designed for the specific purpose. Grease-collecting equipment shall be provided with access for cleaning. The lowest edge of a grease filter located above the cooking surface shall be not less than the height specified in Table 507.11.

**TABLE 507.11**  
**MINIMUM DISTANCE BETWEEN THE LOWEST EDGE OF A**  
**GREASE FILTER AND THE COOKING SURFACE OR THE**  
**HEATING SURFACE**  
**(Table 507.11 attached to end of document)**

**507.11.1 Criteria.** Filters shall be of such size, type and arrangement as will permit the required quantity of air to pass through such units at rates not exceeding those for which the filter or unit was designed or approved. Filter units shall be installed in frames or holders so as to be readily removable without the use of separate tools, unless designed and installed to be cleaned in place and the system is equipped for such cleaning in place. Removable filter units shall be of a size that will allow them to be cleaned in a dishwashing machine or pot sink. Filter units shall be arranged in place or provided with drip-intercepting devices to prevent grease or other condensate from dripping into food or on food preparation surfaces.

**507.11.2 Mounting position.** Filters shall be installed at an angle of not less than 45 degrees (0.79 rad) from the horizontal and shall be equipped with a drip tray beneath the lower edge of the filters.

**507.11.3 Filter servicing.** Filters shall be serviced and replaced regularly by qualified employees of the owner or by a cleaning agency. A record indicating the name of the person or firm doing the servicing and the dates when filters were cleaned or replaced shall be available for inspection by the commissioner. They shall be cleaned or replaced as frequently as necessary, but at least every three months, and no exhaust system shall be operated while cooking is being carried on without the filters installed in place.



**507.12 Canopy size and location.** The inside lower edge of canopy-type commercial cooking hoods shall overhang or extend a horizontal distance of not less than 6 inches (152 mm) beyond the edge of the cooking surface, on all open sides. The vertical distance between the front lower lip of the hood and the cooking surface shall not exceed 4 feet (1219 mm).

**Exception:** The hood shall be permitted to be flush with the outer edge of the cooking surface where the hood is closed to the appliance side by a noncombustible wall or panel.

**507.13 Capacity of hoods.** Commercial food service hoods shall exhaust a minimum net quantity of air determined in accordance with this section and Sections 507.13.1 through 507.13.4. The net quantity of exhaust air shall be calculated by subtracting any airflow supplied directly to a hood cavity from the total exhaust flow rate of a hood. Where any combination of extra-heavy-duty, heavy-duty, medium-duty, and light-duty cooking appliances are utilized under a single hood, the highest exhaust rate required by this section shall be used for the entire hood.

**507.13.1 Extra-heavy-duty cooking appliances.** The minimum net airflow for Type I hoods used for extra-heavy-duty cooking appliances shall be determined as follows:

<b><u>Type of Hood</u></b>	<b><u>CFM per linear foot of hood</u></b>
Wall-mounted canopy	550
Single island canopy	700
Double island canopy (per side)	550
Backshelf/pass-over	Not allowed
Eyebrow	Not allowed

For SI: 1 cfm per linear foot = 1.55 L/s per linear meter.

**507.13.2 Heavy-duty cooking appliances.** The minimum net airflow for Type I hoods used for heavy-duty cooking appliances shall be determined as follows:

<b><u>Type of Hood</u></b>	<b><u>CFM per linear foot of hood</u></b>
Wall-mounted canopy	400
Single island canopy	600
Double island canopy (per side)	400
Backshelf/pass-over	400
Eyebrow	Not allowed

For SI: 1 cfm per linear foot = 1.55 L/s per linear meter.

**507.13.3 Medium-duty cooking appliances.** The minimum net airflow for Type I hoods used for medium-duty cooking appliances shall be determined as follows:

<b><u>Type of Hood</u></b>	<b><u>CFM per linear foot of hood</u></b>
Wall-mounted canopy	300
Single island canopy	500

Double island canopy (per side)	300
Backshelf/pass-over	300
Eyebrow	250

For SI: 1 cfm per linear foot = 1.55 L/s per linear meter.

**507.13.4 Light-duty cooking appliances.** The minimum net airflow for Type I hoods used for light duty cooking appliances and food service preparation and cooking operations approved for use under a Type II hood shall be determined as follows:

<b><u>Type of Hood</u></b>	<b><u>CFM per linear foot of hood</u></b>
Wall-mounted canopy	200
Single island canopy	400
Double island canopy (per side)	250
Backshelf/pass-over	250
Eyebrow	250

For SI: 1 cfm per linear foot = 1.55 L/s per linear meter.

**507.14 Noncanopy size and location.** Noncanopy-type hoods shall be located a maximum of 3 feet (914 mm) above the cooking surface. The edge of the hood shall be set back a maximum of 1 foot (305 mm) from the edge of the cooking surface.

**507.15 Exhaust outlets.** Exhaust outlets located within the hood shall be located so as to optimize the capture of particulate matter. Each outlet shall serve not more than a 12-foot (3658 mm) section of hood.

**507.16 Performance test.** A performance test shall be conducted upon completion and witnessed by a representative of the Fire Department before final approval of the installation of a ventilation system serving commercial cooking appliances. The test shall verify the rate of exhaust airflow required by Section 507.13, makeup airflow required by Section 508, and proper operation as specified in this chapter. The permit holder shall furnish the necessary test equipment and devices required to perform the tests.

## **SECTION MC 508** **COMMERCIAL KITCHEN MAKEUP AIR**

**508.1 Makeup air.** Makeup air shall be supplied during the operation of commercial kitchen exhaust systems that are provided for commercial cooking appliances. The amount of makeup air supplied shall be approximately equal to the amount of exhaust air. The makeup air shall not reduce the effectiveness of the exhaust system. Makeup air shall be provided by gravity or mechanical means or both. For mechanical makeup air systems, the exhaust and makeup air systems shall be electrically interlocked to insure that makeup air is provided whenever the exhaust system is in operation. Makeup air intake opening locations shall comply with Sections 401.5 and 401.5.1.

**508.1.1 Makeup air temperature.** The temperature differential between makeup air and the air in the conditioned space shall not exceed 10°F (6°C).

**Exceptions:**

1. Makeup air that is part of the air-conditioning system.
2. Makeup air that does not decrease the comfort conditions of the occupied space.

**508.2 Compensating hoods.** Manufacturers of compensating hoods shall provide a label indicating minimum exhaust flow and/or maximum makeup airflow that provides capture and containment of the exhaust effluent.

**SECTION MC 509**  
**FIRE SUPPRESSION SYSTEMS**

**509.1 Where required.** Commercial food heat-processing appliances required by Section 507.2.1 to have a Type I hood shall be provided with an approved automatic fire suppression system complying with the *New York City Building Code* and the *New York City Fire Code*.

**SECTION MC 510**  
**HAZARDOUS EXHAUST SYSTEMS**

**510.1 General.** This section shall govern the design and construction of duct systems for hazardous exhaust and shall determine where such systems are required. Hazardous exhaust systems are systems designed to capture and control hazardous emissions generated from product handling or processes, and convey those emissions to the outdoors. Hazardous emissions include flammable vapors, gases, fumes, mists or dusts, and volatile or air-borne materials, including but not limited to perchloroethylene, posing a health hazard, such as toxic or corrosive materials. For the purposes of this section, the health-hazard rating of materials shall be as specified in NFPA 704.

**510.2 Where required.** A hazardous exhaust system shall be required wherever operations involving the handling or processing of hazardous materials, in the absence of such exhaust systems and under normal operating conditions, have the potential to create one of the following conditions:

1. A flammable vapor, gas, fume, mist or dust is present in concentrations exceeding 25 percent of the lower flammability limit of the substance for the expected room temperature.
2. A vapor, gas, fume, mist or dust with a health-hazard rating of 4 is present in any concentration.
3. A vapor, gas, fume, mist or dust with a health-hazard rating of 1, 2 or 3 is present in

concentrations exceeding 1 percent of the median lethal concentration of the substance for acute inhalation toxicity.

**510.2.1 Lumber yards and woodworking facilities.** Equipment or machinery located inside buildings at lumber yards and woodworking facilities which generates or emits combustible dust shall be provided with an approved dust-collection and exhaust system installed in conformance with this section and the *New York City Fire Code*. Equipment and systems that are used to collect, process or convey combustible dusts shall be provided with an approved explosion-control system.

**510.2.2 Combustible fibers.** Equipment or machinery within a building which generates or emits combustible fibers shall be provided with an approved dust-collecting and exhaust system. Such systems shall comply with this code and the *New York City Fire Code*.

**510.3 Design and operation.** The design and operation of the exhaust system shall be such that flammable contaminants are diluted in noncontaminated air to maintain concentrations in the exhaust flow below 25 percent of the contaminant's lower flammability limit.

**510.4 Independent system.** Hazardous exhaust systems shall be independent of other types of exhaust systems. Incompatible materials, as defined in the *New York City Fire Code*, shall not be exhausted through the same hazardous exhaust system. Hazardous exhaust systems shall not share common shafts with other duct systems, except where such systems are hazardous exhaust systems originating in the same fire area.

Contaminated air shall not be recirculated to occupied areas unless the contaminants have been removed. Air contaminated with explosive or flammable vapors, fumes or dusts; flammable or toxic gases; or radioactive material shall not be recirculated.

**510.5 Design.** Systems for removal of vapors, gases and smoke shall be designed by the constant velocity or equal friction methods. Systems conveying particulate matter shall be designed employing the constant velocity method.

**510.5.1 Balancing.** Systems conveying explosive or radioactive materials shall be prebalanced by duct sizing. Other systems shall be balanced by duct sizing with balancing devices, such as dampers. Dampers provided to balance air-flow shall be provided with securely fixed minimum-position blocking devices to prevent restricting flow below the required volume or velocity.

**510.5.2 Emission control.** The design of the system shall be such that the emissions are confined to the area in which they are generated by air currents, hoods or enclosures and shall be exhausted by a duct system to a safe location or treated by removing contaminants.

**510.5.3 Hoods required.** Hoods or enclosures shall be used where contaminants originate in a limited area of a space. The design of the hood or enclosure shall be such that air currents created by the exhaust systems will capture the contaminants and transport them directly to the

exhaust duct.

**510.5.4 Contaminant capture and dilution.** The velocity and circulation of air in work areas shall be such that contaminants are captured by an airstream at the area where the emissions are generated and conveyed into a product-conveying duct system. Contaminated air from work areas where hazardous contaminants are generated shall be diluted below the thresholds specified in Section 510.2 with air that does not contain other hazardous contaminants.

**510.5.5 Makeup air.** Makeup air shall be provided at a rate approximately equal to the rate that air is exhausted by the hazardous exhaust system. Makeup-air intakes shall be located so as to avoid recirculation of contaminated air.

**510.5.6 Clearances.** The minimum clearance between hoods and combustible construction shall be the clearance required by the duct system.

**510.5.7 Ducts.** Hazardous exhaust duct systems shall extend directly to the exterior of the building and shall not extend into or through ducts and plenums.

**510.6 Penetrations.** Penetrations of structural elements by a hazardous exhaust system shall conform to Sections 510.6.1 through 510.6.3.

**Exception:** Duct penetrations within H-5 occupancies as allowed by the *New York City Building Code*.

**510.6.1 Floors.** Hazardous exhaust systems that penetrate a floor /ceiling assembly shall be enclosed in a fire-resistance-rated shaft constructed in accordance with the *New York City Building Code*.

**510.6.2 Wall assemblies.** Hazardous exhaust duct systems that penetrate fire-resistance-rated wall assemblies shall be enclosed in fire-resistance-rated construction from the first point of penetration to the outlet terminal, except where the interior of the duct is equipped with an approved automatic fire suppression system. Ducts shall be enclosed in accordance with the *New York City Building Code* requirements for shaft construction and such enclosure shall have a minimum fire-resistance-rating of not less than the highest fire-resistance-rated wall assembly penetrated.

**510.6.3 Fire walls.** Ducts shall not penetrate a fire wall.

**510.7 Suppression required.** Ducts shall be protected with an approved automatic fire suppression system installed in accordance with the *New York City Building Code*.

**Exceptions:**

1. An approved automatic fire suppression system shall not be required in ducts conveying materials, fumes, mists and vapors that are nonflammable and noncombustible under all

conditions and at any concentrations.

2. An approved automatic fire suppression system shall not be required in ducts where the largest cross-sectional diameter of the duct is less than 10 inches (254 mm).

**510.8 Duct construction.** Ducts utilized to convey hazardous exhaust shall be constructed of approved G90 galvanized sheet steel, with a minimum nominal thickness as specified in Table 510.8.

Nonmetallic ducts utilized in systems exhausting nonflammable corrosive fumes or vapors shall be listed and labeled. Nonmetallic duct shall have a flame spread index of 25 or less and a smoke-developed index of 50 or less, when tested in accordance with ASTM E 84. Ducts shall be approved for installation in such an exhaust system.

Where the products being exhausted are detrimental to the duct material, the ducts shall be constructed of alternative materials that are compatible with the exhaust.

**TABLE 510.8**  
**MINIMUM DUCT THICKNESS**  
**(Table 510.8 attached to end of document)**

**510.8.1 Duct joints.** Ducts shall be made tight with lap joints having a minimum lap of 1 inch (25 mm).

**510.8.2 Clearance to combustibles.** Ducts shall have a clearance to combustibles in accordance with Table 510.8.2. Exhaust gases having temperatures in excess of 600°F (316°C) shall be exhausted to a chimney in accordance with Section 511.2.

**TABLE 510.8.2**  
**CLEARANCE TO COMBUSTIBLES**  
**(Table 510.8.2 attached to end of document)**

**510.8.3 Explosion relief.** Systems exhausting potentially explosive mixtures shall be protected with an approved explosion relief system or by an approved explosion prevention system designed and installed in accordance with NFPA 69. An explosion relief system shall be designed to minimize the structural and mechanical damage resulting from an explosion or deflagration within the exhaust system. An explosion prevention system shall be designed to prevent an explosion or deflagration from occurring.

**510.9 Supports.** Ducts shall be supported at intervals not exceeding 10 feet (3048 mm). Supports shall be constructed of noncombustible material.

**SECTION MC 511**  
**DUST, STOCK AND REFUSE**  
**CONVEYING SYSTEMS**

**511.1 Dust, stock and refuse conveying systems.** Dust, stock and refuse conveying systems shall comply with the provisions of Section 510 and Sections 511.1.1 through 511.2.

**511.1.1 Collectors and separators.** Cyclone collectors and separators and associated supports shall be constructed of noncombustible materials and shall be located on the exterior of the building or structure. A collector or separator shall not be located nearer than 10 feet (3048 mm) to combustible construction or to an unprotected wall or floor opening, unless the collector is provided with a metal vent pipe that extends above the highest part of any roof within a distance of 30 feet (9144 mm).

**511.1.2 Discharge pipe.** Discharge piping shall conform to the requirements for ducts, including clearances required for high-heat appliances, as contained in this code. A delivery pipe from a cyclone collector shall not convey refuse directly into the firebox of a boiler, furnace, dutch oven, refuse burner, incinerator or other appliance.

**511.1.3 Conveying system exhaust discharge.** An exhaust system shall discharge to the outside of the building either directly by flue, or indirectly through the separator, bin or vault into which the system discharges.

**511.1.4 Spark protection.** The outlet of an open-air exhaust terminal shall be protected with an approved metal or other noncombustible screen to prevent the entry of sparks.

**511.1.5 Explosion relief vents.** A safety or explosion relief vent shall be provided on all systems that convey combustible refuse or stock of an explosive nature, in accordance with the requirements of the *New York City Building Code*.

**511.1.5.1 Screens.** Where a screen is installed in a safety relief vent, the screen shall be attached so as to permit ready release under the explosion pressure.

**511.1.5.2 Hoods.** The relief vent shall be provided with an approved noncombustible cowl or hood, or with a counterbalanced relief valve or cover arranged to prevent the escape of hazardous materials, gases or liquids.

**511.2 Exhaust outlets.** Outlets for exhaust that exceed 600°F (315°C) shall be designed in accordance with Table 511.2.

The termination point for exhaust ducts discharging to the atmosphere shall not be less than the following:

1. Ducts conveying explosive or flammable vapors, fumes or dusts: 30 feet (9144 mm) from property line; 10 feet (3048 mm) from openings into the building; 6 feet (1829 mm) from

exterior walls or roofs; 30 feet (9144 mm) from combustible walls or openings into the building which are in the direction of the exhaust discharge; and 10 feet (3048 mm) above adjoining grade.

2. Other product-conveying outlets: 10 feet (3048 mm) from property line; 3 feet (914 mm) from exterior wall or roof; 10 feet (3048 mm) from openings into the building; and 10 feet (3048 mm) above adjoining grade.
3. Environmental air duct exhaust: 3 feet (914 mm) from property line; and 3 feet (914 mm) from openings into the building.

**TABLE 511.2**  
**CONSTRUCTION, CLEARANCE AND TERMINATION REQUIREMENTS FOR**  
**SINGLE-WALL METAL CHIMNEYS**  
**(Table 511.2 attached to end of document)**

**SECTION MC 512**  
**SUBSLAB SOIL EXHAUST SYSTEMS**

**512.1 General.** When a subslab soil exhaust system is provided, the duct shall conform to the requirements of this section.

**512.2 Materials.** Subslab soil exhaust system duct material shall be air duct material listed and labeled to the requirements of UL 181 for Class 0 air ducts, or any of the following piping materials that comply with the *New York City Plumbing Code* as building sanitary drainage and vent pipe: cast iron; galvanized steel; brass or copper pipe; copper tube of a weight not less than that of copper drainage tube, Type DWV; and plastic piping.

**512.3 Grade.** Exhaust system ducts shall not be trapped and shall have a minimum slope of one-eighth unit vertical in 12 units horizontal (1-percent slope).

**512.4 Termination.** Subslab soil exhaust system ducts shall extend through the roof and terminate at least 6 inches (152 mm) above the roof and at least 10 feet (3048 mm) from any operable openings or air intake.

**512.5 Identification.** Subslab soil exhaust ducts shall be permanently identified within each floor level by means of a tag, stencil or other approved marking.

**SECTION MC 513**  
**SMOKE CONTROL SYSTEMS**

**513.1 Scope and purpose.** This section applies to mechanical and passive smoke control systems that are required by the *New York City Building Code*. The purpose of this section is to establish minimum requirements for the design, installation and acceptance testing of smoke control systems that are intended to provide a tenable environment for the evacuation or relocation of



occupants. These provisions are not intended for the preservation of contents, the timely restoration of operations, or for assistance in fire suppression or overhaul activities. Smoke control systems regulated by this section serve a different purpose than the smoke- and heat-venting provisions found in Section 910 of the *New York City Building Code*.

**513.2 General design requirements.** Buildings, structures, or parts thereof required by this code to have a smoke control system or systems shall have such systems designed in accordance with the applicable requirements of Section 909 of the *New York City Building Code* and the generally accepted and well-established principles of engineering relevant to the design. The construction documents shall include sufficient information and detail to describe adequately the elements of the design necessary for the proper implementation of the smoke control systems. These documents shall be accompanied with sufficient information and analysis to demonstrate compliance with these provisions

**513.3 Special inspection and test requirements.** In addition to the ordinary inspection and test requirements which buildings, structures and parts thereof are required to undergo, smoke control systems subject to the provisions of Section 909 of the *New York City Building Code* shall undergo special inspections and tests sufficient to verify the proper commissioning of the smoke control design in its final installed condition. The design submission accompanying the construction documents shall clearly detail procedures and methods to be used and the items subject to such inspections and tests. Such commissioning shall be in accordance with generally accepted engineering practice and, where possible, based on published standards for the particular testing involved. The special inspections and tests required by this section shall be conducted under the same terms as found in Section 1704 of the *New York City Building Code*.

**513.4 Analysis.** A rational analysis supporting the types of smoke control systems to be employed, their methods of operation, the systems supporting them, and the methods of construction to be utilized shall accompany the submitted construction documents and shall include, but not be limited to, the items indicated in Sections 513.4.1 through 513.4.6.

**513.4.1 Stack effect.** The system shall be designed such that the maximum probable normal or reverse stack effects will not adversely interfere with the system's capabilities. In determining the maximum probable stack effects, altitude, elevation, weather history and interior temperatures shall be used.

**513.4.2 Temperature effect of fire.** Buoyancy and expansion caused by the design fire in accordance with Section 513.9 shall be analyzed. The system shall be designed such that these effects do not adversely interfere with its capabilities.

**513.4.3 Wind effect.** The design shall consider the adverse effects of wind. Such consideration shall be consistent with the wind-loading provisions of the *New York City Building Code*.

**513.4.4 HVAC systems.** The design shall consider the effects of the heating, ventilating and air-conditioning (HVAC) systems on both smoke and fire transport. The analysis shall include all permutations of systems' status. The design shall consider the effects of fire on the HVAC

systems.

**513.4.5 Climate.** The design shall consider the effects of low temperatures on systems, property and occupants. Air inlets and exhausts shall be located so as to prevent snow or ice blockage.

**513.4.6 Duration of operation.** All portions of active or passive smoke control systems shall be capable of continued operation after detection of the fire event for not less than 20 minutes.

**513.5 Smoke barrier construction.** Smoke barriers shall comply with the *New York City Building Code*. Smoke barriers shall be constructed and sealed to limit leakage areas exclusive of protected openings. The maximum allowable leakage area shall be the aggregate area calculated using the following leakage area ratios:

1. Walls:  $A/A_w = 0.00100$

2. Exit enclosures:  $A/A_w = 0.00035$

3. All other shafts:  $A/A_w = 0.00150$

4. Floors and roofs:  $A/A_F = 0.00050$

where:

$A$  = Total leakage area, square feet (m<sup>2</sup>).

$A_F$  = Unit floor or roof area of barrier, square feet (m<sup>2</sup>).

$A_w$  = Unit wall area of barrier, square feet (m<sup>2</sup>).

The leakage area ratios shown do not include openings due to doors, operable windows or similar gaps. These shall be included in calculating the total leakage area.

**513.5.1 Leakage area.** Total leakage area of the barrier is the product of the smoke barrier gross area times the allowable leakage area ratio. Compliance shall be determined by achieving the minimum air pressure difference across the barrier with the system in the smoke control mode for mechanical smoke control systems. Passive smoke control systems tested using other approved means such as door fan testing shall be as approved by the commissioner.

**513.5.2 Opening protection.** Openings in smoke barriers shall be protected by automatic-closing devices actuated by the required controls for the mechanical smoke control system. Door openings shall be protected by door assemblies complying with the requirements of the *New York Building Code* for doors in smoke barriers.

**Exceptions:**

1. Passive smoke control systems with automatic-closing devices actuated by spot-type smoke detectors listed for releasing service installed in accordance with the *New York City Building Code*.
2. Fixed openings between smoke zones which are protected utilizing the airflow method.
3. In Group I-2 where such doors are installed across corridors, a pair of opposite-swinging doors without a center mullion shall be installed having vision panels with approved fire-rated glazing materials in approved fire-rated frames, the area of which shall not exceed that tested. The doors shall be close-fitting within operational tolerances, and shall not have undercuts, louvers or grilles. The doors shall have head and jamb stops, astragals or rabbets at meeting edges and automatic-closing devices. Positive latching devices are not required.
4. Group I-3.
5. Openings between smoke zones with clear ceiling heights of 14 feet (4267 mm) or greater and bank down capacity of greater than 20 minutes as determined by the design fire size.

**513.5.2.1 Ducts and air transfer openings.** Ducts and air transfer openings are required to be protected with a minimum Class II, 250°F (121°C) smoke damper complying with the *New York City Building Code*.

**513.6 Pressurization method.** The primary mechanical means of controlling smoke shall be by pressure differences across smoke barriers. Maintenance of a tenable environment is not required in the smoke control zone of fire origin.

**513.6.1 Minimum pressure difference.** The minimum pressure difference across a smoke barrier shall be 0.05-inch water Gage (12.4 Pa) in fully sprinklered buildings.

In buildings permitted to be other than fully sprinklered, the smoke control system shall be designed to achieve pressure differences at least two times the maximum calculated pressure difference produced by the design fire.

**513.6.2 Maximum pressure difference.** The maximum air pressure difference across a smoke barrier shall be determined by required door-opening or closing forces. The actual force required to open exit doors when the system is in the smoke control mode shall be in accordance with the *New York City Building Code*. Opening and closing forces for other doors shall be determined by standard engineering methods for the resolution of forces and reactions. The calculated force to set a side-hinged, swinging door in motion shall be determined by:

**(Equation 5-2 attached to end of document)**

**513.7 Airflow design method.** When approved by the commissioner, smoke migration through openings fixed in a permanently open position, which are located between smoke control zones by the use of the airflow method, shall be permitted. The design airflows shall be in accordance with this section. Air-flow shall be directed to limit smoke migration from the fire zone. The geometry of openings shall be considered to prevent flow reversal from turbulent effects.

**513.7.1 Velocity.** The minimum average velocity through a fixed opening shall not be less than:

**(Equation 5-3 attached to end of document)**

**513.7.2 Prohibited conditions.** This method shall not be employed where either the quantity of air or the velocity of the airflow will adversely affect other portions of the smoke control system, unduly intensify the fire, disrupt plume dynamics or interfere with exiting. In no case shall airflow toward the fire exceed 200 feet per minute (1.02 m/s). Where the formula in Section 513.7.1 requires airflow to exceed this limit, the airflow method shall not be used.

**513.8 Exhaust method.** When approved by the commissioner, mechanical smoke control for large enclosed volumes, such as in atria or malls, shall be permitted to utilize the exhaust method. The design exhaust volumes shall be in accordance with this section.

**513.8.1 Exhaust rate.** The height of the lowest horizontal surface of the accumulating smoke layer shall be maintained at least 10 feet (3048 mm) above any walking surface which forms a portion of a required egress system within the smoke zone. The required exhaust rate for the zone shall be the largest of the calculated plume mass flow rates for the possible plume configurations. Provisions shall be made for natural or mechanical supply of outside air from outside or adjacent smoke zones to make up for the air exhausted. Makeup airflow rates, when measured at the potential fire location, shall not exceed 200 feet per minute (1.02m/s) toward the fire. The temperature of the makeup air shall be such that it does not expose temperature-sensitive fire protection systems beyond their limits.

**513.8.2 Axisymmetric plumes.** The plume mass flow rate ( $m_p$ ), in pounds per second (kg/s), shall be determined by placing the design fire center on the axis of the space being analyzed. The limiting flame height shall be determined by:

**(Equation 5-4 attached to end of document)**

**(Equation 5-5 attached to end of document)**

**513.8.3 Balcony spill plumes.** The plume mass flow rate ( $m_p$ ) for spill plumes shall be determined using the geometrically probable width based on architectural elements and projections in the following formula:

**(Equation 5-6 attached to end of document)**

**513.8.4 Window plumes.** The plume mass flow rate ( $m_p$ ) shall be determined from:

**(Equation 5-7 attached to end of document)**

**513.8.5 Plume contact with walls.** When a plume contacts one or more of the surrounding walls, the mass flow rate shall be adjusted for the reduced entrainment resulting from the contact provided that the contact remains constant. Use of this provision requires calculation of the plume diameter, that shall be calculated by:

**(Equation 5-8 attached to end of document)**

**513.9 Design fire.** The design fire shall be based on a  $Q$  of not less than 5,000 Btu per second (5275 kW) unless a rational analysis is performed by the registered design professional and approved by the commissioner. The design fire shall be based on the analysis in accordance with Section 513.4 and this section.

**513.9.1 Factors considered.** The engineering analysis shall include the characteristics of the fuel, fuel load, effects included by the fire, and whether the fire is likely to be steady or unsteady.

**513.9.2 Separation distance.** Determination of the design fire shall include consideration of the type of fuel, fuel spacing and configuration. The ratio of the separation distance to the fuel equivalent radius shall not be less than 4. The fuel equivalent radius shall be the radius of a circle of equal area to floor area of the fuel package. The design fire shall be increased if other combustibles are within the separation distance as determined by:

**(Equation 5-9 attached to end of document)**

**513.9.3 Heat-release assumptions.** The analysis shall make use of the best available data from approved sources and shall not be based on excessively stringent limitations of combustible material.

**513.9.4 Sprinkler effectiveness assumptions.** A documented engineering analysis shall be provided for conditions that assume fire growth is halted at the time of sprinkler activation.

**513.10 Equipment.** Equipment such as, but not limited to, fans, ducts, automatic dampers and balance dampers shall be suitable for their intended use, suitable for the probable exposure temperatures that the rational analysis indicates, and as approved by the commissioner.

**513.10.1 Exhaust fans.** Components of exhaust fans shall be rated and certified by the manufacturer for the probable temperature rise to which the components will be exposed. This temperature rise shall be computed by:

**(Equation 5-10 attached to end of document)**

**513.10.2 Ducts.** Duct materials and joints shall be capable of withstanding the probable temperatures and pressures to which they are exposed as determined in accordance with Section 513.10.1. Ducts shall be constructed and supported in accordance with Chapter 6. Ducts shall be leak tested to 1.5 times the maximum design operating pressure in accordance with nationally accepted practices. Measured leakage shall not exceed 5 percent of design flow. Results of such testing shall be a part of the documentation procedure. Ducts shall be supported directly from fire-resistance-rated structural elements of the building by substantial, noncombustible supports.

**Exception:** Flexible connections, for the purpose of vibration isolation, that are constructed of approved fire-resistance-rated materials.

**513.10.3 Equipment, inlets and outlets.** Equipment shall be located so as to not expose uninvolved portions of the building to an additional fire hazard. Outdoor air inlets shall be located so as to minimize the potential for introducing smoke or flame into the building. Exhaust outlets shall be so located as to minimize reintroduction of smoke into the building and to limit exposure of the building or adjacent buildings to an additional fire hazard.

**513.10.4 Automatic dampers.** Automatic dampers, regardless of the purpose for which they are installed within the smoke control system, shall be listed and conform to the requirements of approved recognized standards.

**513.10.5 Fans.** In addition to other requirements, belt-driven fans shall have 1.5 times the number of belts required for the design duty with the minimum number of belts being two. Fans shall be selected for stable performance based on normal temperature and, where applicable, elevated temperature. Calculations and manufacturer's fan curves shall be part of the documentation procedures. Fans shall be supported and restrained by noncombustible devices in accordance with the structural design requirements of the *New York City Building Code*. Motors driving fans shall not be operating beyond their nameplate horsepower (kilowatts) as determined from measurement of actual current draw. Motors driving fans shall have a minimum service factor of 1.15.

**513.11 Power systems.** The smoke control system shall be supplied with two sources of power. Primary power shall be the normal building power systems. Secondary power shall be from an approved emergency source complying with the *New York City Electrical Code*. The emergency power source and its transfer switches shall be in a separate room from the normal power transformers and switch gear and shall be enclosed in a room constructed of not less than 1-hour fire-resistance-rated fire barriers, ventilated directly to and from the exterior. Power distribution from the two sources shall be by independent routes. Transfer to full emergency power shall be automatic and within 60 seconds of failure of the primary power. The systems shall comply with the *New York City Electrical Code*.

**513.11.1 Power sources and power surges.** Elements of the smoke management system relying on volatile memories or the like shall be supplied with integral uninterruptible power sources of sufficient duration to span 15-minute primary power interruption. Elements of the

smoke management system susceptible to power surges shall be suitably protected by conditioners, suppressors or other approved means.

**513.12 Detection and control systems.** Fire detection systems providing control input or output signals to mechanical smoke control systems or elements thereof shall comply with the requirements of Chapter 9 of the *New York City Building Code*. Such systems shall be equipped with a control unit complying with UL 864 and listed as smoke control equipment.

Control systems for mechanical smoke control systems shall include provisions for verification. Verification shall include positive confirmation of actuation, testing, manual override, the presence of power downstream of all disconnects and, through a preprogrammed weekly test sequence report, abnormal conditions audibly, visually and by printed report.

**513.12.1 Wiring.** In addition to meeting the requirements of the *New York City Electrical Code*, all wiring, regardless of voltage, shall be fully enclosed within continuous raceways.

**513.12.2 Activation.** Smoke control systems shall be activated in accordance with the *New York City Building Code*.

**513.12.3 Automatic control.** Where completely automatic control is required or used, the automatic control sequences shall be initiated from an appropriately zoned automatic sprinkler system complying with Chapter 9 of the *New York City Building Code* or from manual controls that are readily accessible to the Fire Department, and any smoke detectors required by engineering analysis.

**513.13 Control-air tubing.** Control-air tubing shall be of sufficient size to meet the required response times. Tubing shall be flushed clean and dry prior to final connections. Tubing shall be adequately supported and protected from damage. Tubing passing through concrete or masonry shall be sleeved and protected from abrasion and electrolytic action.

**513.13.1 Materials.** Control-air tubing shall be hard-drawn copper, Type L, ACR in accordance with ASTM B 42, ASTM B 43, ASTM B 68, ASTM B 88, ASTM B 251 and ASTM B 280. Fittings shall be wrought copper or brass, solder type in accordance with ASME B16.18 or ASME B 16.22. Changes in direction shall be made with appropriate tool bends. Brass compression-type fittings shall be used at final connection to devices; other joints shall be brazed using a BCuP5 brazing alloy with solidus above 1,100°F (593°C) and liquids below 1,500°F (816°C). Brazing flux shall be used on copper-to-brass joints only.

**Exception:** Nonmetallic tubing used within control panels and at the final connection to devices provided all of the following conditions are met:

1. Tubing shall be listed by an approved agency for flame and smoke characteristics.
2. Tubing and connected device shall be completely enclosed within a galvanized or paint-grade steel enclosure of not less than 0.030 inch (0.76mm) (No. 22

galvanized sheet Gage) thickness. Entry to the enclosure shall be by copper tubing with a protective grommet of neoprene or teflon or by suitable brass compression to male barbed adapter.

3. Tubing shall be identified by appropriately documented coding.
4. Tubing shall be neatly tied and supported within the enclosure. Tubing bridging cabinets and doors or moveable devices shall be of sufficient length to avoid tension and excessive stress. Tubing shall be protected against abrasion. Tubing serving devices on doors shall be fastened along hinges.

**513.13.2 Isolation from other functions.** Control tubing serving other than smoke control functions shall be isolated by automatic isolation valves or shall be an independent system.

**513.13.3 Testing.** Test control-air tubing at three times the operating pressure for not less than 30 minutes without any noticeable loss in gauge pressure prior to final connection to devices.

**513.14 Marking and identification.** The detection and control systems shall be clearly marked at all junctions, accesses and terminations.

**513.15 Control diagrams.** Identical control diagrams shall be provided and maintained as required by the *New York City Fire Code*.

**513.16 Fire fighter's smoke control panel.** A fire fighter's smoke control panel for Fire Department emergency response purposes only shall be provided in accordance with the *New York City Fire Code*.

**513.17 System response time.** Smoke control system activation shall comply with the *New York City Fire Code*.

**513.18 Acceptance testing.** Devices, equipment, components and sequences shall be tested in accordance with the *New York City Fire Code*.

**513.19 System acceptance.** Acceptance of the smoke control system shall be in accordance with the *New York City Fire Code*.

**513.20 Underground building smoke exhaust system.** Where required by the *New York City Building Code* for underground buildings, a smoke exhaust system shall be provided in accordance with this section.

**513.20.1 Exhaust capability.** Where compartmentation is required, each compartment shall have an independent smoke exhaust system capable of manual operation. The system shall have an air supply and smoke exhaust capability that will provide a minimum of six air changes per hour.



**513.20.2 Operation.** The smoke exhaust system shall be operated in accordance with Section 909 of the *New York City Building Code*.

**513.20.3 Alarm required.** Activation of the smoke exhaust system shall activate an audible alarm at a constantly attended location in accordance with the *New York City Fire Code*.

## **SECTION MC 514** **ENERGY RECOVERY VENTILATION SYSTEMS**

**514.1 General.** Energy recovery ventilation systems shall be installed in accordance with this section. Where required for purposes of energy conservation, energy recovery ventilation systems shall also comply with the *Energy Conservation Construction Code of New York State*.

**514.2 Prohibited applications.** Energy recovery ventilation systems shall not be used in the following systems, unless specifically designed and/or listed for the specific applications and as part of an engineered system.

1. Hazardous exhaust systems covered in Section 510.
2. Dust, stock and refuse systems that convey explosive or flammable vapors, fumes or dust covered in Section 511.
3. Smoke control systems covered in Section 513.
4. Commercial kitchen exhaust systems serving Type I and Type II hoods covered in Section 506.
5. Clothes dryer exhaust systems covered in Section 504.

**514.3 Access.** A means of access shall be provided to the heat exchanger and other components of the system as required for service, maintenance, repair or replacement.

## **SECTION MC 515** **POST-FIRE SMOKE PURGE SYSTEMS**

**515.1 General.** Post-fire smoke purge systems shall be provided as required by Chapter 9 of the *New York City Building Code*.

## **CHAPTER 6** **DUCT SYSTEMS**

### **SECTION MC 601** **GENERAL**

**601.1 Scope.** Duct systems used for the movement of air in air-conditioning, heating, ventilating

and exhaust systems shall conform to the provisions of this chapter except as otherwise specified in Chapters 5 and 7.

**Exception:** Ducts discharging combustible material directly into any combustion chamber shall conform to the requirements of NFPA 82.

**601.2 Air movement in corridors.** Corridors shall not be used as a portion of direct supply, return, or exhaust air system serving adjoining areas. Air transfer opening(s) shall not be permitted in walls or in doors separating public corridors from adjoining areas.

**Exceptions:**

1. Where located within dwelling units, the use of corridors for conveying return air shall not be prohibited.
2. Where located within tenant spaces of 1,000 square feet (93 m<sup>2</sup>) or less in area, utilization of corridors for conveying return air is permitted.
3. Corridors in Group B office buildings equipped throughout with an automatic sprinkler system in accordance with Section 903.3.1.1 of the *New York City Building Code*.
4. Air transfer openings serving toilet rooms, bathrooms, shower rooms, sink closets, and similar auxiliary spaces opening onto the public corridor.
5. Group I-3 detention and correctional occupancies with corridor separations of open construction (e.g. grating doors or grating partitions).
6. Air transfer in openings because of pressure differential in Group I-2 health care occupancies from corridors is permitted.
7. Where door clearances do not exceed those specified for fire doors in the *New York City Building Code*, air transfer caused by pressure differentials shall be permitted.
8. Use of egress corridors as part of an engineered smoke-control system is permitted.

**601.2.1 Corridor ceiling.** Use of the space between the corridor ceiling and the floor or roof structure above as a return air plenum is permitted for one or more of the following conditions:

1. The corridor is not required to be of fire-resistance-rated construction;
2. The corridor is separated from the plenum by fire-resistance-rated construction;
3. The air-handling system serving the corridor is shut down upon activation of the air-handling unit smoke detectors required by this code;

4. The air-handling system serving the corridor is shut down upon detection of sprinkler waterflow where the building is equipped throughout with an automatic sprinkler system; or
5. The space between the corridor ceiling and the floor or roof structure above the corridor is used as a component of an approved engineered smoke control system.

**601.3 Contamination prevention.** Exhaust ducts under positive pressure, chimneys, and vents shall not extend into or pass through ducts or plenums.

## **SECTION MC 602** **PLENUMS**

**602.1 General.** Supply, return, exhaust, relief and ventilation air plenums shall be limited to uninhabited crawl spaces, areas above a finished ceiling or below the finished floor, attic spaces and mechanical equipment rooms. Plenums shall be limited to one fire area. Fuel-fired appliances shall not be installed within a plenum.

**602.2 Construction.** Plenum enclosures shall be constructed of materials permitted for the type of construction classification of the building. The temperature of air delivered to or through these plenums shall not exceed 250°F (121°C), except where used as part of an engineered smoke control system.

The use of gypsum boards to form plenums shall be limited to systems where the air temperatures do not exceed 125°F (52°C) and the building and mechanical system design conditions are such that the gypsum board surface temperature will be maintained above the air stream dew-point temperature. Air plenums formed by gypsum boards shall not be incorporated in air-handling systems utilizing evaporative coolers.

**602.2.1 Materials exposed within plenums.** Except as required by Sections 602.2.1.1 through 602.2.1.5, materials exposed within plenums shall be noncombustible or shall have a flame spread index of not more than 25 and a smoke-developed index of not more than 50 when tested in accordance with ASTM E 84.

### **Exceptions:**

1. Rigid and flexible ducts and connectors shall conform to Section 603.
2. Duct coverings, linings, tape and connectors shall conform to Sections 603 and 604.
3. This section shall not apply to materials exposed within plenums in one- and two-family dwellings.
4. This section shall not apply to smoke detectors.

5. Combustible materials enclosed in approved gypsum board assemblies or enclosed in materials listed and labeled for such application.

**602.2.1.1 Wiring.** Combustible electrical or electronic wiring methods and materials, optical fiber cable, and optical fiber raceway exposed within a plenum shall have a peak optical density not greater than 0.50, an average optical density not greater than 0.15, and a flame spread not greater than 5 feet (1524 mm) when tested in accordance with NFPA 262. Only type OFNP (plenum rated nonconductive optical fiber cable) shall be installed in plenum-rated optical fiber raceways. Wiring, cable, and raceways addressed in this section shall be listed and labeled as plenum rated and shall be installed in accordance with *New York City Electrical Code*.

**602.2.1.2 Fire sprinkler piping.** Plastic fire sprinkler piping exposed within a plenum shall be used only in wet pipe systems and shall have a peak optical density not greater than 0.50, an average optical density not greater than 0.15, and a flame spread of not greater than 5 feet (1524 mm) when tested in accordance with UL 1887. Piping shall be listed and labeled.

**602.2.1.3 Pneumatic tubing.** Combustible pneumatic tubing exposed within a plenum shall have a peak optical density not greater than 0.50, an average optical density not greater than 0.15, and a flame spread of not greater than 5 feet (1524 mm) when tested in accordance with UL 1820. Combustible pneumatic tubing shall be listed and labeled.

**602.2.1.4 Combustible electrical equipment.** Combustible electrical equipment exposed within a plenum shall have a peak rate of heat release not greater than 100 kilowatts, a peak optical density not greater than 0.50 and an average optical density not greater than 0.15 when tested in accordance with UL 2043. Combustible electrical equipment shall be listed and labeled.

**602.2.1.5 Foam plastic insulation.** Foam plastic insulation used as wall or ceiling finish in plenums shall exhibit a flame spread index of 75 or less and a smoke developed index of 450 or less when tested in accordance with ASTM E 84 and shall also comply with Section 602.2.1.5.1, 602.2.1.5.2 or 602.2.1.5.3.

**602.2.1.5.1 Separation required.** The foam plastic insulation shall be separated from the plenum by a thermal barrier complying with Section 2603.4 of the *New York City Building Code*.

**602.2.1.5.2 Approval.** The foam plastic insulation shall be approved based on tests conducted in accordance with Section 2603.8 of the *New York City Building Code*.

**602.2.1.5.3 Covering.** The foam plastic insulation shall be covered by corrosion-resistant steel having a base metal thickness of not less than 0.0160 inch (0.4 mm).

**602.3 Stud cavity and joist space plenums.** Stud wall cavities and the spaces between solid floor

joists to be utilized as air plenums shall comply with the following conditions:

1. Such cavities or spaces shall not be utilized as a plenum for supply air.
2. Such cavities or spaces shall not be part of a required fire-resistance-rated assembly.
3. Stud wall cavities shall not convey air from more than one floor level.
4. Stud wall cavities and joist space plenums shall comply with the floor penetration protection requirements of the *New York City Building Code*.
5. Stud wall cavities and joist space plenums shall be isolated from adjacent concealed spaces by approved fireblocking as required in the *New York City Building Code*.

**602.4 Flood hazard.** For structures located in areas of special flood hazard, plenum spaces shall comply with Appendix G of the *New York City Building Code*.

**602.5 Firestopping.** Where required by the *New York City Building Code* through penetrations shall be firestopped in accordance with Section 712 of the *New York City Building Code*.

**602.6 Materials.** Materials used in the construction of a plenum shall be suitable for continuous exposure to the temperature and humidity conditions of the environmental air in the plenum.

### **SECTION MC 603** **DUCT CONSTRUCTION AND INSTALLATION**

**603.1 General.** An air distribution system shall be designed and installed to supply the required distribution of air. The installation of an air distribution system shall not affect the fire protection requirements specified in the *New York City Building Code*. Ducts shall be constructed, braced, reinforced and installed to provide structural strength and durability.

**603.2 Duct sizing.** Ducts installed within a single dwelling unit shall be sized in accordance with ACCA Manual D or other approved methods. Ducts installed within all other buildings shall be sized in accordance with the ASHRAE Handbook of Fundamentals or other equivalent computation procedure.

**603.3 Duct classification.** Ducts shall be classified based on the maximum operating pressure of the duct at pressures of positive or negative 0.5, 1.0, 2.0, 3.0, 4.0, 6.0 or 10.0 inches of water column. The pressure classification of ducts shall equal or exceed the design pressure of the air distribution in which the ducts are utilized.

**603.4 Metallic ducts.** All metallic ducts shall be constructed as specified in the SMACNA *HVAC Duct Construction Standards —Metal and Flexible*.

**Exception:** Ducts installed within single dwelling units shall have a minimum thickness as

specified in Table 603.4.

**TABLE 603.4**  
**DUCT CONSTRUCTION MINIMUM SHEET METAL**  
**THICKNESS FOR SINGLE DWELLING UNITS**  
**(Table 603.4 attached to end of document)**

**603.5 Nonmetallic ducts.** Nonmetallic ducts shall be constructed with Class 0 or Class 1 duct material in accordance with UL 181. Fibrous duct construction shall conform to the SMACNA Fibrous Glass Duct Construction Standards or NAIMA Fibrous Glass Duct Construction Standards. The maximum air temperature within nonmetallic ducts shall not exceed 250°F (121°C).

**603.6 Air ducts and air connectors.** Air ducts, both metallic and nonmetallic, shall comply with Sections 603.6.1 and 603.6.1.1. Air connectors, both metallic and nonmetallic, shall comply with Sections 606.6.2 and 603.6.3.

**603.6.1 Air ducts.** Air ducts shall be permitted to be rigid or flexible and shall be constructed of materials that are reinforced and sealed to satisfy the requirements for the use of the air duct system, such as the supply air system, the return or exhaust air systems, and the variable volume/pressure air system.

**603.6.1.1 Materials.** All air duct materials shall be suitable for continuous exposure to the temperature and humidity conditions of the environmental air in the air duct. Air ducts shall be constructed of any of the following materials:

1. Iron, steel, aluminum, copper, concrete, masonry, or clay tile.
2. Class 0 or Class 1 rigid or flexible air ducts tested in accordance with UL 181 and installed in conformance with the conditions of the listing.

**Exceptions:**

1. Class 0 or Class 1 rigid or flexible air duct shall not be used as a vertical air duct that is more than two stories in height.
2. Class 0 or Class 1 rigid or flexible air ducts shall not be used for air ducts containing air at temperatures in excess of 250°F (121°C)
3. Where the temperature of the conveyed air does not exceed 125°F (52°C) in normal service, negative pressure exhaust or return air ducts shall be permitted to be constructed of gypsum board having a maximum flame spread index/rating of 25 without evidence of continued progressive combustion and a maximum smoke developed index/rating of 50. Air ducts formed by gypsum boards shall have a

surface temperature maintained above the air stream dew-point temperature, and shall not be used in air-handling systems utilizing evaporative coolers.

**Exception:** The maximum conveyed air temperature of 125°F (52°C) shall not apply to gypsum board material used for emergency smoke exhaust air ducts.

**603.6.1.2. Installation.** The materials, thickness, construction, and installation of ducts shall provide structural strength and durability in conformance with recognized good practice. Air ducts shall be considered to be in compliance with this requirement where constructed and installed in accordance with the *New York City Building Code*. Where no standard exists for the construction of air ducts, they shall be constructed to withstand both the positive and negative pressures of the system.

**603.6.2 Air Connectors.** Air connectors are limited-use, flexible air ducts that are required to conform to other provisions applicable to air ducts and shall meet the following requirements:

1. Air connectors shall conform to the requirements for Class 0 or Class 1 connectors when tested and approved in accordance with UL 181.
2. Class 0 or Class 1 air connectors shall not be used for ducts containing air at temperatures in excess of 250°F (121°C).
3. Air connector runs shall not exceed 14 feet (4267 mm) in length.
4. Air connectors shall not penetrate any rated wall, partition, or shaft that is required to have a fire resistance rating of 1 hour or more.
5. Air connectors shall not pass through floors.

**603.6.3 Flexible air duct and air connector clearance.** Flexible air ducts and air connectors shall be installed with a minimum clearance to an appliance as specified in the appliance manufacturer's installation instructions.

**603.7 Rigid duct penetrations.** Duct system penetrations of walls, floors, ceilings and roofs and air transfer openings in such building components shall be protected as required by Section 607.

**603.8 Underground ducts.** Ducts shall be approved for underground installation. Metallic ducts not having an approved protective coating shall be completely encased in a minimum of 2 inches (51 mm) of concrete.

**603.8.1 Slope.** Ducts shall slope to allow drainage to a point provided with access.

**603.8.2 Sealing.** Ducts shall be sealed and secured prior to pouring the concrete encasement.

**603.8.3 Plastic ducts and fittings.** Plastic ducts shall be constructed of PVC having a minimum pipe stiffness of 8 psi (55 kPa) at 5-percent deflection when tested in accordance with ASTM D 2412. Plastic duct fittings shall be constructed of either PVC or high-density polyethylene. Plastic duct and fittings shall be utilized in underground installations only. The maximum design temperature for systems utilizing plastic duct and fittings shall be 150°F (66°C).

**603.9 Joints, seams and connections.** All longitudinal and transverse joints, seams and connections in metallic and nonmetallic ducts shall be constructed as specified in SMACNA *HVAC Duct Construction Standards—Metal and Flexible* and SMACNA *Fibrous Glass Duct Construction Standards* or NAIMA *Fibrous Glass Duct Construction Standards*. All longitudinal and transverse joints, seams and connections shall be sealed in accordance with the *Energy Conservation Construction Code of New York State*.

**603.10 Supports.** Ducts shall be supported with approved hangers at intervals not exceeding 10 feet (3048 mm) or by other approved duct support systems designed in accordance with the *New York City Building Code*. Flexible and other factory-made ducts shall be supported in accordance with the manufacturer's installation instructions. Ducts shall not be hung from or supported by suspended ceilings.

**603.11 Furnace connections.** Ducts connecting to a furnace shall have a clearance to combustibles in accordance with the furnace manufacturer's installation instructions.

**603.11.1 Air duct at heat sources.** Where heat sources from electrical equipment, fossil fuel-burning equipment, or solar energy collection equipment are installed in air ducts, the installation shall avoid the creation of a fire hazard. Air ducts rated as Class 1 in accordance with UL 181, air duct coverings, and linings shall be interrupted at the immediate area of operation of such heat sources in order to meet the clearances specified in the equipment listing.

**Exceptions:**

- 1. Appliances listed for zero clearance from combustibles where installed with the conditions of their listings.**
- 2. Insulation specifically suitable for the maximum temperature that reasonably can be anticipated on the duct surface shall be permitted to be installed at the immediate area of operation of such appliances.**

**603.12 Condensation.** Provisions shall be made to prevent the formation of condensation on the exterior of any duct.

**603.13 Flood hazard areas.** For structures in areas of special flood hazard, ducts shall comply with Appendix G of the *New York City Building Code*.



**603.14 Location.** Ducts shall not be installed in or within 4 inches (102 mm) of the earth, except where such ducts comply with Section 603.8.

**603.15 Mechanical protection.** Ducts installed in locations where they are exposed to mechanical damage by vehicles or from other causes shall be protected by approved vehicle barriers as required by the *New York City Building Code*.

**603.16 Weather protection.** All ducts including linings, coverings and vibration isolation connectors installed on the exterior of the building shall be adequately protected against the elements.

**603.17 Registers, grilles and diffusers.** Duct registers, grilles and diffusers shall be installed in accordance with the manufacturer's installation instructions. Balancing dampers or other means of supply air adjustment shall be provided in the branch ducts or at each individual duct register, grille or diffuser.

**603.17.1 Floor registers.** Floor registers shall resist, without structural failure, a 200-pound (90.8 kg) concentrated load on a 2-inch-diameter (51 mm) disc applied to the most critical area of the exposed face.

**603.18 Vibration Isolation Connectors.** Vibration isolation connectors in duct systems shall be made of an approved flame-retardant fabric or shall consist of sleeve joints with packing of approved material, each having a maximum flame spread index/rating of 25 and a maximum smoke developed rating of 50. The fabric shall have a maximum length of 10 inches (254 mm) in the direction of air flow.

## **SECTION MC 604** **INSULATION**

**604.1 General.** Duct insulation shall conform to the requirements of Sections 604.2 through 604.13 and the *Energy Conservation Construction Code of New York State*.

**604.2 Surface temperature.** Ducts that operate at temperatures exceeding 120°F (49°C) shall have sufficient thermal insulation to limit the exposed surface temperature to 120°F (49°C).

**604.3 Coverings and linings.** Coverings and linings, including adhesives when used, shall have a flame spread index not more than 25 and a smoke-developed index not more than 50, when tested in accordance with ASTM E 84. Duct coverings and linings shall not flame, glow, smolder or smoke when tested in accordance with ASTM C 411 at the temperature to which they are exposed in service. The test temperature shall not fall below 250°F (121°C).

**604.4 Foam plastic insulation.** Foam plastic used as duct coverings and linings shall conform to the requirements of Section 604.

**604.5 Appliance insulation.** Listed and labeled appliances that are internally insulated shall be

considered as conforming to the requirements of Section 604.

**604.6 Penetration of assemblies.** Duct coverings shall not penetrate a wall or floor required to have a fire-resistance rating or required to be fireblocked.

**604.7 Identification.** External duct insulation and factory-insulated flexible duct shall be legibly printed or identified at intervals not greater than 36 inches (914 mm) with the name of the manufacturer, the thermal resistance  $R$ -value at the specified installed thickness and the flame spread and smoke-developed indexes of the composite materials. All duct insulation product  $R$ -values shall be based on insulation only, excluding air films, vapor retarders or other duct components, and shall be based on tested  $C$ -values at 75°F (24°C) mean temperature at the installed thickness, in accordance with recognized industry procedures. The installed thickness of duct insulation used to determine its  $R$ -values shall be determined as follows:

1. For duct board, duct liner and factory-made rigid ducts not normally subjected to compression, the nominal insulation thickness shall be used.
2. For duct wrap, the installed thickness shall be assumed to be 75 percent (25-percent compression) of nominal thickness.
3. For factory-made flexible air ducts, the installed thickness shall be determined by dividing the difference between the actual outside diameter and nominal inside diameter by two.

**604.8 Lining installation.** Linings shall be interrupted at the area of operation of a fire damper and at a minimum of 6 inches (152 mm) upstream of and 6 inches (152 mm) downstream of electric-resistance and fuel-burning heaters in a duct system. Metal nosings or sleeves shall be installed over exposed duct liner edges that face opposite the direction of airflow.

**604.9 Thermal continuity.** Where a duct liner has been interrupted, a duct covering of equal thermal performance shall be installed.

**604.10 Service openings.** Service openings shall not be concealed by duct coverings unless the exact location of the opening is properly identified.

**604.11 Vapor retarders.** Where ducts used for cooling are externally insulated, the insulation shall be covered with a vapor retarder having a maximum permeance of 0.05 perm [2.87 ng/(Pa • s • m<sup>2</sup>)] or aluminum foil having a minimum thickness of 2 mils (0.051 mm). Insulations having a permeance of 0.05 perm [2.87 ng/(P • s • m<sup>2</sup>)] or less shall not be required to be covered. All joints and seams shall be sealed to maintain the continuity of the vapor retarder.

**604.12 Weatherproof barriers.** Insulated exterior ducts shall be protected with an approved weatherproof barrier.

**604.13 Internal insulation.** Materials used as internal insulation and exposed to the airstream in ducts shall be shown to be durable when tested in accordance with UL 181. Exposed internal

insulation that is not impermeable to water shall not be used to line ducts or plenums from the exit of a cooling coil to the downstream end of the drain pan.

## **SECTION MC 605** **AIR FILTERS**

**605.1 General.** Heating and air-conditioning systems of the central type shall be provided with approved air filters. Filters shall be installed in the return air system, upstream from any heat exchanger or coil, in an approved convenient location. Liquid adhesive coatings used on filters shall have a flash point not lower than 325°F (163°C).

**605.2 Standards.** Media-type and electrostatic-type air filters shall be listed and labeled. Media-type air filters shall comply with UL 900. High-efficiency particulate air filters shall comply with UL 586. Electrostatic-type air filters shall comply with UL 867. Air filters utilized within dwelling units shall be designed for the intended application and shall not be required to be listed and labeled.

**605.3 Airflow over the filter.** Ducts shall be constructed to allow an even distribution of air over the entire filter.

**605.4 Liquid adhesive tanks.** Tanks for liquid adhesives, into which removable filters are dipped, shall be located either outside the building or, if such a location is not available, in a separate fire resistive room and stored in accordance with NFPA 30. Such tanks shall be metal, equipped with tight-fitting covers and shall be kept tightly covered when not in actual use.

**605.5 Filter maintenance.** All air filters shall be kept free of excess dust and combustible material. Unit filters shall be renewed or cleaned when the resistance to airflow has increased to two times the original resistance or when the resistance has reached a value of recommended replacement by the manufacturer. A permanently installed draft gauge shall be provided for this purpose. Where the filters are of the automatic liquid adhesive type, sludge shall be removed from the liquid adhesive reservoir regularly.

## **SECTION MC 606** **SMOKE DETECTION SYSTEMS CONTROL**

**606.1 Controls required.** Air distribution systems shall be equipped with smoke detectors listed and labeled for installation in air distribution systems, as required by this section.

**606.2 Where required.** Smoke detectors shall be installed where indicated in Sections 606.2.1 through 606.2.4.

**Exception:** Smoke detectors shall not be required where air distribution systems are incapable of spreading smoke beyond the enclosing walls, floors and ceilings of the room or space in which the smoke is generated.

**606.2.1 Return air systems.** Smoke detectors shall be installed in return air systems with a design capacity greater than 2,000 cfm (0.9 m<sup>3</sup>/s), in the return air duct or plenum upstream of any filters, exhaust air connections, outdoor air connections, or decontamination equipment and appliances.

**Exception:** Smoke detectors are not required in the return air system where all portions of the building served by the air distribution system are protected by area smoke detectors connected to a fire alarm system in accordance with the *New York City Fire Code*. The area smoke detection system shall comply with Section 606.4.

**606.2.2 Common supply and return air systems.** Where multiple air-handling systems share common supply or return air ducts or plenums with a combined design capacity greater than 2,000 cfm (0.9 m<sup>3</sup>/s), the return air system shall be provided with smoke detectors in accordance with Section 606.2.1.

**Exception:** Individual smoke detectors shall not be required for each fan-powered terminal unit, provided that such units do not have an individual design capacity greater than 2,000 cfm (0.9 m<sup>3</sup>/s) and will be shut down by activation of one of the following:

1. Smoke detectors required by Sections 606.2.1 and 606.2.3.
2. An approved area smoke detector system located in the return air plenum serving such units.
3. An area smoke detector system as prescribed in the exception to Section 606.2.1.

In all cases, the smoke detectors shall comply with Sections 606.4 and 606.4.1.

**606.2.3 Return air risers.** Where return air risers serve two or more stories and serve any portion of a return air system having a design capacity greater than 15,000 cfm (7.1 m<sup>3</sup>/s), smoke detectors shall be installed at each story. Such smoke detectors shall be located upstream of the connection between the return air riser and any air ducts or plenums.

**606.2.4 Supply air systems.** Smoke detectors listed for use in air distribution systems shall be installed downstream of the air filters and ahead of any branch connections in air supply systems having a capacity greater than 2,000 cfm (0.9 m<sup>3</sup>/s).

**606.3 Installation.** Smoke detectors required by this section shall be installed in accordance with the *New York City Electrical Code*. The required smoke detectors shall be installed to monitor the entire airflow conveyed by the system including supply air, return air and exhaust or relief air. Access shall be provided to smoke detectors for inspection and maintenance.

**606.4 Controls operation.** Upon activation, the smoke detectors shall automatically shut down their respective air distribution system(s). Air distribution systems that are part of a smoke control system shall switch to the smoke control mode upon activation of a detector.

**606.4.1 Supervision.** The duct smoke detectors shall be connected to a fire alarm system. The actuation of a duct smoke detector shall activate a visible and audible supervisory signal at a constantly attended location.

**Exceptions:**

1. The supervisory signal at a constantly attended location is not required where the duct smoke detector activates the building's alarm-indicating appliances.
2. In occupancies not required to be equipped with a fire alarm system, actuation of either area or duct smoke detector shall activate a visible and an audible signal in an approved location. Additionally, duct smoke detector trouble conditions shall activate a visible or audible signal in an approved location and shall be identified as air duct detector trouble.

**606.4.2 Fan shutdown.** When any building or floor is provided with an air system utilizing recirculated air and is protected by an automatic sprinkler system or an automatic fire alarm system, provisions shall be made to automatically stop the fans serving the affected area when the sprinkler system or fire alarm system are installed in the area, it shall be required to have only one of these systems arranged to stop the fans.

**Exceptions:**

1. Activation of a manual pull station shall not be required to automatically stop the fans.
2. Systems having a capacity of 2,000 cfm (0.2 m<sup>3</sup>/s) or less or serving not more than one floor.

**606.4.3 Manual restart of fans after automatic fire detecting device or fire alarm system shutdown.** Fans or fan system which have been automatically shut down on activation of an automatic fire detecting device or fire alarm system shall be arranged and equipped so that they do not automatically restart when either the automatic fire detecting device or fire alarm system is reset. The manual means of restarting the fans or fan system shall function independently from the manual resetting of either the automatic fire detecting device or fire alarm system.

**SECTION MC 607**  
**DUCTS AND AIR TRANSFER OPENINGS**

**607.1 General.** The provisions of this section shall govern the protection of duct penetrations and air transfer openings in fire-resistance-rated assemblies.

**607.1.1 Ducts and air transfer openings without dampers.** Ducts and air transfer openings

that penetrate fire-resistance-rated assemblies and are not required to have dampers by this section shall comply with the requirements of Section 712 of the *New York City Building Code*.

**607.2 Installation.** Fire dampers, smoke dampers, combination fire/smoke dampers and ceiling dampers located within air distribution and smoke control systems shall be installed in accordance with the requirements of this section, and the manufacturer's installation instructions and listing.

**607.2.1 Smoke control system.** Where the installation of a fire damper will interfere with the operation of a required smoke control system in accordance with Section 513, approved alternative protection shall be utilized.

**607.2.1.1 Remote operation.** Combination fire and smoke dampers shall be operable by remote controls where necessary for smoke removal. Such dampers shall have provisions that allow them to re-close automatically upon reaching the damper's maximum degradation test temperature in accordance with UL 555S.

**607.2.2 Hazardous exhaust ducts.** Fire dampers for hazardous exhaust duct systems shall comply with Section 510.

**607.2.3 Supply air systems.** Smoke dampers listed for use in air distribution systems shall be installed both upstream and downstream of filters and ahead of any branch connections in supply air-handling apparatus and systems having a capacity equal to or greater than 15,000 cfm (7.1 m<sup>3</sup>/s).

**Exceptions:**

1. Where the air-handling unit is located on the floor that it serves and serves only that floor.
2. Where the air-handling unit is located on the roof and serves only the floor immediately below the roof.
3. Existing buildings using only UL 90D Class 1 filters shall be exempt from this subdivision provided the control system is arranged to shut down the fresh air intake, return air, and exhaust air dampers, and fan shutdown and smoke detection is provided in accordance with Section 606.

**607.3 Damper testing and ratings.** Dampers shall be listed and bear the label of an approved testing agency indicating compliance with the standards in this section. Fire dampers shall comply with the requirements of UL 555. Only fire dampers labeled for use in dynamic systems shall be installed in heating, ventilation and air-conditioning systems designed to operate with fans on during a fire. Smoke dampers shall comply with the requirements of UL 555S. Combination fire/smoke dampers shall comply with the requirements of both UL 555 and UL 555S. Ceiling radiation dampers shall comply with the requirements of UL 555C.

**607.3.1 Fire protection rating.** Fire dampers shall have the minimum fire protection rating specified in Table 607.3.1 for the type of penetration.

**TABLE 607.3.1**  
**FIRE DAMPER RATING**  
**(Table 607.3.1 attached to end of document)**

**607.3.1.1 Fire damper actuating device.** The fire damper actuating device shall meet one of the following requirements:

1. The operating temperature shall be approximately 50°F (27.8°C) above the normal temperature within the duct system, but not less than 160°F (71°C).
2. The operating temperature shall be not more than 286°F (141°C) where located in a smoke control system complying with Section 513.
3. Where a combination fire/smoke damper is located in a smoke control system complying with Section 513, the operating temperature rating shall be approximately 50°F (27.8°C) above the maximum smoke control system designed operating temperature, or a maximum temperature of 350°F (177°C). The temperature shall not exceed the UL 555S degradation test temperature rating for a combination fire/smoke damper.

**607.3.2 Smoke damper ratings.** Smoke damper leakage ratings shall not be less than Class II. Elevated temperature ratings shall be not less than 250°F (121°C).

**607.3.2.1 Smoke damper actuation methods.** The smoke damper shall close upon actuation of a listed smoke detector or detectors installed in accordance with Section 606 of this code and Sections 907.10 and 907.11 of the *New York City Building Code* and one of the following methods, as applicable:

1. Where a damper is installed within a duct, a smoke detector shall be installed in the duct within 5 feet (1524 mm) of the damper with no air outlets or inlets between the detector and the damper. The detector shall be listed for the air velocity, temperature and humidity anticipated at the point where it is installed. Other than in mechanical smoke control systems, dampers shall be closed upon fan shutdown where local smoke detectors require a minimum velocity to operate.
2. Where a damper is installed above smoke barrier doors in a smoke barrier, a spot-type detector listed for releasing service shall be installed on either side of the smoke barrier door opening.
3. Where a damper is installed within an unducted opening in a wall, a spot-type detector listed for releasing service shall be installed within 5 feet (1524 mm)

horizontally of the damper.

4. Where a damper is installed in a corridor wall, the damper shall be permitted to be controlled by a smoke detection system installed in the corridor.
5. Where a total-coverage smoke detector system is provided within areas served by an HVAC system, dampers shall be permitted to be controlled by the smoke detection system.
6. Smoke dampers that are part of an engineered smoke control system shall be capable of being positioned manually from a command station. Such positioning devices shall be provided for supply and return/exhaust dampers grouped by floor and by type. Damper switch positions shall indicate whether the related dampers are commanded to be either open or closed. Smoke damper positioning switches shall be located at the Fire Command Station, or in a Mechanical Control Center in buildings without a Fire Command Station.

**607.4 Access and identification.** Fire and smoke dampers shall be provided with an approved means of access, large enough to permit inspection and maintenance of the damper and its operating parts. The access shall not affect the integrity of fire-resistance-rated assemblies. The access openings shall not reduce the fire-resistance rating of the assembly. Access points shall be permanently identified on the exterior by a label having letters not less than 0.5 inch (12.7 mm) in height reading: SMOKE DAMPER or FIRE DAMPER, followed by an identification marking that is unique to the damper accessed. Access doors in ducts shall be tight fitting and suitable for the required duct construction.

**607.5 Where required.** Fire dampers, smoke dampers, combination fire/smoke dampers and ceiling radiation dampers shall be provided at the locations prescribed in this section. Where an assembly is required to have both fire dampers and smoke dampers, combination fire/smoke dampers or a fire damper and a smoke damper shall be required.

**Exceptions:**

1. Smoke dampers shall not be required on air systems other than where necessary for the proper function of that system where the system is designed specifically to:
  - 1.1. Function as an engineered smoke-control system, including the provision of continuous air movement with the air-handling system; or
  - 1.2. Provide air to other areas of the building during a fire emergency; or
  - 1.3. Provide pressure differentials during a fire emergency.



2. Smoke dampers shall not be required to be located within a prescribed distance of a fire rated enclosure where isolation smoke dampers are used in air-handling equipment (Refer to Section 607.2.3).

3. Smoke dampers shall not be required in ducts where the air continues to move and the air-handling system installed is arranged to prevent recirculation of exhaust or return air under fire emergency conditions.

**607.5.1 Fire walls.** Ducts and air transfer openings permitted in firewalls in accordance with Section 705.11 of the *New York City Building Code* shall be protected with approved fire dampers and smoke dampers installed in accordance with their listing.

**607.5.2 Fire barriers.** Duct penetrations and air transfer openings in fire barriers shall be protected with approved fire dampers installed in accordance with their listing. In addition, smoke dampers shall be installed in penetrations of public corridor walls in accordance with Section 607.5.2.1.

**Exceptions:** Fire dampers are not required at penetrations of fire barriers where any of the following apply:

1. Penetrations are tested in accordance with ASTM E 119 as part of the fire-resistance-rated assembly.
2. Where permitted under Section 513 and ducts are part of an engineered smoke control system.
3. Such walls are penetrated by ducted HVAC systems, have a required fire resistance rating of 1 hour or less, are in areas of other than Group H and are in buildings equipped throughout with an automatic sprinkler system in accordance with Section 903.3.1.1 or 903.3.1.2 of the *New York City Building Code*. For the purposes of this exception, a ducted HVAC system shall be a duct system for the structure's HVAC system. Such a duct system shall be constructed of sheet metal not less than 26-Gage (0.0217-inch) [0.55-mm] thickness and shall be continuous from the air-handling appliance or equipment to the air outlet and inlet terminals.

**607.5.2.1 Public corridors.** A listed smoke damper designed to resist the passage of smoke shall be provided at each point a duct or air transfer opening penetrates a public corridor wall constructed as a fire barrier.

**Exceptions:**

1. Smoke dampers are not required where the building is equipped throughout with an approved smoke control system in accordance with Section 909, and smoke dampers are not necessary for the operation and control of the system.

2. Smoke dampers are not required in corridor penetrations where the duct is constructed of steel not less than 0.019-inch (0.48 mm) in thickness and there are no openings serving the corridor.
3. Smoke dampers are not required in corridor penetrations in Group R-2 buildings and spaces.

**607.5.3 Fire partitions.** Duct penetrations in fire partitions shall be protected with approved fire dampers installed in accordance with their listing.

**Exceptions:** In occupancies other than Group H, fire dampers are not required where any of the following apply:

1. The partitions are tenant separation and corridor walls in buildings equipped throughout with an automatic sprinkler system in accordance with Section 903.3.1.1 or 903.3.1.2 of the *New York City Building Code* and the duct is protected as a through penetration in accordance with the *New York City Building Code*.
2. The duct system is constructed of approved materials in accordance with this code and the duct penetrating the wall meets all of the following minimum requirements.
  - 2.1. The duct shall not exceed 100 square inches (0.06 m<sup>2</sup>).
  - 2.2. The duct shall be constructed of steel a minimum of 0.0217-inch (0.55 mm) in thickness.
  - 2.3. The duct shall not have openings that communicate the corridor with adjacent spaces or rooms.
  - 2.4. The duct shall be installed above a ceiling.
  - 2.5. The duct shall not terminate at a wall register in the fire-resistance-rated wall.
  - 2.6. A minimum 12-inch-long (304.8 mm) by 0.060-inch-thick (1.52 mm) steel sleeve shall be centered in each duct opening. The sleeve shall be secured to both sides of the wall and all four sides of the sleeve with minimum 1½-inch by 1½-inch by 0.060-inch (38 mm by 38 mm by 1.52 mm) steel retaining angles. The retaining angles shall be secured to the sleeve and the wall with No. 10 (M5) screws. The annular space between the steel sleeve and the wall opening shall be filled with rock (mineral) wool batting or approved equivalent on all sides.

**607.5.4 Smoke barriers.** A listed smoke damper designed to resist the passage of smoke shall be provided at each point where a duct or an air transfer opening penetrates a smoke barrier wall enclosure required to have smoke and draft control doors in accordance with the *New*

York City Building Code. Smoke dampers and smoke damper actuation methods shall comply with Section 607.5.4.1.

**Exception:** Smoke dampers are not required in smoke barrier penetrations where the openings in ducts are limited to a single smoke compartment and the ducts are constructed of steel.

**607.5.4.1 Smoke damper.** The smoke damper shall close upon actuation of a listed smoke detector or detectors installed in accordance with the *New York City Building Code* and Section 607.3.2.1.

**607.5.5 Shaft enclosures.** Ducts and air transfer openings shall not penetrate a shaft serving as an exit enclosure except as permitted by Section 1019.1.2 of the *New York City Building Code*.

**607.5.5.1 Penetrations of shaft enclosures.** Shaft enclosures that are permitted to be penetrated by ducts and air transfer openings shall be protected with approved fire and smoke dampers installed in accordance with their listing.

**Exceptions:**

1. Fire dampers are not required at penetrations of shafts where:
  - 1.1. Steel exhaust subducts extend at least 22 inches (559 mm) vertically in exhaust shafts provided there is a continuous airflow upward to the outside, or
  - 1.2. Penetrations are tested in accordance with ASTM E 119 as part of the fire-resistance-rated assembly, or
  - 1.3. Ducts are used as part of an approved smoke control system designed and installed in accordance with Section 513 of this code, and where the fire damper will interfere with the operation of the smoke control system, or
  - 1.4. The penetrations are in parking garage exhaust or supply shafts that are separated from other building shafts by not less than 2-hour fire-resistance-rated construction.
2. In Group B occupancies, equipped throughout with an automatic sprinkler system in accordance with Section 903.3.1.1 of the *New York City Building Code*, smoke dampers are not required at penetrations of shafts where:
  - 2.1. Bathroom and toilet room exhaust openings with steel exhaust subducts, having a wall thickness of at least 0.019 inch (0.48 mm) extend at least 22 inches (559 mm) vertically and where the exhaust fan at the upper terminus is powered continuously in accordance with the provisions of Section

909.11 of the *New York City Building Code*, and maintains airflow upward to the outside, or

- 2.2. Ducts are used as part of an approved smoke control system designed and installed in accordance with Section 909 of the *New York City Building Code*, and where the smoke damper will interfere with the operation of the smoke control system.
3. Smoke dampers are not required at penetration of exhaust or supply shafts in parking garages that are separated from other building shafts by not less than 2-hour fire-resistance-rated construction.
4. Fire dampers and/or smoke dampers shall not be required at a shaft where the shaft is acting as an extension of the mechanical equipment room that it serves and the shaft and mechanical equipment room maintain fire and smoke separation required by the greater of the two spaces from the occupied portions of the building and meet the requirements of Section 707.11 of the *New York City Building Code*.
5. Smoke dampers shall not be required to be located within a prescribed distance of a fire rated enclosure where isolation smoke dampers are used in air-handling equipment.
6. Smoke dampers shall not be required in ducts where the air continues to move and the air-handling system installed is arranged to prevent recirculation of exhaust or return air under fire emergency conditions.

**607.5.5.2 Limitations.** Shafts that constitute air ducts or that enclose air ducts used for the movement of environmental air shall not enclose:

1. Exhaust ducts used for the removal of smoke and grease-laden vapors from cooking equipment;
2. Ducts used for removal of flammable vapors;
3. Ducts used for moving, conveying, or transporting stock, vapor or dust;
4. Ducts used for the removal of nonflammable corrosive fumes and vapors;
5. Refuse and linen chutes; or
6. Piping.

**Exception:** Shafts that constitute air ducts or that enclose air ducts used for the movement of environmental air may enclose noncombustible piping conveying water or other nonhazardous or nontoxic materials.

**607.6 Horizontal assemblies.** Penetrations by air ducts of a floor, floor/ceiling assembly or the ceiling membrane of a roof/ceiling assembly shall be protected by a shaft enclosure that complies with the *New York City Building Code* or shall comply with this section.

**607.6.1 Through penetrations.** In occupancies other than Groups I-2 and I-3, a duct and air transfer opening system constructed of approved materials in accordance with this code that penetrates a fire-resistance-rated floor/ceiling assembly that connects not more than two stories is permitted without shaft enclosure protection provided a fire damper is installed at the floor line and the penetration is firestopped.

**Exception:** A duct serving a dwelling unit is permitted to penetrate three floors or less without a fire damper at each floor provided it meets all of the following requirements.

1. The duct shall be contained and located within the cavity of a wall and shall be constructed of steel not less than 0.019 inch (0.48 mm) (26 gauge) in thickness.
2. The duct shall open into only one dwelling unit and the duct system shall be continuous from the unit to the exterior of the building.
3. The duct shall not exceed 5-inch (127 mm) nominal diameter and the total area of such ducts shall not exceed 100 square inches (64 516 mm<sup>2</sup>) for any 100 square feet (9.3 m<sup>2</sup>) of the floor area.
4. The annular space around the duct is protected with materials that prevent the passage of flame and hot gases sufficient to ignite cotton waste where subjected to ASTM E 119 time-temperature conditions under a minimum positive pressure differential of 0.01 inch (2.49 Pa) of water at the location of the penetration for the time period equivalent to the fire-resistance rating of the construction penetrated.
5. Grille openings located in a ceiling of a fire-resistance-rated floor/ceiling or roof/ceiling assembly shall be protected with a ceiling radiation damper in accordance with Section 607.6.2.

**607.6.2 Membrane penetrations.** Where duct systems constructed of approved materials in accordance with this code penetrate a ceiling of a fire-resistance-rated floor/ceiling or roof/ceiling assembly, shaft enclosure protection is not required provided an approved ceiling radiation damper and firestopping is installed at the ceiling line. Where a duct is not attached to a diffuser that penetrates a ceiling of a fire-resistance-rated floor/ceiling or roof/ceiling assembly, shaft enclosure protection is not required provided an approved ceiling radiation damper and firestopping is installed at the ceiling line. Ceiling radiation dampers shall be installed in accordance with UL 555C and constructed in accordance with the details listed in a

fire-resistance-rated assembly or shall be labeled to function as a heat barrier for air-handling outlet/inlet penetrations in the ceiling of a fire-resistance-rated assembly. Ceiling radiation dampers shall not be required where ASTM E 119 fire tests have shown that ceiling radiation dampers are not necessary in order to maintain the fire-resistance rating of the assembly. Ceiling radiation damper shall not be required where exhaust duct penetrations are protected in accordance with Section 712.4.2 of the *New York City Building Code* and the exhaust ducts are located within the cavity of a wall, and do not pass through another dwelling unit or tenant space.

**607.6.3 Nonfire-resistance-rated assemblies.** Duct systems constructed of approved materials in accordance with this code that penetrate nonfire-resistance-rated floor assemblies that connect not more than two stories are permitted without shaft enclosure protection provided that the annular space between the assembly and the penetrating duct is filled with an approved noncombustible material to resist the free passage of flame and the products of combustion. Duct systems constructed of approved materials in accordance with this code that penetrate nonrated floor assemblies that connect not more than three stories are permitted without shaft enclosure protection provided that the annular space between the assembly and the penetrating duct is filled with an approved noncombustible material to resist the free passage of flame and the products of combustion, and a fire damper is installed at each floor line.

**Exception:** Fire dampers are not required in ducts within individual residential dwelling units.

**607.7 Flexible ducts and air connectors.** Flexible ducts and air connectors shall not pass through any fire-resistance-rated assembly.

## **SECTION MC 608** **AIR OUTLETS AND AIR INLETS**

**608.1 Air Outlets.** Air outlets shall comply with sections 608.1.1 through 608.1.3

**608.1.1 General.** Air supplied to any space shall not contain flammable vapors, flyings, or dust in quantities and concentrations that would introduce a hazardous condition.

**608.1.2 Construction of air outlets.** Air outlets shall be constructed of noncombustible material or a material that has a maximum smoke developed index/rating of 50 and a maximum flame spread index/rating of 25.

**608.1.3 Location of air outlets.** The location of air outlets shall comply with the following requirements:

1. Air outlets shall be located at least 3 inches (76 mm) above the floor.

**Exception:** Air outlets may be located less than 3 inches (76mm) above the floor where provisions have been made to prevent dirt and dust accumulations from entering the system.

2. Where located less than 7 feet (2134 mm) above the floor, outlet openings shall be protected by a grille or screen having openings through which a ½-inch (12.7 mm) sphere cannot pass.
3. Grilles may be located in floors provided they are installed so that they may be removed for cleaning purposes and provided they are constructed as follows:
  - 3.1 Grilles up to 3 square feet (0.2787 m<sup>2</sup>) in gross area shall be designed to support a concentrated live load of 250 pounds (114 kg) on any 4 square inches (2580 mm<sup>2</sup>) of surface.
  - 3.2 Grilles over 3 square feet (0.2787 m<sup>2</sup>) in gross area shall be designed to support the same loads as the floor in the area where used.
  - 3.3 If located where they may be walked upon, the opening in grilles shall reject a ½-inch (12.7 mm) sphere.

**608.2 Air inlets (return or exhaust or return and exhaust).** Air inlets shall be constructed in accordance with 608.2.1 through 608.2.3.

**608.2.1 General.** Air shall not be recirculated from any space in which flammable vapors, flyings, or dust is present in quantities and concentrations that would introduce a hazardous condition into the return air system.

**608.2.2 Construction of air inlets.** Air inlets shall be constructed of noncombustible material or a material that has a maximum flame spread index/rating of 25 and a maximum smoke developed index/rating of 50.

**608.2.3 Location of air inlets.** The location of air inlets shall comply with the following requirements.

1. Air inlets shall be located at least 3 inches (76 mm) above the floor.

**Exception:** Air inlets may be located less than 3 inches (76mm) above the floor where provisions have been made to prevent dirt and dust accumulations from entering the system.

2. Where located less than 7 feet (2134 mm) above the floor, inlet openings shall be protected by a grille or screens having openings through which a ½-inch (12.7 mm) sphere cannot pass.

3. Grilles may be located in floors provided they are installed so that they may be removed for cleaning purposes and provided they are constructed as follows:
  - 3.1. Grilles up to 3 square feet (0.2787 m<sup>2</sup>) in gross area shall be designed to support a concentrated live load of 250 pounds (114 kg) on any 4 square inches (2580 mm<sup>2</sup>) of surface.
  - 3.2. Grilles over 3 square feet (0.2787 m<sup>2</sup>) in gross area shall be designed to support the same loads as the floor in the area where used.
  - 3.3. If located where they may be walked upon, the opening in grilles shall reject a ½-inch (12.7 mm) sphere.

### **SECTION MC 609** **SERVICE OPENINGS**

**609.1 General.** Horizontal air ducts and plenums shall be provided with service openings to facilitate the removal of accumulations of dust and combustible materials. Service openings shall be located at approximately 20 feet (6096 mm) intervals along the air duct and at the base of each vertical riser.

#### **Exceptions:**

1. Removable air outlet or air inlet devices of adequate size shall be permitted in lieu of service openings.
2. Service openings shall not be required in supply ducts where the supply air has previously passed through an air filter, air cleaner, or water spray. Such air filters and air cleaners shall be properly maintained and replaced when needed.
3. Service openings shall not be required where all of the following conditions exist:
  - 3.1. The occupancy has no process producing combustible material such as dust, lint, or greasy vapors. Such occupancies include banks, office buildings, churches, hotels, and health care facilities (but not kitchens, laundries, and manufacturing portions of such facilities).
  - 3.2. The air inlets are at least 7 feet (2134 mm) above the floor or are protected by corrosion-resistant metal screens of at least 14 mesh (0.07 inches) (1.8 mm) that are installed at the inlets so that they cannot draw papers, refuse, or other combustible solids into the return air duct.
  - 3.3. The minimum design velocity in the return duct for the particular occupancy is 1000 feet/minute (5.080 m/s).



**CHAPTER 7**  
**COMBUSTION AIR**

**SECTION MC 701**  
**GENERAL**

**701.1 Scope.** The provisions of this chapter shall govern the requirements for combustion and dilution air for fuel-burning appliances other than gas-fired appliances. The requirements for combustion and dilution air for gas-fired appliances shall be in accordance with the *New York City Fuel Gas Code*.

**701.2 Combustion and dilution air required.** Every room or space containing fuel-burning appliances shall be provided with combustion and dilution air as required by this code. Combustion and dilution air shall be provided in accordance with Section 702, 703, 704, 705, 706 or 707. Direct vent appliances or equipment that do not draw combustion air from inside of the building are not required to be considered in the determination of the combustion and dilution air requirements. Combustion air requirements shall be determined based on the simultaneous operation of all fuel-burning appliances drawing combustion and dilution air from the room or space. The combustion air system shall maintain the room in which the equipment is located at a pressure not less than the outdoor atmosphere pressure.

**701.3 Circulation of air.** The equipment and appliances within every room containing fuel-burning appliances shall be installed so as to allow free circulation of air. Provisions shall be made to allow for the simultaneous operation of mechanical exhaust systems, fireplaces or other equipment and appliances operating in the same room or space from which combustion and dilution air is being drawn. Such provisions shall prevent the operation of such appliances, equipment and systems from affecting the supply of combustion and dilution air.

**701.4 Crawl space and attic space.** For the purposes of this chapter, an opening to a naturally ventilated crawl space or attic space shall be considered equivalent to an opening to the outdoors.

**701.4.1 Crawl space.** Where lower combustion air openings connect with crawl spaces, such spaces shall have unobstructed openings to the outdoors at least twice that required for the combustion air openings. The height of the crawl space shall comply with the requirements of the *New York City Building Code* and shall be without obstruction to the free flow of air.

**701.4.2 Attic space.** Where combustion air is obtained from an attic area, the attic ventilating openings shall not be subject to ice or snow blockage, and the attic shall have not less than 30 inches (762 mm) vertical clear height at its maximum point. Attic ventilation openings shall be sufficient to provide the required volume of combustion air and the attic ventilation required by the *New York City Building Code*. The combustion air openings shall be provided with a sleeve of not less than 0.019 inch (0.48 mm) (No. 26 Gage) galvanized steel or other approved material extending from the appliance enclosure to at least 6 inches (152 mm) above the top of the ceiling joists and insulation.

**701.5 Prohibited sources.** Openings and ducts shall not connect appliance enclosures with a space in which the operation of a fan will adversely affect the flow of the combustion air. Combustion air shall not be obtained from a hazardous location, except where the fuel-fired appliances are located within the hazardous location and are installed in accordance with this code. Combustion air shall not be taken from a refrigeration machinery room, except where a refrigerant vapor detector system is installed to automatically shut off the combustion process in the event of refrigerant leakage. For structures in areas of special flood hazard, air shall be obtained from a location complying with Appendix G of the *New York City Building Code*. Combustion air shall be obtained solely from the outdoors for a boiler room.

## **SECTION MC 702** **INSIDE AIR**

**702.1 All air from indoors.** Combustion and dilution air shall be permitted to be obtained entirely from the indoors in buildings that are not of unusually tight construction. In buildings of unusually tight construction, combustion air shall be obtained from the outdoors in accordance with Section 703, 705, 706 or 707.

**702.2 Air from the same room or space.** The room or space containing fuel-burning appliances shall be an unconfined space as defined in Section 202.

**702.3 Air from adjacent spaces.** Where the volume of the room in which the fuel-burning appliances are located does not comply with Section 702.2, additional inside combustion and dilution air shall be obtained by opening the room to adjacent spaces so that the combined volume of all communicating spaces meets the volumetric requirement of Section 702.2. Openings connecting the spaces shall comply with Sections 702.3.1, 702.3.2 and Figure A-1 of Appendix A of this code.

**702.3.1 Number and location of openings.** Two openings shall be provided, one within 1 foot (305 mm) of the ceiling of the room and one within 1 foot (305 mm) of the floor.

**702.3.2 Size of openings.** The net free area of each opening, calculated in accordance with Section 708, shall be a minimum of 1 square inch per 1,000 Btu/h (2201 mm<sup>2</sup>/kW) of input rating of the fuel-burning appliances drawing combustion and dilution air from the communicating spaces and shall be not less than 100 square inches (64 516 mm<sup>2</sup>).

## **SECTION MC 703** **OUTDOOR AIR**

**703.1 All air from the outdoors.** Where all combustion and dilution air is to be provided by outdoor air, the required combustion and dilution air shall be obtained by opening the room to the outdoors. Openings connecting the room to the outdoor air shall comply with Sections 703.1.1 through 703.1.4, and Figures A-2, A-3 and A-4 of Appendix A of this code. The size of the openings connecting the room to the outdoor air supply shall also comply with any applicable rules of the New York City Department of Environmental Protection.

**703.1.1 Number and location of openings.** Two openings shall be provided, one within 1 foot (305 mm) of the ceiling of the room and one within 1 foot (305 mm) of the floor.

**703.1.2 Size of direct openings.** The net free area of each direct opening to the outdoors, calculated in accordance with Section 709, shall be a minimum of 1 square inch per 4,000 Btu/h (550 mm<sup>2</sup>/kW) of combined input rating of the fuel-burning appliances drawing combustion and dilution air from the room.

**703.1.3 Size of horizontal openings.** The net free area of each opening, calculated in accordance with Section 709 and connected to the outdoors through a horizontal duct, shall be a minimum of 1 square inch per 2,000 Btu/h (1100 mm<sup>2</sup>/kW) of combined input rating of the fuel-burning appliances drawing combustion and dilution air from the room. The cross-sectional area of the duct shall be equal to or greater than the required size of the opening.

**703.1.4 Size of vertical openings.** The net free area of each opening, calculated in accordance with Section 709 and connected to the outdoors through a vertical duct, shall be a minimum of 1 square inch per 4,000 Btu/h (550 mm<sup>2</sup>/kW) of combined input rating of the fuel-burning appliances drawing combustion and dilution air from the room. The cross-sectional area of the duct shall be equal to or greater than the required size of the opening.

## **SECTION MC 704**

### **COMBINED USE OF INSIDE AND OUTDOOR AIR (CONDITION 1)**

**704.1 Combination of air from inside and outdoors.** This section shall apply only to appliances located in confined spaces in buildings not of unusually tight construction. Where the volumes of rooms and spaces are combined for the purpose of providing indoor combustion air, such rooms and spaces shall communicate through permanent openings in compliance with Sections 702.3.1 and 702.3.2. The required combustion and dilution air shall be obtained by opening the room to the outdoors using a combination of inside and outdoor air, prorated in accordance with Section 704.1.6. The ratio of interior spaces shall comply with Section 704.1.5. The number, location and ratios of openings connecting the space with the outdoor air shall comply with Sections 704.1.1 through 704.1.4.

**704.1.1 Number and location of openings.** At least two openings shall be provided, one within 1 foot (305 mm) of the ceiling of the room and one within 1 foot (305 mm) of the floor.

**704.1.2 Ratio of direct openings.** Where direct openings to the outdoors are provided in accordance with Section 703.1, the ratio of direct openings shall be the sum of the net free areas of both direct openings to the outdoors, divided by the sum of the required areas for both such openings as determined in accordance with Section 703.1.2.

**704.1.3 Ratio of horizontal openings.** Where openings connected to the outdoors through horizontal ducts are provided in accordance with Section 703.1, the ratio of horizontal

openings shall be the sum of the net free areas of both such openings, divided by the sum of the required areas for both such openings as determined in accordance with Section 703.1.3.

**704.1.4 Ratio of vertical openings.** Where openings connected to the outdoors through vertical ducts are provided in accordance with Section 703.1, the ratio of vertical openings shall be the sum of the net free areas of both such openings, divided by the sum of the required areas for both such openings as determined in accordance with Section 703.1.4.

**704.1.5 Ratio of interior spaces.** The ratio of interior spaces shall be the available volume of all communicating spaces, divided by the required volume as determined in accordance with Sections 702.2 and 702.3.

**704.1.6 Prorating of inside and outdoor air.** In spaces that utilize a combination of inside and outdoor air, the sum of the ratios of all direct openings, horizontal openings, vertical openings and interior spaces shall equal or exceed 1.

## **SECTION MC 705** **COMBINED USE OF INSIDE AND OUTDOOR AIR (CONDITION 2)**

**705.1 General.** This section shall apply only to appliances located in unconfined spaces in buildings of unusually tight construction. Combustion air supplied by a combined use of indoor and outdoor air shall be supplied through openings and ducts extending to the appliance room or to the vicinity of the appliance.

**705.1.1 Openings and supply ducts.** Openings shall be provided, located and sized in accordance with Sections 702.3.1 and 702.3.2; additionally, there shall be one opening to the outdoors having a free area of at least 1 square inch per 5,000 Btu/h (440 mm<sup>2</sup>/kW) of total input of all appliances in the space.

## **SECTION MC 706** **FORCED COMBUSTION AIR SUPPLY**

**706.1 Rate of air supplied.** Where all combustion air and dilution air is provided by a mechanical forced-air system, the combustion air and dilution air shall be supplied at the minimum rate of 1 cfm per 2,400 Btu/h [0.00067 m<sup>3</sup>/(s • kW)] of combined input rating of all the fuel-burning appliances served. Combustion air rates shall also comply with any applicable rules of the New York City Department of Environmental Protection.

## **SECTION MC 707** **DIRECT CONNECTION**

**707.1 General.** Fuel-burning appliances that are listed and labeled for direct combustion air connection to the outdoors shall be installed in accordance with the manufacturer's installation instructions.

**SECTION MC 708**  
**COMBUSTION AIR DUCTS**

**708.1 General.** Combustion air ducts shall:

1. Be of galvanized steel complying with Chapter 6 or of equivalent corrosion-resistant material approved for this application.

**Exception:** Within dwelling units, unobstructed stud and joist spaces shall not be prohibited from conveying combustion air, provided that not more than one required fireblock is removed.

2. Have a minimum cross-sectional dimension of 3 inches (76 mm).
3. Terminate in an unobstructed space allowing free movement of combustion air to the appliances.
4. Have the same cross-sectional areas as the free area of the openings to which they connect.
5. Serve a single appliance enclosure.
6. Not serve both upper and lower combustion air openings where both such openings are used. The separation between ducts serving upper and lower combustion air openings shall be maintained to the source of combustion air.
7. Not be screened where terminating in an attic space.
8. Not slope downward toward the source of combustion air, where serving the upper required combustion air opening.

**SECTION MC 709**  
**OPENING OBSTRUCTIONS**

**709.1 General.** The required size of openings for combustion and dilution air shall be based on the net free area of each opening. The net free area of an opening shall be that specified by the manufacturer of the opening covering. In the absence of such information, openings covered with metal louvers shall be deemed to have a net free area of 60 percent of the area of the opening, and openings covered with wood louvers shall be deemed to have a net free area of 10 percent of the area of the opening. Louvers and grills shall be fixed in the open position.

**Exception:** Louvers interlocked with the appliance so that they are proven to be in the full open position prior to main burner ignition and during main burner operation. Means shall be provided to prevent the main burner from igniting if the louvers fail to open during burner startup and to shut down the main burner if the louvers close during operation.

**709.2 Dampered openings.** Where the combustion air openings are provided with volume, smoke or fire dampers, the dampers shall be electrically interlocked with the firing cycle of the appliances served, so as to prevent operation of any appliance that draws combustion and dilution air from the room when any of the dampers are closed. Manually operated dampers shall not be installed in combustion air openings.

## **SECTION MC 710** **OPENING LOCATION AND PROTECTION**

**710.1 General.** Combustion air openings to the outdoors shall comply with the location and protection provisions of Sections 401.5 and 401.6 applicable to outside air intake openings.

## **CHAPTER 8** **CHIMNEYS AND VENTS**

### **SECTION MC 801** **GENERAL**

**801.1 Scope.** This chapter shall govern the installation, maintenance, design, minimum safety requirements, repair and approval of factory-built chimneys, chimney liners, vents and connectors, and field built chimneys and connectors. This chapter shall also govern the utilization of masonry chimneys. Gas-fired appliances shall be vented in accordance with the *New York City Fuel Gas Code*.

**801.1.1 Adjoining chimneys and vents.** Adjoining chimneys and vents shall be in accordance with Sections 801.1.1.1 through 801.1.1.8.

**801.1.1.1 Responsibility of owner of taller building.** Whenever a building is erected, enlarged, or increased in height so that any portion of such building, except chimneys or vents, extends higher than the top of any previously constructed chimneys or vents within 100 feet (30 480 mm), the owner of such new or altered building shall have the responsibility of altering such chimneys or vents to make them conform with the requirements of this chapter. A chimney or vent that is no longer connected with a fireplace or combustion or other equipment for which a chimney or vent was required, shall be exempt from this requirement. Such alterations shall be accomplished by one of the following means or a combination thereof:

1. Carry up the previously constructed chimneys or vents to the height required in this chapter.
2. Offset such chimneys or vents to a distance beyond that required in Chapter 5 of this code from the new or altered building provided that the new location of the outlet of the offset chimney or vent shall otherwise comply with the requirements of this chapter.

3. Such requirements shall not dispense with or modify any additional requirements that may be applicable pursuant to rules of the New York City Department of Environmental Protection.

**801.1.1.2 Protection of draft.** After the alteration of a chimney or vent as required by this section, it shall be the responsibility of the owner of the new or altered building to provide any mechanical equipment or devices necessary to maintain the proper draft in the equipment.

**801.1.1.3 Written notification.** The owner of the new or altered building shall notify the owner of the building affected in writing at least forty-five days before starting the work required and request written consent to do such work. Such notice shall be accompanied by plans indicating the manner in which the proposed alterations are to be made.

**801.1.1.4 Approval.** The plans and method of alteration shall be subject to the approval of the commissioner.

**801.1.1.5 Refusal of consent.** If consent is not granted by the owner of the previously constructed building to do the alteration work required by this section, such owner shall signify his or her refusal in writing to the owner of the new or altered building and to the commissioner; and the owner of the new or altered building having submitted plans that conform to the requirements of this section, shall thereupon be released from any responsibility for the proper operation of the equipment due to loss of draft and for any health hazard or nuisance that may occur as a result of the new or altered building. Such responsibilities shall then be assumed by the owner of the previously constructed building. Similarly, should such owner fail to grant consent within forty-five days from the date of written request or fail to signify his or her refusal, he or she shall then assume all responsibilities as prescribed above.

**801.1.1.6 Procedure.** It shall be the obligation of the owner of the new or altered building to:

1. Schedule this work so as to create a minimum of disturbance to the occupants of the affected building; and
2. Provide such essential services as are normally supplied by the equipment while it is out of service; and
3. Where necessary, support such extended chimneys, vents and equipment from this building or to carry up such chimneys or vents within his or her building; and
4. Provide for the maintenance, repair, and/or replacement of such extensions and added equipment; and

5. Make such alterations of the same material as the original chimney or vent so as to maintain the same quality and appearance, except where the affected owner of the chimney or vent shall give his or her consent to do otherwise. All work shall be done in such fashion as to maintain the architectural aesthetics of the existing building. Where there is practical difficulty in complying strictly with the provisions of this Item, the commissioner may permit an equally safe alternative.

**801.1.1.7 Existing violations.** Any existing violations on the previously constructed equipment shall be corrected by the owner of the equipment before any equipment is added or alterations made at the expense of the owner of the new or altered building.

**801.1.1.8 Variance.** The commissioner may grant a variance in accordance with the provisions of this code.

**801.2 General.** Every fuel-burning appliance shall discharge the products of combustion to a vent, factory-built chimney or masonry chimney, except for appliances vented in accordance with Section 804. The chimney or vent shall be designed for the type of appliance being vented.

**801.2.1 Design.** Chimneys and vents shall be designed and constructed so as to provide the necessary draft and capacity for each appliance connected to completely exhaust the products of combustion to the outside air. The temperature on adjacent combustible surfaces shall not be raised above 160°F (71°C). Condensation shall not be developed to an extent that can cause deterioration of the chimney or vent.

**801.2.2 Outlets.** The outlet shall be arranged that the flue gases are not directed so that they jeopardize people, overheat combustible structures, or enter building openings in the vicinity of the outlet.

**801.2.3 Support.** Chimneys and vents shall not be supported by the equipment they serve unless such equipment has been specifically designed for such loads.

**801.2.4 Oil-fired appliances.** Oil-fired appliances shall be vented in accordance with this code and NFPA 31.

**801.2.5 Gas fired appliances.** Gas fired appliances shall be vented in accordance with the *New York City Fuel Gas Code*.

**801.3 Masonry chimneys.** Masonry chimneys shall be constructed in accordance with the *New York City Building Code*.

**801.4 Positive flow.** Venting systems shall be designed and constructed so as to develop a positive flow adequate to convey all combustion products to the outside atmosphere.

**801.5 Design.** Venting systems shall be designed in accordance with this chapter and comply with the requirements of the *New York City Air Pollution Control Code*.



**801.6 Minimum size of chimney or vent.** Except as otherwise provided for in this chapter, the size of the chimney or vent, serving a single appliance, except engineered systems, shall have a minimum area equal to the area of the appliance connection.

**801.7 Solid fuel appliance flues.** The cross-sectional area of a flue serving a solid fuel-burning appliance shall be not greater than three times the cross-sectional area of the appliance flue collar or flue outlet.

**801.8 Abandoned inlet openings.** Abandoned inlet openings in chimneys and vents shall be closed by an approved method, sealed air-tight and permanently labeled as abandoned.

**801.9 Positive pressure.** Where an appliance equipped with a forced or induced draft system creates a positive pressure in the venting system, the venting system shall be designed and listed for positive pressure applications.

**801.10 Connection to fireplace.** Connection of appliances to chimney flues serving fireplaces shall be in accordance with Sections 801.10.1 through 801.10.3.

**801.10.1 Closure and access.** A noncombustible seal shall be provided below the point of connection to prevent entry of room air into the flue. Means shall be provided for access to the flue for inspection and cleaning.

**801.10.2 Connection to factory-built fireplace flue.** An appliance shall not be connected to a flue serving a factory-built fireplace unless the appliance is specifically listed for such installation. The connection shall be made in accordance with the appliance manufacturer's installation instructions.

**801.10.3 Connection to masonry fireplace flue.** A connector shall extend from the appliance to the flue serving a masonry fireplace such that the flue gases are exhausted directly into the flue. The connector shall be provided with access or shall be removable for inspection and cleaning of both the connector and the flue. Listed direct connection devices shall be installed in accordance with their listing.

**801.11 Multiple solid fuel prohibited.** A solid fuel-burning appliance or fireplace shall not connect to a chimney passageway venting another appliance.

**801.12 Chimney entrance.** Connectors shall connect to a chimney flue at a point not less than 12 inches (305 mm) above the lowest portion of the interior of the chimney flue.

**801.13 Cleanouts.** Masonry chimney flues shall be provided with a cleanout opening having a minimum height of 6 inches (152 mm). The upper edge of the opening shall be located not less than 6 inches (152 mm) below the lowest chimney inlet opening. The cleanout shall be provided with a tight-fitting, noncombustible cover of a minimum size of 8 inches by 8 inches (203 mm by 203 mm).

**Exception:** Cleanouts shall not be required for chimney flues serving masonry fireplaces, if such flues are provided with access through the fireplace opening.

**801.14 Connections to exhauster.** All appliance connections to a chimney or vent equipped with a power exhauster shall be made on the inlet side of the exhauster. All joints and piping on the positive pressure side of the exhauster shall be listed for positive pressure applications as specified by the manufacturer's installation instructions for the exhauster.

**801.15 Fuel-fired appliances.** Masonry chimneys utilized to vent fuel-fired appliances shall be located, constructed and sized as specified in the manufacturer's installation instructions for the appliances being vented.

**801.16 Flue lining.** Masonry chimneys shall be lined. The lining material shall be compatible with the type of appliance connected, in accordance with the appliance listing and manufacturer's installation instructions. Listed materials used as flue linings shall be installed in accordance with their listings and the manufacturer's installation instructions.

**801.16.1 Residential and low-heat appliances (general).** Flue lining systems for use with residential-type and low-heat appliances shall be limited to the following:

1. Clay flue lining complying with the requirements of ASTM C 315 or equivalent. Clay flue lining shall be installed in accordance with the *New York City Building Code*.
2. Listed chimney lining systems complying with UL 1777.
3. Other approved materials that will resist, without cracking, softening or corrosion, flue gases and condensate at temperatures up to 1,800°F (982°C).

**801.17 Space around lining.** The space surrounding a flue lining system or other vent installed within a masonry chimney shall not be used to vent any other appliance. This shall not prevent the installation of a separate flue lining in accordance with the manufacturer's installation instructions and this code.

**801.18 Existing chimneys and vents.** Where an appliance is permanently disconnected from an existing chimney or vent, or where an appliance is connected to an existing chimney or vent during the process of a new installation, the chimney or vent shall comply with Sections 801.18.1 through 801.18.4.

**801.18.1 Size.** The chimney or vent shall be resized as necessary to control flue gas condensation in the interior of the chimney or vent and to provide the appliance or appliances served with the required draft. For the venting of oil-fired appliances to masonry chimneys, the resizing shall be in accordance with NFPA 31.

**801.18.2 Flue passageways.** The flue gas passageway shall be free of obstructions and combustible deposits and shall be cleaned if previously used for venting a solid or liquid fuel-burning appliance or fireplace. The flue liner, chimney innerwall or vent innerwall shall be continuous and shall be free of cracks, gaps, perforations or other damage or deterioration which would allow the escape of combustion products, including gases, moisture and creosote. Where an oil-fired appliance is connected to an existing masonry chimney, such chimney flue shall be repaired or relined in accordance with NFPA 31.

**801.18.3 Cleanout.** Masonry chimneys shall be provided with a cleanout opening complying with Section 801.13.

**801.18.4 Clearances.** Chimneys and vents shall have air-space clearance to combustibles in accordance with the *New York City Building Code* and the chimney or vent manufacturer's installation instructions.

**Exception:** Masonry chimneys equipped with a chimney lining system tested and listed for installation in chimneys in contact with combustibles in accordance with UL 1777, and installed in accordance with the manufacturer's instructions, shall not be required to have clearance between combustible materials and exterior surfaces of the masonry chimney. Noncombustible fireblocking shall be provided in accordance with the *New York City Building Code*.

**801.19 Multistory prohibited.** Common venting systems for appliances located on more than one floor level shall be prohibited, except where all of the appliances served by the common vent are located in rooms or spaces that are accessed only from the outdoors. The appliance enclosures shall not communicate with the occupiable areas of the building.

**801.20 Reserved.**

## **SECTION MC 802** **VENTS**

**802.1 General.** All vent systems shall be listed and labeled or field fabricated in accordance with NFPA 211. Type L vents shall be tested in accordance with UL 641.

**802.2 Vent application.** The application of vents shall be in accordance with Table 802.2.

### **TABLE 802.2** **VENT APPLICATION** **(Table 802.2 attached to end of document)**

**802.3 Installation.** Vent systems shall be sized, installed and terminated in accordance with the vent and appliance manufacturer's installation instructions.

**802.4 Vent termination caps.** Vent termination caps shall not be permitted and a 2½-inch (64 mm) minimum drain installed to receive condensed water shall be required. A positive means shall be provided to prevent water from entering the appliance.

**802.5 Type L vent terminations.** Type L vents shall terminate not less than 2 feet (610 mm) above the highest point of the roof penetration and not less than 2 feet (610 mm) higher than any portion of a building within 10 feet (3048 mm). Chimneys serving appliances less than 600°F (316°C) shall extend at least 3 feet (914 mm) above the highest construction, such as a roof ridge, parapet wall, or penthouse, within 10 feet (3048 mm) of the chimney outlet, whether the construction is on the same buildings as the chimney or on another building. Any chimney located in an area that is more than 10 feet (3048 mm) from such construction but not more than the distance determined by Equation 8-1 and Table 802.5, shall be at least as high as the highest construction in such area. For purposes of determining the required height of the chimney, such construction does not include other chimneys, vents, or open structural framing.

**(Equation 8-1 attached to end of document)**

**TABLE 802.5**  
**“F” FACTOR FOR DETERMINING CHIMNEY DISTANCES**  
**(Table 802.5 attached to end of document)**

**802.6 Minimum vent heights.** Vents shall terminate not less than 5 feet (1524 mm) in vertical height above the highest connected appliance flue collar.

**Exceptions:**

1. Venting systems of direct vent appliances shall be installed in accordance with the appliance and the vent manufacturer’s instructions.
2. Appliances listed for outdoor installations incorporating integral venting means shall be installed in accordance with their listings and the manufacturer’s installation instructions.

**802.7 Support of vents.** All portions of vents shall be adequately supported for the design and weight of the materials employed.

**802.8 Insulation shield.** Where vents pass through insulated assemblies, an insulation shield constructed of not less than No. 26 Gage sheet metal shall be installed to provide clearance between the vent and the insulation material. The clearance shall be not less than the clearance to combustibles specified by the vent manufacturer’s installation instructions. Where vents pass through attic space, the shield shall terminate not less than 2 inches (51 mm) above the insulation materials and shall be secured in place to prevent displacement. Insulation shields provided as part of a listed vent system shall be installed in accordance with the manufacturer’s installation instructions.

**SECTION MC 803**  
**CONNECTORS**

**803.1 Connectors required.** Connectors shall be used to connect appliances to the vertical chimney or vent, except where the chimney or vent is attached directly to the appliance.

**803.2 Location.** Connectors shall be located entirely within the room in which the connecting appliance is located, except as provided for in Section 803.10.4. Where passing through an unheated space, a connector shall not be constructed of single-wall pipe.

**803.3 Size.** The connector shall not be smaller than the size of the flue collar supplied by the manufacturer of the appliance. Where the appliance has more than one flue outlet, and in the absence of the manufacturer's specific instructions, the connector area shall be not less than the combined area of the flue outlets for which it acts as a common connector.

**803.4 Branch connections.** All branch connections to the vent connector shall be made in accordance with the vent manufacturer's instructions.

**803.5 Manual dampers.** Manual dampers shall not be installed in connectors except in chimney connectors serving solid fuel-burning appliances.

**803.6 Automatic dampers.** Automatic dampers shall be listed and labeled in accordance with UL 17 for oil-fired heating appliances. The dampers shall be installed in accordance with the manufacturer's installation instructions. An automatic vent damper device shall not be installed on an existing appliance unless the appliance is listed and labeled and the device is installed in accordance with the terms of its listing. The name of the installer and date of installation shall be marked on a label affixed to the damper device.

**803.7 Connectors serving two or more appliances.** Where two or more connectors enter a common vent or chimney, the smaller connector shall enter at the highest level consistent with available headroom or clearance to combustible material.

**803.8 Vent connector construction.** Vent connectors shall be constructed of metal. The minimum nominal thickness of the connector shall be 0.019 inch (0.5 mm) (No. 28 Gage) for galvanized steel, 0.022 inch (0.6 mm) (No. 26 B & S Gage) for copper, and 0.020 inch (0.5 mm) (No. 24 B & S Gage) for aluminum.

**803.9 Chimney connector construction.** Chimney connectors for low-heat appliances shall be of sheet steel pipe having resistance to corrosion and heat not less than that of galvanized steel specified in Table 803.9(1). Connectors for medium-heat appliances and high-heat appliances shall be of sheet steel not less than the thickness specified in Table 803.9(2).

**TABLE 803.9(1)**  
**MINIMUM CHIMNEY CONNECTOR THICKNESS FOR**  
**LOW-HEAT APPLIANCES**

(Table 803.9(1) attached to end of document)

**TABLE 803.9(2)**  
**MINIMUM CHIMNEY CONNECTOR THICKNESS FOR**  
**MEDIUM- AND HIGH-HEAT APPLIANCES**  
**(Table 803.9(2) attached to end of document)**

**803.10 Installation.** Connectors shall be installed in accordance with Sections 803.10.1 through 803.10.6.

**803.10.1 Supports and joints.** Connectors shall be supported in an approved manner, and joints shall be fastened with sheet metal screws, rivets or other approved means.

**803.10.2 Length.** The maximum horizontal length of a single- wall connector shall not affect the capability of the system to produce adequate draft.

**803.10.3 Connection.** The connector shall extend to the inner face of the chimney or vent liner, but not beyond. A connector entering a masonry chimney shall be cemented to masonry in an approved manner. Where thimbles are installed to facilitate removal of the connector from the masonry chimney, the thimble shall be permanently cemented in place with high-temperature cement.

**803.10.4 Connector pass-through.** Chimney connectors shall not pass through any floor or ceiling, nor through a fire-resistance-rated wall assembly. Chimney connectors for domestic-type appliances shall not pass through walls or partitions constructed of combustible material to reach a masonry chimney unless:

1. The connector is labeled for wall pass-through and is installed in accordance with the manufacturer's instructions; or
2. The connector is put through a device labeled for wall pass-through; or
3. The connector has a diameter not larger than 10 inches (254 mm) and is installed in accordance with one of the methods in Table 803.10.4. Concealed metal parts of the pass-through system in contact with flue gases shall be of stainless steel or equivalent material that resists corrosion, softening or cracking up to 1,800°F (980°C).

**TABLE 803.10.4**  
**CHIMNEY CONNECTOR SYSTEMS AND CLEARANCES TO COMBUSTIBLE WALL**  
**MATERIALS FOR DOMESTIC HEATING APPLIANCES** <sup>a,b,c,d</sup>  
**(Table 803.10.4 attached to end of document)**

**803.10.5 Pitch.** Connectors shall rise vertically to the chimney or vent with a minimum pitch equal to one-fourth unit vertical in 12 units horizontal (2-percent slope).

**803.10.6 Clearances.** Connectors shall have a minimum clearance to combustibles in accordance with Table 803.10.6. The clearances specified in Table 803.10.6 apply, except where the listing and labeling of an appliance specifies a different clearance, in which case the labeled clearance shall apply. The clearance to combustibles for connectors shall be reduced only in accordance with Section 308 or via the use of a listed chimney or vent connector system.

**TABLE 803.10.6**  
**CONNECTOR CLEARANCES TO COMBUSTIBLES**  
**(Table 803.10.6 attached to end of document)**

**SECTION MC 804**  
**DIRECT-VENT, INTEGRAL VENT AND**  
**MECHANICAL DRAFT SYSTEMS**

**804.1 Direct-vent terminations.** Vent terminals for direct-vent appliances shall be installed in accordance with the manufacturer's installation instructions. Horizontal venting shall be allowed only if in a non-hazardous location and if the appliance has a sealed combustion chamber.

**804.2 Appliances with integral vents.** Appliances incorporating integral venting means shall be installed in accordance with their listings and the manufacturer's installation instructions. Horizontal venting shall be allowed only if in a non hazardous location and if the appliance has a sealed combustion chamber.

**804.2.1 Terminal clearances.** Appliances designed for natural draft venting and incorporating integral venting means shall be located so that a minimum clearance of 9 inches (229 mm) is maintained between vent terminals and from any openings through which combustion products enter the building. Appliances using forced draft venting shall be located so that a minimum clearance of 12 inches (305 mm) is maintained between vent terminals and from any openings through which combustion products enter the building.

**804.3 Mechanical draft systems.** Mechanical draft systems of either forced or induced draft design shall comply with Sections 804.3.1 through 804.3.7.

**804.3.1 Forced draft systems.** Forced draft systems and all portions of induced draft systems under positive pressure during operation shall be designed and installed so as to be gas tight to prevent leakage of combustion products into a building.

**804.3.2 Automatic shutoff.** Power exhausters serving automatically-fired appliances shall be electrically connected to each appliance to prevent operation of the appliance when the power exhauster is not in operation.

**804.3.3 Termination.** The termination of chimneys or vents equipped with power exhausters shall be located a minimum of 10 feet (3048 mm) from the lot line or from adjacent buildings. The exhaust shall be directed away from the building.

**804.3.4 Horizontal terminations.** Horizontal terminations shall only be allowed if they are in a nonhazardous location and if the appliance has a sealed combustion chamber (direct vent) in accordance with the appliance listing and manufacturers instructions. In addition, horizontal terminations shall comply with the following requirements:

1. Where located adjacent to walkways, the termination of mechanical draft systems shall be not less than 7 feet (2134 mm) above the level of the walkway.
2. Vents shall terminate at least 3 feet (914 mm) above any forced air inlet located within 10 feet (3048 mm).
3. The vent system shall terminate at least 4 feet (1219 mm) below, 4 feet (1219 mm) horizontally from or 1 foot (305 mm) above any door, window or gravity air inlet into the building.
4. The vent termination point shall not be located closer than 3 feet (914 mm) to an interior corner formed by two walls perpendicular to each other.
5. The vent termination shall not be mounted directly above or within 3 feet (914 mm) horizontally from any gas or electric metering, regulating, venting relief equipment or other building opening.
6. The bottom of the vent termination shall be located at least 24 inches (610 mm) above finished grade.

**804.3.5 Vertical terminations.** Vertical terminations shall comply with the following requirements and in accordance with the appliance listing and manufacturers instructions:

1. Chimneys serving appliances less than 600°F (316°C) shall extend at least 3 feet (914 mm) above the highest construction, such as a roof ridge, parapet wall, or penthouse, within 10 feet (3048 mm) of the chimney outlet, whether the construction is on the same building as the chimney or on another building. Any chimney located in an area that is more than 10 feet (3048 mm) from such construction, but not more than the distance determined by Equation 8-2 shall be at least as high as the highest construction in such area. However, for purposes of determining the required height of a chimney, such construction does not include other chimneys, vents, or open structural framing.
2. Chimneys serving appliances between 600°F (316°C) and 1000°F (538°C) shall extend at least 10 feet (3048 mm) above the highest construction, such as a roof ridge, or parapet wall or penthouse within 20 feet (6096 mm) of the chimney outlet, whether the construction is on the same building as the chimney or on another building. Any chimney located in an area more than 20 feet (6096 mm) from such construction, but not more than the distance determined from Equation 8-2 shall be at least as high as the highest construction in such area. However, for purposes of determining the required



height of the chimney, such construction does not include other chimneys, vents or open structural framing.

3. Chimneys serving appliances greater than 1000°F (538°C) shall extend at least 20 feet (6096 mm) above the highest construction, such as roof ridge, parapet wall, penthouse, or other obstruction within 50 feet (15 240 mm) of the chimney outlet, whether the construction is on the same building as the chimney or in another building. Any chimney located in an area that is more than 50 feet (15 240 mm) from such construction, but not more than the distance determined from Equation 8-2 shall be at least as high as the highest construction located in such area. However, for purposes of determining the required height of the chimney, such construction does not include other chimneys, vents, or open structural framing.
4. Vent termination caps shall not be permitted and a 3-inch (76 mm) minimum drain installed to receive condensed water shall be required. A positive means shall be provided to prevent water from entering the appliance.
5. The following formula shall be used in order to determine the distance referred to in Items 1, 2 and 3 of this section.

**(Equation 8-2 attached to end of document)**

**804.3.6 Exhauster connections.** An appliance vented by natural draft shall not be connected into a vent, chimney or vent connector on the discharge side of a mechanical flue exhauster.

**804.3.7 Exhauster sizing.** Mechanical flue exhausters and the vent system served shall be sized and installed in accordance with the manufacturer's installation instructions.

**804.3.8 Mechanical draft systems for manually fired appliances and fireplaces.** A mechanical draft system shall be permitted to be used with manually fired appliances and fireplaces where such system complies with all of the following requirements:

1. The mechanical draft device shall be listed and installed in accordance with the manufacturer's installation instructions.
2. A device shall be installed that produces visible and audible warning upon failure of the mechanical draft device or loss of electrical power, at any time that the mechanical draft device is turned on. This device shall be equipped with a battery backup if it receives power from the building wiring.
3. A smoke detector shall be installed in the room with the appliance or fireplace. This device shall be equipped with a battery backup if it receives power from the building wiring.

## **SECTION MC 805**

## **FACTORY-BUILT CHIMNEYS**

**805.1 Listing.** Factory-built chimneys shall be listed and labeled and shall be installed and terminated in accordance with this code and the manufacturer's installation instructions.

**805.2 Solid fuel appliances.** Factory-built chimneys for use with solid fuel-burning appliances shall comply with the Type HT requirements of UL 103.

**Exception:** Chimneys for use with fireplace stoves listed only to UL 737 shall comply with the requirements of UL 103.

**805.3 Factory-built fireplaces.** Chimneys for use with factory-built fireplaces shall comply with the requirements of UL 127.

**805.4 Support.** Where factory-built chimneys are supported by structural members, such as joists and rafters, such members shall be designed to support the additional load.

**805.5 Medium-heat appliances.** Factory-built chimneys for medium-heat appliances producing flue gases having a temperature above 1,000°F (538°C), measured at the entrance to the chimney, shall comply with UL 959.

**805.6 Decorative shrouds.** Decorative shrouds shall not be installed at the termination of factory-built chimneys except where such shrouds are listed and labeled for use with the specific factory-built chimney system and are installed in accordance with Section 304.1.

## **SECTION MC 806** **METAL CHIMNEYS**

**806.1 General.** Metal chimneys shall be constructed and installed in accordance with NFPA 211.

**806.2 Exterior metal chimneys.** Exterior metal chimneys shall be galvanized, painted on the exterior surface with a heat resisting paint or constructed of equal corrosion resistive alloys.

## **SECTION MC 807** **CHANGES IN APPLIANCE FUELS**

**807.1 Changes in appliance fuels.** Conversion from gas to fuel oil for a heating appliances shall be made only if:

1. The chimney design meets the requirements of this chapter for the conversion fuel; and
2. The chimney size is adequate to vent the combustion products from the new fuel. Conversion from solid or liquid fuels to natural gas fuels for heating appliances shall be made only if:

2.1 The chimney design meets the requirements of this chapter for the conversion fuel and the *New York City Fuel Gas Code*.;

2.2 The chimney is thoroughly cleaned prior to the conversion to remove collected flue deposits, which can spill off when gas is used as a fuel;

2.3 Chimney provides adequate draft the new fuel;

2.4 Drains are installed to remove condensed water; and

2.5 Gas vents are installed within the chimney for venting purposes if required by the appliance listing.

### **SECTION MC 808** **REDUCTION OF FLUE SIZE**

**808.1 Reduction of flue size.** Conversion from one fuel to another or the use of an existing chimney to service a fireplace or wood-burning appliance may require a flue size change for proper operation. This may be done if the redesigned flue meets the criteria for the fuel and chimney type to be used as set forth in this chapter.

### **SECTION MC 809** **CHIMNEY SUPPORTED FROM EQUIPMENT**

**809.1 Chimney support.** Chimneys shall not be supported by the equipment they serve, unless such equipment has been specifically designed for such loads.

### **SECTION MC 810** **TEST RUN AND SMOKE TEST**

**810.1 Test run.** All new chimneys shall be test run under operating conditions to demonstrate fire safety and the complete exhausting of smoke and the products of combustion to the outer air. The test run shall be conducted by a registered design professional responsible for the test, and the results of such test run shall be certified as correct by such professional and submitted in writing to the department.

**810.2 Requirement of a smoke test.** A smoke test shall be made as outlined in Section 810.3. Any faults or leaks found shall be corrected. Such smoke test shall be witnessed by a representative of the commissioner. In lieu thereof, the commissioner may accept the test report of a registered design professional responsible for the test which shall be submitted in writing to the department.

**810.3 Smoke test.** To determine the tightness of chimney construction, a smoke test shall be made in accordance with the following conditions and requirements:

1. The equipment, materials, power and labor necessary for such test shall be furnished by, and at the expense of, the owner or holder of the work permit.
2. If the test shows any evidence of leakage or other defects, such defects shall be corrected in accordance with the requirements of this chapter, and the test shall be repeated until the results are satisfactory.
3. The chimney shall be filled with a thick penetrating smoke produced by one or more smoke machines, or smoke bombs, or other equivalent method. As the smoke appears at the stack opening on the roof, such opening shall be tightly closed and a pressure equivalent to ½-inch (13 mm) column of water measured at the base of the stack, shall be applied. The test shall be applied for a length of time sufficient to permit the inspection of the chimney.

### **SECTION MC 811** **EXHAUST GASES FROM INTERNAL COMBUSTION ENGINES**

**811.1 Exhaust pipe construction.** The exhaust pipe from internal combustion engines shall be constructed in accordance with the requirements for metal chimneys in this chapter, NFPA 211 and NFPA 37 based on the temperature of the gases entering the exhaust pipe, and in accordance with the following:

1. The exhaust pipe, if factory fabricated shall be constructed in accordance with their listing and manufacturers instructions.
2. The exhaust pipe, if field fabricated, shall be constructed of at least  $\frac{3}{16}$ -inch (5 mm) steel, or of other equivalent metal of similar strength and resistance to the temperature and corrosive action of the exhaust gases.
3. No lining shall be required.
4. Where the exhaust pipe runs inside a building, it shall be insulated with insulation adequate for the temperature of the pipe, so that the surface temperature shall be not more than 200°F (93°C).
5. All joints shall be constructed so as to be gas tight under all operating conditions.

**811.2 Discharge openings.** The location of discharge openings for emergency and standby internal combustion engines shall comply with the requirements of NFPA 37 so that the flue gases are not directed to jeopardize the health or safety of people, overheat combustible structures, nor enter building openings in the vicinity of the outlet, nor shall the location of such openings cause the condensate leaving the outlet to come into contact with people.

**811.2.1 Interference.** No discharge opening shall be located and constructed so as to interfere with the proper functioning of other openings in the same building or adjoining buildings, to

interfere unreasonably with the occupants of the same building or adjoining buildings, or with the general public, or to create a fire or health hazard.

**811.2.2 Chimneys.** The exhaust pipe may be connected to a chimney used for other equipment, provided that the operation of the engine does not adversely affect the operation of the other equipment so that it is in violation of the *New York City Air Pollution Control Code*.

**811.3 Vertical termination requirements.** The location of the discharge outlet from all other engines shall comply with the vertical termination requirements of at least a 600°F (316°C) to 1000°F (538°C) chimney or a greater than 1000°F (538°C) chimney based on the temperature of the gases entering the exhaust pipe.

## **CHAPTER 9** **SPECIFIC APPLIANCES, FIREPLACES AND** **SOLID FUEL-BURNING EQUIPMENT**

### **SECTION MC 901** **GENERAL**

**901.1 Scope.** This chapter shall govern the approval, design, installation, construction, maintenance, alteration and repair of the appliances and equipment specifically identified herein and factory-built fireplaces. The approval, design, installation, construction, maintenance, alteration and repair of gas-fired appliances shall be regulated by the *New York City Fuel Gas Code*.

**901.2 General.** The requirements of this chapter shall apply to the mechanical equipment and appliances regulated by this chapter, in addition to the other requirements of this code, and installed in accordance with the requirements of NFPA 31, NFPA 54 and NFPA 211.

**901.3 Hazardous locations.** Fireplaces and solid fuel-burning appliances shall not be installed in hazardous locations.

**901.4 Fireplace accessories.** Listed fireplace accessories shall be installed in accordance with the conditions of the listing and the manufacturer's installation instructions.

**901.5 Inspection of solid fuel-burning heating appliances, chimneys and flues.** Inspections of solid fuel burning heating appliances, chimneys and flues shall be in accordance with the *New York City Building Code*.

**901.6 Fireplaces.** Fireplaces (solid-fuel-type or ANSI Z21.50) shall be installed with tight-fitting noncombustible fireplace doors to control infiltration losses in construction types listed here:

1. Masonry or factory-built fireplaces designed to allow an open burn.

2. Decorative appliances (ANSI Z21.60 gas-log style unit) installed in a vented solid fuel fireplace.
3. Vented decorative gas fireplace appliances (ANSI Z21.50 unit).

Fireplaces shall be provided with a source of combustion air as required by the fireplace construction provisions of the *New York City Building Code* and Chapter 7 of this code.

### **SECTION MC 902** **MASONRY FIREPLACES**

**902.1 General.** Masonry fireplaces shall be constructed in accordance with the *New York City Building Code*.

### **SECTION MC 903** **FACTORY-BUILT FIREPLACES**

**903.1 General.** Factory-built fireplaces shall be listed and labeled and shall be installed in accordance with the conditions of the listing. Factory-built fireplaces shall be tested in accordance with UL 127.

**903.2 Hearth extensions.** Hearth extensions of approved factory-built fireplaces and fireplace stoves shall be installed in accordance with the listing of the fireplace. The hearth extension shall be readily distinguishable from the surrounding floor area.

**903.3 Unvented gas log heaters.** The installation of unvented gas fired space heaters, gas stoves, gas logs, gas fireplaces and gas fireplace inserts is prohibited.

**903.4 Flues.** Separate flues shall be provided for every fireplace and fireplace stove.

**903.5 Combustion air supply.** All installations of factory-built fireplaces shall comply with the requirements of the *Energy Conservation Construction Code of New York State* concerning combustion air supply.

### **SECTION MC 904** **PELLET FUEL-BURNING APPLIANCES**

**904.1 General.** Pellet fuel-burning appliances shall be listed and labeled and shall be installed in accordance with the terms of the listing. If permitted, such appliances shall be operated in accordance with the *New York City Air Pollution Control Code*.

### **SECTION MC 905** **FIREPLACE STOVES AND ROOM HEATERS**

**905.1 General.** Fireplace stoves and solid-fuel-type room heaters shall be listed and labeled and

shall be installed in accordance with the conditions of the listing. Fireplace stoves shall be tested in accordance with UL 737. Solid-fuel-type room heaters shall be tested in accordance with UL 1482. Fireplace inserts intended for installation in fireplaces shall be listed and labeled in accordance with the requirements of UL 1482 and shall be installed in accordance with the manufacturer's installation instructions.

**905.2 Connection to fireplace.** The connection of solid fuel appliances to chimney flues serving fireplaces shall comply with Sections 801.7 and 801.10.

**905.3 Air pollution.** All fireplace stoves and room heaters shall comply with the requirements of the *New York City Air Pollution Control Code*.

**905.4 Combustion air supply.** All fireplace stoves and room heaters shall comply with the requirements of the *Energy Conservation Construction Code of New York State* concerning combustion air supply.

**905.5 Flues.** Separate flues and independent combustion air source shall be provided for every fireplace stove and room heater. Combustion air shall be provided in accordance with the manufacturer's recommendations and Chapter 7.

## **SECTION MC 906** **FACTORY-BUILT BARBECUE APPLIANCES**

**906.1 General.** Factory-built barbecue appliances shall be of an approved type and shall be installed in accordance with the manufacturer's installation instructions, this chapter and Chapters 3, 5, 7, 8 and the *New York City Fuel Gas Code*. All provisions for the construction and installation of fireplaces shall be complied within the construction and installation of barbecue grills.

## **SECTION MC 907** **INCINERATORS AND CREMATORIES**

**907.1 General.** Incinerators and crematories shall be listed and labeled in accordance with UL 791 and NFPA 82 and shall be installed in accordance with the manufacturer's installation instructions.

**907.2 Compliance.** All incinerators and crematories shall be installed, altered and maintained in buildings in conformity with the applicable provisions of the *Administrative Code* and the *New York City Air Pollution Control Code*.

## **SECTION MC 908** **COOLING TOWERS, EVAPORATIVE** **CONDENSERS AND FLUID COOLERS**

**908.1 General.** A cooling tower used in conjunction with an air-conditioning appliance shall be

installed in accordance with the manufacturer's installation instructions.

**908.2 Access.** Cooling towers, evaporative condensers and fluid coolers shall be provided with ready access.

**908.3 Location.** Cooling towers, evaporative condensers and fluid coolers shall be located to prevent the discharge vapor plumes from entering occupied spaces. Plume discharges shall be not less than 5 feet (1524 mm) above or 20 feet (6096 mm) away from any ventilation inlet to a building. Location on the property shall be as required for buildings in accordance with the *New York City Building Code*.

**908.3.1 Indoor.** Cooling towers, evaporative condensers and fluid coolers located inside of buildings shall be constructed of noncombustible materials including fill and drift eliminators.

**908.3.2 Outside.** Cooling towers shall be constructed of noncombustible materials.

**Exception:** Fill and drift eliminators may be made of limited combustibility materials provided all the following conditions are met:

1. The cooling tower is located on a building in construction group 1-A or 1-B of the *New York City Building Code*.
2. The cooling tower, fill and drift eliminators are located at least 30 feet (9144 mm) away from windows or fresh air intakes which are at an elevation above the roof on which the cooling tower is located, whether in the same building or in an adjoining building.
3. The cooling tower is located not less than 15 feet (4572 mm) from the lot line.
4. The cooling tower is located not less than 10 feet (3048 mm) from any chimney, except that the distance shall not be less than 20 feet (6096 mm) from a chimney venting products of combustion other than from gas or oil-fired appliances, whether on the same or an adjoining building.

**908.4 Support and anchorage.** Supports for cooling towers, evaporative condensers and fluid coolers shall be designed in accordance with the *New York City Building Code*. Seismic restraints shall be as required by the *New York City Building Code*. Adequate vibration isolation shall be provided in accordance with the manufacturer's installation guidelines and as required for the supporting structure, and in accordance with the following:

**908.4.1 Cooling towers.** All moving parts of cooling towers located on a roof or floor other than a floor on grade shall be installed on vibration isolators providing a minimum isolation efficiency of 85 percent at fan rotor rpm with a maximum static deflection of 4 inches (102 mm). Each isolator shall incorporate a leveling device and a resilient pad having a minimum thickness of ¼ inch (6 mm).



**908.4.2 Evaporative condensers.** Evaporative and air cooled condensers located on a roof or floor other than a floor on grade shall be mounted on vibration isolators providing a minimum isolation efficiency of 85 percent at fan rotor rpm with a maximum static deflection of 4 inches (102 mm). Each isolator shall incorporate a leveling device and a resilient pad having a minimum thickness of ¼ inch (6 mm).

**908.5 Water supply.** Water supplies and protection shall be as required by the *New York City Plumbing Code*.

**908.6 Drainage.** Drains, overflows and blowdown provisions shall be indirectly connected to an approved disposal location. Discharge of chemical waste shall be approved by the appropriate regulatory authority.

**908.7 Refrigerants and hazardous fluids.** Heat exchange equipment that contains a refrigerant and that is part of a closed refrigeration system shall comply with Chapter 11. Heat exchange equipment containing heat transfer fluids which are combustible or hazardous shall comply with the *New York City Fire Code*. Flammable heat transfer fluids are prohibited.

## **SECTION MC 909** **VENTED WALL FURNACES**

**909.1 General.** Vented wall furnaces shall be installed in accordance with their listing and the manufacturer's installation instructions. Oil-fired furnaces shall be tested in accordance with UL 730.

**909.2 Location.** Vented wall furnaces shall be located so as not to cause a fire hazard to walls, floors, combustible furnishings or doors. Vented wall furnaces installed between bathrooms and adjoining rooms shall not circulate air from bathrooms to other parts of the building.

**909.3 Door swing.** Vented wall furnaces shall be located so that a door cannot swing within 12 inches (305 mm) of an air inlet or air outlet of such furnace measured at right angles to the opening. Doorstops or door closers shall not be installed to obtain this clearance.

**909.4 Ducts prohibited.** Ducts shall not be attached to wall furnaces. Casing extension boots shall not be installed unless listed as part of the appliance.

**909.5 Manual shutoff valve.** A manual shutoff valve shall be installed ahead of all controls.

**909.6 Access.** Vented wall furnaces shall be provided with access for cleaning of heating surfaces, removal of burners, replacement of sections, motors, controls, filters and other working parts, and for adjustments and lubrication of parts requiring such attention. Panels, grilles and access doors that must be removed for normal servicing operations shall not be attached to the building construction.

**SECTION MC 910**  
**FLOOR FURNACES**

**910.1 General.** Floor furnaces shall be installed in accordance with their listing and the manufacturer's installation instructions. Oil-fired furnaces shall be tested in accordance with UL 729. Unvented floor furnaces are prohibited.

**910.2 Placement.** Floor furnaces shall not be installed in any corridor, in the floor of any aisle or passageway of any auditorium, public hall, place of assembly, or in any egress element from any such room or space.

With the exception of wall register models, a floor furnace shall not be placed closer than 6 inches (152 mm) to the nearest wall, and wall register models shall not be placed closer than 6 inches (152 mm) to a corner.

The furnace shall be placed such that a drapery or similar combustible object will not be nearer than 12 inches (305 mm) to any portion of the register of the furnace. Floor furnaces shall not be installed in concrete floor construction built on grade. The controlling thermostat for a floor furnace shall be located within the same room or space as the floor furnace or shall be located in an adjacent room or space that is permanently open to the room or space containing the floor furnace. Floor furnaces shall be located so as to be accessible. Floor furnaces shall be installed only in floors of noncombustible construction having at least a 2-hour fire rating, except as where required for one- and two-family dwellings.

**910.3 Bracing.** The floor around the furnace shall be braced and headed with a support framework design in accordance with the *New York City Building Code*.

**910.4 Clearance.** The lowest portion of the floor furnace shall have not less than a 6-inch (152 mm) clearance from the grade level; except where the lower 6-inch (152 mm) portion of the floor furnace is sealed by the manufacturer to prevent entrance of water, the minimum clearance shall be reduced to not less than 2 inches (51 mm). Where these clearances are not present, the ground below and to the sides shall be excavated to form a pit under the furnace so that the required clearance is provided beneath the lowest portion of the furnace. A 12-inch (305 mm) minimum clearance shall be provided on all sides except the control side, which shall have an 18-inch (457 mm) minimum clearance.

**910.5 Enclosures.** Enclosures of floor furnaces shall be constructed entirely of noncombustible materials with a fire-resistance rating of at least 1 hour and shall be provided with adequate outdoor air to ensure proper combustion. The enclosure shall be provided with adequate means of access for servicing the furnace.

**910.6 Duct temperature.** The outlet duct temperature of warm air heating furnaces shall not be greater than 250°F (121°C).

**910.7 One- and two- family dwellings.** Floor furnace enclosures shall be constructed of

noncombustible materials with a fire-resistance rating of at least 1 hour. Means shall be provided for supporting the furnace when the grille is removed. Clearances shall be provided as per NFPA 54.

## **SECTION MC 911** **DUCT FURNACES**

**911.1 General.** Duct furnaces shall be installed in accordance with the manufacturer's installation instructions. Electric furnaces shall be tested in accordance with UL 1995. Unvented furnaces are prohibited.

**911.2 Access panels.** Ducts connected to duct furnaces shall have removable access panels on both the upstream and downstream sides of the furnace.

**911.3 Location of draft hood and controls.** The controls, combustion air inlets and draft hoods for duct furnaces shall be located outside of the ducts. The draft hood shall be located in the same enclosure from which combustion air is taken.

**911.4 Circulating air.** Where a duct furnace is installed so that supply ducts convey air to areas outside the space containing the furnace, the return air shall also be conveyed by a duct(s) sealed to the furnace casing and terminating outside the space containing the furnace. The duct furnace shall be installed on the positive pressure side of the circulating air blower.

**911.5 Duct Temperature.** The outlet duct temperature of duct furnaces shall not be greater than 250°F (121°C).

## **SECTION MC 912** **INFRARED RADIANT HEATERS**

**912.1 Support.** Infrared radiant heaters shall be safely and adequately fixed in an approved position independent of fuel and electric supply lines. Hangers and brackets shall be noncombustible material.

**912.2 Clearances.** Heaters shall be installed with clearances from combustible material in accordance with the manufacturer's installation instructions.

## **SECTION MC 913** **CLOTHES DRYERS**

**913.1 General.** Clothes dryers shall be installed in accordance with the manufacturer's installation instructions. Electric commercial clothes dryers shall be tested in accordance with UL 1240. Electric residential and coin-operated clothes dryers shall be tested in accordance with UL 2158.

**913.2 Exhaust required.** Clothes dryers shall be exhausted in accordance with Section 504.

**Exception:** Electric clothes dryers provided with a condensate drain.

**913.3 Clearances.** Clothes dryers shall be installed with clearance to combustibles in accordance with the manufacturer's instructions.

## **SECTION MC 914** **SAUNA HEATERS**

**914.1 Location and protection.** Sauna heaters shall be located so as to minimize the possibility of accidental contact by a person in the room.

**914.1.1 Guards.** Sauna heaters shall be protected from accidental contact by an approved guard or barrier of material having a low coefficient of thermal conductivity. The guard shall not substantially affect the transfer of heat from the heater to the room.

**914.2 Installation.** Sauna heaters shall be listed and labeled and shall be installed in accordance with their listing and the manufacturer's installation instructions.

**914.3 Access.** Panels, grilles and access doors that are required to be removed for normal servicing operations shall not be attached to the building.

**914.4 Heat and time controls.** Sauna heaters shall be equipped with a thermostat that will limit room temperature to 194°F (90°C). If the thermostat is not an integral part of the sauna heater, the heat-sensing element shall be located within 6 inches (152 mm) of the ceiling. If the heat-sensing element is a capillary tube and bulb, the assembly shall be attached to the wall or other support, and shall be protected against physical damage.

**914.4.1 Timers.** A timer, if provided to control main burner operation, shall have a maximum operating time of 1 hour. The control for the timer shall be located outside the sauna room.

**914.5 Sauna room.** A ventilation opening into the sauna room shall be provided. The opening shall be not less than 4 inches by 8 inches (102 mm by 203 mm) located near the top of the door into the sauna room.

**914.5.1 Warning notice.** The following permanent notice, constructed of approved material, shall be mechanically attached to the sauna room on the outside:

**WARNING: DO NOT EXCEED 30 MINUTES IN SAUNA. EXCESSIVE EXPOSURE CAN BE HARMFUL TO HEALTH. ANY PERSON WITH POOR HEALTH SHOULD CONSULT A PHYSICIAN BEFORE USING SAUNA.**

The words shall contrast with the background and the wording shall be in letters not less than 0.25-inch (6.4 mm) high.

**Exception:** This section shall not apply to one- and two-family dwellings.

**SECTION MC 915**  
**ENGINE AND GAS TURBINE-POWERED**  
**EQUIPMENT AND APPLIANCES**

**915.1 General.** The installation of liquid-fueled stationary internal combustion engines and gas turbines, including fuel storage and piping, shall meet the requirements of NFPA 37 and Chapter 13 of this code.

**915.2 Powered equipment and appliances.** Permanently installed equipment and appliances powered by internal combustion engines and turbines shall be installed in accordance with the manufacturer's installation instructions and NFPA 37.

**SECTION MC 916**  
**POOL AND SPA HEATERS**

**916.1 General.** Pool and spa heaters shall be installed in accordance with the manufacturer's installation instructions. Oil-fired pool and spa heaters shall be tested in accordance with UL 726. Electric pool and spa heaters shall be tested in accordance with UL 1261.

**SECTION MC 917**  
**COOKING APPLIANCES**

**917.1 Cooking appliances.** Cooking appliances that are designed for permanent installation, including ranges, ovens, stoves, broilers, grills, fryers, griddles and barbecues, shall be listed, labeled and installed in accordance with the manufacturer's installation instructions. Oil-fired cooking appliances are prohibited. Solid fuel-fired ovens shall be tested in accordance with UL 2162.

**917.2 Prohibited location.** Cooking appliances designed, tested, listed and labeled for use in commercial occupancies shall not be installed within dwelling units or within any area where domestic cooking operations occur.

**917.3 Domestic appliances.** Cooking appliances installed within dwelling units and within areas where domestic cooking operations occur shall be listed and labeled as household-type appliances for domestic use.

**917.4 Domestic range installation.** Domestic ranges installed on combustible floors shall be set on their own bases or legs and shall be installed with clearances of not less than that shown on the label.

**917.5 Open-top broiler unit hoods.** A ventilating hood shall be provided above a domestic open-top broiler unit, unless otherwise listed for forced down draft ventilation.

**917.5.1 Clearances.** A minimum clearance of 24 inches (610 mm) shall be maintained

between the cooking top and combustible material above the hood. The hood shall be at least as wide as the open-top broiler unit and be centered over the unit.

**917.6 Commercial cooking appliance venting.** Commercial cooking appliances, other than those exempted by Section 501.8 of the *New York City Fuel Gas Code*, shall be vented by connecting the appliance to a vent or chimney in accordance with this code and the appliance manufacturer's instructions or the appliance shall be vented in accordance with Section 505.1.1 of the *New York City Fuel Gas Code*.

**917.7 Domestic ventilation.** When a hood is required for proper ventilation of a domestic cooking appliance, the exhaust and make-up air systems shall be properly engineered and designed in accordance with Chapter 5.

## **SECTION MC 918** **FORCED-AIR WARM-AIR FURNACES**

**918.1 Forced-air furnaces.** Oil-fired furnaces shall be tested in accordance with UL 727. Electric furnaces shall be tested in accordance with UL 1995. Solid fuel furnaces shall be tested in accordance with UL 391. Forced-air furnaces shall be installed in accordance with the listings and the manufacturer's installation instructions. Forced-air warm-air furnaces shall be installed in accordance with the requirements of NFPA 31 and the *New York City Fuel Gas Code*. Unvented furnaces are prohibited.

**918.2 Minimum duct sizes.** The minimum unobstructed total area of the outside and return air ducts or openings to a forced-air warm-air furnace shall be not less than 2 square inches per 1,000 Btu/h (4402 mm<sup>2</sup>/kW) output rating capacity of the furnace and not less than that specified in the furnace manufacturer's installation instructions. The minimum unobstructed total area of supply ducts from a forced-air warm-air furnace shall not be less than 2 square inches for each 1,000 Btu/h (4402mm<sup>2</sup>/kW) output rating capacity of the furnace and not less than that specified in the furnace manufacturer's installation instructions.

**Exception:** The total area of the supply air ducts and outside and return air ducts shall not be required to be larger than the minimum size required by the furnace manufacturer's installation instructions and in accordance with NFPA 54.

**918.3 Heat pumps.** The minimum unobstructed total area of the outside and return air ducts or openings to a heat pump shall be not less than 6 square inches per 1,000 Btu/h (13 208 mm<sup>2</sup>/kW) output rating or as indicated by the conditions of listing of the heat pump. Electric heat pumps shall be tested in accordance with UL 1995.

**918.4 Dampers.** Volume dampers shall not be placed in the air inlet to a furnace in a manner that will reduce the required air to the furnace.

**918.5 Circulating air ducts for forced-air warm-air furnaces.** Circulating air for fuel-burning, forced-air-type, warm-air furnaces shall be conducted into the blower housing from outside the

furnace enclosure by continuous air-tight ducts.

**918.6 Prohibited sources.** Outside or return air for a forced-air heating system shall not be taken from the following locations:

1. Closer than 10 feet (3048 mm) from an appliance vent outlet, a vent opening from a plumbing drainage system or the discharge outlet of an exhaust fan, unless the outlet is 3 feet (914 mm) above the outside air inlet.
2. Where there is the presence of objectionable odors, fumes or flammable vapors; or where located less than 10 feet (3048 mm) above the surface of any abutting public way or driveway; or where located at grade level by a sidewalk, street, alley or driveway.
3. A hazardous or unsanitary location or a refrigeration machinery room as defined in this code.
4. A room or space, the volume of which is less than 25 percent of the entire volume served by such system. Where connected by a permanent opening having an area sized in accordance with Sections 918.2 and 918.3, adjoining rooms or spaces shall be considered as a single room or space for the purpose of determining the volume of such rooms or spaces.

**Exception:** The minimum volume requirement shall not apply where the amount of return air taken from a room or space is less than or equal to the amount of supply air delivered to such room or space.

5. A closet, bathroom, toilet room, kitchen, garage, mechanical room, boiler room or furnace room.
6. A room or space containing a fuel-burning appliance where such room or space serves as the sole source of return air.

**Exceptions:**

1. This shall not apply where the fuel-burning appliance is a direct-vent appliance.
2. This shall not apply where the room or space complies with the following requirements:
  - 2.1. The return air shall be taken from a room or space having a volume exceeding 1 cubic foot for each 10 Btu/h (9.6 L/W) of combined input rating of all fuel-burning appliances therein.
  - 2.2. The volume of supply air discharged back into the same space shall be

approximately equal to the volume of return air taken from the space.

- 2.3. Return-air inlets shall not be located within 10 feet (3048 mm) of any appliance firebox or draft hood in the same room or space.
3. This shall not apply to rooms or spaces containing solid fuel-burning appliances, provided that return-air inlets are located not less than 10 feet (3048 mm) from the firebox of such appliances.

**918.7 Outside opening protection.** Outdoor air intake openings shall be protected in accordance with Section 401.6.

**918.8 Return-air limitation.** Return air from one dwelling unit shall not be discharged into another dwelling unit.

### **SECTION MC 919** **CONVERSION BURNERS**

**919.1 Conversion burners.** The installation of conversion burners shall conform to ANSI Z21.8.

### **SECTION MC 920** **UNIT HEATERS**

**920.1 General.** Unit heaters shall be installed in accordance with the listing and the manufacturer's installation instructions. Oil-fired unit heaters shall be tested in accordance with UL 731.

**920.2 Support.** Suspended-type unit heaters shall be supported by elements that are designed and constructed to accommodate the weight and dynamic loads. Hangers and brackets shall be of noncombustible material. Suspended-type oil-fired unit heaters shall be installed in accordance with NFPA 31.

**920.3 Ductwork.** A unit heater shall not be attached to a warm-air duct system unless listed for such installation.

### **SECTION MC 921** **VENTED ROOM HEATERS**

**921.1 General.** Vented room heaters shall be listed and labeled and shall be installed in accordance with the conditions of the listing and the manufacturer's instructions.

### **SECTION MC 922** **KEROSENE AND OIL-FIRED STOVES**

**922.1 General.** The installation of kerosene and oil-fired stoves is prohibited.



**SECTION MC 923**  
**SMALL CERAMIC KILNS**

**923.1 General.** The provisions of this section shall apply to kilns that are used for ceramics, have a maximum interior volume of 20 cubic feet (0.566 m<sup>3</sup>) and are used for hobby and noncommercial purposes.

**923.1.1 Installation.** Kilns shall be installed in accordance with the manufacturer's installation instructions and the provisions of this code.

**SECTION MC 924**  
**STATIONARY FUEL CELL POWER PLANTS**

**924.1 General.** Stationary fuel cell power plants having a power output not exceeding 1,000 kW, shall be tested in accordance with ANSI Z21.83 and shall be installed in accordance with the manufacturer's installation instructions and NFPA 853. Only fuel cell plants that derive hydrogen from natural gas shall be used. No on-site storage of hydrogen, natural gas or any other flammable gas shall be allowed.

**SECTION MC 925**  
**MASONRY HEATERS**

**925.1 General.** Masonry heaters shall be constructed in accordance with the *New York City Building Code*.

**SECTION MC 926**  
**NOISE CONTROL REQUIREMENTS**

**926.1 Minimum air-borne noise insulation requirements.**

**926.1.1 Exterior mechanical equipment.** Mechanical equipment in a building in any occupancy group, when located outside of the building in a yard or court or on a roof, or where the equipment opens to the exterior of the building, shall be subject to the noise output limitations given in Table 926.1 where one or more windows of a dwelling unit in any building in occupancy groups R-1, R-2, and R-3, are located within a sphere of 100 foot radius (30 480 mm) whose center is any part of the equipment or its housing, unless it can be shown that the sound pressure levels, in octave bands, of the exterior mechanical equipment as measured within the dwelling unit do not exceed the levels given in Table 926.1(2).

**TABLE 926.1(1)**  
**MAXIMUM SOUND POWER LEVELS PERMITTED FOR EXTERIOR MECHANICAL**  
**EQUIPMENT ADJOINING BUILDINGS**  
**(Table 926.1(1) attached to end of document)**

**TABLE 926.1(2)**  
**NOISE OUTPUT LIMITATIONS FOR EXTERIOR MECHANICAL EQUIPMENT**  
**MAXIMUM SOUND PRESSURE LEVEL**  
**(NOT TO BE EXCEEDED IN ANY OCTAVE BANDS)**  
**(Table 926.1(2) attached to end of document)**

**926.1.2 Noise Control Code.** Sound sources shall also comply with any applicable requirements of Section 24-232 of the *Administrative Code*, also known as the *New York City Noise Control Code*.

**926.2 Minimum structure-borne noise and vibration isolation requirements.** All isolators shall comply with the requirements of Section 926.2.1 through Section 926.2.9.

**926.2.1 Boiler rooms.**

**926.2.1.1 Boilers.** All boilers supported on floors above a story having dwelling units shall be supported on resilient isolators having a minimum static deflection of 1 inch (25 mm). The isolators shall be installed directly under the structural frame of the boiler.

**926.2.1.2 Boiler breeching and piping.** When boilers are equipped with mechanical draft fans, the boiler breeching and piping that are supported from or on slabs, floors or walls that are contiguous to the dwelling unit shall be supported for a distance of 50 pipe diameters on or from resilient isolators. Each isolator shall have a minimum static deflection of 1 inch (25 mm).

**926.2.2 Incinerator charging chutes.**

**926.2.2.1 Metal chutes.** Metal chutes, metal chute supports, and/or metal chute bracing shall be free of direct contact with the shaft enclosure and the openings provided in the floor construction. Metal chutes shall be resiliently supported at each structural support location. Isolators shall provide a minimum static deflection of 0.30 inches (7.62 mm). All chutes shall be plumb.

**926.2.2.2 Masonry chutes.** The interior chute wall shall be plumb and without obstructions for the full height of the shaft and shall have a smooth interior finish.

**926.2.3 Piping.** Equipment piping shall be installed as follows:

- 1. Metal piping connected to power driven equipment shall be resiliently supported from or on the building structure for a distance of 50 pipe diameters from the power driven equipment. The resilient isolators shall have a minimum static deflection of 1 inch (25 mm) for all piping with a 4 inch (25 mm) or larger in actual outside diameter and ½ inch (12.7 mm) for piping with less than 4 inches (25 mm) in actual outside diameter. Piping connected to fluid pressure-reducing valves shall be resiliently isolated for a**

distance of 50 pipe diameters from pressure reducing valves and isolators shall provide a minimum static deflection of ½ inch (12.7 mm).

2. Equipment such as heat exchangers, absorption refrigeration machines, or similar equipment, that is located on any floor or roof other than a floor on grade, and that is not power driven but is connected by metal piping to power driven equipment, shall be resiliently supported from or on the building structure, for a distance of 50 pipe diameters from the power driven equipment. The resilient supports shall be vibration isolators having a minimum static deflection of 1 inch (25 mm) and shall incorporate approved resilient pads having a minimum thickness of ¼ inch (6.4 mm).

**926.2.4 Fans.** All fan equipment located on any roof or floor other than a floor on grade shall be mounted on or from vibration isolators. Fan equipment with motor drives separated from the fan equipment shall be supported on an isolated integral rigid structural base supporting both the fan and motor. Fan equipment with motor drives supported from the fan equipment shall be mounted directly on vibration isolators. Each isolator shall have provision for leveling. Isolators shall incorporate resilient pads having a minimum thickness of ¼ inch (6.4 mm). The vibration isolators shall provide a minimum isolation efficiency of 90 percent at fan rotor rpm with a maximum deflection of 2 inches (51 mm). Fans and compressors of 3 horsepower (2.25 kW) or less assembled in unitary containers may meet this requirement with isolators internal to the container providing the isolators meet the above minimum isolator efficiencies.

**926.2.5 Pumps.** All pumps of 3 horsepower (2.25 kW) or more located on any floor other than a floor on grade shall be supported on vibration isolators having a minimum isolation efficiency of 85 percent at the lowest disturbing frequency. Each isolator shall incorporate a leveling device and a resilient pad having a minimum thickness of ¼ inch (6.4 mm).

**926.2.6 Compressors.** Compressors and drives located on a floor other than a floor on grade shall be mounted on vibration isolators having a minimum isolation efficiency of 85 percent at the lowest disturbing frequency. Each isolator shall incorporate a leveling device and a resilient pad having a minimum thickness of ¼ inch (6.4 mm).

**926.2.7 Cooling towers.** All moving parts of cooling towers located on a roof or floor other than a floor on grade shall be installed on vibration isolators providing a minimum isolation efficiency of 85 percent at fan rotor rpm with a maximum static deflection of 4 inches (102 mm). Each isolator shall incorporate a leveling device and a resilient pad having a minimum thickness of ¼ inch (6.4 mm).

**926.2.8 Evaporative condensers.** Evaporative and air cooled condensers located on a roof or floor other than a floor on grade shall be mounted on vibration isolators providing a minimum isolation efficiency of 85 percent at fan rotor rpm with a maximum static deflection of 4 inches (102 mm). Each isolator shall incorporate a leveling device and a resilient pad having a minimum thickness of ¼ inch (6.4 mm).

**926.2.9 Duct connections to fan equipment.** Flexible connections shall be installed between fan equipment and connecting ductwork.

**CHAPTER 10**  
**BOILERS, WATER HEATERS AND**  
**PRESSURE VESSELS**

**SECTION MC 1001**  
**GENERAL**

**1001.1 Scope.** This chapter shall establish the minimum safety requirements for and shall govern the installation, alteration and repair of boilers, water heaters and pressure vessels.

**Exceptions:**

1. Pressure vessels used for unheated water supply.
2. Portable unfired pressure vessels and Interstate Commerce Commission containers.
3. Containers for bulk oxygen and medical gas.
4. Unfired pressure vessels having a volume of 5 cubic feet (0.14 m<sup>3</sup>) or less operating at pressures not exceeding 250 pounds per square inch (psi) (1724 kPa) and located within occupancies of Groups B, F, H, M, R, S and U.
5. Pressure vessels used in refrigeration systems that are regulated by Chapter 11 of this code.
6. Pressure tanks used in conjunction with coaxial cables, telephone cables, power cables and other similar humidity control systems.

**SECTION MC 1002**  
**WATER HEATERS**

**1002.1 General.** Potable water heaters and hot water storage tanks shall be listed and labeled and installed in accordance with the manufacturer's installation instructions, the *New York City Plumbing Code* and this code. All water heaters shall be capable of being removed without first removing a permanent portion of the building structure. The potable water connections and relief valves for all water heaters shall conform to the requirements of the *New York City Plumbing Code*. Domestic electric water heaters shall comply with UL 174 or UL 1453. Commercial electric water heaters shall comply with UL 1453. Oil-fired water heaters shall comply with UL 732.

**1002.2 Water heaters utilized for space heating.** Water heaters utilized both to supply potable hot water and provide hot water for space-heating applications shall be listed and labeled for such

applications by the manufacturer and shall be installed in accordance with the manufacturer's installation instructions and the *New York City Plumbing Code*.

**1002.2.1 Sizing.** Water heaters utilized for both potable water heating and space-heating applications shall be sized to prevent the space-heating load from diminishing the required potable water-heating capacity.

**1002.2.2 Scald protection.** Where a combination potable water-heating and space-heating system requires water for space heating at temperatures higher than 140°F (60°C), a tempering valve shall be provided to temper the water supplied to the potable hot water distribution system to a temperature of 140°F (60°C) or less.

**1002.3 Supplemental water-heating devices.** Potable water-heating devices that utilize refrigerant-to-water heat exchangers shall be approved and installed in accordance with *the New York City Plumbing Code* and the manufacturer's installation instructions.

## **SECTION MC 1003** **PRESSURE VESSELS**

**1003.1 General.** All pressure vessels shall bear the label of an approved agency and shall be installed in accordance with the manufacturer's installation instructions. The requirements for unfired pressure vessels shall be the same as required for boilers designed for the same operating temperatures.

**1003.2 Piping.** All piping materials, fittings, joints, connections and devices associated with systems utilized in conjunction with pressure vessels shall be designed for the specific application and shall be approved.

**1003.3 Welding.** Welding on pressure vessels shall be performed by approved certified welders in compliance with nationally recognized standards, ASME Boiler and Pressure Vessel Code Sections VIII and IX, 12 NYCRR 4-6.2, and 12 NYCRR 14-3.3 through 14-3.18.

## **SECTION MC 1004** **BOILERS**

**1004.1 Standards.** Oil-fired boilers and their control systems shall be listed and labeled in accordance with UL 726. Electric boilers and their control systems shall be listed and labeled in accordance with UL 834. Boilers shall be designed and constructed in accordance with the requirements of ASME CSD-1 and as applicable: the ASME Boiler and Pressure Vessel Code, Sections I, II, IV, V, VI, VIII and IX; 12 NYCRR Parts 4 and 14; NFPA 8501; NFPA 8502; and NFPA 8504.

**1004.2 Installation.** In addition to the requirements of this code, the installation of boilers shall conform to the manufacturer's instructions. Operating instructions of a permanent type shall be

attached to the boiler. Boilers shall have all controls set, adjusted and tested by the installer. The manufacturer's rating data and the nameplate shall be attached to the boiler.

**1004.3 Working clearance.** Clearances shall be maintained around boilers, generators, heaters, tanks and related equipment and appliances so as to permit inspection, servicing, repair, replacement and visibility of all gauges. When boilers are installed or replaced, clearance shall be provided to allow access for inspection, maintenance and repair. Passageways around all sides of boilers shall have an unobstructed width of not less than 18 inches (457 mm), unless otherwise approved, by the commissioner.

**1004.3.1 Top clearance.** High-pressure steam boilers having a steam-generating capacity in excess of 5,000 pounds per hour (2268 kg/h) or having a heating surface in excess of 1,000 square feet (93 m<sup>2</sup>) or input in excess of 5,000,000 Btu/h (1465 kW) shall have a minimum clearance of 7 feet (2134 mm) from the top of the boiler to the ceiling. Steam-heating boilers and hot-water-heating boilers that exceed one of the following limits: 5,000,000 Btu/h input (1465 kW); 5,000 pounds of steam per hour (2268 kg/h) capacity or a 1,000-square-foot (93 m<sup>2</sup>) heating surface; and high-pressure steam boilers that do not exceed one of the following limits: 5,000,000 Btu/h input (1465 kW); 5,000 pounds of steam per hour (2268 kg/h) capacity or a 1,000-square-foot (93 m<sup>2</sup>) heating surface; and all boilers with manholes on top of the boiler, shall have a minimum clearance of 3 feet (914 mm) from the top of the boiler to the ceiling. Package boilers, steam-heating boilers and hot-water-heating boilers without manholes on top of the shell and not exceeding one of the limits of this section shall have a minimum clearance of 2 feet (610 mm) from the ceiling.

**1004.4 Mounting.** Equipment and appliances shall be set or mounted on a level base capable of supporting and distributing the weight contained thereon. Boilers, tanks and equipment shall be securely anchored to the structure. Equipment and appliances requiring vibration isolation shall be installed as designed by a registered design professional in accordance with the manufacturer's installation instructions.

**1004.5 Floors.** Boilers shall be mounted on floors of noncombustible construction, unless listed for mounting on combustible flooring.

**1004.6 Boiler rooms and enclosures.** Boiler rooms and enclosures and access thereto shall comply with the *New York City Building Code* and Chapter 3 of this code. Boiler rooms shall be equipped with a floor drain or other approved means for disposing of liquid waste.

**1004.7 Operating adjustments and instructions.** Hot water and steam boilers shall have all operating and safety controls set and operationally tested by the installing contractor. A complete control diagram and boiler operating instructions shall be furnished by the installer for each installation.

**1004.8 Burner controls.** Gas and oil modulating burners shall be provided with burner controls (oil and gas equivalent ratings) in accordance with Table 1004.8.

**TABLE 1004.8**  
**MINIMUM CONTROL REQUIREMENTS**  
**(Table 1004.8 attached to end of document)**

**SECTION MC 1005**  
**BOILER CONNECTIONS**

**1005.1 Valves.** Every boiler or modular boiler shall have a shutoff valve in the supply and return piping. For multiple boiler or multiple modular boiler installations, each boiler or modular boiler shall have individual shutoff valves in the supply and return piping.

**Exception:** Shutoff valves are not required in a system having a single low-pressure steam boiler of 350,000 Btu/h (103 kW) output or less.

**1005.2 Potable water supply.** The water supply to all boilers shall be connected in accordance with the *New York City Plumbing Code*.

**SECTION MC 1006**  
**SAFETY AND PRESSURE RELIEF VALVES**  
**AND CONTROLS**

**1006.1 Safety valves for steam boilers.** All steam boilers shall be protected with a safety valve.

**1006.2 Safety relief valves for hot water boilers.** Hot water boilers shall be protected with a safety relief valve.

**1006.3 Pressure relief for pressure vessels.** All pressure vessels shall be protected with a pressure relief valve or pressure-limiting device as required by the manufacturer's installation instructions for the pressure vessel.

**1006.4 Standards of safety and safety relief valves.** Safety and safety relief valves shall be listed and labeled, and shall have a minimum rated capacity for the equipment or appliances served. Safety and safety relief valves shall be set at a maximum of the nameplate pressure rating of the boiler or pressure vessel.

**1006.5 Installation.** Safety or relief valves shall be installed directly into the safety or relief valve opening on the boiler or pressure vessel. Valves shall not be located on either side of a safety or relief valve connection. The relief valve shall discharge by gravity.

**1006.6 Safety and relief valve discharge.** Safety and relief valve discharge pipes shall be of rigid pipe that is approved for the temperature of the system. The discharge pipe shall be the same diameter as the safety or relief valve outlet. Safety and relief valves shall not discharge so as to be a hazard, a potential cause of damage or otherwise a nuisance. High-pressure-steam safety valves shall be vented to the outside of the structure. Where a low-pressure safety valve or a relief valve

discharges to the drainage system, the installation shall conform to the *New York City Plumbing Code*.

**1006.7 Boiler safety devices.** Boilers shall be equipped with controls and limit devices as required by the manufacturer's installation instructions and the conditions of the listing.

**1006.8 Electrical requirements.** The power supply to the electrical control system shall be from a two-wire branch circuit that has a grounded conductor, or from an isolation transformer with a two-wire secondary. Where an isolation transformer is provided, one conductor of the secondary winding shall be grounded. Control voltage shall not exceed 150 volts nominal, line to line. Control and limit devices shall interrupt the ungrounded side of the circuit. A means of manually disconnecting the control circuit shall be provided and controls shall be arranged so that when deenergized, the burner shall be inoperative. Such disconnecting means shall be capable of being locked in the off position and shall be provided with ready access.

**1006.8.1 Remote control (shutdown).** A remote control shall be provided to stop the flow of oil and/or gas and combustion air to any burner or fuel burning internal combustion equipment. Such control shall be located outside all means of egress to the room in which the burner or equipment is located and as close to such entrances as practicable, except that when an outside location is impracticable, such control may be located immediately inside the room in which the burner or equipment is located, provided such location is accessible at all times. All such controls shall be labeled: "REMOTE CONTROL FOR BURNER".

## **SECTION MC 1007** **BOILER LOW-WATER CUTOFF**

**1007.1 General.** All steam and hot water boilers shall be protected with dual low-water cutoff control.

**1007.1.1 High-Pressure boiler.** If the low-water cut off devices are mounted externally to the boiler, the main and auxiliary low-water cut offs shall be connected to the boiler using isolated steam side and water side connection. No other control devices, gauges or valves except for the water column drain shall be connected to the tappings on the boiler used for low-water cut offs.

**1007.2 Operation.** The low-water cutoff shall automatically stop the combustion operation of the appliance when the water level drops below the lowest safe water level as established by the manufacturer and in accordance with ASME CSD-1.

## **SECTION MC 1008** **BOILER BLOWOFF/BLOWDOWN VALVES**

**1008.1 General.** Every boiler shall be equipped with blowoff/blowdown valve(s). The valve(s) shall be installed in the openings provided on the boiler. The minimum quantity and size of each valve shall be the quantity and size specified by the boiler manufacturer or the quantity and size of the boiler blowoff/blowdown valve opening.



**1008.2 Discharge.** Blowoff/blowdown valves shall discharge to a safe place of disposal. Where discharging to the drainage system, the installation shall conform to the *New York City Plumbing Code*.

## **SECTION MC 1009** **HOT WATER BOILER EXPANSION TANK**

**1009.1 Where required.** An expansion tank shall be installed in every hot water system. For multiple boiler installations, a minimum of one expansion tank is required. Expansion tanks shall be of the closed or open type. Tanks shall be rated for the pressure of the hot water system.

**1009.2 Closed-type expansion tanks.** Closed-type expansion tanks shall be installed in accordance with the manufacturer's instructions. The size of the tank shall be based on the capacity of the hot-water-heating system. The minimum size of the tank shall be determined in accordance with the following equation:

**(Equation 10-1 attached to end of document)**

**1009.3 Open-type expansion tanks.** Open-type expansion tanks shall be located a minimum of 4 feet (1219 mm) above the highest heating element. The tank shall be adequately sized for the hot water system. An overflow with a minimum diameter of 1 inch (25 mm) shall be installed at the top of the tank. The overflow shall discharge to the drainage system in accordance with the *New York City Plumbing Code*.

## **SECTION MC 1010** **GAUGES**

**1010.1 Hot water boiler gauges.** Every hot water boiler shall have a pressure gauge and a temperature gauge, or a combination pressure and temperature gauge. The gauges shall indicate the temperature and pressure within the normal range of the system's operation.

**1010.2 Steam boiler gauges.** Every steam boiler shall have a water-gauge glass and a pressure gauge. The pressure gauge installed with a siphon shall indicate the pressure within the normal range of the system's operation.

**1010.2.1 Water-gauge glass.** The gauge glass shall be installed so that the midpoint is at the normal boiler water level.

## **SECTION MC 1011** **TESTS**

**1011.1 Tests.** Upon completion of the assembly and installation of boilers and pressure vessels, acceptance tests shall be conducted in accordance with the requirements of the *ASME Boiler and Pressure Vessel Code*. Boilers shall not be placed in operation upon completion of construction

until they have been inspected and tested and a certificate of compliance has been issued by the commissioner. All final inspections and tests for boilers shall be made by a qualified boiler inspector in the employ of the department or a duly authorized insurance company as provided in Section 204 of the Labor Law of the State of New York. Equipment having a Btu input of not more than 350,000 Btu/h (103 kW) shall be exempt from this requirement. Where field assembly of pressure vessels or boilers is required, a copy of the completed U-1 Manufacturer's Data Report required by the ASME *Boiler and Pressure Vessel Code* shall be submitted to the department.

**1011.2 Test gauges.** An indicating test gauge shall be connected directly to the boiler or pressure vessel where it is visible to the operator throughout the duration of the test. The pressure gauge scale shall be graduated over a range of not less than one and one-half times and not greater than four times the maximum test pressure. All gauges utilized for testing shall be calibrated and certified by the test operator.

**1011.3 Periodic boiler inspections.** Periodic boiler inspections shall be performed in accordance with Section 28-303 of the *Administrative Code*.

## **CHAPTER 11** **REFRIGERATION**

### **SECTION MC 1101** **GENERAL**

**1101.1 Scope.** This chapter shall govern the design, installation, construction and repair of refrigeration systems that vaporize and liquefy a fluid during the refrigerating cycle. Refrigerant piping design and installation, including pressure vessels and pressure relief devices, shall conform to this code. Permanently installed refrigerant storage systems and other components shall be considered as part of the refrigeration system to which they are attached.

**1101.2 Factory-built equipment and appliances.** Listed and labeled self-contained, factory-built equipment and appliances shall be tested in accordance with UL 207, 412, 471 or 1995. Such equipment and appliances are deemed to meet the design, manufacture and factory test requirements of this code if installed in accordance with their listing and the manufacturer's installation instructions.

**1101.3 Protection.** Any portion of a refrigeration system that is subject to physical damage shall be protected in an approved manner.

**1101.4 Water connection.** Water supply and discharge connections associated with refrigeration systems shall be made in accordance with this code and the *New York City Plumbing Code*.

**1101.5 Fuel-oil and fuel-gas connection.** Refrigeration system devices, equipment and appliances utilizing fuel oil or fuel gas for combustion shall be installed in accordance with the applicable provisions of the *New York City Fuel Gas Code* and this code.

**1101.6 General.** Refrigeration systems shall comply with the requirements of this code and, except as modified by this code, ASHRAE 15. Ammonia-refrigerating systems shall comply with this code and, except as modified by this code, ASHRAE 15 and IAR 2.

**1101.7 Maintenance.** Mechanical refrigeration systems shall be maintained in proper operating condition, free from accumulations of oil, dirt, waste, excessive corrosion, other debris and leaks.

**1101.8 Change in refrigerant type.** The type of refrigerant in refrigeration systems having a refrigerant circuit containing more than 220 pounds (100 kg) of Group A1 or 30 pounds (13.6 kg) of any other group refrigerant shall not be changed without prior notification to the commissioner and compliance with the applicable code provisions for the new refrigerant type. The refrigerant being considered shall be evaluated for suitability by an engineer. Whenever change in the type of refrigerant is to be done, consideration shall be given to the following:

1. The effects of the substitute refrigerant on materials in the system;
2. The possibility of overloading the liquid receiver, which shall not be more than 80 percent full of liquid;
3. The possibility of exceeding motor rating, design working pressure, or other requirements that would violate any of the provisions of this code;
4. The proper size of refrigerant controls;
5. The effect of the operation and setting of safety devices;
6. The possible hazards created by mixture of the original and the substituted refrigerant; and
7. The effect of the classification of the refrigerant as provided.

**1101.9 Refrigerant discharge.** Notification of refrigerant discharge shall be provided in accordance with the *New York City Fire Code*.

**1101.10 Gas and oil fired absorption systems.** Refrigeration systems utilizing fuel oil or fuel gas for combustion shall be installed in accordance with the applicable provisions of the *New York City Fuel Gas Code* and this code.

**1101.11 Signs, nameplates, and operation and emergency shutdown instructions.** Signs, nameplates, and operation and emergency shutdown instructions for refrigeration systems shall comply with the following:

1. Sections 9.15, 11.2.1, 11.2.2, 11.2.4, and 11.7 of ASHRAE 15.
2. Each refrigeration unit or system shall be provided with a nameplate indicating the horsepower of the prime mover or compressor and the equivalent of such horsepower in

kilowatts.

3. Section 1105.10 of this code.

## **SECTION MC 1102** **SYSTEM REQUIREMENTS**

**1102.1 General.** The system classification, allowable refrigerants, maximum quantity, enclosure requirements, location limitations, and field pressure test requirements shall be determined as follows:

1. Determine the refrigeration systems classification, in accordance with Section 1103.3.
2. Determine the refrigerant classification in accordance with Section 1103.1.
3. Determine the maximum allowable quantity of refrigerant in accordance with Section 1104, based on type of refrigerant, system classification, and occupancy.
4. Determine the system enclosure requirements in accordance with Section 1104.
5. Refrigeration equipment and appliance location and installation shall be subject to the limitations of Chapter 3.
6. Nonfactory-tested, field-erected equipment and appliances shall be pressure tested in accordance with Section 1108.

**1102.2 Refrigerants.** The refrigerant shall be that which the equipment or appliance was designed to utilize or converted to utilize. Refrigerants not identified in Table 1103.1 shall be approved before use.

**1102.2.1 Mixing.** Refrigerants, including refrigerant blends, with different designations in ASHRAE 34 shall not be mixed in a system.

**Exception:** Addition of a second refrigerant is allowed where permitted by the equipment or appliance manufacturer to improve oil return at low temperatures. The refrigerant and amount added shall be in accordance with the manufacturer's instructions.

**1102.2.2 Purity.** Refrigerants used in refrigeration systems shall be new, recovered or reclaimed refrigerants in accordance with Section 1102.2.2.1, 1102.2.2.2 or 1102.2.2.3. Where required by the equipment or appliance owner, the installer shall furnish a signed declaration that the refrigerant used meets the requirements of Section 1102.2.2.1, 1102.2.2.2 or 1102.2.2.3.

**Exception:** The refrigerant used shall meet the purity specifications set by the manufacturer of the equipment or appliance in which such refrigerant is used where such

specifications are different from that specified in Sections 1102.2.2.1, 1102.2.2.2 and 1102.2.2.3.

**1102.2.2.1 New refrigerants.** Refrigerants shall be of a purity level specified by the equipment or appliance manufacturer.

**1102.2.2.2 Recovered refrigerants.** Refrigerants that are recovered from refrigeration and air-conditioning systems shall not be reused in other than the system from which they were recovered and in other systems of the same owner. Recovered refrigerants shall be filtered and dried before reuse. Recovered refrigerants that show clear signs of contamination shall not be reused unless reclaimed in accordance with Section 1102.2.2.3.

**1102.2.2.3 Reclaimed refrigerants.** Used refrigerants shall not be reused in a different owner's equipment or appliances unless tested and found to meet the purity requirements of ARI 700. Contaminated refrigerants shall not be used unless reclaimed and found to meet the purity requirements of ARI 700.

## **SECTION MC 1103** **REFRIGERATION SYSTEM CLASSIFICATION**

**1103.1 Refrigerant classification.** Refrigerants shall be classified in accordance with ASHRAE 34 as listed in Table 1103.1.

### **TABLE 1103.1** **REFRIGERANT CLASSIFICATION, AMOUNT AND TLV-TWA** **(Table 1103.1 attached to end of document)**

**1103.2 Occupancy classification.** Locations of refrigerating systems are described by occupancy classifications that consider the ability of people to respond to potential exposure to refrigerants. Where equipment or appliances, other than piping, are located outside a building and within 20 feet (6096 mm) of any building opening, such equipment or appliances shall be governed by the occupancy classification of the building. Occupancy classifications shall be defined as follows:

1. Institutional occupancy is that portion of premises from which, because they are disabled, debilitated or confined, occupants cannot readily leave without the assistance of others. Institutional occupancies include, among others, hospitals, nursing homes, asylums and spaces containing locked cells.
2. Public assembly occupancy is that portion of premises where large numbers of people congregate and from which occupants cannot quickly vacate the space. Public assembly occupancies include, among others, auditoriums, ballrooms, classrooms, passenger depots, restaurants and theaters.
3. Residential occupancy is that portion of premises that provides the occupants with complete independent living facilities, including permanent provisions for living, sleeping,

eating, cooking and sanitation. Residential occupancies include, among others, dormitories, hotels, multiunit apartments and private residences.

4. Commercial occupancy is that portion of premises where people transact business, receive personal service or purchase food and other goods. Commercial occupancies include, among others, office and professional buildings, markets (but not large mercantile occupancies) and work or storage areas that do not qualify as industrial occupancies.
5. Large mercantile occupancy is that portion of premises where more than 100 persons congregate on levels above or below street level to purchase personal merchandise.
6. Industrial occupancy is that portion of premises that is not open to the public, where access by authorized persons is controlled, and that is used to manufacture, process or store goods such as chemicals, food, ice, meat or petroleum.
7. Mixed occupancy occurs when two or more occupancies are located within the same building. When each occupancy is isolated from the rest of the building by tight walls, floors and ceilings and by self-closing doors, the requirements for each occupancy shall apply to its portion of the building. When the various occupancies are not so isolated, the occupancy having the most stringent requirements shall be the governing occupancy.

**1103.3 System classification.** Refrigeration systems shall be classified according to the degree of probability that refrigerant leaked from a failed connection, seal, or component could enter an occupied area. The distinction is based on the basic design or location of the components.

**1103.3.1 Low-probability systems.** Double-indirect open-spray systems, indirect closed systems and indirect vented closed systems shall be classified as low-probability systems, provided that all refrigerant-containing piping and fittings are isolated when the quantities in Table 1103.1 are exceeded.

**1103.3.2 High-probability systems.** Direct systems and indirect open-spray systems shall be classified as high-probability systems.

**Exception:** An indirect open-spray system shall not be required to be classified as a high-probability system if the pressure of the secondary coolant is at all times (operating and standby) greater than the pressure of the refrigerant.

## **SECTION MC 1104** **SYSTEM APPLICATION REQUIREMENTS**

**1104.1 General.** The refrigerant, occupancy and system classification cited in this section shall be determined in accordance with Sections 1103.1, 1103.2 and 1103.3, respectively. For refrigerant blends assigned dual classifications, as formulated and for the worst case of fractionation, the classifications for the worst case of fractionation shall be used. Use of a Group A3 or Group B3 refrigerant is prohibited. In an industrial occupancy, a Group A3 or Group B3 refrigerant may be

used in high or low-probability systems only when approved by the commissioner and the Commissioner of the Fire Department. Such use will be approved only if the applicant can demonstrate to the satisfaction of the commissioner and the Commissioner of the Fire Department that the use of the refrigerant is a necessity and does not represent a substantial risk to life, limb, health or property.

**1104.2 Machinery room.** Except as provided in Sections 1104.2.1 and 1104.2.2, all components containing the refrigerant shall be located either outdoors or in a machinery room where the quantity of refrigerant in an independent circuit of a system exceeds the amounts shown in Table 1103.1. For refrigerant blends not listed in Table 1103.1, the same requirement shall apply when the amount for any blend component exceeds that indicated in Table 1103.1 for that component. This requirement shall also apply when the combined amount of the blend components exceeds a limit of 69,100 parts per million (ppm) by volume. Machinery rooms required by this section shall be constructed and maintained in accordance with Section 1105 for Group A1 and B1 refrigerants and in accordance with Sections 1105 and 1106 for Group A2, B2, A3 and B3 refrigerants. Nothing in this section shall be construed to allow the use of Group A3 and B3 refrigerants if otherwise prohibited.

**Exceptions:**

1. Machinery rooms are not required for listed equipment and appliances containing not more than 6.6 pounds (3 kg) of refrigerant, regardless of the refrigerant's safety classification, where installed in accordance with the equipment's or appliance's listing and the equipment or appliance manufacturer's installation instructions.
2. Piping in conformance with Section 1107 of this chapter and Section 8.10 of ASHRAE 15 is allowed in other locations to connect components installed in a machinery room with those installed outdoors.

**1104.2.1 Institutional occupancies.** The amounts shown in Table 1103.1 shall be reduced by 50 percent for all areas of institutional occupancies except kitchens, laboratories, and mortuaries. The total of all Group A2, B2, A3 and B3 refrigerants shall not exceed 550 pounds (250 kg) in occupied areas or machinery rooms. Nothing in this section shall be construed to allow the use of Group A3 and B3 refrigerants if otherwise prohibited.

**1104.2.2 Industrial occupancies and refrigerated rooms.** This section applies only to industrial occupancies and refrigerated rooms for manufacturing, food and beverage preparation, meat cutting, other processes and storage. Machinery rooms are not required where all of the following conditions are met:

1. The space containing the machinery is separated from other occupancies by tight construction with tight-fitting doors.
2. Access is restricted to authorized personnel.

3. The floor area per occupant is not less than 100 square feet (9.3 m<sup>2</sup>). Where provided with egress directly to the outdoors or into building exits meeting the requirements of the *New York City Building Code*, the minimum floor area shall not apply.
4. Refrigerant detectors are installed as required for machinery rooms in accordance with Section 1105.3.
5. Surfaces having temperatures exceeding 800°F (427°C) and open flames are not present where any Group A2, B2, A3 or B3 refrigerant is used (see Section 1104.3.4). Nothing in this section shall be construed to allow the use of Group A3 and B3 refrigerants if otherwise prohibited.
6. All electrical equipment and appliances conform to Class 1, Division 2, hazardous location classification requirements of NFPA 70 where the quantity of any Group A2, B2, A3 or B3 refrigerant in a single independent circuit would exceed 25 percent of the lower flammability limit (LFL) upon release to the space. Nothing in this section shall be construed to allow the use of Group A3 and B3 refrigerants if otherwise prohibited.
7. All refrigerant-containing parts in systems exceeding 100 hp (74.6 kW) drive power, except evaporators used for refrigeration or dehumidification; condensers used for heating; control and pressure relief valves for either; and connecting piping, shall be located either outdoors or in a machinery room.

**1104.3 Refrigerant restrictions.** Refrigerant applications, maximum quantities and use shall be restricted in accordance with Sections 1104.3.1 through 1104.3.4.

**1104.3.1 Air-conditioning for human comfort.** In other than industrial occupancies where the quantity in a single independent circuit does not exceed the amount in Table 1103.1, Group B1, B2 and B3 refrigerants shall not be used in high-probability systems for air-conditioning for human comfort. Nothing in this section shall be construed to allow the use of Group A3 and B3 refrigerants if otherwise prohibited.

**1104.3.2 Nonindustrial occupancies.** Group A2 and B2 refrigerants shall not be used in high-probability systems where the quantity of refrigerant in any independent refrigerant circuit exceeds the amount shown in Table 1104.3.2.

**TABLE 1104.3.2**  
**MAXIMUM PERMISSIBLE QUANTITIES OF REFRIGERANTS**  
**(Table 1104.3.2 attached to end of document)**

**1104.3.3 All occupancies.** The total of all Group A2, B2, A3 and B3 refrigerants other than R-717, ammonia, shall not exceed 1,100 pounds (499 kg) except where approved. Nothing in this section shall be construed to allow the use of Group A3 and B3 refrigerants if otherwise prohibited.



**1104.3.4 Protection from refrigerant decomposition.** Where any device having an open flame or surface temperature greater than 800°F (427°C) is used in a room containing more than 6.6 pounds (3 kg) of refrigerant in a single independent circuit, a hood and exhaust system shall be provided in accordance with Section 510. Such exhaust system shall exhaust combustion products to the outdoors.

**Exception:** A hood and exhaust system shall not be required:

1. Where the refrigerant is R-717, R-718, or R-744;
2. Where the combustion air is ducted from the outdoors in a manner that prevents leaked refrigerant from being combusted; or
3. Where a refrigerant detector is used to stop the combustion in the event of a refrigerant leak (see Sections 1105.3 and 1105.5).

**1104.4 Volume calculations.** Volume calculations shall be in accordance with Sections 1104.4.1 through 1104.4.3.

**1104.4.1 Noncommunicating spaces.** Where the refrigerant-containing parts of a system are located in one or more spaces that do not communicate through permanent openings or HVAC ducts, the volume of the smallest, enclosed occupied space shall be used to determine the permissible quantity of refrigerant in the system.

**1104.4.2 Communicating spaces.** Where an evaporator or condenser is located in an air duct system, the volume of the smallest, enclosed occupied space served by the duct system shall be used to determine the maximum allowable quantity of refrigerant in the system.

**Exception:** If airflow to any enclosed space cannot be reduced below one-quarter of its maximum, the entire space served by the air duct system shall be used to determine the maximum allowable quantity of refrigerant in the system.

**1104.4.3 Plenums.** Where the space above a suspended ceiling is continuous and part of the supply or return air plenum system, this space shall be included in calculating the volume of the enclosed space.

## **SECTION MC 1105** **MACHINERY ROOM, GENERAL REQUIREMENTS**

**1105.1 Design and construction.** Machinery rooms shall be designed and constructed in accordance with the *New York City Building Code* and this section.

**1105.2 Openings.** Ducts and air handlers in the machinery room that operate at a lower pressure than the room shall be sealed to prevent any refrigerant leakage from entering the airstream.

**1105.3 Refrigerant detector.** Refrigerant detectors in machinery rooms shall be provided as required by ASHRAE 15.

**1105.4 Tests.** Periodic tests of the mechanical ventilating system shall be performed in accordance with manufacturer's specifications and as required by the Commissioner of the Fire Department.

**1105.5 Fuel-burning appliances.** Open flames that use combustion air from the machinery room shall not be installed in a machinery room.

**Exceptions:**

1. Matches, lighters, halide leak detectors and similar devices.
2. Where the refrigerant is carbon dioxide or water.
3. Fuel-burning appliances shall not be prohibited in the same machinery room with refrigerant-containing equipment or appliances where combustion air is ducted from outside the machinery room and sealed in such a manner as to prevent any refrigerant leakage from entering the combustion chamber, or where a refrigerant vapor detector is employed to automatically shut off the combustion process in the event of refrigerant leakage.

**1105.6 Ventilation.** Machinery rooms shall be mechanically ventilated to the outdoors. Mechanical ventilation shall be capable of exhausting the minimum quantity of air both at normal operating and emergency conditions. Multiple fans or multispeed fans shall be allowed in order to produce the emergency ventilation rate and to obtain a reduced airflow for normal ventilation. Location of the mechanical ventilation openings shall be based on the relative density of the refrigerant to air. When compressors or self-contained unit system are housed in a machinery space, other than in a machinery room or plenum, the space shall be ventilated in accordance with the requirements of Section 1105.6.3.

**Exception:** Where a refrigerating system is located outdoors more than 20 feet (6096 mm) from any building opening and is enclosed by a penthouse, lean-to or other open structure, natural ventilation may be provided in lieu of mechanical ventilation. Location of the natural ventilation openings shall be based on the relative density of the refrigerant to air. The free-aperture cross section for the ventilation of the machinery room shall be not less than:

**(Equation 11-1 attached to end of document)**

**1105.6.1 Discharge location.** The discharge of the air shall be to the outdoors in accordance with Chapter 5. Exhaust from mechanical ventilation systems shall be discharged not less than 20 feet (6096 mm) from outdoor air intake or openings into buildings and 10 feet (3048 mm) from a fire escape or exterior stair.

**1105.6.2 Make-up air.** Provisions shall be made for make-up air to replace that being

exhausted. Openings for make-up air shall be located to avoid intake of exhaust air. Supply and exhaust ducts to the machinery room shall serve no other area, shall be constructed in accordance with Chapter 5 and shall be covered with corrosion-resistant screen of not less than ¼-inch (6.4 mm) mesh.

**Exception:** The requirement for supply and exhaust ducts to the machinery room to serve no other area shall not apply to a change in the type of refrigerant in a lawfully installed existing refrigerating system being maintained and operated in accordance with these approved installation requirements:

1. Where the replacement refrigerant has a safety classification of Group A1; or
2. Where the replacement refrigerant is R123 and the engineer or architect demonstrates to the satisfaction of the commissioner that providing such air supply and exhaust ducts represents a hardship and that the proposed alternative provides an equivalent level of safety.

**1105.6.3 Quantity-normal ventilation.** During occupied conditions, the mechanical ventilation system shall exhaust the larger of the following:

1. Not less than 0.5 cfm per square foot ( $0.0025\text{m}^3/\text{s m}^2$ ) of machinery room area or 20 cfm ( $0.009\text{m}^3/\text{s}$ ) per person; or
2. A volume required to limit the room temperature rise to 18°F (10°C) taking into account the ambient heating effect of all machinery in the room but not above a maximum temperature of 122°F (50°C).

**1105.6.4 Quantity-emergency conditions.** Upon actuation of the refrigerant detector required in Section 1105.3, the mechanical ventilation system shall exhaust air from the machinery room in the following quantity:

**(Equation 11-2 attached to end of document)**

**1105.7 Termination of relief devices.** In addition to the requirements of Section 9.7.8 of ASHRAE 15, pressure relief devices, fusible plugs and purge systems located within the machinery room shall terminate outside of the structure at a location not less than 15 feet (4572 mm) above the adjoining grade level and not less than 20 feet (6096 mm) from any window, ventilation opening or exit.

**1105.7.1 Discharge of Group A2, B2, A3 and B3 refrigerants.** Discharge of systems containing Group A2 or B2 refrigerants shall be acceptable to the commissioner. Discharge of systems containing Group A3 or B3 refrigerants shall be subject to the approval of the commissioner and the Commissioner of the Fire Department. Nothing in this section shall be construed to approve the use of Group A3 and B3 refrigerants if otherwise prohibited.

**1105.7.2 Certificate of qualification.** Discharge of pressure relief devices, fusible plugs and purge systems for refrigerating systems containing flammable, toxic and highly toxic refrigerants and ammonia shall comply with Section 606 of the *New York City Fire Code*.

**1105.8 Ammonia discharge.** Pressure relief valves for ammonia systems shall discharge in accordance with ASHRAE 15.

**1105.9 Remote control.** A clearly identified switch of the break-glass type shall provide off-only control of the compressors in the machinery room. A second clearly identified switch of the break-glass type shall provide on-only control of the machinery room ventilation fans. Such switches shall be located outside each entrance to the machinery room and as close to the entrance as practicable, except that when an outside location is impracticable, such switches may be located immediately inside the machinery room provided such location is accessible at all times.

**1105.10 Emergency signs.** Signs shall comply with the following:

1. Sections 8.11.8 and 11.2.4 of ASHRAE 15.
2. Refrigeration units or systems having a refrigerant circuit containing more than 220 pounds (100 kg) of Group A1 or 30 pounds (14 kg) of any other group refrigerant shall be provided with approved emergency signs, charts, and labels in accordance with NFPA 704.

## **SECTION MC 1106** **MACHINERY ROOM, SPECIAL REQUIREMENTS**

**1106.1 General.** Where required by Section 1104.2, the machinery room shall meet the requirements of this section in addition to the requirements of Section 1105.

**1106.2 Elevated temperature.** There shall not be an open flame-producing device or continuously operating hot surface over 800°F (427°C) permanently installed in the room.

**1106.3 Ammonia room ventilation.** Ventilation systems in ammonia machinery rooms shall be operated continuously.

### **Exceptions:**

1. Machinery rooms equipped with a vapor detector that will automatically start the ventilation system and actuate an alarm at a detection level not to exceed 1,000 ppm; or
2. Machinery rooms conforming to the Class 1, Division 2, hazardous location classification requirements of the *New York City Electrical Code*.

**1106.4 Flammable refrigerants.** Where refrigerants of Groups A2, A3, B2 and B3 are used, the machinery room shall conform to the Class 1, Division 2, hazardous location classification requirements of the *New York City Electrical Code*.

**Exception:** Ammonia machinery rooms. Nothing in this section shall be construed to approve the use of Group A3 and B3 refrigerants if otherwise prohibited.

**1106.5 Remote controls.** Remote control of the mechanical equipment and appliances located in the machinery room shall be provided at an accessible location immediately outside the machinery room and adjacent to its principal entrance.

**1106.5.1 Refrigeration system.** A clearly identified switch of the break-glass type shall provide off-only control of all electrically energized equipment and appliances in the machinery room, other than refrigerant leak detectors and machinery room ventilation.

**1106.6** Reserved.

## **SECTION MC 1107** **REFRIGERANT PIPING**

**1107.1 General.** All refrigerant piping shall be installed, tested and placed in operation in accordance with this chapter.

**1107.2 Pipe enclosures.** Rigid or flexible metal enclosures or pipe ducts shall be provided for soft, annealed copper tubing used for refrigerant piping erected on the premises and containing other than Group A1 refrigerant. Enclosures shall not be required for connections between condensing units and the nearest riser box(es), provided such connections do not exceed 6 feet (1829 mm) in length.

**1107.3 Condensation.** All refrigerating piping and fittings, brine piping and fittings that, during normal operation, will reach a surface temperature below the dew point of the surrounding air, and are located in spaces or areas where condensation will cause a safety hazard to the building occupants, structure, electrical equipment or any other equipment or appliances, shall be protected in an approved manner to prevent such damage.

**1107.4 Materials for refrigerant pipe and tubing.** Piping materials shall be as set forth in Sections 1107.4.1 through 1107.4.6.

**1107.4.1 Steel pipe.** Carbon steel pipe with a wall thickness not less than Schedule 80 shall be used for Group A2, A3, B2 or B3 refrigerant liquid lines for sizes 1.5 inches (38 mm) and smaller. Carbon steel pipe with a wall thickness not less than Schedule 40 shall be used for Group A1 or B1 refrigerant liquid lines 6 inches (152 mm) and smaller, Group A2, A3, B2 or B3 refrigerant liquid lines sizes 2 inches (51 mm) through 6 inches (152 mm) and all refrigerant suction and discharge lines 6 inches (152 mm) and smaller. Type F steel pipe shall not be used for refrigerant lines having an operating temperature less than -20°F (-29°C).

**1107.4.2 Copper and brass pipe.** Standard iron-pipe size, copper and red brass (not less than 80-percent copper) pipe shall conform to ASTM B 42 and ASTM B 43.

**1107.4.3 Copper tube.** Copper tube used for refrigerant piping erected on the premises shall be seamless copper tube of Type ACR (hard or annealed) complying with ASTM B 280. Where approved, copper tube for refrigerant piping erected on the premises shall be seamless copper tube of Type K or L (drawn or annealed) in accordance with ASTM B 88. Annealed temper copper tube shall not be used in sizes larger than a 2-inch (51 mm) nominal size. Mechanical joints shall not be used on annealed temper copper tube in sizes larger than  $\frac{7}{8}$ -inch (22.2 mm) OD size.

**1107.4.4 Copper tubing joints.** Copper tubing joints used in refrigerating systems containing Group A2, A3, B1, B2 or B3 refrigerants shall be brazed. Soldered joints shall not be used in such refrigerating systems.

**1107.4.5 Aluminum tube.** Type 3003-0 aluminum tubing with high-pressure fittings shall not be used with methyl chloride and other refrigerants known to attack aluminum.

**1107.4.6 Insulation.** Pipe and chiller insulation shall meet the requirements of Section 1204.1 of this code.

**1107.5 Joints and refrigerant-containing parts in air ducts.** Joints and all refrigerant-containing parts of a refrigerating system located in an air duct of an air-conditioning system carrying conditioned air to and from human-occupied space shall be constructed to withstand, without leakage, a pressure of 150 percent of the higher of the design pressure or pressure relief device setting.

**1107.6 Exposure of refrigerant pipe joints.** Refrigerant pipe joints erected on the premises shall be exposed for visual inspection prior to being covered or enclosed.

**1107.7 Stop valves.** All systems containing more than 6.6 pounds (3 kg) of a refrigerant in systems using positive-displacement compressors shall have stop valves installed as follows:

1. At the inlet of each compressor, compressor unit or condensing unit.
2. At the discharge outlet of each compressor, compressor unit or condensing unit and of each liquid receiver.

**Exceptions:**

1. Systems that have a refrigerant pumpout function capable of storing the entire refrigerant charge in a receiver or heat exchanger.
2. Systems that are equipped with provisions for pumpout of the refrigerant using either portable or permanently installed recovery equipment.
3. Self-contained systems.

**1107.7.1 Liquid receivers.** All systems containing 100 pounds (45 kg) or more of a refrigerant, other than systems utilizing nonpositive displacement compressors, shall have stop valves, in addition to those required by Section 1107.7, on each inlet of each liquid receiver. Stop valves shall not be required on the inlet of a receiver in a condensing unit, nor on the inlet of a receiver which is an integral part of the condenser.

**1107.7.2 Copper tubing.** Stop valves used with soft annealed copper tubing or hard-drawn copper tubing  $\frac{7}{8}$ -inch (22.2 mm) OD standard size or smaller shall be securely mounted, independent of tubing fastenings or supports.

**1107.7.3 Identification.** Stop valves shall be identified where their intended purpose is not obvious. Numbers shall not be used to label the valves, unless a key to the numbers is located near the valves.

## **SECTION MC 1108** **FIELD TEST**

**1108.1 General.** Every refrigerant-containing part of every system that is erected on the premises, except compressors, condensers, vessels, evaporators, safety devices, pressure gauges and control mechanisms that are listed and factory tested, shall be tested and proved tight after complete installation, and before operation. Tests shall include both the high- and low-pressure sides of each system at not less than the lower of the design pressures or the setting of the pressure relief device(s). The design pressures for testing shall be those listed on the condensing unit, compressor or compressor unit name-plate, as required by ASHRAE 15.

### **Exceptions:**

1. Gas bulk storage tanks that are not permanently connected to a refrigeration system.
2. Systems using an A1 refrigerant erected on the premises with copper tubing not exceeding  $\frac{5}{8}$ -inch (15.8 mm) OD, with wall thickness as required by ASHRAE 15, shall be tested in accordance with Section 1108.1, or by means of refrigerant charged into the system at the saturated vapor pressure of the refrigerant at 70°F (21°C) or higher.
3. Limited-charge systems equipped with a pressure relief device, erected on the premises, shall be tested at a pressure not less than one and one-half times the pressure setting of the relief device. If the equipment or appliance has been tested by the manufacturer at one and one-half times the design pressure, the test after erection on the premises shall be conducted at the design pressure.

**1108.1.1 Booster compressor.** Where a compressor is used as a booster to obtain an intermediate pressure and discharges into the suction side of another compressor, the booster compressor shall be considered a part of the low side, provided that it is protected by a

pressure relief device.

**1108.1.2 Centrifugal/nonpositive displacement compressors.** In field-testing systems using centrifugal or other nonpositive displacement compressors, the entire system shall be considered as the low-side pressure for field test purposes.

**1108.2 Test gases.** Tests shall be performed with an inert-dried gas including, but not limited to, nitrogen and carbon dioxide. Oxygen, air, flammable gases and mixtures containing such gases shall not be used.

**Exceptions:**

1. The use of air is allowed to test R-717, ammonia, systems provided that they are subsequently evacuated before charging with refrigerant.
2. Mixtures of dry nitrogen, inert gases, or a combination of them with nonflammable refrigerants in concentrations of a refrigerant weight fraction (mass fraction) not exceeding 5 are allowed for tests.

**1108.3 Test apparatus.** The means used to build up the test pressure shall have either a pressure-limiting device or a pressure-reducing device and a gauge on the outlet side.

**1108.4 Declaration.** A certificate of test shall be provided for all systems containing 55 pounds (25 kg) or more of refrigerant. The certificate shall give the name of the refrigerant and the field test pressure applied to the high-side and the low side of the system. The certification of test shall be signed by the installer and shall be made part of the public record.

**SECTION MC 1109**  
**PERIODIC TESTING**

**1109.1 Testing required.** The following emergency devices and systems shall be periodically tested and the results logged in accordance with the manufacturer's instructions and as required by the Commissioner of the Fire Department:

1. Treatment and flaring systems.
2. Valves and appurtenances necessary to the operation of emergency refrigeration control boxes.
3. Fans and associated equipment intended to operate emergency purge ventilation systems.
4. Detection and alarm systems.

**1109.2 Operation.** Operating permits and qualification of operators for refrigeration systems



shall comply with the requirements of the *New York City Fire Code* and the rules of the Fire Department.

**CHAPTER 12**  
**HYDRONIC PIPING**

**SECTION MC 1201**  
**GENERAL**

**1201.1 Scope.** The provisions of this chapter shall govern the construction, installation, alteration and repair of hydronic piping systems. This chapter shall apply to hydronic piping systems that are part of heating, ventilation and air-conditioning systems. Such piping systems shall include steam, hot water, chilled water, condenser water, cooling coil condensate drain, steam condensate and ground source heat pump loop systems. Potable cold and hot water distribution systems shall be installed in accordance with the *New York City Plumbing Code*.

**1201.2 Pipe sizing.** Piping for hydronic systems shall be sized for the demand of the system.

**SECTION MC 1202**  
**MATERIAL**

**1202.1 Piping.** Piping material shall conform to the standards cited in this section.

**Exception:** Embedded piping regulated by Section 1209.

**1202.2 Used existing materials.** Reused pipe, fittings, valves or other materials shall be clean and free of foreign materials.

**1202.3 Material rating.** Materials shall be rated for the operating temperature and pressure of the hydronic system. Materials shall be suitable for the type of fluid in the hydronic system.

**1202.4 Piping materials standards.** Hydronic pipe shall conform to the standards listed in Table 1202.4. The exterior of the pipe shall be protected from corrosion and degradation.

**TABLE 1202.4**  
**HYDRONIC PIPE**  
**(Table 1202.4 attached to end of document)**

**1202.5 Pipe fittings.** Hydronic pipe fittings shall be approved for installation with the piping materials to be installed, and shall conform to the respective pipe standards or to the standards listed in Table 1202.5.

**TABLE 1202.5**  
**HYDRONIC PIPE FITTINGS**  
**(Table 1202.5 attached to end of document)**

**1202.6 Valves.** Valves shall be constructed of materials that are compatible with the type of piping material and fluids in the system. Valves shall be rated for the temperatures and pressures of the systems in which the valves are installed.

**1202.7 Flexible connectors, expansion and vibration compensators.** Flexible connectors, expansion and vibration control devices and fittings shall be of an approved type.

## **SECTION MC 1203** **JOINTS AND CONNECTIONS**

**1203.1 Approval.** Joints and connections shall be of an approved type. Joints and connections shall be tight for the pressure of the hydronic system.

**1203.1.1 Joints between different piping materials.** Joints between different piping materials shall be made with approved adapter fittings. Joints between different metallic piping materials shall be made with approved dielectric fittings or brass converter fittings.

**1203.2 Preparation of pipe ends.** Pipe shall be cut square, reamed and chamfered, and shall be free of burrs and obstructions. Pipe ends shall have full-bore openings and shall not be undercut.

**1203.3 Joint preparation and installation.** When required by Sections 1203.4 through 1203.14, the preparation and installation of brazed, mechanical, soldered, solvent-cemented, threaded and welded joints shall comply with Sections 1203.3.1 through 1203.3.7.

**1203.3.1 Brazed joints.** Joint surfaces shall be cleaned. An approved flux shall be applied where required. The joint shall be brazed with a filler metal conforming to AWS A 5.8.

**1203.3.2 Mechanical joints.** Mechanical joints shall be installed in accordance with the manufacturer's instructions.

**1203.3.3 Soldered joints.** Joint surfaces shall be cleaned. A flux conforming to ASTM B 813 shall be applied. The joint shall be soldered with a solder conforming to ASTM B 32.

**1203.3.4 Solvent-cemented joints.** CPVC joints shall be made in accordance with ASTM D 2846. Joint surfaces shall be clean and free of moisture. An approved primer shall be applied to CPVC and PVC pipe-joint surfaces. Joints shall be made while the cement is wet. Solvent cement conforming to the following standards shall be applied to all joint surfaces:

1. ASTM D 2235 for ABS joints.
2. ASTM F 493 for CPVC joints.
3. ASTM D 2564 for PVC joints.

**1203.3.5 Threaded joints.** Threads shall conform to ASME B 1.20.1. Schedule 80 or heavier plastic pipe shall be threaded with dies specifically designed for plastic pipe. Thread lubricant, pipe-joint compound or tape shall be applied on the male threads only and shall be approved for application on the piping material.

**1203.3.6 Welded joints.** Joint surfaces shall be cleaned by an approved procedure. Joints shall be welded with an approved filler metal.

**1203.3.7 Grooved and shouldered joints.** Grooved and shouldered joints shall be approved and installed in accordance with the manufacturer's installation instructions.

**1203.3.8 Mechanically formed tee fittings.** Mechanically extracted outlets shall have a height not less than three times the thickness of the branch tube wall.

**1203.3.8.1 Full flow assurance.** Branch tubes shall not restrict the flow in the run tube. A dimple/depth stop shall be formed in the branch tube to ensure that penetration into the outlet is of the correct depth. For inspection purposes, a second dimple shall be placed 0.25 inch (6.4 mm) above the first dimple. Dimples shall be aligned with the tube run.

**1203.3.8.2 Brazed joints.** Mechanically formed tee fittings shall be brazed in accordance with Section 1203.3.1.

**1203.4 ABS plastic pipe.** Joints between ABS plastic pipe or fittings shall be solvent-cemented or threaded joints conforming to Section 1203.3.

**1203.5 Brass pipe.** Joints between brass pipe or fittings shall be brazed, mechanical, threaded or welded joints conforming to Section 1203.3.

**1203.6 Brass tubing.** Joints between brass tubing or fittings shall be brazed, mechanical or soldered joints conforming to Section 1203.3.

**1203.7 Copper or copper-alloy pipe.** Joints between copper or copper-alloy pipe or fittings shall be brazed, mechanical, soldered, threaded or welded joints conforming to Section 1203.3.

**1203.8 Copper or copper-alloy tubing.** Joints between copper or copper-alloy tubing or fittings shall be brazed, mechanical or soldered joints conforming to Section 1203.3 or flared joints conforming to Section 1203.8.1.

**1203.8.1 Flared joints.** Flared joints shall be made by a tool designed for that operation.

**1203.9 CPVC plastic pipe.** Joints between CPVC plastic pipe or fittings shall be solvent-cemented or threaded joints conforming to Section 1203.3.

**1203.10 Reserved.**

**1203.11 Cross-linked polyethylene (PEX) plastic tubing.** Joints between cross-linked polyethylene plastic tubing and fittings shall conform to Sections 1203.11.1 and 1203.11.2. Mechanical joints shall conform to Section 1203.3.

**1203.11.1 Compression-type fittings.** When compression-type fittings include inserts and ferrules or O-rings, the fittings shall be installed without omitting the inserts and ferrules or O-rings.

**1203.11.2 Plastic-to-metal connections.** Soldering on the metal portion of the system shall be performed at least 18 inches (457 mm) from a plastic-to-metal adapter in the same water line.

**1203.12 PVC plastic pipe.** Joints between PVC plastic pipe and fittings shall be solvent-cemented or threaded joints conforming to Section 1203.3.

**1203.13 Steel pipe.** Joints between steel pipe or fittings shall be mechanical joints that are made with an approved elastomeric seal, or shall be threaded or welded joints conforming to Section 1203.3.

**1203.14 Steel tubing.** Joints between steel tubing or fittings shall be mechanical or welded joints conforming to Section 1203.3.

**1203.15 Polyethylene plastic pipe and tubing for ground source heat pump loop systems.** Joints between polyethylene plastic pipe and tubing or fittings for ground source heat pump loop systems shall be heat fusion joints conforming to Section 1203.15.1, electrofusion joints conforming to Section 1203.15.2, or stab-type insertion joints conforming to Section 1203.15.3.

**1203.15.1 Heat-fusion joints.** Joints shall be of the socket-fusion, saddle-fusion or butt-fusion type, fabricated in accordance with the piping manufacturer's instructions. Joint surfaces shall be clean and free of moisture. Joint surfaces shall be heated to melt temperatures and joined. The joint shall be undisturbed until cool. Fittings shall be manufactured in accordance with ASTM D 2683.

**1203.15.2 Electrofusion joints.** Joints shall be of the electrofusion type. Joint surfaces shall be clean and free of moisture, and scoured to expose virgin resin. Joint surfaces shall be heated to melt temperatures for the period of time specified by the manufacturer. The joint shall be undisturbed until cool. Fittings shall be manufactured in accordance with ASTM F 1055.

**1203.15.3 Stab-type insert fittings.** Joint surfaces shall be clean and free of moisture. Pipe ends shall be chamfered and inserted into the fittings to full depth. Fittings shall be manufactured in accordance with ASTM D 2513.

**SECTION MC 1204**  
**PIPE INSULATION**

**1204.1 Insulation characteristics.** Pipe insulation installed in buildings shall conform to the requirements of the *Energy Conservation Construction Code of New York State*, shall be tested in accordance with ASTM E 84 and shall have a maximum flame spread index of 25 and a smoke-developed index not exceeding 450. Insulation installed in an air plenum shall comply with Section 602.2.1.

**1204.2 Required thickness.** Hydronic piping shall be insulated to the thickness required by the *Energy Conservation Construction Code of New York State*.

## **SECTION MC 1205** **VALVES**

**1205.1 Where required.** Shutoff valves shall be installed in hydronic piping systems in the locations indicated in Sections 1205.1.1 through 1205.1.5.

**1205.1.1 Heat exchangers.** Shutoff valves shall be installed on the supply and return side of a heat exchanger.

**Exception:** Shutoff valves shall not be required when heat exchangers are integral with a boiler; or are a component of a manufacturer's boiler and heat exchanger packaged unit and are capable of being isolated from the hydronic system by the supply and return valves required by Section 1005.1.

**1205.1.2 Central systems.** Shutoff valves shall be installed on the building supply and return of central utility systems, and district heating and cooling systems.

**1205.1.3 Pressure vessels.** Shutoff valves shall be installed on the connection to any pressure vessel.

**1205.1.4 Pressure-reducing valves.** Shutoff valves shall be installed on both sides of a pressure-reducing valve.

**1205.1.5 Equipment and appliances.** Shutoff valves shall be installed on connections to mechanical equipment and appliances. This requirement does not apply to components of a hydronic system such as pumps, air separators, metering devices and similar equipment.

**1205.2 Reduced pressure.** A pressure relief valve shall be installed on the low-pressure side of a hydronic piping system that has been reduced in pressure. The relief valve shall be set at the maximum pressure of the system design. The valve shall be installed in accordance with Section 1006.

## **SECTION MC 1206** **PIPING INSTALLATION**

**1206.1 General.** Piping, valves, fittings and connections shall be installed in accordance with the conditions of approval.

**1206.1.1 Prohibited tee applications.** Fluid in the supply side of a hydronic system shall not enter a tee fitting through the branch opening.

**1206.2 System drain down.** Hydronic piping systems shall be designed and installed to permit the system to be drained. Where the system drains to the plumbing drainage system, the installation shall conform to the requirements of the *New York City Plumbing Code*.

**1206.3 Protection of potable water.** The potable water system shall be protected from backflow in accordance with the *New York City Plumbing Code*.

**1206.4 Pipe penetrations.** Openings for pipe penetrations in walls, floors or ceilings shall be larger than the penetrating pipe. Openings through concrete or masonry building elements shall be sleeved. The annular space surrounding pipe penetrations shall be protected in accordance with the *New York City Building Code*.

**1206.5 Clearance to combustibles.** A pipe in a hydronic piping system in which the exterior temperature exceeds 250°F (121°C) shall have a minimum clearance of 1 inch (25 mm) to combustible materials.

**1206.6 Contact with building material.** A hydronic piping system shall not be in direct contact with building materials that cause the piping material to degrade or corrode, or that interfere with the operation of the system.

**1206.7 Water hammer.** The flow velocity of the hydronic piping system shall be controlled to reduce the possibility of water hammer. Where a quick-closing valve creates water hammer, an approved water-hammer arrestor shall be installed. The arrestor shall be located within a range as specified by the manufacturer of the quick-closing valve.

**1206.8 Steam piping pitch.** Steam piping shall be installed to drain to the boiler or the steam trap. Steam systems shall not have drip pockets that reduce the capacity of the steam piping.

**1206.9 Strains and stresses.** Piping shall be installed so as to prevent detrimental strains and stresses in the pipe. Provisions shall be made to protect piping from damage resulting from expansion, contraction and structural settlement. Piping shall be installed so as to avoid structural stresses or strains within building components.

**1206.9.1 Flood hazard.** Piping located in areas of special flood hazard shall comply with Appendix G of the *New York City Building Code*.

**1206.10 Pipe support.** Pipe shall be supported in accordance with Section 305. Seismic supports shall be provided where required by the *New York City Building Code*.

**1206.11 Condensation.** Provisions shall be made to prevent the formation of condensation on the exterior of piping.

### **SECTION MC 1207** **TRANSFER FLUID**

**1207.1 Flash point.** The flash point of transfer fluid in a hydronic piping system shall be a minimum of 50°F (28°C) above the maximum system operating temperature.

**1207.2 Makeup water.** The transfer fluid shall be compatible with the makeup water supplied to the system.

### **SECTION MC 1208** **TESTS**

**1208.1 General.** Hydronic piping systems other than ground-source heat pump loop systems shall be tested hydrostatically at one and one half times the system design operating pressure, but not less than 100 psi (689 kPa). The duration of each test shall be not less than 2 hours. Ground-source heat pump loop systems shall be tested in accordance with Section 1208.1.1.

**1208.1.1 Ground source heat pump loop systems.** Before connection (header) trenches are backfilled, the assembled loop system shall be pressure tested with water at 100 psi (689 kPa) for 30 minutes with no observed leaks. Flow and pressure loss testing shall be performed and the actual flow rates and pressure drops shall be compared to the calculated design values. If actual flow rate or pressure drop values differ from calculated design values by more than 10 percent, the problem shall be identified and corrected.

### **SECTION MC 1209** **EMBEDDED PIPING**

**1209.1 Materials.** Piping for heating panels shall be standard-weight steel pipe, Type L copper tubing, or approved plastic pipe or tubing rated at 100 psi (689 kPa) at 180°F (82°C).

**1209.2 Pressurizing during installation.** Piping to be embedded in concrete shall be pressure tested prior to pouring concrete. During pouring, the pipe shall be maintained at the proposed operating pressure.

**1209.3 Embedded joints.** Joints of pipe or tubing that are embedded in a portion of the building, such as concrete or plaster, shall be in accordance with the requirements of Sections 1209.3.1 and 1209.2.

**1209.3.1 Steel pipe joints.** Steel pipe shall be welded by electrical arc or oxygen/acetylene method.

1209.3.2 Copper tubing joints. Copper tubing shall be joined by brazing with filler metals having a melting point of not less than 1,000°F (538°C).

1209.4 Reserved.

## SECTION MC 1210 HIGH-PRESSURE STEAM PIPING SYSTEMS

1210.1 Scope. The provisions of this section shall apply to high-pressure steam piping system which is defined as a system operating at a steam pressure of more than 15 psi (103 kPa). For purposes of this section, loops, bends or offsets of the piping shall not be considered expansion joints.

1210.2 New systems. For purposes of this section, the replacement of existing steam piping systems, the installation of a new system in existing buildings, as well as installations in buildings hereafter constructed, shall be considered to be new high-pressure steam piping systems. The following requirements are applicable:

1210.2.1 Design. The design of new steam piping systems shall be conducted as follows:

1. The system shall be designed by an engineer. An application and plans shall be filed and the approval of the department obtained. The plans and application shall contain, but not be limited to, the following information:
  - 1.1. Size and location of all steam piping.
  - 1.2. The operating pressures and temperatures.
  - 1.3 The location, type, specifications and details of all expansion joints.
  - 1.4 The design, size, material and location of all anchors, guides and auxiliary steel, and the stresses thereon.
2. Systems using utility street steam shall be designed for a pressure of 200 psig (1379 kPa) and 413°F (212°C) up to and including the steam pressure reducing valve or valves which reduce the pressure of 90 psig (621 kPa) or below. For steam pressures between 90 psig (621 kPa) and 16 psig (110 kPa), the system shall be designed for 125 psig (108 kPa).

1210.2.2 Installation. The installation of new steam piping systems shall be conducted as follows:

1. Installations, including any welding, shall be by special inspection by the engineer responsible for the design, or by an engineer acceptable to him or her.



2. Welders shall be qualified for all required pipe sizes, wall thicknesses and positions in accordance with the ASME Boiler and Pressure Vessel Code, Section IX. Requalification is required every three years or sooner if the commissioner has a specific reason to doubt a welder's ability to make sound welds.
3. Welder qualification testing shall be performed by an agency listed with the department, and if the testing is by radiography, the inspection shall have a minimum radiography qualification of Level II in accordance with the ASNT, Document No. SNT-TC-1A.
4. Copies of the certified welder qualification reports shall be maintained by the responsible welding agency and the company performing the welding, and shall be made available upon request to the department.
5. No reports from any welding inspection agency shall be accepted unless such agency has first requested and obtained approval from the department in accordance with rules of the department.
6. Pipe welding shall conform to the following:
  - 6.1 All piping over 2 inches (51 mm) shall be butt-welded. Piping 2 inches (76 mm) and under may be socket-welded or threaded.
  - 6.2 Threaded piping may continue to be used for existing construction in sizes of 6 inches (152 mm) and under.
  - 6.3 Where welding is not feasible, the commissioner may allow an acceptable alternative.
7. Radiographic examination, when required, shall be performed on butt-welds in accordance with ASME B31.1 based on the piping pressure and shall be as follows:

<b><u>Piping Pressure</u></b>	<b><u>Percentage</u></b>
<u>90 psig (621 kPa) or below</u>	<u>Not Required</u>
<u>91 psig (627 kPa) to 150 psig (1034 kPa)</u>	<u>10 at Random</u>
<u>Over 150 psig (1034 kPa)</u>	<u>100</u>

However, if, in the opinion of the engineer responsible for controlled inspection, radiographic examination is not required for piping at pressure between 90 psig (621 kPa) and 150 psig (1034 kPa), the engineer shall so specify in writing, and the final report on the installation may omit the foregoing, and be predicated on all of the other requirements noted in this section, and a hydrostatic test.

**1210.2.3 Testing.** Hydrostatic testing shall be conducted on the completed installation at 150 percent of the design pressure for all piping pressure. Where the changes in an existing steam system involve less than 30 percent of the piping in the system, the testing may be in accordance with ASME B31.1.

**1210.2.4 Relocation.** The commissioner, where deemed necessary, shall require the replacement or relocation of any joints, guides or anchors. The commissioner shall cause the joints in potentially hazardous locations, such as those that are located adjacent to tenant occupied spaces, to be relocated, unless means exist or are provided for eliminating the hazard.

**1210.3 Existing systems.** Existing steam piping systems shall be in accordance with Sections 1210.3.1 through 1210.3.3. Upon the completion of a new high-pressure steam piping system and department approval of same, the rules relating to maintenance requirements and the keeping of records for existing high-pressure steam piping systems shall apply.

**1210.3.1 Maintenance inspections.** Expansion joints, anchorage and guides shall be inspected as follows:

1. Expansion joints shall be inspected weekly.
2. The anchorage and guides shall be inspected annually. Exposure of the structural attachments to the buildings of the anchorages or guides shall not be required..
3. A record of such inspections shall be kept by the person in charge of the mechanical equipment of the building or other qualified person designated by the owner and acceptable to the commissioner. The records shall be available at the premises and subject to inspection by the commissioner.

**1210.3.2 Work approval.** No joint, anchorage or guides shall be repaired, replaced or relocated without a work permit issued by the department. The application for the permit shall contain all pertinent information and shall be filed by an engineer knowledgeable as to high-pressure steam piping systems. The engineer shall be responsible for the special inspection of the proposed work in accordance with the approved application. This provision shall not apply to the repacking of a slip or ball joint; however, records of such repacking shall be kept in the inspection records as provided in Section 1210.3.1, Item 3. When, in the opinion of the engineer, the requirement for prior department approval would create an imminent health or safety hazard, the engineer may permit the work to proceed without prior approval. In such cases, the engineer shall, prior to the repair, replacement or relocation, notify by telephone the borough commissioner of the borough in which the building is located; and, if the emergency occurs at other than normal working hours, he or she shall notify the department in a manner prescribed by the commissioner. This shall be followed by the filing of the application for department approval as specified in Section 28-105.4.1 of the *Administrative Code*.

## **CHAPTER 13**

## FUEL-OIL PIPING AND STORAGE

### SECTION MC 1301 GENERAL

**1301.1 Scope.** This chapter shall govern the design, installation, construction and repair of fuel-oil storage and piping systems. The storage of flammable and combustible liquids not addressed in this chapter shall be in accordance with the *New York City Fire Code*.

**1301.2 Storage and piping systems.** Fuel-oil storage and piping systems shall comply with the requirements of Chapter 13 and, to the extent not otherwise provided for in this code, shall comply with the requirements of NFPA 31. All aboveground and underground storage facilities with a combined storage capacity of over 1,100 gallons (4160 L) shall also comply with the requirements of the *New York State Department of Environmental Conservation's Petroleum Bulk Storage Code*; 6 NYCRR Parts 612, 613, and 614.

**1301.3 Fuel type.** An appliance shall be designed for use with the type of fuel to which it will be connected. Such appliance shall not be converted from the fuel specified on the rating plate for use with a different fuel without securing reapproval from the commissioner.

**1301.4 Fuel tanks, piping and valves.** The tank, piping and valves for appliances burning oil shall be installed in accordance with the requirements of this chapter. When oil burning equipment is served by a tank located such that any part of the tank is above the level of the burner inlet connection and where the fuel supply line is taken from the top of the tank, an approved anti-siphon valve or other siphon-breaking device shall be installed. The anti-siphon valve or siphon-breaking device shall be located at the highest point in the supply line.

**Exceptions:** An anti-siphon valve or other siphon-breaking device shall not be required where either:

1. An approved foot valve is used in the tank, or
2. No. 6 fuel oil is used.

**1301.5 Out of service system.** Fuel-oil storage systems that are temporarily or permanently taken out of service shall comply with the requirements of the Fire Code.

**1301.6 Fuel-oil spill and overflow prevention equipment.** Fuel-oil spill and overflow prevention equipment shall comply with EPA 40 CFR Parts 280, and Section 1305.6.6.

**1301.7 Portable fire extinguishers.** Portable fire extinguishers with a minimum weight of 30 pounds (13.64 kg) shall be provided as required by the Fire Code and NFPA 10.

**1301.8 Absorbent materials.** The building owner shall maintain a sufficient quantity of absorbent materials near fuel-oil storage tanks, pumps, and related equipment to control leaks and slipping hazards.

**1301.9 Certificate of fitness.** Where fuel-oil piping systems utilize pumps to transfer fuel-oil to equipment at levels above the lowest floor or to storage tanks at levels above the lowest floor in buildings, a qualified employee or contracted general company holding a certificate of fitness from the Fire Department shall maintain the fuel-oil system.

## **SECTION MC 1302** **MATERIAL**

**1302.1 General.** Piping materials shall conform to the standards cited in this section.

**1302.2 Rated for system.** All materials shall be rated for the operating temperatures and pressures of the system, and shall be compatible with the type of liquid being handled by the system.

**1302.3 Pipe standards.** Fuel-oil pipe shall comply with the standards listed in Table 1302.3.

**Exception:** Piping for fuel-oil systems utilizing a transfer pump to equipment at levels above the lowest floor or to storage tanks at levels above the lowest floor in buildings shall comply with the requirements of Section 1305.9.5.

### **TABLE 1302.3** **FUEL-OIL PIPING** **(Table 1302.3 attached to end of document)**

**1302.4 Nonmetallic pipe.** All nonmetallic pipe shall be listed and labeled as being acceptable for the intended application for flammable and combustible liquids. Nonmetallic pipe shall be installed only outside, underground.

**1302.5 Fittings and valves.** Fittings and valves shall be approved for the piping systems, and shall be compatible with, or shall be of the same material as, the pipe or tubing.

**1302.6 Bending of pipe.** Pipe shall be approved for bending. Pipe bends shall be made with approved equipment. The bend shall not exceed the structural limitations of the pipe.

**1302.7 Pumps.** Pumps that are not part of an appliance shall be of a positive-displacement type. The pump shall automatically shut off the supply when not in operation. Pumps shall be listed and labeled in accordance with UL 343.

**1302.8 Flexible connectors and hoses.** Flexible metal connectors and hoses used where rigid connections are impractical or to reduce the effect of jarring and vibration shall be listed and labeled in accordance with UL 536 and shall be installed in compliance with its label and the

manufacturer's installation instructions. Connectors made from combustible materials shall not be used inside buildings or above ground outside of buildings.

### **SECTION MC 1303** **JOINTS AND CONNECTIONS**

**1303.1 Approval.** Joints and connections shall be approved and of a type approved for fuel-oil piping systems. All threaded joints and connections shall be made tight with suitable lubricant or pipe compound. Unions requiring gaskets or packings, right or left couplings, and sweat fittings employing brazing material having a melting point of less than 1,000°F (538°C) shall not be used in oil lines. Cast-iron fittings shall not be used. Joints and connections shall be tight for the pressure required by test.

**1303.1.1 Joints between different piping materials.** Joints between different piping materials shall be made with approved adapter fittings. Joints between different metallic piping materials shall be made with approved dielectric fittings or brass converter fittings.

**1303.2 Reserved.**

**1303.3 Joint preparation and installation.** Where required by Sections 1303.4 through 1303.10, the preparation and installation of brazed, threaded and welded joints shall comply with Sections 1303.3.1 through 1303.3.4.

**1303.3.1 Brazed joints.** All joint surfaces shall be cleaned. An approved flux shall be applied where required. The joints shall be brazed with a filler metal conforming to AWS A5.8.

**1303.3.2 Mechanical joints.** Mechanical joints utilizing an elastomeric and/or compression seal are not permitted.

**1303.3.3 Threaded joints.** Threads shall conform to ASME B1.20.1. Pipe-joint compound or tape shall be applied on the male threads only.

**1303.3.4 Welded joints.** All joint surfaces shall be cleaned by approved procedure. The joint shall be welded with an approved filler metal.

**1303.4 Brass pipe.** Joints between brass pipe or fittings shall be brazed, mechanical, threaded or welded joints complying with Section 1303.3.

**1303.5 Reserved.**

**1303.6 Copper or copper-alloy pipe.** Joints between copper or copper-alloy pipe or fittings shall be brazed, mechanical, threaded or welded joints complying with Section 1303.3.

**1303.7 Copper or copper-alloy tubing.** Joints between copper or copper-alloy tubing or fittings shall be brazed or mechanical joints complying with Section 1303.3 or flared joints. Flared joints shall be made by a tool designed for that operation.

**1303.8 Nonmetallic pipe.** Joints between nonmetallic pipe or fittings shall be installed in accordance with the manufacturer's instructions for the labeled pipe and fittings.

**1303.9 Steel pipe.** Joints between steel pipe or fittings shall be threaded or welded joints complying with Section 1303.3.

**1303.10 Reserved.**

**1303.11 Piping protection.** Proper allowance shall be made for expansion, contraction, jarring and vibration. Piping other than tubing, connected to underground tanks, except straight fill lines and test wells, shall be provided with flexible connectors, or otherwise arranged to permit the tanks to settle without impairing the tightness of the piping connections. Piping serving equipment at levels above the lowest floor or storage tanks at levels above the lowest floor in buildings shall also comply with the requirements of Section 1305.9.6 and 1305.9.7.

#### **SECTION MC 1304** **PIPING SUPPORT**

**1304.1 General.** Pipe supports shall be in accordance with Section 305. Piping serving equipment at levels above the lowest floor or storage tanks at levels above the lowest floor in buildings shall also comply with the requirements of Section 1305.9.6 and 1305.9.7.

#### **SECTION MC 1305** **FUEL-OIL SYSTEM INSTALLATION**

**1305.1 General.** Fuel-oil piping systems shall be installed in accordance with this section.

**1305.2 Protection of pipe, equipment and appliances.** All fuel-oil pipe, equipment and appliances shall be protected from physical damage. Piping serving equipment at levels above the lowest floor or storage tanks at levels above the lowest floor in buildings shall also comply with the requirements of Section 1305.9.

**1305.2.1 Flood hazard.** All fuel-oil pipe, tanks, equipment and appliances located in areas of special flood hazard shall comply with Appendix G of the *New York City Building Code*.

**1305.3 Supply piping.** Supply piping shall comply with the requirements of Sections 1305.3.1 through 1305.3.7.

**1305.3.1 Size.** The fuel-oil system shall be sized for the maximum capacity of fuel oil required. The minimum size of a supply line shall be  $\frac{3}{8}$ -inch (9.5 mm) inside diameter nominal pipe or  $\frac{3}{8}$ -inch (9.5 mm) OD tubing.

**1305.3.2 Connections to tank.** Supply piping shall connect to the top of the fuel-oil tank.

**Exception:** Storage tanks in buildings that comply with all of the following conditions:

1. The tank is located above ground on the lowest floor;
2. The tank does not exceed 330 gallons (1250 L) ; and
3. The tank is provided with a ¾-inch (19.1 mm) opening for gravity discharge and a 1-inch (25 mm) opening in the bottom for cleaning and protection against corrosion.

**1305.3.3 Pumps.** Fuel oil shall be supplied by a transfer pump or automatic pump or by other approved means.

**1305.3.4 Smoke detectors.** Appropriate safeties shall be provided so that detection of smoke or heat within the generator or equipment room shall prevent additional fuel oil from being pumped into the piping system within such room, including a fusible link operated lever gate valve in the supply pipe at the wall of the generator room.

**1305.3.5 Horizontal runouts.** Horizontal runouts from risers to the generator or equipment room shall follow as direct a route as practicable.

**1305.3.6 Direct feed.** Systems where day tanks are absent (such as generator installations where fuel oil is taken directly from a fuel-oil pipe or header into the engine) shall comply with Section 1305.9.12.

**1305.3.7 Piping from transfer pump to equipment or storage tanks above the lowest floor.** Supply piping from a transfer pump to equipment at levels above the lowest floor or storage tanks at levels above the lowest floor in buildings shall also comply with the requirements of Section 1305.9.

**1305.4 Return piping.** Return piping shall connect to the top of the fuel-oil tank. The minimum size of a return line shall be ¼-inch (6.4 mm) inside diameter nominal pipe or <sup>5</sup>/<sub>16</sub>-inch (7.9 mm) outside diameter tubing. Valves shall not be installed on return piping unless a means of relieving overpressure is provided. Return piping serving equipment at levels above the lowest floor or storage tanks at levels above the lowest floor in buildings shall also comply with the requirements of Section 1305.9.

**1305.5 System pressure.** The system shall be designed for the maximum pressure required by the fuel-oil-burning appliance. Air or other gases shall not be used to pressurize tanks. Pressure in a storage tank for the purpose of discharging oil shall be prohibited.

**1305.6 Fill piping.** Fill piping shall comply with the requirements of Section 1305.6.1 through 1305.6.6.

**1305.6.1 Size.** Fill piping shall be a minimum of 2 inches (51 mm) in diameter or 3 inches (76 mm) for No. 6 fuel oil.

**1305.6.2 Termination location.** A fill pipe shall terminate outside of a building at or above grade at a point least 2 feet (610 mm) from any building opening and 5 feet (1524 mm) away from any subway grating at the same or lower level. A fill pipe shall terminate in a manner designed to minimize spilling when the filling hose is disconnected. Where No. 6 fuel oil is used, the fill pipe terminal shall be within 3 feet (914 mm) of the curb unless otherwise required by the Department of Transportation or the Transit Authority. If facilities exist for an oil delivery truck to drive onto the premises, the fuel-oil terminal may be located elsewhere other than the curb.

**1305.6.3 Separate fill piping.** Each storage tank shall be provided with a separate fill pipe, except that where a battery of tanks containing the same grade of oil is installed, a common fill and header pipe may be installed.

**1305.6.4 Check valve.** Where the top of the storage tank is above the fill pipe terminal, the fill pipe shall be connected to the top of the tank and provided with a shut-off valve and swing check valve, both of which shall be located at the fill pipe terminal. The shut-off valve and swing check valve may be installed in an accessible location inside the building at or below the level of the fill pipe terminal.

**1305.6.5 Terminal opening.** The fill opening shall be equipped with a tight metal cover designed to discourage tampering. All fill pipe terminals shall be of an approved type and shall be provided with lugs for embedding in concrete. In lieu of lugs, a set screw or threads to fasten the terminal to the fill pipe may be used. The outer flange of the fill pipe terminal or the seal cap shall be permanently marked: FUEL OIL. The fill pipe terminal shall be threaded or provided with other equivalent means to receive the seal cap. The seal cap shall be suitably slotted for receiving an opening wrench, and an oilproof gasket inserted in a groove in the fill pipe terminal shall be provided so as to make the seal cap leakproof. A strainer shall not be required but if used, shall be of at least 1/8-inch (3.2 mm) mesh. Where a storage system for volatile flammable oil and a storage system for fuel oil are to be used in the same premises, the terminal of the fuel-oil pipe shall be provided with a left-handed thread and the fill pipe fitting shall be of a different size than that required for the fill pipes to the tanks containing the volatile flammable oil.

**1305.6.6 Spill containment.** For fill pipes serving tanks greater than 660 gallons (2500 L), an approved overflow/spill containment device shall be provided.

**1305.7 Normal vent piping.** Normal vent piping shall comply with the requirements of Section 1305.7.1 through 1305.7.9.

**1305.7.1 Size.** Normal vent sizes shall comply with the sizes listed in Tables 1305.7(1) and 1305.7(2); provided, however, for tanks other than those complying with the alternate tank



design and construction standards contained in Section 1305.14, the normal vent shall not be smaller in size than the supply pipe.

**1305.7.2 Termination location.** The location of the normal vent pipe terminations shall comply with the following:

1. Liquid fuel normal vent pipes shall terminate outside of buildings in a nonhazardous location at a point not less than 2 feet (610 mm) measured vertically or horizontally from any building opening and not less than 2 feet (610 mm) nor more than 12 feet (3658 mm) above the fill pipe terminal.
2. If the normal vent pipe terminal is not visible from the fill pipe terminal location, a 1-inch (25 mm) tell-tale line shall be connected to the tank and shall parallel the fill pipe and terminate at the fill pipe terminal with an unthreaded end. Such tell-tale lines shall be provided with a check valve set to prevent flow of surface water to the storage tank.
3. Normal vent pipes shall terminate sufficiently above the ground to avoid being obstructed with snow or ice.
4. Normal vent pipes from tanks containing heaters shall be extended to a location where oil vapors discharging from the normal vent will be readily diffused.

**1305.7.3 Termination caps.** Outer ends of normal vent pipes shall terminate in a weatherproof vent cap or fitting or be provided with a weatherproof hood. All normal vent caps shall have a minimum free open area equal to the cross-sectional area of the normal vent pipe and shall not employ screens finer than No. 4 mesh.

**1305.7.4 Tank pressure.** The tank shall be designed for the maximum static head that will be imposed with the normal vent piping filled with oil.

**1305.7.5 Multiple Tanks.** A normal vent pipe shall be provided for each storage tank. Normal vent piping from multiple tanks of the same grade oil with not more than 660 gallons (2500 L) aggregate capacity may be combined. Where a battery of storage tanks complying with the alternate tank design and construction standards contained in Section 1305.14 designed to hold the same grade of oil with not more than 660 gallons (2500 L) aggregate capacity is installed, normal vent pipes may be run into a main header.

**1305.7.6 Pitch.** Normal vent pipes shall drain toward the tank. The normal vent pipes shall have no sags or traps where liquid can collect.

**1305.7.7 Protection.** Normal vent pipes shall be located so that they are not subjected to physical damage.

**1305.7.8 Cross-connection.** Liquid fuel normal vent pipes shall not be cross-connected with fill pipes, lines from burners or overflow lines from auxiliary tanks.

**1305.7.9 Tanks above the lowest floor.** For tanks installed above the lowest floor, the normal vent shall be piped, in an approved manner, into the vent or top of tank of the lowest floor storage tank that supplies the fuel to such tank.

**TABLE 1305.7(1)**  
**VENT PIPING FOR UNDERGROUND TANKS**  
**(Table 1305.7(1) attached to end of document)**

**TABLE 1305.7(2)**  
**VENT PIPING FOR TANKS INSTALLED INSIDE BUILDINGS**  
**(Table 1305.7(2) attached to end of document)**

**1305.8 Emergency relief vent piping.** Each primary tank, the interstitial space of a secondary containment tank and each compartment of a compartment tank complying with UL 142 shall be provided with emergency relief venting. A tank's emergency relief vent piping and normal vent piping shall be combined. The design and installation of the combined normal and emergency relief vent shall be in accordance with Section 1305.7 and Sections 1305.8.1 through 1305.8.4.

**1305.8.1 Piping.** The combination normal and emergency relief venting shall be provided through an open vent pipe connected directly, as applicable, to the primary tank, interstitial space or compartment. The use of a self-closing manway cover, a manway cover provided with long bolts that permit the cover to lift under internal pressure, or other type emergency relief vent device, shall be prohibited.

**1305.8.2 Termination.** Combination normal and emergency relief vent piping shall terminate outdoors.

**1305.8.3 Tanks above the lowest floor.** For tanks installed inside of buildings above the lowest floor, the combination normal and emergency vent piping shall be piped, in an approved manner, into the vent or top of tank of the lowest floor storage tank that supplies the fuel to such tank.

**1305.8.4 Capacity.** The total relief venting capacity of the combination normal and emergency relief venting shall be in accordance with Section 4.2.5.2 of NFPA 30. Construction documents shall include calculations demonstrating that the extension of the normal and emergency vent piping is adequately sized to provide the required emergency vent flow while limiting the back pressure to less than the maximum pressure permitted by the design of the tank. Additionally, consistent with Section 4.2.5.2.5 of NFPA 30, where the design provides for a reduction in the required emergency relief venting capacity based upon the properties of the fuel oil to be stored in the tank, the construction documents shall include supporting calculations.

**1305.9 Supplemental requirements for piping from transfer pumps to equipment or storage tanks above lowest floor.** Fuel-oil piping systems utilizing pumps to transfer fuel-oil to

equipment at levels above the lowest floor or storage tanks at levels above the lowest floor in buildings shall comply with the requirements of Section 1305.9.1 through 1305.9.12.

**1305.9.1 Shaft enclosure.** The piping from a transfer pump to equipment at levels above the lowest floor or storage tanks at levels above the lowest floor in buildings, the return piping, and vent piping shall be enclosed in a shaft constructed of 4-inch (102 mm) concrete or masonry having a 4-inch (102 mm) clearance from all pipe or pipe covering, except that no such enclosures shall be required within the room containing the pump, tank, or equipment where such room is itself enclosed with construction and materials having at least a 2-hour fire resistance rating.

**1305.9.2 Ducts or other piping in shafts.** Pipe shafts containing fuel-oil piping shall not be penetrated by or contain other piping or ducts.

**1305.9.3 Horizontal offsets.** Where it is necessary to make horizontal offsets in the supply piping and pipe shafts, such piping shall be enclosed in a sleeve of other piping of at least No. 10 standard Gage steel, two sizes larger than the supply piping and arranged to drain into the shaft. Horizontal piping offsets shall be further enclosed in construction having a 2-hour fire-resistance rating except that no such enclosure or pipe sleeve shall be required within the room containing the pump, tank, or equipment where such room is itself enclosed with construction and materials having at least a 2-hour fire-resistance rating.

**1305.9.4 Drain at base of shafts; leak detection.** A drain pipe shall be installed at the base of shafts enclosing the supply and overflow piping. The pipe shall lead to a dedicated sump or minimum 55 gallon (208 L) container with a leak detection alarm, arranged so as to sound an alarm and stop the transfer pump. The alarm shall be connected to a local audible alarm and to a remote alarm located at a supervising station. The wiring shall comply with the *New York City Electrical Code*.

**1305.9.5 Piping materials.** Oil lines for equipment or tanks shall be steel pipe ASTM A 53 or ASTM A 106, grade B seamless Schedule 40 with welded connections up to the oil tank or equipment, except that fittings at the tank or equipment, shut-off valves and other fuel-oil flow and control devices may be screwed or flanged.

**1305.9.6 Expansion.** Provision shall be made for expansion in piping without the use of expansion joints.

**1305.9.7 Movement and vibration.** The piping shall be located and secured from movement so as to prevent undue stress on the piping and to isolate the piping from vibrations from any equipment.

**1305.9.8 Connections to header.** Pipe connections to the main header (supply or return) shall be made from the top of the header, except for systems with equipment above the lowest floor where such equipment is designed to operate utilizing fuel pumped as needed from the lowest floor and without utilizing fuel oil stored above the lowest floor.

**1305.9.9 Air vents and breakers.** Required air vents and vacuum breakers shall be designed for their required use.

**1305.9.10 Curb or pan.** All air vents and vacuum breakers shall be hard-piped to a curb or pan.

**1305.9.11 Pipe size; fuel storage above the lowest floor.** In systems with equipment above the lowest floor where such equipment is designed to operate utilizing fuel stored above the lowest floor, piping diameters shall not exceed 4 inches (102 mm). However, where an applicant demonstrates by the inclusion of calculations in the construction documents that a greater diameter is necessary to ensure the proper flow for the functioning of the system, such greater diameter may be permitted. Piping shall not be used for fuel storage purposes.

**1305.9.12 Pipe size; without fuel storage above the lowest floor.** In systems with equipment above the lowest floor, where such equipment is designed to operate utilizing fuel pumped as needed from the lowest floor and without utilizing fuel oil stored above the lowest floor, piping diameters throughout such systems shall not exceed the design flow (three times the maximum firing rate as calculated by the engineer or architect). However, piping diameters within rooms containing such equipment may exceed the calculated design flow pipe size to provide limited reservoir storage to prime equipment, provided such reservoir storage is counted toward the maximum permitted oil storage per story, as provided for in Section 1305.11.1.3.

**1305.10 Devices to control flow to oil-burning equipment.** The following requirements shall apply:

1. The pressure in oil lines to oil-burning equipment located above the lowest floor of a building shall not be more than is required to circulate oil to and from the burners, and all parts of the oil system shall be capable of withstanding the maximum working pressure in that part of the system.
2. A remote control shall be provided to stop the flow of oil to any burner wherever located, and to any oil-burning equipment located on levels above the lowest floor in buildings. Such control shall be located outside the entrance to the room in which the burner is located and as close to such entrance as practicable, except that when an outside location is impracticable, such control may be located immediately inside the room in which the burner is located, provided such location is accessible at all times. All such controls shall be permanently labeled: "REMOTE CONTROL FOR OIL BURNER", "REMOTE CONTROL FOR GENERATOR", or as appropriate to the oil-burning equipment. On storage tanks of 60 gallons (227 L) or less capacity used with manually operated equipment, such remote control may be installed in the supply lines between tank and burner.

3. In systems where either steam or air is used for atomizing the oil, the oil and the atomizing supply shall be interlocked so that where the supply of either is interrupted, the supply of the other will be immediately cut off.

**1305.11 Limitations on quantities of fuel-oil storage.** Quantities of fuel-oil storage shall be limited in accordance with the provisions of this section. For the purposes of this section, fuel oil stored on roofs shall be deemed inside of buildings and located on the floor to which they are adjacent.

**1305.11.1 Inside of buildings.** A total of not more than 100,000 gallons (378 000 L) shall be stored inside of any building. Oil-storage inside of buildings shall also comply with applicable requirements of Sections 1305.11.1.1 through 1305.11.1.3.

**1305.11.1.1 Inside of buildings; below ground.** The maximum size of each below-ground oil-storage tank inside of a building shall be 35,000 gallons (132 475 L).

**1305.11.1.2 Inside of buildings; above ground on the lowest floor.** Fuel-oil storage tanks installed above ground on the lowest floor of a building shall be mounted on and anchored by adequate noncombustible supports. The maximum size of each individual tank shall be 660 gallons (2500 L), and a total of not more than 1375 gallons (5200 L) shall be stored within the same 2-hour fire area.

**Exceptions.** Fuel-oil storage tanks shall be permitted to exceed 660 gallons (2500 L), and the total quantity within a fire area shall be permitted to exceed 1375 gallons (5200 L) in accordance with any one of the following options:

- 1. Buildings of Type I, II, IIIA, IV or VA construction with a total limit of 15,000 gallons.** The maximum size of each individual tank shall be 15,000 gallons (56 775 L) provided that all such tanks are located in a room or enclosure dedicated to oil storage that is separated from the rest of the building by fire-resistance-rated construction of at least 3 hours. Notwithstanding Section 1305.11.1, in such cases, the maximum total quantity in the building shall be limited to 15,000 gallons (56 775 L).
- 2. Buildings of Type IIIB or VB construction with a total limit of 10,000 gallons.** The maximum size of each individual tank shall be 10,000 gallons (37 850 L) provided that all such tanks are located in a room or enclosure dedicated to oil storage that is separated from the rest of the building by fire-resistance-rated construction of at least 3 hours. Notwithstanding Section 1305.11.1, in such cases, the maximum total quantity in the building shall be limited to 10,000 gallons (56 775 L).
- 3. Buildings of any type construction with a total limit of 100,000 gallons.** The maximum size of each individual tank shall be 25,000 gallons (94 625 L) provided that all such tanks are enclosed in a vault (i) with walls, floor, and top having a fire

resistance rating of not less than 3 hours, (ii) with such walls bonded to the floor, and (iii) with such top and walls of the vault independent of the building structure. An exterior building wall having a fire resistance rating of not less than 3 hours shall be permitted to serve as a wall of the vault. The vault shall be located in a dedicated room or area of the building that is cut off vertically and horizontally from other areas and floors of the building by assemblies having a fire resistance rating of not less than 2 hours. Where the aggregate fuel-oil storage on the lowest level of the building exceeds 50,000 gallons (189 250 L), such storage shall be protected with an alternate extinguishing system complying with Section 904 of the *New York City Building Code*.

**1305.11.1.3 Inside of buildings; above the lowest floor.** Fuel-oil above the lowest floor inside of a building shall be limited to 330 gallons (1249 L) per story. The maximum quantity shall include oversized piping as described in 1305.9.12. Piping installations shall comply with the requirements of Section 1305.9.

**1305.11.2 Outside of buildings.** Oil-storage outside of buildings shall comply with applicable requirements of Sections 1305.11.2.1 and 1305.11.2.2.

**1305.11.2.1 Outside of buildings; below ground.** The maximum size of each below-ground oil-storage tank outside of a building shall be 35,000 gallons (132 475 L).

**1305.11.2.2 Outside of buildings; above ground.** The maximum size of each above-ground oil-storage tank outside of a building shall be 100,000 gallons (37 800 L).

**1305.12 Standards for Tank Design.** Tanks shall be designed and constructed in compliance with Sections 1305.12.1 and 1305.12.2.

**1305.12.1 Below ground.** Tanks located below ground, inside or outside of buildings, shall comply with any one of the following design standards, as appropriate for the specific installation as determined by the engineer:

1. UL 58; such tanks shall be listed and labeled;
2. UL 1316; such tanks shall be listed and labeled; or
3. Alternate tank design and construction standards contained in Section 1305.14

**1305.12.2 Above ground.** Tanks located above ground, inside or outside of buildings, shall comply with any one of the following design standards, as appropriate for the specific installation as determined by the engineer:

1. UL 80; such tanks shall be listed and labeled;
2. UL 142; such tanks shall be listed and labeled;

3. ASME Boiler and Pressure Vessel Code, Section VIII, Division 1 or 2; such tanks shall be listed and labeled; or
4. Alternate tank design and construction standards contained in Section 1305.14

**1305.13 Installation of tanks.** Tanks shall be installed in accordance with the provisions of section 1305.13.1 through 1305.13.4. For the purposes of this section, fuel oil stored on roofs shall be deemed inside of buildings.

**1305.13.1 Below ground.** Tanks located below ground, inside or outside of buildings, shall comply with the following requirements:

1. **Containment.** Fuel-oil tanks having a capacity of more than 660 gallons (2500 L) shall be provided with secondary containment intended to prevent any leakage of fuel oil from the tank from entering the environment. The capacity of the containment shall equal or exceed the capacity of the tank served.
2. **Burial.** Regardless of capacity, fuel-oil tanks shall be buried with the top of the tank at least 2 feet (610 mm) below ground. Tanks shall be placed in firm soil and shall be surrounded by clean sand or well-tamped earth, free from ashes or other corrosive substance, and free from stones that will not pass a 1-inch (25 mm) mesh.
3. **Anchorage.** When necessary to prevent floating, fuel-oil tanks, regardless of capacity, shall be securely anchored.
4. **Distance to foundations.** Regardless of capacity, no fuel-oil tank shall be buried within 3 feet (914 mm) of any foundation wall or footing.
5. **Special limitations near subways.** Regardless of capacity, no fuel-oil tank shall be placed within 20 feet (6096 mm) of the outside line of a subway wall. For the purpose of the foregoing requirement, a subway shall be deemed to include any subsurface railroad or rapid transit roadbed.

**1305.13.2 Above ground; on the lowest floor inside a building.** Tanks located above ground, on the lowest floor inside of buildings, shall comply with the following requirements:

1. **Containment.** Fuel-oil tanks having a capacity of more than 660 gallons (2500 L) storage shall be provided with secondary containment intended to capture any leakage of fuel oil from the tank. The capacity of the containment shall equal or exceed the capacity of the tank served.
2. **Special limitations near subways.** Regardless of capacity, fuel-oil tanks located within the outer lines of the subway, or within 20 feet (6096 mm) of the outside line of a subway wall shall be placed within a welded steel oil tight pan of not less than No. 18

Gage metal suitably reinforced and of capacity to contain the contents of the tank. For the purpose of the foregoing requirement, a subway shall be deemed to include any subsurface railroad or rapid transit roadbed.

**1305.13.3 Above ground; above the lowest floor inside a building.** Regardless of capacity, fuel-oil tanks and fuel-oil-burning equipment located above ground, above the lowest floor inside of buildings, shall comply with the following requirements:

1. **Enclosure of room.** Fuel-oil tanks and fuel-oil-burning equipment shall be located in a dedicated room or enclosure, having a fire resistance rating of at least 2 hours. Rooftop tanks need not be enclosed provided that all exterior walls and roof surfaces within 10 feet (3048 mm) horizontally and 20 feet (6096 mm) vertically have a fire resistance rating of at least 2 hours.
2. **Fire extinguishing system.** Rooms containing fuel-oil tanks and fuel-oil-burning equipment shall be equipped with an automatic sprinkler system in accordance with section 903.3.1 of the *New York City Building Code*. To prevent overfilling of the containment barriers, sprinkler shut-offs shall be located on the outside of tank and generator rooms and prominently placarded for immediate control by the Fire Department.
3. **Smoke detection.** Rooms containing fuel-oil tanks and fuel-oil-burning equipment shall be equipped with automatic smoke detection in accordance with Section 907 of the *New York City Building Code*, except that heat detectors may be utilized where, during normal operation, products of combustion are present in sufficient quantity to actuate a smoke detector.
4. **Ventilation.** Rooms containing fuel-oil tanks shall be ventilated to limit the concentration of vapors within the room at or below 25% of the Lower Flammable Limit (LFL) of the fuel oil being used.
5. **Containment.** Fuel-oil tanks, fuel-oil-burning equipment, and related equipment shall be provided with secondary containment area intended to capture any leakage of fuel oil. Floor drains shall be prohibited in containment areas. For tanks, the capacity of the containment area shall equal or exceed 2 times the capacity of the tank served. For fuel-oil-burning equipment the capacity of the containment area shall equal or exceed 1.5 times the storage capacity of the equipment.
6. **Transfer pumps.** Fuel-oil tanks shall be filled by means of a transfer pump supplied from a primary storage tank located on the lowest floor. A separate transfer pump and piping circuit shall be provided for each storage tank installed above the lowest floor. No intermediate pumping stations shall be provided between the storage tank and the transfer pump. Appropriate devices shall be provided for the automatic and manual starting and stopping of the transfer pumps so as to prevent the overflow of oil from these storage tanks.



7. **Indicators and alarms.** Indicators and alarms shall be provided for fuel oil tanks and rooms containing fuel-oil-burning equipment, including a level sensor for height and capacity of fuel oil, high and low levels, and leak detection. The float switch shall be provided within the containment areas and shall be arranged so as to sound an alarm and stop the transfer pump in case of failure of the tank or the control in the tank. These indicators shall be connected to a local audible alarm in the tank room and to a remote alarm located at a supervising station. The wiring shall comply with the *New York City Electrical Code*.
8. **Weekly testing.** The operation of the float switch shall be tested at least once each week by the holder of the certificate of fitness as provided for in Sections 1301.9 and .1308.3.

**1305.13.4 Above ground; outside a building.** Tanks located above ground, outside of buildings, shall comply with the following requirements:

1. **Containment.** Regardless of capacity, each fuel-oil storage tank shall be protected by an embankment or dike. Such protection shall have a capacity at least 1½ times the capacity of the tank so surrounded and shall be at least 4 feet (1219 mm) high, but in no case shall the protection be higher than ¼ the height of the tank when the height of the tank exceeds 16 feet (4877 mm). Embankments or dikes shall be made of earthwork with clay core, of masonry, of reinforced concrete or of steel. Earth work embankments shall be firmly and compactly built of good earth free from stones, vegetable matter, or other similar material, and shall have a flat section of at least 3 feet (914 mm) at the top and a slope of at least 1½ (457 mm) rise to 2 feet (610 mm) of run on all sides. Concrete, masonry or steel dikes shall be designed so as to contain safely all of the oil in the tank so surrounded. Embankments or dikes shall be continuous and unpierced, and the outside toe shall be located at least 5 feet (1524 mm) inside of the property line, and no less than 5 feet (1524 mm) from a driveway or parking area.
2. **Distances to buildings, lot lines, and other tanks.** Storage tanks of a capacity greater than 330 gallons (1250 L) shall be not less than 1¼ tank diameters and in no case less than 10 feet (3048 mm) from the tax lot line, the nearest building or adjacent tank. However, in no case shall the clearance between individual tanks and the tax lot line be less than the distance fixed by the following formula:

$$\text{M.C.} = 10 + 4 \left[ \frac{G - 275}{5000} \right]$$

where:

M.C. = minimum clearance from nearest surface of tank to tax lot line, in feet.

G = capacity of tank, in gallons.

3. Means of egress. Tanks shall be located so as not to obstruct or interfere with any means of egress.

## 1305.14

1305.14.1 General construction standards. All tanks shall comply with the requirements of Section 1305.14.1.1 through 1305.14.1.9.

1305.14.1.1 Materials and workmanship. All fuel-oil storage tanks shall be built of steel plates or sheets, made by the open hearth or basic oxygen process. Such steel shall be free from physical imperfections, and shall be new, in good condition, and free from rust.

1305.14.1.2 Assembly. Tanks, flanges or other pipe connections shall be welded. Filler of any kind between plates shall be prohibited.

1305.14.1.3 Corrosion resistance. Tanks to be buried shall be cleaned and then coated on the outside with two coats of corrosion protective material. They shall be further protected by a coating of hot tar, asphalt, or equivalent rust resistive material, applied at the work site. Tanks installed inside buildings above ground shall be coated with one coat of corrosion protective material.

1305.14.1.4 External loads on underground tanks. All buried storage tanks shall be constructed of at least ¼-inch (6.4 mm) thick metal and shall be designed to withstand any external loads to which the tank may be subjected.

1305.14.1.5 Identification. At the time of installation all storage tanks shall bear a permanently-fixed plate, spot welded or equivalent, bearing the name of the tank manufacturer, the gage of the material, and capacity of the tank. Shop-fabricated storage tanks shall be installed without structural alteration.

1305.14.1.6 Openings. All openings shall be through the top of the storage tank, except that storage tanks of 275 gallon (1041 L) capacity or less, located above ground but below the lowest story, may be provided with a ¾-inch (19.1 mm) opening for gravity discharge and a 1-inch (25 mm) opening in the bottom for cleaning and protection against corrosion.

1305.14.1.7 Manholes. Tanks for No. 1, No. 2, No. 3 and No. 4 commercial grade oils need not have manholes. However, if manholes are used for tanks containing such oils, the manhole covers shall be bolted and made gas tight. Tanks for No. 5 and No. 6 commercial grade oils shall have manhole covers bolted or otherwise secured to the tanks and kept hydrostatically tight at all times. Tanks 275 gallons (1041 L) capacity or less, and all other tanks without manholes, shall be provided with a 2 screwed connection on the top of the tank to permit measuring the level of the oil within.

**1305.14.1.8 Electrical grounding.** Tanks outside of buildings shall be electrically grounded in accordance with the requirements for equipment grounding of *the New York City Electrical Code*.

**1305.14.1.9 Protection from heat and flame.** Tanks shall be located at least 7 feet (2134 mm), measured in the most direct manner, from any source of exposed flame unless protected as provided in Section 1305.11.1.2, exception 3, and at least 2 feet (610 mm) from any surface where the temperature exceeds 165°F (74°C).

**1305.14.2 Additional construction standards for cylindrical tanks exceeding 275 gallons (1041 L).** Cylindrical tanks, including oval, elongated oval, or round tanks, exceeding 275 gallons (1041 L) shall comply with the requirements of Section 1305.14.2.1 through 1305.14.2.3.

**Exception:** Such above-ground vertical tanks that are outside of buildings shall comply with Section 1305.14.1 and 1305.14.5.

**1305.14.2.1 Thickness.** The minimum thickness shall be as follows:

1. Tanks 36 inches (914 mm) in diameter or less shall have at least a ¼-inch (6.4 mm) shell and ¼-inch (6.4 mm) heads.
2. Tanks 37 inches (940 mm) to 72 inches (1829 mm) in diameter shall have at least a ¼-inch (6.4 mm) shell and 5/16-inch (7.9 mm) heads.
3. Tanks 73 (1854 mm) to 120 inches (3048 mm) in diameter shall have at least a 5/16-inch (7.9 mm) shell and 3/8-inch (9.5 mm) heads.
4. Tanks over 120 inches (3048 mm) in diameter shall be of at least 3/8-inch (9.5 mm) steel and shall be stiffened by angle rings or equivalent members so as to retain their cylindrical form.

**1305.14.2.2 Dished heads.** Dished heads for such tanks shall have a curvature the radius of which is not greater than the diameter of the tank. Dished heads shall be formed with an adequate cylindrical extension rim to provide a welding surface.

**1305.14.2.3 Flat heads.** If flat heads are used, they shall be braced in the same manner as described for the bracing of flat sides of rectangular tanks as provided for in Section 1305.14.3.

**1305.14.3 Additional construction standards for rectangular tanks exceeding 275 gallons (1041 L).** Rectangular tanks exceeding 275 gallons (1241 L) capacity shall comply with the requirements of Section 1305.14.3.1 through 1305.14.3.7.

**1305.14.3.1 Thickness.** Plates for rectangular tanks of more than 275 gallon (1040 L) capacity shall be at least  $\frac{5}{16}$  inches (7.9 mm) thick.

**1305.14.3.2 Corners.** Corners may be made up by bending the plates or by using angles.

**1305.14.3.3 Seams.** All tanks shall have full penetration  $\frac{5}{16}$  welds at all seams.

**1305.14.3.4 Bracing.** All flat surfaces of rectangular tanks shall be braced by structural members or rods.

**1305.14.3.5 Structural work.** All structural members shall be designed in accordance with the requirements of the *New York City Building Code*.

**1305.14.3.6 Connections.** Connections between bracing members and the sides of the tank shall be designed so that the connection will not fail before the member will fail.

**1305.14.4 Additional construction standards for tanks 275 gallons (1041 L) or less.** Storage tanks with a capacity of less than or equal to 275 gallons (1041 L) shall have a minimum thickness of shell and head plates of No. 10 manufacturer's standard Gage steel plate. Storage tanks of 60 gallon (227 L) capacity or less shall be similarly constructed but need not be thicker than No.14 manufacturer's standard Gage.

**Exceptions:**

- 1. Such vertical above-ground cylindrical tanks outside of buildings shall comply with Sections 1305.14.1 and 1305.14.5.**
- 2. Such underground tanks need comply only with Sections 1305.14.1.**
- 3. Storage containers of 6 gallons (23 L) or less used with burners or oil burning heaters need only be designed so as to withstand a hydrostatic pressure test of at least 5 psi (34 kPa) without permanent deformation, rupture, or leakage, and shall be approved. Such containers shall be installed with rigid metal fasteners for wall, floor, or stand-type installations, and shall be protected against mechanical damage. Portable storage containers of 6 gallons (23 L) or less may be filled by a pump mounted on a storage tank, provided that the pump is approved.**

**1305.14.5 Additional construction standards for vertical above-ground cylindrical tanks outside of buildings exceeding 6 gallons (23 L).** Vertical above-ground cylindrical storage tanks exceeding 6 gallons (23 L) that are located outside of buildings shall comply with the requirements of Sections 1305.14.5.1 through 1305.14.5.3.

**1305.14.5.1 Plates.** Such tanks shall be built of steel plates of the quality required for cylindrical tanks in accordance with Section 1305.14.2.

**1305.14.5.2 Thickness.** The minimum thickness of shell or bottom plates shall be ¼ inches (6.4 mm), and the minimum thickness of roof plates ⅛ inches (3.2 mm). The thickness of shell plates shall be determined in accordance with the following formula:

$$t = \frac{P \times R \times F}{T \times E}$$

where:

t = thickness of shell plate in inches.

P = head pressure at bottom of ring under consideration in psi.

R = radius of shell, in inches.

F = factor of safety (taken as 5).

T = tensile strength of plate, in psi as verified by mill test certificate.

E = efficiency of vertical joint in ring under consideration. E shall in no case be taken greater than 1.00.

**1305.14.5.3 Seams.** Roof plates shall have welded water-tight seams, and the roof shall be built to shed water. Bottom plates shall have welded seams. Shell plate seams shall be designed to develop the full strength of the plate.

## **SECTION MC 1306** **OIL GAUGING**

**1306.1 Level indication.** All tanks located inside buildings shall be equipped with a method of determining the oil level.

**1306.2 Test wells.** Test wells shall not be installed inside buildings. Unused tank openings shall be permanently sealed. For outside service, test wells shall be equipped with a tight metal cover designed to discourage tampering.

**1306.3 Inside tanks.** The gauging of inside tanks by means of measuring sticks shall not be permitted. An inside tank provided with fill and vent pipes shall be provided with a device to indicate either visually or audibly at the fill point when the oil in the tank has reached a predetermined safe level.

**1306.4 Gauging devices.** Gauging devices such as liquid level indicators or signals shall be designed and installed so that oil vapor will not be discharged into a building from the liquid fuel supply system.

**1306.5 Gauge glass.** A tank used in connection with any oil burner shall not be equipped with a glass gauge or any gauge which, when broken, will permit the escape of oil from the tank.

**1306.6 Storage above lowest floors.** Fuel-oil stored above the lowest floor shall also comply with the indicator requirements of Section 1305.13.3, Item 7.

### **SECTION MC 1307** **FUEL-OIL VALVES**

**1307.1 Building shutoff.** A shutoff valve shall be installed on the fuel-oil supply line at the entrance to the building. Inside or above-ground tanks are permitted to have valves installed at the tank. The valve shall be capable of stopping the flow of fuel oil to the building or to the appliance served where the valve is installed at a tank inside the building.

**1307.2 Appliance shutoff.** A shutoff valve shall be installed at the connection to each appliance where more than one fuel-oil-burning appliance is installed.

**1307.3 Pump relief valve.** A relief valve shall be installed on the pump discharge line where a valve is located downstream of the pump.

**1307.4 Fuel-oil heater relief valve.** A relief valve shall be installed on the discharge line of fuel-oil-heating appliances.

**1307.5 Relief valve operation.** Relief valves shall be set to discharge at not more than 1½ times the maximum working pressure of the system. The discharge from relief valves shall be returned to the storage tank or to the supply line. Shut-off valves are not permitted in the line of relief.

### **SECTION MC 1308** **TESTING**

**1308.1 Testing required.** Fuel-oil storage tanks, other than tanks complying with the alternate tank design and construction standards contained in Section 1305.14, shall be tested in accordance with NFPA 31.

**1308.2 Hydrostatic test.** All liquid-fuel piping, and all tanks complying with the alternate tank design and construction standards contained in Section 1305.14, shall be hydrostatically tested for tightness by the contractor who made the installation before the work is closed in and before the system is operated. The piping shall be tested at 1½ times the maximum working pressure applicable to that part of the piping system but at a pressure less than the test pressure required for the storage tank. The minimum pressure for testing tanks shall be 1½ times the maximum working pressure applicable to the tank but in no case less than 25 psig (172 kPag), except as provided for containers 6 gallons (23 L) or less in capacity as provided for in Section 1305.14.4 Exception 3. The hydrostatic pressure shall be maintained until all joints and connections have been visually inspected for leaks, but in no case for less than ½ hour. The tank shall not show any permanent

deformation as a result of the test. A record shall be kept of the pressure tests showing the name of the contractor and the pressures at which the piping and the tank were tested.

**1308.3. Weekly testing.** For fuel-oil tanks and fuel-oil-burning equipment located above ground, above the lowest floor inside of buildings, the operation of the float switch shall be tested at least once each week by the holder of the certificate of fitness as provided for in Section 1301.9 and Section 1305.13.3, item 8.

## **CHAPTER 14** **SOLAR SYSTEMS**

### **SECTION MC 1401** **GENERAL**

**1401.1 Scope.** This chapter shall govern the design, construction, installation, alteration and repair of systems, equipment and appliances intended to utilize solar energy for space heating or cooling, domestic hot water heating, swimming pool heating or process heating.

**1401.2 Potable water supply.** Potable water supplies to solar systems shall be protected against contamination in accordance with the *New York City Plumbing Code*.

**Exception:** Where all solar system piping is a part of the potable water distribution system, in accordance with the requirements of the *New York City Plumbing Code*, and all components of the piping system are listed for potable water use, cross connection protection measures shall not be required.

**1401.3 Heat exchangers.** Heat exchangers used in domestic water-heating systems shall be approved for the intended use. The system shall have adequate protection to ensure that the potability of the water supply and distribution system is properly safeguarded.

**1401.4 Solar energy equipment and appliances.** Solar energy equipment and appliances shall conform to the requirements of this chapter and shall be installed in accordance with the manufacturer's installation instructions.

**1401.5 Ducts.** Ducts utilized in solar heating and cooling systems shall be constructed and installed in accordance with Chapter 6 of this code.

### **SECTION MC 1402** **INSTALLATION**

**1402.1 Access.** Access shall be provided to solar energy equipment and appliances for maintenance. Solar systems and appurtenances shall not obstruct or interfere with firefighting operations or the operation of any doors, windows, fire escapes, or other means of egress or other building components requiring operation or access.

**1402.2 Protection of equipment.** Solar equipment exposed to vehicular traffic shall be installed not less than 6 feet (1829 mm) above the finished floor.

**Exception:** This section shall not apply where the equipment is protected from motor vehicle impact.

**1402.3 Controlling condensation.** Where attics or structural spaces are part of a passive solar system, ventilation of such spaces, as required by Section 406, is not required where other approved means of controlling condensation are provided.

**1402.4 Roof-mounted collectors.** Roof-mounted solar collectors that also serve as a roof covering shall conform to the requirements for roof coverings in accordance with the *New York City Building Code*.

**Exception:** The use of plastic solar collector covers shall be limited to those approved plastics meeting the requirements for plastic roof panels in the *New York City Building Code*.

**1402.4.1 Collectors mounted above the roof.** When mounted on or above the roof covering, the collector array and supporting construction shall be constructed of noncombustible materials or fire-retardant-treated wood conforming to the *New York City Building Code* to the extent required for the type of roof construction of the building to which the collectors are accessory.

**Exception:** The use of plastic solar collector covers shall be limited to those approved plastics meeting the requirements for plastic roof panels in the *New York City Building Code*.

**1402.5 Equipment.** The solar energy system shall be equipped in accordance with the requirements of Sections 1402.5.1 through 1402.5.4.

**1402.5.1 Pressure and temperature.** Solar energy system components containing pressurized fluids shall be protected against pressures and temperatures exceeding design limitations with a pressure and temperature relief valve. Each section of the system in which excessive pressures are capable of developing shall have a relief device located so that a section cannot be valved off or otherwise isolated from a relief device. Relief valves shall comply with the requirements of Section 1006.4 and discharge in accordance with Section 1006.6.

**1402.5.2 Vacuum.** The solar energy system components that are subjected to a vacuum while in operation or during shutdown shall be designed to withstand such vacuum or shall be protected with vacuum relief valves.

**1402.5.3 Protection from freezing.** System components shall be protected from damage by freezing of heat transfer liquids at the lowest ambient temperatures that will be encountered during the operation of the system.



**1402.5.4 Expansion tanks.** Liquid single-phase solar energy systems shall be equipped with expansion tanks sized in accordance with Section 1009.

**1402.6 Penetrations.** Roof and wall penetrations shall be flashed and sealed to prevent entry of water, rodents and insects.

**1402.7 Filtering.** Air transported to occupied spaces through rock or dust-producing materials by means other than natural convection shall be filtered at the outlet from the heat storage system.

### **SECTION MC 1403** **HEAT TRANSFER FLUIDS**

**1403.1 Flash point.** The flash point of the actual heat transfer fluid utilized in a solar system shall be not less than 50°F (28°C) above the design maximum nonoperating (no-flow) temperature of the fluid attained in the collector.

**1403.2 Flammable gases and liquids.** A flammable liquid or gas shall not be utilized as a heat transfer fluid.

### **SECTION MC 1404** **MATERIALS**

**1404.1 Collectors.** Factory-built collectors shall be listed and labeled, and bear a label showing the manufacturer's name and address, model number, collector dry weight, collector maximum allowable operating and nonoperating temperatures and pressures, minimum allowable temperatures and the types of heat transfer fluids that are compatible with the collector. The label shall clarify that these specifications apply only to the collector.

**1404.2 Thermal storage units.** Pressurized thermal storage units shall be listed and labeled, and bear a label showing the manufacturer's name and address, model number, serial number, storage unit maximum and minimum allowable operating temperatures, storage unit maximum and minimum allowable operating pressures and the types of heat transfer fluids compatible with the storage unit. The label shall clarify that these specifications apply only to the thermal storage unit.

## CHAPTER 15 REFERENCED STANDARDS

This chapter lists the standards that are referenced in various sections of this document. The standards are listed herein by the promulgating agency of the standard, the standard identification, the effective date and title and the section or sections of this document that reference the standard. The application of the referenced standards shall be as specified in Section 102.8.

### ACCA

Air Conditioning Contractors of America  
1712 New Hampshire Ave, NW  
Washington, DC 20009

<u>Standard Reference Number</u>	<u>Title</u>	<u>Referenced in code section number</u>
Manual D—95	Residential Duct Systems . . . . .	603.2

### ANSI

American National Standards Institute  
25 West 43<sup>rd</sup> Street, Fourth Floor  
New York, NY 10036

<u>Standard Reference Number</u>	<u>Title</u>	<u>Referenced in code section number</u>
Z21.8—1994	Installation of Domestic Gas Conversion Burners . . . . .	919.1
Z21.50—2003	Vented Gas Fireplaces . . . . .	901.6, 901.6.3
Z21.60—2003	Decorative Gas Appliances for Installation in Solid-Fuel Burning Fireplaces . . . . .	901.6.2
Z21.83—1998	Fuel Cell Power Plants . . . . .	924.1

### ARI

Air-Conditioning & Refrigeration Institute  
4100 North Fairfax Drive, Suite 200  
Arlington, VA 22203

<u>Standard Reference Number</u>	<u>Title</u>	<u>Referenced in code section number</u>
700—95	Specifications for Fluorocarbon and Other Refrigerants . . . . .	1102.2.2.3

### ASHRAE

American Society of Heating, Refrigerating  
and Air-Conditioning Engineers, Inc.  
1791 Tullie Circle, NE  
Atlanta, GA 30329-2305

<u>Standard Reference Number</u>	<u>Title</u>	<u>Referenced in code section number</u>
ASHRAE—2001	ASHRAE Fundamentals Handbook—2001 . . . . .	312.1, 603.2
15—2001	Safety Standard for Refrigeration Systems . . . . .	1101.6, 1101.11, 1104.2, 1105.3, 1105.7, 1105.8, 1105.10, 1108.1
34—2001	Designation and Safety Classification of Refrigerants . . . . .	202, 1102.2.1, 1103.1
ASHRAE—2000	HVAC Systems and Equipment Handbook—2000 . . . . .	312.1

### ASME

American Society of Mechanical Engineers  
Three Park Avenue  
New York, NY 10016-5990

<u>Standard Reference Number</u>	<u>Title</u>	<u>Referenced in code section number</u>
----------------------------------	--------------	--

B1.20.1—1983 (R1999)	Pipe Threads, General Purpose (Inch) . . . . .	1203.3.5, 1303.3.3
B16.3—1999	Malleable Iron Threaded Fittings, Classes 150 & 300 . . . . .	Table 1202.5
B16.5—1996	Pipe Flanges and Flanged Fittings NPS ½ through NPS 24—With B16.5a-1998 Addenda . . . . .	Table 1202.5
B16.9—1993	Factory -Made Wrought Steel Butt Welding Fittings . . . . .	Table 1202.5
B16.11—1996	Forged Fittings, Socket-Welding and Threaded . . . . .	Table 1202.5
B16.15—1985 (R1994)	Cast Bronze Threaded Fittings . . . . .	Table 1202.5
B16.18—1984 (R1994)	Cast Copper Alloy Solder Joint Pressure Fittings . . . . .	513.13.1, Table 1202.5
B16.22—1995	Wrought Copper and Copper Alloy Solder Joint Pressure Fittings—with B16.22a-1998 Addenda . . . . .	513.13.1, Table 1202.5
B16.23—1992	Cast Copper Alloy Solder Joint Drainage Fittings DWV . . . . .	Table 1202.5
B16.24—1991 (R1998)	Cast Copper Alloy Pipe Flanges and Flanged Fittings: Class 150, 300, 400, 600, 900, 1500 and 2500 . . . . .	Table 1202.5
B16.26—1988	Cast Copper Alloy Fittings for Flared Copper Tubes . . . . .	Table 1202.5
B16.28—1994	Wrought Steel Butt Welding Short Radius Elbows and Returns . . . . .	Table 1202.5
B16.29—1994	Wrought Copper and Wrought Copper Alloy Solder Joint Drainage Fittings-DWV . . . . .	Table 1202.5
B31.1—2004	Power Piping Code . . . . .	1210.2.2, 1210.2.3
BPVC—2004	Boiler & Pressure Vessel Code (Sections I, II, IV, V, VI, VIII & IX) . . . . .	1003.3, 1004.1, 1011.1, 1210.2.2, 1305.11
CSD-1—1998	Controls and Safety Devices for Automatically Fired Boilers . . . . .	1004.1, 1107.2

## ASNT

American Society for Nondestructive Testing  
3200 Riverside Drive  
Columbus, OH 43221

Standard Reference Number	Title	Referenced in code section number
SNT—TC—1A—1980	Recommended Practice . . . . .	1210.2.2

## ASTM

ASTM International  
100 Barr Harbor Drive  
West Conshohocken, PA 19428-2959

Standard Reference Number	Title	Referenced in code section number
A 53/A 53M—01	Specification for Pipe, Steel, Black and Hot-Dipped, Zinc-Coated Welded and Seamless . . . . .	Table 1202.4, Table 1302.3, 1305.9
A 106—99e1	Specification for Seamless Carbon Steel Pipe for High-Temperature Service . . . . .	Table 1202.4, Table 1302.3, 1305.9
A 126—01	Specification for Gray Iron Castings for Valves, Flanges, and Pipe Fittings . . . . .	Table 1202.5
A 254—97	Specification for Copper Brazed Steel Tubing . . . . .	Table 1202.4
A 420/A 420M—01	Specification for Piping Fittings of Wrought Carbon Steel and Alloy Steel for Low-Temperature Service . . . . .	Table 1202.5
B 32—00	Specification for Solder Metal . . . . .	1203.3.3
B 42—98	Specification for Seamless Copper Pipe, Standard Sizes . . . . .	513.13.1, 1107.4.2, Table 1202.4, Table 1302.3
B 43—98	Specification for Seamless Red Brass Pipe, Standard Sizes . . . . .	513.13.1, 1107.4.2, Table 1202.4, Table 1302.3
B 68—99	Specification for Seamless Copper Tube, Bright Annealed . . . . .	513.13.1
B 75—99	Specification for Seamless Copper Tube . . . . .	Table 1202.4, Table 1302.3
B 88—99e1	Specification for Seamless Copper Water Tube . . . . .	513.13.1, 1107.4.3, Table 1202.4, Table 1302.3
B 135—00	Specification for Seamless Brass Tube . . . . .	Table 1202.4
B 251—97	Specification for General Requirements for Wrought Seamless Copper and Copper-Alloy Tube . . . . .	513.13.1, Table 1202.4
B 280—99e1	Specification for Seamless Copper Tube for Air Conditioning and Refrigeration Field Service . . . . .	513.13.1, 1107.4.3, Table 1302.3
B 302—00	Specification for Threadless Copper Pipe, Standard Sizes . . . . .	Table 1202.4, Table 1302.3
B 813—00e01	Specification for Liquid and Paste Fluxes for Soldering of Copper and Copper Alloy Tube . . . . .	1203.3.3
C 315—00	Specification for Clay Flue Linings . . . . .	801.16.1, Table 803.10.4
C 411—97	Test Method for Hot-Surface Performance of High-Temperature Thermal Insulation . . . . .	604.3
D 56—01	Test Method for Flash Point by Tag Closed Tester . . . . .	202
D 93—00	Test Method for Flash Point of Pensky-Martens Closed Cup Tester . . . . .	202
D 1527—99	Specification for Acrylonitrile-Butadiene-Styrene (ABS) Plastic Pipe, Schedules 40 and 80 . . . . .	Table 1202.4
D 1693—01	Test Method for Environmental Stress-Cracking of Ethylene Plastics . . . . .	Table 1202.4
D 1785—99	Specification for Poly (Vinyl Chloride)(PVC) Plastic Pipe, Schedules 40, 80 and 120 . . . . .	Table 1202.4
D 2235—01	Specifications for Solvent Cement for Acrylonitrile-Butadiene-Styrene (ABS) Plastic Pipe and Fittings . . . . .	1203.3.4
D 2241—01	Specification for Poly (Vinyl Chloride)(PVC) Pressure-Rated Pipe (SDR-Series) . . . . .	Table 1202.4
D 2282—99	Specification for Acrylonitrile-Butadiene-Styrene (ABS) Plastic Pipe (SDR-PR) . . . . .	Table 1202.4
D 2412—96a	Test Method for Determination of External Loading Characteristics of Plastic Pipe by Parallel-Plate Loading . . . . .	603.8.3

D 2447—99	Specification for Polyethylene (PE) Plastic Pipe, Schedules 40 and 80, Based on Outside Diameter . . . . .	Table 1202.4
D 2466—01	Specification for Poly (Vinyl Chloride)(PVC) Plastic Pipe Fittings, Schedule 40 . . . . .	Table 1202.5
D 2467—01	Specification for Poly (Vinyl Chloride)(PVC) Plastic Pipe Fittings, Schedule 80 . . . . .	Table 1202.5
D 2468—96a	Specification for Acrylonitrile-Butadiene-Styrene (ABS) Plastic Pipe Fittings, Schedule 40 . . . . .	Table 1202.5
D 2513—00	Specification for Thermoplastic Gas Pressure Pipe, Tubing, and Fittings . . . . .	Table 1202.4, 1203.15.3
D 2564—96a	Specification for Solvent Cements for Poly (Vinyl Chloride) (PVC) Plastic Piping Systems . . . . .	1203.3.4
D 2683—98	Specification for Socket-Type Polyethylene Fittings for Outside Diameter-Controlled Polyethylene Pipe and Tubing . . . . .	Table 1202.4, 1203.15.1
D 2837—98a	Test Method for Obtaining Hydrostatic Design Basis for Thermoplastic Pipe Materials . . . . .	Table 1202.4
D 2846/D 2846M—99	Specification for Chlorinated Poly (Vinyl Chloride) (CPVC) Plastic Hot and Cold Water Distribution Systems . . . . .	Table 1202.4, 1203.3.4
D 2996—00	Specification for Filament-Wound Fiberglass (Glass Fiber Reinforced Thermosetting Resin) Pipe . . . . .	Table 1302.3
D 3035—01	Specification for Polyethylene (PE) Plastic Pipe (DR-PR) Based on Controlled Outside Diameter . . . . .	Table 1202.4
D 3278—96el	Test Methods for Flash Point of Liquids by Small Scale Closed-Cup Apparatus . . . . .	202
D 3350—01	Specification for Polyethylene Plastics Pipe and Fittings Materials . . . . .	Table 1202.4
E 84—01	Test Method for Surface Burning Characteristics of Building Materials . . . . .	202, 510.8, 602.2.1, 602.2.1.5, 604.3, 1204.1
E 119—00e	Test Method for Fire Tests of Building Construction and Materials . . . . .	607.5.2, 607.5.5.1, 607.6.1, 607.6.2
E 136—99e01	Test Method for Behavior of Materials in a Vertical Tube Furnace at 750°C . . . . .	202
E 814—00	Test Method for Fire Tests of Through-Penetration Fire Stops . . . . .	506.3.10
F 438—01	Specification for Socket Type Chlorinated Poly (Vinyl Chloride) (CPVC) Plastic Pipe Fittings, Schedule 40 . . . . .	Table 1202.5
F 439—01	Specification for Socket Type Chlorinated Poly (Vinyl Chloride) (CPVC) Plastic Pipe Fittings, Schedule 80 . . . . .	Table 1202.5
F 441/F 441M—99	Specification for Chlorinated Poly (Vinyl Chloride) (CPVC) Plastic Pipe, Schedules 40 and 80 . . . . .	Table 1202.4
F 442/F 442M—99	Specification for Chlorinated Poly (Vinyl Chloride) (CPVC) Plastic Pipe (SDR-PR) . . . . .	Table 1202.4
F 493—97	Specification for Solvent Cements for Chlorinated Poly (Vinyl Chloride) (CPVC) Plastic Pipe and Fittings . . . . .	1203.3.4
F 876—01	Specification for Crosslinked Polyethylene (PEX) Tubing . . . . .	Table 1202.4
F 877—01	Specification for Crosslinked Polyethylene (PEX) Plastic Hot and Cold-Water Distribution Systems . . . . .	Table 1202.4, Table 1202.5
F 1055—98	Specification for Electrofusion Type Polyethylene Fittings for Outside Diameter Controlled Polyethylene Pipe and Tubing . . . . .	Table 1202.4, 1203.15.2
F 1281—01	Specification for Crosslinked Polyethylene/Aluminum/Crosslinked Polyethylene PEX-AL-PEX) Pressure Pipe . . . . .	Table 1202.4
F 1974—00e	Standard Specification for Metal Insert Fittings for Polyethylene/Aluminum/Polyethylene and Crosslinked Polyethylene/Aluminum/Crosslinked Polyethylene Composite Pressure Pipe . . . . .	Table 1202.5

## **AWS**

American Welding Society  
550 N.W. LeJeune Road  
Miami, FL 33126

Standard Reference Number	Title	Referenced in code section number
A5.8 - 92	Specifications for Filler Metals for Brazing and Braze Welding . . . . .	1203.3.1, 1303.3.1

## **CSA**

Canadian Standards Association  
178 Rexdale Blvd.  
Rexdale (Toronto), Ontario, Canada M9W 1R3

Standard Reference Number	Title	Referenced in code section number
CAN/CSA B137.10M—99	Crosslinked Polyethylene/Aluminum/Polyethylene Composite Pressure Pipe Systems . . . . .	Table 1202.4

## **DOL**

Department of Labor  
Occupational Safety and Health Administration  
c/o Superintendent of Documents  
US Government Printing Office  
Washington, DC 20402-9325

Standard Reference Number	Title	Referenced in code section number
---------------------------	-------	-----------------------------------

29 CFR Part 1910.1000 (1974)	Air Contaminants . . . . .	502.6
---------------------------------	----------------------------	-------

## **IIAR**

International Institute of Ammonia Refrigeration  
Suite 700  
1101 Connecticut Ave., NW  
Washington, DC 20036

<u>Standard Reference Number</u>	<u>Title</u>	<u>Referenced in code section number</u>
2—99	Equipment, Design, and Installation of Ammonia Mechanical Refrigerating Systems . . . . .	1101.6

## **MSS**

Manufacturers Standardization Society of the Valve & Fittings Industry, Inc.  
127 Park Street, N.E.  
Vienna, VA 22180

<u>Standard Reference Number</u>	<u>Title</u>	<u>Referenced in code section number</u>
SP-69—1996	Pipe Hangers and Supports—Selection and Application . . . . .	305.4

## **NAIMA**

North American Insulation Manufacturers Association  
Suite 310  
44 Canal Center Plaza  
Alexandria, VA 22314

<u>Standard Reference Number</u>	<u>Title</u>	<u>Referenced in code section number</u>
AH116—02	Fibrous Glass Duct Construction Standards . . . . .	603.5, 603.9

## **NFPA**

National Fire Protection Association  
Batterymarch Park  
Quincy, MA 02269

<u>Standard Reference Number</u>	<u>Title</u>	<u>Referenced in code section number</u>
30—96	Flammable Combustible Code . . . . .	605.4, 1305.8
31—01	Installation of Oil-Burning Equipment . . . . .	801.2.1, 801.18.1, 801.18.2, 901.2, 918.1, 920.2, 922.1, 1301.2, 1305.11, 1308.1
37—98	Stationary Combustion Engines and Gas Turbines . . . . .	811.1, 811.2, 915.1, 915.2
45—04	Fire Protection for Laboratories Using Chemicals . . . . .	Table 403.3, 407.1, 502.20
54—06	National Fuel Gas Code . . . . .	901.2, 910.7, 918.2
58—01	Liquefied Petroleum Gas Code . . . . .	502.9.10
69—97	Explosion Prevention Systems . . . . .	510.8.3
70—02	National Electric Code . . . . .	1104.2.2
82—99	Incinerators and Waste and Linen Handling Systems and Equipment . . . . .	601.1, 907.1
88B—97	Repair Garages . . . . .	304.5
91—99	Exhaust Systems for Air Conveying of Vapors, Gases, Mists, and Noncombustible Particulate Solids . . . . .	502.9.5.1, 502.17
96—84	Installation of Equipment for the Removal of Smoke and Grease-laden Vapors from Commercial Cooking Equipment . . . . .	506.3.7.1
211—00	Chimneys, Fireplaces, Vents, and Solid Fuel-Burning Appliances . . . . .	802.1, Table 803.10.6, 806.1, 811.1, 901.2
262—99	Standard Method of Test for Flame Travel and Smoke of Wires and Cables for Use in Air-Handling Spaces . . . . .	602.2.1.1
704—96	Identification of the Hazards of Materials for Emergency Response . . . . .	502.8.4, 510.1, Table 1103.1, 1105.10
853—00	Installation of Stationary Fuel Power Plants . . . . .	924.1
8501—97	Single Burner Boiler Operation . . . . .	1004.1
8502—99	Prevention of Furnace Explosions/Implosions in Multiple Burner Boiler-Furnaces . . . . .	1004.1
8504—96	Atmospheric Fluidized-Bed Boiler Operation . . . . .	1004.1

## **NYC/NYS**

New York City Codes / New York State Codes / NYC Agencies

<u>Standard</u>	<u>Referenced</u>
-----------------	-------------------

<u>Reference Number</u>	<u>Title</u>	<u>in code section number</u>
	Energy Conservation Construction Code of New York State...	202, 301.2, 303.3, 312.1, 514.1, 603.9, 604.1, 905.4, 1204.1, 1204.2
	New York City Air Pollution Code.....	801.5, 811.2.2, 904.1, 905.3, 907.2
	New York City Building Code based on 2003 IBC .....	106.4, 106.5, 107.1, 201.3, 301.12, 301.12, 301.14, 301.15, 302.1, 302.2, 304.7, 304.10, 308.8, 308.10, 401.4, 401.6, 402.1, 405.2.1, 406.1, 502.10, 502.10.1, 502.16.2, 504.2, 506.3.3, 506.3.10, 506.3.12.2, 506.4.1, 509.1, 510.6, 510.6.1, 510.6.2, 510.7, 511.1.5, 512.2, 513.1, 513.2, 513.3, 513.4.3, 513.5, 513.5.2, 513.5.2.1, 513.6.2, 513.10.5, 513.12, 513.12.2, 513.12.3, 513.20, 513.20.2, 601.2, 602.2.1.5.1, 602.2.1.5.2, 602.3, 603.1, 603.6.1.1, 603.10, 603.15, 607.1.1, 607.3.2.1, 607.5.1, 607.5.2, 607.5.3, 607.5.4, 607.5.4.1, 607.5.5, 607.5.5.1, 607.6, 701.4.1, 701.4.2, 801.3, 801.16.1, 801.18.4, 901.5, 902.1, 908.3, 908.3.2, 908.4, 910.3, 925.1, 1004.6, 1104.2.2, 1105.1, 1206.4, 1206.10, 1402.4, 1402.4.1
	New York City Electrical Code based on 2002 NEC .....	201.3, 301.7, 306.3.1, 306.4.1, 513.11, 513.12.1, 602.2.1.1, 606.3, 1305.11.1.1
	New York City Fire Code.....	201.3, 310.1, 311.1, 502.5, 502.7.2, 502.8.1, 502.9.5, 502.9.5.2, 502.9.5.3, 502.9.8.2, 502.9.8.3, 502.9.8.5, 502.9.8.6, 502.7, 502.8, 502.9, 502.9.10, 502.10, 502.10.3, , 509.1, 510.2.1, 510.2.2, 510.4, 513.15, 513.16, 513.17, 513.18, 513.19, , 513.20.3, 515.1, 606.2.1, 908.7, 1101.9, 1105.7.2, 1109.2, 1301.1, 513.17, 513.18, 513.19, , 513.20.3, 515.1, 606.2.1, 908.7, 1101.9, 1105.7.2, 1109.2, 1301.1
	New York City Fuel Gas Code based on 2003 IFGC.....	101.2, 201.3, 301.3, 701.1, 801.1, 801.2.2, 807.1, 901.1, 906.1, 917.6, 1101.5
	New York City Fuel Oil tank Construction Standards.....	1301.2, 1305.11
	New York City Plumbing Code based on 2003 IPC.....	201.3, 301.8, 512.2, 908.5, 1002.1, 1002.2, 1002.3, 1005.2, 1006.6, 1008.2, 1009.3, 1101.4, 1201.1, 1206.2, 1206.3, 1401.2
	New York State Department of Environmental Conservation Petroleum Bulk Storage Code (6 NYCRR-612, 613, 614).....	1301.2
	New York State Department of Labor Industrial Code Rule Part 4 .....	1003.3, 1004.1
	New York State Department of Labor Industrial Code Rule Part 4-6.2.....	1003.3
	New York State Department of Labor Industrial Code Rule Part 14.....	1003.3, 1004.1
	United States Environmental Protective Agency Technical Requirements and Corrective Action Requirements for Owners and Operators of Underground Storage Tanks 40 CFR Part 280.....	1301.6

## **SMACNA**

Sheet Metal & Air Conditioning Contractors National Assoc., Inc.  
4021 Fafayette Center Road  
Chantilly, VA 22021

<u>Standard Reference Number</u>	<u>Title</u>	<u>Referred in code section number</u>
SMACNA—95	HVAC Duct Construction Standards—Metal and Flexible .....	603.4, 603.9
SMACNA—92	Fibrous Glass Duct Construction Standards .....	603.5, 603.9

## **UL**

Underwriters Laboratories, Inc.  
333 Pfingsten Road  
Northbrook, IL 60062-2096

<u>Standard Reference Number</u>	<u>Title</u>	<u>Referred in code section number</u>
----------------------------------	--------------	--

<u>17—94</u>	<u>Vent or Chimney Connector Dampers for Oil-Fired Appliances—with Revisions through September 1998.....</u>	<u>803.6</u>
<u>58—96</u>	<u>Steel Underground Tanks for Flammable and Combustible Liquids.....</u>	<u>1305.11</u>
<u>80—04</u>	<u>Steel Tanks for Oil-Burner Fuel.....</u>	<u>1305.11, Table 1305.7(2)</u>
<u>103—98</u>	<u>Factory-Built Chimneys, Residential Type and Building Heating Appliance—with Revisions through March 1999.....</u>	<u>805.2</u>
<u>127—96</u>	<u>Factory-Built Fireplaces—with Revisions through November 1999.....</u>	<u>805.3, 903.1</u>
<u>142—02</u>	<u>Steel Aboveground Tanks for Flammable and Combustible Liquids.....</u>	<u>1305.8, 1305.11</u>
<u>174—98</u>	<u>Household Electric Storage Tank Water Heaters—with revisions through October 1999.....</u>	<u>1002.1</u>
<u>181—96</u>	<u>Factory-made Air Ducts and Air Connectors—with Revisions through December 1998.....</u>	<u>512.2, 603.5,</u> <u>603.6.1.1, 603.6.2, 603.11.1, 604.1.3</u>
<u>197—93</u>	<u>Commercial Electric Cooking Appliances—With Revisions Through January 2000.....</u>	<u>507.1</u>
<u>207—93</u>	<u>Refrigerant-Containing Components and Accessories, Nonelectrical—with Revisions Through October 1997.....</u>	<u>1101.2</u>
<u>343—97</u>	<u>Pumps for Oil-Burning Appliances-with revisions through December 22, 1999.....</u>	<u>1302.7</u>
<u>391—95</u>	<u>Solid-Fuel and Combination-Fuel Central and Supplementary Furnaces—with Revisions Through May 1999.....</u>	<u>918.1</u>
<u>412—93</u>	<u>Refrigeration Unit Coolers—with Revisions through November 1998.....</u>	<u>1101.2</u>
<u>471—95</u>	<u>Commercial Refrigerators and Freezers—with Revisions through April 1998.....</u>	<u>1101.2</u>
<u>536—97</u>	<u>Flexible metallic Hose - with revisions through October 2000.....</u>	<u>1302.8</u>
<u>555—99</u>	<u>Fire Dampers - with Revisions through October, 2000.....</u>	<u>607.3</u>
<u>555C—96</u>	<u>Ceiling Dampers.....</u>	<u>607.3, 607.6.2</u>
<u>555S—99</u>	<u>Smoke Dampers—with Revisions through December 1999.....</u>	<u>607.2.1, 607.3, 607.3.1.1</u>
<u>586—96</u>	<u>High-Efficiency, Particulate, Air Filter Units - with revisions through april 21, 2000.....</u>	<u>605.2</u>
<u>641—95</u>	<u>Type L Low-Temperature Venting Systems—with Revisions through April 1999.....</u>	<u>802.1</u>
<u>710—95</u>	<u>Exhaust Hoods for Commercial Cooking Equipment-with Revisions through April 1999.....</u>	<u>507.1</u>
<u>726—98</u>	<u>Oil-Fired Boiler Assemblies—with Revisions through January 1999.....</u>	<u>916.1, 1004.1</u>
<u>727—94</u>	<u>Oil-Fired Central Furnaces—with Revisions through January 1999.....</u>	<u>918.1</u>
<u>729—98</u>	<u>Oil-Fired Floor Furnaces—with Revisions through January 1999.....</u>	<u>910.1</u>
<u>730—98</u>	<u>Oil-Fired Wall Furnaces—with Revisions through January 1999.....</u>	<u>909.1</u>
<u>731—95</u>	<u>Oil-Fired Unit Heaters—with Revisions through January 1999.....</u>	<u>920.1</u>
<u>732—95</u>	<u>Oil-Fired Storage Tank Water Heaters-With revisions through January 1999.....</u>	<u>1002.1</u>
<u>737—96</u>	<u>Fireplace Stoves—with Revisions through January 2000.....</u>	<u>805.2, 905.1</u>
<u>762—99</u>	<u>Outline of Investigation for Power Ventilators for Restaurant Exhaust Appliances.....</u>	<u>506.5.1</u>
<u>791—93</u>	<u>Residential Incinerators—with Revisions through May 1998.....</u>	<u>907.1</u>
<u>834—98</u>	<u>Heating, Water Supply and Power Boilers Electric—with Revisions Through November 1998.....</u>	<u>1004.1</u>
<u>864—03</u>	<u>Control Units and Accessories for Fire Alarm Systems.....</u>	<u>513.12</u>
<u>867—00</u>	<u>Electrostatic Air Cleaners.....</u>	<u>605.2</u>
<u>900—94</u>	<u>Air Filter Units - with revisions through October 1999.....</u>	<u>605.2, 607.2.3</u>
<u>959—01</u>	<u>Medium Heat Appliance Factory-Built Chimneys.....</u>	<u>805.5</u>
<u>1046—00</u>	<u>Grease Filters for Exhaust Ducts.....</u>	<u>507.11</u>
<u>1240—94</u>	<u>Electric Commercial Clothes Drying Equipment—with Revisions through October 1999.....</u>	<u>913.1</u>
<u>1261—96</u>	<u>Electric Water Heaters for Pools and Tubs - with revisions through November 25, 1998.....</u>	<u>916.1</u>
<u>1316—94</u>	<u>Glass-Fiber Reinforced Plastic Underground Storage Tanks for Petroleum Products, Alcohols, and Alcohol-Gasoline Mixtures.....</u>	<u>1305.11</u>
<u>1453—95</u>	<u>Electronic Booster and Commercial Storage Tank Water Heaters - with Revisions Through September 1998.....</u>	<u>1002.1</u>
<u>1482—98</u>	<u>Solid-Fuel Type Room Heaters—with Revisions through January 2000.....</u>	<u>905.1</u>
<u>1777—98</u>	<u>Chimney Liners—with Revisions through July 1998.....</u>	<u>801.18.4, 806.16.1</u>
<u>1820—97</u>	<u>Fire Test of Pneumatic Tubing for Flame and Smoke Characteristics - with Revisions through March 1999.....</u>	<u>602.2.1.3</u>
<u>1887—96</u>	<u>Fire Tests of Plastic Sprinkler Pipe for Visible Flame and Smoke Characteristics—with Revisions through June 1999.....</u>	<u>602.2.1.2</u>
<u>1995—98</u>	<u>Heating and Cooling Equipment - with Revisions through August 1999.....</u>	<u>911.1, 918.1, 918.3, 1101.2</u>
<u>2043—96</u>	<u>Fire Test for Heat and Visible Smoke Release for Discrete Products and their Accessories Installed in Air-Handling Spaces-With Revisions through February 1998.....</u>	<u>602.2.1.4</u>
<u>2158—97</u>	<u>Outline of Investigation Electric Clothes Dryer—with Revisions through February 1999.....</u>	<u>913.1</u>
<u>2162—94</u>	<u>Outline of Investigation for Commercial Wood-Fired Baking Ovens—Refractory Type.....</u>	<u>917.1</u>

## APPENDIX A COMBUSTION AIR OPENINGS AND CHIMNEY CONNECTOR PASS-THROUGHS

Figures A-1 through A-4 are illustrations of appliances located in confined spaces.

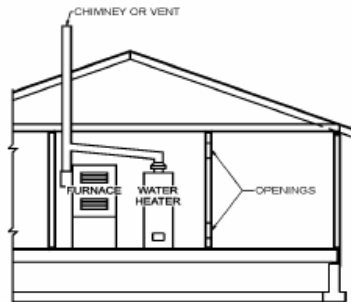


FIGURE A-1  
ALL AIR FROM INSIDE THE BUILDING

NOTE: Each opening shall have a free area of not less than 1 square inch per 1,000 Btu per hour of the total input rating of all appliances in the enclosure and not less than 100 square inches.

For SI: 1 square inch = 645 mm<sup>2</sup>, 1 British thermal unit per hour = 0.2931 W.

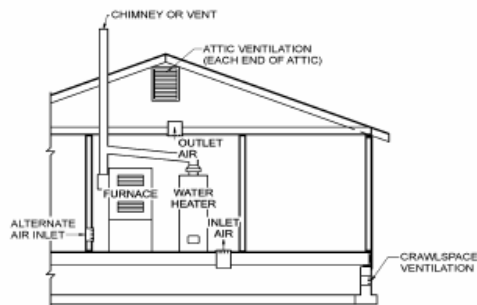


FIGURE A-2  
ALL AIR FROM OUTDOORS—INLET AIR FROM VENTILATED CRAWL SPACE AND OUTLET AIR TO VENTILATED ATTIC

NOTE: The inlet and outlet air openings shall each have a free area of not less than 1 square inch per 4,000 Btu per hour of the total input rating of all appliances in the enclosure.

For SI: 1 square inch = 645 mm<sup>2</sup>, 1 British thermal unit per hour = 0.2931 W.



APPENDIX A

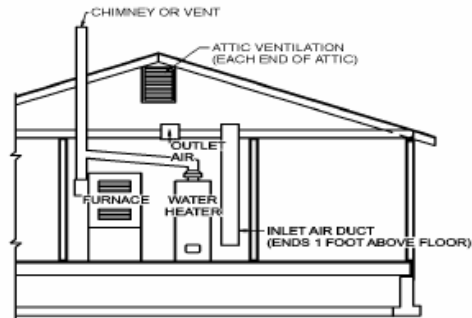


FIGURE A-3  
ALL AIR FROM OUTDOORS THROUGH VENTILATED ATTIC

NOTE: The inlet and outlet air openings shall each have a free area of not less than 1 square inch per 4,000 Btu per hour of the total input rating of all appliances in the enclosure.

For SI: 1 foot = 304.8 mm, 1 square inch = 645 mm<sup>2</sup>, 1 British thermal unit per hour = 0.2931 W.

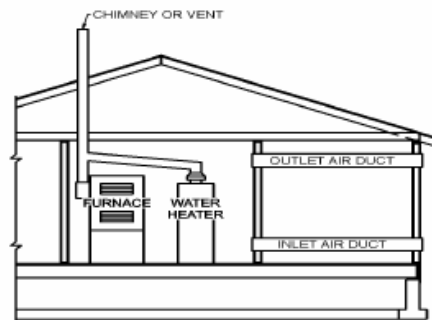


FIGURE A-4  
ALL AIR FROM OUTDOORS THROUGH HORIZONTAL DUCTS OR DIRECT OPENINGS

NOTE: Each air duct opening shall have a free area of not less than 1 square inch per 2,000 Btu per hour of the total input rating of all appliances in the enclosure. If the appliance room is located against an outside wall and the air openings communicate directly with the outdoors, each opening shall have a free area of not less than 1 square inch per 4,000 Btu per hour or the total input rating of all appliances in the enclosure.

For SI: 1 foot = 304.8 mm, 1 square inch = 645 mm<sup>2</sup>, 1 British thermal unit per hour = 0.2931 W.

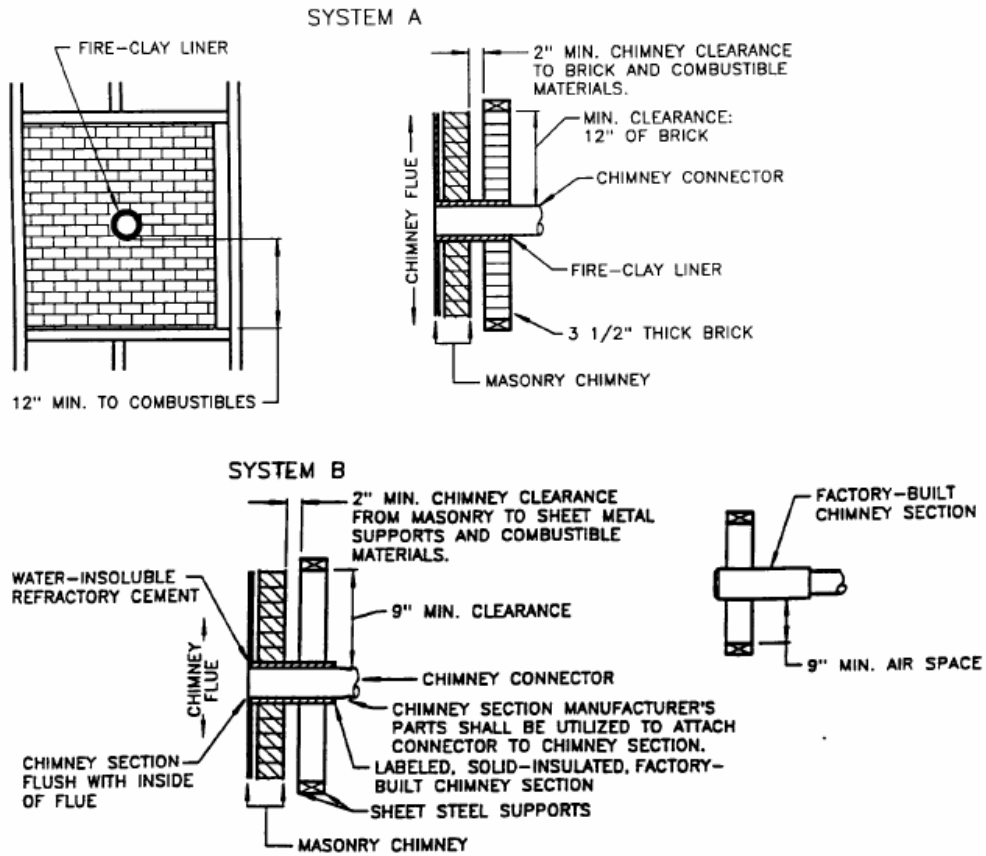
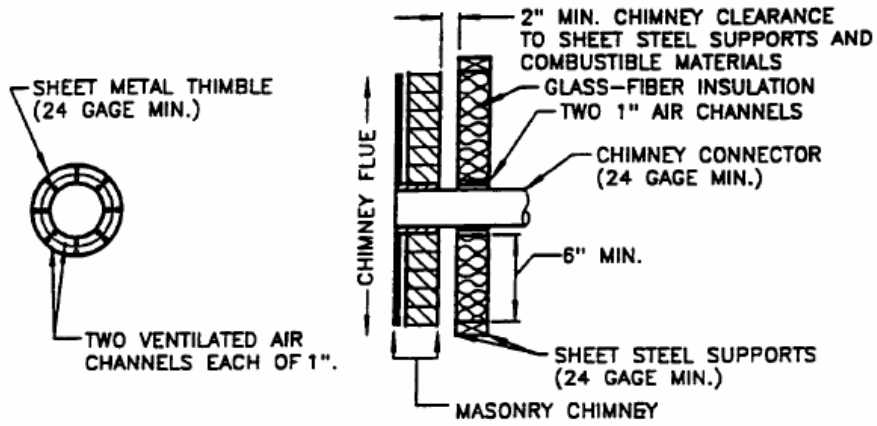


FIGURE A-5  
CHIMNEY CONNECTOR SYSTEMS

For SI: 1 inch = 25.4 mm.

SYSTEM C



SYSTEM D

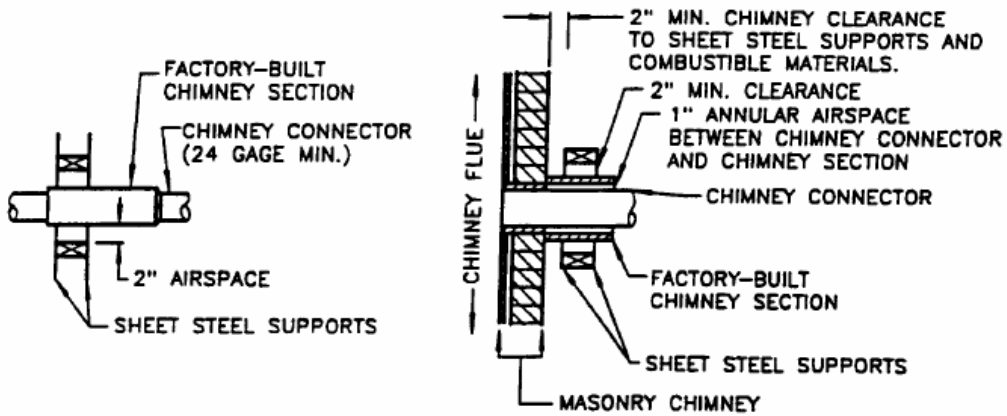


FIGURE A-5—continued  
CHIMNEY CONNECTOR SYSTEMS

For SI: 1 inch = 25.4 mm.

**APPENDIX B**  
**RESERVED**

**{NOTE: REVISE EQUATION 4-1 BELOW BY ADDING MATHEMATICAL SIGNS TO READ AS FOLLOWS:**

$$Y = \frac{X}{(1 + X - Z)}$$

$$Y = \frac{X}{1 + X - Z}$$

(Equation 4-1)

Where

$Y = V_{oa}/V_s$  = Corrected fraction of outdoor air in system supply.

$X = V_{oa}/V_s$  = Uncorrected fraction of outdoor air in system supply

$Z = V_{oc}/V_s$  = Fraction of outdoor air in critical space.  
The critical space is that space with the greatest required fraction of outdoor air in the supply to this space.

$V_{oa}$  = Corrected total outdoor airflow rate.

$V_s$  = Total supply flow rate, i.e., the sum of all supply for all branches of the system.

$V_{oa}$  = Sum of outdoor airflow rates for all branches on system.

$V_{oc}$  = Outdoor airflow rate required in critical spaces.

$V_s$  = Supply flow rate in critical space.

$$Q = 100 \times A_{LD} \quad \text{(Equation 5-1)}$$

where:

$Q$  = Flow rate exhausted through the hood, cubic feet per minute.

$A_{LD}$  = Area of the loading door, square feet.

$$F = F_{dc} + K(WA\Delta P)/2(W-d) \quad \text{(Equation 5-2)}$$

where:

$A$  = Door area, square feet ( $m^2$ ).

$d$  = Distance from door handle to latch edge of door, feet ( $m$ ).

$F$  = Total door opening force, pounds (N).

$F_{dc}$  = Force required to overcome closing device, pounds (N).

$K$  = Coefficient 5.2 (1.0).

$W$  = Door width, feet ( $m$ ).

$\Delta P$  = Design pressure difference, inches (Pa) water gage.

$$v = 217.2 [h (T_f - T_o)/(T_f + 460)]^{1/2} \quad \text{(Equation 5-3)}$$

$$\text{For SI: } v = 119.9 [h (T_f - T_o)/T_f]^{1/2}$$

where:

$H$  = Height of opening, feet ( $m$ ).

$T_f$  = Temperature of smoke, °F (K).

$T_o$  = Temperature of ambient air, °F (K).

$v$  = Air velocity, feet per minute ( $m/minute$ ).

$$z_l = 0.533Q_c^{2/5} \quad \text{(Equation 5-4)}$$

For SI:  $z_l = 0.166Q_c^{2/5}$

where:

$M_p$  = Plume mass flow rate, pounds per second (kg/s).

$Q$  = Total heat output.

$Q_c$  = Convective heat output, British thermal units per second (kW).

(The value of  $Q_c$  shall not be taken as less than  $0.70Q$ ).

$z$  = Height from top of fuel surface to bottom of smoke layer, feet (m).

$z_l$  = Limiting flame height, feet (m). The  $z_l$  value must be greater than the fuel equivalent diameter (see Section 513.9).

for  $z > z_l$

$$m_p = 0.022Q_c^{1/3}z^{5/3} + 0.0042Q_c$$

For SI:  $m_p = 0.071Q_c^{1/3}z^{5/3} + 0.0018Q_c$

for  $z = z_l$

$$M_p = 0.011 Q_c$$

For SI:  $m_p = 0.035Q_c$

for  $z < z_l$

$$M_p = 0.0208Q_c^{3/5}z$$

For SI:  $m_p = 0.032Q_c^{3/5}z$

To convert  $m_p$  from pounds per second of mass flow to a volumetric rate, the following formula shall be used:

$$V = 60m_p/\rho \quad \text{(Equation 5-5)}$$

where:

$V$  = Volumetric flow rate, cubic feet per minute ( $m^3/s$ ).

$\rho$  = Density of air at the temperature of the smoke layer, pounds per cubic feet ( $T$ : in  $^{\circ}F$ )[ $kg/m^3$  ( $T$ : in  $^{\circ}C$ )].

$$M_p = 0.124(QW^2)^{1/3}(z_b + 0.25H) \quad \text{(Equation 5-6)}$$

For SI:  $m_p = 0.36(QW^2)^{1/3}(z_b + 0.25H)$

where:

$H$  = Height above fire to underside of balcony, feet (m).

$M_p$  = Plume mass flow rate, pounds per second (kg/s).

$Q$  = Total heat output.

$W$  = Plume width at point of spill, feet (m).

$$m_p = 0.077(A_w H_w^{1/2})^{1/3} (z_w + a)^{5/3} + 0.18 A_w H_w^{1/2} \quad \text{(Equation 5-7)}$$

For SI:  $m_p = 0.68(A_w H_w^{1/2})^{1/3} (z_w + a)^{5/3} + 1.5 A_w H_w^{1/2}$

where:

$A_w$  = Area of the opening, square feet (m<sup>2</sup>).

$H_w$  = Height of the opening, feet (m).

$M_p$  = Plume mass flow rate, pounds per second (kg/s).

$z_w$  = Height from the top of the window or opening to the bottom of the smoke layer, feet (m).

$$a = 2.4 A_w^{2/5} H_w^{1/5} - 2.1 H_w$$

$$d = 0.48 [(T_c + 460)/(T_a + 460)]^{1/2} z \quad \text{(Equation 5-8)}$$

For SI:  $d = 0.48 (T_c/T_a)^{1/2} z$

where:

$d$  = Plume diameter, feet (m).

$T_a$  = Ambient air temperature, °F (°K).

$T_c$  = Plume centerline temperature, °F (°K).

$$= 0.6 (T_a + 460) Q_c^{2/3} Z^{-5/3} + T_a$$

$z$  = Height at which  $T_c$  is determined, feet (m).

For SI:  $T_c = 0.08 T_a Q_c^{2/3} Z^{-5/3} + T_a$

$$R = [Q/(12\pi q'')]^{1/4} \quad \text{(Equation 5-9)}$$

where:

$Q'$  = Incident radiant heat flux required for nonpiloted ignition, Btu/ft<sup>2</sup> • s (W/m<sup>2</sup>).

$Q$  = Heat release from fire, Btu/s (kW).

$R$  = Separation distance from target to center of fuel package, feet (m).



$$T_s = (Q_c/mc) + (T_a) \quad \text{(Equation 5-10)}$$

where:

$C$  = Specific heat of smoke at smoke-layer temperature,  
Btu/lb<sup>o</sup>F (kJ/kg × K).

$m$  = Exhaust rate, pounds per second (kg/s).

$Q_c$  = Convective heat output of fire, Btu/s (kW).

$T_a$  = Ambient temperature, <sup>o</sup>F (K).

$T_s$  = Smoke temperature, <sup>o</sup>F (K).

**Exception:** Reduced  $T_s$  as calculated based on the assurance of adequate dilution air.

**(Equation 8-1)**

$$\underline{D = F \times \sqrt{A}}$$

where: D = Distance, in feet, measured from the center of the chimney outlet to the nearest edge of the construction.

F = Value determined from Table 802.5.

A = Free area, in square inches, of chimney flue space.

$$D = F \times \sqrt{A} \quad \text{(Equation 8-2)}$$

where: D = Distance, in feet, measured from the center of the chimney outlet to the nearest edge of the construction.

where: F = Value determined from table below

where: A = Free area, in square inches, of chimney flue space.

$$V_t = \frac{(0.000417T - 0.0466)V_s}{\left(\frac{P_a}{P_f}\right) - \left(\frac{P_a}{P_o}\right)} \quad \text{(Equation 10-1)}$$

For SI:

$$V_t = \frac{(0.000738T - 0.03348)V_s}{\left(\frac{P_a}{P_f}\right) - \left(\frac{P_a}{P_o}\right)}$$

where:

$V_t$  = Minimum volume of tanks (gallons) (L).

$V_s$  = Volume of system, not including expansion tanks (gallons) (L).

$T$  = Average operating temperature (°F) (°C).

$P_a$  = Atmospheric pressure (psi) (kPa).

$P_f$  = Fill pressure (psi) (kPa).

$P_o$  = Maximum operating pressure (psi) (kPa).

$$F = \sqrt{G} \quad \text{(Equation 11-1)}$$

For SI:  $F = 0.138 \sqrt{G}$

where:

$F$  = The free opening area in square feet ( $m^2$ ).

$G$  = The mass of refrigerant in pounds (kg) in the largest system, any part of which is located in the machinery room.

$$Q = 100 \times \sqrt{G} \quad \text{(Equation 11-2)}$$

For SI:  $Q = 0.07 \times \sqrt{G}$

where:

$Q$  = The airflow in cubic feet per minute ( $m^3/s$ ).

$G$  = The design mass of refrigerant in pounds (kg) in the largest system, any part of which is located in the machinery room.

**TABLE 305.4  
PIPING SUPPORT SPACING<sup>a</sup>**

<b>PIPING MATERIAL</b>	<b>MAXIMUM HORIZONTAL SPACING (feet)</b>	<b>MAXIMUM VERTICAL SPACING (feet)</b>
ABS pipe	4	10 <sup>c</sup>
Aluminum pipe and tubing	10	15
Brass pipe	10	10
Brass tubing, 1- <sup>1</sup> / <sub>4</sub> -inch diameter and smaller	6	10
Brass tubing, 1- <sup>1</sup> / <sub>2</sub> -inch diameter and larger	10	10
Cast-iron pipe <sup>b</sup>	5	15
Copper or copper-alloy pipe	12	10
Copper or copper-alloy tubing, 1- <sup>1</sup> / <sub>4</sub> -inch diameter and smaller	6	10
Copper or copper-alloy tubing, 1- <sup>1</sup> / <sub>2</sub> -inch diameter and larger	10	10
CPVC pipe or tubing, 1 inch and smaller	3	10 <sup>c</sup>
CPVC pipe or tubing 1- <sup>1</sup> / <sub>4</sub> -inch and larger	4	10 <sup>c</sup>
Steel pipe	12	15
Steel tubing	8	10
Lead pipe	Continuous	4
PB pipe or tubing	$2\frac{2}{3}$ (32 inches)	4
PEX tubing	$2\frac{2}{3}$ (32 inches)	10 <sup>c</sup>
PVC pipe	4	10 <sup>c</sup>

For SI: 1 inch = 25.4 mm, 1 foot = 304.8 mm.

- a. See Section 301.14.
- b. The maximum horizontal spacing of cast-iron pipe hangers shall be increased to 10 feet where 10-foot lengths of pipe are installed.
- c. Mid-story guide.

**{NOTE: MODIFY TABLE 308.6 BELOW BY REVISING THE FIRST ROW IN THE FIRST COLUMN BY REPLACING “0.024 INCH (NO. 24 GAGE)” WITH “0.0296 INCH (NO. 22 GAGE)” AND BY DELETING THE SECOND ROW IN ITS ENTIRETY.}**

TABLE 308.6  
CLEARANCE REDUCTION METHODS

TYPE OF PROTECTIVE ASSEMBLY <sup>a</sup>	REDUCED CLEARANCE WITH PROTECTION (inches) <sup>a</sup>							
	Horizontal combustible assemblies located above the heat source				Horizontal combustible assemblies located beneath the heat source and all vertical combustible assemblies			
	Required clearance to combustibles without protection (inches) <sup>a</sup>				Required clearance to combustibles without protection (inches) <sup>a</sup>			
	36	18	9	6	36	18	9	6
Galvanized sheet metal, minimum nominal thickness of 0.024 inch (No. 24 Gage), mounted on 1-inch glass fiber or mineral wool batt reinforced with wire on the back, 1 inch off the combustible assembly	18	9	5	3	12	6	3	3
Galvanized sheet metal, minimum nominal thickness of 0.024 inch (No. 24 Gage), spaced 1 inch off the combustible assembly	18	9	5	3	12	6	3	2
Two layers of galvanized sheet metal, minimum nominal thickness of 0.024 inch (No. 24 Gage), having a 1-inch airspace between layers, spaced 1 inch off the combustible assembly	18	9	5	3	12	6	3	3
Two layers of galvanized sheet metal, minimum nominal thickness of 0.024 inch (No. 24 Gage), having 1 inch of fiberglass insulation between layers, spaced 1 inch off the combustible assembly	18	9	5	3	12	6	3	3
0.5-inch inorganic insulating board, over 1 inch of fiberglass or mineral wool batt, against the combustible assembly	24	12	6	4	18	9	5	3
3.5-inch brick wall, spaced 1 inch off the combustible wall	—	—	—	—	12	6	6	6
3.5-inch brick wall, against the combustible wall	—	—	—	—	24	12	6	5

For SI: 1 inch = 25.4 mm, °C = [(°F)-32]/1.8, 1 pound per cubic foot = 16.02 kg/m<sup>3</sup>, 1.0 Btu • in./ft<sup>2</sup> • h • °F = 0.144 W/m<sup>2</sup> • K.

- a. Mineral wool and glass fiber batts (blanket or board) shall have a minimum density of 8 pounds per cubic foot and a minimum melting point of 1,500°F. Insulation material utilized as part of a clearance reduction system shall have a thermal conductivity of 1.0 Btu • in./(ft<sup>2</sup> • h • °F) or less. Insulation board shall be formed of noncombustible material.

**TABLE 401.6  
 OPENING SIZES IN LOUVERS, GRILLES AND  
 SCREENS PROTECTING OUTDOOR EXHAUST AND  
 AIR INTAKE OPENINGS**

OUTDOOR OPENING TYPE	MINIMUM AND MAXIMUM OPENING SIZES IN LOUVERS, GRILLES AND SCREENS MEASURED IN ANY DIRECTION
Exhaust openings	Not < ¼ inch and not > ½ inch
Intake openings in residential occupancies	Not < ¼ inch and not > ½ inch
Intake openings in other than residential occupancies	> ¼ inch and not > 1 inch

For SI: 1 inch = 25.4 mm.

**{NOTE: ADD TO TABLE 403.3 BELOW A ROW FOR “LABORATORIES” AND ADD A FOOTNOTE “H” TO TABLE 403.3 BELOW TO READ AS FOLLOWS:**

<b><u>Laboratories</u></b>		
<b><u>Industrial and nonteaching</u></b>	<b><u>8</u></b>	<b><u>1.0cfm/ft<sup>2</sup></u></b>
<b><u>Chemical</u></b>	<b><u>8</u></b>	<b><u>1.0cfm/ft<sup>2</sup></u></b>
<b><u>Biological</u></b>	<b><u>8</u></b>	<b><u>1.0cfm/ft<sup>2</sup></u></b>
<b><u>Nonproduction chemical labs<sup>h</sup></u></b>	<b><u>as per NFPA 45</u></b>	<b><u>as per NFPA 45</u></b>

**h. Nonproduction chemical laboratories subject to Section 419 of the *New York City Building Code.* }**



**TABLE 403.3  
REQUIRED OUTDOOR VENTILATION AIR**

<b>OCCUPANCY CLASSIFICATION</b>	<b>ESTIMATED MAXIMUM OCCUPANT LOAD, PERSONS PER 1,000 SQUARE FEET<sup>a</sup></b>	<b>OUTDOOR AIR (Cubic feet per Minute (cfm) Per person) UNLESS NOTED<sup>e</sup></b>
<b>Correctional facilities</b>		
Cells		
without plumbing fixtures	20	20
with plumbing fixtures	20	20
Dining halls	100	15
Guard stations	40	15
<b>Dry Cleaners, laundries</b>		
Coin-operated dry cleaner	20	15
Coin-operated laundries	20	15
Commercial dry cleaner	30	30
Commercial laundry	10	25
Storage, pick up	30	35
<b>Education</b>		
Auditoriums	150	15
Classrooms	50	15
Corridors	—	0.10 cfm/ft <sup>2</sup>
Laboratories	30	20
Libraries	20	15
Locker rooms <sup>b</sup>	—	0.50 cfm/ft <sup>2</sup>
Music rooms	50	15
Smoking lounges <sup>b,g</sup>	70	60
Training shops	30	20
<b>Food and beverage service</b>		
Bars, cocktail lounges	100	30
Cafeteria, fast food	100	20
Dining rooms	70	20
Kitchens (cooking) <sup>f,g</sup>	20	15
<b>Hospitals, nursing and convalescent homes</b>		
Autopsy rooms <sup>b</sup>	—	0.50 cfm/ft <sup>2</sup>
Medical procedure rooms	20	15
Operating rooms	20	30
Patient rooms	10	25
Physical therapy	20	15
Recovery and ICU	20	15
<b>Hotels, motels, resorts and dormitories</b>		
Assembly rooms	120	15
Bathrooms <sup>b,g</sup>	—	35 cfm per room
Bedrooms	—	30 cfm per room
Conference rooms	50	20
Dormitory sleeping areas	20	15
Gambling casinos	120	30
Living rooms	—	30 cfm per room
Lobbies	30	15
<b>Offices</b>		
Conference rooms	50	20
Office spaces	7	20
Reception areas	60	15
Telecommunication centers and data entry	60	20

*(continued)*

**TABLE 403.3—continued**  
**REQUIRED OUTDOOR VENTILATION AIR**

OCCUPANCY CLASSIFICATION	ESTIMATED MAXIMUM OCCUPANT LOAD, PERSONS PER 1,000 SQUARE FEET <sup>a</sup>	OUTDOOR AIR (Cubic feet per Minute (cfm) Per person) UNLESS NOTED <sup>a</sup>
<b>Private dwellings, single and Multiple Living areas<sup>c</sup></b>	Based upon number of bedrooms. first bedroom: 2; each additional bedroom: 1	0.35 air changes per hour <sup>a</sup> or 15 cfm per person, whichever is greater
Kitchens <sup>§</sup>	—	100 cfm intermittent or 25 cfm continuous
Toilet rooms and bathrooms <sup>§</sup>	—	mechanical exhaust capacity of 50 cfm intermittent or 20 cfm continuous
Garages, separate for each dwelling	—	100 cfm per car
Garages, common for multiple units <sup>b</sup>	—	1.5 cfm/ft <sup>2</sup>
<b>Public spaces</b>		
Corridors and utilities	—	0.05 cfm/ft <sup>2</sup>
Elevators <sup>§</sup>	—	1.00 cfm/ft <sup>2</sup>
Locker rooms <sup>b</sup>	—	0.5 cfm/ft <sup>2</sup>
Toilet rooms <sup>b,§</sup>	—	75 cfm per water closet or urinal
Shower room (per shower head) <sup>b,§</sup>	—	50 cfm intermediate or 20 cfm continuous
Smoking lounges <sup>b,§</sup>	70	60
<b>Retail stores, sales floors and Showroom floors</b>		
Basement and street	—	0.30 cfm/ft <sup>2</sup>
Dressing rooms	—	0.20 cfm/ft <sup>2</sup>
Malls and arcades	—	0.20 cfm/ft <sup>2</sup>
Shipping and receiving	—	0.15 cfm/ft <sup>2</sup>
Smoking lounges <sup>b</sup>	70	60
Storage rooms	—	0.15 cfm/ft <sup>2</sup>
Upper floors	—	0.20 cfm/ft <sup>2</sup>
Warehouses	—	0.05 cfm/ft <sup>2</sup>
<b>Specialty shops</b>		
Automotive service stations	—	1.5 cfm/ft <sup>2</sup>
Barber	25	15
Beauty	25	25
Clothiers, furniture	—	0.30 cfm/ft <sup>2</sup>
Florists	8	15
Hardware, drugs, fabrics	8	15
Nail salon <sup>b</sup>	—	25
Pet shops	—	1.00 cfm/ft <sup>2</sup>
Reducing salons	20	15
Supermarkets	8	15

(continued)

**TABLE 403.3—continued  
REQUIRED OUTDOOR VENTILATION AIR**

OCCUPANCY CLASSIFICATION	ESTIMATED MAXIMUM OCCUPANCY LOAD, PERSONS PER 1,000 SQUARE FEET <sup>a</sup>	OUTDOOR AIR (Cubic feet per Minute (cfm) Per person) UNLESS NOTED <sup>b</sup>
<b>Sports and amusement</b>		
Ballrooms and discos	100	25
Bowling alleys (seating areas)	70	25
Game rooms	70	25
Ice arenas	—	0.50 cfm/ft <sup>2</sup>
Playing floors (gymnasiums)	30	20
Spectator areas	150	15
Swimming pools (pool and deck area)	—	0.50 cfm/ft <sup>2</sup>
<b>Storage</b>		
Repair garages, enclosed parking garages <sup>d</sup>	—	1.5 cfm/ft <sup>2</sup>
Warehouses	—	0.05 cfm/ft <sup>2</sup>
<b>Theaters</b>		
Auditoriums	150	15
Lobbies	150	20
Stages, studios	70	15
Ticket booths	60	20
<b>Transportation</b>		
Platforms	100	15
Vehicles	150	15
Waiting rooms	100	15
<b>Workrooms</b>		
Bank vaults	5	15
Darkrooms	—	0.50 cfm/ft <sup>2</sup>
Duplicating, printing	—	0.50 cfm/ft <sup>2</sup>
Meat processing <sup>e</sup>	10	15
Pharmacy	20	15
Photo studios	10	15

For SI: 1 cubic foot per minute = 0.0004719 m<sup>3</sup>/s, 1 ton = 908 kg,  
1 cubic foot per minute per square foot = 0.00508 m<sup>3</sup>/(s • m<sup>2</sup>),  
°C = [(°F) - 32]/1.8, 1 square foot = 0.0929 m<sup>2</sup>.

- a. Based upon net floor area.
- b. Mechanical exhaust required and the recirculation of air from such spaces as permitted by Section 403.2.1 is prohibited (see Section 403.2.1).
- c. Spaces unheated or maintained below 50°F are not covered by these requirements unless the occupancy is continuous.
- d. Ventilation systems in enclosed parking garages shall comply with Section 404. A mechanical ventilation system shall not be required in garages having a floor area not exceeding 850 square feet and used for the storage of not more than four vehicles or trucks of 1 ton maximum capacity.
- e. Where the ventilation rate is expressed in cfm/ft<sup>2</sup>, such rate is based upon cubic feet per minute per square foot of the floor area being ventilated.
- f. The sum of the outdoor and transfer air from adjacent spaces shall be sufficient to provide an exhaust rate of not less than 1.5 cfm/ft<sup>2</sup>.
- g. Transfer air permitted in accordance with Section 403.2.2.

**TABLE 507.11**  
**MINIMUM DISTANCE BETWEEN THE LOWEST EDGE OF A**  
**GREASE FILTER AND THE COOKING SURFACE OR THE HEATING SURFACE**

<b><u>TYPE OF COOKING APPLIANCE</u></b>	<b><u>HEIGHT ABOVE COOKING SURFACE (feet)</u></b>
<u>Without exposed flame</u>	<u>0.5</u>
<u>Exposed flame and burners</u>	<u>2</u>
<u>Exposed charcoal and charbroil type</u>	<u>4</u>

For SI: 1 foot = 304.8 mm.

**TABLE 510.8**  
**MINIMUM DUCT THICKNESS**

<b>DIAMETER OF DUCT OR MAXIMUM SIDE DIMENSION</b>	<b>MINIMUM NOMINAL THICKNESS</b>		
	<b>Nonabrasive materials</b>	<b>Nonabrasive/ Abrasive materials</b>	<b>Abrasive materials</b>
0-8 inches	0.028 inch (No. 24 Gage)	0.034 inch (No. 22 Gage)	0.040 inch (No. 20 Gage)
9-18 inches	0.034 inch (No. 22 Gage)	0.040 inch (No. 20 Gage)	0.052 inch (No. 18 Gage)
19-30 inches	0.040 inch (No. 20 Gage)	0.052 inch (No. 18 Gage)	0.064 inch (No. 16 Gage)

**TABLE 510.8.2  
CLEARANCE TO COMBUSTIBLES**

<b>TYPE OF EXHAUST OR TEMPERATURE OF EXHAUST (°F)</b>	<b>CLEARANCE TO COMBUSTIBLES (inches)</b>
Less than 100	1
100-600	12
Flammable vapors	6

For SI: 1 inch = 25.4 mm, EC = [(EF)- 32]/1.8.

**{NOTE: REVISE TABLE 511.2 BELOW BY REPLACING THE WORD “CHIMNEYS” IN THE TITLE WITH “DUST, STOCK AND REFUSE CONVEYING SYSTEMS” AND BY REPLACING THE COLUMN HEADING “CHIMNEYS SERVING” WITH “TEMPERATURE RANGE”.}**

**TABLE 511.2  
CONSTRUCTION, CLEARANCE AND TERMINATION REQUIREMENTS FOR  
SINGLE-WALL METAL CHIMNEYS**

CHIMNEYS SERVING	MINIMUM THICKNESS		TERMINATION			CLEARANCE				
	Walls	Lining	Above roof opening (feet)	Above any part of building within (feet)			Combustible construction (inches)		Noncombustible construction	
				10	25	50	Interior inst.	Exterior inst.	Interior inst.	Exterior inst.
Low-heat appliances (1,000°F normal operation)	0.127" (No. 10 MSG)	None	3	2	—	—	18	6	Up to 18" diameter, 2" Over 18" diameter, 4"	
Medium-heat appliances (2,000°F maximum) <sup>b</sup>	0.127" (No. 10 MSG)	Up to 18" dia.—2½" Over 18" —4½" On 4½" bed	10	—	10	—	36	24		
High-heat appliances (Over 2,000°F) <sup>c</sup>	0.127" (No. 10 MSG)	4½" laid on 4½" bed	20	—	—	20	See Note c			

For SI: 1 inch = 25.4 mm, 1 foot = 304.8 mm, °C = [(°F)-32]/1.8.

- Lining shall extend from bottom to top of outlet.
- Lining shall extend from 24 inches below connector to 24 feet above.
- Clearance shall be as specified by the design engineer and shall have sufficient clearance from buildings and structures to avoid overheating combustible materials (maximum 160°F).

**TABLE 603.4  
DUCT CONSTRUCTION MINIMUM SHEET METAL  
THICKNESSES FOR SINGLE DWELLING UNITS**

DUCT SIZE	GALVANIZED		APPROXIMATE ALUMINUM B&S GAGE
	Minimum thickness (Inches)	Equivalent Galvanized Gage No.	
Round ducts and enclosed Rectangular ducts			
14" or less	0.013	30	26
Over 14"	0.016	28	24
Exposed rectangular ducts			
14" or less	0.016	28	24
Over 14"	0.019	26	22

For SI: 1 inch = 25.4 mm.

**TABLE 607.3.1  
FIRE DAMPER RATING**

<b>TYPE OF PENETRATION</b>	<b>MINIMUM DAMPER RATING (hour)</b>
Less than 3-hour fire-resistance-rated assemblies	1½
3-hour or greater fire-resistance-rated assemblies	3

**{NOTE: DELETE IN ITS ENTIRETY FROM TABLE 802.2 BELOW THE ROW “PELLET VENTS”.}**

**TABLE 802.2  
VENT APPLICATION**

VENT TYPES	APPLIANCE TYPES
Type L oil vents	Oil-burning appliances listed and labeled for venting with Type L vents; gas appliances listed and labeled for venting with Type B vents.
Pellet vents	Pellet fuel-burning appliances listed and Labeled for venting with pellet vents.

**TABLE 802.5**  
**“F” FACTOR FOR DETERMINING CHIMNEY DISTANCES**

<b><u>“F” FACTOR FOR DETERMINING CHIMNEY DISTANCES</u></b>			
<b><u>Type of Fuel</u></b>	<b><u>“F” Factor</u></b>		
	<u>600°F (316°C) and less</u>	<u>600°F (316°C) to 1000°F (538°C)</u>	<u>Greater than 1000°F (538°C)</u>
<u>No. 2 Fuel Oil</u>	<u>2.5</u>	<u>2.5</u>	<u>3</u>
<u>No. 4, 6 Fuel Oil</u>	<u>3</u>	<u>3</u>	<u>3</u>

**TABLE 803.9(1)**  
**MINIMUM CHIMNEY CONNECTOR THICKNESS FOR  
LOW-HEAT APPLIANCES**

<b>DIAMETER OF CONNECTOR (inches)</b>	<b>MINIMUM NOMINAL THICKNESS (galvanized) (inches)</b>
5 and smaller	0.022 (No. 26 Gage)
Larger than 5 and up to 10	0.028 (No. 24 Gage)
Larger than 10 and up to 16	0.034 (No. 22 Gage)
Larger than 16	0.064 (No. 16 Gage)

For SI: 1 inch = 25.4 mm.



**TABLE 803.10.4  
CHIMNEY CONNECTOR SYSTEMS AND CLEARANCES  
TO COMBUSTIBLE WALL MATERIALS FOR  
DOMESTIC HEATING APPLIANCES<sup>a,b,c,d</sup>**

System A (12-inch clearance)	A 3.5-inch-thick brick wall shall be framed into the combustible wall. A 0.625-inch-thick fire-clay liner (ASTM C 315 or equivalent) <sup>e</sup> shall be firmly cemented in the center of the brick wall maintaining a 12-inch clearance to combustibles. The clay liner shall run from the outer surface of the bricks to the inner surface of the chimney liner.
System B (9-inch clearance)	A labeled solid-insulated factory-built chimney section (1-inch insulation) the same inside diameter as the connector shall be utilized. Sheet metal supports cut to maintain a 9-inch clearance to combustibles shall be fastened to the wall surface and to the chimney section. Fasteners shall not penetrate the chimney flue liner. The chimney length shall be flush with the masonry chimney liner and sealed to the masonry with water-insoluble refractory cement. Chimney manufacturers' parts shall be utilized to securely fasten the chimney connector to the chimney section.
System C (6-inch clearance)	A sheet metal (minimum number 24 Gage) ventilated thimble having two 1-inch air channels shall be installed with a sheet steel chimney connector (minimum number 24 Gage). Sheet steel supports (minimum number 24 Gage) shall be cut to maintain a 6-inch clearance between the thimble and combustibles. One side of the support shall be fastened to the wall on all sides. Glass-fiber insulation shall fill the 6-inch space between the thimble and the supports.
System D (2-inch clearance)	A labeled solid-insulated factory-built chimney section (1-inch insulation) with a diameter 2 inches larger than the chimney connector shall be installed with a sheet steel chimney connector (minimum number 24 Gage). Sheet metal supports shall be positioned to maintain a 2-inch clearance to combustibles and to hold the chimney connector to ensure that a 1-inch airspace surrounds the chimney connector through the chimney section. The steel support shall be fastened to the wall on all sides and the chimney section shall be fastened to the supports. Fasteners shall not penetrate the liner of the chimney section.

For SI: 1 inch = 25.4 mm, 1.0 Btu × in/ft<sup>2</sup> · h · °F = 0.144 W/m<sup>2</sup> · °K.

a. Insulation material that is part of the wall pass-through system shall be noncombustible and shall have a thermal conductivity of 1.0 Btu × in/ft<sup>2</sup> · h · °F or less.

b. All clearances and thicknesses are minimums.

**{NOTE: REVISE TABLE 803.10.6 BY REPLACING THE WORDS “AS DETERMINED BY THE CODE OFFICIAL” WITH “IN ACCORDANCE WITH NFPA-211”.}**

**TABLE 803.10.6  
CONNECTOR CLEARANCES TO COMBUSTIBLES**

<b>TYPE OF APPLIANCE</b>	<b>MINIMUM CLEARANCE (inches)</b>
<b>Comestic-type appliances</b>	
Chimney and vent connectors	
Electric and oil incinerators	18
Oil and solid fuel appliances	18
Oil appliances labeled for venting with Type L vents	9
<b>Commercial, industrial-type appliances</b>	
<b>Low-heat appliances</b>	
Chimney connectors	
Oil and solid fuel boilers, furnaces and water heaters	18
Oil unit heaters	18
Other low-heat industrial appliances	18
<b>Medium-heat appliances</b>	
Chimney connectors	
All oil and solid fuel appliances	36
<b>High-heat appliances</b>	
Masonry or metal connectors	
All oil and solid fuel appliances	(As determined by the code official)

For SI: 1 inch = 25.4 mm.

**TABLE 926.1(1)**  
**MAXIMUM SOUND POWER LEVELS PERMITTED FOR EXTERIOR MECHANICAL EQUIPMENT**  
**ADJOINING BUILDINGS**

<i>Minimum distance from equipment to exterior window (ft.)<sup>a</sup></i>	<i>Maximum Sound Power Levels in Octave Bands – db re 10<sup>-13</sup>Watts<sup>a</sup></i>							
	<i>Octave Bands c.p.s. Mid Frequency</i>							
	<u>63</u>	<u>125</u>	<u>250</u>	<u>500</u>	<u>1000</u>	<u>2000</u>	<u>4000</u>	<u>8000</u>
<u>12</u>	<u>97</u>	<u>90</u>	<u>83</u>	<u>78</u>	<u>75</u>	<u>73</u>	<u>72</u>	<u>71</u>
<u>25</u>	<u>104</u>	<u>96</u>	<u>89</u>	<u>84</u>	<u>81</u>	<u>79</u>	<u>78</u>	<u>77</u>
<u>50</u>	<u>110</u>	<u>102</u>	<u>95</u>	<u>90</u>	<u>87</u>	<u>85</u>	<u>84</u>	<u>83</u>
<u>100</u>	<u>116</u>	<u>108</u>	<u>101</u>	<u>96</u>	<u>93</u>	<u>91</u>	<u>90</u>	<u>89</u>
	<i>Octave Bands- db re 10<sup>-12</sup> Watts</i>							
<u>12</u>	<u>87</u>	<u>80</u>	<u>73</u>	<u>68</u>	<u>65</u>	<u>63</u>	<u>62</u>	<u>61</u>
<u>25</u>	<u>94</u>	<u>86</u>	<u>79</u>	<u>74</u>	<u>71</u>	<u>69</u>	<u>68</u>	<u>67</u>
<u>50</u>	<u>100</u>	<u>92</u>	<u>85</u>	<u>80</u>	<u>77</u>	<u>75</u>	<u>74</u>	<u>73</u>
<u>100</u>	<u>106</u>	<u>98</u>	<u>91</u>	<u>86</u>	<u>83</u>	<u>81</u>	<u>80</u>	<u>79</u>

**Notes:**

<sup>a</sup> The minimum distance shall be measured in a straight line regardless of obstructions. Interpolated levels may be used for distances between those given in this table. See note a. at end of Table 1207.2.1 in the *New York City Building Code*.

1. In the event sound power level data for the exterior mechanical equipment is not available, the sound pressure levels in octave bands, of the exterior mechanical equipment shall be measured.
2. The measurements shall be obtained with the microphone of the measuring equipment located at the interior of the dwelling unit affected in a line with the window nearest the exterior mechanical equipment. The window shall be fully open and the microphone shall be located 3 feet away from the open portion of the window.
3. Measurements shall be obtained during times when the ambient sound pressure levels, in octave bands, are at least 6 db lower at all octave bands than the sound pressure levels measured with the exterior equipment operating. By ambient sound pressure levels is meant the measured sound pressure levels, at the above described measuring location, with the exterior equipment not in operation.

**TABLE 926.1(2)**  
**NOISE OUTPUT LIMITATIONS FOR EXTERIOR MECHANICAL EQUIPMENT**  
**MAXIMUM SOUND PRESSURE LEVEL<sup>a</sup>**  
**(NOT TO BE EXCEEDED IN ANY OCTAVE BANDS)**

<i>Octave Bands</i> <i>Center Frequency (cps)</i>	<i>Decibels</i> <i>Re .0002 Microbar</i>
<u>63</u>	<u>61</u>
<u>125</u>	<u>53</u>
<u>250</u>	<u>46</u>
<u>500</u>	<u>40</u>
<u>1000</u>	<u>36</u>
<u>2000</u>	<u>34</u>
<u>4000</u>	<u>33</u>
<u>8000</u>	<u>32</u>

**Note:**

<sup>a</sup> Measurements shall be obtained with a sound level meter and octave band analyzer, calibrated both electronically and acoustically before and after the measurements are made.

**TABLE 1004.8**  
**MINIMUM CONTROL REQUIREMENTS**

<u>Type of Control</u>	<u>Gross Output Firing Rate of the Boiler or the Burner Oil Delivery Rate (gph), Whichever is Greater</u>		
	<u>#6 Oil</u>	<u>#4 Oil</u>	<u>#2 Oil</u>
<u>On-Off</u>	<u>=</u>	<u>=</u>	<u>&lt;10</u>
<u>Low-High-Off with low fire start</u>	<u>20 to &lt;30</u>	<u>10 to &lt;30</u>	<u>10 to &lt;30</u>
<u>Low-High-Low-Off with proven low fire start</u>	<u>30 to &lt;50</u>	<u>30 to &lt;50</u>	<u>30 to &lt;50</u>
<u>Full Modulation with proven low fire start</u>	<u>≥50</u>	<u>≥50</u>	<u>≥50</u>
<u>Full Modulation with proven low fire start as well as Cross-Limited Oxygen Trim (dry cell electrochemical type)</u>	<u>≥350</u>	<u>≥350</u>	<u>≥350</u>

(F) TABLE 1103.1  
REFRIGERANT CLASSIFICATION, AMOUNT AND TLV-TWA

REFRIGERANT	CHEMICAL FORMULA	CHEMICAL NAME OR BLEND	HAZARD CATEGORIES <sup>1</sup>	REFRIGERANT CLASSIFICATION OF HAZARD <sup>2</sup>	DEGREES OF HAZARD <sup>3</sup>	[M] AMOUNT OF REFRIGERANT PER OCCUPIED SPACE			TLV-TWA <sup>4</sup> (ppm)
						Pounds per 1,000 cubic feet	ppm	g/m	
R-11 <sup>a</sup>	CCl <sub>3</sub> F	Trichlorofluoromethane	OHH	A1	2-0-0 <sup>b</sup>	0.39	1,100	6.2	C1,000
R-12 <sup>a</sup>	CCl <sub>2</sub> F <sub>2</sub>	Dichlorodifluoromethane	CG,OHH	A1	2-0-0 <sup>b</sup>	5.6	18,000	90	1,000
R-13 <sup>a</sup>	CClF <sub>3</sub>	Chlorotrifluoromethane	CG,OHH	A1	2-0-0 <sup>b</sup>	18	67,000	290	1,000
R-13B1 <sup>a</sup>	CBrF <sub>3</sub>	Bromotrifluoromethane	CG,OHH	A1	2-0-0 <sup>b</sup>	22	57,000	350	1,000
R-14	CF <sub>4</sub>	Tetrafluoromethane (carbon tetrafluoride)	CG,OHH	A1	2-0-0 <sup>b</sup>	16	69,000	250	1,000
R-22	CHClF <sub>2</sub>	Chlorodifluoromethane	CG,OHH	A1	2-0-0 <sup>b</sup>	5.5	25,000	89	1,000
R-23	CHF <sub>3</sub>	Trifluoromethane (fluoroform)	CG,OHH	A1	2-0-0 <sup>b</sup>	7.3	41,000	120	1,000
R-32	CH <sub>2</sub> F <sub>2</sub>	Difluoromethane (methylene fluoride)	CG,F,OHH	A2	4-2	4.2	32,000	68	—
R-113 <sup>a</sup>	CCl <sub>3</sub> FCClF <sub>2</sub>	1, 1,2-trichloro-1,2,2-trifluoroethane	OHH	A1	2-0-0 <sup>b</sup>	1.2	2,600	20	1,000
R-114 <sup>a</sup>	CClF <sub>2</sub> CClF <sub>2</sub>	1,2-dichloro-1,2,2-tetrafluoroethane	CG,OHH	A1	2-0-0 <sup>b</sup>	8.7	20,000	140	1,000
R-116	CF <sub>3</sub> CF <sub>3</sub>	Hexafluoroethane	CH,OHH	A1	1-0-0	24	69,000	390	—
R-123	CHCl <sub>2</sub> CF <sub>3</sub>	2,2-dichloro-1,1,1-trifluoroethane	OHH	B1	2-0-0 <sup>b</sup>	3.5	9,100	57	50
R-124	CHClF <sub>2</sub> CF <sub>3</sub>	2-chloro-1,1,1,2-tetrafluoroethane	CG,OHH	A1	2-0-0 <sup>b</sup>	3.5	10,000	56	1,000
R-125	CHF <sub>2</sub> CF <sub>3</sub>	Pentafluoroethane	CG,OHH	A1	2-0-0 <sup>b</sup>	21	69,000	340	—
R-134a	CH <sub>2</sub> FCF <sub>3</sub>	1,1,1,2-tetrafluoroethane	CG,OHH	A1	2-0-0 <sup>b</sup>	1.3	50,000	210	1,000
R-143a	CH <sub>3</sub> CF <sub>3</sub>	1,1,1-trifluoroethane	CG,F,OHH	A2	2-0-0 <sup>b</sup>	3.8	18,000	60	—
R-152a	CH <sub>3</sub> CHF <sub>2</sub>	1,1-difluoroethane	CG,F,OHH	A2	1-4-0	1.6	9,300	25	—
R-170	CH <sub>3</sub> CH <sub>3</sub>	Ethane	CG,F,OHH	A3	2-4-0	0.54	7,000	8.7	1,000
R-218	CF <sub>3</sub> CF <sub>2</sub> CF <sub>3</sub>	Octafluoropropane	CG,OHH	A1	2-0-0 <sup>b</sup>	33	69,000	530	—
R-236fa	CF <sub>3</sub> C <sub>2</sub> H <sub>2</sub> CF <sub>3</sub>	1,1,1,3,3,3-hexafluoropropane	CG,OHH	A1	2-0-0 <sup>b</sup>	21	55,000	—	1,000
R-245fa	CHF <sub>2</sub> CH <sub>2</sub> CF <sub>3</sub>	1,1,1,3,3-pentafluoropropane	CG,OHH	B1	2-0-0 <sup>b</sup>	12	34,000	—	300
R-290	CH <sub>3</sub> CH <sub>2</sub> CH <sub>3</sub>	Propane	CG,F,OHH	A3	2-4-0	0.56	5,000	9.0	2,500
R-600 <sup>a</sup>	zeotrope	R-12/114	CG,OHH	A1	2-0-0 <sup>b</sup>	9.3	26,000	150	—
R-401A	zeotrope	R-22/152a/124 (53/13/34)	CG,OHH	A1	2-0-0 <sup>b</sup>	4.8	20,000	77	—
R-401B	zeotrope	R-22/152a/124 (61/11/28)	CG,OHH	A1	2-0-0 <sup>b</sup>	4.9	21,000	79	—
R-401C	zeotrope	R-22/152a/124 (33/15/52)	CG,OHH	A1	2-0-0 <sup>b</sup>	4.4	17,000	71	—
R-402A	zeotrope	R-125/290/22 (60/2/38)	CG,OHH	A1	2-0-0 <sup>b</sup>	10	39,000	160	—
R-402B	zeotrope	R-125/290/22 (38/2/60)	CG,OHH	A1	2-0-0 <sup>b</sup>	7.8	32,000	120	—
R-403A	zeotrope	R-290/22/218 (5/75/20)	CG,OHH	A1	2-0-0 <sup>b</sup>	—	—	—	—
R-403B	zeotrope	R-290/22/218 (5/56/39)	CG,OHH	A1	2-0-0 <sup>b</sup>	—	—	—	—
R-404A	zeotrope	R-125/143a/134a (44/52/4)	CG,OHH	A1	2-0-0 <sup>b</sup>	17	69,000	280	—

(continued)

REFRIGERATION

[F] TABLE 1103.1 continued  
REFRIGERANT CLASSIFICATION, AMOUNT AND TLV-TWA

REFRIGERANT	CHEMICAL FORMULA	CHEMICAL NAME OR BLEND	HAZARD CATEGORIES <sup>a</sup>	REFRIGERANT CLASSIFICATION	DEGREES OF HAZARD <sup>b</sup>	[M] AMOUNT OF REFRIGERANT PER OCCUPIED SPACE			
						Pounds per 1,000 cubic feet	ppm	g/m	TLV-TWA <sup>f</sup> (ppm)
R-406A	zeotrope	R-22/600a/142b (5.5/4/41)	CG,FOHH	A2	—	—	—	—	—
R-407A	zeotrope	R-32/12.5/13.4a (20/40/40)	CG,OH	A1	2-0-0 <sup>c</sup>	16	69,000	260	—
R-407B	zeotrope	R-32/12.5/13.4a (10/70/20)	CG,OH	A1	2-0-0 <sup>c</sup>	18	69,000	290	—
R-407C	zeotrope	R-32/12.5/13.4a (23/25/52)	CG,OH	A1	2-0-0 <sup>c</sup>	15	69,000	240	—
R-407D	zeotrope	R-32/12.5/13.4a (15/15/70)	CG,OH	A1	2-0-0 <sup>c</sup>	15	65,000	240	—
R-407E	zeotrope	R-32/12.5/13.4a (25/15/60)	CG,OH	A1	2-0-0 <sup>c</sup>	15	69,000	240	—
R-408A	zeotrope	R-125/143a/22 (7/46/47)	CG,OH	A1	2-0-0 <sup>c</sup>	10	47,000	170	—
R-409A	zeotrope	R-22/12.4/142b (60/2.5/15)	CG,OH	A1	2-0-0 <sup>c</sup>	4.9	20,000	79	—
R-409B	zeotrope	R-22/12.4/142b (65/2.5/10)	CG,OH	A1	2-0-0 <sup>c</sup>	4.9	20,000	78	—
R-410A	zeotrope	R-32/12.5 (50/50)	CG,OH	A1	2-0-0 <sup>c</sup>	10	55,000	160	—
R-410B	zeotrope	R-32/12.5 (45/55)	CG,OH	A1	2-0-0 <sup>c</sup>	11	58,000	180	—
R-411A	zeotrope	R-127/22/152a (1.5/87.5/11.0)	CG,FOHH	A2	—	—	—	—	—
R-411B	zeotrope	R-127/22/152a (3/94/3)	CG,FOHH	A2	—	—	—	—	—
R-412A	zeotrope	R-22/31.8/142b (70/5/25)	CG,FOHH	A2	—	—	—	—	—
R-413A	zeotrope	R-218/134a/600a (9/88/3)	CG,FOHH	A2	—	—	—	—	—
R-414A	zeotrope	R-22/12.4/600a/142b (51/28.5/4/16.5)	CG,OH	A1	—	—	—	—	—
R-414B	zeotrope	R-22/12.4/600a/142b (50/39/1.5/9.5)	CG,OH	A1	—	—	—	—	—
R-416A	zeotrope	R-134a/124/600 (59/39.5/1.5)	CG,OH	A1	2-0-0 <sup>c</sup>	6	21,000	96	—
R-417A	zeotrope	R-125/134a/600 (45.5/50/3.5)	CG,OH	A1	2-0-0 <sup>c</sup>	—	—	—	—
R-500 <sup>e</sup>	azeotrope	R-12/15.2a (73.8/26.2)	CG,OH	A1	2-0-0 <sup>c</sup>	7.4	29,000	120	1,000
R-502 <sup>e</sup>	azeotrope	R-22/11.5 (48.8/51.2)	CG,OH	A1	2-0-0 <sup>c</sup>	10	35,000	160	1,000
R-503 <sup>e</sup>	azeotrope	R-23/13 (40.1/59.9)	CG,OH	A1	2-0-0 <sup>c</sup>	15	67,000	240	1,000
R-507A	azeotrope	R-125/143a (50/50)	CG,OH	A1	2-0-0 <sup>c</sup>	17	69,000	280	—
R-508A	azeotrope	R-23/11.6 (39/61)	CG,OH	A1	2-0-0 <sup>c</sup>	14	55,000	220	—
R-508B	azeotrope	R-23/11.6 (46/54)	CG,OH	A1	2-0-0 <sup>c</sup>	13	52,000	200	—
R-509A	zeotrope	R-22/21.8 (44/56)	CG,OH	A1	2-0-0 <sup>c</sup>	12	38,000	190	—
R-600	CH <sub>3</sub> CH <sub>2</sub> CH <sub>2</sub> CH <sub>3</sub>	Butane	CG,FOHH	A3	1-4-0	—	—	—	—
R-600a	CH(CH <sub>3</sub> ) <sub>2</sub> -CH <sub>3</sub>	Isobutane (2-methyl propane)	CG,FOHH	A3	2-4-0	0.51	2,500	6.0	800

(continued)

[F] TABLE 1103.1 (continued)

REFRIGERANT CLASSIFICATION, AMOUNT AND TLV-TWA

REFRIGERANT	CHEMICAL FORMULA	CHEMICAL NAME OR BLEND	HAZARD CATEGORIES <sup>a</sup>	REFRIGERANT CLASSIFICATION	DEGREES OF HAZARD <sup>b</sup>	[M] AMOUNT OF REFRIGERANT PER OCCUPIED SPACE			
						Pounds per 1,000 cubic feet	ppm	g/m	TLV-TWA <sup>f</sup> (ppm)
R-717	NH <sub>3</sub>	Ammonia	CG,C,F,OHH	B2	3-3-0 <sup>d</sup>	0.022	500	0.35	25
R-718	H <sub>2</sub> O	Water	—	A1	0-0-0	—	—	—	—
R-744	CO <sub>2</sub>	Carbon dioxide	CG,OHH	A1	2-0-0 <sup>e</sup>	4.5	40,000	72	5,000
R-1150	CH <sub>2</sub> =CH <sub>2</sub>	Ethene (ethylene)	CG,F,OHH	A3	1-4-2	0.38	5,200	6.0	1,000
R-1270	CH <sub>3</sub> CH=CH <sub>2</sub>	Propene (propylene)	CG,F,OHH	B3	1-4-1	0.37	3,400	5.0	660

For SI: 1 pound = 0.454 kg, 1 cubic foot = 0.0283 m<sup>3</sup>

a. CG = Compressed gas; C = Corrosive; F = Flammable; OHH = Other Health Hazard.

b. Degrees of hazard are for health, fire, and reactivity, respectively, in accordance with NFPA 704.

c. Reduction to 1-0-0 is allowed if analysis satisfactory to the code official shows that the maximum concentration for a rupture or full loss of refrigerant charge would not exceed the IDLH, considering both the refrigerant quantity and room volume.

d. For installations that are entirely outdoors, use 3-1-0.

e. Class I ozone depleting substance; prohibited for new installations.

f. PEL or consistent occupational exposure limit on a time-weighted average (TWA) basis (unless noted C for ceiling) for an 8 hr/d and 40 hr/wk.



**TABLE 1104.3.2  
MAXIMUM PERMISSIBLE QUANTITIES OF REFRIGERANTS**

TYPE OF REFRIGERATION SYSTEM	MAXIMUM POUNDS (kg) FOR VARIOUS OCCUPANCIES			
	Institutional	Assembly	Residential	All other occupancies
<b>Sealed absorption system</b>				
In exit access	0(0)	0(0)	3.3(1.5)	3.3(1.5)
In adjacent outdoor locations	0(0)	0(0)	22(10)	22(10)
In other than exit access	0(0)	6.6(3)	6.6(3)	6.6(3)
<b>Unit systems</b>				
In other than exit access	0(0)	0(0)	6.6(3)	6.6(3)

For SI: 1 pound = 0.454 kg.

**{NOTE: DELETE FROM TABLE 1202.4 BELOW THE ROWS “LEAD PIPE, AND POLYBUTYLENE (PB) PLASTIC PIPE AND TUBING” AND THEIR REFERENCE STANDARDS.}**

**TABLE 1202.4  
HYDRONIC PIPE**

<b>MATERIAL</b>	<b>STANDARD (see Chapter 15)</b>
Acrylonitrile butadiene styrene (ABS) plastic pipe	ASTM D 1527; ASTM D 2282
Brass pipe	ASTM B 43
Brass tubing	ASTM B 135
Copper or copper-alloy pipe	ASTM B 42; ASTM B 302
Copper or copper-alloy tube (Type K, L or M)	ASTM B 75; ASTM B 88; ASTM B 251
Chlorinated polyvinyl chloride (CPVC) plastic pipe	ASTM D 2846; ASTM F 441; ASTM F 442
Cross-linked polyethylene/aluminum/cross-linked polyethylene (PEX-AL-PEX) pressure pipe	ASTM F 1281; CSA CAN/CSA-B-137.10

*(continued)*

**TABLE 1202.4—continued  
HYDRONIC PIPE**

<b>MATERIAL</b>	<b>STANDARD (see Chapter 15)</b>
Cross-linked polyethylene (PEX) tubing	ASTM F 876; ASTM F 877
Lead pipe	FS WW-P-325B
Polybutylene (PB) plastic pipe and tubing	ASTM D 3309
Polyethylene (PE) pipe, tubing and fittings (for ground source heat pump loop systems)	ASTM D 2513; ASTM D 3035; ASTM D 2447; ASTM D 2683; ASTM F 1055; ASTM D 2837; ASTM D 3350; ASTM D 1693
Polyvinyl chloride (PVC) plastic pipe	ASTM D 1785; ASTM D 2241
Steel pipe	ASTM A 53; ASTM A 106
Steel tubing	ASTM A 254

**TABLE 1202.5  
HYDRONIC PIPE FITTINGS**

<b>MATERIAL</b>	<b>STANDARD (see Chapter 15)</b>
Bronze	ASME B16.24
Copper and copper alloys	ASME B16.15; ASME B16.18; ASME B16.22; ASME B16.23; ASME B16.26; ASME B16.29
Gray iron	ASTM A 126
Malleable iron	ASME B16.3
Plastic	ASTM D 2466; ASTM D 2467; ASTM D 2468; ASTM F 438; ASTM F 439; ASTM F 877
Steel	ASME B16.5; ASME B16.9; ASME B16.11; ASME B16.28; ASTM A 420
Brass	ASTM F 1974

**{NOTE: REVISE TABLE 1302.3 BELOW BY DELETING THE SECOND LINE “BRASS TUBING - ASTM B 135”, THE LAST LINE “STEEL TUBING - ASTM A 254; ASTM A 539”, DELETING TYPES “L OR M” ON THE FORTH LINE AND ADDING A FOOTNOTE “A” TO READ AS FOLLOWS:  
a. BRASS TUBING, STEEL TUBING AND COPPER TUBING L OR M ARE NOT PERMITTED}**

**TABLE 1302.3  
FUEL OIL PIPING**

<b>MATERIAL</b>	<b>STANDARD (see Chapter 15)</b>
Brass pipe	ASTM B 43
Brass tubing	ASTM B 135
Copper or copper-alloy pipe	ASTM B 42; ASTM B 302
Copper or copper-alloy tubing (Type K, L or M)	ASTM B 75; ASTM B 88; ASTM B 280
Labeled pipe	(See Section 1302.4)
Nonmetallic pipe	ASTM D 2996
Steel pipe	ASTM A 53; ASTM A 106
Steel tubing	ASTM A 254; ASTM A 539

**TABLE 1305.7(1)**  
**VENT PIPING FOR UNDERGROUND TANKS**

<b><u>TANK SIZE</u></b>	<b><u>MINIMUM VENT DIAMETER</u></b>
660 gallons (2500 L) or less	1¼ inch (32 mm)
661 gallons (2505 L) to 3,000 gallons (11 355 L)	1½ inch (38 mm)
3,001 gallons (11 360 L) to 10,000 gallons (37 850 L)	2 inch (51 mm)
10,001 gallons (37 855 L) to 20,000 gallons (75 700 L)	2½ inch (64 mm)
Larger than 20,000 gallons (75 700 L)	3 inch (76 mm)

**TABLE 1305.7(2)**  
**VENT PIPING FOR TANKS INSTALLED INSIDE BUILDINGS**

<b><u>TANK SIZE</u></b>	<b><u>MINIMUM VENT DIAMETER</u></b>
660 gallons (2500 L) or less	1 ¼ inch (32 mm) <sup>a</sup>
Larger than 660 gallons (2500 L)	Sized to prevent abnormal pressure in the tank during filling but not smaller than the pipe size specified in Table 1305.7(1)

- a. For tanks constructed to UL 80 specifications the minimum vent diameter shall be 2 inch (51 mm) or as required by Section 1305.8, Item .3, whichever is greater.

# THE NEW YORK CITY FUEL GAS CODE

## CHAPTER 1 ADMINISTRATION

### SECTION FGC 101 GENERAL

**101.1 Title.** This code shall be known and may be cited as the “*New York City Fuel Gas Code*,” “NYCFG” or “FGC”. All section numbers in this code shall be deemed to be preceded by the designation “FGC”.

**101.2 Scope.** This code shall apply to the installation of fuel-gas piping systems, fuel-gas utilization equipment and related accessories in accordance with Sections 101.2.2 through 101.2.5.

**101.2.1 Reserved.**

**101.2.2 Piping systems.** These regulations cover piping systems for natural gas with an operating pressure of 125 pounds per square inch gauge (psig) (862 kPa gauge) or less. Coverage shall extend from the point of delivery to the outlet of the equipment shutoff valves. Piping systems requirements shall include design, materials, components, fabrication, assembly, installation, testing, inspection, operation and maintenance.

**101.2.3 Gas utilization equipment.** Requirements for gas utilization equipment and related accessories shall include installation, combustion and ventilation air and venting and connections to piping systems.

**101.2.4 Systems and equipment outside the scope.** This code shall not apply to the following:

- 1. Portable LP-gas equipment of all types that is not connected to a fixed fuel piping system.**
- 2. Oxygen-fuel gas cutting and welding systems.**
- 3. Industrial gas applications using gases such as acetylene and acetylenic compounds, hydrogen, ammonia, carbon monoxide, oxygen and nitrogen.**
- 4. Petroleum refineries, pipeline compressor or pumping stations, loading terminals, compounding plants, refinery tank farms and natural gas processing plants.**
- 5. Integrated chemical plants or portions of such plants where flammable or combustible liquids or gases are produced by, or used in, chemical reactions.**
- 6. LP-gas installations at utility gas plants.**

7. Liquefied natural gas (LNG) installations.
8. Fuel gas piping in power and atomic energy plants.
9. Components within proprietary items of equipment, apparatus or instruments such as gas-generating sets, compressors and calorimeters.
10. LP-gas equipment for vaporization, gas mixing and gas manufacturing.
11. Temporary LP-gas piping for buildings under construction or renovation that is not to become part of the permanent piping system.
12. Installation of LP-gas systems for railroad switch heating.
13. Installation of hydrogen gas, LP-gas and compressed natural gas (CNG) systems on vehicles.
14. Except as provided in Section 401.1.1 and Appendices E and F, gas piping, meters, gas pressure regulators and other appurtenances used by the serving gas supplier in the distribution of gas, other than undiluted LP-gas.
15. Building design and construction, except as specified herein.
16. Piping systems for mixtures of gas and air within the flammable range with an operating pressure greater than 10 psig (69 kPa gauge).
17. Portable fuel cell appliances that are neither connected to a fixed piping system nor interconnected to a power grid.

**101.2.5 Other fuels.** The requirements for the design, installation, maintenance, alteration and inspection of mechanical systems operating with fuels other than fuel gas shall be regulated by the *New York City Mechanical Code*.

**101.3 Reserved.**

**101.4 Intent.** The purpose of this code is to provide minimum standards to safeguard life or limb, health, property and public welfare by regulating and controlling the design, construction, installation, quality of materials, location, operation and maintenance or use of fuel gas systems.

**101.5 Severability.** If a section, subsection, sentence, clause or phrase of this code is, for any reason, held to be unconstitutional, such decision shall not affect the validity of the remaining portions of this code.

**SECTION FGC 102**  
**APPLICABILITY**

**102.1 General.** The provisions of this code shall apply to all matters affecting or relating to structures and premises, as set forth in Section 101. Where, in a specific case, different sections of this code specify different materials, methods of construction or other requirements, the most restrictive shall govern.

**102.2 Existing installations.** Except as otherwise provided for in this chapter or elsewhere in this code, a provision in this code shall not require the removal, alteration or abandonment of, nor prevent the continued utilization and maintenance of, existing installations lawfully in existence on the effective date of this code.

**102.2.1 Existing buildings.** Additions, alterations, renovations or repairs related to building or structural issues shall be governed by Chapter 1 of Title 28 of the *Administrative code, the New York City Building Code and the 1968 building code, as applicable.*

**102.3 Maintenance.** Installations, both existing and new, and parts thereof shall be maintained in proper operating condition in accordance with the original design and in a safe condition. Devices or safeguards that are required by this code shall be maintained in compliance with the applicable provisions under which they were installed. The owner or the owner's designated agent shall be responsible for maintenance of installations. To determine compliance with this provision, the commissioner shall have the authority to require an existing installation to be inspected.

**102.4 Additions, alterations or repairs.** Additions, alterations, renovations or repairs to installations shall conform to that required for new installations without requiring the existing installation to comply with all of the requirements of this code. Additions, alterations or repairs shall not cause an existing installation to become unsafe, hazardous or overloaded. Minor additions, alterations, renovations and repairs to existing installations shall meet the provisions for new construction, unless such work is done in the same manner and arrangement as was in the existing system, is not hazardous and is approved.

**102.5 Change in occupancy.** Refer to Chapter 1 of Title 28 of the *Administrative Code.*

**102.6 Reserved.**

**102.7 Reserved.**

**102.8 Referenced standards.** The standards referenced in this code shall be those that are listed in Chapter 8 and in the rules of the department and such standards shall be considered part of the requirements of this code to the prescribed extent of each such reference. Where differences occur between provisions of this code and the referenced standards, the provisions of this code shall apply. Refer to Article 103 of chapter 1 of Title 28 of the *Administrative Code* for additional provisions relating to referenced standards.

**102.9 Requirements not covered by code.** Requirements necessary for the strength, stability or proper operation of an existing or proposed installation, or for the public safety, health and general welfare, not specifically covered by this code, shall be determined by the commissioner.

**SECTION FGC 103**  
**DEPARTMENT OF BUILDINGS**

**103.1 Enforcement agency.** Refer to the New York City Charter and Chapter 1 of Title 28 of the *Administrative Code*.

**103.2 Reserved.**

**103.3 Reserved.**

**103.4 Reserved.**

**SECTION FGC 104**  
**DUTIES AND POWERS OF THE COMMISSIONER OF BUILDINGS**

**104.1 General.** The commissioner shall have the authority to render interpretations and to adopt rules establishing policies, and procedures to clarify and implement the provisions of this code. Such interpretations and rules shall be in compliance with the intent and purpose of this code. See the New York City Charter and Chapter 1 of Title 28 of the *Administrative Code* for additional provisions relating to the authority of the Commissioner of Buildings.

**SECTION FGC 105**  
**PERMITS**

**105.1 General.** Permits shall comply with this section, with Article 105 of Chapter 1 of Title 28 of the *Administrative Code*, and with requirements found elsewhere in this code.

**105.2 Required.** Any owner or authorized agent who intends to construct, add to, alter, repair, move, demolish, or change the occupancy of a building or structure, or to erect, install, add to, alter, repair, remove, convert or replace any gas, mechanical or plumbing system, the installation of which is regulated by this code, or to cause any such work to be done, shall first make application for construction document approval in accordance with Chapter 1 of Title 28 of the *Administrative Code* and this chapter and obtain the required permit.

**105.3 Work exempt from permit.** Exemptions from permit requirements of this code as authorized in Chapter 1 of Title 28 of the *Administrative Code* and the rules of the department shall not be deemed to grant authorization for any work to be done in any manner in violation of the provisions of this code or any other laws or rules.

**105.4 Validity of permit.** The issuance or granting of a permit shall not be construed to be a permit for, or an approval of, any violation of any of the provisions of this code or of any other law. Permits presuming to give authority to violate or cancel the provisions of this code or other law shall not be valid. The issuance of a permit based on construction documents and other data shall not prevent the commissioner from requiring the correction of errors in the construction documents and other data. The commissioner is also authorized to prevent occupancy or use of a structure where in violation of this code or of any other law.



**SECTION FGC 106**  
**CONSTRUCTION DOCUMENTS**

**106.1 General.** Construction documents shall comply with Article 104 of Chapter 1 of Title 28 of the *Administrative Code* and other applicable provisions of this code and its referenced standards. Such construction documents shall be coordinated with architectural, structural and means of egress plans.

**106.2 Required documents.** The applicant shall submit all of the documents specified in Sections 106.3 through 106.8 as appropriate to the nature and extent of the work proposed. Construction documents shall indicate the heating, ventilating, refrigeration, and other mechanical work to be performed, so drawn as to conform to the architectural and structural aspects of the building and to show in detail compliance with this code.

**106.2.1 Composite plans.** Composite plans showing compliance of architectural, structural, and mechanical parts of a building may be submitted provided that a clear understanding of each part is not impaired.

**106.3 Lot diagram.** The lot diagram shall be provided where applicable to the work proposed, including but not limited to the installation of exterior or rooftop equipment.

**106.4 Building classification statement.** Where applicable to the proposed work, the statement shall identify:

1. The occupancy group or groups that apply to parts of the building in accordance with Section 302 of the *New York City Building Code*;
2. The occupancy group of the main use or dominant occupancy of the building in accordance with Section 302.1 of the *New York City Building Code*;
3. The construction class of the building in accordance with Section 602 of the *New York City Building Code*;
4. The structure category in accordance with Table 1604.5 of the *New York City Building Code*;
5. The height of the building as defined in Section 502.1 of the *New York City Building Code*;
6. The applicable measurements to the highest and lowest level of fire department access; and
7. Whether the building is inside or outside of the fire districts.

**106.5 Fuel-gas-burning equipment and fuel-gas piping plans.** Construction documents for fuel-gas-burning equipment and fuel-gas piping shall contain plans that include the following data and information.

1. Riser diagrams showing the story heights, the gas risers, and related equipment.
2. Diagrammatic floor plans showing the size, location, material for all gas distribution piping and related equipment.
3. Floor plans or partial floor plans showing the location, layout, size, and listing information for all fuel-gas burning equipment, gas vents, and chimneys, with the riser numbers coordinated with other plans and diagrams. The floor plans shall indicate locations of meters, shut-off valves, including the outside gas cut-off required by Appendix E, Section E6. The plans shall also indicate the method or means of providing air to the equipment space, including duct and opening sizes.
4. Plans indicating the location and type of any relevant smoke and heat detectors, alarm, and fire extinguishing systems.
5. Seismic protection and restraint details for piping and equipment as required by Chapter 16 of the *New York City Building Code*.
6. Details indicating the location, size and materials for all breechings; the thickness and type of insulation materials; and the clearances from combustible walls, partitions, and ceiling; and the fire-resistive ratings of rooms and spaces containing the equipment.
7. Details describing the type, material, listing information, height, and termination distances to adjacent properties and structures for chimneys and gas vents.
8. Details showing structural supports for fuel-gas-burning equipment where required.
9. In areas of special flood hazards, construction documents shall comply with Appendix G of the *New York City Building Code*.

**106.6 Heating systems.** Construction documents for heating systems shall include the temperature to be maintained in every room and the output capacity in BTU per hour (0.2931 W) of the central heating source.

**106.7 Boilers.** Construction documents for boiler installations shall indicate the output capacity in BTU per hour, the operating weight of each boiler, the pressure setting of the relief valves, and such other data and information as required this code.

**106.8 Energy efficiency.** Construction documents shall include a statement by the registered design professional of record that: “To the best of my knowledge, belief and professional judgment, these plans and specifications are in compliance with the *Energy Conservation Construction Code of New York State*.” In addition, the following requirements shall apply:

1. A lead energy professional shall be identified for each project, who shall draw the relevant information regarding envelope, mechanical systems, service water heating system and

lighting and power systems from construction documents into an energy analysis. The energy analysis shall balance total energy consumption of all systems in accordance with the *Energy Conservation Construction Code of New York State* and shall be signed and sealed by the lead energy professional.

2. The format for the energy analysis shall be as established in the *Energy Conservation Construction Code of New York State*, or as approved by the department, and shall comprise a sheet within the drawing set. Supporting documentation shall be available within the drawing set or upon request of the department.

## **SECTION FGC 107 (IFGC)** **INSPECTIONS AND TESTING**

**107.1 General.** Except as otherwise specifically provided, inspections required by this code or by the department during the progress of work may be performed on behalf of the owner by approved agencies or, if applicable, by special inspectors. However, in the interest of public safety, the commissioner may direct that any of such inspections be performed by the department. All inspections shall be performed at the sole cost and expense of the owner. Refer to Article 116 of Chapter 1 of Title 28 of the *Administrative Code* for additional provisions relating to inspections. In addition to any inspections otherwise required by this code or applicable rules, the following inspections shall be required:

1. Progress inspections:

- 1.1. Underground inspection shall be made after trenches or ditches are excavated and bedded, piping is installed and before backfill is put in place. When excavated soil contains rocks, broken concrete, frozen chunks and other rubble that would damage or break the piping or cause corrosive action, clean backfill shall be on the job site.

- 1.2. Rough-in inspection shall be made after the roof, framing, fireblocking and bracing are in place and components to be concealed are complete, and prior to the installation of wall or ceiling membranes.

2. Special inspections. Special inspections shall be performed in accordance with this code and Chapter 17 of the *New York City Building Code*.

3. Final inspection. Refer to Article 116 of Chapter 1 of Title 28 of the *Administrative Code*.

4. Issuance of Certificate of Compliance. Upon satisfactory inspection of service equipment and the project satisfied all the requirements for sign-off, the department shall issue certificate of compliance as applicable for the following service equipment:

- 4.1. Fuel-gas-burning equipment,

- 4.2. Heating systems, and

#### 4.3. Boilers.

**107.1.1 Approved inspection agencies.** Refer to Articles 114 and 115 of Chapter 1 of Title 28 of the *Administrative Code*.

**107.1.2 Inspection of prefabricated construction assemblies.** Prior to the approval of a prefabricated construction assembly having concealed work and the issuance of a permit, the department shall require the submittal of an evaluation report by an approved agency on each prefabricated construction assembly, indicating the complete details of the installation, including a description of the system and its components, the basis upon which the system is being evaluated, test results and similar information and other data as necessary for the commissioner to determine conformance to this code.

**107.1.2.1 Test and inspection records.** Required test and inspection records shall be available to the commissioner at all times during the fabrication of the installation and the erection of the building; or such records as the commissioner designates shall be filed.

**107.2 Testing.** Installations shall be tested as required in this code and in accordance with Sections 107.2.1 through 107.2.3. Tests shall be made by the permit holder and witnessed by the department or an approved agency.

**107.2.1 New, altered, extended or repaired installations.** New installations and parts of existing installations that have been altered, extended, renovated or repaired, shall be tested as prescribed herein to disclose leaks and defects.

**107.2.2 Apparatus, instruments, material and labor for tests.** Apparatus, instruments, material and labor required for testing an installation or part thereof shall be furnished by the permit holder.

**107.2.3 Reinspection and testing.** Where any work or installation does not pass an initial test or inspection, the necessary corrections shall be made so as to achieve compliance with this code. The work or installation shall then be resubmitted to the department for inspection and testing.

**107.3 Sign-off of completed work.** Refer to Article 116 of Chapter 1 of Title 28 of the *Administrative Code*.

**107.4 Temporary connection.** The commissioner shall have the authority to allow the temporary connection of an installation to the sources of energy for the purpose of testing the installation or for use under a temporary certificate of occupancy.

### **SECTION FGC 108** **VIOLATIONS**

**108.1 General.** Refer to Chapters 2 and 3 of Title 28 of the *Administrative Code*.

**108.2 Authority to disconnect service utilities.** The commissioner shall have the authority to require disconnection of utility service to the building, structure or system regulated by the technical codes in case of emergency where necessary to eliminate an immediate hazard to life or property. The commissioner shall notify the serving utility, and wherever possible, the owner and occupant of the building, structure or service system of the decision to disconnect prior to taking such action. If not notified prior to disconnection, the owner or occupant of the building, structure or service system shall be notified in writing, as soon as practicable thereafter.

**108.3 Connection after order to disconnect.** A person shall not make energy source connections to installations regulated by this code that have been disconnected or ordered to be disconnected by the commissioner, or the use of which has been ordered to be discontinued by the commissioner until the commissioner authorizes the reconnection and use of such installations. When an installation is maintained in violation of this code, and in violation of a notice issued pursuant to the provisions of this section, the commissioner shall institute appropriate action to prevent, restrain, correct or abate the violation.

## **CHAPTER 2** **DEFINITIONS**

### **SECTION FGC 201** **GENERAL**

**201.1 Scope.** Unless otherwise expressly stated, the following words and terms shall, for the purposes of this code and standard, have the meanings indicated in this chapter.

**201.2 Interchangeability.** Words used in the present tense include the future; words in the masculine gender include the feminine and neuter; the singular number includes the plural and the plural, the singular.

**201.3 Terms defined in other codes.** Where terms are not defined in this code and are defined in the *New York City Electrical Code*, *New York City Building Code*, *New York City Fire Code*, *New York City Mechanical Code* or *New York City Plumbing Code*, such terms shall have meanings ascribed to them as in those codes.

**201.4 Terms not defined.** Where terms are not defined through the methods authorized by this section, such terms shall have ordinarily accepted meanings such as the context implies.

### **SECTION FGC 202** **GENERAL DEFINITIONS**

**ACCESS (TO).** That which enables a device, appliance or equipment to be reached by ready access or by a means that first requires the removal or movement of a panel, door or similar obstruction (see also “Ready access”).

**AIR CONDITIONER, GAS-FIRED.** A gas-burning, automatically operated appliance for supplying cooled and/or dehumidified air or chilled liquid.

**ADMINISTRATIVE CODE.** *The Administrative Code of the City of New York.*

**AIR CONDITIONING.** The treatment of air so as to control simultaneously the temperature, humidity, cleanness and distribution of the air to meet the requirements of a conditioned space.

**AIR, EXHAUST.** Air being removed from any space or piece of equipment and conveyed directly to the atmosphere by means of openings or ducts.

**AIR-HANDLING UNIT.** A blower or fan used for the purpose of distributing supply air to a room, space or area.

**AIR, MAKEUP.** Air that is provided to replace air being exhausted.

**ALTERATION.** Any construction, addition, change of use or occupancy, or renovation to a building or structure in existence. See Section 28-101.5 of the *Administrative Code*.

**ANODELESS RISER.** A transition assembly in which plastic piping is installed and terminated above ground outside of a building.

**APPLIANCE (EQUIPMENT).** Any apparatus or equipment that utilizes gas as a fuel or raw material to produce light, heat, power, refrigeration or air conditioning.

**APPLIANCE, FAN-ASSISTED COMBUSTION.** An appliance equipped with an integral mechanical means to either draw or force products of combustion through the combustion chamber or heat exchanger.

**APPLIANCE, AUTOMATICALLY CONTROLLED.** Appliances equipped with an automatic burner ignition and safety shutoff device and other automatic devices which accomplish complete turn-on and shutoff of the gas to the main burner or burners, and graduate the gas supply to the burner or burners, but do not affect complete shutoff of the gas.

**APPLIANCE TYPE.**

**Low-heat appliance (residential appliance).** Any appliance in which the products of combustion at the point of entrance to the flue under normal operating conditions have a temperature of 1,000°F (538°C) or less.

**Medium-heat appliance.** Any appliance in which the products of combustion at the point of entrance to the flue under normal operating conditions have a temperature of more than 1,000°F (538°C), but not greater than 2,000°F (1093°C).

**APPLIANCE, UNVENTED.** An appliance designed or installed in such a manner that the products of combustion are not conveyed by a vent or chimney directly to the outside atmosphere.

**APPLIANCE, VENTED.** An appliance designed and installed in such a manner that all of the products of combustion are conveyed directly from the appliance to the outside atmosphere

through an approved chimney or vent system.

**APPROVED.** Acceptable to the commissioner. In reference to construction documents, the determination by the department after full examination that submitted construction documents comply with this code and other applicable laws and rules. In reference to materials, the determination by the commissioner that material is acceptable for its intended use. See Section 28-101.5 of the *Administrative Code*.

**APPROVED AGENCY.** An established and recognized agency, or other qualified person, regularly engaged in conducting tests or furnishing inspection services, when approved pursuant to department rules as qualified to perform or witness identified testing or inspection services. See Chapter 1 of Title 28 of the *Administrative Code*.

**APPROVED INSPECTION AGENCY.** An approved agency that is approved by the department as qualified to perform one or more of the inspections required by this code. See Chapter 1 of Title 28 of the *Administrative Code*.

**APPROVED TESTING AGENCY.** An approved agency that is approved by the department as qualified to test and evaluate the performance of one or more of the materials regulated in their use by this code. Such term shall include, when approved pursuant to department rules, a third party testing or certification agency, evaluation agency, testing laboratory, testing service or other entity concerned with product evaluation. See Chapter 1 of Title 28 of the *Administrative Code*.

**ARCHITECT.** A person licensed and registered to practice the profession of architecture under the Education Law of the state of New York.

**ATMOSPHERIC PRESSURE.** The pressure of the weight of air and water vapor on the surface of the earth, approximately 14.7 pounds per square inch (psi) (101 kPa absolute) at sea level.

**AUTOMATIC IGNITION.** Ignition of gas at the burner(s) when the gas controlling device is turned on, including reignition if the flames on the burner(s) have been extinguished by means other than by the closing of the gas controlling device.

**BAFFLE.** An object placed in an appliance to change the direction of or retard the flow of air, air-gas mixtures or flue gases.

**BAROMETRIC DRAFT REGULATOR.** A balanced damper device attached to a chimney, vent connector, breeching or flue gas manifold to protect combustion equipment by controlling chimney draft. A double-acting barometric draft regulator is one in which the balancing damper is free to move in either direction to protect combustion equipment from both excessive draft and backdraft.

**BOILER, HIGH-PRESSURE.** An appliance (equipment) for supplying steam or hot water that, for a steam boiler, operates at a pressure of more than 15 psig (103 kPa gauge), and for a hot water boiler, operates at a pressure exceeding 150 psig (1034 kPa gauge) or at a temperature exceeding 250°F (121°C).

**BOILER, LOW-PRESSURE.** A self-contained appliance for supplying steam or hot water as follows:

**Hot water heating boiler.** A boiler in which no steam is generated, from which hot water is circulated for heating purposes and then returned to the boiler, and that operates at water pressures not exceeding 160 pounds per square inch gauge (psig) (1100 kPa gauge) and at water temperatures not exceeding 250°F (121°C) at or near the boiler outlet.

**Hot water supply boiler.** A boiler, completely filled with water, which furnishes hot water to be used externally to itself, and that operates at water pressures not exceeding 160 psig (1100 kPa gauge) and at water temperatures not exceeding 250°F (121°C) at or near the boiler outlet.

**Steam heating boiler.** A boiler in which steam is generated and that operates at a steam pressure not exceeding 15 psig (103 kPa gauge).

**BRAZING.** A metal-joining process wherein coalescence is produced by the use of a nonferrous filler metal having a melting point above 1,000°F (538°C), but lower than that of the base metal being joined. The filler material is distributed between the closely fitted surfaces of the joint by capillary action.

**BROILER.** A general term including salamanders, barbecues and other appliances cooking primarily by radiated heat, excepting toasters.

**BTU.** Abbreviation for British Thermal Unit, which is the quantity of heat required to raise the temperature of 1 pound (454 g) of water 1°F (1.8°C) (1 Btu = 1055 J).

**BURNER.** A device for the final conveyance of the gas, or a mixture of gas and air, to the combustion zone.

**Induced-draft.** A burner that depends on draft induced by a fan that is an integral part of the appliance and is located downstream from the burner.

**Power.** A burner in which gas, air or both are supplied at pressures exceeding, for gas, the line pressure, and for air, atmospheric pressure, with this added pressure being applied at the burner.

**CHIMNEY.** A primarily vertical structure containing one or more flues, for the purpose of carrying gaseous products of combustion and air from a fuel-burning appliance to the outside atmosphere.

**Factory-built chimney.** A listed and labeled chimney composed of factory-made components, assembled in the field in accordance with manufacturer's instructions and the conditions of the listing.

**Masonry chimney.** A field-constructed chimney composed of solid masonry units, bricks,



stones or concrete.

**Metal chimney.** A field-constructed chimney of metal.

**CLEARANCE.** The minimum distance through air measured between the heat-producing surface of the mechanical appliance, device or equipment and the surface of the combustible material or assembly.

**CLOTHES DRYER.** An appliance used to dry wet laundry by means of heated air. Dryer classifications are as follows:

**Type 1.** Factory-built package, multiple production. Primarily used in family living environment. Usually the smallest unit physically and in function output.

**Type 2.** Factory-built package, multiple production. Used in business with direct intercourse of the function with the public. Not designed for use in individual family living environment.

**COMBUSTION.** In the context of this code, refers to the rapid oxidation of fuel accompanied by the production of heat or heat and light.

**COMBUSTION AIR.** Air necessary for complete combustion of a fuel, including theoretical air and excess air.

**COMBUSTION CHAMBER.** The portion of an appliance within which combustion occurs.

**COMBUSTION PRODUCTS.** Constituents resulting from the combustion of a fuel with the oxygen of the air, including inert gases, but excluding excess air.

**COMMISSIONER.** The Commissioner of Buildings of the City of New York or his or her duly authorized representative. See Section 28-101.5 of the *Administrative Code*.

**CONCEALED LOCATION.** A location that cannot be accessed without damaging permanent parts of the building structure or finished surface. Spaces above, below or behind readily removable panels or doors shall not be considered as concealed.

**CONCEALED PIPING.** Piping that is located in a concealed location (see “Concealed Location”).

**CONDENSATE.** The liquid that condenses from a gas (including flue gas) caused by a reduction in temperature or increase in pressure.

**CONNECTOR.** The pipe that connects an approved appliance to a chimney, flue or vent.

**CONSTRUCTION DOCUMENTS.** Plans and specifications and other written, graphic and pictorial documents, prepared or assembled for describing the design, location and physical characteristics of the elements of the project necessary for obtaining a building permit. See Section

28-101.5 of the Administrative Code.

**CONTROL.** A manual or automatic device designed to regulate the gas, air, water or electrical supply to, or operation of, a mechanical system.

**CONVERSION BURNER.** A unit consisting of a burner and its controls for installation in an appliance originally utilizing another fuel.

**COUNTER APPLIANCES.** Appliances such as coffee brewers and coffee urns and any appurtenant water-heating equipment, food and dish warmers, hot plates, griddles, waffle bakers and other appliances designed for installation on or in a counter.

**CUBIC FOOT.** The amount of gas that occupies 1 cubic foot (0.02832 m<sup>3</sup>) when at a temperature of 60°F (16°C), saturated with water vapor and under a pressure equivalent to that of 30 inches of mercury (101 kPa).

**DAMPER.** A manually or automatically controlled device to regulate draft or the rate of flow of air or combustion gases.

**DECORATIVE APPLIANCE, VENTED.** A vented appliance wherein the primary function lies in the aesthetic effect of the flames.

**DECORATIVE APPLIANCES FOR INSTALLATION IN VENTED FIREPLACES.** A vented appliance designed for installation within the fire chamber of a vented fireplace, wherein the primary function lies in the aesthetic effect of the flames.

**DEMAND.** The maximum amount of gas input required per unit of time, usually expressed in cubic feet per hour, or Btu/h (1 Btu/h = 0.2931 W).

**DILUTION AIR.** Air that is introduced into a draft hood and is mixed with the flue gases.

**DIRECT-VENT APPLIANCES.** Appliances that are constructed and installed so that all air for combustion is derived directly from the outside atmosphere and all flue gases are discharged directly to the outside atmosphere.

**DRAFT.** The pressure difference existing between the equipment or any component part and the atmosphere, that causes a continuous flow of air and products of combustion through the gas passages of the appliance to the atmosphere.

**Mechanical or induced draft.** The pressure difference created by the action of a fan, blower or ejector, that is located between the appliance and the chimney or vent termination.

**Natural draft.** The pressure difference created by a vent or chimney because of its height, and the temperature difference between the flue gases and the atmosphere.

**DRAFT HOOD.** A nonadjustable device built into an appliance, or made as part of the vent

connector from an appliance, that is designed to (1) provide for ready escape of the flue gases from the appliance in the event of no draft, backdraft or stoppage beyond the draft hood, (2) prevent a backdraft from entering the appliance, and (3) neutralize the effect of stack action of the chimney or gas vent upon operation of the appliance.

**DRAFT REGULATOR.** A device that functions to maintain a desired draft in the appliance by automatically reducing the draft to the desired value.

**DRIP.** A nipple and cap placed at a lowpoint in a system of piping to collect condensate and from which the condensate is removable.

**DRY GAS.** A gas having a moisture and hydrocarbon dew point below any normal temperature to which the gas piping is exposed.

**DUCT FURNACE.** A warm-air furnace normally installed in an air distribution duct to supply warm air for heating. This definition shall apply only to a warm-air heating appliance that depends for air circulation on a blower not furnished as part of the furnace.

**DUCT SYSTEM.** A continuous passageway for the transmission air that, in addition to ducts, includes duct fittings, dampers, plenums, fans and accessory air-handling equipment, and appliances.

**ENGINEER.** A person licensed and registered to practice the profession of engineering under the Education Law of the State of New York.

**EQUIPMENT.** See “Appliance.”

**FIREPLACE.** A fire chamber and hearth constructed of noncombustible material for use with solid fuels and provided with a chimney.

**Masonry fireplace.** A hearth and fire chamber of solid masonry units such as bricks, stones, listed masonry units or reinforced concrete, provided with a suitable chimney.

**Factory-built fireplace.** A fireplace composed of listed factory-built components assembled in accordance with the terms of listing to form the completed fireplace.

**FIRING VALVE.** A valve of the plug and barrel type designed for use with gas, and equipped with a lever handle for manual operation and a dial to indicate the percentage of opening.

**FLAME SAFEGUARD.** A device that will automatically shut off the fuel supply to a main burner or group of burners when the means of ignition of such burners becomes inoperative, and when flame failure occurs on the burner or group of burners.

**FLOOR FURNACE.** A completely self-contained furnace suspended from the floor of the space being heated, taking air for combustion from outside such space and with means for observing flames and lighting the appliance from such space.

**Gravity type.** A floor furnace depending primarily upon circulation of air by gravity. This classification shall also include floor furnaces equipped with booster-type fans which do not materially restrict free circulation of air by gravity flow when such fans are not in operation.

**Fan type.** A floor furnace equipped with a fan which provides the primary means for circulating air.

**FLUE.** A passageway within a chimney or vent through which gaseous combustion products pass.

**FLUE, APPLIANCE.** The passage(s) within an appliance through which combustion products pass from the combustion chamber of the appliance to the draft hood inlet opening on an appliance equipped with a draft hood or to the outlet of the appliance on an appliance not equipped with a draft hood.

**FLUE COLLAR.** That portion of an appliance designed for the attachment of a draft hood, vent connector or venting system.

**FLUE GASES.** Products of combustion plus excess air in appliance flues or heat exchangers.

**FLUE LINER (LINING).** A system or material used to form the inside surface of a flue in a chimney or vent, for the purpose of protecting the surrounding structure from the effects of combustion products and for conveying combustion products without leakage into the atmosphere.

**FUEL GAS.** Fuel gases include: a natural gas, manufactured gas, liquefied petroleum gas, hydrogen gas and mixtures of these gases.

**FUEL GAS UTILIZATION EQUIPMENT.** See "Appliance."

**FURNACE.** A completely self-contained heating unit that is designed to supply heated air to spaces remote from or adjacent to the appliance location.

**FURNACE, CENTRAL.** A self-contained appliance for heating air by transfer of heat of combustion through metal to the air, and designed to supply heated air through ducts to spaces remote from or adjacent to the appliance location.

**Downflow furnace.** A furnace designed with airflow discharge vertically downward at or near the bottom of the furnace.

**Forced-air furnace with cooling unit.** A single-package unit, consisting of a gas-fired forced-air furnace of one of the types listed below combined with an electrically or fuel gas-powered summer air-conditioning system, contained in a common casing.

**Forced-air type.** A central furnace equipped with a fan or blower which provides the primary means for circulation of air.

**Gravity furnace with booster fan.** A furnace equipped with a booster fan that does not materially restrict free circulation of air by gravity flow when the fan is not in operation.

**Gravity type.** A central furnace depending primarily on circulation of air by gravity.

**Horizontal forced-air type.** A furnace with airflow through the appliance essentially in a horizontal path.

**Multiple-position furnace.** A furnace designed so that it can be installed with the airflow discharge in the upflow, horizontal or downflow direction.

**Upflow furnace.** A furnace designed with airflow discharge vertically upward at or near the top of the furnace. This classification includes “highboy” furnaces with the blower mounted below the heating element and “lowboy” furnaces with the blower mounted beside the heating element.

**FURNACE, ENCLOSED.** A specific heating, or heating and ventilating, furnace incorporating an integral total enclosure and using only outside air for combustion.

**FURNACE PLENUM.** An air compartment or chamber to which one or more ducts are connected and which forms part of an air distribution system.

**GAS CONVENIENCE OUTLET.** A permanently mounted, manually operated device that provides the means for connecting an appliance to, and disconnecting an appliance from, the supply piping. The device includes an integral, manually operated valve with a nondisplaceable valve member and is designed so that disconnection of an appliance only occurs when the manually operated valve is in the closed position.

**GAS PIPING.** An installation of pipe, valves or fittings installed on a premises or in a building and utilized to convey fuel gas.

**GAS UTILIZATION EQUIPMENT.** An appliance that utilizes gas as a fuel or raw material or both.

**HAZARDOUS LOCATION.** Any location considered to be a fire hazard for flammable vapors, dust, combustible fibers or other highly combustible substances. The location is not necessarily categorized in the *New York City Building Code* as a high-hazard group classification.

**HOUSE PIPING.** See “Piping system.”

**IGNITION PILOT.** A pilot that operates during the lighting cycle and discontinues during main burner operation.

**IGNITION SOURCE.** A flame, spark or hot surface capable of igniting flammable vapors or fumes. Such sources include appliance burners, burner ignitors, and electrical switching devices.

**INCINERATOR.** An appliance used to reduce combustible refuse material to ashes and which is manufactured, sold and installed as a complete unit.

**INDUSTRIAL AIR HEATERS, DIRECT-FIRED NONRECIRCULATING.** A heater in which all the products of combustion generated by the burners are released into the air stream being heated. The purpose of the heater is to offset building heat loss by heating only outdoor air.

**INDUSTRIAL AIR HEATERS, DIRECT-FIRED RECIRCULATING.**

A heater in which all the products of combustion generated by the burners are released into the air stream being heated. The purpose of the heater is to offset building heat loss by heating outdoor air, and, if applicable, indoor air.

**INFRARED RADIANT HEATER.** A heater that directs a substantial amount of its energy output in the form of infrared radiant energy into the area to be heated. Such heaters are of either the vented or unvented type.

**JOINT, FLANGED.** A joint made by bolting together a pair of flanged ends.

**JOINT, FLARED.** A metal-to-metal compression joint in which a conical spread is made on the end of a tube that is compressed by a flare nut against a mating flare.

**JOINT, MECHANICAL.** A general form of gas-tight joints obtained by the joining of metal parts through a positive-holding mechanical construction, such as flanged joint, threaded joint, flared joint or compression joint.

**JOINT, PLASTIC ADHESIVE.** A joint made in thermoset plastic piping by the use of an adhesive substance which forms a continuous bond between the mating surfaces without dissolving either one of them.

**JOINT, PLASTIC HEAT FUSION.** A joint made in thermoplastic piping by heating the parts sufficiently to permit fusion of the materials when the parts are pressed together.

**JOINT, WELDED.** A gas-tight joint obtained by the joining of metal parts in molten state.

**LABELED.** Material to which has been attached a label, symbol or other identifying mark of the manufacturer that contains the name of the manufacturer, the function and performance characteristics of the product or material, and the name and identification of an approved agency and that indicates that a representative sample of the material has been tested and evaluated by an approved agency for compliance with nationally recognized standards or tests to determine suitable usage in a specified manner. See Section 28-101.5 of the *Administrative Code*.

**LIMIT CONTROL.** A device responsive to changes in pressure, temperature or level for turning on, shutting off or throttling the gas supply to an appliance.

**LIQUEFIED PETROLEUM GAS or LPG (LP-GAS).** Liquefied petroleum gas composed predominately of propane, propylene, butanes or butylenes, or mixtures thereof that is gaseous

under normal atmospheric conditions, but is capable of being liquefied under moderate pressure at normal temperatures.

**LISTED.** Material identified in a list published by an approved agency that maintains periodic inspection of production of listed material or periodic evaluation services and whose listing states either that the material meets identified nationally recognized standards or has been tested and found suitable for a specified purpose when installed in accordance with the manufacturer's installation instructions. See Section 28-101.5 of the *Administrative Code*.

**LIVING SPACE.** Space within a dwelling unit utilized for living, sleeping, eating, cooking, bathing, washing and sanitation purposes.

**LOG LIGHTER.** A manually operated solid fuel ignition appliance for installation in a vented solid fuel-burning fireplace.

**LUBRICATED PLUG-TYPE VALVE.** A valve of the plug and barrel type provided with means for maintaining a lubricant between the bearing surfaces.

**MAIN BURNER.** A device or group of devices essentially forming an integral unit for the final conveyance of gas or a mixture of gas and air to the combustion zone, and in which combustion takes place to accomplish the function for which the appliance is designed.

**MECHANICAL EXHAUST SYSTEM.** Equipment installed in and made a part of the vent, which will provide a positive induced draft.

**METER.** The instrument installed to measure the volume of gas delivered through it.

**MODULATING.** Modulating or throttling is the action of a control from its maximum to minimum position in either predetermined steps or increments of movement as caused by its actuating medium.

**MP REGULATOR.** A medium pressure gas regulator, the capacity of which shall be determined by the manufacturer.

**NPS.** An abbreviation for nominal pipe size.

**OCCUPANCY.** The purpose or activity for which a building or space is used or is designed, arranged or intended to be used.

**OFFSET (VENT).** A combination of approved bends that makes two changes in direction bringing one section of the vent out of line but into a line parallel with the other section.

**ORIFICE.** The opening in a cap, spud or other device whereby the flow of gas is limited and through which the gas is discharged to the burner.

**OUTLET.** A threaded connection or bolted flange in a pipe system to which a gas-burning

appliance is attached.

**OXYGEN DEPLETION SAFETY SHUTOFF SYSTEM (ODS).** A system designed to act to shut off the gas supply to the main and pilot burners if the oxygen in the surrounding atmosphere is reduced below a predetermined level.

**PILOT.** A small flame that is utilized to ignite the gas at the main burner or burners.

**PIPING.** Where used in this code, “piping” refers to either pipe or tubing, or both.

**Pipe.** A rigid conduit of iron, steel, copper, brass or plastic.

**Tubing.** Semirigid conduit of copper, aluminum, plastic or steel.

**PIPING SYSTEM.** All fuel piping, valves and fittings from the outlet of the point of delivery to the outlets of the equipment shutoff valves.

**PLASTIC, THERMOPLASTIC.** A plastic that is capable of being repeatedly softened by increase of temperature and hardened by decrease of temperature.

**POINT OF DELIVERY.** For natural gas systems, the point of delivery is the outlet of the service meter assembly, or the outlet of the service regulator or service shutoff valve where a meter is not provided. Where a valve is provided at the outlet of the service meter assembly, such valve shall be considered to be downstream of the point of delivery. For undiluted liquefied petroleum gas systems, the point of delivery shall be considered the outlet of the first-stage pressure regulator that provides utilization pressure, exclusive of line gas regulators.

**PORTABLE FUEL CELL APPLIANCE.** A fuel cell generator of electricity, which is not fixed in place. A portable fuel cell appliance utilizes a cord and plug connection to a grid-isolated load and has an integral fuel supply.

**PRESSURE DROP.** The loss in pressure due to friction or obstruction in pipes, valves, fittings, regulators and burners.

**PRESSURE TEST.** An operation performed to verify the gas-tight integrity of gas piping following its installation or modification.

**PURGE.** To free a gas conduit of air or gas, or a mixture of gas and air.

**QUICK-DISCONNECT DEVICE.** A hand-operated device that provides a means for connecting and disconnecting an appliance or an appliance connector to a gas supply and that is equipped with an automatic means to shut off the gas supply when the device is disconnected.

**READY ACCESS (TO).** That which enables a device, appliance or equipment to be directly reached, without requiring the removal or movement of any panel, door or similar obstruction (see “Access”).



**REGISTERED DESIGN PROFESSIONAL.** An architect or engineer.

**REGISTERED DESIGN PROFESSIONAL OF RECORD.** The registered design professional who prepared or supervised the preparation of applicable construction documents filed with the department.

**REGULATOR.** A device for controlling and maintaining a uniform supply pressure, either pounds-to-inches water column (MP regulator) or inches-to-inches water column (appliance regulator).

**REGULATOR, GAS APPLIANCE.** A pressure regulator for controlling pressure to the manifold of equipment. Types of appliance regulators are as follows:

**Adjustable.**

1. Spring type, limited adjustment. A regulator in which the regulating force acting upon the diaphragm is derived principally from a spring, the loading of which is adjustable over a range of not more than 15 percent of the outlet pressure at the midpoint of the adjustment range.
2. Spring type, standard adjustment. A regulator in which the regulating force acting upon the diaphragm is derived principally from a spring, the loading of which is adjustable. The adjustment means shall be concealed.

**Multistage.** A regulator for use with a single gas whose adjustment means is capable of being positioned manually or automatically to two or more predetermined outlet pressure settings. Each of these settings shall be adjustable or nonadjustable. The regulator may modulate outlet pressures automatically between its maximum and minimum predetermined outlet pressure settings.

**Nonadjustable.**

1. Spring type, nonadjustable. A regulator in which the regulating force acting upon the diaphragm is derived principally from a spring, the loading of which is not field adjustable.
2. Weight type. A regulator in which the regulating force acting upon the diaphragm is derived from a weight or combination of weights.

**REGULATOR, LINE GAS PRESSURE.** A device placed in a gas line between the service pressure regulator and the equipment for controlling, maintaining or reducing the pressure in that portion of the piping system downstream of the device.

**REGULATOR, MEDIUM-PRESSURE.** A medium-pressure (MP) regulator reduces the gas piping pressure to the appliance regulator or to the appliance utilization pressure.

**REGULATOR, PRESSURE.** A device placed in a gas line for reducing, controlling and maintaining the pressure in that portion of the piping system downstream of the device.

**REGULATOR, SERVICE PRESSURE.** A device installed by the serving gas supplier to reduce and limit the service line pressure to delivery pressure.

**RELIEF OPENING.** The opening provided in a draft hood to permit the ready escape to the atmosphere of the flue products from the draft hood in the event of no draft, back draft, or stoppage beyond the draft hood, and to permit air into the draft hood in the event of a strong chimney updraft.

**RELIEF VALVE (DEVICE)** A safety valve designed to forestall the development of a dangerous condition by relieving either pressure, temperature or vacuum in the hot water supply system.

**RELIEF VALVE, PRESSURE.** An automatic valve that opens and closes a relief vent, depending on whether the pressure is above or below a predetermined value.

**RELIEF VALVE, TEMPERATURE.**

**Reseating or self-closing type.** An automatic valve that opens and closes a relief vent, depending on whether the temperature is above or below a predetermined value.

**Manual reset type.** A valve that automatically opens a relief vent at a predetermined temperature and that must be manually returned to the closed position.

**RELIEF VALVE, VACUUM.** A valve that automatically opens and closes a vent for relieving a vacuum within the hot water supply system, depending on whether the vacuum is above or below a predetermined value.

**RISER, GAS.** A vertical pipe supplying fuel gas.

**ROOM HEATER, UNVENTED.** See “Unvented room heater.”

**ROOM HEATER, VENTED.** See “Vented room heater.”

**ROOM LARGE IN COMPARISON WITH SIZE OF EQUIPMENT.** Rooms having a volume equal to at least 12 times the total volume of a furnace or air-conditioning appliance and at least 16 times the total volume of a boiler. Total volume of the appliance is determined from exterior dimensions and is to include fan compartments and burner vestibules, when used. When the actual ceiling height of a room is greater than 8 feet (2438 mm), the volume of the room is figured on the basis of a ceiling height of 8 feet (2438 mm).

**SAFETY SHUTOFF DEVICE.** See “Flame safeguard.”

**SERVICE PIPING.** All fuel gas piping, valves, and fittings upstream of the point of delivery.

**SHAFT.** An enclosed space extending through one or more stories of a building, connecting vertical openings in successive floors, or floors and the roof.

**SPECIFIC GRAVITY.** As applied to gas, specific gravity is the ratio of the weight of a given volume to that of the same volume of air, both measured under the same condition.

**STATIONARY FUEL CELL POWER PLANT.** A self-contained package or factory-matched packages which constitute an automatically operated assembly of integrated systems for generating electrical energy and recoverable thermal energy that is permanently connected and fixed in place.

### **THERMOSTAT.**

**Electric switch type.** A device that senses changes in temperature and controls electrically, by means of separate components, the flow of gas to the burner(s) to maintain selected temperatures.

**Integral gas valve type.** An automatic device, actuated by temperature changes, designed to control the gas supply to the burner(s) in order to maintain temperatures between predetermined limits, and in which the thermal actuating element is an integral part of the device.

- 1. Graduating thermostat.** A thermostat in which the motion of the valve is approximately in direct proportion to the effective motion of the thermal element induced by temperature change.
- 2. Snap-acting thermostat.** A thermostat in which the thermostatic valve travels instantly from the closed to the open position, and vice versa.

**TRANSITION FITTINGS, PLASTIC TO STEEL.** An adapter for joining plastic pipe to steel pipe. The purpose of this fitting is to provide a permanent, pressure-tight connection between two materials which cannot be joined directly one to another.

### **UNIT HEATER.**

**High-static pressure type.** A self-contained, automatically controlled, vented appliance having integral means for circulation of air against 0.2 inch (15mm H<sub>2</sub>O) or greater static pressure. Such appliance is equipped with provisions for attaching an outlet air duct and, where the appliance is for indoor installation remote from the space to be heated, is also equipped with provisions for attaching an inlet air duct.

**Low-static pressure type.** A self-contained, automatically controlled, vented appliance, intended for installation in the space to be heated without the use of ducts, having integral means for circulation of air. Such units are allowed to be equipped with louvers or face

extensions made in accordance with the manufacturer's specifications.

**UNLISTED BOILER.** A boiler not listed by a nationally recognized testing agency.

**UNVENTED ROOM HEATER.** An unvented heating appliance designed for stationary installation and utilized to provide comfort heating. Such appliance provides radiant heat or convection heat by gravity or fan circulation directly from the heater and does not utilize ducts.

**VALVE.** A device used in piping to control the gas supply to any section of a system of piping or to an appliance.

**Automatic.** An automatic or semiautomatic device consisting essentially of a valve and operator that control the gas supply to the burner(s) during operation of an appliance. The operator shall be actuated by application of gas pressure on a flexible diaphragm, by electrical means, by mechanical means, or by other approved means.

**Automatic gas shutoff.** A valve used in conjunction with an automatic gas shutoff device to shut off the gas supply to a water-heating system. It shall be constructed integrally with the gas shutoff device or shall be a separate assembly.

**Equipment shutoff.** A valve located in the piping system, used to isolate individual equipment for purposes such as service or replacement.

**Individual main burner.** A valve that controls the gas supply to an individual main burner.

**Main burner control.** A valve that controls the gas supply to the main burner manifold.

**Manual main gas-control.** A manually operated valve in the gas line for the purpose of completely turning on or shutting off the gas supply to the appliance, except to pilot or pilots that are provided with independent shutoff.

**Manual reset.** An automatic shutoff valve installed in the gas supply piping and set to shut off when unsafe conditions occur. The device remains closed until manually reopened.

**Service shutoff.** A valve, installed by the serving gas supplier between the service meter or source of supply and the customer piping system, to shut off the entire piping system.

**VENT.** A pipe or other conduit composed of factory-made components, containing a passageway for conveying combustion products and air to the atmosphere, listed and labeled for use with a specific type or class of appliance.

**Special gas vent.** A vent listed and labeled for use with listed Category II, III and IV appliances.

**Type B vent.** A vent listed and labeled for use with appliances with draft hoods and other Category I appliances that are listed for use with Type B vents.

**Type BW vent.** A vent listed and labeled for use with wall furnaces.

**Type L vent.** A vent listed and labeled for use with appliances that are listed for use with Type L or Type B vents.

**VENT CONNECTOR.** (See “Connector”).

**VENT GASES.** Products of combustion from appliances plus excess air plus dilution air in the vent connector, gas vent or chimney above the draft hood or draft regulator.

**VENTED APPLIANCE CATEGORIES.** Appliances that are categorized for the purpose of vent selection are classified into the following four categories:

**Category I.** An appliance that operates with a nonpositive vent static pressure and with a vent gas temperature that avoids excessive condensate production in the vent.

**Category II.** An appliance that operates with a nonpositive vent static pressure and with a vent gas temperature that is capable of causing excessive condensate production in the vent.

**Category III.** An appliance that operates with a positive vent static pressure and with a vent gas temperature that avoids excessive condensate production in the vent.

**Category IV.** An appliance that operates with a positive vent static pressure and with a vent gas temperature that is capable of causing excessive condensate production in the vent.

**VENTED ROOM HEATER.** A vented self-contained, free-standing, nonrecessed appliance for furnishing warm air to the space in which it is installed, directly from the heater without duct connections.

**VENTED WALL FURNACE.** A self-contained vented appliance complete with grilles or equivalent, designed for incorporation in or permanent attachment to the structure of a building, mobile home or travel trailer, and furnishing heated air circulated by gravity or by a fan directly into the space to be heated through openings in the casing. This definition shall exclude floor furnaces, unit heaters and central furnaces as herein defined.

**VENTING SYSTEM.** A continuous open passageway from the flue collar or draft hood of an appliance to the outside atmosphere for the purpose of removing flue or vent gases. A venting system is usually composed of a vent or a chimney and vent connector, if used, assembled to form the open passageway.

**Mechanical draft venting system.** A venting system designed to remove flue or vent gases by mechanical means, that consists of an induced draft portion under nonpositive static pressure or a forced draft portion under positive static pressure.

**Forced-draft venting system.** A portion of a venting system using a fan or other mechanical

means to cause the removal of flue or vent gases under positive static vent pressure.

**Induced draft venting system.** A portion of a venting system using a fan or other mechanical means to cause the removal of flue or vent gases under nonpositive static vent pressure.

**Natural draft venting system.** A venting system designed to remove flue or vent gases under nonpositive static vent pressure entirely by natural draft.

**WALL HEATER, UNVENTED-TYPE.** A room heater of the type designed for insertion in or attachment to a wall or partition. Such heater does not incorporate concealed venting arrangements in its construction and discharges all products of combustion through the front into the room being heated.

**WATER HEATER.** Any heating appliance or equipment that heats potable water and supplies such water to the potable hot water distribution system.

### **CHAPTER 3** **GENERAL REGULATIONS**

#### **SECTION FGC 301** **GENERAL**

**301.1 Scope.** This chapter shall govern the approval and installation of all equipment and appliances that comprise parts of the installations regulated by this code in accordance with Section 101.2.

**301.1.1 Other fuels.** The requirements for combustion and dilution air for gas-fired appliances shall be governed by Section 304. The requirements for combustion and dilution air for appliances operating with fuels other than fuel gas shall be regulated by the *New York City Mechanical Code*.

**301.2 Energy utilization.** Heating, ventilating and air-conditioning systems of all structures shall be designed and installed for efficient utilization of energy in accordance with the *Energy Conservation Construction Code of New York State*.

**301.3 Listed and labeled.** Appliances regulated by this code shall be listed and labeled.

**301.4 Labeling.** Labeling shall be in accordance with the procedures set forth in Sections 301.4.1 through 301.4.2.3, and 301.5.

**301.4.1 Testing.** An approved agency shall test a representative sample of the appliances being labeled to the relevant standard or standards. The approved agency shall maintain a record of all of the tests performed. The record shall provide sufficient detail to verify compliance with the test standard.

**301.4.2 Inspection and identification.** The approved agency shall periodically perform an inspection, which shall be in-plant if necessary, of the appliances to be labeled. The inspection

shall verify that the labeled appliances are representative of the appliances tested.

**301.4.2.1 Independent.** The agency to be approved shall be objective and competent. To confirm its objectivity, the agency shall disclose all possible conflicts of interest.

**301.4.2.2 Equipment.** An approved agency shall have adequate equipment to perform all required tests. The equipment shall be periodically calibrated.

**301.4.2.3 Personnel.** An approved agency shall employ experienced personnel educated in conducting, supervising and evaluating tests.

**301.5 Label information.** A permanent factory-applied nameplate(s) shall be affixed to appliances on which shall appear, in legible lettering, the manufacturer's name or trademark, the model number, serial number and, for listed appliances, the seal or mark of the testing agency. A label shall also include the hourly rating in British thermal units per hour (Btu/h) (W), the type of fuel approved for use with the appliance, and the minimum clearance requirements.

**301.6 Plumbing connections.** Potable water supply and building drainage system connections to appliances regulated by this code shall be in accordance with the *New York City Plumbing Code*.

**301.7 Fuel types.** Appliances shall be designed for use with the type of fuel gas to which they will be connected and the altitude at which they are installed. Appliances that comprise parts of the installation shall not be converted for the usage of a different fuel, except where approved and converted in accordance with the manufacturer's instructions. The fuel gas input rate shall not be increased or decreased beyond the limit rating for the altitude at which the appliance is installed.

**301.7.1 Liquid petroleum gas.** Storage or use of LPG for a stationary LPG installation shall comply with the *New York City Fire Code*.

**301.8 Vibration isolation.** Where means for isolation of vibration of an appliance is installed, means for support and restraint of that appliance shall be provided as designed by A registered design professional.

**301.9 Repair.** Defective material or parts shall be replaced or repaired in such a manner so as to preserve the original approval or listing.

**301.10 Wind resistance.** Appliances and supports that are exposed to wind shall be designed and installed to resist the wind pressures determined in accordance with the *New York City Building Code*.

**301.11 Flood hazard.** For structures located in areas of special flood hazard, the appliance, equipment and system installations regulated by this code shall comply with Appendix G of the *New York City Building Code*.

**301.12 Seismic resistance.** When earthquake loads are applicable in accordance with the *New York City Building Code*, the supports shall be designed and installed for the seismic forces in

accordance with that code.

**301.13 Ducts.** All ducts required for the installation of systems regulated by this code shall be designed and installed in accordance with the *New York City Mechanical Code*.

**301.14 Rodent-proofing.** Buildings or structures and the walls enclosing habitable or occupiable rooms and spaces in which persons live, sleep or work, or in which feed, food or foodstuffs are stored, prepared, processed, served or sold, shall be constructed to protect against rodents in accordance with the *New York City Building Code*.

**301.15 Prohibited location.** The appliances, equipment and systems regulated by this code shall not be located in an elevator shaft.

**301.16 Mechanical systems.** Hydronic piping, ventilation and other mechanical systems not covered by this code shall be in accordance with the *New York City Mechanical Code*.

**301.17 Electrical systems.** Electrical wiring, controls and connections to equipment and appliances regulated by this code shall be in accordance with the *New York City Electrical Code*.

## **SECTION FGC 302** **STRUCTURAL SAFETY**

**302.1 Structural safety.** The building shall not be weakened by the installation of any gas piping. In the process of installing or repairing any gas piping, the finished floors, walls, ceilings, tile work or any other part of the building or premises which is required to be changed or replaced shall be left in a safe structural condition in accordance with the requirements of the *New York City Building Code*.

**302.2 Penetrations of floor/ceiling assemblies and fire-resistance-rated assemblies.** Penetrations of floor/ceiling assemblies and assemblies required to have a fire-resistance rating shall be protected in accordance with the *New York City Building Code*.

**302.3 Cutting, notching and boring in wood members.** The cutting, notching and boring of wood members shall comply with Sections 302.3.1 through 302.3.4.

**302.3.1 Engineered wood products.** Cuts, notches and holes bored in trusses, laminated veneer lumber, glued-laminated members and I-joists are prohibited except where the effects of such alterations are specifically considered in the design of the member.

**302.3.2 Joist notching and boring.** Notching at the ends of joists shall not exceed one-fourth the joist depth. Holes bored in joists shall not be within 2 inches (51 mm) of the top and bottom of the joist and their diameter shall not exceed one-third the depth of the member. Notches in the top or bottom of the joist shall not exceed one-sixth the depth and shall not be located in the middle one-third of the span.

**302.3.3 Stud cutting and notching.** In exterior walls and bearing partitions, any wood stud is



permitted to be cut or notched to a depth not exceeding 25 percent of its width. Cutting or notching of studs to a depth not greater than 40 percent of the width of the stud is permitted in nonload-bearing partitions supporting no loads other than the weight of the partition.

**302.3.4 Bored holes.** A hole not greater in diameter than 40 percent of the stud depth is permitted to be bored in any wood stud. Bored holes not greater than 60 percent of the depth of the stud are permitted in nonload-bearing partitions or in any wall where each bored stud is doubled, provided not more than two such successive doubled studs are so bored. In no case shall the edge of the bored hole be nearer than 5/8 inch (15.9 mm) to the edge of the stud. Bored holes shall not be located at the same section of stud as a cut or notch.

**302.4 Alterations to trusses.** Truss members and components shall not be cut, drilled, notched, spliced or otherwise altered in any way without the written concurrence and approval of a registered design professional. Alterations resulting in the addition of loads to any member (e.g., HVAC equipment, water heaters) shall not be permitted without verification that the truss is capable of supporting such additional loading.

**302.5 Cutting, notching and boring holes in structural steel framing.** The cutting, notching and boring of holes in structural steel framing members shall be as prescribed by the registered design professional.

**302.6 Cutting, notching and boring holes in cold-formed steel framing.** Flanges and lips of load-bearing, cold-formed steel framing members shall not be cut or notched. Holes in webs of load-bearing, cold-formed steel framing members shall be permitted along the centerline of the web of the framing member and shall not exceed the dimensional limitations, penetration spacing or minimum hole edge distance as prescribed by a registered design professional. Cutting, notching and boring holes of steel floor/roof decking shall be as prescribed by a registered design professional.

**302.7 Cutting, notching and boring holes in nonstructural cold-formed steel wall framing.** Flanges and lips of nonstructural cold-formed steel wall studs shall be permitted along the centerline of the web of the framing member, shall not exceed 1½ inches (38 mm) in width or 4 inches (102 mm) in length, and the holes shall not be spaced less than 24 inches (610 mm) center to center from another hole or less than 10 inches (254 mm) from the bearing end.

## **SECTION FGC 303** **APPLIANCE LOCATION**

**303.1 General.** Appliances shall be located as required by this section, specific requirements elsewhere in this code and the conditions of the equipment and appliance listing.

**303.2 Hazardous locations.** Appliances shall not be located in a hazardous location unless listed and approved for the specific installation.

**303.3 Prohibited locations.** Appliances shall not be located in, or obtain combustion air from, any of the following rooms or spaces:

1. Sleeping rooms.

2. Bathrooms.

3. Toilet rooms.

4. Storage closets.

5. Surgical rooms.

**Exceptions:**

1. In rooms other than those used for sleeping purposes, direct-vent appliances that obtain all combustion air directly from the outdoors.
2. In rooms other than those used for sleeping purposes, vented room heaters, wall furnaces, vented decorative appliances and decorative appliances for installation in vented solid fuel-burning fireplaces, provided that the room meets the required volume criteria of Section 304.5.
3. In rooms other than those used for sleeping purposes, appliances installed in an enclosure in which all combustion air is taken from the outdoors, in accordance with Section 304.6. Access to such enclosure shall be through a solid weather-stripped door, equipped with an approved self-closing device.

**303.4 Protection from physical damage.** Appliances shall not be installed in a location where subject to physical damage unless protected by approved barriers meeting the requirements of the *New York City Fire Code*.

**303.5 Indoor locations.** Furnaces and boilers installed in closets and alcoves shall be listed for such installation.

**303.6 Outdoor locations.** Equipment installed in outdoor locations shall be either listed for outdoor installation or provided with protection from outdoor environmental factors that influence the operability, durability and safety of the equipment.

**303.7 Pit locations.** Appliances installed in pits or excavations shall not come in direct contact with the surrounding soil. The sides of the pit or excavation shall be held back a minimum of 12 inches (305 mm) from the appliance. Where the depth exceeds 12 inches (305 mm) below adjoining grade, the walls of the pit or excavation shall be lined with concrete or masonry, such concrete or masonry shall extend a minimum of 4 inches (102 mm) above adjoining grade and shall have sufficient lateral load-bearing capacity to resist collapse. The appliance shall be protected from flooding in a manner approved by the commissioner.

**SECTION FGC 304**

## **COMBUSTION, VENTILATION AND DILUTION AIR**

**304.1 General.** Air for combustion, ventilation and dilution of flue gases for gas utilization equipment installed in buildings shall be provided by application of one of the methods prescribed in Sections 304.5 through 304.9. Where the requirements of Section 304.5 are not met, outdoor air shall be introduced in accordance with one of the methods prescribed in Sections 304.6 through 304.9. Direct-vent appliances, gas appliances of other than natural draft design and vented gas appliances other than Category I shall be provided with combustion, ventilation and dilution air in accordance with the equipment manufacturer's instructions.

**Exception:** Type 1 clothes dryers that are provided with makeup air in accordance with Section 614.5.

**304.2 Appliance/equipment location.** Equipment shall be located so as not to interfere with proper circulation of combustion, ventilation and dilution air.

**304.3 Draft hood/regulator location.** Where used, a draft hood or a barometric draft regulator shall be installed in the same room or enclosure as the equipment served so as to prevent any difference in pressure between the hood or regulator and the combustion air supply. A barometric damper may be installed in an adjacent room provided that a louver is installed in the adjacent room to the outside air. The net free area of the louver shall be equal to or greater than the area of the barometric damper.

**304.4 Makeup air provisions.** Makeup air requirements for the operation of exhaust fans, kitchen ventilation systems, clothes dryers and fireplaces shall be considered in determining the adequacy of a space to provide combustion air requirements.

**304.5 Indoor combustion air.** The required volume of indoor air shall be determined in accordance with Section 304.5.1 or 304.5.2, except that where the air infiltration rate is known to be less than 0.40 air changes per hour (ACH), Section 304.5.2 shall be used. The total required volume shall be the sum of the required volume calculated for all appliances located within the space. Rooms communicating directly with the space in which the appliances are installed through openings not furnished with doors, and through combustion air openings sized and located in accordance with Section 304.5.3, are considered to be part of the required volume.

**304.5.1 Standard method.** The minimum required volume shall be 50 cubic feet per 1,000 Btu/h (4.8m<sup>3</sup>/kW) of the appliance input rating.

**304.5.2 Known air-infiltration-rate method.** Where the air infiltration rate of a structure is known, the minimum required volume shall be determined as follows:

For appliances other than fan-assisted, calculate volume using Equation 3-1.

**(Equation 3-1 attached at end of document)**

**(Equation 3-2 attached at end of document)**

For purposes of this calculation, an infiltration rate greater than 0.60 ACH shall not be used in Equations 3-1 and 3-2.

**304.5.3 Indoor opening size and location.** Openings used to connect indoor spaces shall be sized and located in accordance with Sections 304.5.3.1 and 304.5.3.2 (see Figure 304.5.3).

**FIGURE 304.5.3**  
**ALL AIR FROM INSIDE THE BUILDING**  
**(Figure 304.5.3 attached to end of document)**

**304.5.3.1 Combining spaces on the same story.** Each opening shall have a minimum free area of 1 square inch per 1,000 Btu/h (2200 mm<sup>2</sup>/kW) of the total input rating of all gas utilization equipment in the space, but not less than 100 square inches (0.06 m<sup>2</sup>). One opening shall commence within 12 inches (305 mm) of the top and one opening shall commence within 12 inches (305 mm) of the bottom of the enclosure. The minimum dimension of air openings shall be not less than 3 inches (76 mm).

**304.5.3.2 Combining spaces in different stories.** The volumes of spaces in different stories shall be considered as communicating spaces where such spaces are connected by one or more openings in doors or floors having a total minimum free area of 2 square inches per 1,000 Btu/h (4402 mm<sup>2</sup>/kW) of total input rating of all gas utilization equipment.

**304.6 Outdoor combustion air.** Outdoor combustion air shall be provided through opening(s) to the outdoors in accordance with Section 304.6.1 or 304.6.2. The minimum dimension of air openings shall be not less than 3 inches (76 mm). The size of the openings connecting the room to the outdoor air supply shall also comply with any applicable rules of the New York City Department of Environmental Protection.

**304.6.1 Two-permanent-openings method.** Two permanent openings, one commencing within 12 inches (305 mm) of the top and one commencing within 12 inches (305 mm) of the bottom of the enclosure, shall be provided. The openings shall communicate directly, or by ducts, with the outdoors or spaces that freely communicate with the outdoors. Where directly communicating with the outdoors, or where communicating with the outdoors through vertical ducts, each opening shall have a minimum free area of 1 square inch per 4,000 Btu/h (550 mm<sup>2</sup>/kW) of total input rating of all equipment in the enclosure [see Figures 304.6.1(1) and 304.6.1(2)]

**FIGURE 304.6.1 (1)**  
**ALL AIR FROM OUTDOORS-INLET AIR FROM VENTILATED CRAWL**  
**SPACE AND OUTLET AIR TO VENTILATED ATTIC**  
**(Figure 304.6.1 (1) attached to end of document)**

**FIGURE 304.6.1 (2)**  
**ALL AIR FROM OUTDOORS THROUGH VENTILATED ATTIC**

**(Figure 304.6.1 (2) attached to end of document)**

Where communicating with the outdoors through horizontal ducts, each opening shall have a minimum free area of not less than 1 square inch per 2,000 Btu/h (1100 mm<sup>2</sup>/kW) of total input rating of all equipment in the enclosure. [see Figure 304.6.1(3)].

**FIGURE 304.6.1 (3)**

**ALL AIR FROM OUTDOORS**

**(Figure 304.6.1 (3) attached to end of document)**

**304.6.2 One-permanent-opening method.** One permanent opening, commencing within 12 inches (305 mm) of the top of the enclosure, shall be provided. The equipment shall have clearances of at least 1 inch (25 mm) from the sides and back and 6 inches (152 mm) from the front of the appliance. The opening shall directly communicate with the outdoors or through a vertical or horizontal duct to the outdoors or spaces that freely communicate with the outdoors [see Figure 304.6.2] and shall have a minimum free area of 1 square inch per 3,000 Btu/h (734 mm<sup>2</sup>/kW) of the total input rating of all equipment located in the enclosure, and not less than the sum of the areas of all vent connectors in the space.

**FIGURE 304.6.2**

**SINGLE COMBUSTION AIR OPENING**

**ALL AIR FROM OUTDOORS**

**(Figure 304.6.2 attached to end of document)**

**304.7 Combination indoor and outdoor combustion air.** The use of a combination of indoor and outdoor combustion air shall be in accordance with Sections 304.7.1 through 304.7.3.

**304.7.1 Indoor openings.** Where used, openings connecting the interior spaces shall comply with Section 304.5.3.

**304.7.2 Outdoor opening location.** Outdoor opening(s) shall be located in accordance with Section 304.6.

**304.7.3 Outdoor opening(s) size.** The outdoor opening(s) size shall be calculated in accordance with the following:

1. The ratio of interior spaces shall be the available volume of all communicating spaces divided by the required volume.
2. The outdoor size reduction factor shall be one minus the ratio of interior spaces.
3. The minimum size of outdoor opening(s) shall be the full size of outdoor opening(s) calculated in accordance with Section 304.6, multiplied by the reduction factor. The minimum dimension of air openings shall be not less than 3 inches (76 mm).

**304.8 Reserved.**

**304.9 Mechanical combustion air supply.** Where all combustion air is provided by a mechanical air supply system, the combustion air shall be supplied from the outdoors at a rate not less than 0.35 cubic feet per minute per 1,000 Btu/h (0.034 m<sup>3</sup>/min per kW) of total input rating of all appliances located within the space. Combustion air rates shall also comply with any applicable rules of the New York City Department of Environmental Protection.

**304.9.1 Makeup air.** Where exhaust fans are installed, makeup air shall be provided to replace the exhausted air.

**304.9.2 Appliance interlock.** Each of the appliances served shall be interlocked with the mechanical air supply system to prevent main burner operation when the mechanical air supply system is not in operation.

**304.9.3 Combined combustion air and ventilation air system.** Where combustion air is provided by the building's mechanical ventilation system, the system shall provide the specified combustion air rate in addition to the required ventilation air.

**304.10 Louvers and grilles.** The required size of openings for combustion, ventilation and dilution air shall be based on the net free area of each opening. Where the free area through a design of louver or grille is known, it shall be used in calculating the size opening required to provide the free area specified. Where the design and free area of louvers and grilles are not known, it shall be assumed that wood louvers will have 10-percent free area and metal louvers and grilles will have 60-percent free area. Screens shall have a mesh size not smaller than ¼ inch (6.4 mm). Nonmotorized louvers and grilles shall be fixed in the open position. Motorized louvers shall be interlocked with the equipment so that they are proven to be in the full open position prior to main burner ignition and during main burner operation. Means shall be provided to prevent the main burner from igniting if the louvers fail to open during burner start-up and to shut down the main burner if the louvers close during operation.

**304.11 Combustion air ducts.** Combustion air ducts shall comply with all of the following:

1. Ducts shall be of galvanized steel complying with Chapter 6 of the *New York City Mechanical Code* or of equivalent corrosion-resistant material listed and labeled for this application.
2. Ducts shall terminate in an unobstructed space allowing free movement of combustion air to the appliances.
3. Ducts shall serve a single enclosure.
4. Ducts shall not serve both upper and lower combustion air openings where both such openings are used. The separation between ducts serving upper and lower combustion air openings shall be maintained to the source of combustion air.
5. Ducts shall not be screened where terminating in an attic space.

6. Horizontal upper combustion air ducts shall not slope downward toward the source of combustion air.

7. The remaining space surrounding a chimney liner, gas vent, special gas vent or plastic piping installed within a masonry, metal or factory-built chimney shall not be used to supply combustion air.

**Exception:** Direct-vent gas-fired appliances designed for installation in a solid fuel-burning fireplace where installed in accordance with the listing and the manufacturer's instructions.

8. Combustion air intake openings located on the exterior of a building shall have the lowest side of such openings located not less than 12 inches (305 mm) vertically from the adjoining grade level.

**304.12 Protection from fumes and gases.** Where corrosive or flammable process fumes or gases, other than products of combustion, are present, means for the disposal of such fumes or gases shall be provided. Such fumes or gases include carbon monoxide, hydrogen sulfide, ammonia, chlorine and halogenated hydrocarbons. In barbershops, beauty shops and other facilities where chemicals that generate corrosive or flammable products, such as aerosol sprays, are routinely used, nondirect-vent-type appliances shall be located in an equipment room separated or partitioned off from other areas with provisions for combustion air and dilution air from the outdoors. Direct-vent appliances shall be installed in accordance with the appliance manufacturer's installation instructions.

## **SECTION FGC 305** **INSTALLATION**

**305.1 General.** Equipment and appliances shall be installed as required by the terms of their approval, in accordance with the conditions of listing, the manufacturer's instructions and this code. Manufacturers' installation instructions shall be available on the job site at the time of inspection. Where a code provision is less restrictive than the conditions of the listing of the equipment or appliance or the manufacturer's installation instructions, the conditions of the listing and the manufacturer's installation instructions shall apply.

**305.2 Hazardous area.** Equipment and appliances having an ignition source shall not be installed in Group H occupancies or control areas where open use, handling or dispensing of combustible, flammable or explosive materials occurs.

**305.3 Elevation of ignition source.** Equipment and appliances having an ignition source shall be elevated such that the source of ignition is not less than 18 inches (457 mm) above the floor in hazardous locations and public garages, private garages, repair garages, motor fuel-dispensing facilities and parking garages. For the purpose of this section, rooms or spaces that are not part of the living space of a dwelling unit and that communicate directly with a private garage through openings shall be considered to be part of the private garage.

**Exception:** Elevation of the ignition source is not required for appliances that are listed as flammable vapor resistant and for installation without elevation.

**305.4 Public garages, motor fuel-dispensing facilities and repair garages.** Appliances located in public garages, motor fuel-dispensing facilities, or other areas frequented by motor vehicles shall be installed a minimum of 8 feet (2438 mm) above the floor. Where motor vehicles exceed 6 feet (1829 mm) in height and are capable of passing under an appliance, appliances shall be installed a minimum of 2 feet (610 mm) higher above the floor than the height of the tallest vehicle.

**Exceptions:**

1. The requirements of this section shall not apply where the appliances are protected from motor vehicle impact and installed in accordance with Section 305.3 and NFPA 88B.
2. Appliances installed in repair garages shall be separated from repair areas by walls or partitions, floors, or floor ceiling assemblies that are constructed so as to prohibit the transmission of vapors and having a fire-resistance rating of not less than one hour, and that have no openings in the wall separating the repair area within 8 feet (2438 mm) of the floor. Wall penetration shall be firestopped. Air for combustion purposes shall be obtained from the outdoors. The heating room shall not be used for the storage of combustible materials.
3. Heating appliances for vehicle repair areas where there is no dispensing or transferring of Class I or Class II flammable or combustible liquids or liquefied petroleum gas shall be installed in accordance with NFPA 30A

**305.5 Private garages.** Appliances located in private garages shall be installed with a minimum clearance of 6 feet (1829 mm) above the floor.

**Exception:** The requirements of this section shall not apply where the appliances are protected from motor vehicle impact and installed in accordance with Section 305.3.

**305.6 Construction and protection.** Boiler rooms and furnace rooms shall be protected as required by the *New York City Building Code*.

**305.7 Clearances from grade.** Equipment and appliances installed at grade level shall be supported on a level concrete slab or other approved material extending above adjoining grade or shall be suspended a minimum of 6 inches (152 mm) above adjoining grade.

**305.8 Clearances to combustible construction.** Heat-producing equipment and appliances shall be installed to maintain the required clearances to combustible construction as specified in the listing and manufacturer's instructions. Such clearances shall be reduced only in accordance with Section 308. Clearances to combustibles shall include such considerations as door swing, drawer pull, overhead projections or shelving and window swing. Devices, such as door stops or limits



and closers, shall not be used to provide the required clearances.

## **SECTION FGC 306** **ACCESS AND SERVICE SPACE**

**306.1 Clearances for maintenance and replacement.** Clearances around appliances to elements of permanent construction, including other installed appliances, shall be sufficient to allow inspection, service, repair or replacement without removing such elements of permanent construction or disabling the function of a required fire-resistance-rated assembly.

**306.2 Appliances in rooms.** Rooms containing appliances requiring access shall be provided with a door and an unobstructed passageway measuring not less than 36 inches (914 mm) wide and 80 inches (2032 mm) high.

**Exception:** Within a dwelling unit, appliances installed in a compartment, alcove, basement or similar space shall be provided with access by an opening or door and an unobstructed passageway measuring not less than 24 inches (610 mm) wide and large enough to allow removal of the largest appliance in the space, provided that a level service space of not less than 30 inches (762 mm) deep and the height of the appliance, but not less than 30 inches (762 mm), is present at the front or service side of the appliance with the door open.

**306.3 Appliances in attics.** Attics containing appliances requiring access shall be provided with an opening and unobstructed passageway large enough to allow removal of the largest component of the appliance. The passageway shall not be less than 30 inches (762 mm) high and 22 inches (559 mm) wide and not more than 20 feet (6096 mm) in length when measured along the centerline of the passageway from the opening to the equipment. The passageway shall have continuous solid flooring not less than 24 inches (610 mm) wide. A level service space not less than 30 inches (762 mm) deep and 30 inches (762 mm) wide shall be present at the front or service side of the equipment. The clear access opening dimensions shall be a minimum of 20 inches by 30 inches (508 mm by 762 mm), where such dimensions are large enough to allow removal of the largest component of the appliance.

**Exceptions:**

1. The passageway and level service space are not required where the appliance is capable of being serviced and removed through the required opening.
2. Where the passageway is not less than 6 feet (1829 mm) high for its entire length, the passageway shall be not greater than 50 feet (15 250 mm) in length.

**306.3.1 Electrical requirements.** A lighting fixture controlled by a switch located at the required passageway opening and a receptacle outlet shall be provided at or near the equipment location in accordance with the *New York City Electrical Code*.

**306.4 Appliances under floors.** Under-floor spaces containing appliances requiring access shall be provided with an access opening and unobstructed passageway large enough to remove the

largest component of the appliance. The passageway shall not be less than 30 inches (762 mm) high and 22 inches (559 mm) wide, nor more than 20 feet (6096 mm) in length when measured along the centerline of the passageway from the opening to the equipment. A level service space not less than 30 inches (762 mm) deep and 30 inches (762 mm) wide shall be present at the front or service side of the appliance. If the depth of the passageway or the service space exceeds 12 inches (305 mm) below the adjoining grade, the walls of the passageway shall be lined with concrete or masonry extending 4 inches (102 mm) above the adjoining grade and having sufficient lateral-bearing capacity to resist collapse. The clear access opening dimensions shall be a minimum of 22 inches by 30 inches (559 mm by 762 mm), where such dimensions are large enough to allow removal of the largest component of the appliance.

**Exceptions:**

1. The passageway is not required where the level service space is present when the access is open and the appliance is capable of being serviced and removed through the required opening.
2. Where the passageway is not less than 6 feet high (1829 mm) for its entire length, the passageway shall not be limited in length.

**306.4.1 Electrical requirements.** A lighting fixture controlled by a switch located at the required passageway opening and a receptacle outlet shall be provided at or near the equipment location in accordance with the *New York City Electrical Code*.

**306.5 Appliances on roofs or elevated structures.** Where appliances requiring access are installed on roofs or elevated structures at a height exceeding 16 feet (4877 mm), such access shall be provided by a permanent means of access designed by a registered design professional, the extent of which shall be from grade or floor level to the appliance's level service space. Such access shall not require climbing over obstructions greater than 30 inches high (762 mm) or walking on roofs having a slope greater than four units vertical in 12 units horizontal (33-percent slope).

Permanent ladders installed to provide the required access shall comply with the following minimum design criteria.

1. The side railing shall extend above the parapet or roof edge not less than 30 inches (762 mm).
2. Ladders shall have a rung spacing not to exceed 14 inches (356 mm) on center.
3. Ladders shall have a toe spacing not less than 6 inches (152 mm) deep.
4. There shall be a minimum of 18 inches (457 mm) between rails.
5. Rungs shall have a minimum diameter of 0.75-inch (19 mm) and shall be capable of withstanding a 300-pound (136.1 kg) load.

6. Ladders over 30 feet (9144 mm) in height shall be provided with offset sections and landings capable of withstanding a load of 100 pounds per square foot (488.2 kg/m<sup>2</sup>).

7. Ladders shall be protected against corrosion by means designed by a registered design professional.

Catwalks installed to provide the required access shall be not less than 24 inches wide (610 mm) and shall have railings as required for service platforms.

**Exception:** This section shall not apply to Group R-3 occupancies.

**306.5.1 Sloped roofs.** Where appliances are installed on a roof having a slope of three units vertical in 12 units horizontal (25-percent slope) or greater and having an edge more than 30 inches (762 mm) above grade at such edge, a level platform shall be provided on each side of the appliance to which access is required by the manufacturer's installation instructions for service, repair or maintenance. The platform shall not be less than 30 inches (762 mm) in any dimension and shall be provided with guards in accordance with Section 306.6.

**306.5.2 Electrical requirements.** A receptacle outlet shall be provided at or near the equipment location in accordance with the *New York City Electrical Code*.

**306.6 Guards.** Guards shall be provided where appliances, fans or other components that require service are located within 10 feet (3048 mm) of a roof edge or open side of a walking surface and such edge or open side is located more than 30 inches (762 mm) above the floor, roof or grade below. The guard shall extend not less than 30 inches (762 mm) beyond each end of such appliances, fans or other components and the top of the guard shall be located not less than 42 inches (1067 mm) above the elevated surface adjacent to the guard. The guard shall be constructed so as to prevent the passage of a 21-inch-diameter (533 mm) sphere and shall comply with the loading requirements for guards specified in the *New York City Building Code*.

## **SECTION FGC 307** **CONDENSATE DISPOSAL**

**307.1 Fuel-burning appliances.** Liquid combustion by-products of condensing appliances shall be collected and discharged to a dedicated plumbing fixture, or to a disposal area in accordance with the manufacturer's installation instructions. Condensate piping shall be of corrosion-resistant material and shall not be smaller than the drain connection on the appliance. Such piping shall maintain a minimum slope in the direction of discharge of not less than one-eighth unit vertical in 12 units horizontal (1-percent slope).

**307.2 Drain pipe materials and sizes.** Components of the condensate disposal system shall be cast iron, galvanized steel, copper, polyethylene, ABS, CPVC or PVC pipe or tubing. All components shall be selected for the pressure and temperature rating of the installation. Condensate waste and drain line size shall be not less than 3/4-inch internal diameter (19 mm) and shall not decrease in size from the drain connection to the place of condensate disposal. Where the

drain pipes from more than one unit are manifolded together for condensate drainage, the pipe or tubing shall be sized by a registered design professional. All horizontal sections of drain piping shall be installed in uniform alignment at a uniform slope.

**307.3 Traps.** Condensate drains shall be trapped as required by the equipment or appliance manufacturer.

**307.4 Evaporators and cooling coils.** Drainage of condensate from evaporators and cooling coils shall be performed in accordance with the *New York City Mechanical Code*.

**307.5 Exceptions.** Section 307.5 applies to permanently installed equipment. Window units and through-the-wall air-conditioning units are exempt.

**SECTION FGC 308**  
**CLEARANCE REDUCTION**

**308.1 Scope.** This section shall govern the reduction in required clearances to combustible materials and combustible assemblies for chimneys, vents, appliances, devices and equipment. Clearance requirements for air-conditioning equipment and central heating boilers and furnaces shall comply with Sections 308.3 and 308.4.

**308.2 Reduction table.** The allowable clearance reduction shall be based on one of the methods specified in Table 308.2 or shall utilize an assembly listed for such application. Where required clearances are not listed in Table 308.2, the reduced clearances shall be determined by linear interpolation between the distances listed in the table. Reduced clearances shall not be derived by extrapolation below the range of the table. The reduction of the required clearances to combustibles for listed and labeled appliances and equipment shall be in accordance with the requirements of this section except that such clearances shall not be reduced where reduction is specifically prohibited by the terms of the appliance or equipment listing [see Figures 308.2(1) through 308.2(3)]

**TABLE 308.2**  
**REDUCTION OF CLEARANCES WITH SPECIFIED FORMS OF PROTECTION**  
**(Table 308.2 attached to end of document)**

**FIGURE 308.2(1)**  
**EXTENT OF PROTECTION NECESSARY TO**  
**REDUCE CLEARANCES FROM GAS EQUIPMENT OR**  
**VENT CONNECTIONS**  
**(Figure 308.2(1) attached to end of document)**

**FIGURE 308.2(2)**  
**WALL PROTECTOR CLEARANCE REDUCTION SYSTEM**  
**(Figure 308.2(2) attached to end of document)**

**FIGURE 308.2(3)**

**MASONRY CLEARANCE REDUCTION SYSTEM**  
**(Figure 308. 2 (3) original/existing version attached to end of document)**

**308.3 Clearances for indoor air-conditioning equipment.** Clearance requirements for indoor air-conditioning equipment shall comply with Sections 308.3.1 through 308.3.5.

**308.3.1 Equipment installed in rooms that are large in comparison with the size of the equipment.** Air-conditioning equipment installed in rooms that are large in comparison with the size of the equipment shall be installed with clearances in accordance with the terms of their listing and the manufacturer's instructions.

**308.3.2 Equipment installed in rooms that are not large in comparison with the size of the equipment.** Air-conditioning equipment installed in rooms that are not large in comparison with the size of the equipment, such as alcoves and closets, shall be listed for such installations and installed in accordance with the manufacturer's instructions. Listed clearances shall not be reduced by the protection methods described in Table 308.2, regardless of whether the enclosure is of combustible or noncombustible material.

**308.3.3 Clearance reduction.** Air-conditioning equipment installed in rooms that are large in comparison with the size of the equipment shall be permitted to be installed with reduced clearances to combustible material provided the combustible material or equipment is protected as described in Table 308.2.

**308.3.4 Plenum clearances.** Where the furnace plenum is adjacent to plaster on metal lath or noncombustible material attached to combustible material, the clearance shall be measured to the surface of the plaster or other noncombustible finish where the clearance specified is 2 inches (51 mm) or less.

**308.3.5 Clearance from supply ducts.** Air-conditioning equipment shall have the clearance from supply ducts within 3 feet (914 mm) of the furnace plenum be not less than that specified from the furnace plenum. No clearance is necessary beyond this distance.

**308.4 Central-heating boilers and furnaces.** Clearance requirements for central-heating boilers and furnaces shall comply with Sections 308.4.1 through 308.4.6. The clearance to this equipment shall not interfere with combustion air, draft hood clearance and relief, and accessibility for servicing.

**308.4.1 Equipment installed in rooms that are large in comparison with the size of the equipment.** Central-heating furnaces and low-pressure boilers installed in rooms large in comparison with the size of the equipment shall be installed with clearances in accordance with the terms of their listing and the manufacturer's instructions.

**308.4.2 Equipment installed in rooms that are not large in comparison with the size of the equipment.** Central-heating furnaces and low-pressure boilers installed in rooms that are not large in comparison with the size of the equipment, such as alcoves and closets, shall be listed for such installations. Listed clearances shall not be reduced by the protection methods

described in Table 308.2 and illustrated in Figures 308.2(1) through 308.2(3), regardless of whether the enclosure is of combustible or noncombustible material.

**308.4.3 Clearance reduction.** Central-heating furnaces and low-pressure boilers installed in rooms that are large in comparison with the size of the equipment shall be permitted to be installed with reduced clearances to combustible material provided the combustible material or equipment is protected as described in Table 308.2.

**308.4.4 Clearance for servicing equipment.** Front clearance shall be sufficient for servicing the burner and the furnace or boiler.

**308.4.5 Plenum clearances.** Where the furnace plenum is adjacent to plaster on metal lath or noncombustible material attached to combustible material, the clearance shall be measured to the surface of the plaster or other noncombustible finish where the clearance specified is 2 inches (51 mm) or less.

**308.4.6 Clearance from supply ducts.** Central-heating furnaces shall have the clearance from supply ducts within 3 feet (914 mm) of the furnace plenum be not less than that specified from the furnace plenum. No clearance is necessary beyond this distance.

## **SECTION FGC 309** **ELECTRICAL**

**309.1 Grounding.** Gas piping shall not be used as a grounding electrode.

**309.2 Connections.** Electrical connections between equipment and the building wiring, including the grounding of the equipment, shall conform to the *New York City Electrical Code*.

## **SECTION FGC 310** **ELECTRICAL BONDING**

**310.1 Gas pipe bonding.** Each above-ground portion of a gas piping system that is likely to become energized shall be electrically continuous and bonded to an effective ground-fault current path. Gas piping shall be considered to be bonded where it is connected to gas utilization equipment that is connected to the equipment grounding conductor of the circuit supplying that equipment.

## **CHAPTER 4** **GAS PIPING INSTALLATIONS**

### **SECTION FGC 401** **GENERAL**

**401.1 Scope.** This chapter shall govern the design, installation, modification and maintenance of fuel gas piping systems. The scope covered by this chapter includes piping systems from the point of delivery to the connections with the equipment and includes the design, materials, components,

fabrication, assembly, installation, testing, inspection, operation and maintenance of such piping systems.

**401.1.1 Meters and service piping.** Service piping includes the fuel gas piping up to the point of delivery. Meters and service piping shall comply with the requirements of Appendix E and Appendix F of this code. In addition, service piping located within buildings shall be designed and installed in accordance with the structural integrity, firestopping, and fire protection provisions of the *New York City Building Code*.

**401.1.2 Plastic piping.** Underground plastic piping installed outside of buildings, shall be in compliance with Appendix E and Appendix F of this code.

**401.2 Reserved.**

**401.3 Modifications to existing systems.** In modifying or adding to existing piping systems, sizes shall be maintained in accordance with this chapter.

**401.4 Additional appliances.** Where an additional appliance is to be served, the existing piping shall be checked to determine if it has adequate capacity for all appliances served. If inadequate, the existing system shall be enlarged as required or separate piping of adequate capacity shall be provided.

**401.5 Identification.** For other than black steel pipe, exposed piping shall be identified by a yellow label marked "Gas" in black letters. The marking shall be spaced at intervals not exceeding 5 feet (1524 mm). The marking shall not be required on pipe located in the same room as the equipment served.

**401.6 Interconnections.** Where two or more meters are installed on the same premises but supply separate consumers, the piping systems shall not be interconnected on the outlet side of the meters.

**401.7 Piping meter identification.** Piping from multiple meter installations shall be marked with an approved permanent identification by the installer so that the piping system supplied by each meter is readily identifiable.

**401.8 Minimum sizes.** All pipe utilized for the installation, extension and alteration of any piping system shall be sized to supply the full number of outlets for the intended purpose and shall be sized in accordance with Section 402.

## **SECTION FGC 402** **PIPE SIZING**

**402.1 General considerations.** Piping systems shall be of such size and so installed as to provide a supply of gas sufficient to meet the maximum demand without undue loss of pressure between the point of delivery and the gas utilization equipment.

**402.2 Maximum gas demand.** The volume of gas to be provided, in cubic feet per hour, shall be

determined directly from the manufacturer's input ratings of the gas utilization equipment served. Where an input rating is not indicated, the gas supplier, equipment manufacturer or a qualified agency shall be contacted, or the rating from Table 402.2 shall be used for estimating the volume of gas to be supplied. The total connected hourly load shall be used as the basis for pipe sizing, assuming that all equipment could be operating at full capacity simultaneously. Where a diversity of load can be established, pipe sizing shall be permitted to be based on such loads.

**TABLE 402.2**  
**APPROXIMATE GAS INPUT FOR TYPICAL APPLIANCES**  
**(Table 402.2 attached to end of document)**

**402.3 Sizing.** Gas piping shall be sized in accordance with one of the following:

1. Pipe sizing tables or sizing equations in accordance with Section 402.4.
2. The sizing tables included in a listed piping system's manufacturer's installation instructions.
3. Other approved engineering methods.
4. Individual outlets to gas ranges shall not be less than .75 inches (19 mm) NPS.

**402.4 Sizing tables and equations.** Where Tables 402.4(1) through 402.4(33) are used to size piping or tubing, the pipe length shall be determined in accordance with Section 402.4.1, 402.4.2 or 402.4.3.

Where Equations 4-1 and 4-2 are used to size piping or tubing, the pipe or tubing shall have smooth inside walls and the pipe length shall be determined in accordance with Section 402.4.1, 402.4.2 or 402.4.3.

**(Equation 4-1 attached to end of document)**

**(Equation 4-2 attached to end of document)**

**TABLE 402.4**  
**Cr AND Y VALUES FOR NATURAL GAS AT STANDARD CONDITIONS**  
**(Table 402.4 revised and original/existing versions attached to end of document)**

**TABLES 402.4(1) through TABLES 402.4(33)**  
**(Tables 402.4(1) through Tables 402.4(33) attached to end of document)**

**402.4.1 Longest length method.** The pipe size of each section of gas piping shall be determined using the longest length of piping from the point of delivery to the most remote outlet and the load of the section.

**402.4.2 Branch length method.** Pipe shall be sized as follows:



1. Pipe size of each section of the longest pipe run from the point of delivery to the most remote outlet shall be determined using the longest run of piping and the load of the section.
2. The pipe size of each section of branch piping not previously sized shall be determined using the length of piping from the point of delivery to the most remote outlet in each branch and the load of the section.

**402.4.3 Hybrid pressure.** The pipe size for each section of higher pressure gas piping shall be determined using the longest length of piping from the point of delivery to the most remote line pressure regulator. The pipe size from the line pressure regulator to each outlet shall be determined using the length of piping from the regulator to the most remote outlet served by the regulator.

**402.5 Allowable pressure drop.** The design pressure loss in any piping system under maximum probable flow conditions, from the point of delivery to the inlet connection of the equipment, shall be such that the supply pressure at the equipment is greater than the minimum pressure required for proper equipment operation.

**402.6 Gas distribution pressures.** No gas distribution piping containing gas at a pressure in excess of ½ psig (3.5 kPa gauge) shall be run within a building, except that pressure not exceeding 3 psig (20 kPa gauge) is permitted for the following uses: (a) commercial (b) industrial (c) other large volume use in which fuel requirements for boiler room equipment exceed 4,000 cubic feet per hour (113.2 m<sup>3</sup>/h) and such large volume use is supplied through separate gas distribution piping to the boiler room. Gas pressure not exceeding 15 psig (100 kPa gauge) is permitted for boiler room equipment in excess of 100,000 cubic feet per hour (2830 m<sup>3</sup>/h) provided the gas distribution piping is installed as provided for in Section 404. The use of pressure in excess of 15 psig (100 kPa gauge) shall be permitted for distribution piping provided all of the requirements of Section 406 are met.

## **SECTION FGC 403** **PIPING MATERIALS**

**403.1 General.** Materials used for piping systems shall be new and comply with the requirements of this chapter or shall be approved.

### **403.1.1 Pipe size and pressure limitations.**

1. All requirements for installation of gas distribution piping with operating pressures at ½ psig (3.5 kPa gauge) or less and above ½ psig (3.5 kPa gauge) shall be in accordance with Chapter 4 of this code.
2. Gas distribution piping operating at a pressure of over ½ psig (3.5 kPa gauge) to 3 psig (20 kPa gauge) and size 4 inches (102 mm) or larger shall be welded.

3. All gas distribution piping operating at a pressure above 3 psig (20 kPa gauge) shall be welded.
4. All welding of gas distribution piping shall be subject to controlled inspection as set forth in Section 406.
5. All piping 4 inches and greater operating at pressure exceeding 3 psig (20 kPa gauge) must be butt welded, subject to controlled inspection and radiographed.
6. Threaded piping may be used up to 4 inches at pressure no greater than ½ psig (3.5 kPa gauge).

**403.2 Used materials.** Used pipe, fittings, valves and other materials shall not be re-used.

**403.3 Other materials.** Material not covered by the standards specifications listed herein shall be investigated and tested to determine that it is safe and suitable for the proposed service, and, in addition, shall be recommended for that service by the manufacturer and shall be approved by the commissioner.

**403.4 Metallic pipe.** Metallic pipe shall comply with Sections 403.4.1 through 403.4.4.

**403.4.1 Cast iron.** Cast-iron pipe shall not be used.

**403.4.2 Steel.** Carbon steel and wrought-iron pipe shall be at least of standard weight and shall comply with one of the following standards:

1. ASME B 36.10, 10M
2. ASTM A 53; or
3. ASTM A 106.

**403.4.3 Copper and brass.** Copper and brass pipe shall not be used.

**403.4.4 Aluminum.** Aluminum-alloy pipe shall not be used.

**403.5 Metallic tubing.** Metallic tubing shall not be used.

**403.6 Reserved.**

**403.7 Workmanship and defects.** Pipe and fittings shall be clear and free from cutting burrs and defects in structure or threading, and shall be thoroughly brushed, and chip and scale blown. Defects in pipe and fittings shall not be repaired. Defective pipe and fittings shall be replaced (see Section 406.1.2).

**403.8 Protective coating.** Where in contact with material or atmosphere exerting a corrosive

action, metallic piping and fittings coated with a corrosion-resistant material shall be used. External coatings or linings used on piping or components shall not be considered as adding strength.

**403.9 Metallic pipe threads.** Metallic pipe and fitting threads shall be taper pipe threads and shall comply with ASME B1.20.1.

**403.9.1 Damaged threads.** Pipe with threads that are stripped, chipped, corroded or otherwise damaged shall not be used. Where a weld opens during the operation of cutting or threading, that portion of the pipe shall not be used.

**403.9.2 Number of threads.** Field threading of metallic pipe shall be in accordance with Table 403.9.2.

**TABLE 403.9.2**  
**SPECIFICATIONS FOR THREADING METALLIC PIPE**  
**(Table 403.9.2 attached to end of document)**

**403.9.3 Thread compounds.** Thread (joint) compounds (pipe dope) shall be resistant to the action of liquefied petroleum gas or to any other chemical constituents of the gases to be conducted through the piping. Use of cotton thread (lamp wick) is prohibited.

**403.10 Metallic piping joints and fittings.** The type of piping joint used shall be suitable for the pressure-temperature conditions and shall be selected giving consideration to joint tightness and mechanical strength under the service conditions. The joint shall be able to sustain the maximum end force caused by the internal pressure and any additional forces caused by temperature expansion or contraction, vibration, fatigue or the weight of the pipe and its contents.

**403.10.1 Pipe joints.** Pipe joints shall be threaded, flanged, or welded.

**403.10.2 Tubing joints.** Tubing joints shall not be used.

**403.10.3 Flared joints.** Flared joints shall not be used.

**403.10.4 Metallic fittings.** Metallic fittings, including valves, strainers and filters, shall comply with the following:

1. Threaded fittings in sizes larger than 4 inches (102 mm) shall not be used.
2. Fittings used with steel or wrought-iron pipe shall be steel or malleable iron.
3. Cast-iron fittings:
  - 3.1. Flanges shall be permitted.
  - 3.2. Bushings shall not be used.

**403.11 Reserved.**

**403.12 Flanges.** All flanges shall comply with ASME B16.1, ASME B16.20, AWWA C111/A21.11 or MSS SP-6. The pressure-temperature ratings shall equal or exceed that required by the application.

**403.12.1 Flange facings.** Standard facings shall be permitted for use under this code. Where 150-pound (1034 kPa) pressure-rated steel flanges are bolted to Class 125 cast-iron flanges, the raised face on the steel flange shall be removed.

**403.13 Flange gaskets.** Material for gaskets shall be capable of withstanding the design temperature and pressure of the piping system, and the chemical constituents of the gas being conducted, without change to its chemical and physical properties. The effects of fire exposure to the joint shall be considered in choosing material. Acceptable materials include metal or non-asbestos fiber and aluminum “O” rings and spiral wound metal gaskets. When a flanged joint is opened, the gasket shall be replaced. Full-face gaskets shall be used with all cast-iron flanges.

## **SECTION FGC 404** **PIPING SYSTEM INSTALLATION**

**404.1 Prohibited locations.** Piping shall not be installed in or through a circulating air duct, trash or clothes chute, chimney or gas vent, ventilating duct, dumbwaiter or elevator shaft. Piping, fixtures, or equipment shall be located so as not to interfere with the normal operation of windows or doors and other exit openings. The following installation limitations shall apply:

- 1. Stair enclosures.** Gas piping shall not be installed within a stair enclosure or required exit or exit way.
- 2. Fire standpipe riser.** Gas piping shall not be installed in any shaft containing standpipe risers.
- 3. Fire pump.** Gas piping or gas consumption devices or any other gas equipment shall not be installed within any space housing a fire pump.
- 4. Fire rated construction.** Gas piping shall not be installed within concealed spaces of fire-rated construction.
- 5. Public corridor.** Gas piping shall not be installed in public corridors providing access to required exits.

**404.2 Piping in solid partitions and walls.** Concealed piping shall not be located in solid partitions and solid walls, unless installed in a chase or casing.

**404.3 Piping in concealed locations.** Portions of a piping system installed in concealed locations shall not have unions, tubing fittings, bushings, compression couplings and swing joints made by combinations of fittings.

**404.4 Piping through foundation wall.** Underground piping, where installed below grade through the outer foundation or basement wall of a building, shall be encased in a protective pipe sleeve. The annular space between the gas piping and the sleeve shall be sealed.

**404.5 Branch take-off.** Branches shall be taken off the riser with not less than a two-elbow swing.

**404.6 Piping in solid floors.** Piping in solid floors shall be laid in channels in the floor and covered in a manner that will allow access to the piping with a minimum amount of damage to the building. Where such piping is subject to exposure to excessive moisture or corrosive substances, the piping shall be protected in an approved manner. As an alternative to installation in channels, the piping shall be installed in a casing of Schedule 40 steel or wrought iron pipe with tightly sealed ends and joints. At least one end shall have a vented outlet piped to a safe location outdoors. The vent terminal shall be outdoors, minimum 18 inches (457 mm) above grade, not under an opening to building or overhang, and shall be installed so as to prevent the entrance of water and insects. Both ends of such casing shall extend not less than 2 inches (51 mm) beyond the point where the pipe emerges from the floor.

**404.7 Above-ground outdoor piping.** All piping installed outdoors shall be elevated not less than 3½ inches (152 mm) above ground and where installed across roof surfaces, shall be elevated not less than 3½ inches (152 mm) above the roof surface. Piping installed above ground, outdoors, and installed across the surface of roofs shall be securely supported to the structure and located where it will be protected from physical damage. Where passing through an outside wall, the piping shall also be protected against corrosion by coating or wrapping with an inert material. Where piping is encased in a protective pipe sleeve, the annular space between the piping and the sleeve shall be sealed. At least one end shall have a vented outlet piped to safe location outdoors. The vent terminal shall be outdoors, minimum 18 inches (457 mm) above grade, not under an opening to building or overhang, and shall be installed so as to prevent the entrance of water and insects.

**404.8 Protection against corrosion.** Metallic pipe exposed to corrosive action, such as soil condition or moisture, shall be protected in an approved manner. Zinc coatings (galvanizing) shall not be deemed adequate protection for gas piping underground. Ferrous metal exposed in exterior locations shall be protected from corrosion. Zinc coatings (galvanizing) shall be deemed adequate protection for gas piping exposed in exterior locations. Where dissimilar metals are joined underground, an insulating coupling or fitting shall be used. Piping shall not be laid in contact with cinders.

**404.8.1 Prohibited use.** Uncoated threaded or socket-welded joints shall not be used in piping in contact with soil or where internal or external crevice corrosion is known to occur.

**404.8.2 Protective coatings and wrapping.** Pipe protective coatings and wrappings shall be approved for the application and shall be factory applied.

**Exception:** Where installed in accordance with the manufacturer's installation instructions, field application of coatings and wrappings shall be permitted for pipe nipples, fittings and

locations where the factory coating or wrapping has been damaged or necessarily removed at joints.

**404.9 Minimum burial depth.** Underground piping systems shall be installed a minimum depth of 24 inches (610 mm) below grade.

**404.10 Trenches.** The trench shall be graded so that the pipe has a firm, substantially continuous bearing on the bottom of the trench.

**404.11 Piping underground beneath buildings.** Piping installed underground beneath buildings is prohibited except where the piping is encased in a conduit of wrought iron or steel pipe designed to withstand the superimposed loads. Such conduit shall extend into an occupiable portion of the building and, at the point where the conduit terminates in the building, the space between the conduit and the gas piping shall be sealed to prevent the possible entrance of any gas leakage. The conduit shall be designed for the same pressure as the pipe. Such conduit shall extend not less than 4 inches (102 mm) outside the building, and shall be vented. The vent terminal shall be outdoors, minimum 18 inches (457 mm) above grade, not under an opening to building or overhang, and shall be installed so as to prevent the entrance of water and insects. The conduit shall be protected from corrosion in accordance with Section 404.8.

**404.12 Outlet closures.** Gas outlets that do not connect to appliances shall be capped gas tight.

**Exception:** Listed and labeled flush-mounted-type quick disconnect devices and listed and labeled gas convenience outlets shall be installed in accordance with the manufacturer's installation instructions.

**404.13 Location of outlets.** The unthreaded portion of piping outlets shall extend not less than 1 inch (25 mm) through finished ceilings and walls and where extending through floors or outdoor patios and slabs, shall not be less than 2 inches (51 mm) above them. The outlet fitting or piping shall be securely supported. Outlets shall not be placed behind doors. Outlets shall be located in the room or space where the appliance is installed.

**Exception:** Listed and labeled flush-mounted-type quick disconnect devices and listed and labeled gas convenience outlets shall be installed in accordance with the manufacturer's installation instructions.

**404.14 Reserved.**

**404.15 Prohibited devices.** A device shall not be placed inside the piping or fittings that will reduce the cross-sectional area or otherwise obstruct the free flow of gas.

**Exception:** Approved gas filters.

**404.16 Testing of piping.** Before any system of piping is put in service or concealed, it shall be tested to ensure that it is gas tight. Testing, inspection and purging of piping systems shall comply with Section 406.

**SECTION FGC 405**  
**RESERVED**

**SECTION FGC 406**  
**INSPECTION, TESTING AND PURGING**

**406.1 General.** Prior to acceptance and initial operation, all piping installations shall be inspected and pressure tested to determine that the materials, design, fabrication, and installation practices comply with the requirements of this code.

**406.1.1 Inspections.** Inspection shall consist of visual examination, during or after manufacture, fabrication, assembly, or pressure tests as appropriate. Supplementary types of nondestructive inspection techniques, such as magnetic-particle, radiographic, ultrasonic, etc., shall not be required unless specifically listed herein or in the engineering design.

**406.1.1.1 Welder's qualifications.** Welders installing gas piping within buildings at any pressure shall be qualified for all pipe sizes, wall thicknesses and all positions in accordance with ASME Boiler and Pressure Vessel Code, Section IX and requalified on an annual basis. The qualification testing shall be performed by an approved agency, and the inspector shall have a minimum radiography qualification of Level II in accordance with the ASNT, Document No. SNT-TC-1A, Supplement A. Copies of the certified welder qualification reports shall be maintained by the welder and shall be made available to the department upon request.

**406.1.1.2 Welding requirements.** All welded gas distribution and meter piping main and branch supplies to customer equipment operating in excess of 3 psig (20 kPa gauge) inside buildings shall be welded; and shall be subject to special inspection in accordance with Chapter 17 of the *New York City Building Code*.

Radiography shall be performed on all butt welds in gas meter and gas distribution piping operating at pressures exceeding 3 psig (20 kPa gauge) within buildings, in accordance with ASME Boiler and Pressure Vessel Code, Section IX.

**406.1.2 Repairs and additions.** In the event repairs or additions are made after the pressure test, the affected piping shall be tested.

**406.1.3 New branches.** Where new branches are installed from the point of delivery to new appliances, only the newly installed branches shall be required to be pressure tested. Connections between the new piping and the existing piping shall be tested with a noncorrosive leak-detecting fluid or other approved leak-detecting methods.

**406.1.4 Section testing.** A piping system shall be permitted to be tested as a complete unit or in sections. Under no circumstances shall a valve in a line be used as a bulkhead between gas in one section of the piping system and test medium in an adjacent section, unless two valves are installed in series with a valved "telltale" located between these valves. A valve shall not

be subjected to the test pressure unless it can be determined that the valve, including the valve-closing mechanism, is designed to safely withstand the test pressure.

**406.1.5 Regulators and valve assemblies.** Regulator and valve assemblies fabricated independently of the piping system in which they are to be installed shall be permitted to be tested with inert gas or air at the time of fabrication.

**406.2 Test medium.** The test medium shall be air, nitrogen, carbon dioxide or an inert gas. Oxygen shall not be used. Fresh water may be used as the test medium only where the required test pressure exceeds 100 psig (689 kPa).

**406.3 Test preparation.** Pipe joints, including welds, shall be left exposed for examination during the test.

**Exception:** Covered or concealed pipe end joints that have been previously tested in accordance with this code.

**406.3.1 Expansion joints.** Expansion joints shall be provided with temporary restraints, if required, for the additional thrust load under test.

**406.3.2 Equipment isolation.** Equipment that is not to be included in the test shall be either disconnected from the piping or isolated by blanks, blind flanges, or caps. Flanged joints at which blinds are inserted to blank off other equipment during the test shall not be required to be tested.

**406.3.3 Equipment disconnection.** Where the piping system is connected to equipment or components designed for operating pressures of less than the test pressure, such equipment or equipment components shall be isolated from the piping system by disconnecting them and capping the outlet(s).

**406.3.4 Valve isolation.** Where the piping system is connected to equipment or components designed for operating pressures equal to or greater than the test pressure, such equipment shall be isolated from the piping system by closing the individual equipment shutoff valve(s).

**406.3.5 Testing precautions.** All testing of piping systems shall be done with due regard for the safety of employees and the public during the test. Bulkheads, anchorage, and bracing suitably designed to resist test pressures shall be installed if necessary. Prior to testing, the interior of the pipe shall be purged to flush out all foreign material including weld splatter, dirt, rags, and other debris left inside the pipe during welding operations and piping installation.

**406.4 Test pressure measurement.** Upon completion of the installation of a section of a gas system or of the entire gas system, and before appliances are connected thereto, the completed section or system shall be verified as to materials, and tested and proven tight as follows:

1. Gas distribution piping shall comply with the following:



- 1.1. Distribution pressures up to ½ psig (3.5 kPa gauge). The completed piping is to be tested with a non-mercury gauge at a pressure of 3 psig (20 kPa gauge) for a minimum of 30 minutes.
- 1.2. Distribution pressures over ½ psig (3.5 kPa gauge) through 3 psig (20 kPa gauge). The completed piping is to be tested at 50 psig (340 kPa gauge) for a minimum of 30 minutes.
- 1.3. Distribution pressures over 3 psig (20 kPa gauge) through 15 psig (100 kPa gauge). The completed piping is to be tested at 100 psig (689 kPa gauge) for a minimum of 1 hour.
- 1.4. Distribution pressures above 15 psig (100 kPa gauge). The completed piping is to be tested to twice the maximum allowable operating pressure, but not less than 100 psig (689 kPa gauge), for a minimum of 1 hour.
- 1.5 Where the test pressure exceeds 125 psig (862 kPa gauge), the test pressure shall not exceed a value that produces a hoop stress in the piping greater than 50 percent of the specified minimum yield strength of the pipe.
2. Meter piping shall be pressure tested in accordance with the requirements of the serving utility. These requirements shall be either the same as those for testing distribution piping in numbered paragraph 1 of this section or, if different, the piping shall be certified by the local utility as being tested in compliance with their requirements.
3. Notwithstanding the above, all factory applied coated and wrapped pipe shall be pressure tested at a minimum of 90 psig (621 kPa gauge). For testing, the piping shall be filled with air or an inert gas, and the source of pressure shall be isolated before the pressure readings are made. All test duration time periods are to be measured after stabilization of testing medium. Fresh water may be used as the test medium only where the required test pressure exceeds 100 psig (689 kPa gauge).

#### **406.4.1 Minimum standards for non-mercury gauges:**

1. This section establishes minimum standards for non-mercury gauges to test gas piping, drainage and vent systems.
2. Each gauge shall meet the following requirements:
  - 2.1. The gauge shall be manufactured and used in accordance with ASME B 40.100, which incorporates ASME B 40.1 and ASME B 40.7, and the manufacturer shall provide with the gauge a written statement that the gauge is manufactured in accordance with such ASME standard;
  - 2.2. The gauge shall be labeled with the name of the manufacturer;

2.3. The gauge shall be kept in a padded separate rigid box and the manufacturer's instructions for use and protection of the gauge shall be complied with;

2.4. The units of measurement "psi" shall appear on the face of the gauge; and

2.5. The gauge shall be kept in good working order.

**406.4.2 Analog gauges used to measure pressure in the magnitude of 3 psig (20 kPa gauge).** Each analog gauge used to measure pressure in the magnitude of 3 psig (20 kPa gauge) shall meet the following requirements in addition to satisfying the minimum requirements set forth in section 406.4.1:

1. The face of the gauge shall not be smaller than 2¼ inches (57 mm) in diameter;
2. The gauge shall have a minimum of 270° dial arc;
3. The gauge shall be calibrated in increments of not greater than one-tenth of a pound;
4. The range of the gauge shall not exceed 5 psig (34.5 kPa gauge) when a 2¼ inch (57 mm) diameter gauge is used;
5. The 1/10 psig (.69 kPa gauge) interval on the gauge shall not be smaller than 1/10 of an inch ( 2.5 mm) of arc;
6. The gauge shall be provided with an effective stop for the indicating pointer at the zero point;
7. The gauge shall be protected from excessive pressure with a shut off valve and prior to using the 5 psig ( 34.5 kPa gauge) the snifter valve shall be tested with a tire gauge to determine the magnitude of pressure; and
8. The gauge shall have a calibration screw.

**406.4.3 Analog gauges used to measure pressure in the magnitude of 5 psig (34.5 kPa gauge).** Each analog gauge used to measure pressure in the magnitude of 5 psig (34.5 kPa gauge) shall meet the following requirements in addition to satisfying the minimum requirements set forth in Section 406.4.1:

1. The face of the gauge shall not be smaller than 2¼ inches (57 mm) in diameter;
2. The gauge shall have a minimum of 270° dial arc;
3. The gauge shall be calibrated in increments not greater than one-fifth of a pound;

4. The range of the gauge shall not exceed 10 psig (69 kPa gauge) when a 2¼ inch (57 mm) diameter gauge is used;
5. The 1/5 interval on the gauge shall not be smaller than 1/10 of an inch of arc;
6. The gauge shall be provided with an effective stop for the indicating pointer at the zero point;
7. The gauge shall be protected from excessive pressure with a shut-off valve and prior to using the 10 psig (69 kPa gauge) the snifter valve shall be tested with a tire gauge to determine the magnitude of pressure; and
8. The gauge shall have a calibration screw.

**406.4.4 Digital gauges used to measure pressure in the magnitude of 3 psig (20 kPa gauge) and higher.** Each digital gauge used to measure pressure in the magnitude of 3 psig (20 kPa gauge) and higher shall meet the following requirements in addition to satisfying the minimum requirements set forth in Section 406.4.1:

1. The gauge shall have a minimum reading of 1/100 of a psig, and
2. An extra charged battery shall be readily available for immediate use with the gauge.

**406.4.5 Witnessing tests of gas piping systems.** Tests of gas piping systems in accordance with this code shall be witnessed by department plumbing inspectors, or approved agencies. The department shall prescribe qualifications for individuals who are authorized to witness such tests on behalf of approved agencies, including but not limited to the requirement that such individuals shall be licensed master plumbers or registered design professionals with not less than five years experience in the inspection and testing of gas piping systems.

**406.4.6 Notification.** The holder of the plumbing permit shall give at least two days prior written notice to the commissioner that the plumbing work covered by the permit is ready for inspections and test.

**406.5 Detection of leaks and defects.** The piping system shall withstand the test pressure specified without showing any evidence of leakage or other defects. Any reduction of test pressures as indicated by pressure gauges shall be deemed to indicate the presence of a leak unless such reduction can be readily attributed to some other cause.

**406.5.1 Detection methods.** The leakage shall be located by means of an approved gas detector, a noncorrosive leak detection fluid, or other approved leak detection methods. Matches, candles, open flames, or other methods that could provide a source of ignition shall not be used.

**406.5.2 Corrections.** Where leakage or other defects are located, the affected portion of the piping system shall be repaired or replaced and retested.

**406.6 System and equipment leakage test.** Leakage testing of systems and equipment shall be in accordance with Sections 406.6.1 through 406.6.4.

**406.6.1 Test gases.** Leak checks using fuel gas shall be permitted in piping systems that have been pressure tested in accordance with Section 406.

**406.6.2 Before turning gas on.** Before gas is introduced into a system of new gas piping, the entire system shall be inspected to determine that there are no open fittings or ends and that all valves at unused outlets are closed and plugged or capped.

**406.6.2.1 Establishing gas supply.** It shall be unlawful for any utility company to supply gas to a building, place or premises in which new meters other than replacement are required until a certificate of approval of gas installation from the department is filed with such utility company. When new gas service piping has been installed it shall be locked-off by the utility either by locking the gas service line valve or by installing a locking device on the outside gas service line valve. The lock shall not be removed until the gas meter piping (other than utility-owned) and gas distribution piping has been inspected and certified as required by the department as being ready for service.

**406.6.2.2 Alterations to gas piping systems.** When alterations, extensions or repairs to existing gas meter piping or gas distribution piping requires the shut-off of gas flow to a building, the utility shall be notified by the owner or his or her authorized representative.

**406.6.3 Test for leakage.** Immediately after the gas is turned on into a new system or into a system that has been initially restored after an interruption of service, the piping system shall be tested for leakage. Where leakage is indicated, the gas supply shall be shut off until the necessary repairs have been made.

**406.6.4 Placing equipment in operation.** Gas utilization equipment shall be permitted to be placed in operation after the piping system has been tested and determined to be free of leakage and purged in accordance with Section 406.7.2.

**406.6.4.1 Requirements for placing equipment in operation.** The following will be required prior to placing equipment in operation as applicable:

- 1. Required fire protections systems (sprinkler or standpipe) are completed, inspected and ready for service.**
- 2. Such equipment and related gas pipings are inspected by the department or authorized inspector.**
- 3. Associated fire suppression system is inspected and approved by the Fire Department.**

**406.7 Purging.** Purging of piping shall comply with Sections 406.7.1 through 406.7.4.

**406.7.1 Removal from service.** Where gas piping is to be opened for servicing, addition, or modification, the section to be worked on shall be turned off from the gas supply at the nearest convenient point, and the line pressure vented to the outdoors, or to ventilated areas of sufficient size to prevent accumulation of flammable mixtures. The remaining gas in this section of pipe shall be displaced with an inert gas as required by Table 406.7.1.

**TABLE 406.7.1**  
**LENGTH OF PIPING REQUIRING PURGING WITH INERT GAS FOR SERVICING**  
**OR MODIFICATION**  
**(Table 406.7.1 attached to end of document)**

**406.7.2 Placing in operation.** Where piping full of air is placed in operation, the air in the piping shall be displaced with fuel gas, except where such piping is required by Table 406.7.2 to be purged with an inert gas prior to introduction of fuel gas. The air can be safely displaced with fuel gas provided that a moderately rapid and continuous flow of fuel gas is introduced at one end of the line and air is vented out at the other end. The fuel gas flow shall be continued without interruption until the vented gas is free of air. The point of discharge shall not be left unattended during purging. After purging, the vent shall then be closed. Where required by Table 406.7.2, the air in the piping shall first be displaced with an inert gas, and the inert gas shall then be displaced with fuel gas.

**TABLE 406.7.2**  
**LENGTH OF PIPING REQUIRING PURGING WITH**  
**INERT GAS BEFORE PLACING IN OPERATION**  
**(Table 406.7.2 attached to end of document)**

**406.7.3 Discharge of purged gases.** The open end of piping systems being purged shall not discharge into confined spaces or areas where there are sources of ignition unless precautions are taken to perform this operation in a safe manner by ventilation of the space, control of purging rate, and elimination of all hazardous conditions.

**406.7.4 Placing equipment in operation.** After the piping has been readied for operation, all equipment shall be purged and then placed in operation, as necessary.

**SECTION FGC 407**  
**PIPING SUPPORT**

**407.1 General.** Piping shall be provided with support in accordance with Section 407.2. In addition, when earthquake loads are applicable in accordance with the *New York City Building Code*, a detailed piping system stress analysis including seismic analysis shall be performed. The pipe supports and restraints shall be designed and installed to accommodate the resultant seismic forces, moments and displacements from this stress analysis in accordance with the *New York City Building Code*.

**407.2 Design and installation.** Piping shall be supported with pipe hooks, metal pipe straps, bands, brackets, or hangers suitable for the size of piping, of adequate strength and quality, and

located at intervals so as to prevent or damp out excessive vibration. Piping shall be anchored to prevent undue strains on connected equipment and shall not be supported by other piping. Pipe hangers and supports shall conform to the requirements of MSS SP-58 and shall be spaced in accordance with Section 415. Supports, hangers, and anchors shall be installed so as not to interfere with the free expansion and contraction of the piping between anchors. All parts of the supporting equipment shall be designed and installed so they will not be disengaged by movement of the supported piping.

## **SECTION FGC 408** **DRIPS AND SLOPED PIPING**

**408.1 Slopes.** Piping for other than dry gas conditions shall be sloped not less than ¼ inch in 15 feet (6.3 mm in 4572 mm) to prevent traps. The local gas supplier/utility company should be consulted to determine the type of fuel gas available for the intended service.

**408.2 Drips.** Where the local gas supplier/utility company requires, a manufactured test fitting or drip leg shall be installed downstream of a lockable supply/riser valve in accordance with the requirements for installation of the serving utility. No other locations will be allowed to prevent additional unapproved gas connections.

**408.3 Reserved.**

**408.4 Sediment trap.** Where a sediment trap is not incorporated as part of the gas utilization equipment, a sediment trap shall be installed downstream of the equipment shutoff valve as close to the inlet of the equipment as practical. The sediment trap shall be either a tee fitting with a capped nipple in the bottom opening of the run of the tee or other device approved as an effective sediment trap. Illuminating appliances, ranges, clothes dryers and outdoor grills need not be so equipped.

## **SECTION FGC 409** **SHUTOFF VALVES**

**409.1 General.** Piping systems shall be provided with shutoff valves in accordance with this section.

**409.1.1 Valve approval.** Shutoff valves shall be of an approved type. Shutoff valves shall be constructed of materials compatible with the piping. Shutoff valves installed in a portion of a piping system operating above 0.5 psig (3.5 kPa gauge) shall comply with ASME B 16.33. Shutoff valves installed in a portion of a piping system operating at 0.5 psig (3.5 kPa gauge) or less shall comply with ANSI Z 21.15 or ASME B 16.33.

**409.1.2 Prohibited locations.** Shutoff valves shall be prohibited in concealed locations and furnace plenums.

**409.1.3 Access to shutoff valves.** Shutoff valves shall be located in places so as to provide access for operation and shall be installed so as to be protected from damage.

**409.2 Meter valve.** Every meter shall be equipped with a shutoff valve located on the supply side of the meter.

**409.3 Shutoff valves for multiple-house line systems.** Where a single meter is used to supply gas to more than one building or tenant, a separate shutoff valve shall be provided for each building or tenant.

**409.3.1 Multiple tenant buildings.** In multiple tenant buildings, where a common piping system is installed to supply other than one- and two-family dwellings, shutoff valves shall be provided for each tenant. Each tenant shall have access to the shutoff valve serving that tenant's space.

**409.3.2 Individual buildings.** In a common system serving more than one building, shutoff valves shall be installed outdoors at each building.

**409.3.3 Identification of shutoff valves.** Each house line shutoff valve shall be plainly marked with an identification tag attached by the installer so that the piping systems supplied by such valves are readily identified.

**409.4 MP regulator valves.** A listed shutoff valve shall be installed immediately ahead of each MP regulator.

**409.5 Equipment shutoff valve.** Each appliance shall be provided with a shutoff valve separate from the appliance. The shutoff valve shall be located in the same room as the appliance, not further than 6 feet (1829 mm) from the appliance, and shall be installed upstream from the union, connector or quick disconnect device it serves. Such shutoff valves shall be provided with access.

**Exception:** Shutoff valves for vented decorative appliances and decorative appliances for installation in vented fireplaces shall not be prohibited from being installed in an area remote from the appliance where such valves are provided with ready access. Such valves shall be permanently identified and shall serve no other equipment. Piping from the shutoff valve to within 3 feet (914 mm) of the appliance connection shall be sized in accordance with Section 402.

**409.5.1 Shutoff valve in fireplace.** Equipment shutoff valves located in the firebox of a fireplace shall be installed in accordance with the appliance manufacturer's instructions.

**409.6 Outside gas cut-off.** An outside gas service line valve or other outside shutoff device or method acceptable to the commissioner shall be provided in accordance with Section E.2 of Appendix E of this code.

## **SECTION FGC 410** **FLOW CONTROLS**

**410.1 Pressure regulators.** A line pressure regulator shall be installed where the appliance is

designed to operate at a lower pressure than the supply pressure. Access shall be provided to pressure regulators. Pressure regulators shall be protected from physical damage. Regulators installed on the exterior of the building shall be approved for outdoor installation.

**410.2 MP regulators.** MP pressure regulators shall comply with the following:

1. The MP regulator shall be approved and shall be suitable for the inlet and outlet gas pressures for the application.
2. The MP regulator shall maintain a reduced outlet pressure under lockup (no-flow) conditions.
3. The capacity of the MP regulator, determined by published ratings of its manufacturer, shall be adequate to supply the appliances served.
4. The MP pressure regulator shall be provided with access. Where located indoors, the regulator shall be vented to the outdoors or shall be equipped with a leak-limiting device, in either case complying with Section 410.3.
5. A tee fitting with one opening capped or plugged shall be installed between the MP regulator and its upstream shutoff valve. Such tee fitting shall be positioned to allow connection of a pressure-measuring instrument and to serve as a sediment trap.
6. A tee fitting with one opening capped or plugged shall be installed not less than 10 pipe diameters downstream of the MP regulator outlet. Such tee fitting shall be positioned to allow connection of a pressure-measuring instrument.

**410.3 Venting of regulators.** Pressure regulators that require a vent shall have an independent vent to the outside of the building. The vent shall be designed to prevent the entry of water or foreign objects. The vent terminal shall be outdoors, a minimum of 18 inches (457 mm) above grade, not under an opening to building or overhang, and shall be installed so as to prevent the entrance of water and insects.

**Exception:** A vent to the outside of the building is not required for regulators less than 1 ¼ inches NPS equipped with and labeled for utilization with approved vent-limiting devices installed in accordance with the manufacturer's instructions.

## **SECTION FGC 411** **APPLIANCE CONNECTIONS**

**411.1 Connecting appliances.** Appliances shall be connected to the piping system by one of the following:

1. Rigid metallic pipe and fittings. Space heaters and water heaters within dwelling units shall be connected using rigid piping and fittings only. Use of semirigid (flexible) metallic tubing, fittings, appliance connectors, or quick-disconnect devices is not permitted for this



application.

2. Semirigid (flexible) metallic tubing and metallic fittings. Lengths shall not exceed 6 feet (1829 mm) and shall be located entirely in the same room as the appliance. Semirigid metallic tubing shall not enter a motor-operated appliance through an unprotected knockout opening.
3. Listed and labeled appliance connectors installed in accordance with the manufacturer's installation instructions and located entirely in the same room as the appliance.
4. Listed and labeled quick-disconnect devices used in conjunction with listed and labeled appliance connectors.
5. Listed and labeled convenience outlets used in conjunction with listed and labeled appliance connectors.
6. Listed and labeled appliance connectors complying with ANSI Z 21.69 and listed for use with food service equipment having casters, or that is otherwise subject to movement for cleaning, and other large movable equipment.

**411.1.1 Protection from damage.** Connectors and tubing shall be installed so as to be protected against physical damage.

**411.1.2 Appliance fuel connectors.** Connectors shall have an overall length not to exceed 3 feet (914 mm), except for range and domestic clothes dryer connectors, which shall not exceed 6 feet (1829 mm) in length. Connectors shall not be concealed within, or extended through, walls, floors, partitions, ceilings or appliance housings. A shutoff valve not less than the nominal size of the connector shall be installed ahead of the connector in accordance with Section 409.5. Connectors shall be sized to provide the total demand of the connected appliance.

**Exception:** Fireplace inserts factory equipped with grommets, sleeves, or other means of protection in accordance with the listing of the appliance.

**411.1.3 Movable appliances.** Where appliances are equipped with casters or are otherwise subject to periodic movement or relocation for purposes such as routine cleaning and maintenance, such appliances shall be connected to the supply system piping by means of an approved flexible connector designed and labeled for the application. Such flexible connectors shall be installed and protected against physical damage in accordance with the manufacturer's installation instructions.

## **SECTION FGC 412**

### **LIQUEFIED PETROLEUM GAS MOTOR VEHICLE FUEL-DISPENSING STATIONS**

**412.1 Applicability.** Motor fuel-dispensing facilities for LP-gas fuel shall be designed and operated in accordance with the *New York City Fire Code*.

412.2 Reserved.

412.3 Reserved.

412.4 Reserved.

412.5 Reserved.

412.6 Reserved.

412.7 Reserved.

412.8 Reserved.

### **SECTION FGC 413**

#### **COMPRESSED NATURAL GAS MOTOR VEHICLE FUEL-DISPENSING STATIONS**

**413.1 Applicability.** Motor fuel-dispensing facilities for CNG fuel shall be designed and operated in accordance with the *New York City Fire Code*.

413.2 Reserved.

413.3 Reserved.

413.4 Reserved.

413.5 Reserved.

413.6 Reserved.

413.7 Reserved.

413.8 Reserved.

### **SECTION FGC 414**

#### **RESERVED**

### **SECTION FGC 415**

#### **PIPING SUPPORT INTERVALS**

**415.1 Interval of support.** Piping shall be supported at intervals not exceeding the spacing specified in Table 415.1.

#### **TABLE 415.1**

#### **SUPPORT OF PIPING**

**(Table 415.1 attached to end of document)**

**CHAPTER 5**  
**CHIMNEYS AND VENTS**

**SECTION FGC 501**  
**GENERAL**

**501.1 Scope.** This chapter shall govern the installation, alteration, maintenance, design, minimum safety requirements, repair and approval of factory-built chimneys, chimney liners, vents and connectors, field built chimneys and connectors and the utilization of masonry chimneys serving gas-fired appliances. The requirements for the installation, maintenance, repair and approval of factory-built chimneys, chimney liners, vents and connectors serving appliances burning fuels other than fuel gas shall be regulated by the *New York City Mechanical Code*. The construction, repair, maintenance and approval of masonry chimneys shall be regulated by the *New York City Building Code*.

**501.1.1 Adjoining chimneys and vents.** Adjoining chimneys and vents shall be in accordance with Sections 501.1.1.1 to 501.1.1.8.

**501.1.1.1 Responsibility of owner of taller building.** Whenever a building is erected, enlarged, or increased in height so that any portion of such building, except chimneys or vents, extends higher than the top of any previously constructed chimneys or vents within 100 feet (30 480 mm), the owner of such new or altered building shall have the responsibility of altering such chimneys or vents to make them conform with the requirements of this chapter. A chimney or vent that is no longer connected with a fireplace or combustion or other equipment for which a chimney or vent was required, shall be exempt from this requirement. Such alterations shall be accomplished by one of the following means or a combination thereof:

- 1. Carry up the previously constructed chimneys or vents to the height required in this chapter.**
- 2. Offset such chimneys or vents to a distance beyond that required in Chapter 5 of this code from the new or altered building provided that the new location of the outlet of the offset chimney or vent shall otherwise comply with the requirements of this chapter.**
- 3. Such requirements shall not dispense with or modify any additional requirements that may be applicable pursuant to rules of the New York City Department of Environmental Protection.**

**501.1.1.2 Protection of draft.** After the alteration of a chimney or vent as required by this section, it shall be the responsibility of the owner of the new or altered building to provide any mechanical equipment or devices necessary to maintain the proper draft in the equipment.

**501.1.1.3 Written notification.** The owner of the new or altered building shall notify the owner of the building affected in writing at least forty-five days before starting the work required and request written consent to do such work. Such notice shall be accompanied by plans indicating the manner in which the proposed alterations are to be made.

**501.1.1.4 Approval.** The plans and method of alteration shall be subject to the approval of the commissioner.

**501.1.1.5 Refusal of consent.** If consent is not granted by the owner of the previously constructed building to do the alteration work required by this section, such owner shall signify his or her refusal in writing to the owner of the new or altered building and to the commissioner; and the owner of the new or altered building having submitted plans that conform to the requirements of this section, shall thereupon be released from any responsibility for the proper operation of the equipment due to loss of draft and for any health hazard or nuisance that may occur as a result of the new or altered building. Such responsibilities shall then be assumed by the owner of the previously constructed building. Similarly, should such owner fail to grant consent within forty-five days from the date of written request or fail to signify his or her refusal, he or she shall then assume all responsibilities as prescribed above.

**501.1.1.6 Procedure.** It shall be the obligation of the owner of the new or altered building to:

1. Schedule this work so as to create a minimum of disturbance to the occupants of the affected building; and
2. Provide such essential services as are normally supplied by the equipment while it is out of service; and
3. Where necessary, support such extended chimneys, vents and equipment from this building or to carry up such chimneys or vents within his or her building; and
4. Provide for the maintenance, repair, and/or replacement of such extensions and added equipment; and
5. Make such alterations of the same material as the original chimney or vent so as to maintain the same quality and appearance, except where the affected owner of the chimney or vent shall give his or her consent to do otherwise. All work shall be done in such fashion as to maintain the architectural aesthetics of the existing building. Where there is practical difficulty in complying strictly with the provisions of this Item, the commissioner may permit an equally safe alternative.

**501.1.1.7 Existing violations.** Any existing violations on the previously constructed equipment shall be corrected by the owner of the equipment before any equipment is added or alterations made at the expense of the owner of the new or altered building.

**501.1.1.8 Variance.** The commissioner may grant a variance in accordance with the provisions of this code.

**501.2 General.** Every appliance shall discharge the products of combustion to the outdoors, except for appliances exempted by Section 501.8.

**501.2.1 Design.** Chimneys and vents shall be designed and constructed so as to provide the necessary draft and capacity for each appliance connected to completely exhaust the products of combustion to the outside air. The temperature on adjacent combustible surfaces shall not be raised above 160°F (71°C). Condensation shall not be developed to an extent that can cause deterioration of the chimney or vent.

**501.2.2 Outlets.** The outlet shall be arranged that the flue gases are not directed so that they jeopardize people, overheat combustible structures, or enter building openings in the vicinity of the outlet. Gas fired appliances shall be vented in accordance with this code and NFPA 54.

**501.2.3 Support.** Chimneys and vents shall not be supported by the equipment they serve unless such equipment has been specifically designed for such loads.

**501.3 Masonry chimneys.** Masonry chimneys shall be constructed in accordance with Section 503.5.3 and the *New York City Building Code*.

**501.4 Minimum size of chimney or vent.** Chimneys and vents shall be sized in accordance with Section 504.

**501.5 Abandoned inlet openings.** Abandoned inlet openings in chimneys and vents shall be closed by an approved method.

**501.6 Positive pressure.** Where an appliance equipped with a mechanical forced draft system creates a positive pressure in the venting system, the venting system shall be designed for positive pressure applications.

**501.7 Connection to fireplace.** Connection of appliances to chimney flues serving fireplaces shall be in accordance with Sections 501.7.1 through 501.7.3.

**501.7.1 Closure and access.** A noncombustible seal shall be provided below the point of connection to prevent entry of room air into the flue. Means shall be provided for access to the flue for inspection and cleaning.

**501.7.2 Connection to factory-built fireplace flue.** An appliance shall not be connected to a flue serving a factory-built fireplace unless the appliance is specifically listed for such installation. The connection shall be made in accordance with the appliance manufacturer's installation instructions.

**501.7.3 Connection to masonry fireplace flue.** A connector shall extend from the appliance to the flue serving a masonry fireplace such that the flue gases are exhausted directly into the flue. The connector shall be accessible or removable for inspection and cleaning of both the

connector and the flue. Listed direct connection devices shall be installed in accordance with their listing.

**501.8 Equipment not required to be vented.** The following appliances shall not be required to be vented:

1. Ranges.
2. Built-in domestic cooking units listed and marked for optional venting.
3. Hot plates and laundry stoves.
4. Type 1 clothes dryers (Type 1 clothes dryers shall be exhausted in accordance with the requirements of Section 614).
5. A single booster-type automatic instantaneous water heater, where designed and used solely for the sanitizing rinse requirements of a dishwashing machine, provided that the heater is installed in a commercial kitchen having a mechanical exhaust system. Where installed in this manner, the draft hood, if required, shall be in place and unaltered and the draft hood outlet shall be not less than 36 inches (914 mm) vertically and 6 inches (152 mm) horizontally from any surface other than the heater.
6. Refrigerators.
7. Counter appliances.
8. Specialized equipment of limited input such as laboratory burners and gas lights.

Where the appliances and equipment listed in Items 5 through 11 above are installed so that the aggregate input rating exceeds 20 British thermal units (Btu) per hour per cubic foot (207 watts per m<sup>3</sup>) of volume of the room or space in which such appliances and equipment are installed, one or more shall be provided with venting systems or other approved means for conveying the vent gases to the outdoor atmosphere so that the aggregate input rating of the remaining unvented appliances and equipment does not exceed the 20 Btu per hour per cubic foot (207 watts per m<sup>3</sup>) figure. Where the room or space in which the equipment is installed is directly connected to another room or space by a doorway, archway, or other opening of comparable size that cannot be closed, the volume of such adjacent room or space shall be permitted to be included in the calculations.

**501.9 Chimney entrance.** Connectors shall connect to a masonry chimney flue at a point not less than 12 inches (305 mm) or one chimney diameter above the lowest portion of the interior of the chimney flue.

**501.10 Connections to exhauster.** Appliance connections to a chimney or vent equipped with a power exhauster shall be made on the inlet side of the exhauster. Joints and vent systems on the positive pressure side of the exhauster shall be sealed to prevent flue-gas leakage as specified by the manufacturer's installation instructions for the exhauster.

**501.11 Masonry chimneys.** Masonry chimneys utilized to vent appliances shall be located, constructed and sized as specified in the manufacturer's installation instructions for the appliances being vented and Section 503.

**501.12 Residential and low-heat appliances flue lining systems.** Flue lining systems for use with residential-type and low-heat appliances shall be limited to the following:

1. Clay flue lining complying with the requirements of ASTM C 315 or equivalent. Clay flue lining shall be installed in accordance with the *New York City Building Code*.
2. Listed chimney lining systems complying with UL 1777.
3. Other approved materials that will resist, without cracking, softening or corrosion, flue gases and condensate at temperatures up to 1,800°F (982°C).

**501.13 Category I appliance flue lining systems.** Flue lining systems for use with Category I appliances shall be limited to the following:

1. Flue lining systems complying with Section 501.12.
2. Chimney lining systems listed and labeled for use with gas appliances with draft hoods and other Category I gas appliances listed and labeled for use with Type B vents.

**501.14 Category II, III and IV appliance venting systems.** The design, sizing and installation of vents for Category II, III and IV appliances shall be in accordance with the appliance manufacturer's installation instructions.

**501.15 Existing chimneys and vents.** Where an appliance is permanently disconnected from an existing chimney or vent, or where an appliance is connected to an existing chimney or vent during the process of a new installation, the chimney or vent shall comply with Sections 501.15.1 through 501.15.4.

**501.15.1 Size.** The chimney or vent shall be resized as necessary to control flue gas condensation in the interior of the chimney or vent and to provide the appliance or appliances served with the required draft. For Category I appliances, the resizing shall be in accordance with Section 502.

**501.15.2 Flue passageways.** The flue gas passageway shall be free of obstructions and combustible deposits and shall be cleaned if previously used for venting a solid or liquid fuel-burning appliance or fireplace. The flue liner, chimney inner wall or vent inner wall shall be continuous and shall be free of cracks, gaps, perforations or other damage or deterioration which would allow the escape of combustion products, including gases, moisture and creosote.

**501.15.3 Cleanout.** Masonry chimney flues shall be provided with a cleanout opening having a minimum height of 6 inches (152 mm). The upper edge of the opening shall be located not

less than 6 inches (152 mm) below the lowest chimney inlet opening. The cleanout shall be provided with a tight-fitting, noncombustible cover of a minimum size of 8 inches (203 mm) by 8 inches (203 mm).

**501.15.4 Clearances.** Chimneys and vents shall have airspace clearance to combustibles in accordance with the *New York City Building Code* and the chimney or vent manufacturer's installation instructions. Noncombustible firestopping or fireblocking shall be provided in accordance with the *New York City Building Code*.

**Exception:** Masonry chimneys equipped with a chimney lining system tested and listed for installation in chimneys in contact with combustibles in accordance with UL 1777, and installed in accordance with the manufacturers instructions, shall not be required to have clearance between combustible materials and exterior surfaces of the masonry chimney.

## **SECTION FGC 502**

### **VENTS**

**502.1 General.** All vents, except as provided in Section 503.7, shall be listed and labeled. Type B and BW vents shall be tested in accordance with UL 441 and labeled or field fabricated in accordance with NFPA 211. Type L vents shall be tested in accordance with UL 641. Vents for Category II and III appliances shall be tested in accordance with UL 1738. Plastic vents for Category IV appliances shall not be required to be listed and labeled where such vents are as specified by the appliance manufacturer and are installed in accordance with the appliance manufacturer's installation instructions.

**502.2 Connectors required.** Connectors shall be used to connect appliances to the vertical chimney or vent, except where the chimney or vent is attached directly to the appliance. Vent connector size, material, construction and installation shall be in accordance with Section 503.

**502.3 Vent application.** The application of vents shall be in accordance with Table 503.4.

**502.4 Insulation shield.** Where vents pass through insulated assemblies, an insulation shield constructed of not less than 26 gage sheet (0.016 inch) (0.4mm) metal shall be installed to provide clearance between the vent and the insulation material. The clearance shall not be less than the clearance to combustibles specified by the vent manufacturer's installation instructions. Where vents pass through attic space, the shield shall terminate not less than 2 inches (51 mm) above the insulation materials and shall be secured in place to prevent displacement. Insulation shields provided as part of a listed vent system shall be installed in accordance with the manufacturer's installation instructions.

**502.5 Installation.** Vent systems shall be sized, installed and terminated in accordance with the vent and appliance manufacturer's installation instructions and Section 503.

**502.6 Support of vents.** All portions of vents shall be adequately supported for the design and weight of the materials employed.



## **SECTION FGC 503** **VENTING OF EQUIPMENT**

**503.1 General.** This section recognizes that the choice of venting materials and the methods of installation of venting systems are dependent on the operating characteristics of the equipment being vented. The operating characteristics of vented equipment can be categorized with respect to (1) positive or negative pressure within the venting system; and (2) whether or not the equipment generates flue or vent gases that might condense in the venting system. See Section 202 for the definition of these vented appliance categories.

**503.2 Venting systems required.** Except as permitted in Sections 503.2.1 through 503.2.4 and 501.8, all equipment shall be connected to venting systems.

**503.2.1 Ventilating hoods.** Ventilating hoods and exhaust systems shall be permitted to be used to vent equipment installed in commercial applications (see Section 503.3.4) and to vent industrial equipment, such as where the process itself requires fume disposal.

**503.2.2 Direct-vent equipment.** Listed direct-vent equipment shall be considered properly vented where installed in accordance with the terms of its listing, the manufacturer's instructions, and Section 503.8.

**503.2.3 Equipment with integral vents.** Equipment incorporating integral venting means shall be considered properly vented when installed in accordance with its listing, the manufacturer's instructions, and Section 503.8.

**503.3 Design and construction.** A venting system shall be designed and constructed so as to develop a positive flow adequate to convey flue or vent gases to the outdoor atmosphere.

**503.3.1 Equipment draft requirements.** A venting system shall satisfy the draft requirements of the equipment in accordance with the manufacturer's instructions.

**503.3.2 Design and construction.** Gas utilization equipment required to be vented shall be connected to a venting system designed and installed in accordance with the provisions of Sections 503.4 through 503.15.

**503.3.3 Mechanical draft systems.** Mechanical draft systems shall comply with the following:

- 1. Mechanical draft systems shall be listed and shall be installed in accordance with the terms of their listing and both the appliance and the mechanical draft system manufacturer's instructions.**
- 2. Equipment, except incinerators, requiring venting shall be permitted to be vented by means of mechanical draft systems of either forced or induced draft design.**
- 3. Forced draft systems and all portions of induced draft systems under positive pressure**

during operation shall be designed and installed so as to prevent leakage of flue or vent gases into a building.

4. Vent connectors serving equipment vented by natural draft shall not be connected into any portion of mechanical draft systems operating under positive pressure.

5. When a mechanical draft system is employed, provision shall be made to prevent the flow of gas to the main burners when the draft system is not performing so as to satisfy the operating requirements of the equipment for safe performance.

6. The exit terminals of mechanical draft systems shall be in compliance with Section 503.8.

**503.3.4 Ventilating hoods and exhaust systems.** Ventilating hoods and exhaust systems shall be permitted to be used to vent gas utilization equipment installed in commercial applications. Where automatically operated equipment is vented through a ventilating hood or exhaust system equipped with a damper or with a power means of exhaust, provisions shall be made to allow the flow of gas to the main burners only when the damper is open to a position to properly vent the equipment and when the power means of exhaust is in operation.

**503.3.5 Circulating air ducts and furnace plenums.** No portion of a venting system shall extend into or pass through any circulating air duct or furnace plenum.

**503.4 Type of venting system to be used.** The type of venting system to be used shall be in accordance with Table 503.4.

**TABLE 503.4**  
**TYPE OF VENTING SYSTEM TO BE USED**  
**(Table 503.4 attached to end of document)**

**503.4.1 Plastic piping.** Plastic piping used for venting equipment listed for use with such venting materials shall be approved.

**503.4.2 Special gas vent.** Special gas vent shall be listed and installed in accordance with the terms of the special gas vent listing and the manufacturers' instructions.

**503.5 Masonry, metal, and factory-built chimneys.** Masonry, metal and factory-built chimneys shall comply with Sections 503.5.1 through 503.5.10.

**503.5.1 Factory-built chimneys.** Factory-built chimneys shall be installed in accordance with their listing and the manufacturers' instructions. Factory-built chimneys used to vent appliances that operate at positive vent pressure shall be listed for such application.

**503.5.2 Metal chimneys.** Metal chimneys shall be built and installed in accordance with NFPA 211.

**503.5.3 Masonry chimneys.** Masonry chimneys shall be built and installed in accordance with Chapter 21 of the *New York City Building Code* and NFPA 211, and shall be lined with approved clay flue lining, a listed chimney lining system, or other approved material that will resist corrosion, erosion, softening, or cracking from vent gases at temperatures up to 1800°F (982°C).

**Exception:** Masonry chimney flues serving listed gas appliances with draft hoods, Category I appliances and other gas appliances listed for use with Type B vent shall be permitted to be lined with a chimney lining system specifically listed for use only with such appliances. The liner shall be installed in accordance with the liner manufacturer's instructions and the terms of the listing. A permanent identifying label shall be attached at the point where the connection is to be made to the liner. The label shall read: "This chimney liner is for appliances that burn gas only. Do not connect to solid or liquid fuel-burning appliances or incinerators."

For information on installation of gas vents in existing masonry chimneys, see Section 503.6.5.

**503.5.4 Chimney termination.** Chimneys serving gas fired equipment shall comply with the appliance listing, the manufacturer's instructions and the following requirements:

1. Chimneys serving appliances less than 600°F (316°C) shall extend at least 3 feet (914 mm) above the highest construction, such as a roof ridge, parapet wall, or penthouse, within 10 feet (3048 mm) of the chimney outlet, whether the construction is on the same building as the chimney or on another building. However, such constructions do not include other chimneys, vents, or open structural framing. Any chimney located beyond 10 feet (3048 mm) from such construction, but not more than the distance determined by Equation 5-1 shall be at least as high as the construction.
2. Chimneys serving appliances between 600°F (316°C) and 1000°F (538°C) shall extend at least 10 feet (3048 mm) above the highest construction, such as a roof ridge, or parapet wall or penthouse within 20 feet (6096 mm) of the chimney outlet, whether the construction is on the same building as the chimney or on another building. However, such constructions do not include other chimneys, and vents or open structural framing. Any chimney located beyond 20 feet (6096 mm) from such construction, but not more than the distance determined by Equation 5-1 shall be at least as high as the construction.
3. Chimneys serving appliances greater than 1000°F shall extend at least 20 feet (6096 mm) above the highest construction, such as roof ridge, parapet wall, penthouse, or other obstruction within 50 feet (15 240 mm) of the chimney outlet, whether the construction is on the same building as the chimney or in another building. However, such constructions do not include other chimneys, vents, or open structural framing. Any chimney located beyond 50 feet (15 240 mm) from such construction but not more than the distance determined by Equation 5-1 shall be at least as high as the construction.

4. Termination caps shall not be permitted and a 3 inch (76 mm) minimum drain installed to receive collected water shall be required. A positive means shall be provided to prevent water from entering the appliance.

**Exception:** Termination caps shall be permitted on listed factory built chimneys.

5. The following equation shall be used for determining the distances referred to above:
6. Decorative shrouds shall not be installed at the termination of factory-built chimneys except where such shrouds are listed and labeled for use with the specific factory-built chimney system and are installed in accordance with the manufacturers' installation instructions.

**(Equation 5-1 attached to end of document)**

**503.5.5 Size of chimneys.** The effective area of a chimney venting system serving listed appliances with draft hoods, Category I appliances, and other appliances listed for use with Type B vents shall be determined in accordance with one of the following methods:

1. The provisions of Section 504.
2. For sizing an individual chimney venting system for a single appliance with a draft hood, the effective areas of the vent connector and chimney flue shall be not less than the area of the appliance flue collar or draft hood outlet, nor greater than seven times the draft hood outlet area.
3. For sizing a chimney venting system connected to two appliances with draft hoods, the effective area of the chimney flue shall be not less than the area of the larger draft hood outlet plus 50 percent of the area of the smaller draft hood outlet, nor greater than seven times the smallest draft hood outlet area.
4. Chimney venting systems using mechanical draft shall be sized in accordance with approved engineering methods.
5. Other approved engineering methods.

**503.5.5.1 Incinerator venting.** Where an incinerator is vented by a chimney serving other gas utilization equipment, the gas input to the incinerator shall not be included in calculating chimney size, provided the chimney flue diameter is not less than 1 inch (25 mm) larger in equivalent diameter than the diameter of the incinerator flue outlet.

**503.5.6 Inspection of chimneys.** Before replacing an existing appliance or connecting a vent connector to a chimney, the chimney passageway shall be examined to ascertain that it is clear and free of obstructions and it shall be cleaned if previously used for venting solid or liquid fuel-burning appliances or fireplaces.

**503.5.6.1 Chimney lining.** Chimneys shall be lined in accordance with NFPA 211.

**Exception:** Existing chimneys shall be permitted to have their use continued when an appliance is replaced by an appliance of similar type, input rating, and efficiency.

**503.5.6.2 Cleanouts.** Cleanouts shall be examined to determine if they will remain tightly closed when not in use.

**503.5.6.3 Unsafe chimneys.** Where inspection reveals that an existing chimney is not safe for the intended application, it shall be repaired, rebuilt, lined, relined, or replaced with a vent or chimney to conform to NFPA 211 and it shall be suitable for the equipment to be vented.

**503.5.6.4 Test run.** All new chimneys shall be test run by the design professional engineer responsible for the testing under operating conditions to demonstrate fire safety and the complete exhausting of smoke and the products of combustion to the outer air. The results of such test run shall be certified as correct by the design professional engineer responsible for the test and shall be submitted in writing to the department.

**503.5.6.5 Requirement of a smoke test.** A smoke test shall be made as outlined below. Any faults or leaks found shall be corrected. Such smoke test shall be witnessed by a representative of the commissioner. In lieu thereof, the commissioner may accept the test report of the design professional engineer responsible for the test which shall be submitted in writing to the department.

**503.5.6.5.1 Smoke test.** To determine the tightness of chimney construction, a smoke test shall be made in accordance with the following conditions and requirements:

- 1. The equipment, materials, power and labor necessary for such test shall be furnished by, and at the expense of, the owner or holder of the work permit.**
- 2. If the test shows any evidence of leakage or other defects, such defects shall be corrected in accordance with the requirement of this chapter and the test shall be repeated until the results are satisfactory.**
- 3. Method of test. The chimney shall be filled with a thick penetrating smoke produced by one or more smoke machines, or smoke bombs, or other equivalent method. As the smoke appears at the stack opening on the roof, such opening shall be tightly closed and a pressure equivalent to one-half inch column of water measured at the base of the stack, shall be applied. The test shall be applied for a length of time sufficient to permit the inspection of the chimney.**

**503.5.7 Chimneys serving equipment burning other fuels.** Chimneys serving equipment burning other fuels shall comply with Sections 503.5.7.1 through 503.5.7.4.

**503.5.7.1 Solid fuel-burning appliances.** Gas utilization equipment shall not be connected to a chimney flue serving a separate appliance designed to burn solid fuel.

**503.5.7.2 Liquid fuel-burning appliances.** Where one chimney flue serves gas utilization equipment and equipment burning liquid fuel, the equipment shall be connected through separate openings or shall be connected through a single opening where joined by a suitable fitting located as close as practical to the chimney. Where two or more openings are provided into one chimney flue, they shall be at different levels. Where the gas utilization equipment is automatically controlled, it shall be equipped with a safety shutoff device.

**503.5.7.3 Combination gas and solid fuel-burning appliances.** A combination gas- and solid fuel-burning appliance shall be permitted to be connected to a single chimney flue where equipped with a manual reset device to shut off gas to the main burner in the event of sustained back draft or flue gas spillage. The chimney flue shall be sized to properly vent the appliance.

**503.5.7.4 Combination gas- and oil fuel-burning appliances.** A listed combination gas- and oil fuel-burning appliance shall be permitted to be connected to a single chimney flue. The chimney flue shall be sized to properly vent the appliance.

**503.5.8 Support of chimneys.** All portions of chimneys shall be supported for the design and weight of the materials employed. Factory-built chimneys shall be supported and spaced in accordance with their listings and the manufacturer's instructions.

**503.5.9 Cleanouts.** Where a chimney that formerly carried flue products from liquid or solid fuel-burning appliances is used with an appliance using fuel gas, an accessible cleanout shall be provided. The cleanout shall have a tight-fitting cover and shall be installed at the base of all chimneys in accordance with the rules of the New York City Department of Environmental Protection. The cleanout shall be gas tight if the chimney is to be of positive pressure.

**503.5.10 Space surrounding lining or vent.** The remaining space surrounding a chimney liner, gas vent, special gas vent, or plastic piping installed within a masonry chimney flue shall not be used to vent another appliance. The insertion of another liner or vent within the chimney as provided in this code and the liner or vent manufacturer's instructions shall not be prohibited.

The remaining space surrounding a chimney liner, gas vent, special gas vent, or plastic piping installed within a masonry, metal or factory-built chimney, shall not be used to supply combustion air. Such space shall not be prohibited from supplying combustion air to direct-vent appliances designed for installation in a solid fuel-burning fireplace and installed in accordance with the listing and the manufacturer's instructions.

**503.6 Gas vents.** Gas vents shall comply with Sections 503.6.1 through 503.6.12 (see Section 202, Definitions).

**503.6.1 Installation, general.** Gas vents shall be installed in accordance with the terms of their listings and the manufacturer's instructions.

**503.6.2 Type B-W vent capacity.** A Type B-W gas vent shall have a listed capacity not less than that of the listed vented wall furnace to which it is connected.

**503.6.3 Roof penetration.** A gas vent passing through a roof shall extend through the roof flashing, roof jack, or roof thimble and shall be terminated by a listed termination cap.

**503.6.4 Offsets.** Type B and Type L vents shall extend in a generally vertical direction with offsets not exceeding 45 degrees (0.79 rad), except that a vent system having not more than one 60-degree (1.04 rad) offset shall be permitted. Any angle greater than 45 degrees (0.79 rad) from the vertical is considered horizontal. The total horizontal length of a vent plus the horizontal vent connector length serving draft-hood-equipped appliances shall not be greater than 75 percent of the vertical height of the vent.

**Exception:** Systems designed and sized as provided in Section 504 or in accordance with other approved engineering methods.

Vents serving Category I fan-assisted appliances shall be installed in accordance with the appliance manufacturer's instructions and Section 504 or other approved engineering methods.

**503.6.5 Gas vents installed within masonry chimneys.** Gas vents installed within masonry chimneys shall be installed in accordance with the terms of their listing and the manufacturer's installation instructions. Gas vents installed within masonry chimneys shall be identified with a permanent label installed at the point where the vent enters the chimney. The label shall contain the following language: "This gas vent is for appliances that burn gas. Do not connect to solid or liquid fuel-burning appliances or incinerators."

**503.6.6 Gas vent terminations.** A gas vent shall terminate in accordance with one of the following:

- 1. Above the roof surface with a listed cap or listed roof assembly.** Gas vents 12 inches (305 mm) in size or smaller with listed caps shall be permitted to be terminated in accordance with Figure 503.6.6, provided that such vents are at least 8 feet (2438 mm) from a vertical wall or similar obstruction. All other gas vents shall terminate not less than 2 feet (610mm) above the highest point where they pass through the roof and at least 2 feet (610 mm) higher than any portion of a building within 10 feet (3048 mm).
- 2. As provided for direct-vent systems in Section 503.2.2.**
- 3. As provided for equipment with integral vents in Section 503.2.3.**
- 4. As provided for mechanical draft systems in Section 503.3.3.**
- 5. As provided for ventilating hoods and exhaust systems in Section 503.3.4.**

However, such constructions do not include chimneys or other vents, or open structural framing. The vent shall be as high as such construction which is located beyond ten feet from the vent and up to and including the distance determined by the following formula:

**(Equation 5-2 attached to end of document)**

**503.6.6.1 Decorative shrouds.** Decorative shrouds shall not be installed at the termination of gas vents except where such shrouds are listed for use with the specific gas venting system and are installed in accordance with the manufacturer's installation instructions.

**503.6.6.2 Rain and debris.** All gas vents shall terminate in an approved vent or cowl, which shall prevent downdrafts and prevent rain and debris from entering the vent.

### **FIGURE 503.6.6**

### **GAS VENT TERMINATION LOCATIONS FOR LISTED CAPS 12 INCHES OR LESS IN SIZE AT LEAST 8 FEET FROM A VERTICAL WALL**

**(Figure 503.6.6 attached to end of document)**

**503.6.7 Minimum height.** A Type B or a Type L gas vent shall terminate at least 5 feet (1524 mm) in vertical height above the highest connected equipment draft hood or flue collar. A Type B-W gas vent shall terminate at least 12 feet (3658 mm) in vertical height above the bottom of the wall furnace.

**503.6.8 Exterior wall penetrations.** A gas vent extending through an exterior wall shall not terminate adjacent to the wall or below eaves or parapets, except as provided in Sections 503.2.3 and 503.3.3.

**503.6.9 Size of gas vents.** Venting systems shall be sized and constructed in accordance with Section 504 or other approved engineering methods acceptable to the commissioner. Gas vents shall also comply with the manufacturers' instructions.

**503.6.9.1 Category I appliances.** The sizing of natural draft venting systems serving one or more listed appliances equipped with a draft hood or appliances listed for use with Type B gas vent, installed in a single story of a building, shall be in accordance with one of the following methods:

1. The provisions of Section 504.
2. For sizing an individual gas vent for a single, draft-hood-equipped appliance, the effective area of the vent connector and the gas vent shall be not less than the area of the appliance draft hood outlet, nor greater than seven times the draft hood outlet area.
3. For sizing a gas vent connected to two appliances with draft hoods, the effective area of the vent shall be not less than the area of the larger draft hood outlet plus 50 percent of the area of the smaller draft hood outlet, nor greater than seven times the



smaller draft hood outlet area.

4. Engineering practices acceptable to the commissioner.

**503.6.9.2 Category II, III, and IV appliances.** The sizing of gas vents for Category II, III, and IV equipment shall be in accordance with the equipment manufacturer's instructions.

**503.6.9.3 Mechanical draft.** Chimney venting systems using mechanical draft shall be designed and sized to develop a positive flow adequate to carry all products of combustion to the outside atmosphere.

**503.6.10 Gas vents serving equipment on more than one floor.** A single or common gas vent shall be permitted in multistory installations to vent Category I equipment located on more than one floor level, provided the venting system is designed and installed in accordance with this section and approved engineering methods.

**503.6.10.1 Equipment separation.** All equipment connected to the common vent shall be located in rooms separated from habitable space. Each of these rooms shall have provisions for an adequate supply of combustion, ventilation, and dilution air that is not supplied from habitable space (see Figure 503.6.10.1).

**503.6.10.2 Sizing.** The size of the connectors and common segments of multistory venting systems for equipment listed for use with Type B double-wall gas vent shall be in accordance with Table 504.3(1) and Figures 503.6.10.2(1) and 503.6.10.2(2), provided:

1. The available total height (H) for each segment of a multistory venting system is the vertical distance between the level of the highest draft hood outlet or flue collar on that floor and the centerline of the next highest interconnection tee (see Figure B-13).
2. The size of the connector for a segment is determined from its gas utilization equipment heat input and available connector rise, and shall not be smaller than the draft hood outlet or flue collar size.
3. The size of the common vertical segment, and of the interconnection tee at the base of that segment, shall be based on the total gas utilization equipment heat input entering that segment and its available total height.

**FIGURE 503.6.10.1**  
**PLAIN VIEW OF PRACTICAL SEPARATION METHOD FOR MULTISTORY GAS**  
**VENTING**  
**(Figure 503.6.10.1 attached to end of document)**

**FIGURE 503.6.10.2(1)**  
**MULTISTORY GAS VENT DESIGN PROCEDURE FOR EACH SEGMENT SYSTEM**  
**(Figure 503.6.10.2(1) attached to end of document)**

**FIGURE 503.6.10.2(2)**  
**MULTISTORY VENT SYSTEMS**  
**(Figure 503.6.10.2(2) attached to end of document)**

**503.6.11 Support of gas vents.** Gas vents shall be supported and spaced in accordance with their listings and the manufacturer's instructions.

**503.6.12 Marking.** Gas vents shall be permanently identified by a label attached to the wall or ceiling at a point where the vent connector enters the gas vent. The label shall read:

"This gas vent is for appliances that burn gas. Do not connect to solid or liquid fuel- burning appliances or incinerators."

**503.7 Single-wall metal pipe.** Single-wall metal pipe vents shall comply with Sections 503.7.1 through 503.7.12.

**503.7.1 Construction.** Single-wall metal pipe shall be constructed of galvanized sheet steel not less than 0.0304 inch (0.7 mm) thick or other approved, noncombustible, corrosion-resistant material.

**503.7.2 Climate protection.** Uninsulated single-wall metal pipe shall not be used outdoors for venting gas utilization equipment.

**503.7.3 Termination.** Single-wall metal pipe shall terminate at least 5 feet (1524 mm) in vertical height above the highest connected equipment draft hood outlet or flue collar. Single-wall metal pipe shall extend at least 2 feet (610 mm) above the highest point where it passes through a roof of a building and at least 2 feet (610 mm) higher than any portion of a building within a horizontal distance of 10 feet (3048 mm) (see Figure 503.5.4). An approved cap or roof assembly shall be attached to the terminus of a single-wall metal pipe (see also Section 503.7.8, Item 3). However, such constructions do not include chimneys or other vents, or open structural framing. The single wall metal pipe shall be as high as such construction which is located beyond ten feet from the vent and up to and including the distance determined by Equation 5-2.

**503.7.4 Limitations of use.** Single-wall metal pipe shall be used only for runs directly from the space in which the equipment is located through the roof or exterior wall to the outdoor atmosphere.

**503.7.5 Roof penetrations.** A pipe passing through a roof shall extend without interruption through the roof flashing, roof jacket, or roof thimble. Where a single-wall metal pipe passes through a roof constructed of combustible material, a noncombustible, non-ventilating thimble shall be used at the point of passage. The thimble shall extend at least 18 inches (457 mm) above and 6 inches (152 mm) below the roof with the annular space open at the bottom and closed only at the top. The thimble shall be sized in accordance with Section 503.10.16.

**503.7.6 Installation.** Single-wall metal pipe shall not originate in any unoccupied attic or concealed space and shall not pass through any attic, inside wall, concealed space, or floor. The installation of a single-wall metal pipe through an exterior combustible wall shall comply with Section 503.10.15. Single-wall metal pipe used for venting an incinerator shall be exposed and readily examinable for its full length and shall have suitable clearances maintained.

**503.7.7 Clearances.** Minimum clearances from single-wall metal pipe to combustible material shall be in accordance with Table 503.7.7. The clearance from single-wall metal pipe to combustible material shall be permitted to be reduced where the combustible material is protected as specified for vent connectors in Table 308.2.

**TABLE 503.7.7-**  
**CLEARANCES FOR CONNECTORS**  
**(Table 503.7.7a attached to end of document)**

**503.7.8 Size of single-wall metal pipe.** A venting system constructed of single-wall metal pipe shall be sized in accordance with one of the following methods and the equipment manufacturer's instructions:

1. For a draft-hood-equipped appliance, in accordance with Section 504.
2. For a venting system for a single appliance with a draft hood, the areas of the connector and the pipe each shall be not less than the area of the appliance flue collar or draft hood outlet, whichever is smaller. The vent area shall not be greater than seven times the draft hood outlet area.
3. Other approved engineering methods.

**503.7.9 Pipe geometry.** Any shaped single-wall metal pipe shall be permitted to be used, provided that its equivalent effective area is equal to the effective area of the round pipe for which it is substituted, and provided that the minimum internal dimension of the pipe is not less than 2 inches (51 mm).

**503.7.10 Termination capacity.** The vent cap or a roof assembly shall have a venting capacity not less than that of the pipe to which it is attached.

**503.7.11 Support of single-wall metal pipe.** All portions of single-wall metal pipe shall be supported for the design and weight of the material employed.

**503.7.12 Marking.** Single-wall metal pipe shall comply with the marking provisions of Section 503.6.12.

**503.8 Venting system termination location.** The location of venting system terminations shall comply with the following:

1. Gas venting systems shall be extended at least 2 feet (610 mm) above the highest construction, such as a roof ridge, parapet wall, or penthouse, within 10 feet (3048 mm) of the vent outlet whether the construction is on the same building as the chimney or on another building. However, such constructions do not include chimneys or other vents, or open structural framing. The vent shall be as high as such construction which is located beyond 10 feet (3048 mm) from the vent and up to and including the distance determined by Equation 5-2.

**Exception:** Direct vent appliances approved by the commissioner and installed in accordance with the manufacturer's instructions.

2. Where permitted, through-the-wall vents for Category II and IV appliances and non-categorized condensing appliances shall not terminate over public walkways or over an area where condensate or vapor could create a nuisance or hazard or could be detrimental to the operation of regulators, relief valves or other equipment. Where local experience indicates that condensate is a problem with Category I and III appliances, this provision shall also apply.
3. A mechanical draft venting system shall terminate at least 3 feet (914 mm) above any forced-air inlet located within 10 feet (3048 mm).

**Exceptions:**

1. This provision shall not apply to the combustion air intake of a direct-vent appliance.
2. This provision shall not apply to the separation of the integral outdoor air inlet and flue gas discharge of listed outdoor appliances.

**503.9 Condensation drainage.** Provision shall be made to collect and dispose of condensate from venting systems serving Category II and IV equipment and noncategorized condensing appliances in accordance with Section 503.8, Item 2.

**503.10 Vent connectors for Category I equipment.** Vent connectors for Category I equipment shall comply with Sections 503.10.1 through 503.10.16.

**503.10.1 Where required.** A vent connector shall be used to connect equipment to a gas vent, chimney, or single-wall metal pipe, except where the gas vent, chimney, or single-wall metal pipe is directly connected to the equipment.

**503.10.2 Materials.** Vent connectors shall be constructed in accordance with Sections 503.10.2.1 through 503.10.2.5.

**503.10.2.1 General.** A vent connector shall be made of noncombustible corrosion-resistant material capable of withstanding the vent gas temperature produced by the equipment and of sufficient thickness to withstand physical damage.

**503.10.2.2 Vent connectors located in unconditioned areas.** Where the vent connector

used for equipment having a draft hood or a Category I appliance is located in or passes through attics, crawl spaces or other unconditioned spaces, that portion of the vent connector shall be listed Type B or Type L or listed vent material or listed material having equivalent insulation properties.

**503.10.2.3 Residential-type appliance connectors.** Where vent connectors for residential-type appliances are not installed in attics or other unconditioned spaces, connectors for listed appliances having draft hoods and for appliances having draft hoods and equipped with listed conversion burners shall be one of the following:

1. Type B or Type L vent material;
2. Galvanized sheet steel not less than 0.018 inch (0.46 mm) thick;
3. Aluminum (1100 or 3003 alloy or equivalent) sheet not less than 0.027 inch (0.69 mm) thick;
4. Stainless steel sheet not less than 0.012 inch (0.31 mm) thick;
5. Smooth interior wall metal pipe having resistance to heat and corrosion equal to or greater than that of Item 2, 3 or 4 above; or
6. A listed vent connector.

Vent connectors shall not be covered with insulation.

**Exception:** Listed insulated vent connectors shall be installed according to the terms of their listing.

**503.10.2.4 Low-heat equipment.** A vent connector for low-heat equipment shall be a factory-built chimney section or steel pipe having resistance to heat and corrosion equivalent to that for the appropriate galvanized pipe as specified in Table 503.10.2.4. Factory-built chimney sections shall be joined together in accordance with the chimney manufacturers' instructions.

**TABLE 503.10.2.4**  
**MINIMUM THICKNESS FOR GALVANIZED STEEL VENT CONNECTORS FOR**  
**LOW-HEAT APPLIANCES**  
**(Table 503.10.2.4 attached to end of document)**

**503.10.2.5 Medium-heat appliances.** Vent connectors for medium-heat equipment and commercial and industrial incinerators shall be constructed of factory-built medium-heat chimney sections or steel of a thickness not less than that specified in Table 503.10.2.5 and shall comply with the following:

1. A steel vent connector for equipment with a vent gas temperature in excess of

1000°F (538°C), measured at the entrance to the connector shall be lined with medium-duty fire brick (ASTM C 64, Type F), or the equivalent.

2. The lining shall be at least 2½ inches (64 mm) thick for a vent connector having a diameter or greatest cross-sectional dimension of 18 inches (457 mm) or less.
3. The lining shall be at least 4½ inches (114 mm) thick laid on the 4½-inch (114 mm) bed for a vent connector having a diameter or greatest cross-sectional dimension greater than 18 inches (457 mm).
4. Factory-built chimney sections, if employed, shall be joined together in accordance with the chimney manufacturers' instructions.

**TABLE 503.10.2.5**

**MINIMUM THICKNESS FOR STEEL VENT CONNECTORS FOR MEDIUM-HEAT EQUIPMENT AND COMMERCIAL AND INDUSTRIAL INCINERATORS VENT CONNECTOR SIZE**

**(Table 503.10.2.5 attached to end of document)**

**503.10.3 Size of vent connector.** Vent connectors shall be sized in accordance with Sections 503.10.3.1 through 503.10.3.5.

**503.10.3.1 Single draft hood and fan-assisted.** A vent connector for equipment with a single draft hood or for a Category I fan-assisted combustion system appliance shall be sized and installed in accordance with Section 504 or other approved engineering methods.

**503.10.3.2 Multiple draft hoods.** For a single appliance having more than one draft hood outlet or flue collar, the manifold shall be constructed according to the instructions of the appliance manufacturer. Where there are no instructions, the manifold shall be designed and constructed in accordance with approved engineering practices. As an alternate method, the effective area of the manifold shall equal the combined area of the flue collars or draft hood outlets and the vent connectors shall have a minimum 1-foot (305 mm) rise.

**503.10.3.3 Multiple appliances.** Where two or more appliances are connected to a common vent or chimney, each vent connector shall be sized in accordance with Section 504 or other approved engineering methods.

As an alternative method applicable only when all of the appliances are draft hood equipped, each vent connector shall have an effective area not less than the area of the draft hood outlet of the appliance to which it is connected.

**503.10.3.4 Common connector/manifold.** Where two or more gas appliances are vented through a common vent connector or vent manifold, the common vent connector or vent manifold shall be located at the highest level consistent with available headroom and the required clearance to combustible materials and shall be sized in accordance with Section 504 or other approved engineering methods.

As an alternate method applicable only where there are two draft hood equipped appliances, the effective area of the common vent connector or vent manifold and all junction fittings shall be not less than the area of the larger vent connector plus 50 percent of the area of the smaller flue collar outlet.

**503.10.3.5 Size increase.** Where the size of a vent connector is increased to overcome installation limitations and obtain connector capacity equal to the equipment input, the size increase shall be made at the equipment draft hood outlet.

**503.10.4 Two or more appliances connected to a single vent.** Where two or more vent connectors enter a common gas vent, chimney flue, or single-wall metal pipe, the smaller connector shall enter at the highest level consistent with the available headroom or clearance to combustible material. Vent connectors serving Category I appliances shall not be connected to any portion of a mechanical draft system operating under positive static pressure, such as those serving Category III or IV appliances.

**503.10.5 Clearance.** Minimum clearances from vent connectors to combustible material shall be in accordance with Table 503.7.7.

**Exception:** The clearance between a vent connector and combustible material shall be permitted to be reduced where the combustible material is protected as specified for vent connectors in Table 308.2.

**503.10.6 Flow resistance.** A vent connector shall be installed so as to avoid turns or other construction features that create excessive resistance to flow of vent gases.

**503.10.7 Joints.** Joints between sections of connector piping and connections to flue collars and hood outlets shall be fastened by one of the following methods:

1. Sheet metal screws.
2. Vent connectors of listed vent material assembled and connected to flue collars or draft hood outlets in accordance with the manufacturers' instructions.
3. Welding.

**503.10.8 Slope.** A vent connector shall be installed without dips or sags and shall slope upward toward the vent or chimney at least ¼ inch per foot (21 mm/m).

**Exception:** Vent connectors attached to a mechanical draft system installed in accordance with the manufacturers' instructions.

**503.10.9 Length of vent connector.** A vent connector shall be as short as practical and the equipment located as close as practical to the chimney or vent. Except as provided for in Section 503.10.3, the maximum horizontal length of a single-wall connector shall be 75 percent of the height of the chimney or vent. Except as provided for in Section 503.10.3, the

maximum horizontal length of a Type B double-wall connector shall be 100 percent of the height of the chimney or vent. For a chimney or vent system serving multiple appliances, the maximum length of an individual connector, from the appliance outlet to the junction with the common vent or another connector, shall be 100 percent of the height of the chimney or vent.

**503.10.10 Support.** A vent connector shall be supported in accordance with the manufacturer's recommendations for the design and weight of the material employed to maintain clearances and prevent physical damage and separation of joints.

**503.10.11 Chimney connection.** Where entering a flue in a masonry or metal chimney, the vent connector shall be installed above the extreme bottom to avoid stoppage. Where a thimble or slip joint is used to facilitate removal of the connector, the connector shall be firmly attached to or inserted into the thimble or slip joint to prevent the connector from falling out. Means shall be employed to prevent the connector from entering so far as to restrict the space between its end and the opposite wall of the chimney flue (see Section 501.9).

**503.10.12 Inspection.** The entire length of a vent connector shall be provided with ready access for inspection, cleaning, and replacement.

**503.10.13 Fireplaces.** A vent connector shall not be connected to a chimney flue serving a fireplace.

**503.10.14 Passage through ceilings, floors, or walls.** A vent connector shall not pass through any ceiling, floor or fire-resistance-rated wall. A single-wall metal pipe connector shall not pass through any interior wall.

**Exception:** Vent connectors made of listed Type B or Type L vent material and serving listed equipment with draft hoods and other equipment listed for use with Type B gas vents shall be permitted to pass through walls or partitions constructed of combustible material if the connectors are installed with not less than the listed clearance to combustible material.

**503.10.15 Single-wall connector penetrations of combustible walls.** A vent connector made of a single-wall metal pipe shall not pass through a combustible exterior wall unless guarded at the point of passage by a ventilated metal thimble not smaller than the following:

1. For listed appliances equipped with draft hoods and appliances listed for use with Type B gas vents, the thimble shall be not less than 4 inches (102 mm) larger in diameter than the vent connector. Where there is a run of not less than 6 feet (1829 mm) of vent connector in the open between the draft hood outlet and the thimble, the thimble shall be permitted to be not less than 2 inches (51 mm) larger in diameter than the vent connector.
2. For unlisted appliances having draft hoods, the thimble shall be not less than 6 inches (152 mm) larger in diameter than the vent connector.
3. For residential and low-heat appliances, the thimble shall be not less than 12 inches (305



mm) larger in diameter than the vent connector.

**Exception:** In lieu of thimble protection, all combustible material in the wall shall be removed from the vent connector a sufficient distance to provide the specified clearance from such vent connector to combustible material. Any material used to close up such opening shall be noncombustible.

**503.10.16 Medium-heat connectors.** Vent connectors for medium-heat equipment shall not pass through walls or partitions constructed of combustible material.

**503.11 Vent connectors for Category II, III, and IV appliances.** Vent connectors for Category II, III and IV appliances shall be as specified for the venting systems in accordance with Section 503.4.

**503.12 Draft hoods and draft controls.** The installation of draft hoods and draft controls shall comply with Sections 503.12.1 through 503.12.7.

**503.12.1 Equipment requiring draft hoods.** Vented equipment shall be installed with draft hoods.

**Exception:** Incinerators, direct-vent equipment, fan-assisted combustion system appliances, equipment requiring chimney draft for operation, equipment equipped with blast, power, or pressure burners that are not listed for use with draft hoods, and equipment designed for forced venting.

**503.12.2 Installation.** A draft hood supplied with or forming a part of listed vented equipment shall be installed without alteration, exactly as furnished and specified by the equipment manufacturer.

**503.12.2.1 Draft hood required.** If a draft hood is not supplied by the equipment manufacturer where one is required, a draft hood shall be installed, shall be of a listed or approved type and, in the absence of other instructions, shall be of the same size as the equipment flue collar. Where a draft hood is required with a conversion burner, it shall be of a listed or approved type.

**503.12.2.2 Special design draft hood.** Where it is determined that a draft hood of special design is needed or preferable for a particular installation, the installation shall be in accordance with the recommendations of the equipment manufacturer and shall be approved by the department.

**503.12.3 Draft control devices.** Where a draft control device is part of the equipment or is supplied by the equipment manufacturer, it shall be installed in accordance with the manufacturers' instructions. In the absence of manufacturers' instructions, the device shall be attached to the flue collar of the equipment or as near to the equipment as practical.

**503.12.4 Additional devices.** Equipment requiring controlled chimney draft shall be permitted

to be equipped with a listed double-acting barometric-draft regulator installed and adjusted in accordance with the manufacturers' instructions.

**503.12.5 Location.** Draft hoods and barometric draft regulators shall be installed in the same room or enclosure as the equipment in such a manner as to prevent any difference in pressure between the hood or regulator and the combustion air supply.

**503.12.6 Positioning.** Draft hoods and draft regulators shall be installed in the position for which they were designed with reference to the horizontal and vertical planes and shall be located so that the relief opening is not obstructed by any part of the equipment or adjacent construction. The equipment and its draft hood shall be located so that the relief opening is accessible for checking vent operation.

**503.12.7 Clearance.** A draft hood shall be located so its relief opening is not less than 6 inches (152 mm) from any surface except that of the equipment it serves and the venting system to which the draft hood is connected. Where a greater or lesser clearance is indicated on the equipment label, the clearance shall be not less than that specified on the label. Such clearances shall not be reduced.

**503.13 Manually operated dampers.** A manually operated damper shall not be placed in the vent connector for any equipment. Fixed baffles shall not be classified as manually operated dampers.

**503.14 Automatically operated vent dampers.** An automatically operated vent damper shall be of a listed type complete with safety controls to prove open position of the damper before equipment operation.

**503.15 Obstructions.** Devices that retard the flow of vent gases shall not be installed in a vent connector, chimney, or vent. The following shall not be considered as obstructions:

1. Draft regulators and safety controls specifically listed for installation in venting systems and installed in accordance with the terms of their listing.
2. Approved draft regulators and safety controls that are designed and installed in accordance with approved engineering methods.
3. Listed heat reclaimers and automatically operated vent dampers installed in accordance with the terms of their listing.
4. Approved economizers, heat reclaimers, and recuperators installed in venting systems of equipment not required to be equipped with draft hoods, provided that the gas utilization equipment manufacturer's instructions cover the installation of such a device in the venting system and performance in accordance with Sections 503.3 and 503.3.1 is obtained.
5. Vent dampers serving listed appliances installed in accordance with Sections 504.2.1 and 504.3.1 or other approved engineering methods.

**SECTION FGC 504**  
**SIZING OF CATEGORY I APPLIANCE**  
**VENTING SYSTEMS**

**504.1 Definitions.** The following definitions apply to the tables in this section.

**APPLIANCE CATEGORIZED VENT DIAMETER/ AREA.** The minimum vent area/diameter permissible for Category I appliances to maintain a non-positive vent static pressure when tested in accordance with nationally recognized standards.

**FAN-ASSISTED COMBUSTION SYSTEM.** An appliance equipped with an integral mechanical means to either draw or force products of combustion through the combustion chamber or heat exchanger.

**FAN Min.** The minimum input rating of a Category I fan-assisted appliance attached to a vent or connector.

**FAN Max.** The maximum input rating of a Category I fan-assisted appliance attached to a vent or connector.

**NAT Max.** The maximum input rating of a Category I draft-hood-equipped appliance attached to a vent or connector.

**FAN + FAN.** The maximum combined appliance input rating of two or more Category I fan-assisted appliances attached to the common vent.

**FAN + NAT.** The maximum combined appliance input rating of one or more Category I fan-assisted appliances and one or more Category I draft-hood-equipped appliances attached to the common vent.

**NA.** Vent configuration is not allowed due to potential for condensate formation or pressurization of the venting system, or not applicable due to physical or geometric restraints.

**NAT + NAT.** The maximum combined appliance input rating of two or more Category I draft-hood-equipped appliances attached to the common vent.

**504.2 Application of single-appliance vent Tables 504.2(1) through 504.2(5).** The application of Tables 504.2(1) through 504.2(5) shall be subject to the requirements of Sections 504.2.1 through 504.2.15.

**(Tables 504.2(1) through 504.2(5) attached to end of document)**

**504.2.1 Vent obstructions.** These venting tables shall not be used where obstructions, as described in Section 503.15, are installed in the venting system. The installation of vents serving listed appliances with vent dampers shall be in accordance with the appliance manufacturer's instructions or in accordance with the following:

1. The maximum capacity of the vent system shall be determined using the “NAT Max” column.
2. The minimum capacity shall be determined as if the appliance were a fan-assisted appliance, using the “FAN Min” column to determine the minimum capacity of the vent system. Where the corresponding “FAN Min” is “NA,” the vent configuration shall not be permitted and an alternative venting configuration shall be utilized.

**504.2.2 Minimum size.** Where the vent size determined from the tables is smaller than the appliance draft hood outlet or flue collar, the smaller size shall be permitted to be used provided that all of the following requirements are met:

1. The total vent height (H) is at least 10 feet (3048 mm).
2. Vents for appliance draft hood outlets or flue collars 12 inches (305 mm) in diameter or smaller are not reduced more than one table size.
3. Vents for appliance draft hood outlets or flue collars larger than 12 inches (305 mm) in diameter are not reduced more than two table sizes.
4. The maximum capacity listed in the tables for a fan-assisted appliance is reduced by 10 percent ( $0.90 \times$  maximum table capacity).
5. The draft hood outlet is greater than 4 inches (102 mm) in diameter. Do not connect a 3-inch-diameter (76 mm) vent to a 4-inch-diameter (102 mm) draft hood outlet. This provision shall not apply to fan-assisted appliances.

**504.2.3 Vent offsets.** Single-appliance venting configurations with zero (0) lateral lengths in Tables 504.2(1), 504.2(2), and 504.2(5) shall not have elbows in the venting system. For vent configurations with lateral lengths, the venting tables include allowance for two 90-degree (1.57rad) turns. For each elbow up to and including 45 degrees (0.79 rad), the maximum capacity listed in the venting tables shall be reduced by 5 percent. For each elbow greater than 45 degrees (0.79 rad) up to and including 90 degrees (1.57 rad), the maximum capacity listed in the venting tables shall be reduced by 10 percent.

**504.2.4 Zero lateral.** Zero (0) lateral (L) shall apply only to a straight vertical vent attached to a top outlet draft hood or flue collar.

**504.2.5 Reserved.**

**504.2.6 Multiple input rate appliances.** For appliances with more than one input rate, the minimum vent capacity (FAN Min) determined from the tables shall be less than the lowest appliance input rating, and the maximum vent capacity (FAN Max/NAT Max) determined from the tables shall be greater than the highest appliance rating input.

**504.2.7 Liner system sizing.** Listed corrugated metallic chimney liner systems in masonry chimneys shall be sized by using Table 504.2(1) or 504.2(2) for Type B vents with the maximum capacity reduced by 20 percent ( $0.80 \times$  maximum capacity) and the minimum capacity as shown in Table 504.2(1) or 504.2(2). Corrugated metallic liner systems installed with bends or offsets shall have their maximum capacity further reduced in accordance with Section 504.2.3. The 20-percent reduction for corrugated metallic chimney liner systems includes an allowance for one long-radius 90-degree (157 rad) turn at the bottom of the liner.

**504.2.8 Vent area and diameter.** Where the vertical vent has a larger diameter than the vent connector, the vertical vent diameter shall be used to determine the minimum vent capacity, and the connector diameter shall be used to determine the maximum vent capacity. The flow area of the vertical vent shall not exceed seven times the flow area of the listed appliance categorized vent area, flue collar area, or draft hood outlet area unless designed in accordance with approved engineering methods.

**504.2.9 Chimney and vent locations.** Tables 504.2(1), 504.2(2), 504.2(3), 504.2(4) and 504.2(5) shall be used for chimneys and vents not exposed to the outdoors below the roof line. A Type B vent or listed chimney lining system passing through an unused masonry chimney flue shall not be considered to be exposed to the outdoors. Table 504.2(3) in combination with Table 504.3(6) shall be used for clay-tile-lined exterior masonry chimneys, provided all of the following are met:

1. Vent connector is Type B double-wall.
2. Vent connector length is limited to 1½ feet for each inch (18 mm per mm) of vent connector diameter.
3. The appliance is draft hood equipped.
4. The input rating is less than the maximum capacity given by Table 504.2(3).
5. For a water heater, the outdoor design temperature is not less than 5°F (-15°C).
6. For a space-heating appliance, the input rating is greater than the minimum capacity given by Table 504.3(6).

Where these conditions cannot be met, an alternative venting design shall be used, such as a listed chimney lining system.

**Exception:** The installation of vents serving listed appliances shall be permitted to be in accordance with the appliance manufacturer's instructions and the terms of the listing.

**504.2.10 Corrugated vent connector size.** Corrugated vent connectors shall be not smaller than the listed appliance categorized vent diameter, flue collar diameter, or draft hood outlet diameter.

**504.2.11 Vent connector size limitation.** Vent connectors shall not be increased in size more than two sizes greater than the listed appliance categorized vent diameter, flue collar diameter, or draft hood outlet diameter.

**504.2.12 Component commingling.** In a single run of vent or vent connector, different diameters and types of vent and connector components shall be permitted to be used, provided that all such sizes and types are permitted by the tables.

**504.2.13 Table interpolation.** Interpolation shall be permitted in calculating capacities for vent dimensions that fall between the table entries.

**504.2.14 Extrapolation prohibited.** Extrapolation beyond the table entries shall not be permitted.

**504.2.15 Engineering calculations.** For vent heights less than 6 feet (1829 mm) and greater than shown in the tables, engineering methods shall be used to calculate vent capacities. Signed and sealed calculations shall be submitted with filing application.

**504.3 Application of multiple appliance vent Tables 504.3(1) through 504.3(8).** The application of Tables 504.3(1) through 504.3(8) shall be subject to the requirements of Sections 504.3.1 through 504.3.2.5.

**(Tables 504.3(1) through 504.3(8) attached to end of document)**

**504.3.1 Vent obstructions.** These venting tables shall not be used where obstructions, as described in Section 503.15, are installed in the venting system. The installation of vents serving listed appliances with vent dampers shall be in accordance with the appliance manufacturer's instructions or in accordance with the following:

1. The maximum capacity of the vent connector shall be determined using the NAT Max column.
2. The maximum capacity of the vertical vent or chimney shall be determined using the FAN+NAT column when the second appliance is a fan-assisted appliance, or the NAT+NAT column when the second appliance is equipped with a draft hood.
3. The minimum capacity shall be determined as if the appliance were a fan-assisted appliance.
  - 3.1. The minimum capacity of the vent connector shall be determined using the FAN Min column.
  - 3.2. The FAN+FAN column shall be used where the second appliance is a fan-assisted appliance, and the FAN+NAT column shall be used where the second appliance is equipped with a draft hood, to determine whether the vertical vent or chimney configuration is not permitted (NA). Where the vent configuration is NA, the vent

configuration shall not be permitted and an alternative venting configuration shall be utilized.

**504.3.2 Connector length limit.** The vent connector shall be routed to the vent utilizing the shortest possible route. Except as provided in Section 504.3.3, the maximum vent connector horizontal length shall be 1½ feet for each inch (457 mm per mm) of connector diameter as shown in Table 504.3.2.

**TABLE 504.3.2**  
**MAXIMUM VENT CONNECTOR LENGTH**  
**(Table 504.3.2 attached to end of document)**

**504.3.3 Connectors with longer lengths.** Connectors with longer horizontal lengths than those listed in Section 504.3.2 are permitted under the following conditions:

1. The maximum capacity (FAN Max or NAT Max) of the vent connector shall be reduced 10 percent for each additional multiple of the length listed above. For example, the maximum length listed above for a 4-inch (102 mm) connector is 6 feet (1829 mm). With a connector length greater than 6 feet (1829 mm) but not exceeding 12 feet (3658 mm), the maximum capacity must be reduced by 10 percent (0.90 maximum vent connector capacity). With a connector length greater than 12 feet (3658 mm) but not exceeding 18 feet (5486 mm), the maximum capacity must be reduced by 20 percent (0.80 maximum vent capacity).
2. For a connector serving a fan-assisted appliance, the minimum capacity (FAN Min) of the connector shall be determined by referring to the corresponding single appliance table. For Type B double-wall connectors, Table 504.2(1) shall be used. For single-wall connectors, Table 504.2(2) shall be used. The height (H) and lateral (L) shall be measured according to the procedures for a single-appliance vent, as if the other appliances were not present.

**504.3.4 Vent connector manifold.** Where the vent connectors are combined prior to entering the vertical portion of the common vent to form a common vent manifold, the size of the common vent manifold and the common vent shall be determined by applying a 10-percent reduction (0.90 maximum common vent capacity) to the common vent capacity part of the common vent tables. The length of the common vent connector manifold ( $L_M$ ) shall not exceed 1½ feet for each inch (457 mm per mm) of common vent connector manifold diameter (D) (see Figure B-11).

**504.3.5 Common vertical vent offset.** Where the common vertical vent is offset, the maximum capacity of the common vent shall be reduced in accordance with Section 504.3.6. The horizontal length of the common vent offset ( $L_o$ ) shall not exceed 1½ feet for each inch (457 mm per mm) of common vent diameter.

**504.3.6 Elbows in vents.** For each elbow up to and including 45 degrees (0.79 rad) in the common vent, the maximum common vent capacity listed in the venting tables shall be

reduced by 5 percent. For each elbow greater than 45 degrees (0.79 rad) up to and including 90 degrees (1.57 rad), the maximum common vent capacity listed in the venting tables shall be reduced by 10 percent.

**504.3.7 Elbows in connectors.** The vent connector capacities listed in the common vent sizing tables include allowance for two 90-degree (1.57 rad) elbows. For each additional elbow up to and including 45 degrees (0.79 rad), the maximum vent connector capacity listed in the venting tables shall be reduced by 5 percent. For each elbow greater than 45 degrees (0.79 rad) up to and including 90 degrees (1.57 rad), the maximum vent connector capacity listed in the venting tables shall be reduced by 10 percent.

**504.3.8 Common vent minimum size.** The cross-sectional area of the common vent shall be equal to or greater than the cross-sectional area of the largest connector.

**504.3.9 Common vent fittings.** At the point where tee or wye fittings connect to a common vent, the opening size of the fitting shall be equal to the size of the common vent. Such fittings shall not be prohibited from having reduced size openings at the point of connection of appliance vent connectors.

**504.3.10 Connector rise measurement.** Connector rise (R) for each appliance connector shall be measured from the draft hood outlet or flue collar to the centerline where the vent gas streams come together.

**504.3.11 Vent height measurement.** For multiple units of equipment all located on one floor, available total height (H) shall be measured from the highest draft hood outlet or flue collar up to the level of the outlet of the common vent.

**504.3.12 Multistory height measurement.** For multistory installations, available total height (H) for each segment of the system shall be the vertical distance between the highest draft hood outlet or flue collar entering that segment and the centerline of the next higher interconnection tee.

**504.3.13 Multistory lowest portion sizing.** The size of the lowest connector and of the vertical vent leading to the lowest interconnection of a multistory system shall be in accordance with Table 504.2(1) or 504.2(2) for available total height (H) up to the lowest interconnection.

**504.3.14 Multistory common vent offsets.** Where used in multistory systems, vertical common vents shall be Type B double wall and shall be installed with a listed vent cap.

**504.3.15 Multistory common vent offsets.** Offsets in multistory common vent systems shall be limited to a single offset in each system, and systems with an offset shall comply with all of the following:

1. The offset angle shall not exceed 45 degrees (0.79 rad) from vertical.



2. The horizontal length of the offset shall not exceed 1½ feet for each inch (457 mm per mm) of common vent diameter of the segment in which the offset is located.
3. For the segment of the common vertical vent containing the offset, the common vent capacity listed in the common venting tables shall be reduced by 20 percent (0.80 × maximum common vent capacity).
4. A multi-story common vent shall not be reduced in size above the offset.

**504.3.16 Vertical vent maximum size.** Where two or more appliances are connected to a vertical vent or chimney, the flow area of the largest section of vertical vent or chimney shall not exceed seven times the smallest listed appliance categorized vent areas, flue collar area, or draft hood outlet area unless designed in accordance with approved engineering methods.

**504.3.17 Multiple input rate appliances.** For appliances with more than one input rate, the minimum vent connector capacity (FAN Min) determined from the tables shall be less than the lowest appliance input rating, and the maximum vent connector capacity (FAN Max or NAT Max) determined from the tables shall be greater than the highest appliance input rating.

**504.3.18 Liner system sizing.** Listed, corrugated metallic chimney liner systems in masonry chimneys shall be sized by using Table 504.3(1) or 504.3(2) for Type B vents, with the maximum capacity reduced by 20 percent (0.80 × maximum capacity) and the minimum capacity as shown in Table 504.3(1) or 504.3(2). Corrugated metallic liner systems installed with bends or offsets shall have their maximum capacity further reduced in accordance with Sections 504.3.5 and 504.3.6. The 20-percent reduction for corrugated metallic chimney liner systems includes an allowance for one long-radius 90-degree (1.57 rad) turn at the bottom of the liner.

**504.3.19 Chimney and vent location.** Tables 504.3(1), 504.3(2), 504.3(3), 504.3(4), and 504.3(5) shall be used for chimneys and vents not exposed to the outdoors below the roof line. A Type B vent or listed chimney lining system passing through an unused masonry chimney flue shall not be considered to be exposed to the outdoors. Tables 504.3(7) and 504.3(8) shall be used for clay-tile-lined exterior masonry chimneys, provided all of the following conditions are met:

1. Vent connector is Type B double-wall.
2. At least one appliance is draft hood equipped.
3. The combined appliance input rating is less than the maximum capacity given by Table 504.3(7a) for NAT+NAT or Table 504.3(8a) for FAN+NAT.
4. The input rating of each space-heating appliance is greater than the minimum input rating given by Table 504.3(7b) for NAT+NAT or Table 504.3(8b) for FAN+NAT.
5. The vent connector sizing is in accordance with Table 504.3(3).

Where these conditions cannot be met, an alternative venting design shall be used, such as a listed chimney lining system.

**Exception:** Vents serving listed appliances installed in accordance with the appliance manufacturer's instructions and the terms of the listing.

**504.3.20 Connector maximum and minimum size.** Vent connectors shall not be increased in size more than two sizes greater than the listed appliance categorized vent diameter, flue collar diameter, or draft hood outlet diameter. Vent connectors for draft hood-equipped appliances shall not be smaller than the draft hood outlet diameter. Where a vent connector size(s) determined from the tables for a fan-assisted appliance(s) is smaller than the flue collar diameter, the use of the smaller size(s) shall be permitted provided that the installation complies with all of the following conditions:

1. Vent connectors for fan-assisted appliance flue collars 12 inches (305 mm) in diameter or smaller are not reduced by more than one table size [e.g., 12 inches to 10 inches (305 mm to 254 mm) is a one-size reduction] and those larger than 12 inches (305 mm) in diameter are not reduced more than two table sizes [e.g., 24 inches to 20 inches (610 mm to 508 mm) is a two-size reduction].
2. The fan-assisted appliance(s) is common vented with a draft-hood-equipped appliances(s).
3. The vent connector has a smooth interior wall.

**504.3.21 Component commingling.** All combinations of pipe sizes, single-wall, and double-wall metal pipe shall be allowed within any connector run(s) or within the common vent, provided all of the appropriate tables permit all of the desired sizes and types of pipe, as if they were used for the entire length of the subject connector or vent. Where single-wall and Type B double-wall metal pipes are used for vent connectors within the same venting system, the common vent must be sized using Table 504.3(2) or 504.3(4), as appropriate.

**504.3.22 Multiple sizes permitted.** Where a table permits more than one diameter of pipe to be used for a connector or vent, all the permitted sizes shall be permitted to be used.

**504.3.23 Table interpolation.** Interpolation shall be permitted in calculating capacities for vent dimensions that fall between table entries.

**504.3.24 Extrapolation prohibited.** Extrapolation beyond the table entries shall not be permitted.

**504.3.25 Engineering calculations.** For vent heights less than 6 feet (1829 mm) and greater than shown in the tables, engineering methods shall be used to calculate vent capacities.

## **SECTION FGC 505**

**DIRECT-VENT, INTEGRAL VENT,  
MECHANICAL VENT AND  
VENTILATION/EXHAUST HOOD VENTING**

**505.1 General.** The installation of direct-vent and integral vent appliances shall be in accordance with Section 503. Mechanical venting systems and exhaust hood venting systems shall be designed and installed in accordance with Section 503.

**505.1.1 Commercial cooking appliances vented by exhaust hoods.** Refer to Chapter 5 of the *New York City Mechanical Code*.

**SECTION FGC 506  
FACTORY-BUILT CHIMNEYS**

**506.1 Building heating appliances.** Factory-built chimneys for building heating appliances producing flue gases having a temperature not greater than 1,000°F (538°C), measured at the entrance to the chimney, shall be listed and labeled in accordance with UL 103 and shall be installed and terminated in accordance with the manufacturer's installation instructions and this code.

**506.2 Support.** Where factory-built chimneys are supported by structural members, such as joists and rafters, such members shall be designed to support the additional load.

**506.3 Medium-heat appliances.** Factory-built chimneys for medium-heat appliances producing flue gases having a temperature above 1,000°F (538°C), measured at the entrance to the chimney, shall be listed and labeled in accordance with UL 959 and shall be installed and terminated in accordance with the manufacturer's installation instructions and this code.

**CHAPTER 6  
SPECIFIC APPLIANCES**

**SECTION FGC 601  
GENERAL**

**601.1 Scope.** This chapter shall govern the approval, design, installation, construction, maintenance, alteration and repair of the appliances and equipment specifically identified herein. The approval, design, installation, construction, maintenance, alteration and repair of non gas-fired appliances shall be regulated by the *New York City Mechanical Code*.

**601.2 Fireplaces.** Fireplaces (solid fuel type or ANSI Z21.50) shall be installed with tight fitting noncombustible fireplace doors to control infiltration losses in construction type listed here:

1. Masonry or factory-built fireplaces designed to allow an open burn.
2. Whenever a decorative appliance (ANSI Standard Z21.60 gas-log style unit) is installed in a vented solid fuel fireplace.

3. Vented decorative gas fireplace appliances (ANSI Standard Z21.50 units).

Fireplaces shall be provided with a source of combustion air as required by the fireplace construction provisions of the *New York City Building Code*.

**601.3 Flame safeguard device.** All fuel gas space heating appliances installed or used in a building occupied as a residence shall be equipped with an automatic flame safeguard device that shall shut off the fuel supply to the main burner or group of burners when the flame or pilot light thereof is extinguished.

**SECTION FGC 602**

**DECORATIVE GAS FIRED APPLIANCES FOR INSTALLATION IN FIREPLACES**

**602.1 General.** Decorative appliances for installation in approved solid fuel-burning fireplaces shall be tested in accordance with ANSI Z21.60 and shall be installed in accordance with the manufacturer's installation instructions. Manually lighted natural gas decorative appliances shall be tested in accordance with ANSI Z21.84.

**602.2 Flame safeguard device.** Decorative appliances for installation in approved solid fuel-burning fireplaces, with the exception of those tested in accordance with ANSI Z21.84, shall utilize a direct ignition device, an ignitor or a pilot flame to ignite the fuel at the main burner, and shall be equipped with a flame safeguard device. The flame safeguard device shall automatically shut off the fuel supply to a main burner or group of burners when the means of ignition of such burners becomes inoperative.

**602.3 Prohibited installations.** Decorative appliances for installation in fireplaces shall not be installed where prohibited by Section 303.3.

**SECTION FGC 603**

**LOG LIGHTERS**

**603.1 General.** Log lighters shall be tested in accordance with CSA 8 and installed in accordance with the manufacturer's installation instructions.

**603.2 Automatic Valves.** Automatic valves or semi-automatic valves shall be provided and shall comply with the applicable provisions of ANSI Z21.21.

**SECTION FGC 604**

**VENTED GAS FIREPLACES  
(DECORATIVE APPLIANCES)**

**604.1 General.** Vented gas fireplaces shall be tested in accordance with ANSI Z21.50, shall be installed in accordance with the manufacturer's installation instructions and shall be designed and equipped as specified in Section 602.2.

604.2 Access. Panels, grilles and access doors that are required to be removed for normal servicing operations shall not be attached to the building.

**SECTION FGC 605**  
**VENTED GAS FIREPLACE HEATERS**

605.1 General. Vented gas fireplace heaters shall be installed in accordance with the manufacturer's installation instructions, shall be tested in accordance with ANSI Z21.88 and shall be designed and equipped as specified in Section 602.2. The installation of unvented gas fired space heaters, gas stoves, gas logs, gas fireplaces and gas fireplace inserts is prohibited.

605.2 Separate flues shall be provided for every fireplace and fireplace stove.

605.3 The requirements of the *Energy Conservation Construction Code of New York State* concerning combustion air supply shall be followed.

**SECTION FGC 606**  
**RESERVED**

**SECTION FGC 607**  
**COMMERCIAL-INDUSTRIAL INCINERATORS AND CREMATORIES**

607.1 Incinerators and crematories, commercial-industrial. Commercial-industrial-type incinerators and crematories shall be constructed and installed in accordance with NFPA 82.

607.2 Compliance. All new and existing refuse disposal systems shall be installed, altered and maintained in buildings in conformity with the applicable provisions of the *New York City Air Pollution Control Code*.

**SECTION FGC 608**  
**VENTED WALL FURNACES**

608.1 General. Vented wall furnaces shall be tested in accordance with ANSI Z21.49 or Z21.86/CSA 2.32 and shall be installed in accordance with the manufacturer's installation instructions.

608.2 Venting. Vented wall furnaces shall be vented in accordance with Section 503.

608.3 Location. Vented wall furnaces shall be located so as not to cause a fire hazard to walls, floors, combustible furnishings or doors. Vented wall furnaces installed between bathrooms and adjoining rooms shall not circulate air from bathrooms to other parts of the building.

608.4 Door swing. Vented wall furnaces shall be located so that a door cannot swing within 12 inches (305 mm) of an air inlet or air outlet of such furnace measured at right angles to the opening. Doorstops or door closers shall not be installed to obtain this clearance.

**608.5 Ducts prohibited.** Ducts shall not be attached to wall furnaces. Casing extension boots shall not be installed unless listed as part of the appliance.

**608.6 Access.** Vented wall furnaces shall be provided with access for cleaning of heating surfaces, removal of burners, replacement of sections, motors, controls, filters and other working parts, and for adjustments and lubrication of parts requiring such attention. Panels, grilles and access doors that are required to be removed for normal servicing operations shall not be attached to the building construction.

## **SECTION FGC 609** **FLOOR FURNACES**

**609.1 General.** Floor furnaces shall be tested in accordance with ANSI Z21.48 or Z21.86/CSA 2.32 and shall be installed in accordance with the manufacturer's installation instructions.

**609.2 Placement.** The following provisions apply to floor furnaces.

1. Floors. Floor furnaces shall not be installed in the floor of any doorway, stairway landing, aisle or passageway of any enclosure, public or private, or in an exit way from any such room or space.
2. Walls and corners. The register of a floor furnace with a horizontal warm-air outlet shall not be placed closer than 6 inches (152 mm) to the nearest wall. A distance of at least 18 inches (457 mm) from two adjoining sides of the floor furnace register to walls shall be provided to eliminate the necessity of occupants walking over the warm-air discharge. The remaining sides shall be permitted to be placed not closer than 6 inches (152 mm) to a wall. Wall register models shall not be placed closer than 6 inches (152 mm) to a corner.
3. Draperies. The furnace shall be placed so that a door, drapery or similar object cannot be nearer than 12 inches (305 mm) to any portion of the register of the furnace.
4. Floor construction. Floor furnaces shall be located so as to be readily accessible. Means shall be provided for supporting the furnace when the grille is removed. Floor furnaces shall be installed only on floors of noncombustible construction having at least a two-hour fire rating, except that floor furnace enclosures in one-and two- family dwellings shall be constructed of non-combustible materials with a fire-resistance rating of at least one hour.
5. Thermostat. The controlling thermostat for a floor furnace shall be located within the same room or space as the floor furnace or shall be located in an adjacent room or space that is permanently open to the room or space containing the floor furnace.

**609.3 Bracing.** The floor around the furnace shall be braced and headed with a support framework designed in accordance with the *New York City Building Code*.

**609.4 Clearance.** The lowest portion of the floor furnace shall have not less than a 6-inch (152 mm) clearance from the grade level; except where the lower 6-inch (152 mm) portion of the floor furnace is sealed by the manufacturer to prevent entrance of water, the minimum clearance shall

be not less than 2 inches (51 mm). Where such clearances cannot be provided, the ground below and to the sides shall be excavated to form a pit under the furnace so that the required clearance is provided beneath the lowest portion of the furnace. A 12-inch (305 mm) minimum clearance shall be provided on all sides except the control side, which shall have an 18-inch (457 mm) minimum clearance.

**609.5 Reserved.**

**609.6 Reserved.**

**609.7 Enclosures.** Enclosures of floor furnaces shall be constructed entirely of non-combustible materials with a fire-resistance rating of at least one-hour and the enclosure shall be provided with adequate outdoor air to ensure proper combustion. The enclosure shall be provided with adequate means of access for servicing the furnace.

**609.8 Duct temperature.** The outlet duct temperature of warm air heating furnaces shall not be greater than two hundred fifty degrees Fahrenheit.

**609.9 One- and two-family dwellings.** Floor furnace enclosures shall be constructed of non-combustible materials with a fire-resistance rating of at least one-hour. Means shall be provided for supporting the furnace when the grille is removed. Clearances shall be provided as per NFPA 54.

## **SECTION FGC 610** **DUCT FURNACES**

**610.1 General.** Duct furnaces shall be tested in accordance with ANSI Z83.9 or UL 795 and shall be installed in accordance with the manufacturer's installation instructions.

**610.2 Access panels.** Ducts connected to duct furnaces shall have removable access panels on both the upstream and downstream sides of the furnace.

**610.3 Location of draft hood and controls.** The controls, combustion air inlets and draft hoods for duct furnaces shall be located outside of the ducts. The draft hood shall be located in the same enclosure from which combustion air is taken.

**610.4 Circulating air.** Where a duct furnace is installed so that supply ducts convey air to areas outside the space containing the furnace, the return air shall also be conveyed by a duct(s) sealed to the furnace casing and terminating outside the space containing the furnace.

The duct furnace shall be installed on the positive pressure side of the circulating air blower.

**610.5 Unvented duct furnaces.** Unvented duct furnaces are prohibited.

## **SECTION FGC 611** **NONRECIRCULATING DIRECT-FIRED INDUSTRIAL AIR HEATERS**

**611.1 General.** Nonrecirculating direct-fired industrial air heaters shall be listed to ANSI Z83.4/CSA 3.7 and shall be installed in accordance with the manufacturer's instructions.

**611.2 Installation.** Nonrecirculating direct-fired industrial air heaters shall not be used to supply any area containing sleeping quarters. Nonrecirculating direct-fired industrial air heaters shall be installed only in industrial or commercial occupancies. Nonrecirculating direct-fired industrial air heaters shall be permitted to provide ventilation air.

**611.3 Clearance from combustible materials.** Nonrecirculating direct-fired industrial air heaters shall be installed with a clearance from combustible materials of not less than that shown on the rating plate and in the manufacturer's instructions.

**611.4 Supply air.** All air handled by a nonrecirculating direct-fired industrial air heater, including combustion air, shall be ducted directly from the outdoors.

**611.5 Outdoor air louvers.** If outdoor air louvers of either the manual or automatic type are used, such devices shall be proven to be in the open position prior to allowing the main burners to operate.

**611.6 Atmospheric vents and gas reliefs or bleeds.** Nonrecirculating direct-fired industrial air heaters with valve train components equipped with atmospheric vents or gas reliefs or bleeds shall have their atmospheric vent lines or gas reliefs or bleeds lead to the outdoors. Means shall be employed on these lines to prevent water from entering and to prevent blockage by insects and foreign matter. An atmospheric vent line shall not be required to be provided on a valve train component equipped with a listed vent limiter.

**611.7 Relief opening.** The design of the installation shall include provisions to permit nonrecirculating direct-fired industrial air heaters to operate at rated capacity without overpressurizing the space served by the heaters by taking into account the structure's designed infiltration rate, providing properly designed relief openings or an interlocked power exhaust system, or a combination of these methods. The structure's designed infiltration rate and the size of relief openings shall be determined by approved engineering methods. Relief openings shall be permitted to be louvers or counterbalanced gravity dampers. Motorized dampers or closable louvers shall be permitted to be used, provided they are verified to be in their full open position prior to main burner operation.

**611.8 Access.** Nonrecirculating direct-fired industrial air heaters shall be provided with access for removal of burners; replacement of motors, controls, filters and other working parts; and for adjustment and lubrication of parts requiring maintenance.

**611.9 Purging.** Inlet ducting, where used, shall be purged by not less than four air changes prior to an ignition attempt.

**611.10 Controls.** Direct-fired make-up air heaters shall be equipped with airflow-sensing devices, safety shutoff devices, operating temperature controls and thermally actuated temperature limit controls in accordance with the terms of their listing.



**SECTION FGC 612**  
**RECIRCULATING DIRECT-FIRED INDUSTRIAL AIR HEATERS**

**612.1 General.** Recirculating direct-fired industrial air heaters shall be listed to ANSI Z83.18 and shall be installed in accordance with the manufacturer's installation instructions.

**612.2 Location.** Recirculating direct-fired industrial air heaters shall be installed only in industrial and commercial occupancies. Recirculating direct-fired air heaters shall not serve any area containing sleeping quarters. Recirculating direct-fired industrial air heaters shall not be installed in hazardous locations or in buildings that contain flammable solids, liquids or gases, explosive materials or substances that can become toxic when exposed to flame or heat.

**612.3 Installation.** Direct-fired industrial air heaters shall be permitted to be installed in accordance with their listing and the manufacturer's instructions. Direct-fired industrial air heaters shall be installed only in industrial or commercial occupancies. Direct-fired industrial air heaters shall be permitted to provide fresh air ventilation.

**612.4 Clearance from combustible materials.** Direct-fired industrial air heaters shall be installed with a clearance from combustible material of not less than that shown on the label and in the manufacturer's instructions.

**612.5 Air supply.** Air to direct-fired industrial air heaters shall be taken from the building, ducted directly from outdoors, or a combination of both. Direct-fired industrial air heaters shall incorporate a means to supply outside ventilation air to the space at a rate of not less than 4 cubic feet per minute per 1,000 Btu per hour (0.38 m<sup>3</sup> per min per kW) of rated input of the heater. If a separate means is used to supply ventilation air, an interlock shall be provided so as to lock out the main burner operation until the mechanical means is verified. Where outside air dampers or closing louvers are used, they shall be verified to be in the open position prior to main burner operation.

**612.6 Atmospheric vents, gas reliefs or bleeds.** Direct-fired industrial air heaters with valve train components equipped with atmospheric vents, gas reliefs or bleeds shall have their atmospheric vent lines and gas reliefs or bleeds lead to the outdoors.

Means shall be employed on these lines to prevent water from entering and to prevent blockage by insects and foreign matter. An atmospheric vent line shall not be required to be provided on a valve train component equipped with a listed vent limiter.

**612.7 Relief opening.** The design of the installation shall include adequate provision to permit direct-fired industrial air heaters to operate at rated capacity by taking into account the structure's designed infiltration rate, providing properly designed relief openings or an interlocked power exhaust system, or a combination of these methods. The structure's designed infiltration rate and the size of relief openings shall be determined by a registered design professional. Relief openings shall be permitted to be louvers or counterbalanced gravity dampers. Motorized dampers or closable louvers shall be permitted to be used, provided they are verified to be in their full open position prior to main burner operation.

**612.8 Controls.** Recirculating direct-fired air heaters shall be equipped with airflow-sensing devices, safety shutoff devices, operating temperature controls and thermally actuated temperature limit controls in accordance with the terms of their listing.

### **SECTION FGC 613** **CLOTHES DRYERS**

**613.1 General.** Clothes dryers shall be tested in accordance with ANSI Z21.5.1 or ANSI Z21.5.2 and shall be installed in accordance with the manufacturer's installation instructions.

### **SECTION FGC 614** **CLOTHES DRYER EXHAUST**

**614.1 Installation.** Clothes dryers shall be exhausted in accordance with the manufacturer's instructions. Dryer exhaust systems shall be independent of all other systems and shall convey the moisture and any products of combustion to the outside of the building.

**614.2 Duct penetrations.** Ducts that exhaust clothes dryers shall not penetrate or be located within any fireblocking, draftstopping or any wall, floor/ceiling or other assembly required by the *New York City Building Code* to be fire-resistance rated, unless such duct is constructed of galvanized steel or aluminum of the thickness specified in Table 603.4 of the *New York City Mechanical Code* and the fire-resistance rating is maintained in accordance with the *New York City Building Code*. Fire dampers shall not be installed in clothes dryer exhaust duct systems.

**614.3 Cleaning access.** Each vertical duct riser or dryers listed to ANSI Z21.5.2 shall be provided with a cleanout or other means for cleaning the interior of the duct.

**614.4 Exhaust installation.** Exhaust ducts for clothes dryers shall terminate on the outside of the building and shall be equipped with a backdraft damper. Screens shall not be installed at the duct termination. Ducts shall not be connected or installed with sheet metal screws or other fasteners that will obstruct the flow. Clothes dryer exhaust ducts shall not be connected to a vent connector, vent or chimney. Clothes dryer exhaust ducts shall not extend into or through ducts or plenums.

**614.5 Makeup air.** Installations exhausting more than 200 cfm (0.09 m<sup>3</sup>/s) shall be provided with makeup air. Where a closet is designed for the installation of a clothes dryer, an opening having an area of not less than 100 square inches (645 mm<sup>2</sup>) for makeup air shall be provided in the closet enclosure, or makeup air shall be provided by other approved means.

**614.6 Domestic clothes dryer ducts.** Exhaust ducts for domestic clothes dryers shall be constructed of metal and shall have a smooth interior finish. The exhaust duct shall be a minimum nominal size of 4 inches (102 mm) in diameter. The entire exhaust system shall be supported and secured in place. The male end of the duct at overlapped duct joints shall extend in the direction of airflow. Clothes dryer transition ducts used to connect the appliance to the exhaust duct system shall be metal and limited to a single length not to exceed 8 feet (2438 mm) and shall be listed and labeled for the application. Transition ducts shall not be concealed within construction.

**614.6.1 Maximum length.** The maximum length of a clothes dryer exhaust duct shall not exceed 25 feet (7620 mm) from the dryer location to the outlet terminal. The maximum length of the duct shall be reduced 2.5 feet (762 mm) for each 45-degree (0.79 rad) bend and 5 feet (1524 mm) for each 90-degree (1.6 rad) bend.

**Exception:** Listed clothes dryers may be installed in accordance with the manufacturer's installation instructions.

**614.6.2 Rough-in required.** Where a compartment or space for a domestic clothes dryer is provided, an exhaust duct system shall be installed.

**614.7 Commercial clothes dryers.** The installation of dryer exhaust ducts serving Type 2 clothes dryers shall comply with the appliance manufacturer's installation instructions. Exhaust fan motors installed in exhaust systems shall be located outside of the airstream. In multiple installations, the fan shall operate continuously or be interlocked to operate when any individual unit is operating. Ducts shall have a minimum clearance of 6 inches (152 mm) to combustible materials.

## **SECTION FGC 615** **SAUNA HEATERS**

**615.1 General.** Sauna heaters shall be installed in accordance with the manufacturer's installation instructions.

**615.2 Location and protection.** Sauna heaters shall be located so as to minimize the possibility of accidental contact by a person in the room.

**615.2.1 Guards.** Sauna heaters shall be protected from accidental contact by an approved guard or barrier of material having a low coefficient of thermal conductivity. The guard shall not substantially affect the transfer of heat from the heater to the room.

**615.3 Access.** Panels, grilles and access doors that are required to be removed for normal servicing operations shall not be attached to the building.

**615.4 Combustion and dilution air intakes.** Sauna heaters of other than the direct-vent type shall be installed with the draft hood and combustion air intake located outside the sauna room. Where the combustion air inlet and the draft hood are in a dressing room adjacent to the sauna room, there shall be provisions to prevent physically blocking the combustion air inlet and the draft hood inlet, and to prevent physical contact with the draft hood and vent assembly, or warning notices shall be posted to avoid such contact. Any warning notice shall be easily readable, shall contrast with its background and the wording shall be in letters not less than ¼ inch (6.4 mm) high.

**615.5 Combustion and ventilation air.** Combustion air shall not be taken from inside the sauna room. Combustion and ventilation air for a sauna heater not of the direct-vent type shall be provided to the area in which the combustion air inlet and draft hood are located in accordance

with Section 304.

**615.6 Heat and time controls.** Sauna heaters shall be equipped with a thermostat which will limit room temperature to 194°F (90°C). If the thermostat is not an integral part of the sauna heater, the heat-sensing element shall be located within 6 inches (152 mm) of the ceiling. If the heat-sensing element is a capillary tube and bulb, the assembly shall be attached to the wall or other support, and shall be protected against physical damage.

**615.6.1 Timers.** A timer, if provided to control main burner operation, shall have a maximum operating time of 1 hour. The control for the timer shall be located outside the sauna room.

**615.7 Sauna room.** A ventilation opening into the sauna room shall be provided. The opening shall be not less than 4 inches by 8 inches (102 mm by 203 mm) located near the top of the door into the sauna room.

**615.7.1 Warning notice.** The following permanent notice, constructed of approved material, shall be mechanically attached to the sauna room on the outside:

WARNING: DO NOT EXCEED 30 MINUTES IN SAUNA. EXCESSIVE EXPOSURE CAN BE HARMFUL TO HEALTH. ANY PERSON WITH POOR HEALTH SHOULD CONSULT A PHYSICIAN BEFORE USING SAUNA.

The words shall contrast with the background and the wording shall be in letters not less than ¼ inch (6.4 mm) high.

**Exception:** This section shall not apply to one- and two-family dwellings.

## **SECTION FGC 616** **ENGINE AND GAS TURBINEPOWERED EQUIPMENT**

**616.1 Powered equipment.** Permanently installed equipment powered by internal combustion engines and turbines shall be installed in accordance with the manufacturer's installation instructions and NFPA 37.

## **SECTION FGC 617** **POOL AND SPA HEATERS**

**617.1 General.** Pool and spa heaters shall be tested in accordance with ANSI Z21.56 and shall be installed in accordance with the manufacturer's installation instructions.

## **SECTION FGC 618** **FORCED-AIR WARM-AIR FURNACES**

**618.1 General.** Forced-air warm-air furnaces shall be tested in accordance with ANSI Z21.47 or UL 795 and shall be installed in accordance with the manufacturer's installation instructions.

**618.2 Forced-air furnaces.** The minimum unobstructed total area of the outside and return air ducts or openings to a forced-air warm-air furnace shall be not less than 2 square inches for each 1,000 Btu/h (4402 mm<sup>2</sup>/W) output rating capacity of the furnace and not less than that specified in the furnace manufacturer's installation instructions. The minimum unobstructed total area of supply ducts from a forced-air warm-air furnace shall be not less than 2 square inches for each 1,000 Btu/h (4402 mm<sup>2</sup>/W) output rating capacity of the furnace and not less than that specified in the furnace manufacturer's installation instructions.

**Exception:** The total area of the supply air ducts and outside and return air ducts shall not be required to be larger than the minimum size required by the furnace manufacturer's installation instructions.

**618.3 Dampers.** Volume dampers shall not be placed in the air inlet to a furnace in a manner that will reduce the required air to the furnace.

**618.4 Circulating air ducts for forced-air warm-air furnaces.** Circulating air for fuel-burning, forced-air-type, warm-air furnaces shall be conducted into the blower housing from outside the furnace enclosure by continuous air-tight ducts.

**618.5 Prohibited sources.** Outside or return air for a forced-air heating system shall not be taken from the following locations:

1. Closer than 10 feet (3048 mm) from an appliance vent outlet, a vent opening from a plumbing drainage system or the discharge outlet of an exhaust fan, unless the outlet is 3 feet (914 mm) above the outside air inlet.
2. Where there is the presence of objectionable odors, fumes or flammable vapors; or where located less than 10 feet (3048 mm) above the surface of any abutting public way or driveway; or where located at grade level by a sidewalk, street, alley or driveway.
3. A hazardous or insanitary location or a refrigeration machinery room as defined in the *New York City Mechanical Code*.
4. A room or space, the volume of which is less than 25 percent of the entire volume served by such system. Where connected by a permanent opening having an area sized in accordance with Section 618.2, adjoining rooms or spaces shall be considered as a single room or space for the purpose of determining the volume of such rooms or spaces.

**Exception:** The minimum volume requirement shall not apply where the amount of return air taken from a room or space is less than or equal to the amount of supply air delivered to such room or space.

5. A room or space containing an appliance where such a room or space serves as the sole source of return air.

**Exception:** This shall not apply where:

1. The appliance is a direct-vent appliance or an appliance not requiring a vent in accordance with Section 501.8.
  2. The room or space complies with the following requirements:
    - 2.1. The return air shall be taken from a room or space having a volume exceeding 1 cubic foot for each 10 Btu/h (9.6 L/W) of combined input rating of all fuel-burning appliances therein.
    - 2.2. The volume of supply air discharged back into the same space shall be approximately equal to the volume of return air taken from the space.
    - 2.3. Return-air inlets shall not be located within 10 feet (3048 mm) of any appliance firebox or draft hood in the same room or space.
  3. Rooms or spaces containing solid fuel-burning appliances, provided that return-air inlets are located not less than 10 feet (3048 mm) from the firebox of such appliances.
6. A closet, bathroom, toilet room, kitchen, garage, mechanical room, boiler room or furnace room.

**618.6 Screen.** Required outdoor air inlets for residential portions of a building shall be covered with a screen having ¼-inch (6.4 mm) openings. Required outdoor air inlets serving a nonresidential portion of a building shall be covered with screen having openings larger than ¼ inch (6.4 mm) and not larger than 1 inch (25 mm).

**618.7 Return-air limitation.** Return air from one dwelling unit shall not be discharged into another dwelling unit.

## **SECTION FGC 619** **CONVERSION BURNERS**

**619.1 Conversion burners.** The installation of conversion burners shall conform to ANSI Z21.8.

## **SECTION FGC 620** **UNIT HEATERS**

**620.1 General.** Unit heaters shall be tested in accordance with ANSI Z83.8 and shall be installed in accordance with the manufacturer's installation instructions.

**620.2 Support.** Suspended-type unit heaters shall be supported by elements that are designed and constructed to accommodate the weight and dynamic loads. Hangers and brackets shall be of noncombustible material.

**620.3 Ductwork.** Ducts shall not be connected to a unit heater unless the heater is listed for such installation.

**620.4 Clearance.** Suspended-type unit heaters shall be installed with clearances to combustible materials of not less than 18 inches (457 mm) at the sides, 12 inches (305 mm) at the bottom and 6 inches (152 mm) above the top where the unit heater has an internal draft hood or 1 inch (25mm) above the top of the sloping side of the vertical draft hood.

Floor-mounted-type unit heaters shall be installed with clearances to combustible materials at the back and one side only of not less than 6 inches (152 mm). Where the flue gases are vented horizontally, the 6-inch (152 mm) clearance shall be measured from the draft hood or vent instead of the rear wall of the unit heater. Floor-mounted-type unit heaters shall not be installed on combustible floors unless listed for such installation.

Clearances for servicing all unit heaters shall be in accordance with the manufacturer's installation instructions.

**Exception:** Unit heaters listed for reduced clearance shall be permitted to be installed with such clearances in accordance with their listing and the manufacturer's instructions and as approved by the department.

## **SECTION FGC 621** **UNVENTED ROOM HEATERS**

**621.1 General.** The installation of unvented room heaters is prohibited.

**621.2** Reserved.

**621.3** Reserved.

**621.4** Reserved.

**621.5** Reserved.

**621.6** Reserved.

**621.7** Reserved.

## **SECTION FGC 622** **VENTED ROOM HEATERS**

**622.1 General.** Vented room heaters shall be tested in accordance with ANSI Z21.11.1 or ANSI Z21.86/CSA 2.32, shall be designed and equipped as specified in Section 602.2 and shall be installed in accordance with the manufacturer's installation instructions.

## **SECTION FGC 623**

## **COOKING APPLIANCES**

**623.1 Cooking appliances.** Cooking appliances that are designed for permanent installation, including ranges, ovens, stoves, broilers, grills, fryers, griddles, hot plates and barbecues, shall be tested in accordance with ANSI Z21.1, ANSI Z21.58 or ANSI Z83.11 and shall be installed in accordance with the manufacturer's installation instructions.

**623.1.1 LPG.** Except as may be permitted by the *New York City Fire Code*, cooking appliances using LPG are prohibited.

**623.2 Prohibited location.** Cooking appliances designed, tested, listed and labeled for use in commercial occupancies shall not be installed within dwelling units or within any area where domestic cooking operations occur.

**623.3 Domestic appliances.** Cooking appliances installed within dwelling units and within areas where domestic cooking operations occur shall be listed and labeled as household-type appliances for domestic use.

**623.4 Domestic range installation.** Domestic ranges installed on combustible floors shall be set on their own bases or legs and shall be installed with clearances of not less than that shown on the label.

**623.5 Open-top broiler unit hoods.** A ventilating hood shall be provided above a domestic open-top broiler unit, unless otherwise listed for forced down draft ventilation.

**623.5.1 Clearances.** A minimum clearance of 24 inches (610 mm) shall be maintained between the cooking top and combustible material above the hood. The hood shall be at least as wide as the open-top broiler unit and be centered over the unit.

**623.6 Commercial cooking appliance venting.** Commercial cooking appliances, other than those exempted by Section 501.8, shall be vented by connecting the appliance to a vent or chimney in accordance with this code and the appliance manufacturer's instructions or the appliance shall be vented in accordance with Section 505.1.1.

**623.7 Domestic ventilation.** When a hood is provided for a domestic cooking appliance, the exhaust and make-up air systems shall be properly engineered and designed in accordance with Chapter 5 and the *New York City Mechanical Code*.

## **SECTION FGC 624** **WATER HEATERS**

**624.1 General.** Water heaters shall be tested in accordance with ANSI Z 21.10.1 and ANSI Z 21.10.3 and shall be installed in accordance with the manufacturer's installation instructions. Water heaters utilizing fuels other than fuel gas shall be regulated by the *New York City Mechanical Code*.



**624.1.1 Installation requirements.** The requirements for water heaters relative to sizing, relief valves, drain pans and scald protection shall be in accordance with the *New York City Plumbing Code* and the following:

1. No person shall install or maintain in any dwelling unit a gas fuel fired water heater unless the heater obtains combustion air directly from the outside of the building.
2. No person shall install or maintain a gas fueled water heater in a room occupied for sleeping purposes, or cause or permit to be occupied for sleeping purposes any room in which a gas-fueled heater is installed.
3. Each heater shall be connected to a flue or outlet pipe.

**624.2 Water heaters utilized for space heating.** Water heaters utilized both to supply potable hot water and provide hot water for space-heating applications shall be listed and labeled for such applications by the manufacturer and shall be installed in accordance with the manufacturer's installation instructions and the *New York City Plumbing Code*.

## **SECTION FGC 625** **REFRIGERATORS**

**625.1 General.** Refrigerators shall be tested in accordance with ANSI Z21.19 and shall be installed in accordance with the manufacturer's installation instructions.

Refrigerators shall be provided with adequate clearances for ventilation at the top and back, and shall be installed in accordance with the manufacturer's instructions. If such instructions are not available, at least 2 inches (51mm) shall be provided between the back of the refrigerator and the wall and at least 12 inches (305 mm) above the top.

## **SECTION FGC 626** **GAS-FIRED TOILETS**

**626.1 General.** Gas-fired toilets are not approved for use in New York City.

**626.2 Reserved.**

## **SECTION FGC 627** **AIR CONDITIONING EQUIPMENT**

**627.1 General.** Gas-fired air-conditioning equipment shall be tested in accordance with ANSI Z21.40.1 or ANSI Z21.40.2 and shall be installed in accordance with the manufacturer's installation instructions.

**627.2 Independent piping.** Gas piping serving heating equipment shall be permitted to also serve cooling equipment where such heating and cooling equipment cannot be operated simultaneously (see Section 402).

**627.3 Connection of gas engine-powered air conditioners.** To protect against the effects of normal vibration in service, gas engines shall not be rigidly connected to the gas supply piping. Where units are powered by internal combustion engines and turbines, installation shall comply with Section 616.1.

**627.4 Clearances for indoor installation.** Air-conditioning equipment installed in rooms other than alcoves and closets shall be installed with clearances not less than those specified in Section 308.3 except that air-conditioning equipment listed for installation at lesser clearances than those specified in Section 308.3 shall be permitted to be installed in accordance with such listing and the manufacturer's instructions and air-conditioning equipment listed for installation at greater clearances than those specified in Section 308.3 shall be installed in accordance with such listing and the manufacturer's instructions.

Air-conditioning equipment installed in rooms other than alcoves and closets shall be permitted to be installed with reduced clearances to combustible material, provided that the combustible material is protected in accordance with Table 308.2.

**627.5 Alcove and closet installation.** Air-conditioning equipment installed in spaces such as alcoves and closets shall be specifically listed for such installation and installed in accordance with the terms of such listing. The installation clearances for air-conditioning equipment in alcoves and closets shall not be reduced by the protection methods described in Table 308.2.

**627.6 Installation.** Air-conditioning equipment shall be installed in accordance with the manufacturer's instructions. Unless the equipment is listed for installation on a combustible surface such as a floor or roof, or unless the surface is protected in an approved manner, equipment shall be installed on a surface of noncombustible construction with noncombustible material and surface finish and with no combustible material against the underside thereof.

**627.7 Plenums and air ducts.** A plenum supplied as a part of the air-conditioning equipment shall be installed in accordance with the equipment manufacturer's instructions. Where a plenum is not supplied with the equipment, such plenum shall be installed in accordance with the fabrication and installation instructions provided by the plenum and equipment manufacturer. The method of connecting supply and return ducts shall facilitate proper circulation of air.

Where air-conditioning equipment is installed within a space separated from the spaces served by the equipment, the air circulated by the equipment shall be conveyed by ducts that are sealed to the casing of the equipment and that separate the circulating air from the combustion and ventilation air.

**627.8 Refrigeration coils.** A refrigeration coil shall not be installed in conjunction with a forced-air furnace where circulation of cooled air is provided by the furnace blower, unless the blower has sufficient capacity to overcome the external static resistance imposed by the duct system and cooling coil at the air throughput necessary for heating or cooling, whichever is greater. Furnaces shall not be located upstream from cooling units, unless the cooling unit is designed or equipped so as not to develop excessive temperature or pressure. Refrigeration coils shall be installed in

parallel with or on the downstream side of central furnaces to avoid condensation in the heating element, unless the furnace has been specifically listed for downstream installation. With a parallel flow arrangement, the dampers or other means used to control flow of air shall be sufficiently tight to prevent any circulation of cooled air through the furnace.

Means shall be provided for disposal of condensate and to prevent dripping of condensate onto the heating element.

**627.9 Cooling units used with heating boilers.** Boilers, where used in conjunction with refrigeration systems, shall be installed so that the chilled medium is piped in parallel with the heating boiler with appropriate valves to prevent the chilled medium from entering the heating boiler. Where hot water heating boilers are connected to heating coils located in air-handling units where they might be exposed to refrigerated air circulation, such boiler piping systems shall be equipped with flow control valves or other automatic means to prevent gravity circulation of the boiler water during the cooling cycle.

**627.10 Switches in electrical supply line.** Means for interrupting the electrical supply to the air-conditioning equipment and to its associated cooling tower (if supplied and installed in a location remote from the air conditioner) shall be provided within sight of and not over 50 feet (15 240 mm) from the air conditioner and cooling tower.

## **SECTION FGC 628** **ILLUMINATING APPLIANCES**

**628.1 General.** Illuminating appliances shall be tested in accordance with ANSI Z21.42 and shall be installed in accordance with the manufacturer's installation instructions.

**628.2 Mounting on buildings.** Illuminating appliances designed for wall or ceiling mounting shall be securely attached to substantial structures in such a manner that they are not dependent on the gas piping for support.

**628.3 Mounting on posts.** Illuminating appliances designed for post mounting shall be securely and rigidly attached to a post. Posts shall be rigidly mounted in accordance with the requirements of the *New York City Building Code*. Drain openings shall be provided near the base of posts where there is a possibility of water collecting inside them.

**628.4 Appliance pressure regulators.** Where an appliance pressure regulator is not supplied with an illuminating appliance and the service line is not equipped with a service pressure regulator, an appliance pressure regulator shall be installed in the line to the illuminating appliance. For multiple installations, one regulator of adequate capacity shall be permitted to serve more than one illuminating appliance.

## **SECTION FGC 629** **SMALL CERAMIC KILNS**

**629.1 General.** Ceramic kilns with a maximum interior volume of 20 cubic feet (0.566 m<sup>3</sup>) and

used for hobby and noncommercial purposes shall be installed in accordance with the manufacturer's installation instructions and the provisions of this code.

### **SECTION FGC 630** **INFRARED RADIANT HEATERS**

**630.1 General.** Infrared radiant heaters shall be tested in accordance with ANSI Z83.6 and shall be installed in accordance with the manufacturer's installation instructions.

**630.2 Support.** Infrared radiant heaters shall be safely and adequately fixed in an approved position independent of gas and electric supply lines. Hanger and brackets shall be of noncombustible material.

### **SECTION FGC 631** **BOILERS**

**631.1 Standards.** Boilers shall be listed in accordance with the requirements of ANSI Z21.13 or UL 795. If applicable, the boiler shall be designed and constructed in accordance with the requirements of ASME CSD-1 and as applicable, the ASME *Boiler and Pressure Vessel Code*, Sections I, II, IV, V, VI and IX, NFPA 8501, NFPA 8502 and NFPA 8504. Low pressure boilers shall conform to the requirements of 12 NYCRR Part 4 and high pressure boilers shall conform to the requirements of 12 NYCRR Part 14.

**631.2 Installation.** In addition to the requirements of this code, the installation of boilers shall be in accordance with the manufacturer's instructions and the *New York City Mechanical Code*. Operating instructions of a permanent type shall be attached to the boiler. Boilers shall have all controls set, adjusted and tested by the installer. A complete control diagram together with complete boiler operating instructions shall be furnished by the installer. The manufacturer's rating data and the nameplate shall be attached to the boiler.

**631.3 Clearance to combustible materials.** Clearances to combustible materials shall be in accordance with Section 308.4.

### **SECTION FGC 632** **EQUIPMENT INSTALLED IN EXISTING UNLISTED BOILERS**

**632.1 General.** Gas equipment installed in existing unlisted boilers shall comply with Section 631.1 and shall be installed in accordance with the manufacturer's instructions and the *New York City Mechanical Code*.

### **SECTION FGC 633** **FUEL CELL POWER PLANTS**

**633.1 General.** Stationary fuel-cell power plants having a power output not exceeding 1,000 kW shall be tested in accordance with ANSI Z21.83 and shall be installed in accordance with the manufacturer's installation instructions and NFPA 853.

**SECTION FGC 634**  
**CHIMNEY DAMPER OPENING AREA**

**634.1 Free opening area of chimney dampers.** Where an unlisted decorative appliance for installation in a vented fireplace is installed, the fireplace damper shall have a permanent free opening equal to or greater than specified in Table 634.1.

**TABLE 634.1**  
**FREE OPENING AREA OF CHIMNEY DAMPER**  
**FOR VENTING FLUE GASES FROM UNLISTED DECORATIVE APPLIANCES FOR**  
**INSTALLATION IN VENTED FIREPLACES**  
**(Table 634.1 attached to end of document)**

**CHAPTER 7**  
**RESERVED**

## CHAPTER 8 REFERENCED STANDARDS

This chapter lists the standards that are referenced in various sections of this document. The standards are listed herein by the promulgating agency of the standard, the standard identification, the effective date and title and the section or sections of this document that reference the standard. The application of the referenced standards shall be as specified in Section 102.8 of this code.

### ANSI

American National Standards Institute  
25 West 43<sup>rd</sup> Street, Fourth Floor  
New York, NY 10036

<u>Standard Reference Number</u>	<u>Title</u>	<u>Referenced in code section number</u>
Z21.1—00	Household Cooking Gas Appliances . . . . .	623.1
Z21.5.1—99	Gas Clothes Dryers -Volume I -Type 1 Clothes Dryers. . . . .	613.1
Z21.5.2—99	Gas Clothes Dryers -Volume II-Type 2 Clothes Dryers with Z21.5.2a-99 and Z21.5.2b-99 Addenda . . . . .	613.1, 614.3
Z21.8—94	Installation of Domestic Gas Conversion Burners. . . . .	619.1
Z21.10.1—00	Gas Water Heaters -Volume I - Storage, Water Heaters with Input Ratings of 75,000 Btu per Hour or Less . . . . .	624.1
Z21.10.3—98	Gas Water Heaters - Volume III - Storage, Water Heaters with Input Ratings Above 75,000 Btu per hour, Circulating and Instantaneous Water Heaters—with Z21.10.3a-99 Addendum . . . . .	624.1
Z21.11.1—91	Gas-Fired Room Heaters -Volume I - Vented Room Heaters—with 1993 Addendum (Replaced by Z21.86-98/CSA 2.32 - M98,Vented Gas-Fired Space Heating Appliances) . . . . .	622.1
Z21.13—99	Gas-Fired Low-Pressure Steam and Hot Water Boilers—with Addenda Z21.13a-1993 and Z21.13b-1994 . . . . .	631.1
Z21.15—97	Manually Operated Gas Valves for Appliances, Appliance Connector Valves, and Hose End Valves . . . . .	409.1.1
Z21.19—90	Refrigerators Using Gas (R 1999) Fuel—with Addenda Z21.19a-1992 (R1999) and Z21.19b-1995 (R1999) . . . . .	625.1
Z21.21—05	Automatic valves for gas appliances. . . . .	603.2
Z21.40.1—96	Gas-Fired Heat Activated Air Conditioning and Heat Pump Appliances—with Z21.40.1a-98 Addendum . . . . .	627.1
Z21.40.2—96	Gas-Fired Work Activated Air Conditioning and Heat Pump Appliances (Internal Combustion)—with Z21.40.2a-97 Addendum . . . . .	627.1
Z21.42—93	Gas-Fired Illuminating Appliances. . . . .	628.1
Z21.47—00	Gas-Fired Central Furnaces—with Addendum Z21.47a-00 . . . . .	618.1
Z21.48—92	Gas-Fired Gravity and Fan Type Floor Furnaces—with 1993 Addendum (Replaced by Z21.86-98/CSA 2.32-M98,Vented Gas-Fired Space Heating Appliances). . . . .	609.1
Z21.49—92	Gas-Fired Gravity and Fan-Type Vented Wall Furnaces—with 1993 Addendum B-94 (Replaced by Z21.86-98/CSA 2.32-M98,Vented Gas-Fired Space Heating Appliances) . . . . .	608.1
Z21.50—98	Vented Decorative Gas Appliances . . . . .	601.2, 604.1
Z21.56—98	Gas-Fired Pool Heaters—with Addendum Z21.56a-99 . . . . .	617.1
Z21.58—95	Outdoor Cooking Gas Appliances—with Addendum Z21.58a-1998 . . . . .	623.1
Z21.60—00	Decorative Gas Appliances for Installation in Solid-Fuel Burning Fireplaces. . . . .	601.2, 602.1
Z21.69—97	Connectors for Movable Gas Appliances . . . . .	411.1
Z21.83—98	Fuel Cell Power Plants . . . . .	633.1
Z21.84—99	Manually-Lighted, Natural Gas Decorative Gas Appliances for Installation in Solid Fuel Burning Fireplaces . . . . .	602.1, 602.2
Z21.86—98/CSA 2.32M98	Gas-Fired Vented Space Heating Appliances. . . . .	608.1, 609.1, 622.1
Z21.88—99	Vented Gas Fireplace Heaters . . . . .	605.1
Z83.4—99/CSA 3.7	Non-Recirculating Direct-Gas-Fired Industrial Air Heaters with Addendum Z83.4a-2001 . . . . .	611.1
Z83.6—90 (R 1998)	Gas-Fired Infrared Heaters . . . . .	630.1
Z83.8—96	Gas -Fired Unit Heaters—with Addendum Z83.8a-1997 . . . . .	620.1
Z83.9—96	Gas-Fired Duct Furnaces . . . . .	610.1
Z83.11—00	Gas Food Service Equipment (Ranges and Unit Broilers), Baking and Roasting Ovens, Fat Fryers, Counter Appliances and Kettles, Steam Cookers, and Steam Generators . . . . .	623.1
Z83.18—90	Recirculating Direct Gas-Fired Industrial Air Heaters with Addenda Z83a 2001 and Z83.18b 1992 . . . . .	612.1

### ASME

American Society of Mechanical Engineers  
Three Park Avenue  
New York, NY 10016-5990

<u>Standard Reference Number</u>	<u>Title</u>	<u>Referenced in code section number</u>
----------------------------------	--------------	--

B1.20.1—R92	Pipe Threads, General Purpose (inch) . . . . .	403.9
B16.1—98	Cast Iron Pipe Flanges and Flanged Fittings, Class 25, 125 and 250 . . . . .	403.12
B16.20—98	Metallic Gaskets for Pipe Flanges Ring-Joint, Spiral-Wound, and Jacketed—with Addendum B16.20a-2000 . . . . .	403.12
B16.33—90	Manually Operated Metallic Gas Valves for Use in Gas Piping Systems up to 125 psig (Sizes 1/2 through 2) . . . . .	409.1.1
B36.10M—00	Welded and Seamless Wrought-Steel Pipe . . . . .	403.4.2
B40.100—98	Pressure Gauges and Gauge Attachments . . . . .	406.4.1
BPVC—01	ASME Boiler & Pressure Vessel Code (2001 Edition) . . . . .	406.1.1.1, 406.1.1.2, 631.1
CSD-1—98	Controls and Safety Devices for Automatically Fired Boilers with the ASME CSD-1a-1999 Addendum . . . . .	631.1

## **ASNT**

American Society for Non-destructive Testing  
3200 Riverside Drive  
Columbus, OH 43221

<u>Standard Reference Number</u>	<u>Title</u>	<u>Referenced in code section number</u>
SNT-TC-1A—01	Recommended Practice . . . . .	406.1.1.1

## **ASTM**

ASTM International  
100 Barr Harbor Drive  
West Conshohocken, PA 19428-2959

<u>Standard Reference Number</u>	<u>Title</u>	<u>Referenced in code section number</u>
A53/A53M—01	Specification for Pipe, Steel, Black and Hot Dipped Zinc-Coated Welded and Seamless . . . . .	403.4.2
A106—99	Specification for Seamless Carbon Steel Pipe for High-Temperature Service . . . . .	403.4.2
C 64—72 (1977)	Withdrawn No Replacement (Specification for Fireclay Brick Refractories for Heavy Duty Stationary Boiler Service) . . . . .	503.10.2.5
C315—00	Specification for Clay Flue Linings . . . . .	501.12

## **AWWA**

American Water Works Association  
6666 West Quincy Avenue  
Denver, CO 80235

<u>Standard Reference Number</u>	<u>Title</u>	<u>Referenced in code section number</u>
C111/A.21.11—00	Rubber-Gasket Joints for Ductile-Iron Pressure Pipe and Fittings . . . . .	403.12

## **CSA**

Canadian Standards Association  
178 Rexdale Blvd.  
Rexdale (Toronto), Ontario, Canada M9W 1R3

<u>Standard Reference Number</u>	<u>Title</u>	<u>Referenced in code section number</u>
CSA 8—93 (Revision 1, 1999)	Requirements for Gas-Fired Log Lighters for Wood Burning Fireplaces . . . . .	603.1

## **MSS**

Manufacturers Standardization Society of the Valve & Fittings Industry, Inc.  
127 Park Street, N.E.  
Vienna, VA 22180 MSS

<u>Standard Reference Number</u>	<u>Title</u>	<u>Referenced in code section number</u>
SP-6—96	Standard Finishes for Contact Faces of Pipe Flanges and Connecting-End Flanges of Valves and Fittings . . . . .	403.12
SP-58—93	Pipe Hangers and Supports—Materials, Design and Manufacture . . . . .	407.2

## **NFPA**

National Fire Protection Association  
Batterymarch Park  
Quincy, MA 02269

<u>Standard Reference Number</u>	<u>Title</u>	<u>Referenced in code section number</u>
----------------------------------	--------------	--

30A—03	Code for Motor Fuel Dispensing Facilities and Repair Garages .....	305.4
37—02	Installation and Use of Stationary Combustion Engines and Gas Turbines .....	616.1
54—06	National Fuel Gas Code.....	501.2.2, 609.9
68—02	Guide for Venting of Deflagrations.....	E.2.1
69—92	Standard on Explosion Prevention Systems .....	E.2.1
82—99	Incinerators, Waste and Linen Handling Systems and Equipment .....	607.1
88B—97	Repair Garages .....	305.4
211—00	Chimneys, Fireplaces, Vents, and Solid Fuel-Burning Appliances .....	502.1, 503.5.2, 503.5.3, 503.5.6.1, 503.5.6.3
853—00	Standard for the Installation of Stationary Fuel Cell Power Plants .....	633.1
8501—97	Standard for Single Burner Boiler Operations.....	631.1
8502—99	Standard for the Prevention of Furnace Explosions/Implosions in Multiple Burner Boilers.....	631.1
8504—96	Standard on Atmospheric Fluidized-Bed Boiler Operations.....	631.1

# NYC/NYS

New York City Codes / New York State Codes / NYC Agencies

Standard Reference Number	Title	Referenced in code section number
	Energy Conservation Construction Code of New York State.....	301.2, 605.3
	New York City Air Pollution Control Code.....	607.2
	New York City Building Code based on 2003 IBC .....	102.2.1, 201.3, 301.10, 301.11, 301.12, 301.14, 302.1, 302.2, 305.6, 306.6, 401.1.1, 407.1, 501.1, 501.3, 501.12, 501.15.4, 503.5.3, 601.2, 609.3, 614.2, 628.3,
	New York City Department of Environmental Protection.....	304.6, 304.9, 501.1.1.1, 503.5.9
	New York City Electrical Code based on 2002 NEC .....	201.3, 306.3.1, 306.4.1, 306.5.2, 309.2
	New York City Fire Code.....	201.3, 303.4
	New York City Mechanical Code based on 2003 IMC.....	101.2.5, 201.3, 301.1.1, 301.13, 304.11, 501.1, 614.2, 618.5, 621.1, 623.7, 624.1, 631.2, 632.1,
	New York City Plumbing Code based on 2003 IPC.....	201.3, 301.6, 624.1.1, 624.2
	New York Codes, Rules and Regulations, 12 NYCRR Part 4 .....	631.1
	New York Codes, Rules and Regulations, 12 NYCRR Part 14 .....	631.1

# UL

Underwriters Laboratories, Inc.  
333 Pfingsten Road  
Northbrook, IL 60062-2096 UL

Standard Reference Number	Title	Referenced in code section number
103—98	Factory-Built Chimneys, Residential Type and Building Heating Appliances—with Revisions thru March 1999 .....	506.1
441—96	Gas Vents—with Revisions through April 1999 .....	502.1
641—95	Type L Low-Temperature Venting Systems—with Revisions through April 1999 .....	502.1
795—99	Commercial-Industrial Gas Heating Equipment .....	610.1, 618.1, 631.1
959—01	Medium Heat Appliance Factory-Built Chimneys .....	506.3
1738—93	Venting Systems for Gas Burning Appliances, Categories II, III and IV with Revisions through December 2000 .....	502.1
1777—98	Chimney Liners—with Revisions through July 1998 .....	501.12, 501.15.4



**APPENDIX A**  
**RESERVED**

**APPENDIX B**  
**RESERVED**

**APPENDIX C**  
**RESERVED**

**APPENDIX D**  
**RESERVED**

**APPENDIX E**  
**METERS AND GAS SERVICE PIPING**

**E.1 General.** This appendix addresses the requirements for meters and service piping, underground or aboveground, as the piping enters the building. Service piping includes fuel gas piping, valves, and fittings upstream of the point of delivery. Service piping may include piping supplied by the gas service utility, as well as other service piping furnished by the owner serving multiple buildings on the same lot.

**E.2 Gas regulator and gas regulator vent outlets.** Gas meter piping supplying gas to a building at a pressure in excess of ½ psig (3.4 kPa gauge) shall be provided with a regulator that will reduce the pressure of the gas to ½ psig (3.4 kPa gauge) or less prior to entering the gas distribution piping in the building, except where the use of higher pressure is permitted. Where gas distribution pressure in excess of ½ psig (3.4 kPa gauge) is permitted, it shall be regulated not to exceed the maximum pressure level as permitted by the code or the commissioner.

**E.2.1** Inside gas meter piping operating at a pressure in excess of 15 psig (103 kPa gauge) shall comply with the following:

1. Where such piping is greater than 4 inches (102 mm) in diameter, the meter piping shall be installed in a properly ventilated meter room of 3-hour fire rated construction.
2. The maximum distance from the service line valve to the regulator shall be limited as follows:

<b><u>SERVICE LINE VALVE SIZE</u></b>	<b><u>MAXIMUM DISTANCE (LINEAR FEET OF PIPE)</u></b>
<u>Up through 2 inch (51 mm) pipe size</u>	<u>4 feet (1219 mm)</u>
<u>Over 2 inch (51 mm) through 4 inch (102 mm) pipe size</u>	<u>8 feet (2438 mm)</u>
<u>Over 4 inch (102 mm) through 8 inch (203 mm) pipe size</u>	<u>15 feet (4572 mm)</u>
<u>10 inch (254 mm) pipe size and larger</u>	<u>20 feet (6096 mm)</u>

3. Where these maximum distances cannot be met, the following shall be required:

<u>FOOTAGE (LINEAR FEET OF PIPE) IN EXCESS OF ABOVE REQUIREMENTS</u>	<u>ADDITIONAL REQUIREMENTS</u>
<u>Up to 5 feet (1534 mm)</u>	<u>The meter room shall have 3 hour fire-rating construction and adequate ventilation</u>
<u>Over 5 feet (1524 mm) through 10 feet (3048 mm)</u>	<u>Above requirements plus a combustible gas-detection alarm system</u>
<u>Over 10 (3048 mm) feet through 15 feet (4572 mm)</u>	<u>Above requirements plus special inspection by the customer or his representative as required by the <i>New York City Building Code</i>.</u>
<u>Over 15 feet (4572 mm) through 20 feet (6096 mm)</u>	<u>Above requirements plus explosion venting per NFPA 68 and NFPA 69 or alternative ventilation acceptable to the commissioner and automatic gas shutoff devices</u>
<u>Over 20 feet (6096 mm)</u>	<u>Above requirements plus suitable fire protection approved by the commissioner</u>

For new gas installations made in existing structures, the above requirements shall be used to the extent feasible. Alternate designs may be considered by the commissioner.

E.2.2 When located inside the building, each regulator shall be provided with a vent pipe that leads directly to the outdoor air. The vent pipe shall be sized according to local utility requirements. The vent outlet shall not be located under a window or any opening leading back into the premises or located below any overhang or projection. No gas regulator vent outlet shall be covered over, plugged up, or otherwise obstructed, and all gas vents shall be identified by suitable marking on the outlet on the outside of the building.

E.2.3 Gas appliance pressure regulators requiring access to the atmosphere for successful operation shall be equipped with vent leading to the outdoors, unless constructed or equipped with a vent limiting means to limit the escape of gas from the vent opening in the event of diaphragm failure.

**E.3 Gas meter location.** Gas meter location shall comply with the following:

1. When located inside the building, meters shall be located as near as practicable to the point of entrance of the service and, where possible, the meters shall be located in the cellar or basement unless otherwise permitted by the commissioner. The meter location shall be clean, dry, and free of refuse, steam or chemical fumes. Meters shall be adequately protected against extreme cold or heat and shall be readily accessible for reading and inspection. The area in which the meter is located shall be properly ventilated as per Section E.4. Notwithstanding the foregoing, outside meter installation shall be permitted in areas where the utility company certifies that dry gas is being distributed.
2. In a multiple dwelling, no gas meter, other than the replacement of an existing meter shall be located in any boiler room or other room or space containing a heating boiler, in any stair hall, nor in any public hall above the cellar or above the lowest story if there is no

cellar. However, in any multiple dwelling where there is an existing gas meter located in any boiler room or other room or space containing a heating boiler, one additional gas meter may be installed in such room or space, provided such additional gas meter is installed adjacent to the existing gas meter and is used in conjunction with the supply of gas for a gas-fired heating boiler or a gas-fired water heater used as a central source of supply of heat or hot water for the tenants residing in such multiple dwelling. Such additional gas meter may be installed only upon the condition that space heaters or hot water appliances in the dwelling units are eliminated.

3. Gas meter rooms, when provided, shall at all times be kept clear of all rubbish; and shall not be used in any way for storage purposes, including material or equipment of any kind. A legible sign reading "Gas meter room-No storage permitted" shall be permanently and conspicuously posted on the exterior of the meter room door, except that the sign may be posted on the interior of the meter room door in buildings classified in occupancy group R-3. The lettering of such signs shall be of bold type at least one inch in height and shall be properly spaced to provide good legibility. The lettering and background shall be of contrasting colors. Where gas meters and related equipment are not located in a separate room but are located in an open floor area, no combustible material shall be stored or kept within five feet of such equipment; nor shall the gas meter be within 3 feet (914 mm) of any heating boiler or sources of ignition and, except for buildings in occupancy group R-3 there shall be a physical barrier required if the room is also used for storage purposes or the like.
4. The installation of gas meter piping shall be made in accordance with the requirements of this code and the local utility company.
5. Piping containing gas with a pressure exceeding ½ psig (3.4 kPa gauge) and the gas service pressure regulator which may be subjected to accidental vehicular impact shall be suitably protected.

**E.4 Gas meter room ventilation.** Any one of the following methods shall be considered sufficient to provide proper ventilation to a room or space in which a gas meter(s) is installed:

1. An opening to the outside air in the wall of such room or space, provided the free area of the opening is not less than 30 square inches (19 321 mm<sup>2</sup>).
2. A duct having a cross-section area of at least 50 square inches (32 522 mm<sup>2</sup>) of free area and a maximum length of 15 feet (4572 mm) leading to the outside air. If a longer duct is required due to the building construction, the area of the duct should be increased accordingly, subject to the approval of the commissioner. However, under no circumstances shall the means of ventilation for the gas meter room or space be from an adjoining room or space within the building.

The above requirement is not applicable to one- and two-family dwellings, since the gas meter is available for continuous supervision.

**E.5 Gas service piping connections.** Gas service piping connections shall comply with the following:

1. Gas service piping shall be fitted with a gas service line valve, the valve located on the supply side of the meter and service regulator, if a service regulator is required. If a plug type valve is used, it shall be constructed so as to prevent the core from being blown out by the pressure of the gas. In addition, it shall be of a type capable of being locked in the off position by the local gas utility. When the gas service line valve is inside the building, it shall be in an accessible location within 2 feet (610 mm) of the point where the gas service connection enters the building or at such other location as may be permitted by the commissioner. Where the gas service connection is installed through a building wall below ground, it shall be protected with a wall sleeve extending at least 4 inches (102 mm) beyond the outer side of the wall and at least 1 inch (25 mm) beyond the inner side of the wall. The sleeve shall be sealed at both ends to prevent the entry of water and gas. Gas service connections, installed through ground slab construction, shall be protected with a floor sleeve sealed at both ends to prevent the entry of water and gas. The sleeve shall extend at least 4 inches (102 mm) above the floor, and shall be installed as specified by the utility company providing the service. It shall terminate at least 4 inches (102 mm) outside the building.
2. In all high-pressure areas, the utility company providing the service may inspect the gas service line valve and regulator in accordance with the provisions of 16 NYCRR Part 255 in addition to the department in accordance with Section 406 of this code.
3. No gas service shall enter a structure at a horizontal distance of less than 10 feet (3048 mm) from the cellar termination of a stairway, nor shall any gas meters or gas regulators be located less than 10 feet (3048 mm) from such stairway termination. Where such services, meters and regulators are separated from the stairway termination by a permanent partition or wall having a fire-resistance rating of at least 1 hour, the foregoing shall not apply. Unless forbidden by other provisions of this code, locations under a stairway are exempt from this requirement.
4. When the structure is erected on fill or on piles, provision shall be made to preclude possible damage to the gas service piping caused by settlement.
5. The installation of gas service piping shall be made in accordance with the requirements of the utility corporation providing the service as regulated by the provisions of 16 NYCRR Part 255. Further, such installation shall meet the requirements of the department.
6. Gas service piping outside a structure shall be installed not less than 24 inches (610 mm) below grade, except that a lesser distance of not less than 18 inches (457 mm) may be permitted, provided the piping is adequately protected in accordance with the requirements of this code and the utility corporation supplying service, and the piping is not located below a driveway. Any piping that is exposed to outdoor temperatures or installed underground with a cover of less than 2 feet (610 mm) shall be protected against frost, except

that frost protection may be omitted in areas where the utility company certifies that dry gas is being distributed.

**E.6 Outside gas cut-off.** Outside gas cut-off shall comply with the following:

1. An outside gas service line valve or other outside emergency shut-off device or other means acceptable to the commissioner and the Fire Commissioner shall be installed in every gas service pipe outside the building. If buried, such valve, device or method shall be readily accessible from grade. Every existing service which is being replaced or refurbished shall be provided with such valve, device or means, but in any event, all existing gas services shall be provided with such valve, device or method by January 1, 2010. However, in R-3 occupancy the completion date shall be January 1, 2020. The utility company shall provide the Fire Department with suitable tools for operation of such emergency shut-off valves, devices or means. The number of such tools required for supplying Fire Department units shall be determined by the Fire Department. On or before January 31, of each year, the utility company shall report to the department and the Fire Department the actual number of emergency shut-off valves installed for the preceding year.
2. If the outside gas service line valve, emergency shut-off device or means is located below ground, it shall be installed in a protective housing, and a cover, easily identifiable shall be provided for the housing. The cover shall be flush with the surface of the ground and kept clear at all times so as to be accessible for immediate use.
3. The valve or emergency shut-off device shall be capable of being readily operated by removing the cover of the housing and inserting a portable key or other device over the operating end of the valve or emergency shut-off device.
4. If the outside gas service line valve is located above ground, it shall be suitably protected to prevent accidental vehicular impact and must be installed in accordance with provisions of 16 NYCRR Part 255.
5. Where a gas-fired generator provides required emergency power in accordance with the *New York City Building Code* such generator shall have an outside gas cut-off valve that is separate from other gas services to the buildings.

**APPENDIX F**  
**PLASTIC FUEL GAS PIPING**

**F.1 General.** This appendix addresses and regulates the application of plastic piping for outdoor underground service. The plastic piping may be utilized for outdoor direct burial application.

**F.2 Plastic piping design requirements.** Plastic piping, either insert or direct burial, may be installed subject to the following restrictions:

1. Wherever plastic insert piping is used, the existing piping shall act as a mechanical protection between the plastic piping and the surrounding environment. The gas pipe shall be prepared to the extent necessary to remove any sharp edges, projections, or abrasive material which could damage the plastic during and after insertion. Plastic piping shall be inserted into the casing pipe in such a manner as to protect the plastic during the installation. The leading end of the plastic shall be closed before insertion. Care shall be taken to prevent piping from bearing on the end of the casing.
2. Persons engaged in the installation of the plastic piping shall be formally trained, qualified, and certified by the serving utility company.
3. Plastic piping shall not extend more than 3 inches (76 mm) beyond the inner face of the building wall, and shall not be exposed inside the building. Plastic piping may extend into the building a maximum of 1 foot (305 mm) horizontally and 4 feet (1219 mm) vertically immediately adjacent to the inner face of the building wall when encased in a metallic sleeve and constructed and vented so that uncontrolled gas cannot escape from the metallic sleeve inside the building.
4. Joints shall only be either mechanical or heat fusion joints. Each plastic pipe fusion joint must be made in accordance with written procedures that have been proven by destructive burst test to produce joints at least as strong as the pipe being joined.
  - 4.1. When plastic pipe or fittings of different material specifications are joined together by heat fusion, a thorough investigation shall be made to determine that the materials are compatible for joining purposes. The joining method used must be compatible with the materials being joined. The recommendations of the manufacturer shall be considered when determining the method to be used.
  - 4.2. When compression type mechanical joints are used, the gasket material in the coupling must be compatible with the plastic. An internal tubular rigid stiffener shall be used in conjunction with the coupling. The tubular stiffener shall reinforce the end of the pipe and shall extend at least to the outside end of the compression fitting when installed. The stiffener shall be free of rough or sharp edges and shall not be a force fit in the plastic. A split tubular stiffener shall not be used.
5. Changes in direction with plastic piping may be made with bends, elbows and tees. Bends shall be free of buckles, cracks, or other evidence of damage. No miter joints are permitted. The pipe may be bent or deflected provided the radius shall not be less than the minimum recommended by the manufacturer.
6. The minimum allowable wall thickness for plastic pipe shall be 0.09 inches (2 mm).
7. Plastic pipe shall be laid, and continuously supported, on undisturbed or well-compacted soil to minimize shear stresses. Backfill material for at least 4 inches (102 mm) over the plastic pipe shall be free from large rocks or sharp objects. The trench shall be backfilled to a height of 12 inches (305 mm) above the pipe in 6-inch (152 mm) lifts which shall be hand compacted. The remaining trench shall be backfilled in 12-inch (305 mm) lifts.

8. An electrically continuous corrosion-resistant tracer wire (minimum AWG 14) or tape shall be buried with the plastic pipe to facilitate locating the buried gas pipe. The tracer wire or tape shall be yellow in color. One end of the tracer wire shall be brought aboveground at a building wall or riser for easy identification.
9. Slack for thermal expansion and contraction or for external loading on direct-buried plastic services shall be provided by snaking the pipe from one side of the trench to the other. Where plastic piping is inserted for a distance of 50 feet (15 240 mm) or more allowances shall be made at the end connections to prevent pull out caused by thermal or by external loading.
10. External sleeves shall be used on plastic service lines at main connections to minimize shear stresses.
11. Plastic pipe shall not be installed in areas where it may be exposed to temperatures below 20°F (-7°C) or above 140°F (60°C). Plastic pipe shall not be installed within 35 feet (10 688 mm) of an underground steam facility, nor in any vault in which a steam facility is located.
12. The specific plastic pipe or fitting to be used shall be thoroughly investigated by the user and material serviceability determined for the conditions anticipated. The selected material shall be adequately resistant to the liquids and the chemical atmosphere which may be encountered. Care shall be exercised at all times to protect plastic material from fire, excessive heat, or harmful chemicals.
13. The design pressure is not to exceed 100 psig (690 kPa gauge) for plastic gas service piping.
14. The design pressure for plastic gas service piping or the nominal wall thicknesses for a given design pressure shall be determined by one of the following equations:

**(Equation F-1 attached to end of document)**

**(Equation F-2 attached to end of document)**

**F.3 Inspection and handling provisions.** Plastic piping components are susceptible to damage by mishandling. Gouges, cuts, kinks, or other forms of damage may cause failure. Injurious gouges or grooves shall be removed by cutting out the damaged portion as a cylinder and replacing it with a good piece. Care shall be exercised during handling and installation to prevent such damage. The serving utility shall inspect plastic piping and its components to ensure the absence of imperfections in materials, to ensure sound joints are made, and to ensure conformance with applicable state regulations.

**F.4 Plastic pipe sizing.** Tables F.4.1, F.4.2 and F.4.3 shall be used to size polyethylene plastic pipes for various inlet pressures and design pressure drops for plastic piping systems.

**TABLE F.4.1**  
**POLYETHYLENE PLASTIC PIPE**  
**(Table F.4.1 attached to end of document)**

**TABLE F.4.2**  
**POLYETHYLENE PLASTIC PIPE**  
**(Table F.4.1 attached to end of document)**

**TABLE F.4.3**  
**POLYETHYLENE PLASTIC PIPE**  
**(Table F.4.1 attached to end of document)**



$$\text{Required Volume}_{\text{other}} \geq \frac{21 \text{ ft}^3}{ACH} \left( \frac{I_{\text{other}}}{1,000 \text{ Btu / hr}} \right)$$

**(Equation 3-1)**

For fan-assisted appliances, calculate volume using Equation 3-2.

$$\text{Required Volume}_{\text{fan}} \geq \frac{15 \text{ ft}^3}{ACH} \left( \frac{I_{\text{fan}}}{1,000 \text{ Btu / hr}} \right)$$

**(Equation 3-2)**

where:

$I_{\text{other}}$  = All appliances other than fan assisted (input in Btu/h).

$I_{\text{fan}}$  = Fan-assisted appliance (input in Btu/h).

$ACH$  = Air change per hour (percent of volume of space exchanged per hour, expressed as a decimal).

1. Low-pressure gas equation [Less than 1.5 pounds per square inch (psi) (10.3 kPa)]:

$$D = \frac{Q^{0.381}}{19.17 \left( \frac{\Delta H}{C_r \times L} \right)^{0.206}} \quad (\text{Equation 4-1})$$

2. High-pressure gas equation [1.5 psi (10.3 kPa) and above]:

$$D = \frac{Q^{0.381}}{18.93 \left[ \frac{(P_1^2 - P_2^2) \times Y}{C_r \times L} \right]^{0.206}} \quad (\text{Equation 4-2})$$

where:

- $D$  = Inside diameter of pipe, inches (mm).  
 $Q$  = Input rate appliance(s), cubic feet per hour at 60°F (16°C) and 30-inch mercury column  
 $P_1$  = Upstream pressure, psia ( $P_1 + 14.7$ )  
 $P_2$  = Downstream pressure, psia ( $P_2 + 14.7$ )  
 $L$  = Equivalent length of pipe, feet  
 $\Delta H$  = Pressure drop, inch water column (27.7 inch water column = 1 psi)

$$D = F \times \sqrt{A} \quad \text{(Equation 5-1)}$$

where: D = Distance, in feet, measured from the center of the chimney outlet to the nearest edge of the construction.

where: F = Value determined from Table below

where: A = Free area, in square inches, of chimney flue space.

<u>“F” FACTOR FOR DETERMINING CHIMNEY DISTANCES</u>			
<u>Type of Fuel</u>	<u>“F” Factor</u>		
	<u>600°F (316°C ) and less</u>	<u>600°F (316°C ) to 1000°F (538°C)</u>	<u>Greater than 1000°F (538°C)</u>
<u>Gas</u>	<u>2</u>	<u>2</u>	<u>3</u>

$$D = 2A \quad \text{(Equation 5-2)}$$

where: D = Distance in feet, measured from the center of the vent outlet to the nearest edge of the construction.

where: A = Free area, in square inches, of vent flue space.

$$\frac{P = 2S \times F}{R-1} \quad \text{(Equation F-1)}$$

$$\frac{P = 2S \times F}{(D-t)} \quad \text{(Equation F-2)}$$

where:

D = Specified outside diameter, inches

P = Design pressure, psi

S = Long term hydrostatic strength, psi (Determined in accordance with ASTM D2513)

t = Specified wall thickness, inches

F = Plastic design factor = .32

R = Standard dimension ratio

**FIGURE 304.5.3**  
**ALL AIR FROM INSIDE THE BUILDING**

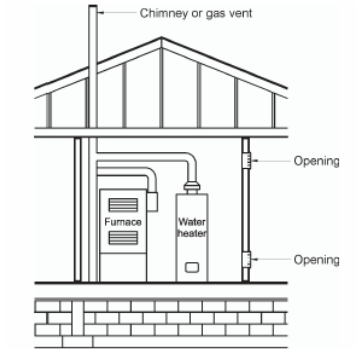


FIGURE 304.5.3  
ALL AIR FROM INSIDE THE BUILDING (see Section 304.5.3)

**FIGURE 304.6.1 (1)**  
**ALL AIR FROM OUTDOORS—INLET AIR FROM VENTILATED CRAWL SPACE AND OUTLET AIR TO VENTILATED ATTIC**

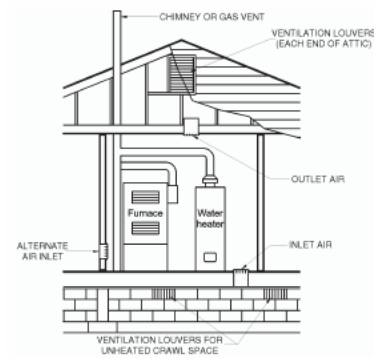
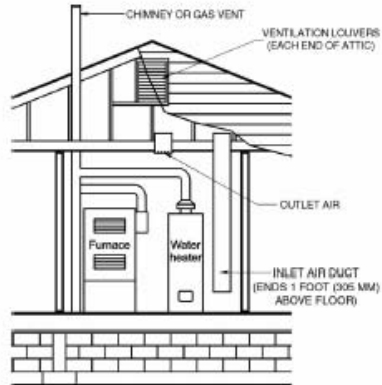


FIGURE 304.6.1(1)  
ALL AIR FROM OUTDOORS—INLET AIR FROM VENTILATED  
CRAWL SPACE AND OUTLET AIR TO VENTILATED ATTIC  
(see Section 304.6.1)

**FIGURE 304.6.1 (2)**  
**ALL AIR FROM OUTDOORS THROUGH VENTILATED ATTIC**



For SI: 1 foot = 304.8 mm.

FIGURE 304.6.1(2)  
ALL AIR FROM OUTDOORS THROUGH VENTILATED ATTIC  
(see Section 304.6.1)

**FIGURE 304.6.1 (3)**  
**ALL AIR FROM OUTDOORS**

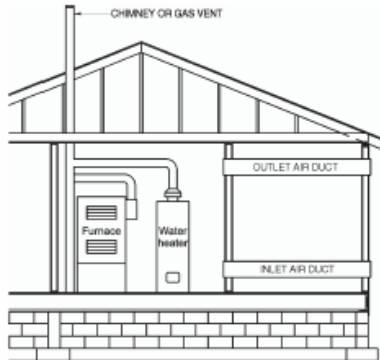
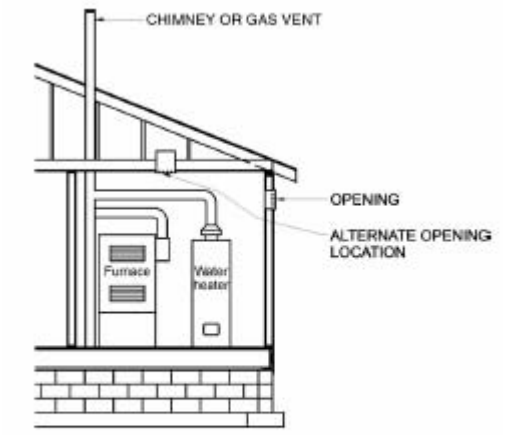


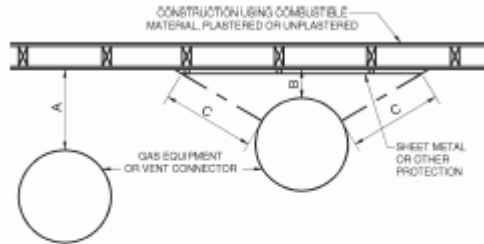
FIGURE 304.6.1(3)  
ALL AIR FROM OUTDOORS  
(see Section 304.6.1)

**FIGURE 304.6.2**  
**SINGLE COMBUSTION AIR OPENING**  
**ALL AIR FROM OUTDOORS**



**FIGURE 304.6.2**  
**SINGLE COMBUSTION AIR OPENING,**  
**ALL AIR FROM THE OUTDOORS**  
**(see Section 304.6.2)**

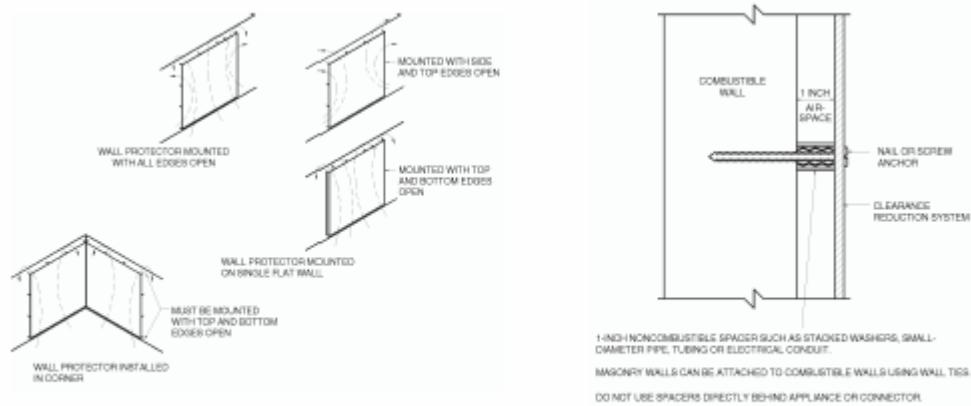
**FIGURE 308.2(1)**  
**EXTENT OF PROTECTION NECESSARY TO**  
**REDUCE CLEARANCES FROM GAS EQUIPMENT OR**  
**VENT CONNECTIONS**



"A" equals the reduced clearance with no protection.  
 "B" equals the reduced clearance permitted in accordance with Table 308.2.  
 The protection applied to the construction using combustible material shall extend far enough in each direction to make "C" equal to "A."

FIGURE 308.2(1)  
 EXTENT OF PROTECTION NECESSARY TO  
 REDUCE CLEARANCES FROM GAS EQUIPMENT OR  
 VENT CONNECTIONS

**FIGURE 308.2(2)**  
**WALL PROTECTOR CLEARANCE REDUCTION SYSTEM**

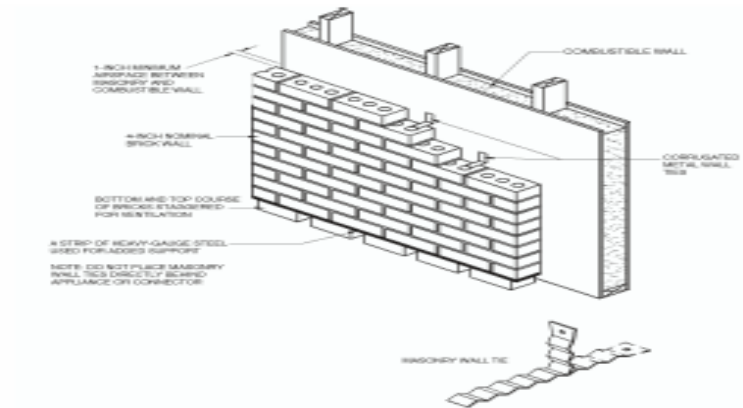


For SI: 1 inch = 25.4 mm.

FIGURE 308.2(2)  
 WALL PROTECTOR CLEARANCE REDUCTION SYSTEM



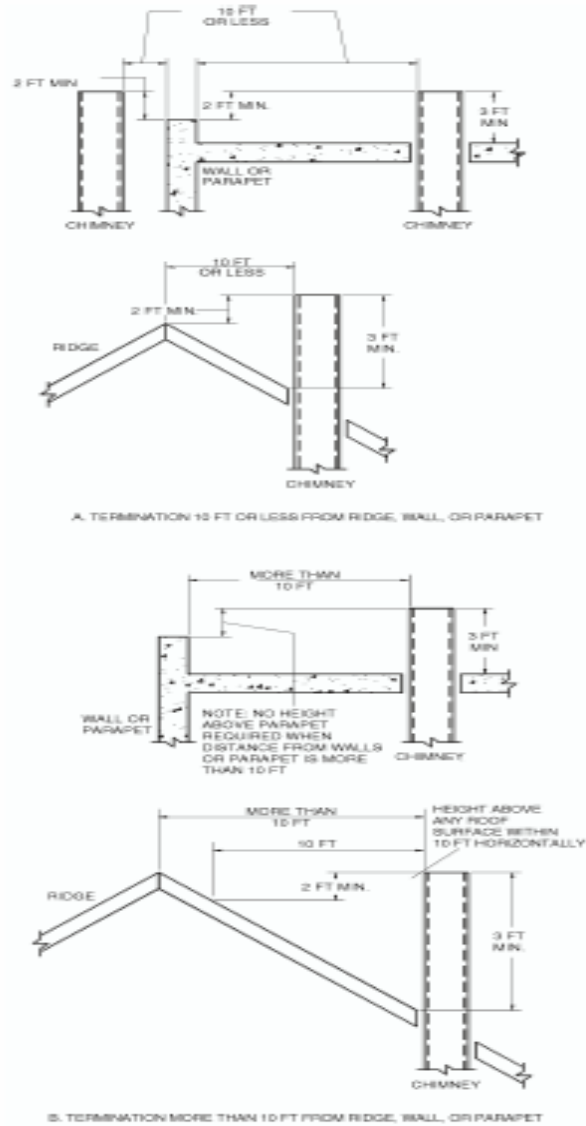
**FIGURE 308.2(3)**  
**MASONRY CLEARANCE REDUCTION SYSTEM**



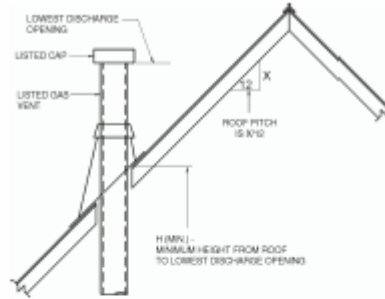
For SI: 1 inch = 25.4 mm.

**FIGURE 308.2(3)**  
**MASONRY CLEARANCE REDUCTION SYSTEM**

**FIGURE 503.5.4**  
**TYPICAL TERMINATION LOCATIONS FOR CHIMNEYS AND SINGLE-WALL METAL PIPES SERVING RESIDENTIAL-TYPE AND LOW-HEAT EQUIPMENT**



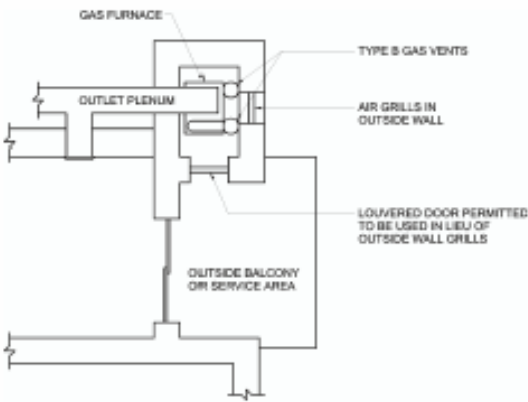
**FIGURE 503.6.6**  
**GAS VENT TERMINATION LOCATIONS FOR LISTED CAPS 12 INCHES OR LESS IN**  
**SIZE AT LEAST 8 FEET FROM A VERTICAL WALL**



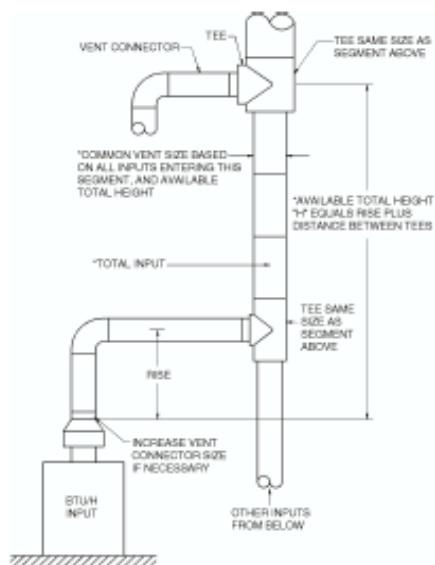
ROOF PITCH	H (min) ft
Flat to 6/12	1.0
Over 6/12 to 7/12	1.25
Over 7/12 to 8/12	1.5
Over 8/12 to 9/12	2.0
Over 9/12 to 10/12	2.5
Over 10/12 to 11/12	3.25
Over 11/12 to 12/12	4.0
Over 12/12 to 14/12	5.0
Over 14/12 to 16/12	6.0
Over 16/12 to 18/12	7.0
Over 18/12 to 20/12	7.5
Over 20/12 to 21/12	8.0

For SI: 1 inch = 25.4 mm, 1 foot = 304.8 mm.

**FIGURE 503.6.10.1**  
**PLAIN VIEW OF PRACTICAL SEPARATION METHOD FOR MULTISTORY GAS VENTING**



**FIGURE 503.6.10.2(1)**  
**MULTISTORY GAS VENT DESIGN PROCEDURE FOR EACH SEGMENT SYSTEM**



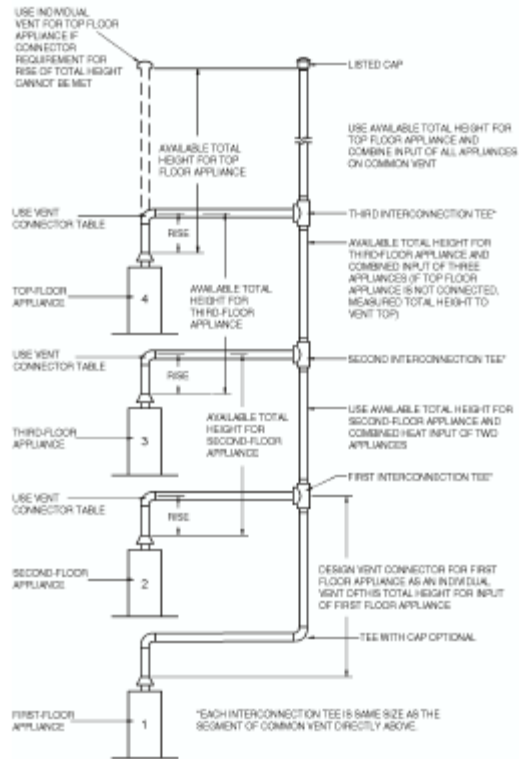
Vent connector size depends on:

- Input
- Rise
- Available total height " $H$ "
- Table 504.3(1) connectors

Common vent size depends on:

- Combined inputs
- Available total height " $H$ "
- Table 504.3(1) common vent

**FIGURE 503.6.10.2(2)**  
**MULTISTORY VENT SYSTEMS**



Principles of design of multistory vents using vent connector and common vent design tables (see Sections 504.3.11 through 504.3.17).

TABLE 308.2<sup>a-k</sup>  
REDUCTION OF CLEARANCES WITH SPECIFIED FORMS OF PROTECTION

TYPE OF PROTECTION APPLIED TO AND COVERING ALL SURFACES OF COMBUSTIBLE MATERIAL WITHIN THE DISTANCE SPECIFIED AS THE REQUIRED CLEARANCE WITH NO PROTECTION [see Figures 308.2(1), 308.2(2), and 308.2(3)]	WHERE THE REQUIRED CLEARANCE WITH NO PROTECTION FROM APPLIANCE, VENT CONNECTOR, OR SINGLE-WALL METAL PIPE IS: (inches)									
	36		18		12		9		6	
	Allowable clearances with specified protection (inches)									
	Use Column 1 for clearances above appliance or horizontal connector. Use Column 2 for clearances from appliance, vertical connector, and single-wall metal pipe.									
	Above Col. 1	Sides and rear Col. 2	Above Col. 1	Sides and rear Col. 2	Above Col. 1	Sides and rear Col. 2	Above Col. 1	Sides and rear Col. 2	Above Col. 1	Sides and rear Col. 2
1. 3 1/2-inch-thick masonry wall without ventilated airspace	—	24	—	12	—	9	—	6	—	5
2. 1/2-inch insulation board over 1-inch glass fiber or mineral wool batts	24	18	12	9	9	6	6	5	4	3
3. 0.024 sheet metal over 1-inch glass fiber or mineral wool batts reinforced with wire on rear face with ventilated airspace	18	12	9	6	6	4	5	3	3	3
4. 3 1/2-inch-thick masonry wall with ventilated airspace	—	12	—	6	—	6	—	6	—	6
5. 0.024 sheet metal with ventilated airspace	18	12	9	6	6	4	5	3	3	2
6. 1/2-inch-thick insulation board with ventilated airspace	18	12	9	6	6	4	5	3	3	3
7. 0.024 sheet metal with ventilated airspace over 0.024 sheet metal with ventilated airspace	18	12	9	6	6	4	5	3	3	3
8. 1-inch glass fiber or mineral wool batts sandwiched between two sheets 0.024 sheet metal with ventilated airspace	18	12	9	6	6	4	5	3	3	3

- For SI: 1 inch = 25.4 mm, °C = [(°F - 32)/1.8], 1 pound per cubic foot = 16.02 kg/m<sup>3</sup>, 1 Btu per inch per square foot per hour per °F = 0.144 W/m<sup>2</sup> · K.
- Reduction of clearances from combustible materials shall not interfere with combustion air, draft hood clearance and relief, and accessibility of servicing.
  - All clearances shall be measured from the outer surface of the combustible material to the nearest point on the surface of the appliance, disregarding any intervening protection applied to the combustible material.
  - Spacers and ties shall be of noncombustible material. No spacer or tie shall be used directly opposite an appliance or connector.
  - For all clearance reduction systems using a ventilated airspace, adequate provision for air circulation shall be provided as described [see Figures 308.2(2) and 308.2(3)].
  - There shall be at least 1 inch between clearance reduction systems and combustible walls and ceilings for reduction systems using ventilated airspace.
  - Where a wall protector is mounted on a single flat wall away from corners, it shall have a minimum 1-inch air gap. To provide air circulation, the bottom and top edges, or only the side and top edges, or all edges shall be left open.
  - Mineral wool batts (blanket or board) shall have a minimum density of 8 pounds per cubic foot and a minimum melting point of 1500°F.
  - Insulation material used as part of a clearance reduction system shall have a thermal conductivity of 1.0 Btu per inch per square foot per hour per °F or less.
  - There shall be at least 1 inch between the appliance and the protector. In no case shall the clearance between the appliance and the combustible surface be reduced below that allowed in this table.
  - All clearances and thicknesses are minimum; larger clearances and thicknesses are acceptable.
  - Listed single-wall connectors shall be installed in accordance with the terms of their listing and the manufacturer's instructions.

**{TABLE NOTE: Revise table 308.2 above by deleting “0.024” from the first column of row “3.” and replacing with “0.0296 inch (No. 22 gauge) galvanized” and delete row “5.”}**

**TABLE 402.2  
APPROXIMATE GAS INPUT FOR TYPICAL APPLIANCES**

APPLIANCE	INPUT BTU/H (Approx.)
<b>Space Heating Units</b>	
Hydronic boiler	
Single family	100,000
Multifamily, per unit	60,000
Warm-air furnace	
Single family	100,000
Multifamily, per unit	60,000
<b>Space and Water Heating Units</b>	
Hydronic boiler	
Single family	120,000
Multifamily, per unit	75,000
<b>Water Heating Appliances</b>	
Water heater, automatic instantaneous	35,000
Capacity at 2 gal/minute	50,000
Capacity at 4 gal/minute	
Capacity at 6 gal/minute	142,800
Water heater, automatic storage, 30- to 40-gal. tank	285,000
Water heater, automatic storage, 50-gal. tank	428,400
Water heater, domestic, circulating or side-arm	35,000
<b>Cooking Appliances</b>	
Built-in oven or broiler unit, domestic	65,000
Built-in top unit, domestic	25,000
Range, free-standing, domestic	40,000
<b>Other Appliances</b>	
Barbecue	3,000
Clothes dryer, Type 1 (domestic)	35,000
Gas fireplace, direct vent	40,000
Gas light	80,000
Gas log	40,000
Refrigerator	2,500

For SI: 1 British thermal unit per hour = 0.293 W, 1 gallon = 3.785 L,  
1 gallon per minute = 3.785 L/m.



**TABLE 402.4**  
**Cr AND Y VALUES FOR NATURAL GAS AND STANDARD CONDITIONS**

GAS	EQUATION FACTORS	
	$C_r$	$Y$
Natural gas	0.6094	0.9992

For SI: 1 cubic foot = 0.028 m<sup>3</sup>, 1 foot = 305 mm, 1-inch water column = 0.249 kPa, 1 pound per square inch = 6.895 kPa, 1 British thermal unit per hour = 0.293 W.

TABLE 402.4(1)  
SCHEDULE 40 METALLIC PIPE

Gas	Natural
Inlet Pressure	0.50 psi or less
Pressure Drop	0.3 inch WC
Specific Gravity	0.60

PIPE SIZE (in.)											
Nominal	1/4	3/8	1/2	3/4	1	1 1/4	1 1/2	2	2 1/2	3	4
Actual ID	0.364	0.493	0.622	0.824	1.049	1.380	1.610	2.067	2.469	3.068	4.026
Length (ft)	Maximum Capacity in Cubic Feet of Gas per Hour										
10	32	72	132	278	520	1,050	1,600	3,050	4,800	8,500	17,500
20	22	49	92	190	350	730	1,100	2,100	3,300	5,900	12,000
30	18	40	73	152	285	590	890	1,650	2,700	4,700	9,700
40	15	34	63	130	245	500	760	1,450	2,300	4,100	8,300
50	14	30	56	115	215	440	670	1,270	2,000	3,600	7,400
60	12	27	50	105	195	400	610	1,150	1,850	3,250	6,800
70	11	25	46	96	180	370	560	1,050	1,700	3,000	6,200
80	11	23	43	90	170	350	530	990	1,600	2,800	5,800
90	10	22	40	84	160	320	490	930	1,500	2,600	5,400
100	9	21	38	79	150	305	460	870	1,400	2,500	5,100
125	8	18	34	72	130	275	410	780	1,250	2,200	4,500
150	8	17	31	64	120	250	380	710	1,130	2,000	4,100
175	7	15	28	59	110	225	350	650	1,050	1,850	3,800
200	6	14	26	55	100	210	320	610	980	1,700	3,500

For SI: 1 inch = 25.4 mm, 1 foot = 304.8 mm, 1 cubic foot per hour = 0.0283 m<sup>3</sup>/h, 1 pound per square inch = 6.895 kPa, 1-inch water column = 0.2488 kPa.

TABLE 402.4(2)  
SCHEDULE 40 METALLIC PIPE

Gas	Natural
Inlet Pressure	0.50 psi or less
Pressure Drop	0.5 inch WC
Specific Gravity	0.60

PIPE SIZE (in.)											
Nominal	1/4	3/8	1/2	3/4	1	1 1/4	1 1/2	2	2 1/2	3	4
Actual ID	0.364	0.493	0.622	0.824	1.049	1.380	1.610	2.067	2.469	3.068	4.026
Length (ft)	Maximum Capacity in Cubic Feet of Gas per Hour										
10	43	95	175	360	680	1,400	2,100	3,950	6,300	11,000	23,000
20	29	65	120	250	465	950	1,460	2,750	4,350	7,700	15,800
30	24	52	97	200	375	770	1,180	2,200	3,520	6,250	12,800
40	20	45	82	170	320	660	990	1,900	3,000	5,300	10,900
50	18	40	73	151	285	580	900	1,680	2,650	4,750	9,700
60	16	36	66	138	260	530	810	1,520	2,400	4,300	8,800
70	15	33	61	125	240	490	750	1,400	2,250	3,900	8,100
80	14	31	57	118	220	460	690	1,300	2,050	3,700	7,500
90	13	29	53	110	205	430	650	1,220	1,950	3,450	7,200
100	12	27	50	103	195	400	620	1,150	1,850	3,250	6,700
125	11	24	44	93	175	360	550	1,020	1,650	2,950	6,000
150	10	22	40	84	160	325	500	950	1,500	2,650	5,500
175	9	20	37	77	145	300	460	850	1,370	2,450	5,000
200	8	19	35	72	135	280	430	800	1,280	2,280	4,600

For SI: 1 inch = 25.4 mm, 1 foot = 304.8 mm, 1 cubic foot per hour = 0.0283 m<sup>3</sup>/h, 1 pound per square inch = 6.895 kPa, 1-inch water column = 0.2488 kPa.

TABLE 402.4(3)  
SCHEDULE 40 METALLIC PIPE

Gas	Natural
Inlet Pressure	2.0 psi
Pressure Drop	1.0 psi
Specific Gravity	0.60

PIPE SIZE (in.)									
Nominal	1/2	3/4	1	1 1/4	1 1/2	2	2 1/2	3	4
Actual ID	0.622	0.824	1.049	1.380	1.610	2.067	2.469	3.068	4.026
Length (ft)	Maximum Capacity in Cubic Feet of Gas per Hour								
10	1,506	3,041	5,561	11,415	17,106	32,944	52,505	92,819	189,326
20	1,065	2,150	3,932	8,072	12,096	23,295	37,127	65,633	133,873
30	869	1,756	3,211	6,591	9,876	19,020	30,314	53,589	109,307
40	753	1,521	2,781	5,708	8,553	16,472	26,253	46,410	94,663
50	673	1,360	2,487	5,105	7,650	14,733	23,481	41,510	84,669
60	615	1,241	2,270	4,660	6,983	13,449	21,435	37,893	77,292
70	569	1,150	2,102	4,315	6,465	12,452	19,845	35,082	71,558
80	532	1,075	1,966	4,036	6,048	11,647	18,563	32,817	66,937
90	502	1,014	1,854	3,805	5,702	10,981	17,502	30,940	63,109
100	462	934	1,708	3,508	5,257	10,125	16,138	28,530	58,194
125	414	836	1,528	3,138	4,702	9,056	14,434	25,518	52,050
150	372	751	1,373	2,817	4,222	8,130	12,960	22,911	46,732
175	344	695	1,271	2,608	3,909	7,527	11,999	21,211	43,265
200	318	642	1,174	2,413	3,613	6,959	11,093	19,608	39,997

For SI: 1 inch = 25.4 mm, 1 foot = 304.8 mm, 1 cubic foot per hour = 0.0283 m<sup>3</sup>/h, 1 pound per square inch = 6.895 kPa.

TABLE 402.4(4)  
SCHEDULE 40 METALLIC PIPE

Gas	Natural
Inlet Pressure	5.0 psi
Pressure Drop	3.5 psi
Specific Gravity	0.60

PIPE SIZE (in.)									
Nominal	1/2	3/4	1	1 1/4	1 1/2	2	2 1/2	3	4
Actual ID	0.622	0.824	1.049	1.380	1.610	2.067	2.469	3.068	4.026
Length (ft)	Maximum Capacity in Cubic Feet of Gas per Hour								
10	3,185	6,434	11,766	24,161	36,206	69,727	111,133	196,468	400,732
20	2,252	4,550	8,320	17,084	25,602	49,305	78,583	138,924	283,361
30	1,839	3,715	6,793	13,949	20,904	40,257	64,162	113,431	231,363
40	1,593	3,217	5,883	12,080	18,103	34,864	55,566	98,234	200,366
50	1,425	2,878	5,262	10,805	16,192	31,183	49,700	87,863	179,213
60	1,301	2,627	4,804	9,864	14,781	28,466	45,370	80,208	163,598
70	1,204	2,432	4,447	9,132	13,685	26,354	42,004	74,258	151,463
80	1,153	2,330	4,260	8,542	12,801	24,652	39,291	69,462	141,680
90	1,062	2,145	3,922	8,054	12,069	23,242	37,044	65,489	133,577
100	979	1,978	3,617	7,427	11,128	21,433	34,159	60,387	123,173
125	876	1,769	3,235	6,643	9,953	19,170	30,553	54,012	110,169
150	786	1,589	2,905	5,964	8,937	17,211	27,431	48,494	98,911
175	728	1,471	2,690	5,522	8,274	15,934	25,396	44,897	91,574
200	673	1,360	2,487	5,104	7,649	14,729	23,478	41,504	84,656

For SI: 1 inch = 25.4 mm, 1 foot = 304.8 mm, 1 cubic foot per hour = 0.0283 m<sup>3</sup>/h, 1 pound per square inch = 6.895 kPa.

TABLE 402.4(5)  
SCHEDULE 40 METALLIC PIPE

Gas	Natural
Inlet Pressure	1.0 psi or less
Pressure Drop	0.3 inch WC
Specific Gravity	0.60

PIPE SIZE (in.)													
Nominal	1	1 1/4	1 1/2	2	2 1/2	3	3 1/2	4	5	6	8	10	12
Actual ID	1.049	1.380	1.610	2.067	2.469	3.068	3.548	4.026	5.047	6.065	7.981	10.020	11.938
Length (ft)	Maximum Capacity in Cubic Feet of Gas per Hour												
50	215	442	662	1,275	2,033	3,594	5,262	7,330	13,261	21,472	44,118	80,130	126,855
100	148	304	455	877	1,397	2,470	3,616	5,038	9,114	14,758	30,322	55,073	87,187
150	119	244	366	704	1,122	1,983	2,904	4,046	7,319	11,851	24,350	44,225	70,014
200	102	209	313	602	960	1,698	2,485	3,462	6,264	10,143	20,840	37,851	59,923
250	90	185	277	534	851	1,505	2,203	3,069	5,552	8,990	18,470	33,547	53,109
300	82	168	251	484	771	1,363	1,996	2,780	5,030	8,145	16,735	30,396	48,120
400	70	143	215	414	660	1,167	1,708	2,380	4,305	6,971	14,323	26,015	41,185
500	62	127	191	367	585	1,034	1,514	2,109	3,816	6,178	12,694	23,056	36,501
1,000	43	87	131	252	402	711	1,041	1,450	2,623	4,246	8,725	15,847	25,087
1,500	34	70	105	203	323	571	836	1,164	2,106	3,410	7,006	12,725	20,146
2,000	29	60	90	173	276	488	715	996	1,802	2,919	5,997	10,891	17,242

For SI: 1 inch = 25.4 mm, 1 foot = 304.8 mm, 1 cubic foot per hour = 0.0283 m<sup>3</sup>/h, 1 pound per square inch = 6.895 kPa, 1-inch water column = 0.2488 kPa.

TABLE 402.4(6)  
SCHEDULE 40 METALLIC PIPE

Gas	Natural
Inlet Pressure	1.0 psi or less
Pressure Drop	0.5 inch WC
Specific Gravity	0.60

PIPE SIZE (in.)													
Nominal	1	1 1/4	1 1/2	2	2 1/2	3	3 1/2	4	5	6	8	10	12
Actual ID	1.049	1.380	1.610	2.067	2.469	3.068	3.548	4.026	5.047	6.065	7.981	10.020	11.938
Length (ft)	Maximum Capacity in Cubic Feet of Gas per Hour												
50	284	583	873	1,681	2,680	4,738	6,937	9,663	17,482	28,308	58,161	105,636	167,236
100	195	400	600	1,156	1,842	3,256	4,767	6,641	12,015	19,456	39,974	72,603	114,940
150	157	322	482	928	1,479	2,615	3,828	5,333	9,649	15,624	32,100	58,303	92,301
200	134	275	412	794	1,266	2,238	3,277	4,565	8,258	13,372	27,474	49,900	78,998
250	119	244	366	704	1,122	1,983	2,904	4,046	7,319	11,851	24,350	44,225	70,014
300	108	221	331	638	1,017	1,797	2,631	3,666	6,632	10,738	22,062	40,071	63,438
400	92	189	283	546	870	1,538	2,252	3,137	5,676	9,190	18,883	34,296	54,295
500	82	168	251	484	771	1,363	1,996	2,780	5,030	8,145	16,735	30,396	48,120
1,000	56	115	173	333	530	937	1,372	1,911	3,457	5,598	11,502	20,891	33,073
1,500	45	93	139	267	426	752	1,102	1,535	2,776	4,496	9,237	16,776	26,559
2,000	39	79	119	229	364	644	943	1,313	2,376	3,848	7,905	14,358	22,731

For SI: 1 inch = 25.4 mm, 1 foot = 304.8 mm, 1 cubic foot per hour = 0.0283 m<sup>3</sup>/h, 1 pound per square inch = 6.895 kPa, 1-inch water column = 0.2488 kPa.

TABLE 403.9.2  
 SPECIFICATIONS FOR THREADING METALLIC PIPE

IRON PIPE SIZE (inches)	APPROXIMATE LENGTH OF THREADED PORTION (inches)	APPROXIMATE NUMBER OF THREADS TO BE CUT
$\frac{1}{2}$	$\frac{5}{4}$	10
$\frac{3}{4}$	$\frac{5}{4}$	10
1	$\frac{7}{8}$	10
$1\frac{1}{4}$	1	11
$1\frac{1}{2}$	1	11
2	1	11
$2\frac{1}{2}$	$1\frac{1}{2}$	12
3	$1\frac{1}{2}$	12
4	$1\frac{3}{4}$	13

For SI: 1 inch = 25.4 mm.

**TABLE 406.7.1  
LENGTH OF PIPING REQUIRING PURGING WITH  
INERT GAS FOR SERVICING OR MODIFICATION**

<b>NOMINAL PIPE SIZE (inches)</b>	<b>LENGTH OF PIPING REQUIRING PURGING</b>
2½	> 50 feet
3	> 30 feet
4	> 15 feet
6	> 10 feet
8 or larger	Any length

For SI: 1 inch = 25.4 mm, 1 foot = 304.8 mm.

**TABLE 406.7.2  
LENGTH OF PIPING REQUIRING PURGING WITH  
INERT GAS BEFORE PLACING IN OPERATION**

NOMINAL PIPE SIZE (inches)	LENGTH OF PIPING REQUIRING PURGING
3	> 30 feet
4	> 15 feet
6	> 10 feet
8 or larger	Any length

For SI: 1 inch = 25.4 mm, 1 foot = 304.8 mm.

**TABLE 413.8.2.3  
SEPARATION DISTANCE FOR  
ATMOSPHERIC VENTING OF CNG**

EQUIPMENT OR FEATURE	MINIMUM SEPARATION (feet)
Buildings	25
Building openings	25
Lot lines	15
Public ways	15
Vehicles	25
CNG compressor and storage vessels	25
CNG dispensers	25

For SI: 1 foot = 304.8 mm.

---

**TABLE 415.1  
SUPPORT OF PIPING**

STEEL PIPE, NOMINAL SIZE OF PIPE (inches)	SPACING OF SUPPORTS (feet)	NOMINAL SIZE OF TUBING (SMOOTH-WALL) (inch O.D.)	SPACING OF SUPPORTS (feet)
$\frac{1}{2}$	6	$\frac{1}{2}$	4
$\frac{3}{4}$ or 1	8	$\frac{5}{8}$ or $\frac{3}{4}$	6
$1\frac{1}{4}$ or larger (horizontal)	10	$\frac{7}{8}$ or 1 (Horizontal)	8
$1\frac{1}{4}$ or larger (vertical)	Every floor level	1 or Larger (vertical)	Every floor level

For SI: 1 inch = 25.4 mm, 1 foot = 304.8 mm.



**TABLE 503.4**  
**TYPE OF VENTING SYSTEM TO BE USED**

<b><u>GAS UTILIZATION EQUIPMENT</u></b>	<b><u>TYPE OF VENTING SYSTEM</u></b>
Listed Category I equipment Listed equipment equipped with draft hood Equipment listed for use with Type B gas vent	Type B gas vent (Section 503.6) Chimney (Section 503.5) Single-wall metal pipe (Section 503.7) Listed chimney lining system for gas venting (Section 503.5.3) Special gas vent listed for this equipment (Section 503.4.2)
Listed vented wall furnaces	Type B-W gas vent (Sections 503.6, 608)
Category II equipment	As specified or furnished by manufacturers of listed equipment (Sections 503.4.1, 503.4.2)
Category III equipment	As specified or furnished by manufacturers of listed equipment (Sections 503.4.1, 503.4.2)
Category IV equipment	As specified or furnished by manufacturers of listed equipment (Sections 503.4.1, 503.4.2)
Incinerators, indoors	Chimney (Section 503.5)
Incinerators, outdoors	Single-wall metal pipe (Sections 503.7, 503.7.6)
Equipment which may be converted to use of solid fuel	Chimney (Section 503.5)
Unlisted combination gas and oil-burning equipment	Chimney (Section 503.5)
Listed combination gas and oil-burning equipment	Type L vent (Section 503.6) or chimney (Section 503.5)
Combination gas and solid fuel-burning equipment	Chimney (Section 503.5)
Equipment listed for use with chimneys only	Chimney (Section 503.5)
Unlisted equipment	Chimney (Section 503.5)
Decorative appliance in vented fireplace	Chimney
Direct vent equipment	See Section 503.2.2, 503.2.3
Equipment with integral vent	See Section 503.2.3, 503.2.4

**TABLE 503.7.7<sup>a</sup>**  
**CLEARANCES FOR CONNECTORS**

EQUIPMENT	MINIMUM DISTANCE FROM COMBUSTIBLE MATERIAL			
	Listed Type B gas vent material	Listed Type L vent material	Single-wall metal pipe	Factory-built chimney sections
Listed equipment with draft hoods and equipment listed for use with Type B gas vents	As listed	As listed	6 inches	As listed
Residential boilers and furnaces with listed gas conversion burner and with draft hood	6 inches	6 inches	9 inches	As listed
Residential appliances listed for use with Type L vents	Not permitted	As listed	9 inches	As listed
Listed gas-fired toilets	Not permitted	As listed	As listed	As listed
Unlisted residential appliances with draft hood	Not permitted	6 inches	9 inches	As listed
Residential and low-heat equipment other than above	Not permitted	9 inches	18 inches	As listed
Medium-heat equipment	Not permitted	Not permitted	36 inches	As listed

For SI: 1 inch = 25.4 mm.

a. These clearances shall apply unless the listing of an appliance or connector specifies different clearances, in which case the listed clearances shall apply.

**TABLE 503.10.2.4**  
**MINIMUM THICKNESS FOR GALVANIZED STEEL VENT CONNECTORS FOR LOW-HEAT APPLIANCES**

DIAMETER OF CONNECTOR (inches)	MINIMUM THICKNESS (inch)
Less than 6	0.019
6 to less than 10	0.023
10 to 12 inclusive	0.029
14 to 16 inclusive	0.034
Over 16	0.056

For SI: 1 inch = 25.4 mm.

**TABLE 503.10.2.5**  
**MINIMUM THICKNESS FOR STEEL VENT CONNECTORS FOR MEDIUM-HEAT EQUIPMENT AND COMMERCIAL AND INDUSTRIAL INCINERATORS VENT CONNECTOR SIZE**

DIAMETER (inches)	AREA (square inches)	MINIMUM THICKNESS (inch)
Up to 14	Up to 154	0.053
Over 14 to 16	154 to 201	0.067
Over 16 to 18	201 to 254	0.093
Over 18	Larger than 254	0.123

For SI: 1 inch = 25.4 mm, 1 square inch = 645.16 mm<sup>2</sup>.

**TABLE 504.2(1)**  
**TYPE B DOUBLE- WALL GAS VENT**

Number of Appliances	Single
Appliance Type	Category I
Appliance Vent Connection	Connected directly to vent

TABLE 504.2(1)  
TYPE B DOUBLE-WALL GAS VENT

HEIGHT (ft) (feet)	LATERAL (ft) (feet)	VERT DIAMETER—(D)—inches																				
		3			4			5			6			7			8			9		
		FAN		NAT	FAN		NAT	FAN		NAT	FAN		NAT	FAN		NAT	FAN		NAT	FAN		NAT
Min	Max	Max	Min	Max	Max	Min	Max	Max	Min	Max	Max	Min	Max	Max	Min	Max	Max	Min	Max	Max		
6	0	0	78	46	0	152	86	0	251	141	0	375	205	0	524	285	0	698	370	0	897	470
	2	13	51	36	18	97	67	27	157	105	32	232	157	44	321	217	53	425	285	63	543	370
	4	21	49	34	30	94	64	39	153	103	50	227	153	66	316	211	79	419	279	95	536	362
8	6	25	46	32	36	91	61	47	149	100	59	223	149	78	310	205	93	413	273	110	530	354
	0	0	84	50	0	165	94	0	276	155	0	415	235	0	583	320	0	780	415	0	1,006	537
	2	12	57	40	16	109	75	25	178	120	28	263	180	42	365	247	50	483	322	60	619	418
10	5	23	53	38	32	103	71	42	171	115	53	255	173	70	356	237	83	473	313	99	607	407
	8	28	49	35	39	98	66	51	164	109	64	247	165	84	347	227	99	463	303	117	596	396
	0	0	88	53	0	175	100	0	295	166	0	447	255	0	631	345	0	847	450	0	1,096	585
15	2	12	61	42	17	118	81	23	194	129	26	289	195	40	402	273	48	533	355	57	684	457
	5	23	57	40	32	113	77	41	187	124	52	280	188	68	392	263	81	522	346	95	671	446
	10	30	51	36	41	104	70	54	176	115	67	267	175	88	376	245	104	504	330	122	651	427
20	0	0	94	58	0	191	112	0	327	187	0	502	285	0	716	390	0	970	525	0	1,263	682
	2	11	69	48	15	136	93	20	226	150	22	339	225	38	475	316	45	633	414	53	815	544
	5	22	65	45	30	130	87	39	219	142	49	330	217	64	463	300	76	620	403	90	800	529
20	10	29	59	41	40	121	82	51	206	135	64	315	208	84	445	288	99	600	386	116	777	507
	15	35	53	37	48	112	76	61	195	128	76	301	198	96	429	275	115	580	373	134	755	491
	0	0	97	61	0	202	119	0	349	202	0	540	307	0	776	430	0	1,057	575	0	1,384	752
20	2	10	75	51	14	149	100	18	250	166	20	377	249	33	531	346	41	711	470	50	917	612
	5	21	71	48	29	143	96	38	242	160	47	367	241	62	519	337	73	697	460	86	902	599
	10	28	64	44	38	133	89	50	229	150	62	351	228	81	499	321	95	675	443	112	877	576
20	15	34	58	40	46	124	84	59	217	142	73	337	217	94	481	308	111	654	427	129	853	557
	0	48	52	35	55	116	78	69	206	134	84	322	206	107	464	295	125	634	410	145	830	537

(continued)

**Table 504.2(1) Continued**

		3		4		5		6		7		8		9								
HEIGHT (H) (feet)	LATERAL (L) (feet)	FAN		FAN		FAN		FAN		FAN		FAN		FAN								
		Min	Max	Min	Max	Min	Max	Min	Max	Min	Max	Min	Max	Min	Max							
		NAT		NAT		NAT		NAT		NAT		NAT		NAT								
		Max		Max		Max		Max		Max		Max		Max								
		Min		Min		Min		Min		Min		Min		Min								
		FAN		FAN		FAN		FAN		FAN		FAN		FAN								
		Max		Max		Max		Max		Max		Max		Max								
		Min		Min		Min		Min		Min		Min		Min								
		NAT		NAT		NAT		NAT		NAT		NAT		NAT								
		Max		Max		Max		Max		Max		Max		Max								
		Min		Min		Min		Min		Min		Min		Min								
		APPLIANCE INPUT RATING IN THOUSANDS OF BTUH		APPLIANCE INPUT RATING IN THOUSANDS OF BTUH		APPLIANCE INPUT RATING IN THOUSANDS OF BTUH		APPLIANCE INPUT RATING IN THOUSANDS OF BTUH		APPLIANCE INPUT RATING IN THOUSANDS OF BTUH		APPLIANCE INPUT RATING IN THOUSANDS OF BTUH		APPLIANCE INPUT RATING IN THOUSANDS OF BTUH								
		FAN		FAN		FAN		FAN		FAN		FAN		FAN								
		Max		Max		Max		Max		Max		Max		Max								
		Min		Min		Min		Min		Min		Min		Min								
		NAT		NAT		NAT		NAT		NAT		NAT		NAT								
		Max		Max		Max		Max		Max		Max		Max								
		Min		Min		Min		Min		Min		Min		Min								
30	0	0	100	64	0	213	128	0	374	220	0	587	336	0	853	475	0	1,173	650	0	1,548	855
	2	9	81	56	13	166	112	14	283	185	18	432	280	27	613	394	33	826	535	42	1,072	700
	5	21	77	54	28	160	108	36	275	176	45	421	273	58	600	385	69	811	524	82	1,055	688
	10	27	70	50	37	150	102	48	262	171	59	405	261	77	580	371	91	788	507	107	1,028	668
	15	33	64	NA	44	141	96	57	249	163	70	389	249	90	560	357	105	765	490	124	1,002	648
	20	56	88	NA	53	132	90	66	237	154	80	374	237	102	542	343	119	743	473	139	977	628
	30	NA	NA	NA	73	113	NA	88	214	NA	104	346	219	131	507	321	149	702	444	171	929	594
	0	0	101	67	0	216	134	0	397	232	0	633	363	0	932	518	0	1,297	708	0	1,730	952
	2	8	86	61	11	183	122	14	320	206	15	497	314	22	715	445	26	975	615	33	1,276	813
	5	20	82	NA	27	177	119	35	312	200	43	487	308	55	702	438	65	960	605	77	1,259	798
50	0	26	76	NA	35	168	114	45	299	190	56	471	298	73	681	426	86	935	589	101	1,230	773
	15	59	70	NA	42	158	NA	54	287	180	66	455	288	85	662	413	100	911	572	117	1,203	747
	20	NA	NA	NA	50	149	NA	63	275	169	76	440	278	97	642	401	113	888	556	131	1,176	722
	30	NA	NA	NA	69	131	NA	84	250	NA	99	410	259	123	605	376	141	844	522	161	1,125	670
	0	NA	NA	NA	0	218	NA	0	407	NA	0	665	400	0	997	560	0	1,411	770	0	1,908	1,040
	2	NA	NA	NA	10	194	NA	12	354	NA	13	566	375	18	831	510	21	1,155	700	25	1,536	935
	5	NA	NA	NA	26	189	NA	33	347	NA	40	557	369	52	820	504	60	1,141	692	71	1,519	926
	10	NA	NA	NA	33	182	NA	43	335	NA	53	542	361	68	801	493	80	1,118	679	94	1,492	910
	15	NA	NA	NA	40	174	NA	50	321	NA	62	528	353	80	782	482	93	1,095	666	109	1,465	895
	20	NA	NA	NA	47	166	NA	59	311	NA	71	513	344	90	763	471	105	1,073	653	122	1,438	880
30	NA	NA	NA	NA	NA	NA	78	290	NA	92	483	NA	115	726	449	131	1,029	627	149	1,387	849	
50	NA	NA	NA	NA	NA	NA	NA	NA	NA	147	428	NA	180	651	405	197	944	575	217	1,288	787	

(continued)

TABLE 504.2(1)—continued  
TYPE B DOUBLE-WALL GAS VENT

Number of Appliances		Single
Appliance Type		Category I
Appliance Vent Connection		Connected directly to vent

**Table 504.2(1) Continued**

		10			12			14			16			18			20			22			24		
HEIGHT (ft)	LATERAL (ft)	APPLIANCE INPUT RATING IN THOUSANDS OF BTU/H																							
		FAN	NAT	FAN	NAT	FAN	NAT	FAN	NAT	FAN	NAT	FAN	NAT	FAN	NAT	FAN	NAT	FAN	NAT	FAN	NAT	FAN	NAT		
		Min	Max	Min	Max	Min	Max	Min	Max	Min	Max	Min	Max	Min	Max	Min	Max	Min	Max	Min	Max	Min	Max		
6	0	0	1,121	570	0	1,645	850	0	2,267	1,170	0	2,983	1,530	0	3,802	1,960	0	4,721	2,430	0	5,737	2,950	0	6,853	3,520
	2	75	675	455	103	982	650	138	1,346	890	178	1,769	1,170	225	2,250	1,480	296	2,782	1,850	360	3,377	2,220	426	4,030	2,670
	4	110	608	445	147	975	640	191	1,338	880	242	1,761	1,160	300	2,242	1,475	390	2,774	1,835	469	3,370	2,215	555	4,023	2,660
	6	128	661	435	171	967	630	219	1,330	870	276	1,753	1,150	341	2,235	1,470	437	2,767	1,820	523	3,363	2,210	618	4,017	2,650
	0	0	1,261	660	0	1,858	970	0	2,571	1,320	0	3,399	1,740	0	4,333	2,220	0	5,387	2,750	0	6,555	3,360	0	7,838	4,010
	2	71	770	515	98	1,124	745	130	1,543	1,020	168	2,030	1,340	212	2,584	1,700	278	3,196	2,110	376	3,882	2,560	401	4,634	3,050
8	0	0	1,121	570	0	1,645	850	0	2,267	1,170	0	2,983	1,530	0	3,802	1,960	0	4,721	2,430	0	5,737	2,950	0	6,853	3,520
	2	115	758	503	154	1,110	733	199	1,528	1,010	251	2,013	1,330	311	2,563	1,685	398	3,180	2,090	476	3,863	2,545	562	4,612	3,040
	4	137	746	490	180	1,097	720	231	1,514	1,000	289	2,000	1,320	354	2,552	1,670	450	3,163	2,070	537	3,850	2,530	630	4,602	3,030
	6	142	817	525	187	1,204	795	238	1,609	1,080	298	2,209	1,430	364	2,818	1,840	459	3,504	2,280	546	4,268	2,780	641	5,099	3,340
	0	0	1,377	720	0	2,036	1,060	0	2,825	1,450	0	3,742	1,925	0	4,782	2,450	0	5,955	3,050	0	7,254	3,710	0	8,682	4,450
	2	68	852	560	93	1,244	850	124	1,713	1,120	161	2,256	1,480	202	2,868	1,890	264	3,556	2,340	319	4,322	2,840	378	5,153	3,390
10	0	0	1,121	570	0	1,645	850	0	2,267	1,170	0	2,983	1,530	0	3,802	1,960	0	4,721	2,430	0	5,737	2,950	0	6,853	3,520
	2	112	839	547	149	1,229	829	192	1,696	1,105	243	2,238	1,461	300	2,849	1,871	382	3,536	2,318	458	4,301	2,818	540	5,132	3,371
	4	142	817	525	187	1,204	795	238	1,609	1,080	298	2,209	1,430	364	2,818	1,840	459	3,504	2,280	546	4,268	2,780	641	5,099	3,340
	6	142	817	525	187	1,204	795	238	1,609	1,080	298	2,209	1,430	364	2,818	1,840	459	3,504	2,280	546	4,268	2,780	641	5,099	3,340
	0	0	1,596	840	0	2,380	1,240	0	3,323	1,720	0	4,423	2,270	0	5,678	2,900	0	7,099	3,620	0	8,665	4,410	0	10,393	5,300
	2	63	1,019	675	86	1,495	985	114	2,062	1,350	147	2,719	1,770	186	3,467	2,260	259	4,304	2,800	290	5,232	3,410	346	6,251	4,080
15	0	0	1,121	570	0	1,645	850	0	2,267	1,170	0	2,983	1,530	0	3,802	1,960	0	4,721	2,430	0	5,737	2,950	0	6,853	3,520
	2	105	1,003	660	140	1,476	967	182	2,041	1,327	229	2,696	1,748	283	3,442	2,235	355	4,278	2,777	426	5,204	3,385	501	6,222	4,057
	4	135	977	635	177	1,446	936	227	2,009	1,289	283	2,659	1,712	346	3,402	2,193	432	4,234	2,739	510	5,159	3,343	599	6,175	4,019
	6	155	953	610	202	1,418	905	257	1,976	1,250	318	2,623	1,675	385	3,363	2,150	479	4,192	2,700	564	5,115	3,300	665	6,129	3,980
	0	0	1,756	930	0	2,637	1,350	0	3,701	1,900	0	4,948	2,520	0	6,376	3,250	0	7,988	4,060	0	9,785	4,980	0	11,753	6,000
	2	59	1,150	755	81	1,694	1,100	107	2,343	1,520	139	3,097	2,000	175	3,955	2,570	220	4,916	3,200	269	5,983	3,910	321	7,154	4,700
20	0	0	1,121	570	0	1,645	850	0	2,267	1,170	0	2,983	1,530	0	3,802	1,960	0	4,721	2,430	0	5,737	2,950	0	6,853	3,520
	2	101	1,133	738	135	1,674	1,079	174	2,320	1,498	219	3,071	1,978	270	3,926	2,544	337	4,885	3,174	403	5,950	3,880	475	7,119	4,662
	4	130	1,105	710	172	1,641	1,045	220	2,282	1,460	273	3,029	1,940	334	3,880	2,500	413	4,835	3,130	489	5,896	3,830	573	7,063	4,600
	6	150	1,078	688	195	1,609	1,018	248	2,245	1,425	306	2,988	1,910	372	3,835	2,465	459	4,786	3,090	541	5,844	3,795	631	7,007	4,575
	0	0	1,052	665	217	1,578	990	273	2,210	1,390	335	2,948	1,880	404	3,791	2,430	495	4,737	3,050	585	5,792	3,760	689	6,953	4,550
	2	167	1,052	665	217	1,578	990	273	2,210	1,390	335	2,948	1,880	404	3,791	2,430	495	4,737	3,050	585	5,792	3,760	689	6,953	4,550

(continued)

Number of Appliances	Single
Appliance Type	Category 1
Appliance Vent Connection	Connected directly to vent

TABLE 504.2(1)—continued  
TYPE B DOUBLE-WALL GAS VENT

HEIGHT (ft) (feet)	VENT DIAMETER—(D) inches																								
	10		12		14		16		18		20		22		24										
	FAN Min	NAT Max	FAN Min	NAT Max	FAN Min	NAT Max	FAN Min	NAT Max	FAN Min	NAT Max	FAN Min	NAT Max	FAN Min	NAT Max	FAN Min	NAT Max									
30	0	1,977	1,060	0	3,004	1,550	0	4,252	2,170	0	5,725	2,920	0	7,420	3,770	0	9,341	4,750	0	11,483	5,850	0	13,848	7,000	
	2	54	1,351	865	74	2,004	1,310	98	2,786	1,800	127	3,696	2,380	159	4,734	3,050	199	5,900	3,810	241	7,194	4,650	285	8,617	5,600
	5	96	1,332	851	127	1,981	1,289	164	2,759	1,775	206	3,666	2,350	252	4,701	3,020	312	5,863	3,783	373	7,155	4,622	439	8,574	5,552
	10	125	1,301	829	164	1,944	1,254	209	2,716	1,733	259	3,617	2,300	316	4,647	2,970	386	5,803	3,739	456	7,090	4,574	535	8,505	5,471
	15	143	1,272	807	187	1,908	1,229	237	2,674	1,692	292	3,570	2,250	354	4,594	2,920	431	5,744	3,695	507	7,026	4,527	590	8,437	5,391
50	0	1,620	1,010	66	2,431	1,513	86	3,409	2,125	113	4,554	2,840	141	5,864	3,670	171	7,339	4,630	209	8,980	5,695	251	10,788	6,860	
	2	41	1,600	996	118	2,406	1,495	151	3,380	2,102	191	4,520	2,813	234	5,826	3,639	283	7,295	4,597	336	8,933	5,654	394	10,737	6,818
	5	118	1,567	972	154	2,366	1,466	196	3,332	2,064	243	4,464	2,767	295	5,763	3,585	355	7,224	4,542	419	8,855	5,585	491	10,652	6,749
	15	136	1,536	948	177	2,327	1,437	222	3,285	2,026	274	4,409	2,721	330	5,701	3,534	396	7,155	4,511	465	8,779	5,546	542	10,570	6,710
	20	151	1,505	924	195	2,288	1,408	244	3,239	1,987	300	4,356	2,675	361	5,641	3,481	433	7,086	4,479	506	8,704	5,506	586	10,488	6,670
100	0	1,446	876	232	2,214	1,340	287	3,150	1,910	347	4,253	2,631	412	5,523	3,431	494	6,953	4,421	577	8,557	5,444	672	10,328	6,603	
	2	0	2,491	1,310	0	3,925	2,050	0	5,729	2,950	0	7,914	4,050	0	10,485	5,300	0	13,454	6,700	0	16,817	8,600	0	20,578	10,300
	2	30	1,975	1,170	44	3,027	1,820	72	4,313	2,550	95	5,834	3,500	120	7,591	4,600	138	9,577	5,800	169	11,809	7,200	204	14,264	8,800
	5	82	1,955	1,159	107	3,002	1,803	136	4,282	2,531	172	5,797	3,475	208	7,548	4,566	245	9,528	5,769	293	11,748	7,162	341	14,204	8,756
	10	108	1,925	1,142	142	2,961	1,775	180	4,231	2,500	223	5,737	3,434	268	7,478	4,509	318	9,447	5,717	374	11,658	7,100	436	14,105	8,683
300	0	1,892	1,124	163	2,920	1,747	206	4,182	2,469	252	5,678	3,392	304	7,409	4,451	358	9,367	5,665	418	11,568	7,037	487	14,007	8,610	
	2	141	1,861	1,107	181	2,880	1,719	226	4,133	2,438	277	5,619	3,351	330	7,341	4,394	387	9,289	5,613	452	11,482	6,975	523	13,910	8,537
	5	170	1,802	1,071	215	2,803	1,663	265	4,057	2,375	319	5,505	3,267	378	7,209	4,279	446	9,156	5,509	514	11,310	6,850	592	13,720	8,391
	10	241	1,688	1,000	292	2,657	1,550	350	3,856	2,250	415	5,289	3,100	486	6,956	4,050	572	8,841	5,300	659	10,079	6,600	752	13,354	8,100

For SE: 1 inch = 25.4 mm, 1 foot = 304.8 mm, 1 British thermal unit per hour = 0.2931 W.

Table 504.2(1) Continued



**TABLE 504.2(2)**  
**TYPE B DOUBLE- WALL GAS VENT**

Number of Appliances	Single
Appliance Type	Category I
Appliance Vent Connection	Single-wall metal connector

TABLE 5.04.2(2)  
TYPE B DOUBLE-WALL GAS VENT

HEIGHT LATERAL (ft)	HEIGHT LATERAL (L) (feet)	VENT DIAMETER (D) inches																											
		APPLIANCE INPUT RATINGS IN THOUSANDS OF BTUH																											
		3		4		5		6		7		8		9		10		12											
Min	Max	FAN Min	MAF Max	FAN Min	MAF Max	FAN Min	MAF Max	FAN Min	MAF Max	FAN Min	MAF Max	FAN Min	MAF Max	FAN Min	MAF Max	FAN Min	MAF Max	FAN Min	MAF Max										
6	0	38	77	45	89	151	85	85	249	140	126	373	204	165	522	284	211	695	369	267	894	469	371	1,118	569	537	1,638	849	
	2	39	51	36	60	96	66	85	156	104	123	231	150	159	320	213	201	425	284	251	541	368	347	673	453	498	970	648	
	4	NA	NA	33	74	92	63	102	152	102	146	225	152	187	313	208	237	416	277	295	533	360	409	664	443	584	971	658	
	6	NA	NA	31	83	89	60	114	147	99	163	220	148	207	307	203	263	409	271	327	526	352	449	656	433	638	962	627	
	8	0	37	83	50	88	64	93	83	273	154	123	412	234	161	580	319	206	777	414	258	1,002	536	360	1,257	658	521	1,852	967
	2	39	56	39	59	108	75	83	176	119	121	261	179	155	303	246	197	482	321	246	617	417	339	768	513	486	1,120	743	
8	5	NA	NA	37	77	102	69	107	168	114	151	252	171	193	332	235	245	470	311	305	604	404	418	754	500	598	1,104	750	
	8	NA	NA	33	90	95	64	122	161	107	175	243	163	223	342	225	280	458	300	344	591	392	470	740	486	665	1,089	715	
	0	37	87	53	57	174	99	82	293	165	120	444	254	158	628	344	202	844	449	253	1,093	584	351	1,373	718	507	2,031	1,057	
	2	39	61	41	59	117	80	82	193	128	119	287	194	153	400	272	193	531	354	242	681	456	332	849	559	475	1,242	848	
	5	52	56	39	76	111	76	105	185	122	148	277	186	190	388	261	241	518	344	299	667	443	409	834	544	584	1,224	825	
	10	NA	NA	34	97	100	68	132	171	112	188	261	171	237	369	241	296	497	325	363	643	423	492	808	520	688	1,194	788	
10	0	36	93	57	56	190	111	80	325	186	116	499	283	153	713	388	195	966	523	244	1,258	681	336	1,591	838	488	2,374	1,237	
	2	38	69	47	57	136	93	80	225	149	115	337	224	148	473	314	187	631	413	252	812	543	319	1,015	673	457	1,491	983	
	5	51	63	44	75	128	86	102	216	140	144	326	217	182	459	298	231	616	400	287	795	526	392	997	657	562	1,468	963	
	10	NA	NA	39	95	116	79	128	201	131	182	308	203	228	438	284	284	592	381	349	768	501	470	966	628	664	1,433	928	
	15	NA	NA	NA	NA	NA	72	158	186	124	220	290	192	272	418	269	334	508	367	404	742	484	540	937	601	750	1,399	894	
	0	35	96	60	54	200	118	78	346	201	114	537	306	149	772	428	190	1,053	573	238	1,376	750	326	1,751	927	473	2,631	1,346	
20	2	37	74	50	56	148	99	78	248	165	113	375	248	144	528	344	182	708	468	227	914	611	309	1,146	754	443	1,689	1,098	
	5	50	68	47	73	140	94	100	239	158	141	363	239	178	514	334	224	692	457	279	896	596	381	1,124	734	547	1,665	1,074	
	10	NA	NA	41	93	129	86	125	223	146	177	344	224	222	491	316	277	666	437	339	866	570	457	1,092	702	646	1,626	1,037	
	15	NA	NA	NA	NA	NA	80	155	208	136	216	325	210	264	469	301	325	640	419	393	838	549	526	1,066	677	730	1,587	1,005	
	20	NA	NA	NA	NA	NA	NA	186	192	126	254	306	196	309	448	285	374	616	400	448	810	526	592	1,028	651	808	1,586	973	

(continued)

**TABLE 504.2(2) Continued**

		VENT DIAMETER—(D) inches																												
		3			4			5			6			7			8			9			10			12				
HEIGHT (H) (feet)	LATERAL (L) (feet)	FAN		NAT		FAN		NAT		FAN		NAT		FAN		NAT		FAN		NAT		FAN		NAT		FAN		NAT		
		Min	Max	Min	Max	Min	Max	Min	Max	Min	Max	Min	Max	Min	Max	Min	Max	Min	Max	Min	Max	Min	Max	Min	Max	Min	Max	Min	Max	
30	0	34	99	63	53	211	127	76	372	219	110	584	334	144	849	472	184	1,068	647	229	1,542	852	312	1,971	1,056	451	2,996	1,545		
	2	37	80	56	55	164	111	76	281	183	109	429	279	139	610	392	175	823	533	219	1,069	698	296	1,346	863	424	1,999	1,308		
	5	49	74	52	72	157	106	98	271	173	136	417	271	171	595	382	215	806	521	269	1,049	684	366	1,324	846	524	1,971	1,283		
	10	NA	NA	NA	91	144	98	122	255	168	171	397	257	213	570	367	265	777	501	327	1,017	662	440	1,287	821	620	1,927	1,234		
	15	NA	NA	NA	115	131	NA	151	239	157	208	377	242	255	547	349	312	750	481	379	985	638	507	1,251	794	702	1,884	1,205		
	20	NA	NA	NA	NA	NA	NA	181	223	NA	246	357	228	298	524	333	360	723	461	433	955	615	570	1,216	768	780	1,841	1,166		
	30	NA	NA	NA	NA	NA	NA	NA	NA	NA	NA	389	477	305	461	670	436	541	895	574	704	1,147	720	937	1,759	1,101				
	0	33	99	66	51	213	133	73	394	230	105	629	361	138	928	515	176	1,292	704	220	1,724	948	295	2,223	1,189	428	3,432	1,818		
	2	36	84	61	53	181	121	73	318	205	104	495	312	133	712	443	168	971	613	269	1,273	811	280	1,615	1,007	401	2,426	1,509		
	5	48	80	NA	70	174	117	94	308	198	131	482	305	164	696	435	204	953	602	257	1,252	795	347	1,591	991	496	2,396	1,490		
10	NA	NA	NA	89	160	NA	118	292	186	162	461	292	203	671	420	253	923	583	313	1,217	765	418	1,551	963	589	2,347	1,455			
15	NA	NA	NA	112	148	NA	145	275	174	199	441	280	244	646	405	299	894	562	363	1,183	736	481	1,512	934	668	2,299	1,421			
20	NA	NA	NA	NA	NA	NA	176	257	NA	236	420	267	285	622	389	345	866	543	415	1,150	708	544	1,473	906	741	2,251	1,387			
30	NA	NA	NA	NA	NA	NA	NA	NA	NA	315	376	NA	373	573	NA	442	809	502	521	1,086	649	674	1,399	848	892	2,159	1,318			
0	NA	NA	NA	49	214	NA	69	403	NA	100	659	395	131	991	555	166	1,404	765	207	1,900	1,033	273	2,479	1,300	395	3,912	2,042			
2	NA	NA	NA	51	192	NA	70	351	NA	98	563	373	125	828	508	158	1,152	698	196	1,532	933	259	1,970	1,168	371	3,021	1,817			
5	NA	NA	NA	67	186	NA	90	342	NA	125	551	366	156	813	501	194	1,134	688	240	1,511	921	322	1,945	1,153	460	2,990	1,796			
10	NA	NA	NA	85	175	NA	113	324	NA	153	532	354	191	789	486	238	1,104	672	293	1,477	902	389	1,905	1,133	517	2,938	1,763			
15	NA	NA	NA	132	162	NA	138	310	NA	188	511	343	230	764	473	281	1,075	656	342	1,443	884	447	1,865	1,110	618	2,888	1,730			
20	NA	NA	NA	NA	NA	NA	168	295	NA	224	487	NA	270	739	458	325	1,046	639	391	1,410	864	507	1,825	1,087	690	2,838	1,696			
30	NA	NA	NA	NA	NA	NA	231	264	NA	301	448	NA	355	685	NA	418	988	NA	491	1,343	824	631	1,747	1,041	834	2,739	1,627			
50	NA	NA	NA	NA	NA	NA	NA	NA	NA	NA	NA	NA	NA	540	584	NA	617	866	NA	711	1,205	NA	895	1,591	NA	1,138	2,547	1,489		

For SI: 1 inch = 25.4 mm, 1 foot = 304.8 mm, 1 British thermal unit per hour = 0.2931 W.

Number of Appliances	Single
Appliance Type	Category I
Appliance Vent Connection	Single-wall metal, connector

TABLE 504.2(2)—continued  
TYPE B DOUBLE-WALL GAS VENT

**TABLE 504.2(3)**  
**MASONRY CHIMNEY**

Number of Appliances	Single
Appliance Type	Category 1
Appliance Vent Connection	Type B double-wall connector

TABLE 504.2(3)  
MASONRY CHIMNEY

HEIGHT (H) (feet)	LATERAL (L) (feet)	TYPE B DOUBLE-WALL CONNECTOR DIAMETER—(D) inches to be used with chimneys with in the size limits at bottom																											
		APPLIANCE INPUT RATING IN THOUSANDS OF BTU/H																											
		3		4		5		6		7		8		9		10		12											
FAN		FAN		FAN		FAN		FAN		FAN		FAN		FAN		FAN		FAN											
Max		Max		Max		Max		Max		Max		Max		Max		Max		Max											
Min		Min		Min		Min		Min		Min		Min		Min		Min		Min											
6	2	NA	NA	28	NA	NA	NA	52	NA	NA	86	NA	NA	130	NA	NA	180	NA	NA	247	NA	NA	320	NA	NA	401	NA	NA	581
	5	NA	NA	25	NA	NA	NA	49	NA	NA	82	NA	NA	117	NA	NA	165	NA	NA	231	NA	NA	298	NA	NA	376	NA	NA	561
8	2	NA	NA	29	NA	NA	NA	55	NA	NA	93	NA	NA	145	NA	NA	198	NA	NA	266	84	590	350	100	728	446	139	1,024	651
	5	NA	NA	26	NA	NA	NA	52	NA	NA	88	NA	NA	134	NA	NA	183	NA	NA	247	NA	NA	328	149	711	423	201	1,007	640
	8	NA	NA	24	NA	NA	NA	48	NA	NA	83	NA	NA	127	NA	NA	175	NA	NA	239	NA	NA	318	173	695	410	231	990	623
10	2	NA	NA	31	NA	NA	NA	61	NA	NA	103	NA	NA	162	NA	NA	221	68	519	298	82	655	388	98	810	491	136	1,144	724
	5	NA	NA	28	NA	NA	NA	57	NA	NA	96	NA	NA	148	NA	NA	204	NA	NA	277	124	638	365	146	791	466	196	1,124	712
	10	NA	NA	25	NA	NA	NA	50	NA	NA	87	NA	NA	139	NA	NA	191	NA	NA	263	155	610	347	182	762	444	240	1,093	668
15	2	NA	NA	35	NA	NA	NA	67	NA	NA	114	NA	NA	179	53	475	259	64	613	336	77	779	441	92	968	562	127	1,376	841
	5	NA	NA	35	NA	NA	NA	62	NA	NA	107	NA	NA	164	NA	NA	231	99	594	313	118	759	416	139	946	533	186	1,352	828
	10	NA	NA	28	NA	NA	NA	55	NA	NA	97	NA	NA	153	NA	NA	216	126	565	296	148	727	394	173	912	567	229	1,315	777
20	15	NA	NA	NA	NA	NA	NA	48	NA	NA	89	NA	NA	141	NA	NA	201	NA	NA	281	171	698	375	198	880	485	259	1,280	742
	2	NA	NA	38	NA	NA	NA	74	NA	NA	124	NA	NA	201	51	522	274	61	678	375	73	867	491	87	1,083	627	121	1,548	953
	5	NA	NA	36	NA	NA	NA	68	NA	NA	116	NA	NA	184	80	503	254	95	658	350	113	845	463	133	1,059	597	179	1,523	933
20	10	NA	NA	NA	NA	NA	NA	60	NA	NA	107	NA	NA	172	NA	NA	237	122	627	332	143	811	440	167	1,022	566	221	1,482	879
	15	NA	NA	NA	NA	NA	NA	NA	NA	NA	97	NA	NA	159	NA	NA	220	NA	NA	314	165	780	418	191	987	541	251	1,443	840
	20	NA	NA	NA	NA	NA	NA	NA	NA	NA	83	NA	NA	148	NA	NA	206	NA	NA	296	NA	NA	397	214	955	513	277	1,406	807

(continued)

**TABLE 504.2(3) Continued**

Number of Appliances	Single
Appliance Type	Category 1
Appliance Vent/Connector	Type B double-wall connector

**TABLE 504.2(3)—Continued  
MASONRY CHIMNEY**

HEIGHT (H) (feet)	LATERAL (L) (feet)	TYPE B DOUBLE-WALL CONNECTOR DIAMETER—(D) inches to be used with chimney areas within the size limits at bottom																											
		APPLIANCE INPUT RATING IN THOUSANDS OF BTU/H																											
		3		4		5		6		7		8		9		10		12											
FAN		NAT		FAN		NAT		FAN		NAT		FAN		NAT		FAN		NAT											
Min		Max		Min		Max		Min		Max		Min		Max		Min		Max											
30	2	NA	NA	41	NA	NA	82	NA	NA	137	NA	NA	216	47	581	303	57	762	421	68	985	558	81	1,240	717	111	1,793	1,112	
	5	NA	NA	NA	NA	NA	76	NA	NA	128	NA	NA	198	75	561	281	90	741	393	106	962	536	125	1,216	683	169	1,766	1,094	
	10	NA	NA	NA	NA	NA	67	NA	NA	115	NA	NA	184	NA	NA	263	115	709	373	135	927	500	158	1,176	648	210	1,721	1,025	
	15	NA	NA	NA	NA	NA	NA	NA	NA	107	NA	NA	171	NA	NA	243	NA	NA	353	156	893	476	181	1,139	621	239	1,679	981	
	20	NA	NA	NA	NA	NA	NA	NA	NA	91	NA	NA	159	NA	NA	227	NA	NA	332	176	860	450	203	1,103	592	264	1,638	940	
	30	NA	NA	NA	NA	NA	NA	NA	NA	NA	NA	NA	NA	NA	NA	188	NA	NA	288	NA	NA	NA	416	249	1,035	555	318	1,560	877
	2	NA	NA	NA	NA	NA	NA	92	NA	NA	161	NA	NA	251	NA	NA	351	51	840	477	61	1,106	633	72	1,413	812	99	2,081	1,243
	5	NA	NA	NA	NA	NA	NA	NA	NA	151	NA	NA	230	NA	NA	323	83	819	445	98	1,083	596	116	1,387	774	155	2,052	1,225	
	10	NA	NA	NA	NA	NA	NA	NA	NA	138	NA	NA	215	NA	NA	304	NA	NA	424	126	1,047	567	147	1,347	733	195	2,006	1,147	
	15	NA	NA	NA	NA	NA	NA	NA	NA	127	NA	NA	199	NA	NA	282	NA	NA	400	146	1,010	539	170	1,307	702	222	1,961	1,099	
20	NA	NA	NA	NA	NA	NA	NA	NA	NA	NA	NA	185	NA	NA	264	NA	NA	376	165	977	511	190	1,269	669	246	1,916	1,050		
30	NA	NA	NA	NA	NA	NA	NA	NA	NA	NA	NA	NA	NA	NA	NA	NA	NA	327	NA	NA	NA	468	233	1,196	623	295	1,832	984	
Minimum Internal Area of Chimney (square inches)		12		19		28		38		50		63		78		95		132											
Maximum Internal Area of Chimney (square inches)		49		88		137		198		269		352		445		550		792											

For SI: 1 inch = 25.4 mm, 1 square inch = 645.16 mm<sup>2</sup>, 1 foot = 304.8 mm, 1 British thermal unit per hour = 0.2931 W.

**TABLE 504.2(4)**  
**MASONRY CHIMNEY**

Number of Appliances	Single
Appliance Type	Category 1
Appliance Vent Connection	Single-wall metal connector

TABLE 504.2(4)  
MASONRY CHIMNEY

HEIGHT (H) (feet)	LATERAL (L) (feet)	APPLIANCE INPUT RATING IN THOUSANDS OF BTU/H																									
		3		4		5		6		7		8		9		10		12									
		FAN Min	FAN Max	FAN Min	FAN Max	FAN Min	FAN Max	FAN Min	FAN Max	FAN Min	FAN Max	FAN Min	FAN Max	FAN Min	FAN Max	FAN Min	FAN Max	FAN Min	FAN Max								
6	2	NA	NA	28	NA	NA	52	NA	NA	86	NA	130	NA	180	NA	247	NA	319	NA	400	NA	580					
		NA	NA	25	NA	NA	48	NA	NA	81	NA	116	NA	164	NA	230	NA	297	NA	375	NA	560					
		NA	NA	29	NA	NA	55	NA	NA	93	NA	145	NA	197	NA	265	NA	349	382	725	445	549	1,021	660			
		NA	NA	26	NA	NA	51	NA	NA	87	NA	133	NA	182	NA	246	NA	327	NA	422	673	1,033	638				
8	8	NA	NA	23	NA	NA	47	NA	NA	82	NA	126	NA	174	NA	237	NA	317	NA	408	747	985	621				
		NA	NA	31	NA	NA	61	NA	NA	102	NA	161	NA	220	216	518	297	271	654	387	373	808	490	536	1,142	722	
		NA	NA	28	NA	NA	56	NA	NA	95	NA	147	NA	208	NA	276	334	635	364	489	789	465	657	1,121	710		
		NA	NA	24	NA	NA	49	NA	NA	86	NA	137	NA	189	NA	261	NA	345	547	758	441	771	1,088	665			
10	2	NA	NA	35	NA	NA	67	NA	NA	113	NA	178	166	473	249	211	611	335	264	776	440	362	965	560	520	1,373	840
		NA	NA	32	NA	NA	61	NA	NA	105	NA	163	NA	230	261	591	312	325	775	414	444	942	531	637	1,348	825	
		NA	NA	27	NA	NA	54	NA	NA	96	NA	151	NA	214	NA	294	392	722	392	531	907	504	749	1,309	774		
		NA	NA	NA	NA	NA	46	NA	NA	87	NA	138	NA	198	NA	278	452	692	372	605	873	481	841	1,272	738		
15	2	NA	NA	38	NA	NA	73	NA	NA	123	NA	200	163	520	273	206	675	374	258	864	490	252	1,079	625	508	1,544	950
		NA	NA	35	NA	NA	67	NA	NA	115	NA	183	80	NA	252	255	665	348	317	842	461	433	1,055	594	623	1,518	930
		NA	NA	NA	NA	NA	59	NA	NA	105	NA	170	NA	235	312	622	330	382	805	437	517	1,016	562	733	1,475	875	
		NA	NA	NA	NA	NA	NA	NA	NA	95	NA	156	NA	217	NA	311	442	773	414	591	979	539	823	1,434	835		
20	20	NA	NA	NA	NA	NA	NA	NA	NA	80	NA	144	NA	202	NA	292	NA	392	666	944	510	911	1,394	800			

*(continued)*

**Table 504.2(4) Continued**

Number of Appliances	Single
Appliance Type	Category 1
Appliance Vent Connection	Single-wall metal connector

TABLE 504.2(4)—continued  
MASONRY CHIMNEY

HEIGHT (ft)	LATERAL (ft)	TYPE B DOUBLE-WALL CONNECTOR DIAMETER—(D) inches to be used with chimney areas within the size limits at bottom																														
		APPLIANCE INPUT RATING IN THOUSANDS OF BTUH																														
		3		4		5		6		7		8		9		10		12														
FAN		FAN		FAN		FAN		FAN		FAN		FAN		FAN		FAN		FAN														
NAT		NAT		NAT		NAT		NAT		NAT		NAT		NAT		NAT		NAT														
Max		Max		Max		Max		Max		Max		Max		Max		Max		Max														
Min		Min		Min		Min		Min		Min		Min		Min		Min		Min														
30	2	NA	NA	41	NA	NA	81	NA	NA	136	NA	215	1.58	578	302	2.00	7.59	42.0	2.49	982	55.6	34.0	1.237	715	489	1.788	1,110					
	5	NA	NA	NA	NA	NA	75	NA	NA	127	NA	196	NA	NA	279	2.45	7.37	39.1	3.06	958	52.4	41.7	1.210	680	600	1.760	1,090					
	10	NA	NA	NA	NA	NA	66	NA	NA	113	NA	182	NA	NA	260	3.00	7.03	37.0	3.70	920	49.6	50.0	1.168	644	708	1.713	1,020					
	15	NA	NA	NA	NA	NA	NA	NA	NA	105	NA	168	NA	NA	240	NA	NA	349	4.28	884	47.1	57.2	1.128	615	798	1.668	975					
	20	NA	NA	NA	NA	NA	NA	NA	NA	88	NA	155	NA	NA	223	NA	NA	32.7	NA	NA	44.5	64.3	1.089	585	883	1.624	932					
	30	NA	NA	NA	NA	NA	NA	NA	NA	NA	NA	NA	NA	NA	182	NA	NA	281	NA	NA	408	NA	544	1.055	1,539	865	NA	NA	5.44	1.055	1,539	865
50	2	NA	NA	NA	NA	NA	91	NA	NA	160	NA	250	NA	NA	350	1.91	837	47.5	2.38	1,103	63.1	32.3	1.408	810	463	2.076	1,240					
	5	NA	NA	NA	NA	NA	NA	NA	NA	149	NA	228	NA	NA	32.1	NA	44.2	2.93	1,078	59.3	39.8	1.381	770	571	2.044	1,220						
	10	NA	NA	NA	NA	NA	NA	NA	NA	136	NA	212	NA	NA	30.1	NA	42.0	3.55	1,038	56.2	44.7	1.337	728	674	1.994	1,140						
	15	NA	NA	NA	NA	NA	NA	NA	NA	124	NA	195	NA	NA	278	NA	NA	39.5	NA	NA	53.3	54.6	1.294	695	761	1.945	1,090					
	20	NA	NA	NA	NA	NA	NA	NA	NA	NA	NA	180	NA	NA	258	NA	NA	37.0	NA	NA	50.4	61.6	1.251	660	844	1.898	1,040					
	30	NA	NA	NA	NA	NA	NA	NA	NA	NA	NA	NA	NA	NA	NA	NA	NA	31.8	NA	NA	45.8	NA	NA	610	1,009	1,805	970	NA	NA	610	1,009	1,805
Minimum Internal Area of Chimney (square inches)		12		19		28		38		50		63		78		95		132														
Maximum Internal Area of Chimney (square inches)		49		88		137		198		269		352		445		550		792														

For SI: 1 inch = 25.4 mm, 1 square inch = 645.16 mm<sup>2</sup>, 1 foot = 304.8 mm, 1 British thermal unit per hour = 0.2931 W.



**TABLE 504.2(5)**  
**SINGLE-WALL METAL PIPE OR TYPE B ASBESTOS CEMENT VENT**

TABLE 504.2(5)  
SINGLE-WALL METAL PIPE OR TYPE B  
ASBESTOS CEMENT VENT

Number of Appliances	Single
Appliance Type	Category 1
Appliance Vent Connection	Connected directly to pipe or vent

HEIGHT (H) (feet)	LATERAL (L) (feet)	VENT DIAMETER—(D) inches							
		3	4	5	6	7	8	10	12
MAXIMUM APPLIANCE INPUT RATING IN THOUSANDS OF BTUH									
6	0	39	70	116	170	232	312	500	750
	2	31	55	94	141	194	260	415	620
	5	28	51	88	128	177	242	390	600
8	0	42	76	126	185	252	340	542	815
	2	32	61	102	154	210	284	451	680
	5	29	56	95	141	194	264	430	648
	10	24	49	86	131	180	250	406	625
10	0	45	84	138	202	279	372	606	912
	2	35	67	111	168	233	311	505	760
	5	32	61	104	153	215	289	480	724
	10	27	54	94	143	200	274	455	700
	15	NA	46	84	130	186	258	432	666
15	0	49	91	151	223	312	420	684	1,040
	2	39	72	122	186	260	350	570	865
	5	35	67	110	170	240	325	540	825
	10	30	58	103	158	223	308	514	795
	15	NA	50	93	144	207	291	488	760
	20	NA	NA	82	132	195	273	466	726
20	0	53	101	163	252	342	470	770	1,190
	2	42	80	136	210	286	392	641	990
	5	38	74	123	192	264	364	610	945
	10	32	65	115	178	246	345	571	910
	15	NA	55	104	163	228	326	550	870
	20	NA	NA	91	149	214	306	525	832
	30	NA	NA	78	137	210	296	410	694
30	0	56	108	183	276	384	529	878	1,370
	2	44	84	148	230	320	441	730	1,140
	5	NA	78	137	210	296	410	694	1,080
	10	NA	68	125	196	274	388	656	1,050
	15	NA	NA	113	177	258	366	625	1,000
	20	NA	NA	99	163	240	344	596	960
	30	NA	NA	NA	NA	192	295	540	890
	50	NA	NA	120	210	310	443	590	980
50	0	NA	95	171	260	370	492	820	1,290
	2	NA	NA	159	234	342	474	780	1,230
	5	NA	NA	146	221	318	456	730	1,190
	10	NA	NA	NA	200	292	407	705	1,130
	15	NA	NA	NA	185	276	384	670	1,080
	20	NA	NA	NA	185	276	384	670	1,080
	30	NA	NA	NA	NA	222	330	605	1,010

For SI: 1 inch = 25.4 mm, 1 foot = 304.8 mm, 1 British thermal unit per hour = 0.2931 W.

**TABLE 504.3(1)  
TYPE B DOUBLE-WALL VENT**

Number of Appliances	Two or more
Appliance Type	Category I
Appliance Vent Connection	Type B double-wall connector

**VENT CONNECTOR CAPACITY**

VENT HEIGHT (H) (feet)	CONNECTOR RISE (R) (feet)	TYPE B DOUBLE-WALL VENT AND CONNECTOR DIAMETER—(D) inches																							
		3			4			5			6			7			8			9			10		
		APPLIANCE INPUT RATING LIMITS IN THOUSANDS OF BTU/H																							
		FAN		NAT		FAN		NAT		FAN		NAT		FAN		NAT		FAN		NAT		FAN		NAT	
Min	Max	Min	Max	Min	Max	Min	Max	Min	Max	Min	Max	Min	Max	Min	Max	Min	Max	Min	Max	Min	Max	Min	Max		
6	1	22	37	26	35	66	46	106	72	58	164	104	77	225	142	92	296	185	109	376	237	128	466	289	
	2	23	41	31	37	75	55	48	121	86	60	183	124	79	253	168	95	333	220	112	424	282	131	526	345
	3	24	44	35	38	81	62	49	132	96	62	199	139	82	275	189	97	363	248	114	463	317	134	575	386
8	1	22	40	27	35	72	48	49	114	76	64	176	109	84	243	148	100	320	194	118	408	248	138	507	303
	2	23	44	32	36	80	57	51	128	90	66	195	129	86	269	175	103	356	230	121	454	294	141	564	358
	3	24	47	36	37	87	64	53	139	101	67	210	145	88	290	198	105	384	258	123	492	330	143	612	402
10	1	22	43	28	34	78	50	49	123	78	65	189	113	89	257	154	106	341	200	125	436	257	146	542	314
	2	23	47	33	36	86	59	51	136	93	67	206	134	91	282	182	109	374	238	128	479	305	149	596	372
	3	24	50	37	37	92	67	52	146	104	69	220	150	94	303	205	111	402	268	131	515	342	152	642	417
15	1	21	50	30	33	89	53	47	142	83	64	220	120	88	298	163	110	389	214	134	493	273	162	609	333
	2	22	53	35	35	96	63	49	153	99	66	235	142	91	320	193	112	419	253	137	532	323	165	658	394
	3	24	55	40	36	102	71	51	163	111	68	248	160	93	339	218	115	445	286	140	565	365	167	700	444
20	1	21	54	31	33	99	56	46	157	87	62	246	125	86	334	171	107	436	224	131	552	285	158	681	347
	2	22	57	37	34	105	66	48	167	104	64	259	149	89	354	202	110	463	265	134	587	339	161	725	414
	3	23	60	42	35	110	74	50	176	116	66	271	168	91	371	228	113	486	300	137	618	383	164	764	466
30	1	20	62	33	31	113	59	45	181	93	60	288	134	83	391	182	103	512	238	125	649	305	151	802	372
	2	21	64	39	33	118	70	47	190	110	62	299	158	85	408	215	105	535	282	129	679	360	155	840	439
	3	22	66	44	34	123	79	48	198	124	64	309	178	88	423	242	108	555	317	132	706	405	158	874	494
50	1	19	71	36	30	133	64	43	216	101	57	349	145	78	477	197	97	627	257	120	797	330	144	984	403
	2	21	73	43	32	137	76	45	223	119	59	358	172	81	490	234	100	645	306	123	820	392	148	1,014	478
	3	22	75	48	33	141	86	46	229	134	61	366	194	83	502	263	103	661	343	126	842	441	151	1,043	538
100	1	18	82	37	28	158	66	40	262	104	53	442	150	73	611	204	91	810	266	112	1,038	341	135	1,285	417
	2	19	83	44	30	161	79	42	267	123	55	447	178	75	619	242	94	822	316	115	1,054	405	139	1,306	494
	3	20	84	50	31	163	89	44	272	138	57	452	199	78	627	272	97	834	355	118	1,069	455	142	1,327	555

**COMMON VENT CAPACITY**

VENT HEIGHT (H) (feet)	TYPE B DOUBLE-WALL COMMON VENT DIAMETER (D)—Inches																				
	4			5			6			7			8			9			10		
	COMBINED APPLIANCE INPUT RATING IN THOUSANDS OF BTU/H																				
	FAN +FAN	FAN +NAT	NAT +NAT	FAN +FAN	FAN +NAT	NAT +NAT	FAN +FAN	FAN +NAT	NAT +NAT	FAN +FAN	FAN +NAT	NAT +NAT	FAN +FAN	FAN +NAT	NAT +NAT	FAN +FAN	FAN +NAT	NAT +NAT	FAN +FAN	FAN +NAT	NAT +NAT
6	92	81	65	140	116	103	204	161	147	309	248	200	404	314	260	547	434	335	672	520	410
8	101	90	73	155	129	114	224	178	163	339	275	223	444	348	290	602	480	378	740	577	465
10	110	97	79	169	141	124	243	194	178	367	299	242	477	377	315	649	522	405	800	627	495
15	125	112	91	195	164	144	283	228	206	427	352	280	556	444	365	753	612	465	924	733	565
20	136	123	102	215	183	160	314	255	229	475	394	310	621	499	405	842	688	523	1,035	826	640
30	152	138	118	244	210	185	361	297	266	547	459	360	720	585	470	979	808	605	1,209	975	740
50	167	153	134	279	244	214	421	353	310	641	547	423	854	706	550	1,164	977	705	1,451	1,188	860
100	175	163	NA	311	277	NA	489	421	NA	751	658	479	1,025	873	625	1,408	1,215	800	1,784	1,502	975

(continued)

**TABLE 504.3(1)—continued  
TYPE B DOUBLE-WALL VENT**

Number of Appliances	Two or more
Appliance Type	Category I
Appliance Vent Connection	Type B double-wall connector

**VENT CONNECTOR CAPACITY**

VENT HEIGHT (H) (feet)	CONNECTOR RISE (R) (feet)	TYPE B DOUBLE-WALL VENT AND DIAMETER—(D) Inches																											
		12				14				16				18				20				22				24			
		APPLIANCE INPUT RATING LIMITS IN THOUSANDS OF BTU/H																											
		FAN		NAT		FAN		NAT		FAN		NAT		FAN		NAT		FAN		NAT		FAN		NAT					
Min	Max	Max	Min	Max	Max	Min	Max	Max	Min	Max	Max	Min	Max	Max	Min	Max	Max	Min	Max	Max	Min	Max	Max						
6	2	174	764	496	223	1,046	653	281	1,371	853	346	1,772	1,080	NA	NA	NA	NA	NA	NA	NA	NA	NA	NA	NA					
	4	180	897	616	230	1,231	827	287	1,617	1,081	352	2,069	1,370	NA	NA	NA	NA	NA	NA	NA	NA	NA	NA	NA					
	6	NA	NA	NA	NA	NA	NA	NA	NA	NA	NA	NA	NA	NA	NA	NA	NA	NA	NA	NA	NA	NA	NA	NA					
8	2	186	822	516	238	1,126	696	298	1,478	910	365	1,920	1,150	NA	NA	NA	NA	NA	NA	NA	NA	NA	NA	NA					
	4	192	952	644	244	1,307	884	305	1,719	1,150	372	2,211	1,460	471	2,737	1,800	560	3,319	2,180	662	3,957	2,590							
	6	198	1,050	772	252	1,445	1,072	313	1,902	1,390	380	2,434	1,770	478	3,018	2,180	568	3,665	2,640	669	4,373	3,130							
10	2	196	870	536	249	1,195	730	311	1,570	955	379	2,049	1,205	NA	NA	NA	NA	NA	NA	NA	NA	NA	NA	NA					
	4	201	997	664	256	1,371	924	318	1,804	1,205	387	2,332	1,535	486	2,887	1,890	581	3,502	2,280	686	4,175	2,710							
	6	207	1,095	792	263	1,509	1,118	325	1,989	1,455	395	2,556	1,865	494	3,169	2,290	589	3,849	2,760	694	4,593	3,270							
15	2	214	967	568	272	1,334	790	336	1,760	1,030	408	2,317	1,305	NA	NA	NA	NA	NA	NA	NA	NA	NA	NA	NA					
	4	221	1,085	712	279	1,499	1,006	344	1,978	1,320	416	2,579	1,665	523	3,197	2,060	624	3,881	2,490	734	4,631	2,960							
	6	228	1,181	856	286	1,632	1,222	351	2,157	1,610	424	2,796	2,025	533	3,470	2,510	634	4,216	3,030	743	5,035	3,600							
20	2	223	1,051	596	291	1,443	840	357	1,911	1,095	430	2,533	1,385	NA	NA	NA	NA	NA	NA	NA	NA	NA	NA	NA					
	4	230	1,162	748	298	1,597	1,064	365	2,116	1,395	438	2,778	1,765	554	3,447	2,180	661	4,190	2,630	772	5,005	3,130							
	6	237	1,253	900	307	1,726	1,288	373	2,287	1,695	450	2,984	2,145	567	3,708	2,650	671	4,511	3,190	785	5,392	3,790							
30	2	216	1,217	632	286	1,664	910	367	2,183	1,190	461	2,891	1,540	NA	NA	NA	NA	NA	NA	NA	NA	NA	NA	NA					
	4	223	1,316	792	294	1,802	1,160	376	2,366	1,510	474	3,110	1,920	619	3,840	2,365	728	4,861	2,860	847	5,606	3,410							
	6	231	1,400	952	303	1,920	1,410	384	2,524	1,830	485	3,299	2,340	632	4,080	2,875	741	4,976	3,480	860	5,961	4,150							
50	2	206	1,479	689	273	2,023	1,007	350	2,659	1,315	435	3,548	1,665	NA	NA	NA	NA	NA	NA	NA	NA	NA	NA	NA					
	4	213	1,561	860	281	2,139	1,291	359	2,814	1,685	447	3,730	2,135	580	4,601	2,633	709	5,569	3,185	851	6,633	3,790							
	6	221	1,631	1,031	290	2,242	1,575	369	2,951	2,055	461	3,893	2,605	594	4,808	3,208	724	5,826	3,885	867	6,943	4,620							
100	2	192	1,923	712	254	2,644	1,050	326	3,490	1,370	402	4,707	1,740	NA	NA	NA	NA	NA	NA	NA	NA	NA	NA	NA					
	4	200	1,984	888	263	2,731	1,346	336	3,606	1,760	414	4,842	2,220	523	5,982	2,750	639	7,254	3,330	769	8,650	3,950							
	6	208	2,035	1,064	272	2,811	1,642	346	3,714	2,150	426	4,968	2,700	539	6,143	3,350	654	7,453	4,070	786	8,892	4,810							

**COMMON VENT CAPACITY**

VENT HEIGHT (H) (feet)	TYPE B DOUBLE-WALL COMMON VENT DIAMETER—(D) Inches																											
	12				14				16				18				20				22				24			
	COMBINED APPLIANCE INPUT RATING IN THOUSANDS OF BTU/H																											
	FAN +FAN	FAN +NAT	NAT +NAT	FAN +FAN	FAN +NAT	NAT +NAT	FAN +FAN	FAN +NAT	NAT +NAT	FAN +FAN	FAN +NAT	NAT +NAT	FAN +FAN	FAN +NAT	NAT +NAT	FAN +FAN	FAN +NAT	NAT +NAT	FAN +FAN	FAN +NAT	NAT +NAT	FAN +FAN	FAN +NAT	NAT +NAT				
6	900	696	588	1,284	990	815	1,735	1,336	1,065	2,253	1,732	1,345	2,838	2,180	1,660	3,488	2,677	1,970	4,206	3,226	2,360							
8	994	773	652	1,423	1,103	912	1,927	1,491	1,190	2,507	1,936	1,510	3,162	2,439	1,860	3,890	2,998	2,200	4,695	3,616	2,680							
10	1,076	841	712	1,542	1,200	995	2,093	1,625	1,300	2,727	2,113	1,645	3,444	2,665	2,030	4,241	3,278	2,400	5,123	3,957	2,920							
15	1,247	986	825	1,794	1,410	1,158	2,440	1,910	1,510	3,184	2,484	1,910	4,026	3,133	2,360	4,971	3,862	2,790	6,016	4,670	3,400							
20	1,405	1,116	916	2,006	1,588	1,290	2,722	2,147	1,690	3,561	2,798	2,140	4,548	3,552	2,640	5,573	4,352	3,120	6,749	5,261	3,800							
30	1,658	1,327	1,025	2,373	1,892	1,525	3,220	2,558	1,990	4,197	3,326	2,520	5,303	4,193	3,110	6,539	5,157	3,680	7,940	6,247	4,480							
50	2,024	1,640	1,280	2,911	2,347	1,863	3,964	3,183	2,430	5,184	4,149	3,075	6,567	5,240	3,800	8,116	6,458	4,500	9,837	7,813	5,475							
100	2,569	2,131	1,670	3,732	3,076	2,450	5,125	4,202	3,200	6,749	5,509	4,050	8,597	6,986	5,000	10,681	8,648	5,920	13,004	10,499	7,200							

For SI: 1 inch = 25.4 mm, 1 foot = 304.8 mm, 1 British thermal unit per hour = 0.2931 W.

**TABLE 504.3(2)  
TYPE B DOUBLE-WALL VENT**

Number of Appliances	Two or more
Appliance Type	Category I
Appliance Vent Connection	Single-wall metal connector

**VENT CONNECTOR CAPACITY**

VENT HEIGHT (H) (feet)	CONNECTOR RISE (R) (feet)	SINGLE-WALL METAL VENT CONNECTOR DIAMETER—(D) Inches																							
		3			4			5			6			7			8			9			10		
		APPLIANCE INPUT RATING LIMITS IN THOUSANDS OF BTUH																							
		FAN		NAT		FAN		NAT		FAN		NAT		FAN		NAT		FAN		NAT		FAN		NAT	
Min	Max	Max	Min	Max	Max	Min	Max	Max	Min	Max	Max	Min	Max	Max	Min	Max	Max	Min	Max	Max	Min	Max	Max		
6	1	NA	NA	26	NA	NA	46	NA	NA	71	NA	NA	102	207	223	140	262	293	183	325	373	234	447	463	286
	2	NA	NA	31	NA	NA	55	NA	NA	85	168	182	123	215	251	167	271	331	219	334	422	281	458	524	344
	3	NA	NA	34	NA	NA	62	121	131	95	175	198	138	222	273	188	279	361	247	344	462	316	468	574	385
8	1	NA	NA	27	NA	NA	48	NA	NA	75	NA	NA	106	226	240	145	285	316	191	352	403	244	481	502	299
	2	NA	NA	32	NA	NA	57	125	126	89	184	193	127	234	266	173	293	353	228	360	450	292	492	560	355
	3	NA	NA	35	NA	NA	64	130	138	100	191	208	144	241	287	197	302	381	256	370	489	328	501	609	400
10	1	NA	NA	28	NA	NA	50	119	121	77	182	186	110	240	253	150	302	335	196	372	429	252	506	534	308
	2	NA	NA	33	84	85	59	124	134	91	189	203	132	248	278	183	311	369	235	381	473	302	517	589	368
	3	NA	NA	36	89	91	67	129	144	102	197	217	148	257	299	203	320	398	265	391	511	339	528	637	413
15	1	NA	NA	29	79	87	52	116	138	81	177	214	116	238	291	158	312	380	208	397	482	266	556	596	324
	2	NA	NA	34	83	94	62	121	150	97	185	230	138	246	314	189	321	411	248	407	522	317	568	646	387
	3	NA	NA	39	87	100	70	127	160	109	193	243	157	255	333	215	331	438	281	418	557	360	579	690	437
20	1	49	56	30	78	97	54	115	152	84	175	238	120	233	325	165	306	425	217	390	538	276	546	664	336
	2	52	59	36	82	103	64	120	163	101	182	252	144	243	346	197	317	453	259	400	574	331	558	709	403
	3	55	62	40	87	107	72	125	172	113	190	264	164	252	363	223	326	476	294	412	607	375	570	750	457
30	1	47	60	31	77	110	57	112	175	89	169	278	129	226	380	175	296	497	230	378	630	294	528	779	358
	2	51	62	37	81	115	67	117	185	106	177	290	152	236	397	208	307	521	274	389	662	349	541	819	425
	3	54	64	42	85	119	76	122	193	120	185	300	172	244	412	235	316	542	309	400	690	394	555	855	482
50	1	46	69	34	75	128	60	109	207	96	162	336	137	217	460	188	284	604	245	364	768	314	507	951	384
	2	49	71	40	79	132	72	114	215	113	170	345	164	226	473	223	294	623	293	376	793	375	520	983	458
	3	52	72	45	83	136	82	119	221	123	178	353	186	235	486	252	304	640	331	387	816	423	535	1,013	518
100	1	45	79	34	71	150	61	104	249	98	153	424	140	205	585	192	269	774	249	345	993	321	476	1,236	393
	2	48	80	41	75	153	73	110	255	115	160	428	167	212	593	228	279	788	299	358	1,011	383	490	1,259	469
	3	51	81	46	79	157	85	114	260	129	168	433	190	222	603	256	289	801	339	368	1,027	431	506	1,280	527

**COMMON VENT CAPACITY**

VENT HEIGHT (H) (feet)	TYPE B DOUBLE-WALL COMMON VENT DIAMETER—(D) Inches																				
	4			5			6			7			8			9			10		
	COMBINED APPLIANCE INPUT RATING IN THOUSANDS OF BTUH																				
	FAN +FAN	FAN +NAT	NAT +NAT	FAN +FAN	FAN +NAT	NAT +NAT	FAN +FAN	FAN +NAT	NAT +NAT	FAN +FAN	FAN +NAT	NAT +NAT	FAN +FAN	FAN +NAT	NAT +NAT	FAN +FAN	FAN +NAT	NAT +NAT	FAN +FAN	FAN +NAT	NAT +NAT
6	NA	78	64	NA	113	99	200	158	144	304	244	196	398	310	257	541	429	332	665	515	407
8	NA	87	71	NA	126	111	218	173	159	331	269	218	436	342	285	592	473	373	730	569	460
10	NA	94	76	163	137	120	237	189	174	357	292	236	467	369	309	638	512	398	787	617	487
15	121	108	88	189	159	140	275	221	200	416	343	274	544	434	357	738	599	456	905	718	553
20	131	118	98	208	177	156	305	247	223	463	383	302	606	487	395	824	673	512	1,013	808	626
30	145	132	113	236	202	180	350	286	257	533	446	349	703	570	459	958	790	593	1,183	952	723
50	159	145	128	268	233	208	406	337	296	622	529	410	833	686	535	1,139	954	689	1,418	1,157	838
100	166	153	NA	297	263	NA	469	398	NA	726	633	464	999	846	606	1,378	1,185	780	1,741	1,459	948

For SI: 1 inch = 25.4 mm, 1 foot = 304.8 mm, 1 British thermal unit per hour = 0.2931 W.

**TABLE 504.3(3)  
MASONRY CHIMNEY**

Number of Appliances	Two or more
Appliance Type	Category I
Appliance Vent Connection	Type B double-wall connector

**VENT CONNECTOR CAPACITY**

VENT HEIGHT (H) (feet)	CONNECTOR RISE (R) (feet)	TYPE B DOUBLE-WALL VENT CONNECTOR DIAMETER—(D) Inches																							
		3		4		5		6		7		8		9		10									
		APPLIANCE INPUT RATING LIMITS IN THOUSANDS OF BTU/H																							
		FAN		NAT		FAN		NAT		FAN		NAT		FAN		NAT		FAN		NAT		FAN		NAT	
Min	Max	Max	Min	Max	Max	Min	Max	Max	Min	Max	Max	Min	Max	Max	Min	Max	Max	Min	Max	Max	Min	Max	Max		
6	1	24	33	21	39	62	40	52	106	67	65	194	101	87	274	141	104	370	201	124	479	253	145	599	319
	2	26	43	28	41	79	52	53	133	85	67	230	124	89	324	173	107	436	232	127	562	300	148	694	378
	3	27	49	34	42	92	61	55	155	97	69	262	143	91	369	203	109	491	270	129	633	349	151	795	439
8	1	24	39	22	39	72	41	55	117	69	71	213	105	94	304	148	113	414	210	134	539	267	156	682	335
	2	26	47	29	40	87	53	57	140	86	73	246	127	97	350	179	116	473	240	137	615	311	160	776	394
	3	27	52	34	42	97	62	59	159	98	75	269	145	99	383	206	119	517	276	139	672	358	163	848	452
10	1	24	42	22	38	80	42	55	130	71	74	232	108	101	324	153	120	444	216	142	582	277	165	739	348
	2	26	50	29	40	93	54	57	153	87	76	261	129	103	366	184	123	498	247	145	652	321	168	825	407
	3	27	55	35	41	105	63	58	170	100	78	284	148	106	397	209	126	540	281	147	705	366	171	893	463
15	1	24	48	23	38	93	44	54	154	74	72	277	114	100	384	164	125	511	229	153	658	297	184	824	375
	2	25	55	31	39	105	55	56	174	89	74	299	134	103	419	192	128	558	260	156	718	339	187	900	432
	3	26	59	35	41	115	64	57	189	102	76	319	153	105	448	215	131	597	292	159	760	382	190	960	486
20	1	24	52	24	37	102	46	53	172	77	71	313	119	98	437	173	123	584	239	150	752	312	180	943	397
	2	25	58	31	39	114	56	55	190	91	73	335	138	101	467	199	126	625	270	153	805	354	184	1,011	452
	3	26	63	35	40	123	65	57	204	104	75	353	157	104	493	222	129	661	301	156	851	396	187	1,067	505
30	1	24	54	25	37	111	48	52	192	82	69	357	127	96	504	187	119	680	255	145	883	337	175	1,115	432
	2	25	60	32	38	122	58	54	208	95	72	376	145	99	531	209	122	715	287	149	928	378	179	1,171	484
	3	26	64	36	40	131	66	56	221	107	74	392	163	101	554	233	125	746	317	152	968	418	182	1,220	535
50	1	23	51	25	36	116	51	51	209	89	67	405	143	92	582	213	115	798	294	140	1,049	392	168	1,334	506
	2	24	59	32	37	127	61	53	225	102	70	421	161	95	604	235	118	827	326	143	1,085	433	172	1,379	558
	3	26	64	36	39	135	69	55	237	115	72	435	180	98	624	260	121	854	357	147	1,118	474	176	1,421	611
100	1	23	46	24	35	108	50	49	208	92	65	428	155	88	640	237	109	907	334	134	1,222	454	161	1,589	596
	2	24	53	31	37	120	60	51	224	105	67	444	174	92	660	260	113	933	368	138	1,253	497	165	1,626	651
	3	25	59	35	38	130	68	53	237	118	69	458	193	94	679	285	116	956	399	141	1,282	540	169	1,661	705

**COMMON VENT CAPACITY**

VENT HEIGHT (H) (feet)	MINIMUM INTERNAL AREA OF MASONRY CHIMNEY FLUE (square inches)																							
	12		19		28		38		50		63		78		118									
	COMBINED APPLIANCE INPUT RATING IN THOUSANDS OF BTU/H																							
FAN +FAN	FAN +NAT	NAT +NAT	FAN +FAN	FAN +NAT	NAT +NAT	FAN +FAN	FAN +NAT	NAT +NAT	FAN +FAN	FAN +NAT	NAT +NAT	FAN +FAN	FAN +NAT	NAT +NAT	FAN +FAN	FAN +NAT	NAT +NAT	FAN +FAN	FAN +NAT	NAT +NAT	FAN +FAN	FAN +NAT	NAT +NAT	
6	NA	74	25	NA	119	46	NA	178	71	NA	257	103	NA	351	143	NA	458	188	NA	582	246	1,041	853	NA
8	NA	80	28	NA	130	53	NA	193	82	NA	279	119	NA	384	163	NA	501	218	724	636	278	1,144	937	408
10	NA	84	31	NA	138	56	NA	207	90	NA	299	131	NA	409	177	606	538	236	776	686	302	1,226	1,010	454
15	NA	NA	36	NA	152	67	NA	233	106	NA	334	152	523	467	212	682	611	283	874	781	365	1,374	1,156	546
20	NA	NA	41	NA	NA	75	NA	250	122	NA	368	172	565	508	243	742	668	325	955	858	419	1,513	1,286	648
30	NA	NA	NA	NA	NA	NA	NA	270	137	NA	404	198	615	564	278	816	747	381	1,062	969	496	1,702	1,473	749
50	NA	NA	NA	NA	NA	NA	NA	NA	NA	NA	NA	NA	NA	620	328	879	831	461	1,165	1,089	606	1,905	1,692	922
100	NA	NA	NA	NA	NA	NA	NA	NA	NA	NA	NA	NA	NA	NA	348	NA	NA	499	NA	NA	669	2,053	1,921	1,058

For SI: 1 inch = 25.4 mm, 1 square inch = 645.16 mm<sup>2</sup>, 1 foot = 304.8 mm, 1 British thermal unit per hour = 0.2931 W.

**TABLE 504.3(4)  
MASONRY CHIMNEY**

Number of Appliances	Two or more
Appliance Type	Category I
Appliance Vent Connection	Single-wall metal connector

**VENT CONNECTOR CAPACITY**

VENT HEIGHT (H) (feet)	CONNECTOR RISE (R) (feet)	SINGLE-WALL METAL VENT CONNECTOR DIAMETER (D)—Inches																							
		3		4		5		6		7		8		9		10									
		APPLIANCE INPUT RATING LIMITS IN THOUSANDS OF BTUH																							
		FAN		NAT		FAN		NAT		FAN		NAT		FAN		NAT		FAN		NAT		FAN		NAT	
Min	Max	Min	Max	Min	Max	Min	Max	Min	Max	Min	Max	Min	Max	Min	Max	Min	Max	Min	Max	Min	Max	Min	Max		
6	1	NA	NA	21	NA	NA	39	NA	NA	66	179	191	100	231	271	140	292	366	200	362	474	252	499	594	316
	2	NA	NA	28	NA	NA	52	NA	NA	84	186	227	123	239	321	172	301	432	231	373	557	299	509	696	376
	3	NA	NA	34	NA	NA	61	134	153	97	193	258	142	247	365	202	309	491	269	381	634	348	519	793	437
8	1	NA	NA	21	NA	NA	40	NA	NA	68	195	208	103	250	298	146	313	407	207	387	530	263	529	672	331
	2	NA	NA	28	NA	NA	52	137	139	85	202	240	125	258	343	177	323	465	238	397	607	309	540	766	391
	3	NA	NA	34	NA	NA	62	143	156	98	210	264	145	266	376	205	332	509	274	407	663	356	551	838	450
10	1	NA	NA	22	NA	NA	41	130	151	70	202	225	106	267	316	151	333	434	213	410	571	273	558	727	343
	2	NA	NA	29	NA	NA	53	136	150	86	210	255	128	276	358	181	343	489	244	420	640	317	569	813	403
	3	NA	NA	34	97	102	62	143	166	99	217	277	147	284	389	207	352	530	279	430	694	363	580	880	459
15	1	NA	NA	23	NA	NA	43	129	151	73	199	271	112	268	376	161	349	502	225	445	646	291	623	808	366
	2	NA	NA	30	92	103	54	135	170	88	207	295	132	277	411	189	359	548	256	456	706	334	634	884	424
	3	NA	NA	34	96	112	63	141	185	101	215	315	151	286	439	213	368	586	289	466	755	378	646	945	479
20	1	NA	NA	23	87	99	45	128	167	76	197	303	117	265	425	169	345	569	235	439	734	306	614	921	347
	2	NA	NA	30	91	111	55	134	185	90	205	325	136	274	455	195	355	610	266	450	787	348	627	986	443
	3	NA	NA	35	96	119	64	140	199	103	213	343	154	282	481	219	365	644	298	461	831	391	639	1,042	496
30	1	NA	NA	24	86	108	47	126	187	80	193	347	124	259	492	183	338	665	250	430	864	330	600	1,089	421
	2	NA	NA	31	91	119	57	132	203	93	201	366	142	269	518	205	348	699	282	442	908	372	613	1,145	473
	3	NA	NA	35	95	127	65	138	216	105	209	381	160	277	540	229	358	729	312	452	946	412	626	1,193	524
50	1	NA	NA	24	85	113	50	124	204	87	188	392	139	252	567	208	328	778	287	417	1,022	383	582	1,302	492
	2	NA	NA	31	89	123	60	130	218	100	196	408	158	262	588	230	339	806	320	429	1,058	425	596	1,346	545
	3	NA	NA	35	94	131	68	136	231	112	205	422	176	271	607	255	349	831	351	440	1,090	466	610	1,386	597
100	1	NA	NA	23	84	104	49	122	200	89	182	410	151	243	617	232	315	875	328	402	1,181	444	560	1,537	580
	2	NA	NA	30	88	115	59	127	215	102	190	425	169	253	636	254	326	899	361	415	1,210	488	575	1,570	634
	3	NA	NA	34	93	124	67	133	228	115	199	438	188	262	654	279	337	921	392	427	1,238	529	589	1,604	687

**COMMON VENT CAPACITY**

VENT HEIGHT (H) (feet)	MINIMUM INTERNAL AREA OF MASONRY CHIMNEY FLUE (square inches)																							
	12		19		28		38		50		63		78		113									
	COMBINED APPLIANCE INPUT RATING IN THOUSANDS OF BTUH																							
FAN +FAN	FAN +NAT	NAT +NAT	FAN +FAN	FAN +NAT	NAT +NAT	FAN +FAN	FAN +NAT	NAT +NAT	FAN +FAN	FAN +NAT	NAT +NAT	FAN +FAN	FAN +NAT	NAT +NAT	FAN +FAN	FAN +NAT	NAT +NAT	FAN +FAN	FAN +NAT	NAT +NAT	FAN +FAN	FAN +NAT	NAT +NAT	
6	NA	NA	25	NA	118	45	NA	176	71	NA	255	102	NA	348	142	NA	455	187	NA	579	245	NA	846	NA
8	NA	NA	28	NA	128	52	NA	190	81	NA	276	118	NA	380	162	NA	497	217	NA	633	277	1,136	928	405
10	NA	NA	31	NA	136	56	NA	205	89	NA	295	129	NA	405	175	NA	532	234	171	680	300	1,216	1,000	450
15	NA	NA	36	NA	NA	66	NA	230	105	NA	335	150	NA	400	210	677	602	280	866	772	360	1,359	1,139	540
20	NA	NA	NA	NA	NA	74	NA	247	120	NA	362	170	NA	503	240	765	661	321	947	849	415	1,495	1,264	640
30	NA	NA	NA	NA	NA	NA	NA	135	NA	398	195	NA	558	275	808	739	377	1,052	957	490	1,682	1,447	740	
50	NA	NA	NA	NA	NA	NA	NA	NA	NA	NA	NA	NA	NA	612	325	NA	821	456	1,152	1,076	600	1,879	1,672	910
100	NA	NA	NA	NA	NA	NA	NA	NA	NA	NA	NA	NA	NA	NA	NA	NA	NA	494	NA	NA	663	2,006	1,885	1,046

For SI: 1 inch = 25.4 mm, 1 square inch = 645.16 mm<sup>2</sup>, 1 foot = 304.8 mm, 1 British thermal unit per hour = 0.2931 W.

**TABLE 504.3(5)  
SINGLE-WALL METAL PIPE OR TYPE ASBESTOS CEMENT VENT**

<b>Number of Appliances</b>	Two or more
<b>Appliance Type</b>	Draft hood-equipped
<b>Appliance Vent Connection</b>	Direct to pipe or vent

**VENT CONNECTOR CAPACITY**

TOTAL VENT HEIGHT ( <i>H</i> ) (feet)	CONNECTOR RISE ( <i>R</i> ) (feet)	VENT CONNECTOR DIAMETER—( <i>D</i> ) inches					
		3	4	5	6	7	8
		MAXIMUM APPLIANCE INPUT RATING IN THOUSANDS OF BTU/H					
6-8	1	21	40	68	102	146	205
	2	28	53	86	124	178	235
	3	34	61	98	147	204	275
15	1	23	44	77	117	179	240
	2	30	56	92	134	194	265
	3	35	64	102	155	216	298
30 and up	1	25	49	84	129	190	270
	2	31	58	97	145	211	295
	3	36	68	107	164	232	321

**COMMON VENT CAPACITY**

TOTAL VENT HEIGHT ( <i>H</i> ) (feet)	COMMON VENT DIAMETER—( <i>D</i> ) inches						
	4	5	6	7	8	10	12
	COMBINED APPLIANCE INPUT RATING IN THOUSANDS OF BTU/H						
6	48	78	111	155	205	320	NA
8	55	89	128	175	234	365	505
10	59	95	136	190	250	395	560
15	71	115	168	228	305	480	690
20	80	129	186	260	340	550	790
30	NA	147	215	300	400	650	940
50	NA	NA	NA	360	490	810	1,190

For SI: 1 inch = 25.4 mm, 1 foot = 304.8 mm, 1 British thermal unit per hour = 0.2931 W.

**TABLE 504.3(6)  
EXTERIOR MASONRY CHIMNEY**

Number of Appliances	One
Appliance Type	NAT
Appliance Vent Connection	Type B double-wall connector

MINIMUM ALLOWABLE INPUT RATING OF SPACE-HEATING APPLIANCE IN THOUSANDS OF BTU PER HOUR								
VENT HEIGHT (feet)	Internal area of chimney (square inches)							
	12	19	28	38	50	63	78	113
37°F or Greater Local 99% Winter Design Temperature: 37°F or Greater								
6	0	0	0	0	0	0	0	0
8	0	0	0	0	0	0	0	0
10	0	0	0	0	0	0	0	0
15	NA	0	0	0	0	0	0	0
20	NA	NA	123	190	249	184	0	0
30	NA	NA	NA	NA	NA	393	334	0
50	NA	NA	NA	NA	NA	NA	NA	579
27 to 36°F Local 99% Winter Design Temperature: 27 to 36°F								
6	0	0	68	116	156	180	212	266
8	0	0	82	127	167	187	214	263
10	0	51	97	141	183	201	225	265
15	NA	NA	NA	NA	233	253	274	305
20	NA	NA	NA	NA	NA	307	330	362
30	NA	NA	NA	NA	NA	419	445	485
50	NA	NA	NA	NA	NA	NA	NA	763
17 to 26°F Local 99% Winter Design Temperature: 17 to 26°F								
6	NA	NA	NA	NA	NA	215	259	349
8	NA	NA	NA	NA	197	226	264	352
10	NA	NA	NA	NA	214	245	278	358
15	NA	NA	NA	NA	NA	296	331	398
20	NA	NA	NA	NA	NA	352	387	457
30	NA	NA	NA	NA	NA	NA	507	581
50	NA	NA	NA	NA	NA	NA	NA	NA
5 to 16°F Local 99% Winter Design Temperature: 5 to 16°F								
6	NA	NA	NA	NA	NA	NA	NA	416
8	NA	NA	NA	NA	NA	NA	312	423
10	NA	NA	NA	NA	NA	289	331	430
15	NA	NA	NA	NA	NA	NA	393	485
20	NA	NA	NA	NA	NA	NA	450	547
30	NA	NA	NA	NA	NA	NA	NA	682
50	NA	NA	NA	NA	NA	NA	NA	972
-10 to 4°F Local 99% Winter Design Temperature: -10 to 4°F								
6	NA	NA	NA	NA	NA	NA	NA	484
8	NA	NA	NA	NA	NA	NA	NA	494
10	NA	NA	NA	NA	NA	NA	NA	513
15	NA	NA	NA	NA	NA	NA	NA	586
20	NA	NA	NA	NA	NA	NA	NA	650
30	NA	NA	NA	NA	NA	NA	NA	805
50	NA	NA	NA	NA	NA	NA	NA	1,003
-11°F or Lower Local 99% Winter Design Temperature: -11°F or Lower								
Not recommended for any vent configurations								

Note: See Figure B-19 in Appendix B for a map showing local 99 percent winter design temperatures in the United States.

For SI: °C = [(°F - 32)/1.8], 1 inch = 25.4 mm, 1 foot = 304.8 mm, 1 British thermal unit per hour = 0.2931 W.



**TABLE 504.3(7a)  
EXTERIOR MASONRY CHIMNEY**

Number of Appliances	Two or more
Appliance Type	NAT + NAT
Appliance Vent Connection	Type B double-wall connector

**Combined Appliance Maximum  
Input Rating in Thousands of Btu per Hour**

VENT HEIGHT (feet)	INTERNAL AREA OF CHIMNEY (square inches)							
	12	19	28	38	50	63	78	113
6	25	46	71	103	143	188	246	NA
8	28	53	82	119	163	218	278	408
10	31	56	90	131	177	236	302	454
15	NA	67	106	152	212	283	365	546
20	NA	NA	NA	NA	NA	325	419	648
30	NA	NA	NA	NA	NA	NA	496	749
50	NA	NA	NA	NA	NA	NA	NA	922
100	NA	NA	NA	NA	NA	NA	NA	NA

**TABLE 504.3(7b)  
EXTERIOR MASONRY CHIMNEY**

Number of Appliances	Two or more
Appliance Type	NAT + NAT
Appliance Vent Connection	Type B double-wall connector

**Minimum Allowable Input Rating of  
Space-Heating Appliance in Thousands of Btu per Hour**

VENT HEIGHT (feet)	INTERNAL AREA OF CHIMNEY (square inches)							
	12	19	28	38	50	63	78	113
<b>37°F or Greater</b> Local 99% Winter Design Temperature: 37°F or Greater								
6	0	0	0	0	0	0	0	NA
8	0	0	0	0	0	0	0	0
10	0	0	0	0	0	0	0	0
15	NA	0	0	0	0	0	0	0
20	NA	NA	NA	NA	NA	184	0	0
30	NA	NA	NA	NA	NA	393	334	0
50	NA	NA	NA	NA	NA	NA	NA	579
100	NA	NA	NA	NA	NA	NA	NA	NA
<b>27 to 36°F</b> Local 99% Winter Design Temperature: 27 to 36°F								
6	0	0	68	NA	NA	180	212	NA
8	0	0	82	NA	NA	187	214	263
10	0	51	NA	NA	NA	201	225	265
15	NA	NA	NA	NA	NA	253	274	305
20	NA	NA	NA	NA	NA	307	330	362
30	NA	NA	NA	NA	NA	NA	445	485
50	NA	NA	NA	NA	NA	NA	NA	763
100	NA	NA	NA	NA	NA	NA	NA	NA

**TABLE 504.3(7b)  
EXTERIOR MASONRY CHIMNEY—continued**

**Minimum Allowable Input Rating of  
Space-Heating Appliance in Thousands of Btu per Hour**

VENT HEIGHT (feet)	INTERNAL AREA OF CHIMNEY (square inches)							
	12	19	28	38	50	63	78	113
<b>17 to 26°F</b> Local 99% Winter Design Temperature: 17 to 26°F								
6	NA	NA	NA	NA	NA	NA	NA	NA
8	NA	NA	NA	NA	NA	NA	264	352
10	NA	NA	NA	NA	NA	NA	278	358
15	NA	NA	NA	NA	NA	NA	331	398
20	NA	NA	NA	NA	NA	NA	387	457
30	NA	NA	NA	NA	NA	NA	NA	581
50	NA	NA	NA	NA	NA	NA	NA	862
100	NA	NA	NA	NA	NA	NA	NA	NA
<b>5 to 16°F</b> Local 99% Winter Design Temperature: 5 to 16°F								
6	NA	NA	NA	NA	NA	NA	NA	NA
8	NA	NA	NA	NA	NA	NA	NA	NA
10	NA	NA	NA	NA	NA	NA	NA	430
15	NA	NA	NA	NA	NA	NA	NA	485
20	NA	NA	NA	NA	NA	NA	NA	547
30	NA	NA	NA	NA	NA	NA	NA	682
50	NA	NA	NA	NA	NA	NA	NA	NA
100	NA	NA	NA	NA	NA	NA	NA	NA
<b>4°F or Lower</b> Local 99% Winter Design Temperature: 4°F or Lower								
Not recommended for any vent configurations								

Note: See Figure B-19 in Appendix B for a map showing local 99 percent winter design temperatures in the United States.

For SI: °C = [(°F - 32)/1.8], 1 inch = 25.4 mm, 1 square inch = 645.16 mm<sup>2</sup>, 1 foot = 304.8 mm, 1 British thermal unit per hour = 0.2931 W.

**TABLE 504.3(8a)  
EXTERIOR MASONRY CHIMNEY**

Number of Appliances	Two or more
Appliance Type	FAN + NAT
Appliance Vent Connection	Type B double-wall connector

**Combined Appliance Maximum  
Input Rating in Thousands of Btu per Hour**

VENT HEIGHT (feet)	INTERNAL AREA OF CHIMNEY (square inches)							
	12	19	28	38	50	63	78	113
6	74	119	178	257	351	458	582	853
8	80	130	193	279	384	501	636	937
10	84	138	207	299	409	538	686	1,010
15	NA	152	233	334	467	611	781	1,156
20	NA	NA	250	368	508	668	858	1,286
30	NA	NA	NA	404	564	747	969	1,473
50	NA	NA	NA	NA	NA	831	1,089	1,692
100	NA	NA	NA	NA	NA	NA	NA	1,921

**TABLE 504.3(8b)  
EXTERIOR MASONRY CHIMNEY**

Number of Appliances	Two or more
Appliance Type	FAN + NAT
Appliance Vent Connection	Type B double-wall connector

**Minimum Allowable Input Rating of  
Space-Heating Appliance in Thousands of Btu per Hour**

VENT HEIGHT (feet)	INTERNAL AREA OF CHIMNEY (square inches)							
	12	19	28	38	50	63	78	113
<b>37°F or Greater</b> Local 99% Winter Design Temperature: 37°F or Greater								
6	0	0	0	0	0	0	0	0
8	0	0	0	0	0	0	0	0
10	0	0	0	0	0	0	0	0
15	NA	0	0	0	0	0	0	0
20	NA	NA	123	190	249	184	0	0
30	NA	NA	NA	334	398	393	334	0
50	NA	NA	NA	NA	NA	714	707	579
100	NA	NA	NA	NA	NA	NA	NA	1,600
<b>27 to 36°F</b> Local 99% Winter Design Temperature: 27 to 36°F								
6	0	0	68	116	156	180	212	266
8	0	0	82	127	167	187	214	263
10	0	51	97	141	183	210	225	265
15	NA	111	142	183	233	253	274	305
20	NA	NA	187	230	284	307	330	362
30	NA	NA	NA	330	319	419	445	485
50	NA	NA	NA	NA	NA	672	705	763
100	NA	NA	NA	NA	NA	NA	NA	1,554

**TABLE 504.3(8b)  
EXTERIOR MASONRY CHIMNEY—continued**

**Minimum Allowable Input Rating of  
Space-Heating Appliance in Thousands of Btu per Hour**

VENT HEIGHT (feet)	INTERNAL AREA OF CHIMNEY (square inches)							
	12	19	28	38	50	63	78	113
<b>17 to 26°F</b> Local 99% Winter Design Temperature: 17 to 26°F								
6	0	55	99	141	182	215	259	349
8	52	74	111	154	197	226	264	352
10	NA	90	125	169	214	245	278	358
15	NA	NA	167	212	263	296	331	398
20	NA	NA	212	258	316	352	387	457
30	NA	NA	NA	362	429	470	507	581
50	NA	NA	NA	NA	NA	723	766	862
100	NA	NA	NA	NA	NA	NA	NA	1,669
<b>5 to 16°F</b> Local 99% Winter Design Temperature: 5 to 16°F								
6	NA	78	121	166	214	252	301	416
8	NA	94	135	182	230	269	312	423
10	NA	111	149	198	250	289	331	430
15	NA	NA	193	247	305	346	393	485
20	NA	NA	NA	293	360	408	450	547
30	NA	NA	NA	377	450	531	580	682
50	NA	NA	NA	NA	NA	797	853	972
100	NA	NA	NA	NA	NA	NA	NA	1,833
<b>-10 to 4°F</b> Local 99% Winter Design Temperature: -10 to 4°F								
6	NA	NA	145	196	249	296	349	484
8	NA	NA	159	213	269	320	371	494
10	NA	NA	175	231	292	339	397	513
15	NA	NA	NA	283	351	404	457	586
20	NA	NA	NA	333	408	468	528	650
30	NA	NA	NA	NA	NA	603	667	805
50	NA	NA	NA	NA	NA	NA	955	1,003
100	NA	NA	NA	NA	NA	NA	NA	NA
<b>-11°F or Lower</b> Local 99% Winter Design Temperature: -11°F or Lower Not recommended for any vent configurations								

Note: See Figure B-19 in Appendix B for a map showing local 99 percent winter design temperatures in the United States.

For SI: °C = [(°F - 32)/1.8], 1 inch = 25.4 mm, 1 square inch = 645.16 mm<sup>2</sup>, 1 foot = 304.8 mm, 1 British thermal unit per hour = 0.2931 W.

**TABLE 504.3.2  
MAXIMUM VENT CONNECTOR LENGTH**

<b>CONNECTOR DIAMETER MAXIMUM (inches)</b>	<b>CONNECTOR HORIZONTAL LENGTH (feet)</b>
3	4 <sup>1</sup> / <sub>2</sub>
4	6
5	7 <sup>1</sup> / <sub>2</sub>
6	9
7	10 <sup>1</sup> / <sub>2</sub>
8	12
9	13 <sup>1</sup> / <sub>2</sub>
10	15
12	18
14	21
16	24
18	27
20	30
22	33
24	36

For SI: 1 inch = 25.4 mm, 1 foot = 304.8 mm.

**TABLE 634.1  
FREE OPENING AREA OF CHIMNEY DAMPER FOR VENTING FLUE GASES  
FROM UNLISTED DECORATIVE APPLIANCES FOR INSTALLATION IN VENTED FIREPLACES**

CHIMNEY HEIGHT (foot)	MINIMUM PERMANENT FREE OPENING (square inches) <sup>a</sup>						
	8	13	20	29	39	51	64
	Appliance input rating (Btu per hour)						
6	7,800	14,000	23,200	34,000	46,400	62,400	8,000
8	8,400	15,200	25,200	37,000	50,400	68,000	86,000
10	9,000	16,800	27,600	40,400	55,800	74,400	96,400
15	9,800	18,200	30,200	44,600	62,400	84,000	108,800
20	10,600	20,200	32,600	50,400	68,400	94,000	122,200
30	11,200	21,600	36,600	55,200	76,800	105,800	138,600

For SI: 1 inch = 25.4 mm, 1 foot = 304.8 mm, 1 square inch = 645.16 mm<sup>2</sup>, 1 British thermal unit per hour = 0.2931 W.

a. The first six minimum permanent free openings (8 to 51 square inches) correspond approximately to the cross-sectional areas of chimneys having diameters of 3 through 8 inches, respectively. The 64-square-inch opening corresponds to the cross-sectional area of standard 8-inch by 8-inch chimney tile.

**TABLE F.4.1  
POLYETHYLENE PLASTIC PIPE**

<b>Gas</b>	<u>Natural</u>
<b>Inlet Pressure</b>	<u>1.0 psi or less</u>
<b>Pressure Drop</b>	<u>0.3 inch WC</u>
<b>Specific Gravity</b>	<u>0.60</u>

<b>Nominal OD</b>	<b>PIPE SIZE (in.)</b>					
	<u>1/2</u>	<u>3/4</u>	<u>1</u>	<u>1 1/4</u>	<u>1 1/2</u>	<u>2</u>
<b>Designation</b>	<u>SDR 9.33</u>	<u>SDR 11.0</u>	<u>SDR 11.00</u>	<u>SDR 10.00</u>	<u>SDR 11.00</u>	<u>SDR 11.00</u>
<b>Actual ID</b>	<u>0.660</u>	<u>0.860</u>	<u>1.077</u>	<u>1.328</u>	<u>1.554</u>	<u>1.943</u>
<b>Length (ft)</b>	<b>Maximum</b>					
<u>10</u>	<u>153</u>	<u>305</u>	<u>551</u>	<u>955</u>	<u>1,442</u>	<u>2,590</u>
<u>20</u>	<u>105</u>	<u>210</u>	<u>379</u>	<u>656</u>	<u>991</u>	<u>1,780</u>
<u>30</u>	<u>84</u>	<u>169</u>	<u>304</u>	<u>527</u>	<u>796</u>	<u>1,430</u>
<u>40</u>	<u>72</u>	<u>144</u>	<u>260</u>	<u>451</u>	<u>681</u>	<u>1,224</u>
<u>50</u>	<u>64</u>	<u>128</u>	<u>231</u>	<u>400</u>	<u>604</u>	<u>1,084</u>
<u>60</u>	<u>58</u>	<u>116</u>	<u>209</u>	<u>362</u>	<u>547</u>	<u>983</u>
<u>70</u>	<u>53</u>	<u>107</u>	<u>192</u>	<u>333</u>	<u>503</u>	<u>904</u>
<u>80</u>	<u>50</u>	<u>99</u>	<u>179</u>	<u>310</u>	<u>468</u>	<u>841</u>
<u>90</u>	<u>46</u>	<u>93</u>	<u>168</u>	<u>291</u>	<u>439</u>	<u>789</u>
<u>100</u>	<u>44</u>	<u>88</u>	<u>159</u>	<u>275</u>	<u>415</u>	<u>745</u>
<u>125</u>	<u>39</u>	<u>78</u>	<u>141</u>	<u>243</u>	<u>368</u>	<u>661</u>
<u>150</u>	<u>35</u>	<u>71</u>	<u>127</u>	<u>221</u>	<u>333</u>	<u>598</u>
<u>175</u>	<u>32</u>	<u>65</u>	<u>117</u>	<u>203</u>	<u>306</u>	<u>551</u>
<u>200</u>	<u>30</u>	<u>60</u>	<u>109</u>	<u>189</u>	<u>285</u>	<u>512</u>

For SI: 1 inch = 25.4 mm, 1 foot = 304.8 mm, 1 cubic foot per hour = 0.0283 m<sup>3</sup>/h, 1 pound per square inch = 6.895 kPa, 1-inch water column = 0.2488 kPa.

**TABLE F.4.2  
POLYETHYLENE PLASTIC PIPE**

<b>Gas</b>	Natural
<b>Inlet Pressure</b>	1.0 psi or less
<b>Pressure Drop</b>	0.5 inch WC
<b>Specific Gravity</b>	0.60

<b>Nominal OD</b>	<b>PIPE SIZE (in.)</b>					
	<u>1/2</u>	<u>3/4</u>	<u>1</u>	<u>1 1/4</u>	<u>1 1/2</u>	<u>2</u>
<b>Designation</b>	<u>SDR 9.33</u>	<u>SDR 11.0</u>	<u>SDR 11.00</u>	<u>SDR 10.00</u>	<u>SDR 11.00</u>	<u>SDR 11.00</u>
<b>Actual ID</b>	<u>0.660</u>	<u>0.860</u>	<u>1.077</u>	<u>1.328</u>	<u>1.554</u>	<u>1.943</u>
<b>Length (ft)</b>	<b>Maximum Capacity in Cubic Feet of Gas per Hour</b>					
<u>10</u>	<u>201</u>	<u>403</u>	<u>726</u>	<u>1,258</u>	<u>1,900</u>	<u>3,415</u>
<u>20</u>	<u>138</u>	<u>277</u>	<u>499</u>	<u>865</u>	<u>1,306</u>	<u>2,347</u>
<u>30</u>	<u>111</u>	<u>222</u>	<u>401</u>	<u>695</u>	<u>1,049</u>	<u>1,885</u>
<u>40</u>	<u>95</u>	<u>190</u>	<u>343</u>	<u>594</u>	<u>898</u>	<u>1,613</u>
<u>50</u>	<u>84</u>	<u>169</u>	<u>304</u>	<u>527</u>	<u>796</u>	<u>1,430</u>
<u>60</u>	<u>76</u>	<u>153</u>	<u>276</u>	<u>477</u>	<u>721</u>	<u>1,295</u>
<u>70</u>	<u>70</u>	<u>140</u>	<u>254</u>	<u>439</u>	<u>663</u>	<u>1,192</u>
<u>80</u>	<u>65</u>	<u>131</u>	<u>236</u>	<u>409</u>	<u>617</u>	<u>1,109</u>
<u>90</u>	<u>61</u>	<u>123</u>	<u>221</u>	<u>383</u>	<u>579</u>	<u>1,040</u>
<u>100</u>	<u>58</u>	<u>116</u>	<u>209</u>	<u>362</u>	<u>547</u>	<u>983</u>
<u>125</u>	<u>51</u>	<u>103</u>	<u>185</u>	<u>321</u>	<u>485</u>	<u>871</u>
<u>150</u>	<u>46</u>	<u>93</u>	<u>168</u>	<u>291</u>	<u>439</u>	<u>789</u>
<u>175</u>	<u>43</u>	<u>86</u>	<u>154</u>	<u>268</u>	<u>404</u>	<u>726</u>
<u>200</u>	<u>40</u>	<u>80</u>	<u>144</u>	<u>249</u>	<u>376</u>	<u>675</u>

For SI: 1 inch = 25.4 mm, 1 foot = 304.8 mm, 1 cubic foot per hour = 0.0283 m<sup>3</sup>/h, 1 pound per square inch = 6.895 kPa, 1-inch water column = 0.2488 kPa.

**TABLE F.4.3  
POLYETHYLENE PLASTIC PIPE**

<b>Gas</b>	<u>Natural</u>
<b>Inlet Pressure</b>	<u>2.0 psi</u>
<b>Pressure Drop</b>	<u>1.0 psi</u>
<b>Specific Gravity</b>	<u>0.60</u>

<b>Nominal OD</b>	<b>PIPE SIZE (in.)</b>					
	<u>1/2</u>	<u>3/4</u>	<u>1</u>	<u>1 1/4</u>	<u>1 1/2</u>	<u>2</u>
<b>Designation</b>	<u>SDR 9.33</u>	<u>SDR 11.0</u>	<u>SDR 11.00</u>	<u>SDR 10.00</u>	<u>SDR 11.00</u>	<u>SDR 11.00</u>
<b>Actual ID</b>	<u>0.660</u>	<u>0.860</u>	<u>1.077</u>	<u>1.328</u>	<u>1.554</u>	<u>1.943</u>
<b>Length (ft)</b>	<b>Maximum Capacity in Cubic Feet of Gas per Hour</b>					
<u>10</u>	<u>1,858</u>	<u>3,721</u>	<u>6,714</u>	<u>11,631</u>	<u>17,565</u>	<u>31,560</u>
<u>20</u>	<u>1,277</u>	<u>2,557</u>	<u>4,614</u>	<u>7,994</u>	<u>12,072</u>	<u>21,691</u>
<u>30</u>	<u>1,026</u>	<u>2,054</u>	<u>3,706</u>	<u>6,420</u>	<u>9,695</u>	<u>17,419</u>
<u>40</u>	<u>878</u>	<u>1,758</u>	<u>3,172</u>	<u>5,494</u>	<u>8,297</u>	<u>14,908</u>
<u>50</u>	<u>778</u>	<u>1,558</u>	<u>2,811</u>	<u>4,869</u>	<u>7,354</u>	<u>13,213</u>
<u>60</u>	<u>705</u>	<u>1,412</u>	<u>2,547</u>	<u>4,412</u>	<u>6,663</u>	<u>11,972</u>
<u>70</u>	<u>649</u>	<u>1,299</u>	<u>2,343</u>	<u>4,059</u>	<u>6,130</u>	<u>11,014</u>
<u>80</u>	<u>603</u>	<u>1,208</u>	<u>2,180</u>	<u>3,776</u>	<u>5,703</u>	<u>10,246</u>
<u>90</u>	<u>566</u>	<u>1,134</u>	<u>2,045</u>	<u>3,543</u>	<u>5,351</u>	<u>9,614</u>
<u>100</u>	<u>535</u>	<u>1,071</u>	<u>1,932</u>	<u>3,347</u>	<u>5,054</u>	<u>9,081</u>
<u>125</u>	<u>474</u>	<u>949</u>	<u>1,712</u>	<u>2,966</u>	<u>4,479</u>	<u>8,048</u>
<u>150</u>	<u>429</u>	<u>860</u>	<u>1,551</u>	<u>2,688</u>	<u>4,059</u>	<u>7,292</u>
<u>175</u>	<u>395</u>	<u>791</u>	<u>1,427</u>	<u>2,473</u>	<u>3,734</u>	<u>6,709</u>
<u>200</u>	<u>368</u>	<u>736</u>	<u>1,328</u>	<u>2,300</u>	<u>3,474</u>	<u>6,241</u>

For SI: 1 inch = 25.4 mm, 1 foot = 304.8 mm, 1 cubic foot per hour = 0.0283 m<sup>3</sup>/h, 1 pound per square inch = 6.895 kPa.